

CHICAGO[®] Electric

UNIVERSAL BATTERY CHARGER

Model 66718

SET UP AND OPERATING INSTRUCTIONS

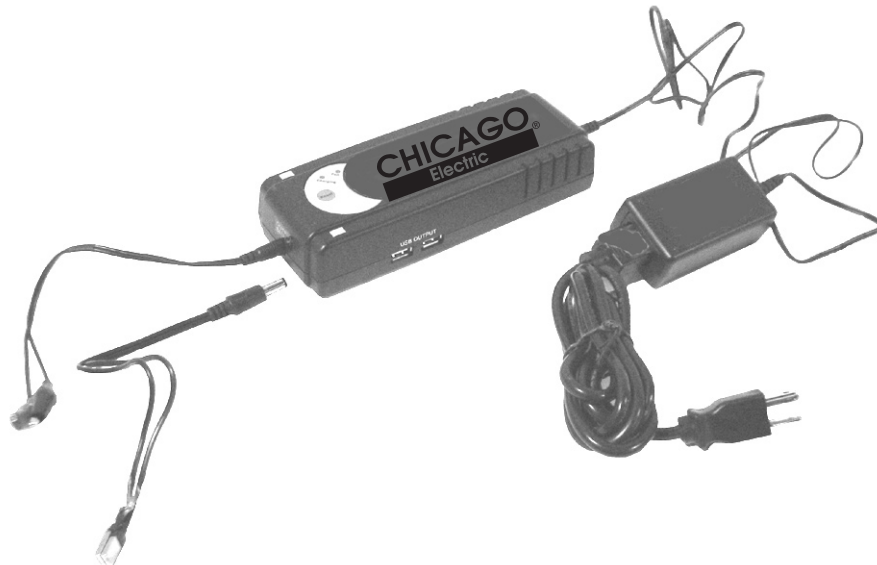

Distributed exclusively by Harbor Freight Tools[®].
3491 Mission Oaks Blvd., Camarillo, CA 93011
Visit our website at: <http://www.harborfreight.com>



**Read this material before using this product.
Failure to do so can result in serious injury.
SAVE THIS MANUAL.**

Copyright[®] 2009 by Harbor Freight Tools[®]. All rights reserved. No portion of this manual or any artwork contained herein may be reproduced in any shape or form without the express written consent of Harbor Freight Tools. Diagrams within this manual may not be drawn proportionally. Due to continuing improvements, actual product may differ slightly from the product described herein. Tools required for assembly and service may not be included.

For technical questions or replacement parts, please call 1-800-444-3353.

SAVE THIS MANUAL

Keep this manual for the safety warnings and precautions, assembly, operating, inspection, maintenance and cleaning procedures. Write the product's serial number in the back of the manual (or month and year of purchase if product has no number). Keep this manual and the receipt in a safe and dry place for future reference.

IMPORTANT SAFETY INFORMATION

In this manual, on the labeling, and all other information provided with this product:



This is the safety alert symbol. It is used to alert you to potential personal injury hazards. Obey all safety messages that follow this symbol to avoid possible injury or death.

DANGER

DANGER indicates a hazardous situation which, if not avoided, will result in death or serious injury.

WARNING

WARNING indicates a hazardous situation which, if not avoided, could result in death or serious injury.

CAUTION

CAUTION, used with the safety alert symbol, indicates a hazardous situation which, if not avoided, could result in minor or moderate injury.

NOTICE

NOTICE is used to address practices not related to personal injury.

CAUTION

CAUTION, without the safety alert symbol, is used to address practices not related to personal injury.

General Safety Warnings



WARNING Read all safety warnings and instructions.

Failure to follow the warnings and instructions may result in electric shock, fire and/or serious injury.

Save all warnings and instructions for future reference.
Work area safety

- a. **Keep work area clean and well lit.** Cluttered or dark areas invite accidents.
- b. **Do not operate Universal Battery Charger in explosive atmospheres, such as in the presence of flammable liquids, gases or dust.** Power tools create sparks which may ignite the dust or fumes.
- c. **Keep children and bystanders away while operating the Battery Charger.** Distractions can cause you to lose control.

2. Electrical safety

- a. **The Power Plug for this product must match the Outlet. Never modify the Plug in any way. Do not use any adapter plugs with this product.** Unmodified plugs and matching outlets will reduce risk of electric shock.
- b. **Avoid body contact with grounded surfaces such as pipes, radiators, ranges and refrigerators.** There is an increased risk of electric shock if your body is grounded.
- c. **Do not expose the Battery Charger to rain or wet conditions.** Water entering this product will increase the risk of electric shock.
- d. **Do not abuse the Power Cord. Never use the Cord for carrying, pulling or unplugging the Battery Charger. Keep the Cord away from heat, oil, sharp edges or moving parts.** Damaged or entangled cords increase the risk of electric shock.
- e. **When operating the Battery Charger outdoors, use an Extension Cord suitable for outdoor use.** Use of a Cord suitable for outdoor use reduces the risk of electric shock.
- f. **If operating the Battery Charger in a damp location is unavoidable, use a Ground Fault Circuit Interrupter (GFCI) protected supply.** Use of a GFCI reduces the risk of electric shock.

3. Personal safety

- a. **Stay alert, watch what you are doing and use common sense when operating the Battery Charger. Do not use this product while you are tired or under the influence of drugs, alcohol or medication. A**

moment of inattention while operating power tools may result in serious personal injury.

- b. **Use personal protective equipment. Always wear ANSI-approved eye protection.** Safety equipment such as NIOSH-approved dust mask/respirator, non-skid safety shoes, hard hat, or hearing protection used for appropriate conditions will reduce personal injuries.
 - c. **Do not overreach. Keep proper footing and balance at all times.** This enables better control of the Battery Charger in unexpected situations.
 - d. **Only use safety equipment that has been approved by an appropriate standards agency.** Unapproved safety equipment may not provide adequate protection. Eye protection must be ANSI-approved and breathing protection must be NIOSH-approved for the specific hazards in the work area.
- ## 4. Battery Charger use and care
- a. **Do not force the Battery Charger. Use the correct product for your application.** The correct Battery Charger will do the job better and safer at the rate for which it was designed.
 - b. **Disconnect the AC/DC Adapter's Power Plug from the power source before making any adjustments, changing accessories, or storing the Charger.** Such preventive safety measures reduce the risk of turning on the AC/DC Adapter accidentally.
 - c. **Store the Battery Charger out of the reach of children and do not allow persons unfamiliar with this**

Charger or these instructions to operate the product. Battery Chargers are dangerous in the hands of untrained users.

- d. **Maintain the Battery Charger.** Check for misalignment or binding of moving parts, breakage of parts and any other condition that may affect the Charger's operation. If damaged, have the Charger repaired before use. Many accidents are caused by poorly maintained products.
- e. **Use the Battery Charger and its accessories in accordance with these instructions, taking into account the working conditions and the work to be performed.** Use of the Battery Charger for operations different from those intended could result in a hazardous situation.

5. Service

- a. **Have your Battery Charger serviced by a qualified repair person using only identical replacement parts.** This will ensure that the safety of the product is maintained.

Specific Safety Warnings

1. **This Universal Battery Charger is designed for use with 4.8, 7.2, 9.6, 12, 14.4, and 18 volt NiMH or NiCd batteries only.** Never attempt to use the Battery Charger with any other battery types.
2. **Do not attempt to charge a battery when the temperature is below 32° Fahrenheit or above 104° Fahrenheit.** Damage to the Battery Charger, the battery being charged, and/or personal injury can result.

3. **Do not allow the BLACK and RED Charger Clips to touch one another when the Battery Charger is plugged into an electrical outlet.**

Do not allow the two Charger Magnets to touch one another when the Battery Charger is plugged into an electrical outlet.

Failure to adhere to these directions can result in damage to the Battery Charger, the battery being charged, and/or personal injury.

4. **Maintain labels and nameplates on the Battery Charger.** These carry important safety information. If unreadable or missing, contact Harbor Freight Tools for a replacement.
5. **Do not leave the Battery Charger unattended when it is plugged into an electrical outlet.** Unplug the AC/DC Adapter from its electrical outlet before leaving.

6.



The Charger gets hot during use. The Charger's heat can build up to unsafe levels and create a

fire hazard if it does not receive adequate ventilation, due to an electrical fault, or if it is used in a hot environment.

Do not place the Charger on a flammable surface. Do not obstruct any vents on the Charger. **Especially avoid placing the Charger on carpets and rugs; they are not only flammable, but they also obstruct vents under the Charger.**

Place the Charger on a stable, solid, nonflammable surface (such as a stable metal workbench or concrete floor) at least 1 foot away from all flammable objects, such as drapes or

walls. Keep a fire extinguisher and a smoke detector in the area. While charging, frequently monitor the Charger and the battery being charged.

7. **Prior to using the Battery Charger, consult with the manufacturer of the battery being charged for specific charging instructions.** Never overcharge a battery.
8. **Do not attempt to use the Battery Charger with a leaking battery.** Battery leakage may occur under extreme usage or temperature conditions.
9. **Do not dispose of batteries by fire.** Fire or intense heat can cause an explosion. After the life of the battery has expired, it should be recycled. Some States require this recycling. Contact your local solid waste authority for recycling information.
10. **This product is not a toy. Keep it out of reach of children.**
11. **People with pacemakers should consult their physician(s) before use.** Electromagnetic fields in close proximity to heart pacemaker could cause pacemaker interference or pacemaker failure. In addition, people with pacemakers should:
 - Avoid operating alone.
 - Properly maintain and inspect to avoid electrical shock.
 - Any Power Cord must be properly grounded. Ground Fault Circuit Interrupter (GFCI) should also be implemented – it prevents sustained electrical shock.
12. **WARNING: Handling the power Cord on this product will expose**

you to lead, a chemical known to the State of California to cause cancer, and birth defects or other reproductive harm. Wash hands after handling. (California Health & Safety Code § 25249.5, *et seq.*)

13. **The warnings, precautions, and instructions discussed in this instruction manual cannot cover all possible conditions and situations that may occur.** It must be understood by the operator that common sense and caution are factors which cannot be built into this product, but must be supplied by the operator.



SAVE THESE INSTRUCTIONS.

GROUNDING



WARNING TO PREVENT ELECTRIC SHOCK

AND DEATH FROM INCORRECT GROUNDING WIRE CONNECTION: Check with a qualified electrician if you are in doubt as to whether the Electrical Outlet is properly grounded. Do not modify the Power Cord Plug provided with the Battery Charger. Never remove the grounding prong from the Plug. Do not use the Battery Charger if the Power Cord or Plug is damaged. If damaged, have it repaired by a service facility before use. If the Plug will not fit the Outlet, have a proper Outlet installed by a qualified electrician.



Grounded Tools: Tools with Three Prong Plugs

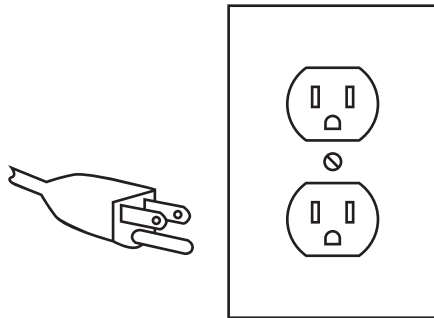

3-Prong Plug and Outlet

1. Tools marked with “Grounding Required” have a three wire cord and three prong grounding plug. The plug must be connected to a properly grounded outlet. If the tool should electrically malfunction or break down, grounding provides a low resistance path to carry electricity away from the user, reducing the risk of electric shock.
(See 3-Prong Plug and Outlet.)
2. The grounding prong in the plug is connected through the green wire inside the cord to the grounding system in the tool. The green wire in the cord must be the only wire connected to the tool’s grounding system and must never be attached to an electrically “live” terminal.
(See 3-Prong Plug and Outlet.)
3. The tool must be plugged into an appropriate outlet, properly installed and grounded in accordance with all codes and ordinances. The plug and outlet should look like those in the preceding illustration.
(See 3-Prong Plug and Outlet.)

Double Insulated Tools: Tools with Two Prong Plugs

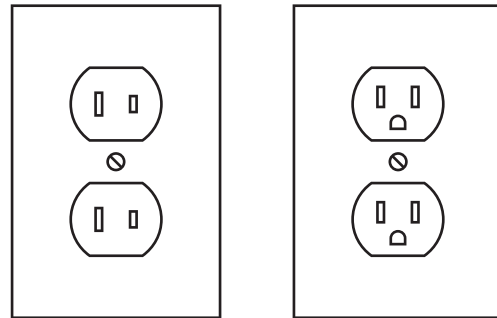

Outlets for 2-Prong Plug

1. Tools marked “Double Insulated” do not require grounding. They have a special double insulation system which satisfies OSHA requirements and complies with the applicable standards of Underwriters Laboratories, Inc., the Canadian Standard Association, and the National Electrical Code.
(See Outlets for 2-Prong Plug.)
2. Double insulated tools may be used in either of the 120 volt outlets shown in the preceding illustration.
(See Outlets for 2-Prong Plug.)

EXTENSION CORDS





1. Grounded tools require a three wire extension cord. Double Insulated tools can use either a two or three wire extension cord.
2. As the distance from the supply outlet increases, you must use a heavier gauge extension cord. Using extension cords with inadequately sized wire causes a serious drop in voltage, resulting in loss of power and possible tool damage.
(See Table A, next page.)

3. The smaller the gauge number of the wire, the greater the capacity of the cord. For example, a 14 gauge cord can carry a higher current than a 16 gauge cord. **(See Table A.)**
4. When using more than one extension cord to make up the total length, make sure each cord contains at least the minimum wire size required. **(See Table A.)**
5. If you are using one extension cord for more than one tool, add the nameplate amperes and use the sum to determine the required minimum cord size. **(See Table A.)**
6. If you are using an extension cord outdoors, make sure it is marked with the suffix "W-A" ("W" in Canada) to indicate it is acceptable for outdoor use.
7. Make sure the extension cord is properly wired and in good electrical condition. Always replace a damaged extension cord or have it repaired by a qualified electrician before using it.
8. Protect the extension cords from sharp objects, excessive heat, and damp or wet areas.

| RECOMMENDED MINIMUM WIRE GAUGE FOR EXTENSION CORDS* (120/240 VOLT) | | | | | |
|---|-----------------------|-----|-----|------|------|
| NAMEPLATE AMPERES (at full load) | EXTENSION CORD LENGTH | | | | |
| | 25' | 50' | 75' | 100' | 150' |
| 0 – 2.0 | 18 | 18 | 18 | 18 | 16 |
| 2.1 – 3.4 | 18 | 18 | 18 | 16 | 14 |
| 3.5 – 5.0 | 18 | 18 | 16 | 14 | 12 |
| 5.1 – 7.0 | 18 | 16 | 14 | 12 | 12 |
| 7.1 – 12.0 | 18 | 14 | 12 | 10 | - |
| 12.1 – 16.0 | 14 | 12 | 10 | - | - |
| 16.1 – 20.0 | 12 | 10 | - | - | - |

TABLE A * Based on limiting the line voltage drop to five volts at 150% of the rated amperes.

SYMBOLOLOGY

| | |
|---|--------------------------------------|
|  | Double Insulated |
|  | Canadian Standards Association |
|  | Underwriters Laboratories, Inc. |
|  | Volts Alternating Current |
|  | Amperes |
| n_0 xxxx/min. | No Load Revolutions per Minute (RPM) |

SPECIFICATIONS

| | |
|-----------------------|--|
| Input Power | AC/DC Adapter Input Power: 120 V~ / 60Hz |
| Output Power | Designed for use only with 4.8, 7.2, 9.6, 12, 14.4, and 18 volt NiMH or NiCd rechargeable batteries. |
| Charger Auto Shut-Off | No. (Care must be taken <i>not</i> to overcharge batteries) |
| Polarity Protection | Yes. (Designed with <i>non-polarity</i> technology) |
| Charging Time | 1.0 ~ 3.0 Hours (Depending on battery capacity) |
| L.E.D. Functions | Red = "Charging" Green = "Fully Charged" |
| Reset Button Function | When pressed, Charger will return to "charge" mode within 2 seconds |
| Accessories | Charger (Qty. 1) AC/DC Adapter (Qty. 1) AC/DC Adapter Input Cord (Qty. 1) Charger Input Cord (Qty. 1) Charger Output Clips (Qty. 1 set) Charger Output Magnets (Qty. 1 set) |

UNPACKING

When unpacking, make sure that the item is intact and undamaged. If any parts are missing or broken, please call Harbor

Freight Tools at 1-800-444-3353 as soon as possible.

PRODUCT FEATURES



Read the **ENTIRE IMPORTANT SAFETY INFORMATION** section at the beginning of this manual including all text under subheadings therein before set up or use of this product.



TO PREVENT SERIOUS INJURY

FROM ACCIDENTAL OPERATION:

Unplug the AC/DC Adapter from its electrical outlet before assembling or making any adjustments to the tool.

Note: For additional information regarding the parts listed in the following pages, refer to the Assembly Diagram near the end of this manual.

- 1. AC/DC Adapter Input Cord (1):** Plugs into a 120 volt, grounded, electrical outlet *and* the AC/DC Adapter (2). (See Figure A.)
- 2. AC/DC Adapter with Cord (2):** Connects into Charger (3). (See Figure A.)
- 3. Charger (3):** Designed to charge 4.8, 7.2, 9.6, 12, 14.4, and 18 volt rechargeable NiMH or NiCd batteries. (See Figure A.)
- 4. Charger Output Clips (4):** Connects to the positive (+) and negative (-) terminals of a battery. (See Figure A.)

- 5. Charger Output Magnets (5):** Connects to the positive (+) and negative (-) tabs of a battery. (See Figure A.)

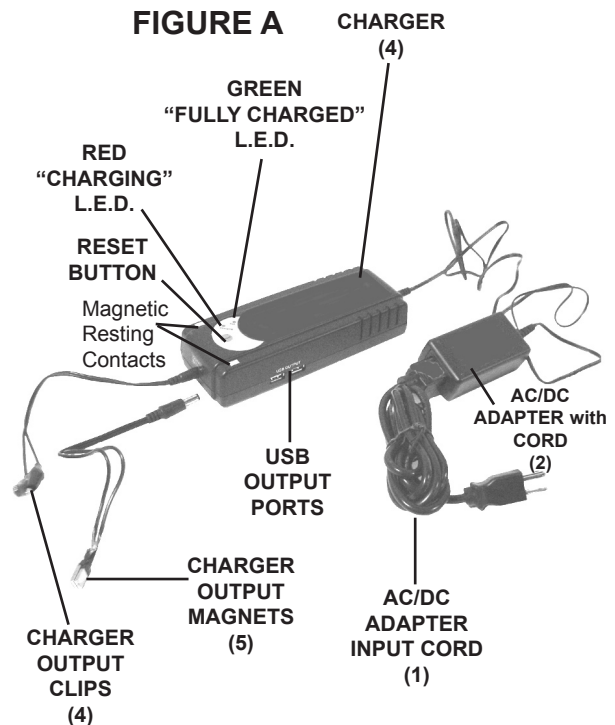

- 6. Red "Charging" and Green "Fully Charged": L.E.D.'s:** The Red and Green L.E.D.'s will flash simultaneously when the Battery Charger is first hooked up to a battery. When charging begins, the Green L.E.D. will turn off and the Red L.E.D. will continue illuminating. When charging is complete, the Red L.E.D. will turn off and the Green L.E.D. will illuminate. The Battery Charger will then "trickle" charge to keep the battery in a fully charged status. (See Figure A.)
- 7. Reset Button:** Charging will not begin if the battery is too cool or if the battery has not been used for a lengthy period of time, as indicated when the Red and Green L.E.D.'s *simultaneously* keep flashing. In this

case, press the Reset Button one or more times to warm the battery and start the charging process. If after pressing the Reset Button up to 5 times the Red and Green L.E.D.'s continue flashing, this indicates the battery is too old or defective and should be replaced. (See Figure A.)

OPERATING INSTRUCTIONS



Read the **ENTIRE IMPORTANT SAFETY INFORMATION** section at the beginning of this manual including all text under subheadings therein before set up or use of this product.

1. IMPORTANT:
 - a. Polarity is not critical.
 - b. This means the Charger Output Clips (4) or Charger Output Magnets (5) may be connected to a battery without need to match the Clips or Magnets to a specific positive (+) or negative (-) polarity on the battery terminals or battery tabs.
 - c. The **“intelligent non-polarity operation”** feature automatically detects and adjusts to the polarity and voltage of the battery before charging.
2. ADDITIONAL NOTES:
 - a. When charging a cool battery, place the battery in a warm location for at least one hour. Then, if necessary, press the Reset Button on the Charger (4) to aid in warming up the battery. Otherwise, the battery may not fully charge.
 - b. Do not allow the *black* and *red* Charger Clips (5) to touch one another

when the Battery Charger is plugged into an electrical outlet.

- c. Do not allow the *two* Charger Magnets (5) to touch one another when the Battery Charger is plugged into an electrical outlet. Do not place magnets on metal surfaces or adjacent to a metal tool where they can attach to a tool casing and short circuit.
 - d. Prior to using the Battery Charger, read the battery manufacturer's instruction for properly charging the batteries. **Never overcharge a battery.**
3. If the battery to be charged is designed with **terminals**, connect the Charger Output Clips (4) to the terminals and to the Charger. (See Figure B.)

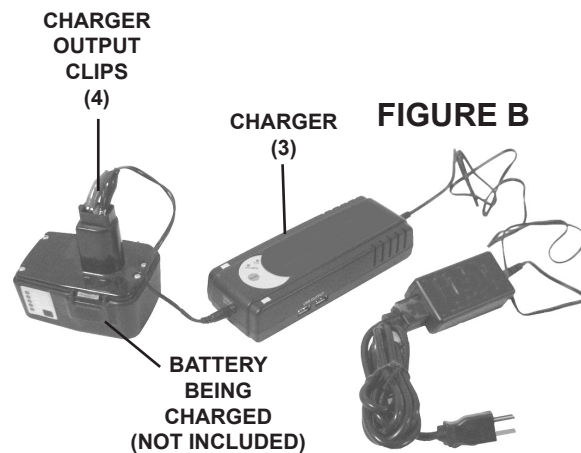

4. If the battery to be charged is designed with **tabs**, connect the Charger Output Magnets (5) to the tabs first. Then connect the Output Cord to the Charger. (See Figure C, next page.)

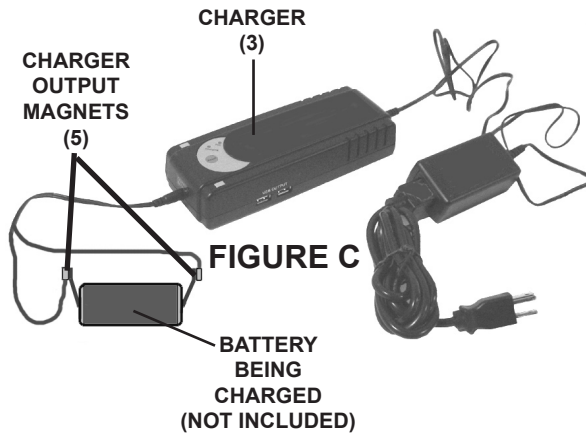

5. Connect the Charger Input Cord (2) to the Charger (3). **(See Figure D.)**
6. Connect the AC/DC Adapter Input Cord (1) to the AC/DC Adapter (2). Then plug into the nearest 120 volt, grounded, electrical outlet. **(See Figure D.)**
7. Once all connections are made, the Green L.E.D. will turn off. The Red L.E.D. will illuminate continuously to indicate “charging” is taking place. If necessary, press the Reset Button to initiate charging. **(See Figure D.)**
8. When charging is done, the Red L.E.D. will turn off. The Green L.E.D. will illuminate continuously, indicating the battery is “fully charged.” **(See Figure D.)**
9. When finished charging, disconnect the AC/DC Adapter Input Cord (1) from its electrical outlet. Then disconnect the Charger Output Clips (4) or Charger Output Magnets (5) from the battery. **(See Figure D.)**
10. NOTE: The Universal Battery Charger also features two USB Outlet

Ports for charging batteries. Check with your local electronics retailer for the proper USB charging output cords to be used with the Battery Charger. **(See Figure D.)**

10. Clean, then store the Universal Battery Charger and its accessories indoors out of children’s reach.

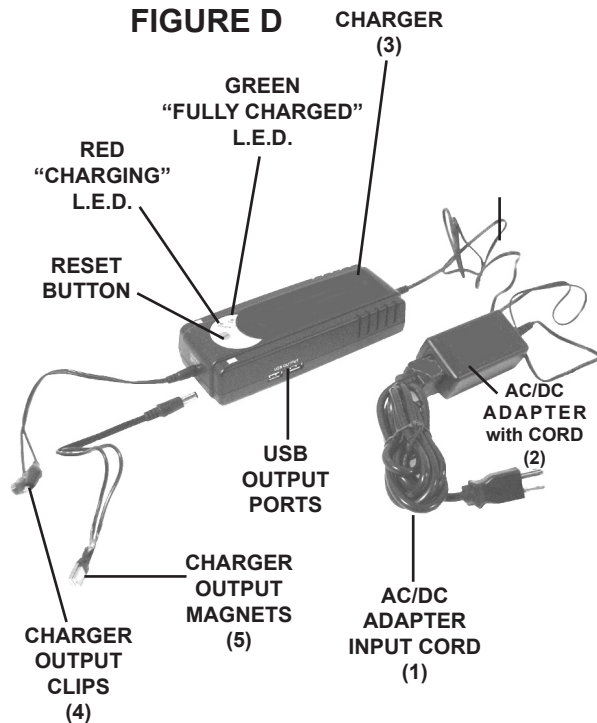

MAINTENANCE AND SERVICING



Procedures not specifically explained in this manual must be performed only by a qualified technician.

⚠WARNING**TO PREVENT
SERIOUS INJURY****FROM ACCIDENTAL
OPERATION:**

**Unplug the AC/DC Adapter (2)
from its electrical outlet
before performing any
inspection, maintenance, or
cleaning procedures.**

**TO PREVENT SERIOUS
INJURY FROM TOOL
FAILURE:**

**Do not use damaged
equipment. If abnormal noise
or vibration occurs, have the
problem corrected before
further use.**

1. **BEFORE EACH USE**, inspect the general condition of the Universal Battery Charger. Check for loose hardware, misalignment or binding of moving parts, cracked or broken parts, damaged electrical wiring, and any other condition that may affect its safe operation.
2. **AFTER USE**, wipe external surfaces of the tool with clean cloth.
3. **⚠WARNING!** If the AC/DC Adapter Input Cord (1) of this Universal Battery Charger is damaged, it must be replaced only by a qualified service technician.

TROUBLESHOOTING

| Problem | Possible Causes | Likely Solutions |
|---|--|--|
| Battery Charger will not start. | <ol style="list-style-type: none"> 1. AC/DC Adapter Input Cord not connected to 120 volt, grounded, electrical outlet. 2. No power at outlet. 3. Battery is cold or has not been used for an extended period. 4. Disconnected or poorly connected. | <ol style="list-style-type: none"> 1. Check that Cord is plugged in. 2. Check power at outlet. If outlet is unpowered, unplug Battery Charger and check circuit breaker. If breaker is tripped, make sure circuit is right capacity for Charger and circuit has no other loads. 3. Press Reset Button (see paragraph 8 on page 8.) 4. Re-connect charger input cord. |
| Green and red L.E.D.'s illuminate simultaneously. | <ol style="list-style-type: none"> 1. Battery is too cool or hasn't been used for a lengthy period of time. 2. Battery is old or defective. | <ol style="list-style-type: none"> 1. Press Reset Button as discussed in step #7 on pages 8 and 9 of this manual. 2. Press Reset Button as discussed in step #7 on pages 8 and 9 of this manual. If necessary, replace battery. |
| Green and red L.E.D.'s not illuminating. | <ol style="list-style-type: none"> 1. Improper or loose connection(s). | <ol style="list-style-type: none"> 1. Make sure all connections are properly and securely connected. |
| Charger becomes warm or hot during charging. | <ol style="list-style-type: none"> 1. This is normal operation. | <ol style="list-style-type: none"> 1. No action needs to be taken. |
| | | |



Follow all safety precautions whenever diagnosing or servicing the tool. Disconnect power supply before service.

PARTS LIST & ASSEMBLY DIAGRAM

| Part # | Description | Qty. | Part # | Description | Qty. |
|--------|--------------------------|------|--------|------------------------|-------|
| 1 | AC/DC Adapter Input Cord | 1 | 4 | Charger Output Clips | 1 set |
| 2 | AC/DC Adapter with Cord | 1 | 5 | Charger Output Magnets | 1 Set |
| 3 | Charger | 1 | | | |

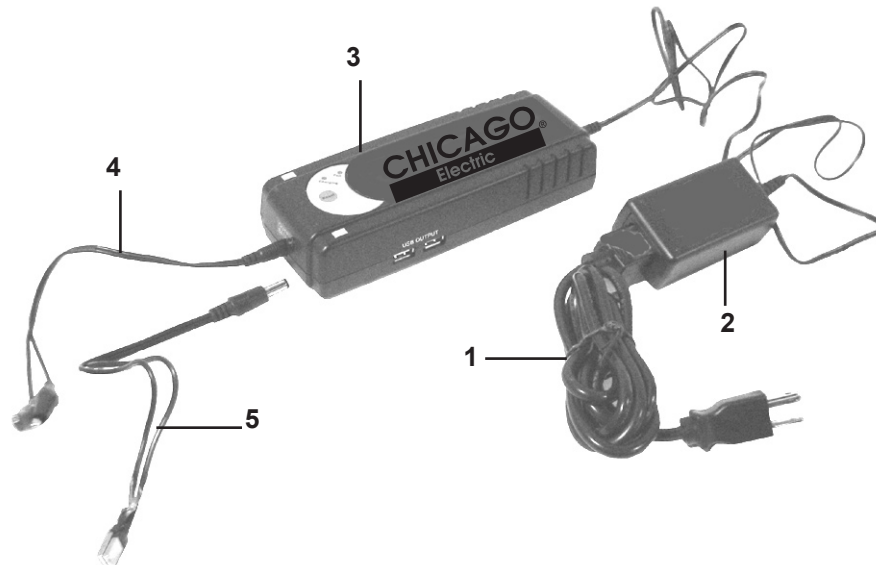

LIMITED 90 DAY WARRANTY

Harbor Freight Tools Co. makes every effort to assure that its products meet high quality and durability standards, and warrants to the original purchaser that this product is free from defects in materials and workmanship for the period of 90 days from the date of purchase. This warranty does not apply to damage due directly or indirectly, to misuse, abuse, negligence or accidents, repairs or alterations outside our facilities, criminal activity, improper installation, normal wear and tear, or to lack of maintenance. We shall in no event be liable for death, injuries to persons or property, or for incidental, contingent, special or consequential damages arising from the use of our product. Some states do not allow the exclusion or limitation of incidental or consequential damages, so the above limitation of exclusion may not apply to you. THIS WARRANTY IS EXPRESSLY IN LIEU OF ALL OTHER WARRANTIES, EXPRESS OR IMPLIED, INCLUDING THE WARRANTIES OF MERCHANTABILITY AND FITNESS.

To take advantage of this warranty, the product or part must be returned to us with transportation charges prepaid. Proof of purchase date and an explanation of the complaint must accompany the merchandise. If our inspection verifies the defect, we will either repair or replace the product at our election or we may elect to refund the purchase price if we cannot readily and quickly provide you with a replacement. We will return repaired products at our expense, but if we determine there is no defect, or that the defect resulted from causes not within the scope of our warranty, then you must bear the cost of returning the product.

This warranty gives you specific legal rights and you may also have other rights which vary from state to state.

3491 Mission Oaks Blvd. • PO Box 6009 • Camarillo, CA 93011 • (800) 444-3353

PLEASE READ THE FOLLOWING CAREFULLY

THE MANUFACTURER AND/OR DISTRIBUTOR HAS PROVIDED THE PARTS LIST AND ASSEMBLY DIAGRAM IN THIS MANUAL AS A REFERENCE TOOL ONLY. NEITHER THE MANUFACTURER OR DISTRIBUTOR MAKES ANY REPRESENTATION OR WARRANTY OF ANY KIND TO THE BUYER THAT HE OR SHE IS QUALIFIED TO MAKE ANY REPAIRS TO THE PRODUCT, OR THAT HE OR SHE IS QUALIFIED TO REPLACE ANY PARTS OF THE PRODUCT. IN FACT, THE MANUFACTURER AND/OR DISTRIBUTOR EXPRESSLY STATES THAT ALL REPAIRS AND PARTS REPLACEMENTS SHOULD BE UNDERTAKEN BY CERTIFIED AND LICENSED TECHNICIANS, AND NOT BY THE BUYER. THE BUYER ASSUMES ALL RISK AND LIABILITY ARISING OUT OF HIS OR HER REPAIRS TO THE ORIGINAL PRODUCT OR REPLACEMENT PARTS THERETO, OR ARISING OUT OF HIS OR HER INSTALLATION OF REPLACEMENT PARTS THERETO.

Record Product's Serial Number Here: _____

Note: If product has no serial number, record month and year of purchase instead.

Note: Some parts are listed and shown for illustration purposes only, and are not available individually as replacement parts.

Free Manuals Download Website

<http://myh66.com>

<http://usermanuals.us>

<http://www.somanuals.com>

<http://www.4manuals.cc>

<http://www.manual-lib.com>

<http://www.404manual.com>

<http://www.luxmanual.com>

<http://aubethermostatmanual.com>

Golf course search by state

<http://golfingnear.com>

Email search by domain

<http://emailbydomain.com>

Auto manuals search

<http://auto.somanuals.com>

TV manuals search

<http://tv.somanuals.com>