



Earn BISSELL Rewards!

Register your product today!

See details on back page

POWER groom[®] pet

USER'S GUIDE
67E2 SERIES

- 2** Thank You
- 3** Safety Instructions
- 4** Product View
- 5** Assembly
- 6-10** Operations
- 11-14** Maintenance and Care
- 15-16** Troubleshooting
- 17** Replacement Parts
- 18** Accessories
- 19** Warranty
- 20** Consumer Services
- 20** Product Registration



Thanks for buying a BISSELL PowerGroom® Pet Canister Vacuum

We're glad you purchased a BISSELL PowerGroom Pet canister vacuum. Everything we know about floor care went into the design and construction of this complete, high-tech home cleaning system.

Your PowerGroom Pet canister vacuum is well made, and we back it with a limited one year warranty. We also stand behind it with a knowledgeable, dedicated Consumer Services department, so, should you ever have a problem, you'll receive fast, considerate assistance.

My great-grandfather invented the floor sweeper in 1876. Today, BISSELL is a global leader in the design, manufacture, and service of high quality homecare products like your PowerGroom Pet Canister vacuum.

Thanks again, from all of us at BISSELL.

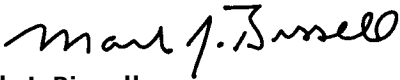

Mark J. Bissell
Chairman, President & CEO

IMPORTANT SAFETY INSTRUCTIONS

When using an electrical appliance, basic precautions should be observed, including the following:

READ ALL INSTRUCTIONS BEFORE USING YOUR CANISTER VACUUM.

Always connect to a polarized outlet (left slot is wider than right). Unplug from outlet when not in use and before conducting maintenance.

WARNING: To reduce the risk of fire, electric shock, or injury:

- Do not leave cleaner when it is plugged in.
- Unplug from outlet when not in use and before servicing.
- Do not use with damaged cord or plug.
- To unplug grasp plug not cord.
- Do not pull or carry by cord, use cord as a handle, close door on cord, pull cord around sharp corners, run cleaner over cord, or expose cord to heated surfaces.
- Hold plug when rewinding the cord onto the reel. Do not allow the plug to whip when rewinding.
- Do not use cleaner if it has been dropped, damaged, left outdoors or dropped into water. Have it repaired at an Authorized Service Center.
- Do not allow children to use as a toy.
- Do not use outdoors or on wet surfaces.
- Do not handle cleaner or plug with wet hands.
- Do not put any object into openings, use with blocked opening, or restrict air flow.
- Do not use without dust bag and/or filters in place.
- Do not allow hair, loose clothing, fingers or body parts to get near openings or floor brush in the appliance.
- Do not pick up hot coals, cigarette butts, matches or any hot, smoking, or burning objects.
- Do not pick up hard or sharp objects such as glass, nails, screws, coins, etc.

- Do not pick up flammable or combustible materials (lighter fluid, gasoline, kerosene, etc.) or use in the presence of explosive liquids or vapor.
- Do not unplug by pulling on cord.
- Do not pick up toxic material (chlorine bleach, ammonia, drain cleaner, etc.).
- Do not use in an enclosed space filled with vapors given off by oil base paint, paint thinner, some moth proofing substances, flammable dust, or other explosive or toxic vapors.
- Do not use for any purpose other than described in this User's Guide.
- Always turn off this appliance before connecting or disconnecting vacuum hose.
- Use only manufacturer's recommended attachments.
- Use only on dry, indoor surfaces.
- Keep openings free of dust, lint, hair, etc.
- Keep appliance on a level surface.
- Turn off all controls before plugging or unplugging cleaner.
- Be extra careful when cleaning stairs.
- Close attention is necessary when used by or near children.

SAVE THESE INSTRUCTIONS FOR FUTURE USE

THIS APPLIANCE HAS A POLARIZED PLUG.

To reduce the risk of electric shock, this appliance has a polarized plug (one blade is wider than the other). This plug will fit in a polarized outlet only one way. If the plug does not fit fully in the outlet, reverse the plug. If it still does not fit, contact a qualified electrician to install a proper outlet. Do not change the plug in any way.

This model is for household use only.

Product view



BareFloor Tool



Floor Brush



Upholstery Tool



Crevice Tool



Dusting Brush



Tool Holder



Pet Contour Tool®



Wide Pet TurboBrush®



Pet Tool Adaptor



Accessory Storage Bag



Assembly

1. Connect swivel hose by squeezing both locking buttons and inserting it into the suction opening on the canister. Once the swivel hose is inserted in the suction opening, release the locking buttons.
2. Plug the cord from the hose into the slot on the lower left front of canister.
3. Connect and plug-in telescoping extension wand to the handle end of the flex hose.
4. Connect the powerhead onto the telescoping extension wand.
5. Attach the tool holder to the telescoping extension wand and insert the tools into the holder.
6. To extend the telescopic tube, push the black release button and then pull the tube to the desired length.

NOTE: Shorten length of telescopic tube for storage.

7. To store the barefloor tool, insert the storage clip into the storage slot on the rear of the vacuum or on the back of the unit when in an upright position.

WARNING:
Plastic film can be dangerous. To avoid danger of suffocation, keep away from babies and children.



Operations

Special tools

Your **BISSELL PowerGroom Pet** is not only a powerful carpet and rug vacuum cleaner, it's also a versatile bare floor vacuum cleaner and above floor vacuum cleaner when you select one of the special tools.



Powerhead:

The **PowerGroom Pet** comes with the powerhead for your regular use. The powerhead has many features, including:

1. A motorized, rotating brush that can be turned on/off by a switch on the handle so you can protect your bare floors.
2. Six height adjustments so you can vacuum from non-carpet to carpeted areas with ease.
3. Variable suction control which can be controlled on a switch located on the handle.

BareFloor tool:

Use to vacuum carpets, rugs and bare floors. Swivel head turns to get into tight spaces and fits under cabinets.

1. To vacuum carpets and rugs, push the brush switch to the carpet position . This will pull the brushes up into the floor nozzle.
2. To vacuum bare floors, push the brush switch to the bare floor position . This will extend the brushes down from the floor nozzle.

Pet Tool Adapter:

The **Pet Tool Adapter** must be attached to the handle end of the flex hose to use the **Pet Contour Tool** and the **Wide Pet TurboBrush**. The narrow end of the adapter attaches to the handle end of the flex hose and the wide end of the adapter attaches to the pet tool of your choice. The adapter should fit snugly to the hose and pet tool without using excessive force.

Tip:

Before cleaning under low furniture, check area first for objects that might harm the unit or block the hose.

Tip:

Hair, string and small objects can block the hose and tools. Check them occasionally for obstructions.

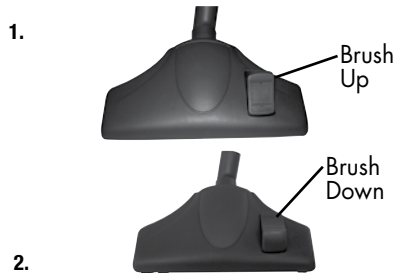

Operations

Special tools continued

Pet Contour Tool:

Use to reach into corners and edges on stairs, as well as armrests and other curved surfaces. The tool can be flipped to use in any direction.



Wide Pet TurboBrush:

Use rotating brush action for small, flat areas such as cushions and beds.



Floor brush:

Ideal for cleaning edges on bare floor.



Dusting brush:

Use the dusting brush to dust furniture, blinds, books, lamps, shelves and baseboards.



Upholstery tool:

Use the upholstery tool to clean curtains, draperies, cushions and fabrics.



Crevice tool:

Use the crevice tool in tight, narrow spaces.



Power cord

The power cord is located at the rear of the vacuum. Gently pull out the power cord, watching for the yellow line. Stop pulling the power cord once the yellow line is visible. There is also a red line, which indicates the end of the usable cord. Do not pull the power cord out beyond the red line.



Automatic cord rewind

Your vacuum is equipped with an automatic cord rewind. When cleaning is finished, press the power button OFF and grasp the plug to disconnect from the electrical outlet. Hold the plug and press the automatic cord rewind button to rewind the cord automatically.

Automatic
Cord
Rewind
Button



CAUTION:

Be careful to avoid injury as cord retracts very quickly.

Operations

Power button

Turn the power on or off by pressing lightly downward on the power button (ⓘ).

Power Button



Motorized powerhead

Set the power switch on the handle to 1 for rotating brush or 0 to turn rotating brush off.

NOTE: The power brush will automatically turn off if the telescopic tube is in an upright position to protect your carpet from potential damage caused by the rotation of the power brush.

NOTE: The power brush will automatically turn off if the rotator bar is blocked by clogs (hair, cloth, ect.) for your protection. In that case, turn off the power head, unplug the vacuum, clean the clog, and re-start the power brush.

Variable Suction Control

PowerBrush On/Off



Variable suction power control

The variable suction power control is located on the top of the handle. Slide the control toward the larger dots for maximum suction. Slide the control toward the smaller dots to minimize suction for lightly soiled areas or delicate fabrics.



CAUTION:

Before using your vacuum, make sure that the dust bag and all filters (pre-motor and post-motor) are in place. Do not operate your vacuum without the dust bag and filters.

Variable height adjustments

Step on the brush height adjuster located on the right side of the motorized powerhead to adjust for flooring type (lowest setting (1) for non-carpet, indoor areas, highest setting (6) for plush pile carpet).



Operations

Handle position

Press the handle release pedal, located in the middle of the motorized powerhead, with your foot to place your vacuum into one of the three cleaning positions.

1. Upright – For storage and above floor cleaning with tools.
2. Normal Cleaning – Press handle release pedal once. Position used for most household floor cleaning tasks.
3. Low Cleaning – With the vacuum in normal cleaning position, press handle release pedal again. Use for reaching under low furniture such as tables, chairs or beds.

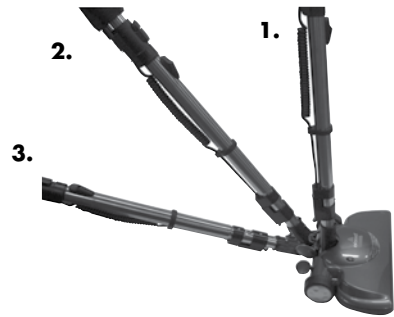

Tip:

Before cleaning under low furniture, check area first for objects that might harm the unit or block the vacuum hose.

Bag change indicator

The bag change indicator is located between the power button and the automatic cord rewind button. If the bag change indicator turns orange while you are vacuuming, the dust bag needs to be replaced. The dust bag may appear to be full or only partially full depending upon the type of debris picked up. Fine particles can block the airflow in the dust bag and reduce suction before the dust bag is full. If the bag change indicator remains orange, even after changing the dust bag, turn the vacuum off and check for a clog in the hose or tools.

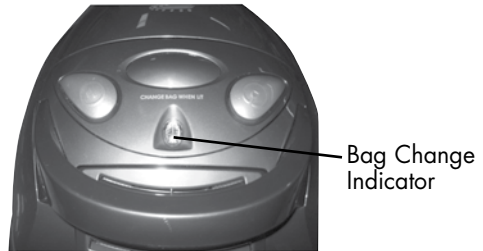

Operations

Dust bag replacement

1. Unplug the vacuum from electrical outlet.
2. Disconnect hose
3. Open the dust bag compartment by lifting up on the latch on the door on the front of the vacuum.
4. Lift out the dust bag holder and dust bag.
5. Release the dust bag from the holder by pressing the dust bag holder clip and pulling the dust bag out of the holder. Discard the used dust bag.
6. Slide the new dust bag into the holder by inserting the dust bag into the tabs located at the bottom of the holder. Then press the dust bag holder clip, insert the dust bag and release the dust bag holder clip to hold the dust bag in place.
7. Place holder and new dust bag back into the dust bag compartment, making sure the entire bag is tucked in below the seal gasket.
8. Close dust bag compartment door and press down gently until it locks into place.
NOTE: The dust bag compartment door will not close without the dust bag in place.
9. Reconnect hose.

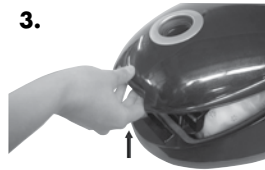

 **WARNING:**
To reduce the risk of electric shock, turn power switch OFF and disconnect plug from electrical outlet before performing maintenance or troubleshooting checks.

Maintenance and care

Cleaning the pre-motor filter

The pre-motor filter protects the motor from dirt and dust particles.

1. Unplug the vacuum from electrical outlet.
2. Disconnect hose
3. Open the dust bag compartment by lifting up on the latch on the door at the front of the vacuum. Lift out the dust bag holder and dust bag.
4. Remove the filter frame from the filter holder by grasping the lip of the frame and pulling up.
5. Remove the filter from the filter frame and clean by hand washing in warm water. A mild detergent can be used if desired. Allow the filter to air dry thoroughly before replacing.
6. Place the filter back into the filter frame and replace back into the filter holder.
NOTE: The filter frame should be placed so the protective frame is visible.
7. Place dust bag holder and dust bag into the dust bag compartment, making sure the entire bag is tucked in below the seal gasket.
8. Close dust bag compartment door and press down gently until it locks into place.
9. Reconnect hose.

NOTICE:

This product is intended for household use only and not for commercial or industrial use. Vacuuming of dust from products like plaster, concrete or ashes will damage the motor and void the warranty.

Washable Pre-Motor Filter

3.

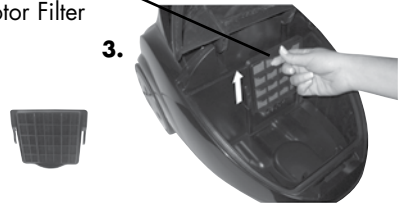

Tip:

For maximum cleaning performance, check the filters often and clean or replace if necessary.



WARNING:

Do not operate cleaner with damp or wet filters or without all filters in place.

Maintenance and care

Replacing the post-motor HEPA media filter

The post-motor HEPA media filter assists in the filtration process to return clean air to the room.

1. Unplug the vacuum from electrical outlet.
2. Remove the filter door (located on the rear of the vacuum) by pulling up on the filter door latch.
3. Remove the post-motor HEPA media filter by grasping the lip of the filter frame and pulling up.
4. Replace the post-motor HEPA media filter with a new filter.

NOTE: The post-motor filter is a white, pleated HEPA media filter. This filter is NOT washable and must be replaced when it becomes dirty.

NOTE: The HEPA media filter should not be touched, when handling be sure to only touch the frame.

5. Replace the filter door by inserting the two tabs at the top of the filter door and pushing down on the bottom of the filter door.

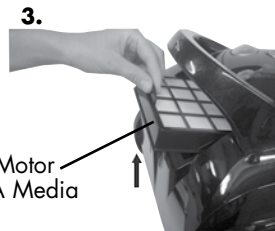

Post-Motor
HEPA Media
Filter

Maintenance and care

Maintaining the Wide Pet TurboBrush

The Wide Pet TurboBrush should be checked regularly for clogs or debris wrapping around the brush.

1. Turn vacuum OFF (Ⓞ) unplug the vacuum from electrical outlet.
2. If a clog is present or debris is visible, turn the collar on the neck of the Wide Pet TurboBrush counter-clockwise to the unlocked position to remove the faceplate and clear any obstructions.
3. To clean debris from the brush, remove the brush from the drive belt and clean debris.
4. Reposition the drive belt on the brush. Place the ends of the brush in the slots on the sides. Reposition the faceplate and turn the collar clockwise to the locked position.



Maintenance and care

Cleaning the motorized powerhead

The brush can usually be cleaned without removal from the vacuum. If there is an excessive amount of hair and debris, however, it is best to remove the brush.

1. Unplug the vacuum.
2. Lay the motorized powerhead forward on the floor.
3. Locate the locking screws (2) on the bottom of the powerfoot. Using a Phillips head screwdriver, remove the screws. Lift off the brush cover. Grasp the brush firmly, and pull it out.
4. Clean debris from brush. Lint, carpet pile, and hair can be removed with a pair of scissors. If brush bristles are worn or missing, replace brush.
5. Slide belt over brush onto the belt track. Slide belt over the motor pulley. To reinstall brush, slide square ends of brush into grooves, beginning with the belt side. The drive belt should have room to rotate within the belt channel. Make sure drive belt is looped over roller and not twisted. Inspect belt action by rolling the brush with the palm of your hand.
6. Reattach brush cover to powerhead with (2) screws.



Replacing the drive belt

1. Follow steps 1, 2 and 3 from the Cleaning the motorized powerhead section.
2. Remove old belt from brush.
3. Attach new belt, aligning as indicate in steps 5 and 6 from Cleaning the motorized power head section.

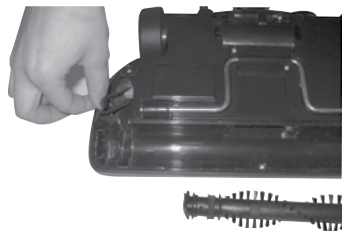

Troubleshooting



WARNING:

To reduce the risk of electric shock, turn power OFF and disconnect plug from electrical outlet before performing maintenance or troubleshooting.

Vacuum cleaner won't run

Possible causes

1. Vacuum cleaner is not plugged in
2. Power button is not pressed down

Remedies

1. Check electrical plug
2. Press power button down

Vacuum cleaner won't pick up or low suction

Possible causes

1. Tools, flex hose and/or telescoping extension wand are blocked
2. Filters are dirty
3. Dust bag is full
4. Swivel hose not securely attached to suction opening
5. Crack or hole in flex hose
6. Air flow regulator or variable suction power control is set to open or minimum setting

Remedies

1. Remove each part and check for blockages
2. Check and clean or replace pre-motor and post-motor filters
3. Replace with new dust bag
4. Make sure swivel hose is locked into suction opening
5. Check hose and replace if needed
6. Change to closed or maximum setting

Visible dust escaping from vacuum

Possible causes

1. Dust bag is full
2. Filters missing or installed incorrectly
3. Filters are dirty
4. Flex hose is blocked
5. Swivel hose not securely attached to suction opening
6. Crack or hole in flex hose

Remedies

1. Replace with new dust bag
2. Check pre-motor and post-motor filter for correct installation
3. Check and clean or replace pre-motor and post-motor filters
4. Remove hose and check for blockages
5. Make sure swivel hose is locked into suction opening
6. Check hose and replace if needed

Troubleshooting

Other maintenance or service not included in the manual should be performed by an authorized service representative.

Thank you for selecting a BISSELL product.

Please do not return this product to the store.

For any questions or concerns, BISSELL is happy to be of service. Contact us directly at 1-800-237-7691.

Replacement parts - BISSELL vacuum

Item	Part No.	Part Name
1	203-7270	Dust Bag (3pk)
2	203-7268	Pre-Motor Filter
3	203-7269	Post-Motor HEPA Media Filter
4	203-7315	Hose Grip with Powercord
5	203-7274	Tool Holder

1

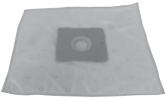

2

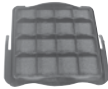

3



4



5



Accessories

Item	Part No.	Part Name
1	203-7309	Barefloor Tool
2	203-7310	Floor Brush
3	203-7314	Extension Wand with Power Cord
4	203-7273	Upholstery Tool
5	203-7272	Dusting Brush
6	203-7271	Crevice Tool
7	203-7279	Pet Tool Adaptor
8	203-1291	Pet Contour Tool
9	203-1290	Wide Pet TurboBrush
10	203-7278	Accessory Bag

1



2



3



4



5



6



7



8



9



10



Warranty - BISSELL PowerGroom Pet Compact Vacuum

This warranty gives you specific legal rights, and you may also have other rights which may vary from state to state. If you need additional instruction regarding this warranty or have questions regarding what it may cover, please contact BISSELL Consumer Services by E-mail, telephone, or regular mail as described below.

Limited One Year Warranty

Subject to the *EXCEPTIONS AND EXCLUSIONS identified below, upon receipt of the product BISSELL Homecare, Inc. will repair or replace (with new or remanufactured components or products), at BISSELL's option, free of charge from the date of purchase by the original purchaser, for one year any defective or malfunctioning part.

See information below on "If your BISSELL product should require service".

This warranty applies to product used for personal, and not commercial or rental service. This warranty does not apply to fans or routine maintenance components such as filters, belts, or brushes. Damage or malfunction caused by negligence, abuse, neglect, unauthorized repair, or any other use not in accordance with the User's Guide is not covered.

If your BISSELL product should require service:

Contact BISSELL Consumer Services to locate a BISSELL Authorized Service Center in your area.

If you need information about repairs or replacement parts, or if you have questions about your warranty, contact BISSELL Consumer Services.

Website or E-mail:

www.bissell.com

Use the "Customer Support" tab.

Or Call:

BISSELL Consumer Services

1-800-237-7691

Monday - Friday 8 a.m. - 10 p.m. ET

Saturday 9 a.m. - 8 p.m. ET

Or Write:

BISSELL Homecare, Inc.

PO Box 3606

Grand Rapids, MI 49501

ATTN: Consumer Services

BISSELL HOMECARE, INC. IS NOT LIABLE FOR INCIDENTAL OR CONSEQUENTIAL DAMAGES OF ANY NATURE ASSOCIATED WITH THE USE OF THIS PRODUCT. BISSELL'S LIABILITY WILL NOT EXCEED THE PURCHASE PRICE OF THE PRODUCT.

Some states do not allow the exclusion or limitation of incidental or consequential damages, so the above limitation or exclusion may not apply to you.

***EXCEPTIONS AND EXCLUSIONS FROM THE TERMS OF THE LIMITED WARRANTY**
THIS WARRANTY IS EXCLUSIVE AND IN LIEU OF ANY OTHER WARRANTIES EITHER ORAL OR WRITTEN. ANY IMPLIED WARRANTIES WHICH MAY ARISE BY OPERATION OF LAW, INCLUDING THE IMPLIED WARRANTIES OF MERCHANTABILITY AND FITNESS FOR A PARTICULAR PURPOSE, ARE LIMITED TO THE ONE YEAR DURATION FROM THE DATE OF PURCHASE AS DESCRIBED ABOVE.

Some states do not allow limitations on how long an implied warranty last so the above limitation may not apply to you.



Don't forget to register your product!

Registering is quick, easy and offers you benefits over the lifetime of your product. You'll receive:

BISSELL Rewards Points

Automatically earn points for discounts and free shipping on future purchases.

Faster Service

Supplying your information now saves you time should you need to contact us with questions regarding your product.

Product Support Reminders and Alerts

We'll contact you with any important product maintenance reminders and alerts.

Special Promotions

Optional: Register your email to receive notice of offers, contests, cleaning tips and more!

Visit www.bissell.com/registration now!



BISSELL consumer services

For information about repairs or replacement parts, or questions about your warranty, call:

BISSELL Consumer Services

1-800-237-7691

Monday - Friday 8 a.m. — 10 p.m. ET

Saturday 9 a.m. — 8 p.m. ET

Or write:

BISSELL Homecare, Inc.

PO Box 3606

Grand Rapids MI 49501

ATTN: Consumer Services

Or visit the BISSELL website - **www.bissell.com**

When contacting BISSELL, have model number of cleaner available.

Please record your Model Number: _____

Please record your Purchase Date: _____

NOTE: Please keep your original sales receipt. It provides proof of purchase date in the event of a warranty claim. See Warranty on page 19 for details.



©2010 BISSELL Homecare, Inc
Grand Rapids, Michigan
All rights reserved. Printed in China
Part Number 110-4233
Rev 4/10
Visit our website at:
www.bissell.com



Free Manuals Download Website

<http://myh66.com>

<http://usermanuals.us>

<http://www.somanuals.com>

<http://www.4manuals.cc>

<http://www.manual-lib.com>

<http://www.404manual.com>

<http://www.luxmanual.com>

<http://aubethermostatmanual.com>

Golf course search by state

<http://golfingnear.com>

Email search by domain

<http://emailbydomain.com>

Auto manuals search

<http://auto.somanuals.com>

TV manuals search

<http://tv.somanuals.com>