



ProHeat®

USER'S GUIDE

1699, 7901, 8910 SERIES

- 3 Safety Instructions
- 4-5 Product View / Accessories
- 6 Assembly
- 7-16 Features / Operations
- 16-18 Troubleshooting / User Maintenance
- 18 Consumer Services
- 19 Replacement Parts
- 20 Warranty



Thanks for buying a BISSELL ProHeat

We're glad you purchased a BISSELL ProHeat heated formula deep cleaner. Everything we know about floor care went into the design and construction of this complete, high-tech home cleaning system.

Your ProHeat is well made, and we back it with a limited one-year warranty. We also stand behind it with a knowledgeable, dedicated Consumer Services department, so, should you ever have a problem, you'll receive fast, considerate assistance.

My great-grandfather invented the floor sweeper in 1876. Today, BISSELL is a global leader in the design, manufacture, and service of high quality homecare products like your ProHeat .

Thanks again, from all of us at BISSELL.

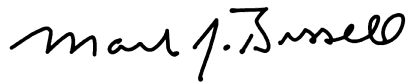

Mark J. Bissell
President and Chief Executive Officer



IMPORTANT SAFETY INSTRUCTIONS

When using an electrical appliance, basic precautions should be observed, including the following:

Read all instructions before using your PROHEAT®

⚠ WARNING: To reduce the risk of fire, electric shock, or injury:

- Do not immerse.
- Use only on surfaces moistened by cleaning process.
- Always connect to a properly grounded outlet.
- See Grounding Instructions.
- Unplug from outlet when not in use and before conducting maintenance or troubleshooting.
- Do not leave machine when it is plugged in.
- Do not service machine when it is plugged in.
- Do not use with damaged cord or plug.
- If appliance is not working as it should, has been dropped, damaged, left outdoors, or dropped into water, have it repaired at an authorized Service Center.
- Use indoors only.
- Do not pull or carry by cord, use cord as a handle, close door on cord, pull cord around sharp corners or edges, run appliance over cord, or expose cord to heated surfaces.
- Do not carry the appliance while in use.
- Do not unplug by pulling on cord. Unplug by grasping the plug, not the cord.
- Do not handle plug or appliance with wet hands.
- Do not put any object into appliance openings, use with blocked opening, or restrict air flow.
- Do not expose hair, loose clothing, fingers or body parts to openings or moving parts.
- Do not pick up hot or burning objects.
- Do not pick up flammable or combustible materials (lighter fluid, gasoline, kerosene, etc.) or use in the presence of explosive liquids or vapor.
- Do not use appliance in an enclosed space filled with vapors given off by oil base paint, paint thinner, some moth proofing substances, flammable dust, or other explosive or toxic vapors.
- Do not pick up toxic material (chlorine bleach, ammonia, drain cleaner, gasoline, etc.).
- Do not modify the 3-prong grounded plug.
- Do not allow to be used as a toy.
- Do not use for any purpose other than described in this User's Guide.
- Do not operate the appliance unless the belt door is securely assembled in the location provided.
- Use only manufacturer's recommended attachments.
- Use only cleaning products formulated by BISSELL for use in this appliance to prevent internal component damage. See the cleaning fluid section of this guide.
- Keep openings free of dust, lint, hair, etc.
- Do not point attachment nozzle at people or animals

www.bissell.com



800.237.7691

3

- Keep appliance on a level surface.
 - Turn off all controls before unplugging.
 - Unplug before attaching the TurboBrush.®
 - Be extra careful when cleaning stairs.
 - Close attention is necessary when used by or near children.
 - **WARNING:** The Power Cord on this product contains lead, a chemical known to the State of California to cause birth defects or other reproductive harm.
- Wash hand after handling.**

SAVE THESE INSTRUCTIONS.

GROUNDING INSTRUCTIONS

This appliance must be connected to a grounded wiring system. If it should malfunction or break down, grounding provides a safe path of least resistance for electrical current, reducing the risk of electrical shock. The cord for this appliance has an equipment-grounding conductor and a grounding plug. It must only be plugged into an outlet that is properly installed and grounded in accordance with all local codes and ordinances.

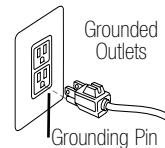

⚠ WARNING: Improper connection of the equipment-grounding conductor can result in a risk of electrical shock. Check with a qualified electrician or service person if you aren't sure if the outlet is properly grounded. **DO NOT MODIFY THE PLUG.** If it will not fit the outlet, have a proper outlet installed by a qualified electrician. This appliance is designed for use on a nominal 120-volt circuit, and has a grounding attachment plug that looks like the plug in the drawing above. Make certain that the appliance is connected to an outlet having the same configuration as the plug. No plug adapter should be used with this appliance.

This model is for household uses only.

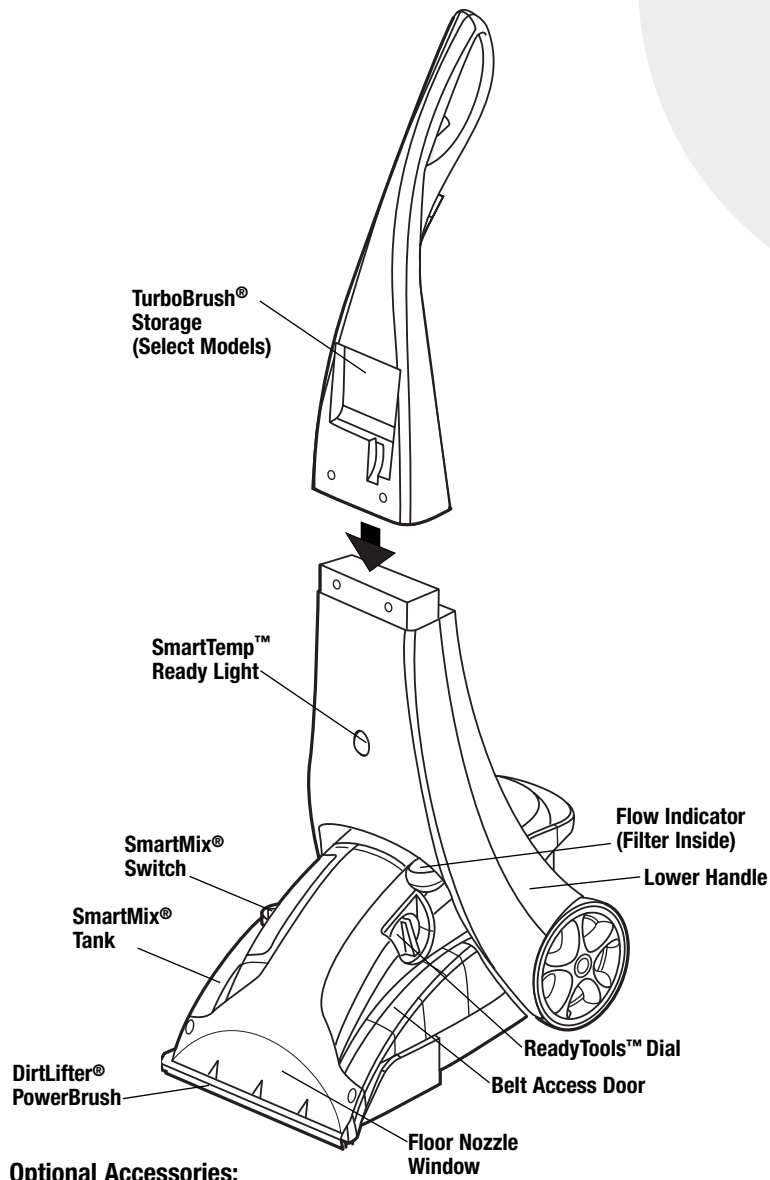

Optional Accessories:

These items are available for purchase with your model. To order replacement parts or additional tools or formulas, please refer to page 19.

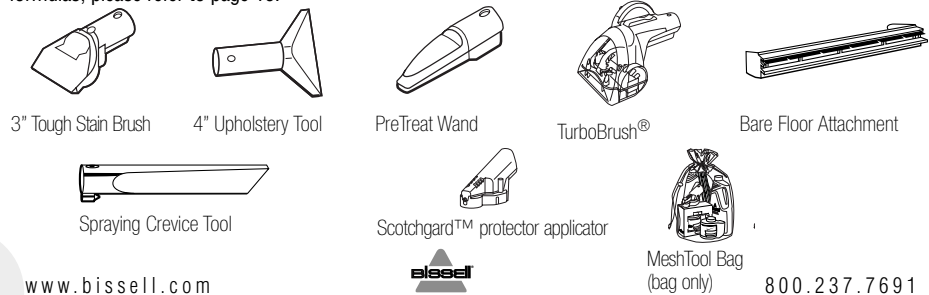

Keep plenty of genuine BISSELL Advanced Cleaning Formulas on hand so you can clean whenever it fits your schedule. Always use genuine BISSELL deep cleaning formulas. Non-BISSELL cleaning solutions may harm the machine and will void the warranty.

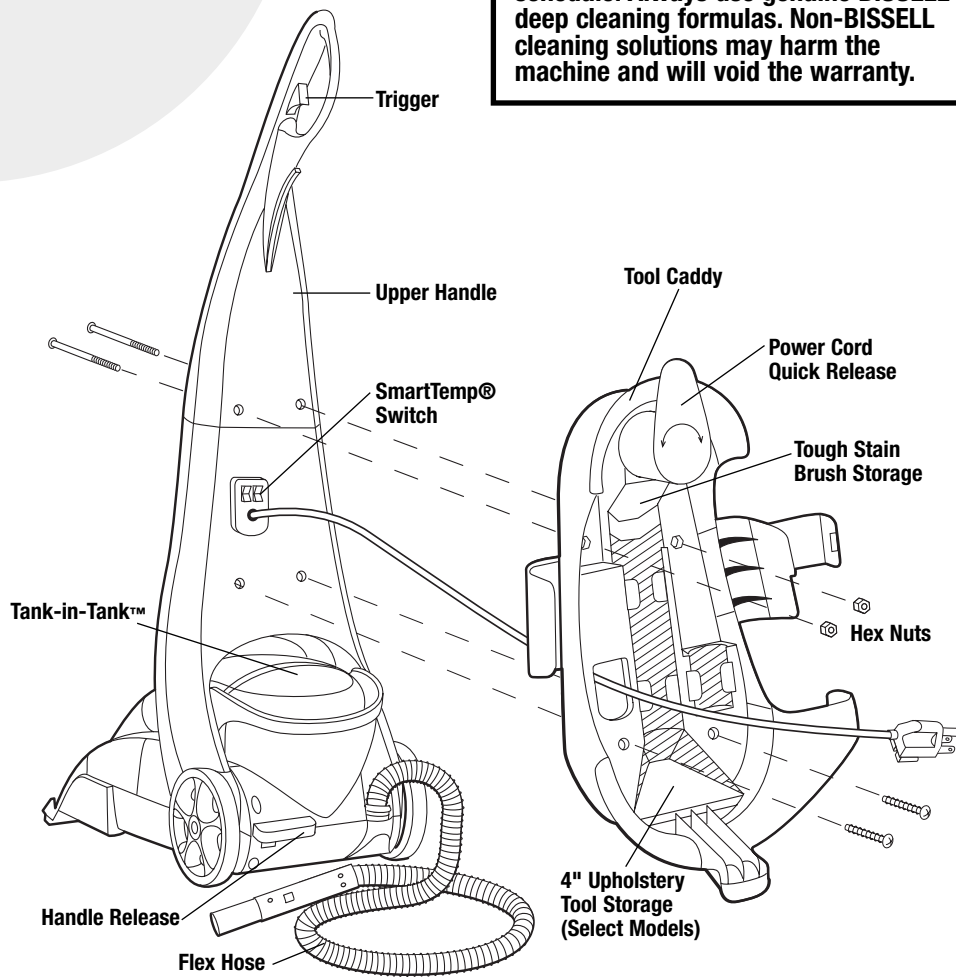

BISSELL Formulas:



48 oz. Fiber Cleansing Formula™ with Scotchgard™ Protector



48 oz. Multi-Allergen Removal™ Formula™ with Scotchgard™ Protector



48 oz. Pet Odor and Soil Removal™ Formula with Scotchgard™ Protector



48 oz. BISSELL Natural Orange Extract Formula with Scotchgard™ Protector



22 oz. Tough Stain PreCleaner™



32 oz. Hard Floor Solutions™



8 oz. Scotchgard Protector Post Treatment Cartridge

www.bissell.com



800.237.7691

5

How to Use this Guide

This User's Guide has been designed to help you get the utmost satisfaction from your BISSELL ProHeat. You'll find assembly and operating instructions, safety precautions, as well as maintenance and troubleshooting instructions. Please read this Guide thoroughly before assembling your Deep Cleaner.

Pay particular attention to the product diagram, assembly instructions, and part names. Locate and organize all parts before assembly. Familiarize yourself with the parts and where they go. Following this User's Guide will greatly enhance your ability to get the most performance from your BISSELL ProHeat for many years.

Your ProHeat comes in three, easy to assemble components:

- Upper Handle
- Lower Handle
- Tool Caddy

The only thing you will need to assemble your cleaner is a Phillips head  screwdriver.

 **WARNING:**
Do Not plug in your cleaner until you have completely assembled it per the following instructions and are familiar with all instructions and operating procedures.

Assembling Your ProHeat

Refer to Assembly Diagram on page 5

1. Slide Upper Handle onto Lower Handle.
2. Feed bundled power cord through Tool Caddy from caddy's flat side.
3. Align Upper Handle holes and Tool Caddy holes.
4. Place hex nut into back of Tool Caddy and hold in place. Insert bolt from front to back turning into the hex nut until snug. Do not over tighten. Repeat for the second bolt and hex nut.
5. Insert 2 screws into lower 2 holes. Turn until snug.
6. Snap tools into Storage on the Tool Caddy.
7. Wrap Power Cord and Flex Hose as shown in figure 7.

ProHeat assembly is now complete.

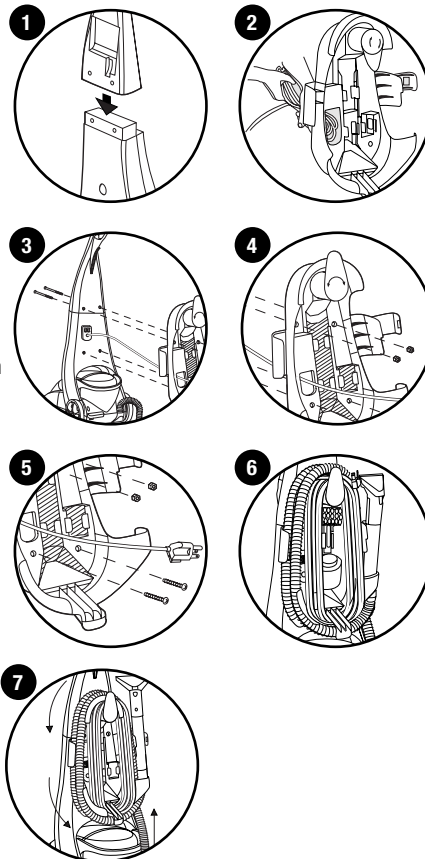

Special Features of Your BISSELL ProHeat

Your BISSELL ProHeat Deep Cleaner is a home cleaning system that automatically mixes hot tap water with BISSELL advanced cleaning formulas and heats the solution as it is applied to the carpet. The combination of heated solution, rotating brushes and powerful suction provide a safe and effective method of cleaning.

SmartTemp[®]

The BISSELL ProHeat models all feature a patented built-in heater which will heat hot tap water you put in up to 25° degrees hotter to safely optimize cleaning effectiveness. The heater will never allow the temperature to exceed 180°. The Heater Switch which is located on the back of the machine controls the Heater so you have the option to turn off the heat if you are cleaning delicate wool or oriental rugs.

SmartTemp Ready Light

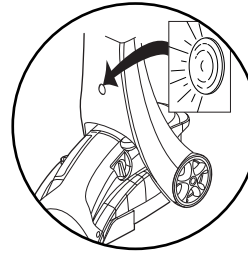

DirtLifter[®] PowerBrush

The DirtLifter PowerBrush is designed to enhance cleaning performance. The bristle pattern safely lifts out the deep down dirt while gently grooming carpet fibers. The floating suspension self-adjusts to all carpet heights. When the power is ON (I) and the machine is in the upright position, your carpet is protected because the brushes are lifted up off the carpet.

SmartMix[®]

The SmartMix feature automatically mixes hot tap water with the BISSELL advanced cleaning formula. Simply choose one of the 3 settings (High Traffic, Normal, or Water Rinse) and the ProHeat will adjust the right amount of cleaning solution to mix with the heated water to fit your cleaning need.

SmartMix bottle

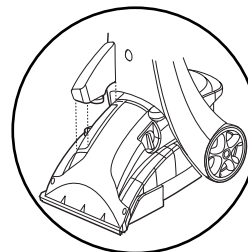

Having a separate solution tank from the water tank allows no waste of formula. Because the water and solution are stored separately, they are not mixed until you are ready to clean. When your cleaning job is finished, the formula can be stored ready to use in your machine for the next time!

This feature is available on all ProHeat models.

Scotchgard™ Protector Applicator Tool and Scotchgard Warranty

Carpet protection applied at the mill typically wears down over time from heavy foot traffic and everyday cleaning, including deep cleaning. To help restore this important protection, only BISSELL offers deep cleaning formulas with Scotchgard protector as well as a post-applicator to apply the same Scotchgard protector used by carpet mills. This offers extra protection against dirt and tough stains to keep your carpets looking good longer.

To maintain your Scotchgard 5-year limited stain warranty, you no longer are required to hire a professional. By using your BISSELL ProHeat machine with BISSELL formulas containing Scotchgard protector every 12 months, your carpet warranty from 3M remains in effect. No other home deep cleaning system can do this for you. Refer to the Scotchgard protector warranty for details.

Tank-in-Tank™

Our tank in tank system is designed with a heavy duty bladder inside for clean water. As you clean, the clean water in the bladder will empty and mix with the cleaning formula. Dirty water pulled out of your carpets will collect around the outside of the bladder so that clean and dirty water are always kept separate. This allows the user to maximize tank space, yet only carry one tank to and from the sink for emptying and filling.

Ready Tools Dial

This provides either floor cleaning or above the floor cleaning with the flip of a switch. If choosing above floor cleaning for upholstery, stairs, or along the baseboards, choose the attachment appropriate for the job. Attach tool to the hose, and you are ready to go!

Flow Indicator

This is located on the machine base. It spins when the trigger is pressed to indicate that the machine is applying cleaning solution to the carpet and will stop spinning when the SmartMix tank or Bladder needs to be refilled, or when the trigger is released.

Note: Flow Indicator does not spin when spraying through the attachment hose.

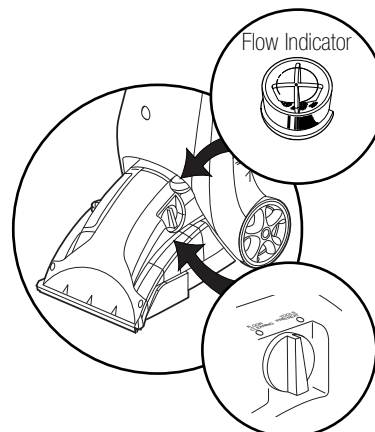
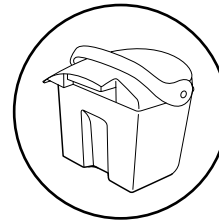
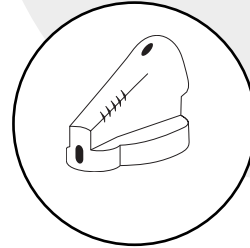

ReadyTools Dial

Before You Clean

1. Plan activities to give your carpet time to dry.
2. Move furniture to another area if cleaning an entire room (optional).
3. Thoroughly vacuum area with a dry vacuum cleaner before deep cleaning.
4. Plan your cleaning route to leave an exit path. It is best to begin cleaning in the corner farthest from your exit.
5. Pretreating (optional)

Note: Pretreating is recommended to improve cleaning effectiveness for heavily soiled carpet in high traffic areas such as entryways and hallways.

- A. Spray the BISSELL Tough Stain Pre-treat formula onto heavy traffic areas, soiled areas, or stains.
- B. Allow to penetrate for at least 3 minutes.
- C. Following the instructions below, clean as normal, using the BISSELL ProHeat machine on the High Traffic Setting.

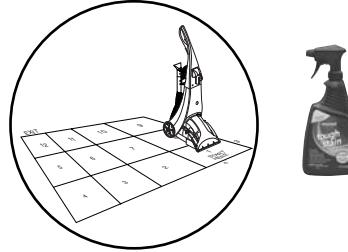

ATTENTION:

Some Berber carpets have a tendency to fuzz with wear. Repeated strokes in the same area with an ordinary vacuum or deep cleaner may aggravate this condition. Please see Stain Removal instructions on page 15.

Carpet Cleaning

Fill The Water Tank

1. Release the handle and lay the machine handle back to access the Tank.
2. Remove the Tank from the base of the machine by lifting the Tank carry Handle.
3. Carry like a bucket to the sink. Rotate the Handle forward to unlatch the lid. Lift off and set the lid aside.
4. Fill up the Bladder with clean hot tap water.
***Do not boil or microwave water as it can destroy the Bladder.**
5. Replace the top of the Tank by matching the lid and tank edges. Handle must be in the forward position in order to replace lid. Rotate the handle to the carrying position to latch the lid.
Note: Remember to secure the lid and test to make sure it is secure before picking up the Tank.
6. Place tank into machine base, seating firmly in place. Rotate tank handle back into latched position. Bring machine handle back into upright position.

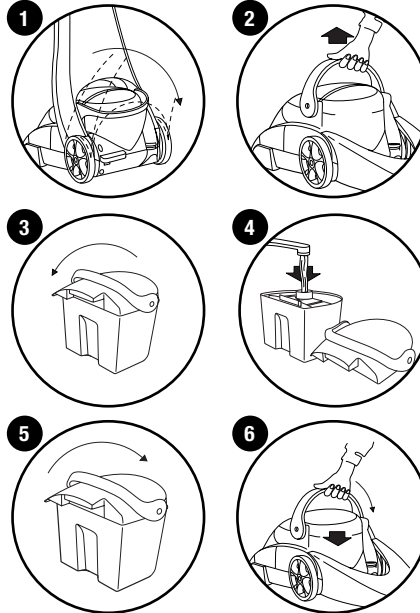

Fill The SmartMix/Formula Tank

1. Lift the formula Tank up and out of the machine base.
2. To fill the Formula Tank, first unscrew the Cap and Insert. Always use genuine BISSELL formulas to maximize cleaning and for the safety of your machine. Fill formula up to the line and replace the Cap and Insert. Place Formula Tank back into the base of machine, making sure it is seated securely.
Note: If bottle leaks, check for proper positioning of red grommet and straw.

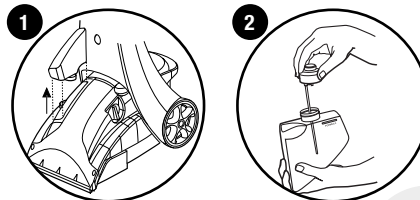

Choose The SmartMix Setting

Simply choose one of the 3 settings

- High Traffic
- Normal
- Water Rinse/Carpet Protector

and the ProHeat will adjust the right amount of cleaning solution to mix with the heated water to fit your cleaning need.

NOTE: When your cleaning job is finished, the formula can be stored ready to use in your machine for the next time!

Set Ready Tools Dial

Set Ready Tools Dial to the Floor Cleaning Setting.

Power Switch

1. Plug into a proper outlet and turn the Power and Heater switches to the **ON (I)** position. The switches are found on the back of the handle. Allow 1 minute for the built-in heater to warm-up before cleaning. The ProHeat will be fully warmed and will provide optimal performance after a minute of continuous heated cleaning.
2. The SmartTemp ready light indicates when the heater is **ON (I)**.
Note: SmartTemp heats the cleaning solution for carpet and bare floor application only. It does not heat solution sprayed through the accessory tools.

Cleaning strokes

1. While pressing the Trigger, make one slow forward wet pass and another one back. Let the Built-In Heater, formula, and DirtLifter PowerBrush do the work for you. **Caution: Do not overwet.** Take care not to run over loose objects or edges of area rugs. Stalling brush may result in premature belt failure.
2. Release the Trigger and make one slow forward and backward pass over the same area to remove any residual dirty water, and aid in drying. Repeat cleaning passes until solution being pulled up appears clean. Continue passes without pressing the trigger until you can't see any more water being pulled up.
NOTE: Both the SmartMix tank and the clean water tank must have liquid in them in order for the machine to spray. If one tank is empty the machine will not apply cleaning solution or water.
3. After cleaning, you may want to turn the SmartMix dial to Rinse to give your carpeting a final water only rinse. This will ensure thorough removal of embedded dirt loosened by the deep cleaning formula. BISSELL deep cleaning formulas contain an anti-resoiling agent that helps your carpets repel dirt and keeps them looking good longer.



WARNING:

To Reduce the Risk of Fire and Electric Shock due to internal component damage, use only BISSELL cleaning fluids intended for use with the deep cleaner.

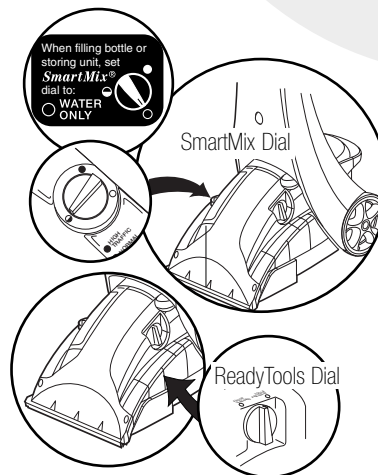

Tip:

Deep Cleaning stairs and high traffic areas on a regular basis can prolong carpet life.

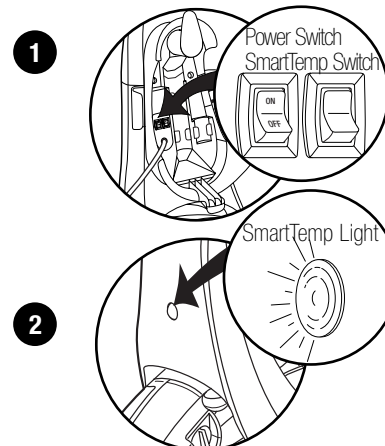

WARNING:

To reduce the risk of fire, electric shock or injury, unplug from the outlet before servicing.

Empty The Tank

1. Remove the Water Tank from the base using the Tank Carry Handle. Carry the Tank like a bucket to a utility sink or outside where you will dispose of the collection water. Remove the top of the Tank by rotating the handle forward to unlatch lid and lifting lid off tank.
2. Empty collection water from bottom of tank.
NOTE: You may notice hair & debris deposits on the carpet or in the Tank that were loosened by the cleaning action (especially with newer carpets that have never been deep cleaned before). This debris should be picked up and thrown away.
3. After each use, remove and rinse the lint screen located on the Tank lid.
4. Refill the Tank in tank by referencing "Fill the Water Tank" on page 9. Remember to secure the top of the Tank by rotating the handle and test to make sure it is secure before picking up.
5. Return Tank-in-Tank to the machine.
NOTE: Always check the level of cleaning formula in the SmartMix Tank at the same time, and refill as needed.

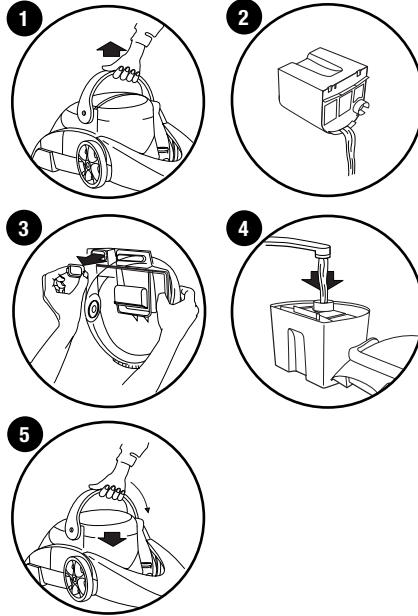

Rinse (Optional)

Rinsing is an optional step that can be done during the cleaning process by switching to the Water Rinse setting, or it can be done after the carpeted area has been cleaned.

1. Simply choose the Water Rinse setting on the SmartMix Dial, and follow the same path as you did for cleaning, taking care to do a forward (wet) stroke by depressing the trigger, a backward (wet) stroke, and a forward and backward (dry) stroke, releasing the trigger. Continue this until the water you see coming up the nozzle is clear.



After Cleaning

Machine Storage

Once your cleaning is complete, make sure the Water Tank is emptied and rinsed out. Put the unit away in a closet or basement for the next use. The SmartMix Tank can remain filled and ready to go (store with machine set to Water Rinse setting), or it can simply be emptied back into the formula bottle if that is more convenient.

Note: Store cleaner in a protected, dry area. Since this product uses water, it must not be stored where there is a danger of freezing. Freezing will damage internal components and void the warranty.

! WARNING:
To reduce the risk of fire, electric shock or injury, unplug from the outlet before servicing.

After Cleaning (Continued)

Machine Care

For best results, a few simple steps can assure your machine is well maintained after your cleaning is complete.

1. Turn Power and Heater switches OFF (0). Unplug the machine and wrap the power cord.
2. After emptying the Water Tank, rinse it out at a faucet with running hot tap water, taking care to clean underneath the Heavy Duty Bladder, and all around it. Clean out lint trap.
3. Replace the Tank in tank on the machine.
4. Clean out the flow indicator filter each time it is used to ensure best cleaning performance. Unscrew the Flow indicator cap, lift out the red rotor and white filter. Rinse all three parts with water. Replace the filter and rotor. Replace the Flow indicator cap. Turn until snug, do not over-tighten.
5. Any loose hair or debris can be pulled from the brush roll if desired and thrown away.
6. Wipe the machine's exterior with a soft cloth.
7. After carpet is dry, vacuum again to remove hair and fuzz.

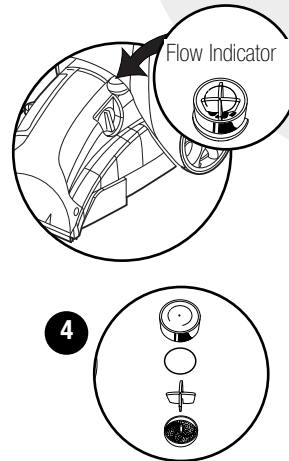

Post-Treatment Scotchgard Protector* (Optional) (*Available on select models)

Some ProHeat models are equipped with a Scotchgard Protector post treatment applicator and cartridge. Using this, along with one of the BISSELL cleaning formulas containing Scotchgard, helps to retain the carpet cleanliness achieved with the ProHeat machine. For best results, the post cleaning treatment should be applied while the carpet is still damp. It is recommended that the Scotchgard protector be applied every 12 months to all clean carpeted areas, and after every deep cleaning for high traffic areas such as entry ways and stairs.

1. Immediately after cleaning and rinsing your carpets, empty the Water Tank and refill the Heavy Duty Bladder with clean, hot tap water.
2. Set the Ready Tools dial to the Tools/Pretreat setting. This will allow spray from the hose.
3. Purge the hose to eliminate cleaning solution from the tube by spraying clean water through the hose without attachments into a sink for 15-30 seconds.
4. Attach Scotchgard post-applicator cartridge to the Applicator Tool, following the instructions on the cartridge. Attach the combined Tool/Cartridge to the hose. The water from the Tank in Tank will automatically mix with the concentrated Scotchgard post-treatment formula contained in the cartridge.
5. Turn the SmartMix Dial to the **Water Rinse/Carpet Protector** setting.

Tip:

If clogged, soak applicator tool in hot tap water before using.

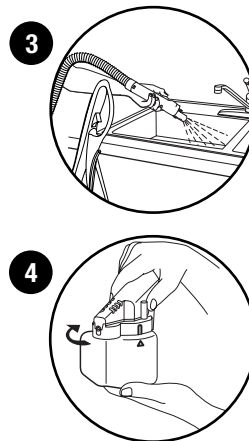

Post-Treatment Scotchgard Protector* (Optional) (Continued)

6. Before applying Scotchgard protector to a large area, test in a small, hidden area for colorfastness. Examine area when dry. If color is affected, do not use. For use on upholstery, look for manufacturer's cleanability code tag. Use only on fabrics coded "W" or "WS". If coded "S" or "X", do not use. Not recommended for use on velvet, silk vinyl, leather, or 100% cotton upholstery.
7. Apply Scotchgard protector in a slow sweeping motion with a slight overlap of the treated area. For best coverage, follow the guide on the cartridge.
8. One 8 oz. cartridge protects 200 square feet (18.6 sq. meters). This is equal to two average size rooms, (each at 10 x 10 ft. or 3 x 3 meters). Periodically check the product level in the bottle to ensure the best coverage.
9. Be careful not to spray the protector onto furniture or fabric that has not been tested for colorfastness. If this does occur, wipe off the protector.
10. When finished remove the bottle from the spraying applicator tool. If concentrate is left, replace the cap to the cartridge and store at room temperature for later use.
11. With the applicator tool still on the end of the hose, spray clean hot water into the sink to avoid any future clogging.
12. Store tool in a convenient location for use the next time.

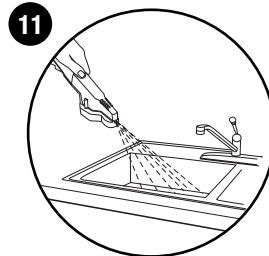
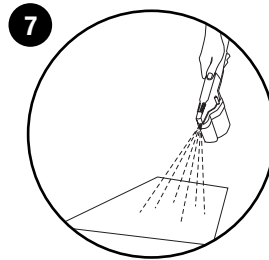

Cleaning with Attachments

Your ProHeat machine comes equipped with a hose and at least one attachment for cleaning stairs, upholstery, and more.

1. **Important! If using to clean Upholstery, check Upholstery Tags.**
 - A. Check manufacturer's tag before cleaning. "W" or "WS" on the tag means you can use your ProHeat. If the tag is coded with an "X" or an "S" (with a diagonal stripe through it), or says "Dry Clean Only", do not proceed with any deep cleaning machine. Do not use on Velvet or Silk. If manufacturer's tag is missing or not coded, check with your furniture dealer.
 - B. Check for colorfastness in an inconspicuous place.
 - C. If possible, check upholstery stuffing. Colored stuffing may bleed through fabric when wet.
 - D. Plan activities to allow upholstery time to dry.
 - E. Vacuum thoroughly to pick up loose debris and pet hair. Use a vacuum with a brush attachment and a crevice tool to clean in fabric folds.
2. Follow the instructions on page 9 for filling the Water Tank and the Formula Tank.

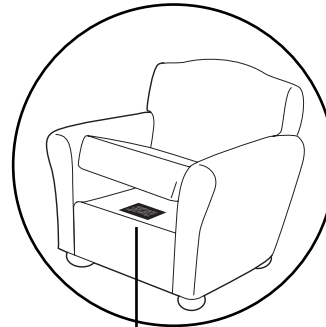

Manufacturer's tag

WARNING:
To reduce the risk of injury, be extra careful when cleaning stairs. Make sure machine is secure and level.

Cleaning with Attachments (Continued)

3. Set Ready Tools Dial to the Tools/Pretreat Setting. This will allow spray and divert the suction to the hose.
***SmartTemp heats the cleaning solution for carpet and bare floor application only. It does not heat solution sprayed through the accessory tools.**
4. Set SmartMix Dial to Normal.
5. Attach the cleaning tool to the end of the hose.
6. Plug in and turn on the Power Switch.
7. Clean by pressing the trigger to spray solution onto the area to be cleaned. Slowly move the tool back and forth over the soiled surface. Release the trigger to suction soiled water. Continue to clean in the area, working in small sections, until no more dirt can be removed. Rinse (optional) and suction as needed. Caution: Do no overwet.
8. When cleaning is complete, remove and rinse tools in clean, running water.
9. Coil hose around the Tool Caddy.
10. Empty Water Tank and rinse out, following the instructions on page 11.
11. Return Ready Tools Dial to Floor Cleaning.

Tip:

Deep cleaning carpeting and upholstery with BISSELL Multi-Allergen Removal Formula™ with Scotchgard™ protector regularly can reduce dust and allergens in your home.

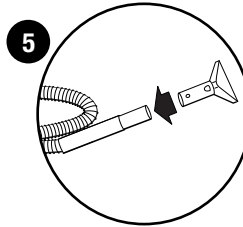

Cleaning Fluid Section

Keep plenty of genuine BISSELL Fiber Cleansing Formula™ and Scotchgard™ protector cartridges on hand so you can clean and protect whenever it fits your schedule. Always use genuine BISSELL deep cleaning formulas.



WARNING:

To Reduce the Risk of Fire and Electric Shock due to internal component damage, use only BISSELL cleaning fluids intended for use with the deep cleaner. Non-BISSELL cleaning solutions may harm the machine and void the warranty.



48 oz. BISSELL Fiber Cleansing Formula™ with Scotchgard™ Protector
item # 0710



48 oz. BISSELL Multi-Allergen Removal™ Formula with Scotchgard™ Protector
item # 0720



48 oz. BISSELL Pet Odor and Soil Removal™ Formula with Scotchgard™ Protector
item # 0730



48 oz. BISSELL Natural Orange Extract Formula with Scotchgard™ Protector
item # 0740

Stain Removal

Do Not Delay! Attending to an accident soon after it occurs ensures the chances for full removal. Leaving it for an extended period of time may cause it to set and become permanent.

1. Blot up liquids with an absorbent cloth or paper towels. White materials are recommended because certain dyes may bleed and make the stain worse.
2. Gently scrape up any semi-solids with a spoon or spatula. Do not use a knife or other utensil with sharp edges because it could damage the carpet or upholstery.
3. If the area has dried, remove the remaining semi-solids and residue with a sweeper or vacuum.
4. Be sure to test any spot removal formulas in an inconspicuous area first. This is important as some dyes and materials could be damaged or discolored by cleaning solvents. If such a change should occur, try a different solution or call a professional.
5. If cleaning on Berber carpeting, gently run your machine over a hidden area. If no fuzzing occurs, continue cleaning in soiled area.
6. Using the BISSELL Tough Stain PreCleaner, spray evenly over soiled area. Do not overwet. Wait 3-5 minutes. Gently work the solution by blotting area with a clean, damp, color safe cloth.
7. Clean using either the Floor Cleaning, or Tools/ Pretreat Setting on the Ready Tools Dial.



Bare Floor Cleaning

Your ProHeat model may have come with a Bare Floor attachment and Hard Floor Solutions Formula. If not, these products are available for purchase by contacting the BISSELL Consumer Services department by phone or on the website. The Bare Floor tool provides effective cleaning for linoleum, vinyl, and tile floors. Caution: Do not use on hardwood floors.

1. Vacuum or Sweep thoroughly to pick up any loose debris and pet hair.
2. Move any furniture, if needed.
3. Empty any carpet cleaning formula back into the BISSELL bottle if stored in the Formula Tank. Fill Formula Tank with BISSELL Hard Floor Solutions, available at many retailers, or contact BISSELL Consumer Services.



Bare Floor Cleaning (Continued)

4. Fill the Water Tank with Hot Tap Water and Set Aside.
5. Attach the Bare Floor Tool onto the Floor Nozzle with the long tab to the right side of the Floor Nozzle. First attach left side (short tab) catching tab over nozzle edge. Gently bend long Tab (right side) outward to easily snap over edge of clear nozzle on left.
6. Set the Ready Tools Dial to Floor Cleaning.
7. Set the SmartMix Dial to Normal Clean.
8. Plug into an outlet and turn the Power Switch and Heater ON (I).
9. Slowly move the machine forward and back over bare floor surface one time while pressing trigger.
Caution: Do not overwet.
10. Repeat the motion without pressing the trigger. This allows the Bare Floor tool to squeegee and suction up the dirty water.
11. Allow approximately 30 minutes for floors to dry.
12. Remove Bare Floor tool and rinse and dry before storing.
13. If any formula remains in the Formula Tank, pour it back into the Hard Floor Solutions bottle for use the next time.
14. Rinse out the Formula Tank.

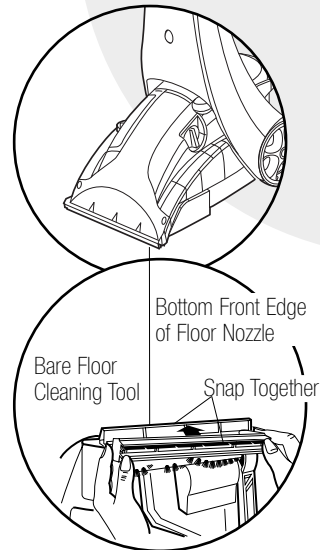

WARNING:
To reduce the risk of fire, electric shock or injury unplug from outlet before servicing.

Troubleshooting / User Maintenance

SmartTemp Ready Light does not illuminate.

Possible Causes

1. The SmartTemp Switch is not turned ON (I).
2. The machine Power Switch is not turned ON (I).

Remedies

1. Turn ON (I) the SmartTemp Switch.
2. Both switches must be ON (I) to activate the SmartTemp Ready Light.

Reduced spray or no spray.

Possible Cause

1. Bladder may be empty.
2. SmartMix Tank may be empty.
3. The filter may be clogged.
4. Tanks may not be seated properly.
5. Pump may have lost prime.

Remedies

1. Refill Bladder with hot tap water.
2. Fill with BISSELL Fiber Cleansing Formula for cleaning. Fill with water if rinsing or using the Scotchgard applicator.
3. Clean out Flow Indicator Filter, page 12.
4. Turn power OFF (O); remove & reseal tanks.
5. Turn power OFF (O); after 1 minute turn ON and press Trigger.

Troubleshooting / User Maintenance (Continued)

Reduced spray or no spray. (Continued)

Possible Cause

6. The Pump Belt may be broken.

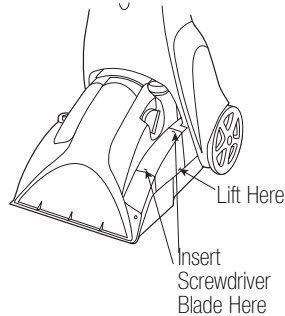

Remedies

6. Turn the machine **OFF (O)** and unplug from the outlet. To check if a Pump Belt has broken, you will need a flat head screwdriver. Insert the blade end into the lower slot of the Belt Access door to release the lower snap. If necessary, insert the blade end into the upper slot to release the upper snap. Examine the belt for breakage. You should be able to see the Pump Belt looped around the motor shaft. If it is broken or missing, please refer to Replacement Parts on page 19 before calling Consumer Services. Complete installation instructions will accompany the replacement belt.

DirtLifter PowerBrush does not turn.

Possible Cause

1. The Brush Belt or Pump Belt is off or broken.

Remedies

1. Turn the machine **OFF (O)** and unplug from the outlet. To check if the Brush Belt or Pump Belt has broken, you will need a flat head screwdriver. Insert the blade end into the lower slot of the Belt Access door to release the lower snap. If necessary, insert the blade end into the upper slot to release the upper snap. Examine the belt for breakage. If broken, please refer to Replacement Parts on page 19 before calling Consumer Services. Complete installation instructions will accompany the replacement belt.

Carpet Protector is not spraying. (Select Models Only)

Possible Cause

1. Cartridge not connected to the tool.
2. Solution clogging the Spray Trigger.
3. Applicator tool spray is blocked.

Remedies

1. Follow instructions on cartridge assuring proper fit.
2. Soak applicator tool in hot water. Spray without the cartridge attached to purge any residual Solution left in the tool.
3. Soak applicator tool in hot water. Spray without the cartridge attached to purge any residual Solution left in the tool.

Troubleshooting / User Maintenance (Continued)

Cleaner not picking up solution.

Possible Causes

1. Ready Tools dial may be on the wrong setting for the cleaning job.
2. Nozzle Window may not be properly attached.
3. Tank-in-Tank lid is not properly installed.
4. Tank-in-Tank is not properly seated.
5. Poor tool position.
(Hand held attachments only).
6. Tank-in-Tank has picked up maximum dirty water.

Remedies

1. Set ReadyTools dial to either or Tools/PreTreat Floor Cleaning.
2. Press down firmly on the black oval gasket at the top window to make sure the two tabs on the back of the Nozzle Window are snapped into the mating slots in the main housing.
3. Re-install lid; refer to page 9.
4. Tank-In-Tank must be firmly seated to function; remove and reseal Tank-in-Tank.
5. Adjust angle; apply more downward pressure.
6. Empty Tank-in-Tank, refer to page 11.

Other Maintenance or Service not included above should be performed by an authorized service representative.

Thank you for selecting a BISSELL product.

If you should happen to need assistance during assembly or operations, call 1-800-237-7691

Please do not return this product to the store

BISSELL Consumer Services

For information about repairs or replacement parts, or questions about your warranty, call:

BISSELL Consumer Services
1-800-237-7691

Monday - Friday 8 a.m. — 10 p.m. EST
Saturday 9 a.m. — 8 p.m. EST

Or write:
BISSELL HOMECARE, INC
PO Box 3606
Grand Rapids MI 49501
ATTN: Consumer Services

Or visit the BISSELL website - **www.bissell.com**

When contacting BISSELL, have model number of unit available.

Please record your Model Number: _____

Please record your Purchase Date: _____

NOTE: Please keep your original sales receipt. It provides proof of date of purchase in the event of a warranty claim. See "About Your Warranty" on page 20 for details.



Replacement parts - BISSELL ProHeat

Below a list of common replacement parts*. While not all of these parts may have come with your specific machine, all are available to you for purchase, if desired.

Item	Part No.	Part Name
1	210-9201	4" Small Area Tool
2	203-6655	Spraying Crevice Tool
3	203-6652	TurboBrush®
4	214-9131	Bare Floor Tool
5	214-9142	PreTreat Wand
6	215-9155	Tough Stain Brush
7	015-9043	Tank Assembly Complete (Includes lid assembly)
8	015-4439	Tank Lid Assembly
9	015-9041	Tank Bottom
10	210-1785	SmartMix® Tank (Includes Cap)
11	210-1795	SmartMix® Cap Assembly
12	555-6503	Flow Indicator Cap Assembly
13	214-9871	Floor Nozzle Window and Gasket
14	210-4052	Window Gasket
15	215-0628	Replacement Pump Belt (With Instructions)
16	015-0621	Replacement Belt Brush (With Instructions)
17	213-3501	Lint Screen
18	0710	Fiber Cleansing Formula™ 48 oz
19	0720	Multi-Allergen Removal™ Formula 48 oz
20	0730	Pet Odor and Soil Removal™ Formula 48 oz
21	0484	Hard Floor Solutions™ 32 oz
22	0400	Tough Stain PreCleaner™ 22 oz
23	203-6691	Scotchgard Applicator Tool
24	0464	Scotchgard protector Post Treatment Cartridge

*Not all parts are included with every model.

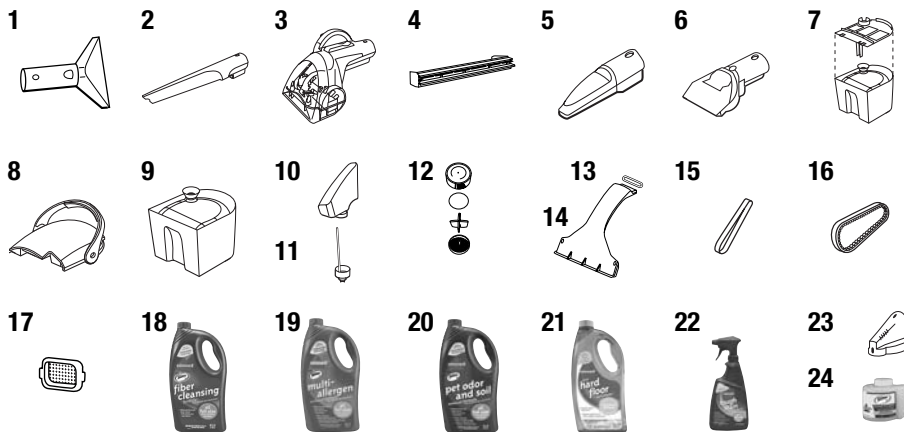

Warranty - BISSELL ProHeat

This warranty gives you specific legal rights, and you may also have other rights which may vary from state to state. If you need additional instruction regarding this warranty or have questions regarding what it may cover, please contact BISSELL Consumer Services by E-mail, telephone, or regular mail as described below.

Limited One Year Warranty

Subject to the ***EXCEPTIONS AND EXCLUSIONS** identified below, upon receipt of the product BISSELL Homecare, Inc. will repair or replace (with new or remanufactured components or products), at BISSELL's option, free of charge from the date of purchase by the original purchaser, for one year any defective or malfunctioning part.

See information below on "If your BISSELL product should require service".

This warranty applies to product used for personal, and not commercial or rental service. This warranty does not apply to fans or routine maintenance components such as filters, belts, or brushes. Damage or malfunction caused by negligence, abuse, neglect, unauthorized repair, or any other use not in accordance with the User's Guide is not covered.

If your BISSELL product should require service:

Contact BISSELL Consumer Services to locate a BISSELL Authorized Service Center in your area.

If you need information about repairs or replacement parts, or if you have questions about your warranty, contact BISSELL Consumer Services.

Website or E-mail:

www.bissell.com

Use the "Customer Services" tab.

Or Call:

BISSELL Consumer Services

1-800-237-7691

Monday - Friday 8 a.m. - 10 p.m. ET

Saturday 9 a.m. - 8 p.m. ET

Or write:

BISSELL Homecare Inc.

PO Box 3606

Grand Rapids MI 49501

ATTN: Consumer Services

BISSELL HOMECARE, INC. IS NOT LIABLE FOR INCIDENTAL OR CONSEQUENTIAL DAMAGES OF ANY NATURE ASSOCIATED WITH THE USE OF THIS PRODUCT. BISSELL'S LIABILITY WILL NOT EXCEED THE PURCHASE PRICE OF THE PRODUCT.

Some states do not allow the exclusion or limitation of incidental or consequential damages, so the above limitation or exclusion may not apply to you.

***EXCEPTIONS AND EXCLUSIONS FROM THE TERMS OF THE LIMITED WARRANTY**

THIS WARRANTY IS EXCLUSIVE AND IN LIEU OF ANY OTHER WARRANTIES EITHER ORAL OR WRITTEN. ANY IMPLIED WARRANTIES WHICH MAY ARISE BY OPERATION OF LAW, INCLUDING THE IMPLIED WARRANTIES OF MERCHANTABILITY AND FITNESS FOR A PARTICULAR PURPOSE, ARE LIMITED TO THE ONE YEAR DURATION FROM THE DATE OF PURCHASE AS DESCRIBED ABOVE.



©2006 BISSELL Homecare, Inc.
Grand Rapids, Michigan
All rights reserved. Printed in China
Part Number 310-5876
Rev 02/06
Visit our website at:
www.bissell.com

Scotchgard is a trademark of 3M



Free Manuals Download Website

<http://myh66.com>

<http://usermanuals.us>

<http://www.somanuals.com>

<http://www.4manuals.cc>

<http://www.manual-lib.com>

<http://www.404manual.com>

<http://www.luxmanual.com>

<http://aubethermostatmanual.com>

Golf course search by state

<http://golfingnear.com>

Email search by domain

<http://emailbydomain.com>

Auto manuals search

<http://auto.somanuals.com>

TV manuals search

<http://tv.somanuals.com>