

2 OPTIONAL ACCESSORIES

SHREDDER KIT

P/N 890209. *Shreds leaves, dramatically reducing total volume.*

HOSE KITS

For vacuuming in hard to reach areas.

Heavy Duty Vacuum Hose Kit P/N 900943.

4"(102mm) x 10' (3.05m)

Homeowners Vacuum Hose Kit P/N 900942.

4"(102mm) x 10' (3.05m)

NOZZLE WEAR PLATES

P/N 900810. *Extends nozzle life when used along curbs and hard surfaces.*

STANDARD QUICK DEBRIS BAG

P/N 890305. *Standard on KD models. For dusty conditions.*

OPTIONAL DEBRIS BAGS

TURF QUICK DEBRIS BAG

P/N 890307 *For use in leaves and grass in non-dusty conditions.*

DEBRIS BAG COVER

P/N 900801 *Directs dust downward, away from operator.*

ZIPPERLESS BAG QUICK

P/N 890309 *For non dusty conditions that are damaging to zippers.*

1

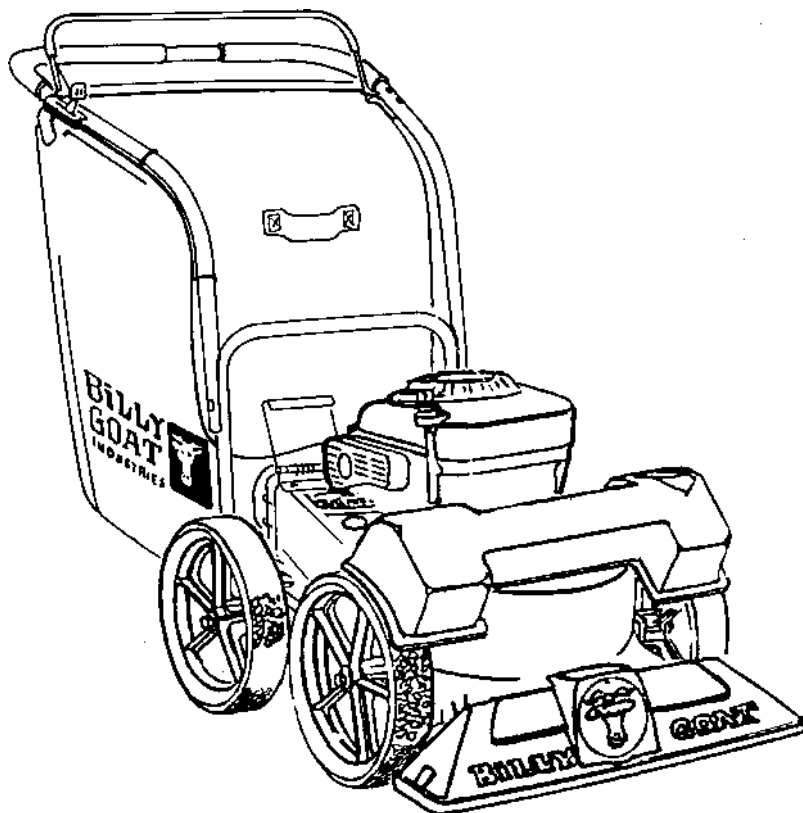

Thank You for Selecting
The Powerful KD SELF-PROPELLED VACUUM

Operator Owner's Manual

KD505SPQ

3

Specifications

	KD505SPQ
ENGINE: H.P.	5 (3.73 kW)
ENGINE: TYPE	B&S QUANTUM
ENGINE: FUEL CAP.	1.5 qt. (1.4 L)
ENGINE: OIL CAP.	0.63 qt. (0.6 L)
WEIGHT: UNIT	117# (53.1 kg)
WEIGHT: SHIPPING	140# (63.5 kg)
ENGINE WEIGHT:	25.25# (11.45 kg)

5



IN THE INTEREST OF SAFETY

BEFORE STARTING ENGINE, READ AND UNDERSTAND THE "ENTIRE OPERATOR'S MANUAL & ENGINE MANUAL."

THIS SYMBOL MEANS WARNING OR CAUTION. DEATH, PERSONAL INJURY AND/OR PROPERTY DAMAGE MAY OCCUR UNLESS INSTRUCTIONS ARE FOLLOWED CAREFULLY.



WARNING: The Engine Exhaust from this product contains chemicals known to the State of California to cause cancer, birth defects or other reproductive harm.

WARNING: DO NOT

1. **DO NOT** run engine in an enclosed area. Exhaust gases contain carbon monoxide, an odorless and deadly poison.

2. **DO NOT** place hands or feet near moving or rotating parts.

3. **DO NOT** store, spill or use gasoline near an open flame, or devices such as a stove, furnace, or water heater which use a pilot light or devices which can create a spark.

4. **DO NOT** refuel indoors where area is not well ventilated. Outdoor refueling is recommended.

5. **DO NOT** fill fuel tank while engine is running. Allow engine to cool for 2 minutes before refueling. Store fuel in approved safety containers.

6. **DO NOT** remove fuel tank cap while engine is running.

7. **DO NOT** operate engine when smell of gasoline is present or other explosive conditions exist.

8. **DO NOT** operate engine if gasoline is spilled. Move machine away from the spill and avoid creating any ignition until the gasoline has evaporated.

9. **DO NOT** transport unit with fuel in tank.

10. **DO NOT** smoke when filling fuel tank.

11. **DO NOT** choke carburetor to stop engine. Whenever possible, gradually reduce engine speed before stopping.

12. **DO NOT** run engine at excessive speeds. This may result in injury & /or damage to unit.

13. **DO NOT** tamper with governor springs, governor links or other parts which may change the governed engine speed.

14. **DO NOT** tamper with the engine speed selected by the engine manufacturer.

15. **DO NOT** check for spark with spark plug or spark plug wire removed. Use an approved tester.

16. **DO NOT** crank engine with spark plug removed. If engine is flooded, place throttle in "FAST" position and crank until engine starts.

17. **DO NOT** strike flywheel with a hard object or metal tool as this may cause flywheel to shatter in operation. Use proper tools to service engine.

18. **DO NOT** operate engine without a muffler. Inspect periodically and replace, if necessary. If engine is equipped with muffler deflector, inspect periodically and replace, if necessary, with correct deflector.

19. **DO NOT** operate engine with an accumulation of grass, leaves, dirt or other combustible material in the muffler area.

20. **DO NOT** use this engine on any forest covered, brush covered, or grass covered unimproved land unless a spark arrester is installed on the muffler. The arrester must be maintained in effective working order by the operator. In the State of California the above is required by law (Section 4442 of the California Public Resources Code). Other states may have similar laws. Federal laws apply on federal lands.

21. **DO NOT** touch hot muffler, cylinder, or fins because contact may cause burns.

22. **DO NOT** run engine without air cleaner or air cleaner cover.

23. **DO NOT** operate during excessive vibration!

24. **DO NOT** leave machine unattended while in operation.

25. **DO NOT** park machine on a steep grade or slope.

WARNING: DO



1. **ALWAYS DO** remove the wire from the spark plug when servicing the engine or equipment TO PREVENT ACCIDENTAL STARTING.

2. **DO** keep cylinder fins and governor parts free of grass and other debris which can affect engine speed.

3. **DO** pull starter cord slowly until resistance is felt. Then pull cord rapidly to avoid kickback and prevent hand or arm injury.

4. **DO** examine muffler periodically to be sure it is functioning effectively. A worn or leaking muffler should be repaired or replaced as necessary.

5. **DO** use fresh gasoline. Stale fuel can gum carburetor and cause leakage.

6. **DO** check fuel lines and fittings frequently for cracks or leaks. Replace if necessary

7. **Follow** engine manufacturer operating and maintenance instructions.

8. **Inspect** machine and work area before starting unit.

6 TABLE OF CONTENTS

SAFETY INSTRUCTIONS	2
GENERAL SAFETY	3
ASSEMBLY	3
PARTS BAG & CONTROLS	4
LABELS	4
OPERATION	5 - 7
MAINTENANCE	8 - 9
PARTS DRAWING & LIST	10 - 12
TROUBLESHOOTING	12
WARRANTY PROCEDURE	12

Part No. 890311

7

SOUND

SOUND TESTS

€ L_{WA}
95

Sound tests conducted were in accordance with 79/113/EEC and were performed on 05/19/95 under the conditions listed:

GENERAL CONDI- Sunny
TION:

3 L_{pA}
108

TEMPERATURE: 62°F (16.7°C)

WIND SPEED: 5 MPH (8.0 kmh)

WIND DIRECTION: South

HUMIDITY: 67%

OPERATOR

BAROMETRIC PRESSURE: 30.06" Hg (763mm Hg)

8

VIBRATION

VIBRATION LEVEL 1.1g

Vibration levels at the operators handles were measured in the vertical, lateral, and longitudinal directions using calibrated vibration test equipment. Tests were performed on 05/23/95 under the conditions listed:

GENERAL CONDI- Cloudy
TION:

TEMPERATURE: 66°F (18.9°C)

WIND SPEED: 9 MPH (14.5 kmh)

WIND DIRECTION: N.E.

HUMIDITY: 97%

BAROMETRIC PRESSURE: 29.7" Hg (754mm Hg)

Page 2 of 12

Form No. F010396C

GENERAL SAFETY

For your safety and the safety of others, these directions should be followed:

 Do not operate this machine without first reading owner's manual and engine manufacturer's manual.

 Use of Ear Protection is recommended while operating this machine.

 Use of Eye and Breathing protection is recommended when using this machine, especially in dry and dusty conditions. Optional bag cover directs dust toward ground, away from the operator.

•DO NOT place hands or feet inside nozzle intake opening, near debris outlet or near any moving parts.

•DO NOT start engine without debris bag and quick disconnect connected firmly in place to exhaust outlet.

•DO NOT start or operate machine with debris bag zipper open.

•DO NOT operate during excessive vibration.

•DO NOT remove bag until engine has been turned off and has come to a complete stop.

•DO NOT remove hose kit cap on nozzle until engine has been turned off and has come to a complete stop.

•DO NOT operate machine with hose cap, bag or hose removed.

•DO NOT use this machine for vacuuming **exclusively** sand, dust, fine dirt, rock, glass, string like material, grain, rags, cans, metal, bark or water.

•DO NOT operate this machine on slopes greater than 20%.

•DO NOT pick up any hot or burning debris, or any toxic or explosive material.

•DO NOT allow children to operate this equipment.

ASSEMBLY



Read all safety and operating instructions before assembling or starting this unit.



PUT OIL IN ENGINE BEFORE STARTING.

Your Billy Goat is shipped from the factory in one carton, completely assembled except for the upper handle, debris bag, and bag quick disconnect.

1. **ASSEMBLE** Lift upper handle (item 6) and remove items 8, 19, 30, & 46 from lower handle (item 27). Attach upper and lower handles as shown, and securely tighten folding handle knobs (item 46), while holding head of screw (item 8) firmly against upper handle.

2. **UNFOLD** the debris bag (item 1) and fasten bag neck to bag quick disconnect (item 83). Attach firmly to housing exhaust (item 52) see fig. 2.

3. **ATTACH** bag hanger strap to bag supports (item 11), preassembled to upper handle.

4. **CONNECT** spark plug wire.

PACKING CHECKLIST

These items should be included in your carton. If any of these parts are missing, contact your dealer.

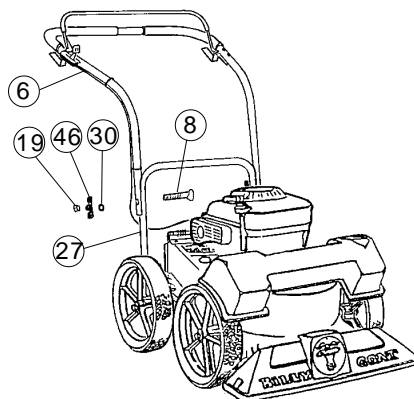
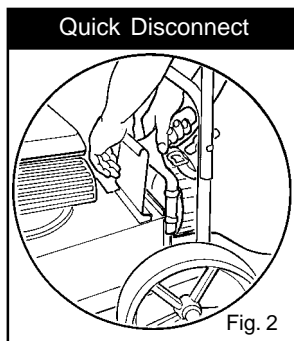
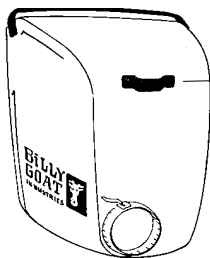

Literature Assy

Engine Manual

Check Debris Bag
890304

Check Connector
Quick
Disconnect
890176

Per Model

Check Literature Assy
890320

Check Briggs & Stratton
P/N MS9984 Multi-Lang.

	Literature Checklist
Owner's Manual	<input type="checkbox"/> Check Owner's Manual 890311
Literature KD/TKD Accessories	<input type="checkbox"/> Check Literature KD/TKD Accessories 890317
Warranty Card	<input type="checkbox"/> Check Warranty Card 400972
EU Declaration of Conformity & EU Distributor List	<input type="checkbox"/> Check EU Declaration of Conformity & EU Distributor List 890266

Throttle Control

Start position

Briggs engines have a primer button carburetor rather than choke type carburetor.



Stop position

These labels should be included on your Vacuum. If any of these labels are damaged, replace them before putting this equipment into operation. Item and part numbers are given to help in ordering replacement labels..



Label Do Not Fill While Engine Is Hot
Item 63 Part No.400268

Label Danger Keep Hands and Feet Away
Item 29 Part No.400424



Label Read Owner's Manual Item No. 123
Part No. 890301



Label Danger Flying Material Item 62
Part No.810736



Label Warning Guards
Item 100 Part No.900327



Label Ear Eye Breathing
Item No. 37 Part No. 890254



Label Clutch Item No. 99
Part No. 830503



Label Oil Chain
Item No. 45
Part No. 830502

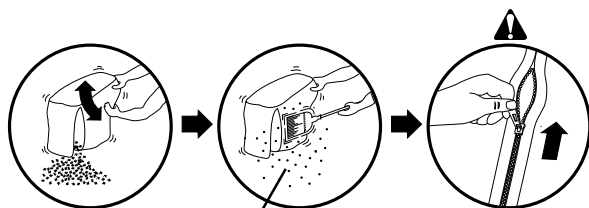

Debris Bag
Label item 1

Briggs & Stratton



INTENDED USE: This machine is designed for vacuuming leaves, grass clippings and other types of organic litter. Debris mixed with cans, bottles and small amounts of sand can be vacuumed; however, it is not this machine's primary purpose. Vacuuming cans, bottles and sand will affect the longevity of your machine.

Do not operate if excessive vibration occurs. If excessive vibration occurs, shut engine off immediately and check for damaged or worn impeller, loose impeller bolt, loose impeller key, loose engine or lodged foreign objects. Note: See parts list for proper impeller bolt torque specifications. (See trouble shooting section on page 12).



Like all mechanical tools, reasonable care must be used when operating machine.

Inspect machine work area and machine before operating. Make sure that all operators of this equipment are trained in general machine use and safety.



PUT OIL IN ENGINE BEFORE STARTING.

16.1 STARTING



ENGINE: See engine manufacturer's instructions for type and amount of oil and gasoline used. Engine must be level when checking and filling oil and gasoline.

ENGINE SPEED: Controlled by throttle lever on the handle. Under normal conditions, operate at minimum throttle to accomplish your current cleaning task.

FUEL VALVE: Move fuel valve to "ON" position (when provided on engine).

CHOKE: See Primer.

PRIMER: Push primer per engine instructions.

THROTTLE: Move remote throttle control to fast position. Pull starting rope to start engine.

IF YOUR UNIT FAILS TO START:
See Troubleshooting on page 12.

16.2 VACUUMING OPERATION

VACUUM NOZZLE HEIGHT ADJUSTMENT: is raised and lowered by lifting slightly upward on handle and pulling height adjustment rod (Item 23) at left side of handle.

FOR MAXIMUM PICKUP: Adjust nozzle close to debris, but without blocking airflow into the nozzle. *NOTE:* Never bury nozzle into debris.



CLEARING A CLOGGED NOZZLE



& EXHAUST: Turn engine off and wait for impeller to stop completely and disconnect spark plug wire. Wearing durable gloves, remove clog. **Danger**, the clog may contain sharp materials. Reconnect spark plug wire.

Debris bags are normal replaceable wear items.

⚠ Note: Frequently empty debris to prevent bag overloading with more weight than you can lift.

An optional bag and dust cover is available for use where debris will be vacuumed in dusty conditions (see **Optional Accessories shown on page 1.**)

DO NOT place bag on or near hot surface, such as engine. Run engine at 1/2 throttle for first 1/2 hour to condition new bag. Your new bag requires a break-in period to condition the pores of the material against premature blockage. The entire bag surface serves as a filter, and must be able to breathe to have good vacuum performance. Be sure engine has come to a complete stop before removing or emptying bag.

This vacuum is designed for picking up trash, organic material and other similar debris (see Safety Warnings page 2-3). However, many vacuums are used where dust is mixed with trash. Your unit can intermittently vacuum in dusty areas. Dust is the greatest cause of lost vacuum performance. However, following these rules will help maintain your machine's ability to vacuum in dusty conditions:

- Run machine at idle to quarter throttle.
- The debris bag must be cleaned more frequently. A vacuum with a clean, pillow soft bag will have good pickup performance. One with a dirty, tight bag will have poor pickup performance. If dirty, empty debris and vigorously shake bag free of dust.
- Machine or pressure-wash debris bag if normal cleaning does not fully clean bag. Bag should be thoroughly dry before use.

Having one or more spare debris bags is a good way to reduce down time while dirty bags are being cleaned.

- DO NOT** leave debris in bag while in storage.

16.6 PROPULSION

This vacuum is self-propelled. To engage the drive, pull operator's bail against operator's handle. The drive is disengaged by releasing the operator's bail.

GROUND SPEED can be varied by applying slight downward pressure to handle during operation (to allow drive wheels partial slippage) or by changing the engine rpm.

For improved control in confined areas, this machine can be freewheel pushed forward or backward by releasing the operator's bail and pushing machine.

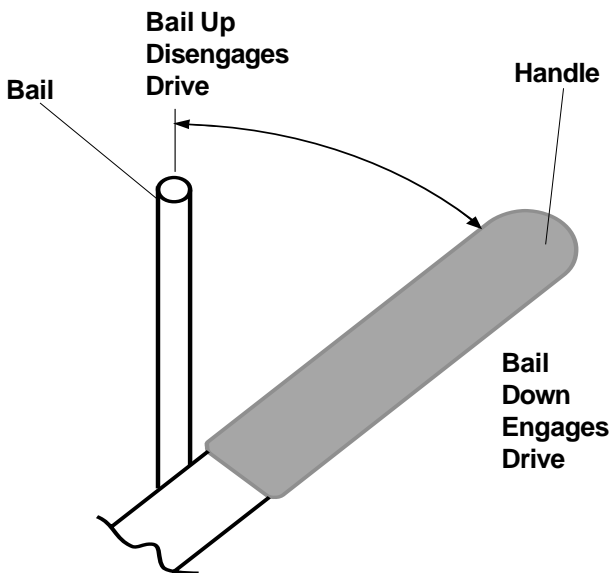
**16.4 HANDLING & TRANSPORTING:**

Using two people to lift machine is recommended. Lift holding the handle and front of nozzle. Secure in place during transport.

16.5 STORAGE

⚠ Never store engine indoors or in enclosed poorly ventilated areas with fuel in tank, where fuel fumes may reach an open flame, spark or pilot light, as on a furnace, water heater, clothes dryer or other gas appliance.

If engine is to be unused for 30 days or more, prepare as follows:

⚠ Be sure engine is cool. Do not smoke. Remove all gasoline from carburetor and fuel tank to prevent gum deposits from forming on these parts and causing possible malfunction of engine. Drain fuel outdoors, into an approved container, away from open flame. Run engine until fuel tank is empty and engine runs out of gasoline.

NOTE: Fuel stabilizer (such as Sta-Bil) is an acceptable alternative in minimizing the formation of fuel gum deposits during storage. Add stabilizer to gasoline in fuel tank or storage container. Always follow mix ratio found on stabilizer container. Run engine at least 10 min. after adding stabilizer to allow it to reach the carburetor.

⚠ Do not store with debris in bag.



Use only a qualified mechanic for any adjustments, disassembly or any kind of repair .



WARNING: TO AVOID PERSONAL INJURY, ALWAYS TURN MACHINE OFF, MAKE SURE ALL MOVING PARTS COME TO A COMPLETE STOP.



DISCONNECT SPARK PLUG WIRE BEFORE SERVICING UNIT.



ENGINE: See engine manufacturer operator's instructions.

DEBRIS BAG: See page 6.



RECONNECT SPARK PLUG WIRE, GUARDS, BAG, CAPS AND / OR HOSE BEFORE STARTING ENGINE.

1. Wait for engine to cool and disconnect spark plug.
2. Drain fuel and oil from the engine.
3. Remove bag, quick release, upper handle and clutch cable from upper handle. Do not kink, stretch, or break control cables, control housings, or end fittings while removing handles.
4. Remove chain guard, chains and jackshaft assembly (see page 9, Drive Chain).
5. Invert and support machine with engine not touching ground to prevent damage to recoil starter.
6. Disassemble housing by removing six (6) lock nuts and washers from nozzle frame, (2 are inside of nozzle opening).
7. Remove impeller bolt and lock washer.
8. Lift impeller upward. If impeller slides freely, proceed to (step 11).
9. Place two crowbars between impeller and housing on opposite sides. Pry impeller away from engine until it loosens. *Using a penetrating oil can help loosen a stuck impeller.*
10. If the impeller does not loosen, obtain a 1" (25.4mm) longer bolt of the same diameter and thread type as the impeller bolt. Thread longer bolt by hand into the crankshaft until bolt bottoms. Using a suitable gear or wheel puller against the bolt head and the impeller back-plate (near the blades), remove impeller from shaft.
11. Remove engine mounting screws, bolts, and nuts as required.
12. When impeller is free of the engine shaft, lift impeller and housing assembly off engine. Align impeller with opening, and diagonally lift impeller out of housing.
13. Using a new impeller bolt and lockwasher, reinstall new impeller in reverse order.
14. Tighten impeller bolt. Torque impeller bolt to 50 Ft. Lbs. (68 N.m) (see item 51 on page 11).
15. Reinstall engine onto housing in reverse order of removal.
16. Invert machine back onto all 4 wheels.
17. Reinstall jackshaft assembly components onto housing in reverse order of removal, properly tighten chains and adjust clutch (see Drive on page 9).
18. Reinstall spark plug wire.

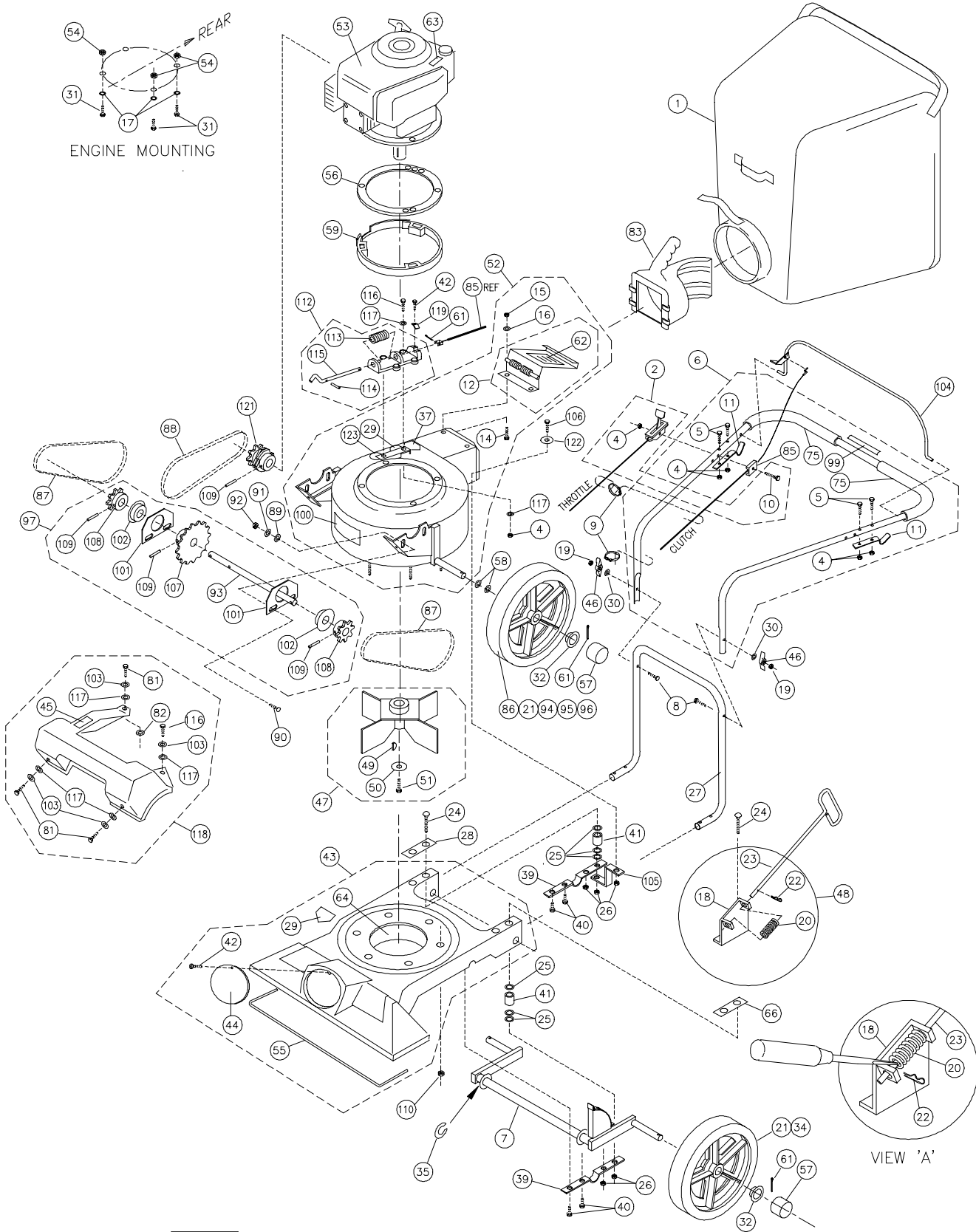
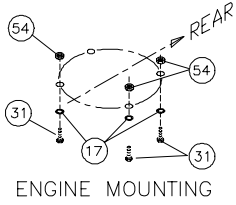

18 PARTS DRAWING
KD505SPQ

Item No.	19 PARTS LIST	Description	KD505SPQ	Qty.
			Part No.	
1	DEBRIS BAG (service assy)	890305	1	
2	THROTTLE ASSEMBLY (INCL. 1 ea items 4, 10)	900514-04	1	
3				
4	NUT LOCK (1/4 - 20)	*8160001	7	
5	SCREW CAP (1/4 - 20 x 1-1/2 HEX)	*8041008	4	
6	HANDLE ASS'Y (incl. items 4(5), 5(4), 11(2), 99, 75(2))	900059	1	
7	AXLE REAR - FRAME W.A.	900956	1	
8	SCREW CURVED HEAD 5/16 - 18 x 2-1/4	900547	2	
9	CLAMP CABLE PLASTIC 1"	900813	2	
10	SCREW CAP 1/4 - 20 x 2 1/4	*8041011	1	
11	BAR SUPPORT BAG	900039	2	
12	DOOR EXHAUST ASS'Y (incl. item 62)	890148	1	
13				
14	SCREW CAP #10 - 24 x 5/8	*8059135	2	
15	NUT LOCK #10 NC	*8164005	2	
16	WASHER #10 FC	*8171001	2	
17	WASHER LOCK 3/8 INT.	*8180011	3	
18	BRACKET - HEIGHT ADJUSTMENT	900932	1	
19	NUT LOCK 5/16-18 THIN HT.	*8161041	2	
20	SPRING	900136	1	
21	TIRE - ONLY (PER ASSY) TREADED	900659	1	
22	PIN - HAIR COTTER	900471	1	
23	ROD SHORT HT. ADJ.	890110	1	
24	BOLT - CARRIAGE 5/16 - 18 x 3-1/2	*8024050	4	
25	WASHER - FLAT 5/16 SAE	*8172008	12	
26	NUT LOCK 5/16 - 18 HEX	*8160002	5	
27	HANDLE LOWER KD505	900041	1	
28	PLATE HANDLE SUPPORT	900933	1	
29	LABEL DANGER CUT FINGER	400424	2	
30	WASHER FLAT CUT 5/16	*8171003	2	
31	SCREW CAP 3/8 - 16 X 2 1/2 WASHER FACE	900564	3	
32	WASHER HUB CAP 1/2 I.D.	900927	4	
33				
34	WHEEL ASS'Y CAST (incl. item 21) TREADED	900760	2	
35	WASHER 0.75 "C"	900997	1-0	
36				
37	LABEL EAR EYE BREATHING	890254	1	
38				
39	PLATE BRACE REAR	890189	2	
40	SCREW CAP 1/4 - 20 x 1/2	*8041002	4	
41	SPACER	900926	4	
42	SCREW SELF TAPPING 10 - 24 x 1/2	*8123086	2	
43	NOZZLE MAINFRAME ASS'Y (incl. one of items 29, 44, 42, 55, 64)	900966	1	
44	PLUG	900146	1	
45	LABEL OIL CHAIN	830502	1	
46	KNOB WING 5/16-18	890108	2	
47	IMPELLER ASS'Y (incl. items 49, 50, 51)	900342-S	1	
48	HEIGHT ADJUST ASSY	890326	1	
49	KEY HI PRO (5/32 x 5/8)	900162	1	
50	WASHER LOCK 3/8 TWISTED TOOTH	400502	1	
51	SCREW CAP 3/8 - 24 x 1 1/2" (HARDENED) (TORQUE 50 FT-LBS) (68 N-m)	900344	1	
52	HOUSING ASS'Y (incl. items 12, 14, 15, 16, 29, 37, 100)	890237	1	
53	ENGINE 5.0 H.P. BRIGGS & STRATTON QUANTUM	900619	1	
54	NUT LOCK 3/8 16	*8160003	3	
55	ROD BUMPER	900939	1	
56	GASKET	800411	1	
57	CAP HUB	900486	4	
58	WASHER FLAT 1/2 SAE	*8172011	4	
59	SPACER RING FULL ASSY	900304T	1	
60				
61	PIN COTTER 3/32 x 3/4	*8197016	5	
62	LABEL DANGER FLYING MATERIAL	810736	1	
63	LABEL HOT ENGINE	400268	1	
64	GUARD FOAM INSERT	900977	1	
65				
66	PLATE BRACE HT. ADJ.	900756	1	
67				
68				
69				
70				
71				
72				
73				
74				
75	GRIP HANDLE	400570	2	
76				
77				
78				
79				
80				
81	SCREW CAP 1/4 - 20 x 3/4	*8041004	3	
82	SPACER CHAIN GUARD	900569	1	
83	CONNECTOR QUICK	890176	1	
84				
85	CABLE ASS'Y CLUTCH	900207	1	

* Denotes standard hardware item that may be purchased locally.

19
Parts List
continued from
page 11.

Item No.	Description	KD505SPQ Part No.	Qty.
86	WHEEL WITH SPROCKET ASS'Y CAST (21, 94, 95, 96)	900512	2
87	CHAIN 52 PITCH	890239	2
88	CHAIN 40 PITCH	900323	1
89	WASHER FLAT 5/16 (3/8 ID x 7/8 x 1/16)	*8171003	4
90	BOLT CARRIAGE 5/16 -18 x 3/4	*8024039	4
91	WASHER SPRING LOCK 5/16	*8177011	4
92	NUT REGULAR 5/16-18	*8142002	4
93	JACKSHAFT	900320	1
94	SPROCKET (PER ASSEMBLY) 26 TEETH (Size 65A26)	890238	1
95	SCREW SELF TAP 1/4-14 x 3/4 (PER ASSEMBLY)	800505	5
96	WASHER LOCK EXTERNAL TOOTH (PER ASSEMBLY)	*8181007	5
97	JACKSHAFT ASS'Y (INCLUDE. 93, 101, 102, 107, 108, 109)	890197	1
98			
99	LABEL CLUTCH	830503	1
100	LABEL-DANGER GUARDS	900327	1
101	BEARING PLATE	900317	2
102	BEARING BALL (WITH SNAP RING)	900321	2
103	WASHER LOCK 1/4	*8177010	4
104	ROD BAIL CLUTCH	900970	1
105	BAR BRACE HANDLE	900768	1
106	SCREW CAP 5/16-18 x 3/4	*8041026	1
107	SPROCKET - 17 TOOTH	900303	1
108	SPROCKET - 8 TOOTH	900302	2
109	ROLL PIN 3/16 DIA. x 1 1/4 LG.	*8195166	4
110	LOCKNUT 5/16 - 18 FLANGE	850164	5
112	BRACKET CONTROL ASS'Y (INCL. 113, 114, 115)	900221	1
113	SPRING	900136	1
114	ROLL PIN 1/8" DIA. x 1 1/4 LG.	*9195106	1
115	ROD CLUTCH	900208	1
116	SCREW CAP 1/4-20 x 1/2" LG.	*8041002	3
117	WASHER 1/4" FLAT (5/16 ID x 3/4 OD x 1/16)	*8171002	8
118	GUARD CHAIN ASS'Y	890231	1
119	CLIP-CLUTCH CABLE	900999	1
120			
121	CLUTCH DOUBLE RELEASE	900307	1
122	WASHER FENDER 5/16	*8172020	1
123	LABEL READ OWNER'S MANUAL	890301	1

* Denotes standard hardware item that may be purchased locally.

20 TROUBLESHOOTING *Before Requesting Service Review These Suggestions*

Problem	Possible Cause	Solution
Will not vacuum or has poor vacuum performance.	Dirty debris bag. Nozzle height set too high or too low. Hose kit cap missing. Clogged nozzle or exhaust. Excessive quantity of debris.	Clean debris bag. Shake bag clean or wash. Adjust nozzle height. Check for hose kit cap. Unclog nozzle or exhaust (see page 5). Allow air to feed with debris.
Abnormal vibration.	Loose or out of balance impeller or loose engine.	Check impeller and replace if required. Check Engine.
Engine will not start.	Throttle in off position. Out of gasoline. Bad or old gasoline. Spark Plug wire disconnected. Dirty air cleaner.	Check stop switches, throttle, and gasoline. Connect spark plug wire. Clean or replace air cleaner. Or contact a qualified service person.
No self propelling.	Operator's bail not releasing clutch. Broken or out of adjustment clutch cable. Worn or broken clutch assembly. Bracket control assembly (item 112) out of adjustment.	Adjust clutch cable. Adjust bracket control assembly. Replace any worn or damaged or malfunctioning parts.
Self propelled drive will not release .	Clutch cable out of adjustment. Clutch not lubricated and is locked-up.	Adjust clutch cable. See page 9 Clutch Adjustment. Oil clutch.
Engine is locked, will not pull over.	Debris locked inside impeller. Engine problem.	See page 5, Contact an engine servicing dealer for engine problems.

22.1 Engine Service and Warranty
Contact your nearest engine manufacturer's authorized servicing dealer.

21 Serial Plate *Record your machine model, serial number and date-of-purchase and where purchased*







1803 S. Jefferson
P.O. Box 308
Lee's Summit,
MO 64063 / USA
Tel (816) 524-9666
Fax (816) 524-6983

Model	Serial No.
Unit (Weight)	Engine Power
<input type="text"/> lbs. <input type="text"/> kg	<input type="text"/> kW <input type="text"/> rpm

Operator _____

Purchase Date _____ Purchased from _____

22 WARRANTY PROCEDURE

Please fill in the WARRANTY CARD and send the upper part to Billy Goat. The WARRANTY terms are stated on the lower part which remains with the user. Whenever a Billy Goat Machine is faulty due to a defect in material and / or workmanship, the owner should make a warranty claim as follows:

The Machine should be taken to the dealer from whom it was purchased or to an authorized Billy Goat dealer.

The owner should present the remaining half of the Warranty Registration Card, or, if this is not available, the invoice or receipt.

The Warranty Claim will be filled in by the authorized Billy Goat Dealer, who will send it with the faulty part to Billy Goat headquarters.

The Quality / Service department at Billy Goat headquarters will study the claim and parts and will notify their conclusions.

The decision by the Quality / Service department at Billy Goat headquarters to approve or reject a Warranty claim is final and binding.

Note: To process a Warranty Claim, it is necessary to quote the Model & Serial number who are printed on the Billy Goat Serial Plate.



BILLY GOAT INDUSTRIES, INC.
P.O. BOX 308 (1803 S JEFFERSON LEE'S SUMMIT, MO 64063 / USA
PHONE: 816-524-9666 FAX: 816-524-6983

Free Manuals Download Website

<http://myh66.com>

<http://usermanuals.us>

<http://www.somanuals.com>

<http://www.4manuals.cc>

<http://www.manual-lib.com>

<http://www.404manual.com>

<http://www.luxmanual.com>

<http://aubethermostatmanual.com>

Golf course search by state

<http://golfingnear.com>

Email search by domain

<http://emailbydomain.com>

Auto manuals search

<http://auto.somanuals.com>

TV manuals search

<http://tv.somanuals.com>