

BenQ Joybee 200
MP3 Player
User Manual

Welcome

Copyright

All rights reserved. No part of this publication may be reproduced, transmitted, recorded, stored in a retrieval system, or translated into any language or computer language, in any form or by any means, electronic, mechanical, recording, photocopying, or otherwise, without the prior permission of the BenQ Corporation.

Disclaimer

The BenQ Corporation shall make no warranty or representation, either expressed or implied, with respect to the quality, accuracy or fitness for any particular purpose of this document. The information in this document is subject to change without notice. The content of this manual has been checked and proofread prior to publication.

*Windows is the registered trademark of Microsoft Corporation. All trademarks or product names appearing in this manual are registered property of their respective owners.

Cautions

- This MP3 player is a delicate electronic device - DO NOT OPEN IT.
- Do not format memory using the FAT32 format.
- Do not attempt to disassemble or modify any part of the device.
- Avoid shock or impact to the device.
- Keep the device away from water.
- Keep the device away from extreme temperatures, humidity, dust or direct sunlight.

- Do not clean the device with chemical solvents. Clean the device with a cloth dampened with water.
- Use only the adapter and accessories approved by the manufacturer. The warranty is voided if other adapters or accessories are used, which may be dangerous.
- Avoid listening at high volume, which may damage your ears and cause loss of hearing.
- The BenQ Corporation assumes no responsibility for the loss of data due to damage to the device, repair of the device and/or battery replacement. Users are advised to back up all data on other storage devices. Use of the device not in accordance with the instructions will void the warranty.

Memo

Introduction	1
System requirements	2
Package contents	3
Touring the BenQ Joybee 200 MP3 Player	4
Buttons and ports	4
Putting leather strap on.....	5
LCD display.....	9
Charging the battery.....	11
Connecting earphones and wired remote control.....	13
Connecting the Joybee 200 to a PC	14
Disconnecting the Joybee 200 from a PC.....	15
Installing the software	17
Installing the USB driver.....	19
Installing in Windows ME/Windows 2000/Windows XP	19
Installing in Windows 98SE	19
Turning the Joybee 200 on and off.....	20
Transferring data to the Joybee 200	21
Transferring data with Windows Explorer.....	21
Transferring files with QMusic	21
Playing MP3/WMA music files	22
Repeat play	23
Selecting an EQ mode.....	24
Selecting a playback speed.....	24
Listening to FM radio.....	25
Saving preset channels in memory	26
Recording FM radio.....	26
Using the recorder function.....	27
Playing back recorded audio files	28
System setup	29
Deleting files from the Joybee 200	29

Setting the recording options	30
Setting up a timer recording.....	33
Setting the power save option.....	34
Using the lyric sync function	35
Using the play list function.....	36
Setting the date and time	37
Setting the language	38
Formatting the Joybee 200.....	39
Upgrading the firmware.....	40
Viewing system information.....	41
Overview of QMusic	43
Adding music to the Joybee 200 using QMusic	47
Adding music from an audio CD to Joybee 200.....	48
Adding files from a PC to Joybee 200.....	52
Updating Joybee 200 automatically with QMusic	55
Deleting files using QMusic.....	58

1 Introducing the BenQ Joybee 200 MP3 Player

Introduction

Thank you for purchasing the BenQ Joybee 200 MP3 Player!

The BenQ Joybee 200 MP3 Player offers high quality audio playback and voice recording functions at low power consumption.

The Joybee 200 supports MP3, WMA, and WAV music formats for your listening pleasure. Moreover, the seven built-in EQ modes of the Joybee 200 allow you to enjoy music at the best sound quality. In addition to being a MP3 player, the Joybee 200 also functions as a FM radio, an audio recorder, and a FM transmitter for music share.

The FM radio function enables you to preset up to 16 radio stations for quick and easy listening. The recording function enables you to record your voice from the built-in microphone, from the radio receiver or from the MP3 player. The FM transmitter allows you to broadcast your music with another device equipped with a FM transceiver.

Joybee 200 not only enriches your musical life but also allows you to carry your data everywhere. Its convenient driver-free plug and play function allows you to use it as a USB flash disk on Windows 98SE/2000/ME/XP.

The Joybee 200 comes equipped with a software suite for additional convenience. The QMusic software enables you to convert and transfer music from your PC or audio CDs to the Joybee 200.



When the batteries are fully charged, Joybee 200 offers about 10 hours of continuous replay time for MP3 music. However, the exact replay time depends on the condition of the battery, the volume level and many other factors.

System requirements

Your PC must comply with the following requirements in order to enable data transfer to your player:

- OS: Microsoft Windows 98/2000/Me/XP/98SE (QMusic supports Windows 2000/XP/98SE)
- CPU: Pentium 200 MHz or faster
- I/O port: USB (1.1 or higher)
- Device: CD-ROM
- Hard disk space: 40 MB (minimum)
- System memory: 32 MB (minimum)

Package contents

Check the contents of your Joybee 200 MP3 Player package. Contact your dealer immediately if any of the following are missing or damaged.

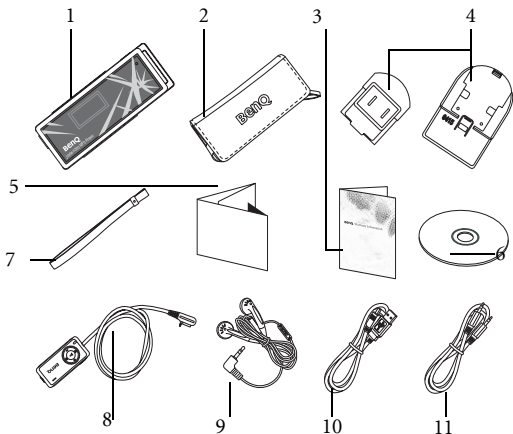

1. BenQ Joybee 200 MP3 Player
2. Carrying pouch
3. Warranty card
4. AC power adapter & plug
5. Quick start guide
6. Software CD-ROM (E-manual, driver, QMusic, etc.)
7. Leather strap
8. FM Transmitter or Wired remote(Optional)
9. Stereo headphones
10. USB cable
11. Line-in Cable

Touring the BenQ Joybee 200 MP3 Player

The following section describes the various components of the Joybee 200.

Buttons and ports

Left View

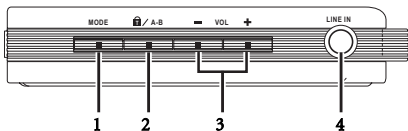

Front View

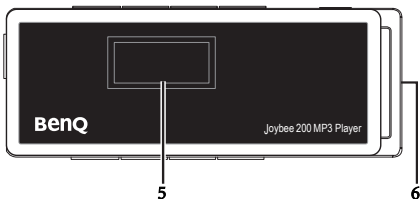

Right View

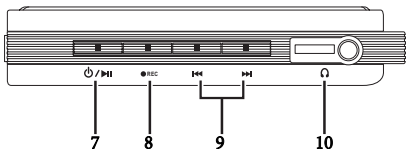

Bottom View

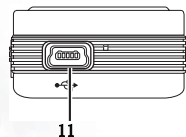

Putting leather strap on

Follow the steps below to put the leather strap on your Joy-bee 200.

(1)

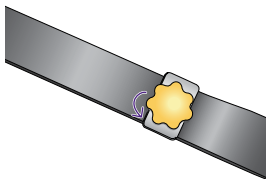

(2)

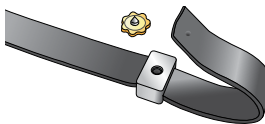

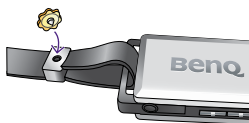

(3)



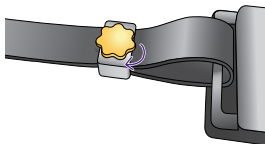

(4)

















Item	Description	Function
(1)	Mode MODE	<ul style="list-style-type: none"> • Press to switch modes. • Press and hold for 2 seconds to display options for the current mode. • Press to cancel current setting and go back to the previous level in setup or playback mode.
(2)	A-B repeat/ Lock)  / A-B	<ul style="list-style-type: none"> • Follow this procedure to repeat a desired section during audio playback. <ol style="list-style-type: none"> Press once to set point A. Press again to set point B and the section from point A to B repeats continuously. Press again to disable the repeat function. • Press and hold for 2 seconds to lock or unlock the keys.
(3)	Volume control — VOL +	Press VOL – to decrease volume and VOL + to increase volume.
(4)	LINE IN	For external audio signal recording.
(5)	LCD Display	Displays player status and file information. See "LCD display" on page 9 for details.
(6)	Neck strap hook	For attaching the neck strap.







Item	Description	Function
(7)	Power on/off, Play/Pause/ Stop/Enter 	<ul style="list-style-type: none"> • Press and hold for 2 seconds to turn on the Joybee 200. • Press and hold for 2 seconds to turn the player off. The message 'System Off' is displayed on the screen before the power goes off. • Press once to play an audio file in playback mode. Press once to pause playback and press again to continue playing in playback mode. • Press and hold for 2 seconds to stop playing or recording and switch to file layout. • Press to confirm a selection in setup mode.
(8)	Record 	Press to start recording. Press again to stop recording.

Item	Description	Function
(9)	Previous/Fast Rewind, Next/Fast Forward buttons 	<ul style="list-style-type: none"> • Press once to skip to the previous or next file in audio file playback mode. • Press and hold for 4 seconds to rewind or fast forward an audio file in playback mode. • Press once to scroll to the previous or next item in menu mode. • Press and hold for 2 seconds to scroll back or forward continuously in menu mode. • Press once to skip to the previous or next channel or frequency in FM radio mode. • Press and hold for 2 seconds to auto-scan the frequencies in forward or reverse direction in FM radio mode. • Press to skip to the previous or next item in setup mode.
(10)	Earphone and wired remote control jack	Connects to earphones and wired remote control jack.
(11)	USB port	Connects the Joybee 200 to a PC or to the battery charger for charging the built-in battery.
(12)	Force shutdown	Turns Joybee 200 off when system malfunctions. Turn on the Joybee 200 by using  after force shutdown.

LCD display

The LCD screen displays information about the player mode and file information. The following table shows the icons displayed on the screen and their meanings.

Icon	Description
	Indicates audio file being scanned in forward direction (Forward).
	Indicates audio file is being scanned in reverse direction (Rewind).
	Indicates FM radio mode.
	Indicates that recording time is remaining.
	Indicates recording in progress.
	Indicates that recording has been paused.
	Indicates single track repeat mode.
	Indicates random mode.
	Indicates random repeat mode.
	Indicates sampling mode.
	Indicates repeat mode is disabled.
	Indicates A-B repeat mode.
	Indicates repeat mode for all files.
	Indicates fast (110), slow (90) and very slow (80) playback speeds.
	Indicates MP3/WMA mode.

Icon	Description
	Indicates voice recording mode.
	Indicates audio recording mode.
	Indicates FM mode.
	Indicates setup mode.
	Indicates battery status.
	Indicates keys are locked.
	Indicates player is connected to a PC with the USB port.

2 Getting Started

Charging the battery

Follow these steps to charge the Joybee 200's battery.

1. Remove the translucent rubber cover from the charger socket. Insert one end of the power adapter cable into the USB port of the Joybee 200 and the other end to the adapter.

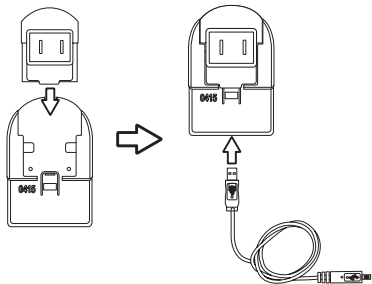

2. Connect the adapter to a wall outlet.

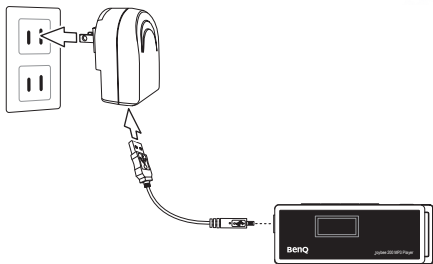

It takes around 1 hour to quick charge the Joybee 200 built-in battery. For fully charge of thwe battery, it takes about 3.5 hours.



- **Exact charging time depends on battery status.**
- **Chargers for use in some areas may not have an indicator. Check the battery charge status using the indication on the LCD display (see "LCD display" on page 9).**
- **The life of battery depends on how often it has been charged. Frequent charging results in shorter playing time.**

Connecting earphones and wired remote control

Follow these steps to connect earphones and wired remote control.

- Plug the earphones into the earphone jack on the wired remote control as shown in the illustration.

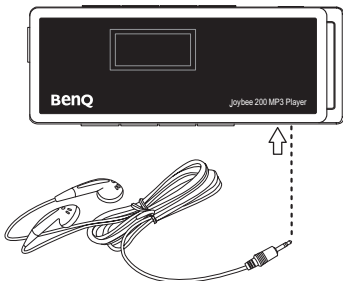

- To connect both the wired remote control as well as the earphones, connect the wired remote control to the Joybee 200. Connect the earphones to earphones jack on the wired remote control.

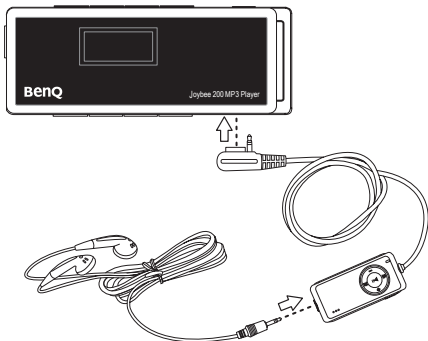

Connecting the Joybee 200 to a PC

Connect the Joybee 200 to your PC with the USB cable provided as shown in the illustration.

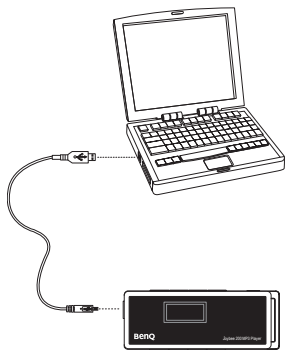

When the Joybee 200 is successfully connected to the PC, a new **Removable Disk** icon appears in the **My Computer** window on your PC. A message saying **Connection Completed** along with a connection icon is also displayed on the LCD screen of the Joybee 200.

 If the dialog box "Windows found new hardware" keeps appearing on the PC screen after the connection, press Next or OK to close the dialog box.

Disconnecting the Joybee 200 from a PC

Follow these steps to disconnect the Joybee 200 from a PC.

1. Double click the USB device icon  on the taskbar. A dialog box as shown below appears on the screen.

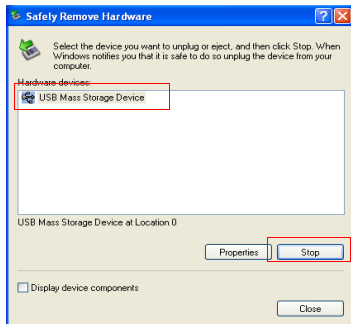

2. Select **USB Mass Storage Device** in the dialog box and press **Stop**. Another dialog box appears on the screen.

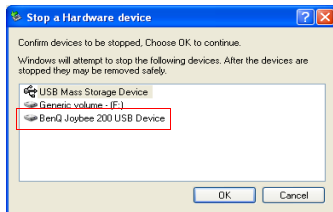

3. Select **BenQ Joybee 200 MP3 Player USB Device** and press **OK**

4. When the following dialog box appears on the screen, press **OK** and disconnect the Joybee 200 from the PC.



 **The procedure described here may differ for the different operating systems.**

Installing the software

Insert the software CD provided with the Joybee 200 in the CD-ROM drive on your PC. The following installation menu is displayed on the PC screen.

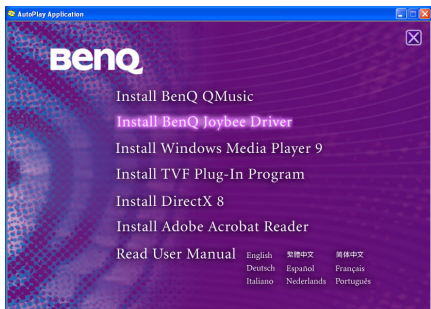

If the installation menu does not appear on your PC screen, open Explorer in Windows and locate the 'autorun.exe' file on the software CD. Double-click the icon to open the installation menu.

Click to select and install the desired software. Follow the instructions on the screen to complete the installation. The following table shows the contents and functions of the software suite on the CD.

Item	Description
Install BenQ QMusic	QMusic is an easy-to-use file manager that allows you to play an audio CD and MP3 files, convert music on an audio CD into MP3 files, create playlists, create audio CDs, and organize your CD albums. With QMusic, you can save your music files on the Joybee 200, and organize and update the data stored on the Joybee 200. Note that QMusic works only on Windows 2000/XP. Windows 2000 does not support the CD burning function.
Install BenQ Joybee 200 Software	The player software includes Joybee 200 firmware upgrade and memory quick format utilities.If you are using Windows 98SE, please install this software before connecting the Joybee 200 to your PC.
Install Windows Media Player 9	QMusic requires Windows Media Player 9 to be installed on your system. Click this item to install Windows Media Player 9 if you do not have it installed.
Install Direct X 8	QMusic requires Direct X to be installed on your system. Click this item to install Direct X if you do not have it installed.
Install Adobe Acrobat Reader	Install the Acrobat Reader to read the electronic documentation for your MP3 player.
Read User Manual	Click to read the User Manual in the language of your choice. Choose from English, Simplified Chinese, Traditional Chinese, Japanese, German, French, Italian, Spanish, and Dutch.

Installing the USB driver

Installing in Windows ME/Windows 2000/Windows XP

Follow these instructions to install a USB driver.

1. Turn on the BenQ Joybee 200 MP3 Player.
2. Connect the Joybee 200 to the USB port of your computer using the USB cable provided.
3. A **New Hardware Found** message appears on the PC screen and installation of the driver is completed automatically.

Installing in Windows 98SE

Use the **Install Joybee 200 Software** option described in the previous section to install the driver if you have Windows 98SE running on your PC.

1. Turn on the Joybee 200.
2. Connect it to the USB port of your computer using the USB cable provided. The **Adding New Hardware Wizard** appears to install the driver.
3. Follow the instructions on the screen to complete installation. Browse to select the files required for installation under the Joybee 200 directory in the BenQ folder on the disk drive where you installed the Joybee 200 Software.

A **Removable Disk** icon appears in the **My Computer** window on your PC after installation is completed successfully.

3 Using the BenQ Joybee 200 MP3 Player

Turning the Joybee 200 on and off

Follow these steps to turn the Joybee 200 on or off.

- Press and hold the power button for 2 seconds to turn on the Joybee 200. After the welcome note is displayed, the Joybee 200 enters whatever mode the player was in when it was switched off.
- Press and hold down the power button for 4 seconds to turn the player off. The BENQ logo is displayed on the screen before the power goes off.



The Joybee 200 turns off automatically when it has been in idle mode for more than 1 minute.

Transferring data to the Joybee 200

You can transfer music files to the Joybee 200 using Windows Explorer or the QMusic software provided. QMusic also enables you to convert your audio CDs to MP3 files and copy them to the player.

Transferring data with Windows Explorer

Follow these steps to transfer files to the Joybee 200 using Windows Explorer.

1. Connect Joybee 200 to a PC with the USB cable as described in "Connecting the Joybee 200 to a PC" on page 14.
2. Locate your existing MP3 (.mp3) or WMA (.wma) files in your PC.
3. Select the desired files, copy and pastethem to the MP3 folder in **Removable Disk**. The selected files will be transferred to Joybee 200.











- Do not disconnect the Joybee 200 from the PC when the message 'Don't remove' is displayed on the OLED screen. Disconnect the Joybee 200 from your PC only when the message 'USB connect' is displayed alone on the screen.
- Check that there is enough memory space on the Joybee 200 before transferring files to it.

Transferring files with QMusic

Connect it to your PC using the USB cable provided as described in "Connecting the Joybee 200 to a PC" on page 14. Refer to "Adding music to the Joybee 200 using QMusic" on page 47 for detailed information about transferring files to your player using the QMusic software.

Playing MP3/WMA music files

Use the following procedure to quickly start listening to your favorite music on the BenQ Joybee 200 MP3 Player.

1. Turn on the Joybee 200.
2. Press the MODE button repeatedly to switch to MP3 mode.
3. Press the  key to play the current track.
4. Use the  or  keys to skip to the previous or next tracks. Press and hold down the  or  keys for 2 seconds to scan in the reverse or forward direction.
5. Press  to pause playback. Press the  key again to resume playback.
6. Press and hold  for 2 seconds to stop playback and switch to file layout mode.
7. Use the VOL + or VOL - buttons to increase or decrease the volume as desired during playback. The LCD screen shows the volume setting when you change the volume.

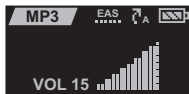
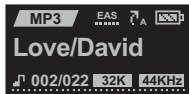

Repeat play

You can use the repeat function to play a selected track, section, all files or a random file repeatedly.

1. Press and hold the MODE button for two seconds while a track is playing to display a popup menu.



2. Use the \lll or \ggg keys to select the **REPEAT** option.
3. Press the $\blacktriangleright \parallel$ key to confirm your selection.
4. Use the \lll or \ggg keys to scroll through the various repeat options.

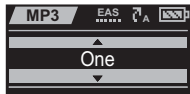

- Choose $\text{C}1$ to repeat the current track.
- Choose $\text{C}ALL$ to repeat all tracks.
- Choose $\text{C}R$ to play a random track once.
- Choose $\text{C}RR$ to repeat random tracks.
- Choose $\text{C}S$ to play an introductory sample of the audio track.
- Choose $\text{C}OFF$ to disable the repeat function.

Alternatively follow these steps to repeat a desired section of the track during playback.

1. Press the A-B key once to set point A.
2. Press the key again to set point B. The section from point A to B repeats continuously. The A-B icon appears at the bottom of the LCD screen.
3. Press the A-B key again to disable the repeat function.

Selecting an EQ mode

The Joybee 200 provides seven equalizer modes to enhance the quality of audio. Select the EQ mode as described in the following procedure.

1. Press and hold the MODE button for two seconds while a track is playing to display a popup menu.
2. Use the |◀◀ or ▶▶| keys to select the **EQ** option.
3. Press the ▶|| key to confirm your selection.
4. Use the |◀◀ or ▶▶| keys to scroll through the various equalizer options: Bass, Speech, Normal, Classical, Jazz, POP, and Rock.

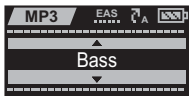

Selecting a playback speed

The Joybee 200 provides four playback speeds when playing MP3s or recorded files. Select the Speed mode as described in the following procedure.

1. Press and hold the MODE button for two seconds while a track is playing to display a popup menu.
2. Use the |◀◀ or ▶▶| keys to select the **Speed** option.
3. Press the ▶|| key to confirm your selection.
4. Use the |◀◀ or ▶▶| keys to scroll through the various speed options: Faster, Normal, Slower, and Slowest.



Listening to FM radio

The radio mode of the Joybee 200 enables you to listen to FM radio as follows.

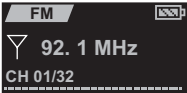
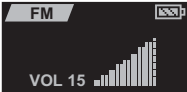
1. Turn on the Joybee 200.
2. Press the MODE button repeatedly to switch to FM mode.
3. Choose an FM frequency using one of the following procedures.
 - Use the **|◀◀** or **▶▶|** keys to scan to the previous or next frequency.
 - Press and hold down the **|◀◀** or **▶▶|** keys for 2 seconds to auto-scan frequencies in the up or down direction. Stop scanning when the desired frequency is displayed by pressing the **▶▶||** key.
 - Press and hold the **▶▶||** key for 2 seconds to display a list of preset channels. Use the **|◀◀** or **▶▶|** keys to select the desired channel and the **▶▶||** key to confirm your selection.
4. Use the **VOL +** or **VOL -** buttons to increase or decrease the volume as desired during playback. The LCD screen shows the volume setting when you change the volume.

Saving preset channels in memory

Follow these steps to save your favorite radio stations for quick access.

1. When listening to your favorite channel, press and hold the MODE key for 2 seconds to display a pop-up menu.
2. Use the ◀◀ or ▶▶ keys to choose a channel number (1-32).
3. Press the ▶|| key to confirm your selection. The current channel is saved to the location you specified.

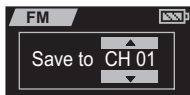



Recording FM radio

Follow these instructions to use the Joybee 200 to record from the FM radio.

 **Do not turn off the Joybee 200 or connect or disconnect it from a PC while recording.**

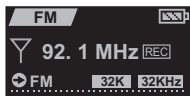
1. When listening to your favorite channel, press the ●REC key to start recording.
2. Press the ▶|| key to pause recording and press it again to resume recording.
3. Press and hold the ▶|| key for 2 seconds to stop recording. Alternatively, you can also press the ●REC key again to stop recording.



 **All recorded radio programs are saved as MP3 files with filenames such as FM0101. The number at the end of the filenames refers to date and the order in which the programs were recorded. These files are saved in the Radio folder on the Joybee 200. Use the procedure described in "Playing back recorded audio files" on page 28 to listen to your recorded programs. The repeat play, multiple playback speeds, and**

equalizer functions are also available when you play back a recorded program. Refer to "Repeat play" on page 23, "Selecting an EQ mode" on page 24, and "Selecting a playback speed" on page 24 for more details.

Using the recorder function

The Joybee 200 has a recording function to enable you to record your voice using the built-in microphone or an external audio signal as follows.









- **Recording function will be disabled when the battery is low.**
 1. Press the key to start recording and speak into the microphone.
 2. Press the key to pause recording and press it again to resume recording.
 3. Press and hold the key for 2 seconds to stop recording.

Refer to "Setting the recording options" on page 30 for more details about setting the recording parameters.

 All recorded programs are saved as MP3 files with filenames such as MIC0101 or LINE0101. The prefix indicates the source of the recording and the number at the end of the filenames refers to date and the order in which the programs were recorded. These files are saved in the MICIN or LINEIN folders on the Joybee 200. Use the procedure described in "Playing back recorded audio files" on page 28 to listen to your recorded programs. The repeat play, multiple playback speeds, and equalizer functions are also available when you play back a recorded program. Refer to "Repeat play" on page 23, "Selecting an EQ mode" on page 24, and "Selecting a playback speed" on page 24 for more details.

Playing back recorded audio files

Voice mode enables you to play back your recorded (FM, MIC or LINEIN) files. The recorded files are saved as MP3s with the filename indicating the source of the recording, the date and the order in which they were recorded. Follow these steps to play back your recorded files.

1. Turn on the Joybee 200.
2. Press the MODE button repeatedly to switch to VOICE mode.
3. Press the  key to play the current file.
4. Use the  or  keys to skip to the previous or next file. Press and hold down the  or  keys for 2 seconds to scan in the reverse or forward direction.
5. Press  to pause playback. Press the  key again to resume playback.
6. Press and hold the  for 2 seconds to stop playback and switch to file layout mode.
7. Use the VOL + or VOL - buttons to increase or decrease the volume as desired during playback. The LCD screen shows the volume setting when you change the volume.

 The repeat play, multiple playback speeds, and equalizer functions are also available when you play back a recorded program. Refer to "Repeat play" on page 23, "Selecting an EQ mode" on page 24, and "Selecting a playback speed" on page 24 for more details.

System setup

Deleting files from the Joybee 200

Follow these instructions to delete any files from your Joybee 200.

1. Turn on the Joybee 200.
2. Press the MODE button repeatedly to switch to SETUP mode.
3. Use the **◀◀** or **▶▶** keys to select the desired option as follows:

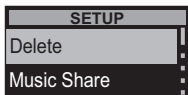

- **Music File:** deletes the selected music (MP3 or WMA) file.
- **Voice File:** deletes the selected recorded (FM, MICIN, or LINEIN) file.
- **All Music:** deletes all music (MP3/WMA) files.
- **All Voice:** deletes all recorded (FM, MICIN, or LINEIN) files.

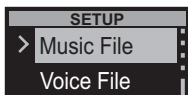

4. Press **▶▶** to confirm your selection.
5. If you selected the Music File or Voice File options, a list of the files is shown. Use the **◀◀** or **▶▶** keys to scroll and select the desired file and press **▶▶** to confirm your selection.

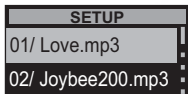

6. You are asked to confirm the deletion. Use the **◀◀** or **▶▶** keys to highlight either **Yes** or **No** to delete the file(s) or cancel.

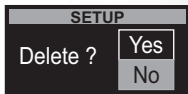

7. Press  to confirm your selection.
8. Press the MODE key to exit from the setup menu.

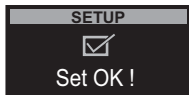







 You can also use QMusic or Windows Explorer to delete files on the Joybee 200.

Setting the recording options

You can set the recording quality when recording from FM radio, the internal microphone, or an external audio signal. You can also specify the recording source signal as well as enable the VOR function when recording.

To set the recording quality, do the following:

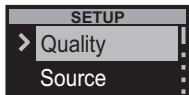
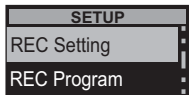

1. Turn on the Joybee 200.
2. Press the MODE button repeatedly to switch to SETUP mode.
3. Use the  or  keys to select the **REC Setting** option.
4. Press  to confirm your selection.
5. Use the  or  keys to select the **Quality** option from the popup menu.
6. Use the  or  keys to select the desired option. The popup menu provides you with four MP3 quality options for recording quality: **MP3-L (Low)**, **MP3-M (Medium)**, **MP3-H (High)**, and **TVF**.



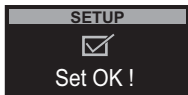





7. Press  to confirm your selection.

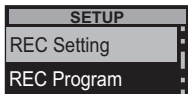



To specify the default source signal when recording voice files, do the following:

1. Turn on the Joybee 200.
2. Press the MODE button repeatedly to switch to SETUP mode.
3. Use the  or  keys to highlight **REC Setting** from the menu and press the  key to confirm your choice.

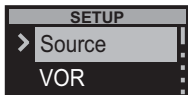

4. Use the  or  keys to highlight **Source** in the menu and press the  key to confirm your choice.
5. Use the  or  keys to highlight **Mic In** to record from the microphone signal or select **Line in** to record from the external audio signal connected to the LINE IN jack.



6. Press the  key to confirm your choice.
7. Press the MODE button repeatedly to return to Playback Mode. Record the voice signal as described in "Using the recorder function" on page 27.

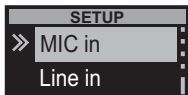

The Joybee 200 has the VOR feature that only records when a voice signal is detected and stops recording if there is no voice or audio signal. This prevents blank spaces in your recorded files. To enable the VOR feature, do the following:



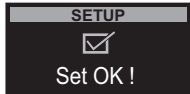
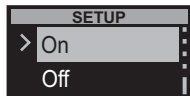
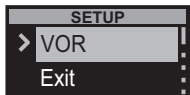
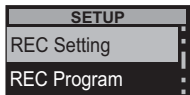

1. Turn on the Joybee 200.
2. Press the MODE button repeatedly to switch to SETUP mode.
3. Use the |◀◀ or ▶▶| keys to highlight **REC Setting** from the menu and press the ▶▶ key to confirm your choice.
4. Use the |◀◀ or ▶▶| keys to highlight **VOR** in the menu and press the ▶▶ key to confirm your choice.
5. Use the |◀◀ or ▶▶| keys to highlight **On** to enable VOR or **Off** to disable the feature.
6. Press the ▶▶ key to confirm your choice.
7. Press the MODE button repeatedly to return to Playback Mode.

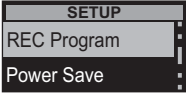

Setting up a timer recording

The Joybee 200 can be programmed to start recording automatically at a specified time, from a specified input source.

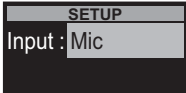
To set up a timer recording, do the following:

1. Turn on the Joybee 200.
2. Press the MODE button repeatedly to switch to SETUP mode.
3. Use the |<< or >>| keys to select the **REC Program** option.
4. Press ►|| to confirm your selection.
5. Use the |<< or >>| keys to select **On** to enable the timer recording.
6. Press ►|| to confirm your selection.
7. Use the |<< or >>| keys to select the input source for the recording. Choose from **Mic**, **Line**, and **Radio**.
8. Press ►|| to confirm your selection.
9. Use the |<< or >>| keys to set the date and time when the recording starts. Set the date (year, month, date) and the time (hours and minutes) using the |<< or >>| keys and press ►|| after each option to move to the next.

10. Use the |◀◀ or ▶▶| keys to set the date and time when the recording ends. Set the date (year, month, date) and the time (hours and minutes) using the |◀◀ or ▶▶| keys and press ▶▶ after each option to move to the next.



11. Press ▶▶ to confirm your selection.





Setting the power save option

The Joybee 200 has a power save option to switch it off if no key has been pressed for a specified interval to conserve power.

To set the power save feature, do the following:

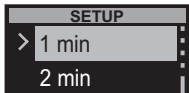
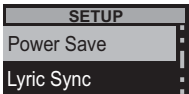
1. Turn on the Joybee 200.
2. Press the MODE button repeatedly to switch to SETUP mode.
3. Use the |◀◀ or ▶▶| keys to select the **Power Save** option.
4. Press ▶▶ to confirm your selection.
5. Use the |◀◀ or ▶▶| keys to select **1 min**, **2 min**, or **3 min** as the time interval for the power save feature.





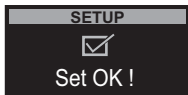



6. Press  to confirm your selection.



Using the lyric sync function

The Joybee 200 has a special feature that enables you to know the view the lyrics on the display when playing back music. The Lyrics editing tool in QMusic enables you to create the lyrics and you can enable the lyrics sync feature using the setup menu as follows:

1. Turn on the Joybee 200.
2. Press the MODE button repeatedly to switch to SETUP mode.
3. Use the  or  keys to select the **Power Save** option.
4. Press  to confirm your selection.
5. Use the  or  keys to select **On** to enable the lyrics sync feature.
6. Press  to confirm your selection.

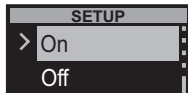
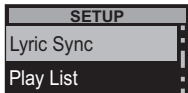

Using the play list function

The Joybee 200 provides a play list feature that helps you create play lists of your favorite songs. Create play lists using QMusic and play them on your Joybee 200 by activating the play list feature as follows:

1. Turn on the Joybee 200.
2. Press the MODE button repeatedly to switch to SETUP mode.
3. Use the |◀◀ or ▶▶| keys to select the **Play List** option.
4. Press ▶▶ to confirm your selection.
5. Use the |◀◀ or ▶▶| keys to select **On** to enable the play list feature.
6. Press ▶▶ to confirm your selection.

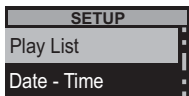

Setting the date and time

Follow these steps to set the date and the time:

1. Turn on the Joybee 200.
2. Press the MODE button repeatedly to switch to SETUP mode.
3. Use the |◀◀ or ▶▶| keys to select the **Date - Time** option.
4. Press ▶▶ to confirm your selection.
5. Use the |◀◀ or ▶▶| keys to set the year, month, date, hour, minute and second. Move to the next field by pressing the ▶▶ key to confirm your setting.
6. Press ▶▶ to confirm your new settings. The time and date are set on your player.

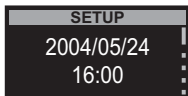
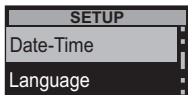

Setting the language

Follow these steps to set the language:

1. Turn on the Joybee 200.
2. Press the MODE button repeatedly to switch to SETUP mode.
3. Use the |◀◀ or ▶▶| keys to select the **Language** option.
4. Press the ▶▶ key to confirm your selection.
5. Use the |◀◀ or ▶▶| keys to select the desired language from the choices provided: **Traditional Chinese, Simplified Chinese, or English**.
6. Press the ▶▶ key to confirm your setting. The language of your choice is selected for the menus.

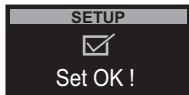
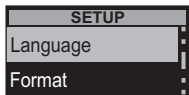

Formatting the Joybee 200

Follow these steps to format the Joybee 200 and delete all its contents:

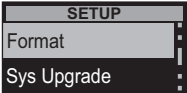
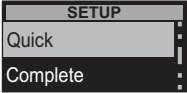
1. Turn on the Joybee 200
2. Press the MODE button repeatedly to switch to SETUP mode.
3. Use the |◀◀ or ▶▶| keys to select the **Format** option.
4. Press ▶▶|| to confirm your selection.
5. Use the |◀◀ or ▶▶| keys to select **Quick** for a quick format or **Complete** for a complete format of the system.
6. Press the ▶▶|| key to confirm your selection. Formatting begins and the message **Formatting...** is displayed on the screen. All data is deleted.

Upgrading the firmware

Follow these steps to upgrade the firmware of the Joybee 200:

1. Turn on the Joybee 200
2. Press the MODE button repeatedly to switch to SETUP mode.
3. Use the |◀◀ or ▶▶| keys to select the **Sys Upgrade** option.
4. Press ▶▶ to confirm your selection.
5. You will be prompted to connect the Joybee 200 to your PC using the USB cable. Press any key to exit this function. When connected to the PC, the screen displays a **Ready to Upgrade** message.
6. The Add New Hardware Wizard appears on the screen of your PC. Browse to select the files required for upgrade in the update directory in the BENQ folder on the disk drive where you installed the Joybee 200 Digital Audio Player software. Follow the instructions of the wizard to complete the installation process.

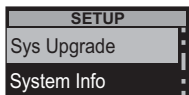

Viewing system information

To view information about the system such as details about memory usage, number of music and voice files, and the version number of the firmware, do the following:

1. Turn on the Joybee 200.
2. Press the MODE button repeatedly to switch to SETUP mode. A menu is displayed on the screen.
3. Use the |◀◀ or ▶▶| keys to select the **System Info** option.
4. Press ▶|| to confirm your selection.
5. The screen displays information about the system memory and firmware. Use the |◀◀ or ▶▶| keys to scroll and view all the information.
6. Press the MODE key to exit the setup menu.

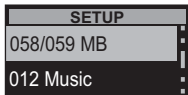
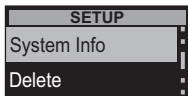

4 Using QMusic

QMusic is software provided to help you to organize your music collection. You can use it to play audio CDs or MP3s on your PC, convert audio CD tracks into MP3 format, create playlists, transfer music to your Joybee 200, burn music CDs and create your own music album.



The QMusic icon appears on your Desktop after it is successfully installed as described in "Installing the software" on page 17. Double click the icon to launch QMusic. Alternatively, you can start QMusic by clicking **Start** on the Windows taskbar and clicking **Programs | QMusic2 | QMusic2**.

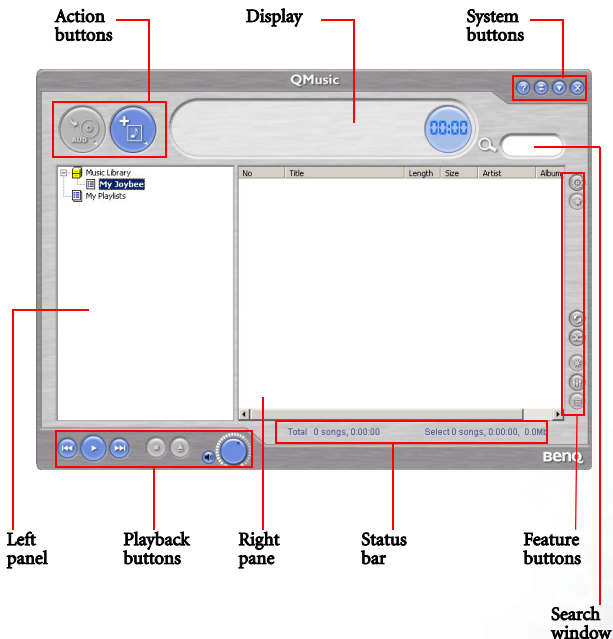

Overview of QMusic

The user interface of the QMusic program is shown in the illustration below.



Features	Description
Action buttons	<p>Provides specific QMusic functions.</p>  <p>Left button: Convert CD audio tracks to MP3 formats.</p> <p>Right button: Add audio files saved in your PC to either Music Library or MP3 folder under Joybee 200.</p>
Left panel	<p>Displays all files supported by QMusic.</p>  <p>There are two default folders in your hard disk: Music Library and My Joybee. You can save and organize your audio files here.</p> <p>Music Library: All your MP3 audio files transferred from audio CD tracks would be saved in the folders under this root data base.</p> <ul style="list-style-type: none"> • QMusic can auto-search CD album title and CD tracks data base when your PC is connected to the internet.



My Joybee: QMusic automatically synchronizing function folder. When you set Joybee 200 MP3 player automatically synchronizing every time the Joybee 200 MP3 player is connected to your PC, the audio files in Joybee 200 will be replaced by the files here.







Joybee200(F:24 Available\Capacity...): This appears when your Joybee 200 MP3 player is connected to your PC. F stands for Joybee 200 MP3 player as a removable drive and the digits following are current memory usage status.

MP3: Joybee 200 MP3 player default folder. You can directly drag and drop your audio files saved under the **Music Library** to this folder, or you can just right click the folder and select **Add songs** to copy audio files saved in your hard disk to this folder.

FMRadio: Joybee 200 MP3 player default folder. All your recorded FM audio files will be saved in this folder.

MicIn: Joybee 200 MP3 player default folder. All your recorded voice files will be saved in this folder.

Playlist: You can right click this folder to create sub-playlists to organize all your audio files in Joybee 200/ MP3 folder. Create different playlists, drag and drop the audio files from Joybee 200/ MP3 folder to each playlist, and you can reorganize the playback order in each album.

Playback buttons	 <p>Provides functions such as playing a selected file, skipping to the next or previous files, pausing playback, stopping playback, ejecting a CD, and volume control.</p>
Status bar	Displays details of files, such as total number of files and playing time.
Feature buttons	<p>Sets repeat or random playing of files in playback mode and provide additional options.</p> <p> Setting button: Click to have general settings dialogue box.</p> <p> Repeat button: Click to repeat playback all tracks.</p> <p> Random button: Click to random play all tracks.</p> <p> EQ button: Click to have EQ control pane</p> 
Right panel	Displays the files in the folder or media selected in the left panel.
Search window	Provides searching function. Type in a file name and press the magnifier icon to search for a particular file.
System buttons	Control QMusic window.
Display	Displays progress of an action. For example, when an audio file is being played, the name, elapsed playing time and other information of the file is displayed here.

For more detailed information on buttons function, please refer to HELP file.

Adding music to the Joybee 200 using QMusic

Connect the Joybee 200 to the PC using the procedure described in "Connecting the Joybee 200 to a PC" on page 14. The icon  Joybee 200 appears in the left panel of the QMusic interface, and the directories on the Joybee 200 are displayed under the icon.

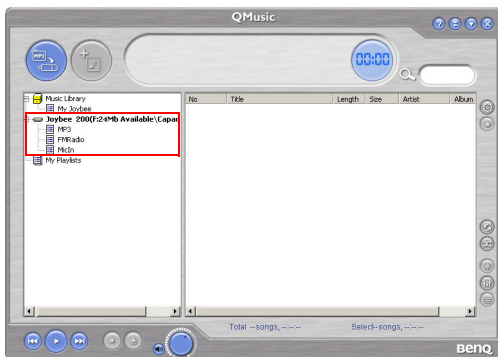

You can now add files to your Joybee 200 from an audio CD using the file conversion facility provided by QMusic or you can directly copy your audio music files from the PC to the Joybee 200.

Adding music from an audio CD to Joybee 200

1. Put an audio CD in the CD-ROM on your PC. The  **Audio CD** icon appears in the left panel of QMusic, and the files on the CD appear in the right panel.



2. Select the files to be added to the Joybee 200 by clicking the check boxes in front of the files.

3. Click the  icon, and QMusic starts converting the selected files into MP3 files.



4. After the conversion is completed, a **New Album** is added to the left panel. All the converted files are placed in this album. Click the **New Album** to display the details of files in the right panel.

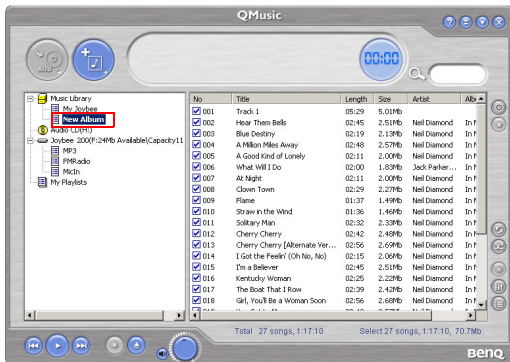

5. Select the files to be added to the Joybee 200. To select more than one file, press and hold the **Ctrl** key on the keyboard while selecting the files. To select all files, click the first file, press and hold the **Shift** key on the keyboard, and then click the last file. If you want to delete files, select files and press the **Delete** key on the keyboard.



6. Drag to copy the selected files from the right panel to the **MP3** directory under the Joybee 200 icon.



- Check if there is enough memory space on Joybee 200 before transferring files to Joybee 200.

Adding files from a PC to Joybee 200

Follow these steps to add files from a PC to your Joybee 200.

1. Click the **My Joybee** folder in the left panel.



2. Press  to open a dialogue box for selecting files. Browse and select MP3, WAV or WMA files to be add to the Joybee 200 from the PC. Press **Open** to add the selected files to **My Joybee**.

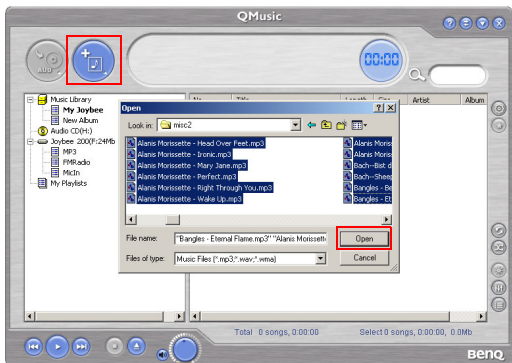

3. Click the  Joybee 200 icon on the QMusic interface.



4. Press  and QMusic starts transferring the files in the **my joybee** folder to the Joybee 200. Before transferring the selected files to Joybee 200, QMusic shows a dialog box to ask if you want to delete the existing files in the **My Joybee** folder. If you want to keep them, abort the transfer and back up these files, before starting file transfer again.

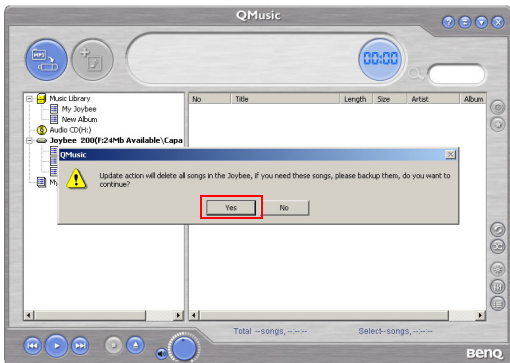

- Check if there is enough memory space on Joybee 200 before transferring files to Joybee 200.
- The Joybee 200 supports WMA DRM files. To play back WMA files, use QMusic to transfer them to the Joybee 200.

Updating Joybee 200 automatically with QMusic

You can set up the Joybee 200 to be updated with the music from the **My Joybee** folder automatically when it is connected to the PC.

1. Click the **My Joybee** folder in the left panel.



- Press  to open a dialogue box for selecting files. Browse and select MP3, WAV or WMA files to be added to the Joybee 200 from the PC. Press **Open** to add the selected files to **My Joybee**.

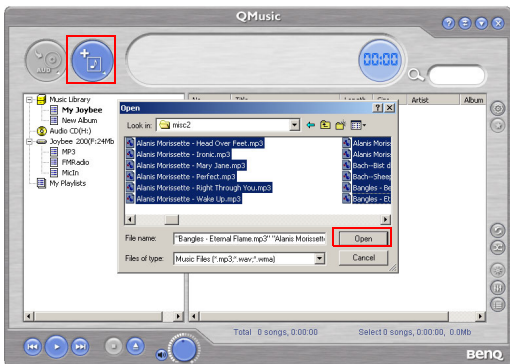

- Press  on the right panel of QMusic in the function button area.

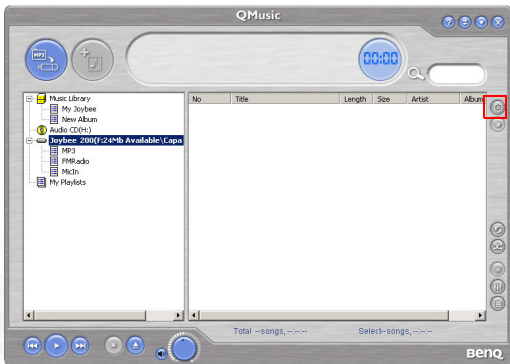

4. In the **Option** dialog box shown, click the **Joybee** tab.

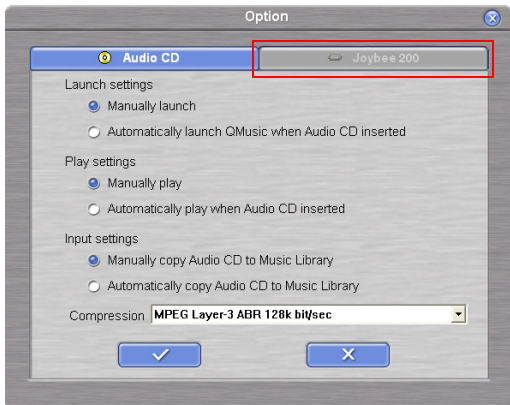

5. Select **Automatically launch QMusic when Joybee added** under **Launch Settings** and **Automatically transfer MP3 files to Joybee when added** under

Update Settings. Click the  button to save your settings.

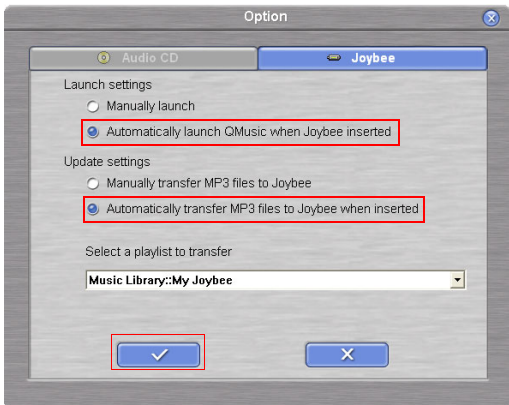

6. Connect the Joybee 200 to the PC and QMusic automatically updates the files on Joybee 200 with the files in **My Joybee** folder.

From now on, if you want to automatically update files on Joybee 200, you only need to save files in the **My Joybee** folder and connect the Joybee 200 to your PC. QMusic automatically transfers the files in the folder to the Joybee 200.

- **Check if there is enough memory space on Joybee 200 before transferring files to Joybee 200.**

Deleting files using QMusic

Use the following procedure to delete files on your Joybee 200 using QMusic.

1. Start QMusic.
2. Turn on the Joybee 200 and connect it to the PC using the USB cable.
3. Locate the files to be deleted by clicking on the **MicIn** or **MP3** subdirectory under the Joybee 200 icon in the left panel of QMusic.



4. The files in the selected directory are displayed in the right panel. Click to select the file to be deleted. To select more than one file, press and hold the **Ctrl** key on the keyboard while selecting the files. To select all

files, click the first file, press and hold the **Shift** key on the keyboard, and then click the last file.



5. Press the **Delete** key on the keyboard to delete all selected files from the Joybee 200.

5 Troubleshooting

Unable to transfer files to Joybee 200.

 Check the following:

- The USB cable has been securely connected to the PC and Joybee 200, and the Joybee 200 is turned on.
- The USB driver has been installed on your PC.
- The battery on Joybee 200 is charged.

Data stored in Joybee 200 is lost.

 If the power supply is unstable when the Joybee 200 is connected to a PC, it may cause data loss. Hence, we strongly recommend you to back up all the data stored on the Joybee 200. BenQ Corporation will make no representation on damage or indemnification arising from loss of data.

Memory on the Joybee 200 is sufficient for the files I want to transfer to Joybee 200, but I cannot transfer them to Joybee 200.

 The Joybee 200 allocates memory in blocks of 16 KB or 32 KB. Even a file of 1 byte size occupies one block of memory. Hence, even if the total size of the files is not larger than the memory size, you may not be able to transfer all files to the Joybee 200.

I cannot see anything on the screen of Joybee 200.



- Check that the Joybee 200 is turned on and has sufficient battery charge.
- The firmware of Joybee 200 may be damaged due to improper operation. Perform Firmware Update.

6 Service Information

If you cannot solve the problems encountered while using the Joybee 200 with the troubleshooting guide, please contact our worldwide service locations to obtain the latest drivers and online support services.

Region	Country or City	Telephone Number	E-mail Address
Asia	China	+86-512-68092520	service@benq.com.cn
	Hong Kong	+852-23306188	service@benq.com.cn
	Taiwan	0800-027-427	support@benq.com.tw
	Singapore	+65-6777-2229	servicesg@benq.com
	Thailand	+66-2-6700310-1	serviceth@benq.com
	Malaysia	+603-7954-8660	servicemy@benq.com
Australia		61-1300-130-336	service-au@benq.com
Europe	The Netherlands	0900-2367-669	support@Benq.nl
	Belgium	+32(0)2-645-32-52	
	Luxembourg		
	Germany	0180-3232-002 (Euro €0.09/minute)	support@benq.de
	Switzerland	+41(0)22-567-5331	N/A
	Italy	+39(0)2-385-91-029	support@benq.it
	UK/Ireland	+44(0)207-216-0039	support@benq.co.uk
	Spain	+34(0)91-754-7015	support@benq.es
	Portugal	+351-2-1316-4113	
	Austria	+43(0)1-360-2772-062	support@benq.at
	Romania	+40(0)259-342431	
	Czechoslovakia	02-24321322	service@medisoft.cz
Poland	032-373-6168	serwis@itus.pc	

America	USA	+305-593-5250	compumex@fdr.com
	Los Angeles	888-723-2238	BenqCS.us@benq.com
	Mexico	01-800-712-7745	support.latinamerica@benq.com
	Chile	562-399-5000	rcox@vector.cl
Middle East	The United Arab Emirates	+971-4-2825767	DhirajManghnani@benq.com
	Iran		
	Kuwait		
	Yemen		
	Qatar		
	Saudi Arabia		

Free Manuals Download Website

<http://myh66.com>

<http://usermanuals.us>

<http://www.somanuals.com>

<http://www.4manuals.cc>

<http://www.manual-lib.com>

<http://www.404manual.com>

<http://www.luxmanual.com>

<http://aubethermostatmanual.com>

Golf course search by state

<http://golfingnear.com>

Email search by domain

<http://emailbydomain.com>

Auto manuals search

<http://auto.somanuals.com>

TV manuals search

<http://tv.somanuals.com>