

Read all instructions BEFORE assembly and USE of product.
KEEP INSTRUCTIONS FOR FUTURE USE.

Item#: PY81988

Check that you have all the below parts for this model
before assembling the playard.

Playard (fully assemble) x 1	Mobile Lower Arm x 1
Mattress x 1	Mobile Arm Holder x 1
Bassinet x 1	Mobile Upper Curved Arm x 1
Metal Support Tubes (2 male, 2 female)	Mobile Tri-shaped Arm x 1
Diaper Stacker x 1	Toy Animal x 3
	Travel / Storage Bag x 1

Nursery Center

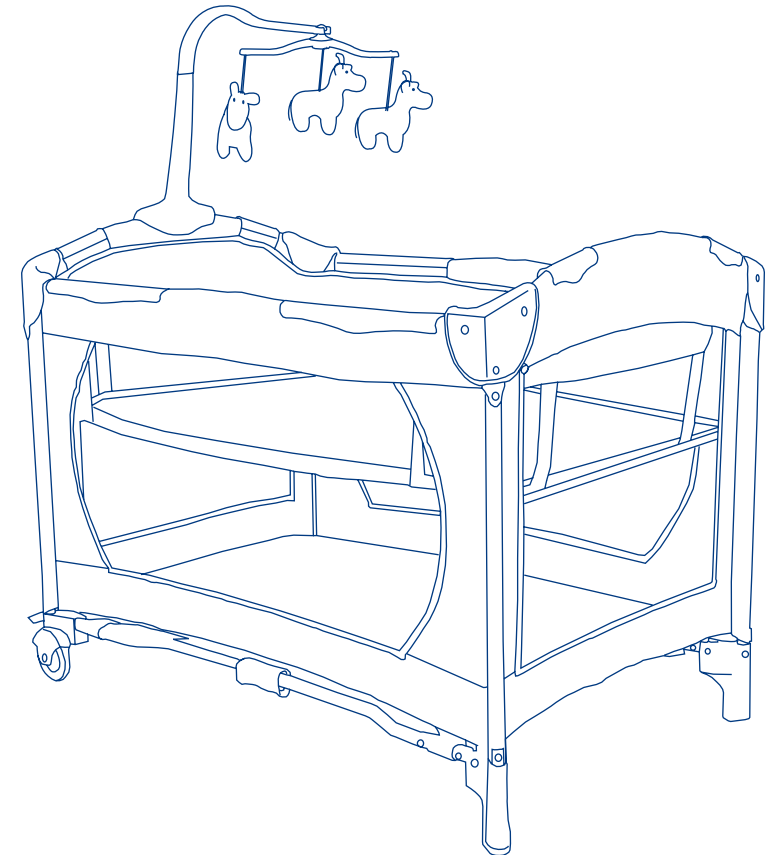

*Toys and mobile may vary



**IF YOU EXPERIENCE ANY DIFFICULTY IN USING THIS PRODUCT,
PLEASE CONTACT OUR CUSTOMER SERVICE DEPARTMENT AT
1-800-328-7363 BETWEEN THE HOURS OF 8:00 A.M. AND 4:30 P.M. PACIFIC
STANDARD TIME FOR ASSISTANCE. PLEASE HAVE YOUR MODEL NUMBER AND
MANUFACTURING DATE AVAILABLE WHEN YOU CALL. THIS INFORMATION CAN BE
FOUND ON A SMALL STICKER UNDER THE PLAYARD.**

baby trend
Convenience through innovation and thoughtful design

Contact us by mail:
Baby Trend, Inc.
1607 S. Campus Ave., Ontario, CA 91761

Contact us by phone:
1-800-328-7363 (8:00am ~ 4:30pm PST)
or online <http://www.babytrend.com>

Instruction Manual

baby trend
Convenience through innovation and thoughtful design
www.babytrend.com

10.09

⚠️ WARNING: NEVER LEAVE INFANT IN PRODUCT WITH SIDES DOWN.

Infant may roll into space between pad and loose mesh side causing suffocation.

⚠️ WARNING:

Infants can suffocate:

- In gaps between a mattress too small or too thick and product sides
 - On soft bedding
- Never add a mattress, pillow, comforter, or padding.
Use only the mattress provided by manufacturer.
Never use a water mattress with this product.

⚠️ WARNING: See playard floor and side rails for warnings.

⚠️ WARNING: Failure to follow these warnings and the instructions could result in serious injury or death.

- **NEVER** use this product if there are any loose or missing fasteners, loose joints, broken parts, or torn mesh/fabric. Check before assembly and periodically during use. Contact Baby Trend Customer Service at 1-800-328-7363 for replacement parts, repair or instructions. **NEVER** substitute parts.
- **NEVER** leave child in product with sides lowered. Be sure sides are in raised and locked position whenever child is in product.
- **NEVER** use plastic shipping bags or other plastic film as mattress covers not sold and intended for that purpose. They can cause suffocation.
- This product is not intended for commercial use.

MAINTENANCE AND CLEANING INSTRUCTIONS:

Use only household mild soap and warm water.

DO NOT USE BLEACH.
DO NOT MACHINE WASH.

-
- The playard, including side rails, must be fully erected prior to use. **Make sure latches are secure.**
 - Strings can cause strangulation! **NEVER** place items with a string around a child's neck such as hood strings or pacifier cords. **NEVER** suspend strings over playard or attach strings to toys.
 - Discontinue use of the product when child is able to climb out or has reached the height of 35 in. (890 mm) or weight of 30 lbs. (14 kgs), whichever comes first.
 - When child is able to pull to standing position, remove bumper pads, large toys and other objects that could serve as steps for climbing out.
 - **NEVER** place product near a window where cords from blinds or draps can strangle a child.
 - Always provide the supervision necessary for the continued safety of your child. When used for playing, **NEVER** leave child unattended.
 - To reduce the risk of SIDS, pediatricians recommend healthy infants be placed on their back to sleep, unless otherwise advised by your physician.

If you experience any difficulty with the use of our product or have a question regarding these instructions, please contact our Customer Service Department at 1-800-328-7363 between the hours of 8:00 a.m. and 4:30 p.m. (PST). Please do not return the product to the store as once it is returned it cannot be re-sold and the materials and energy used to make it are wasted.

Contact us by mail:
Baby Trend, Inc.
1607 S. Campus Ave., Ontario, CA 91761

Contact us by phone:
1-800-328-7363 (8:00am ~ 4:30pm PST)
or online <http://www.babytrend.com>

IMPORTANT! To ensure safe operation of your playard, please follow these instructions carefully. Please keep these instructions for future reference.

IMPORTANT! Before assembly and each use, inspect this product for damaged hardware, loose joints, missing parts or sharp edges. NEVER use if any parts are missing or broken.

IMPORTANT! Adult assembly is required.

TO ASSEMBLE PLAYARD



Check the parts list on the back cover to make sure you have all the parts for this model before assembling the playard.



Playard

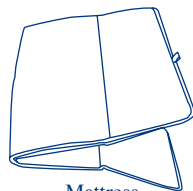

Mattress

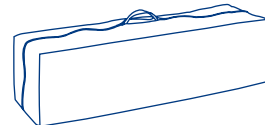

Travel / Storage Bag

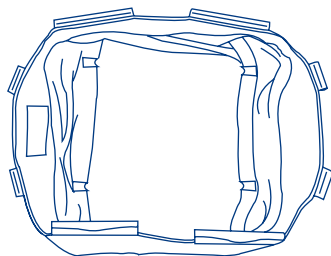

Bassinet

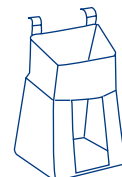

Diaper Stacker



Metal Support Tubes
(2 male, 2 female)

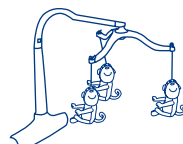

Fixed Mobile*
*Toy type vary



Playard

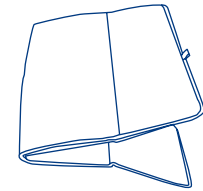

Mattress



ATTENTION:

Playard must be fully assembled and securely locked before installing or using other accessories.

1. Unzip bag and remove Playard frame (Fig. 1). Undo the three (3) Fasten straps and set the Mattress aside.

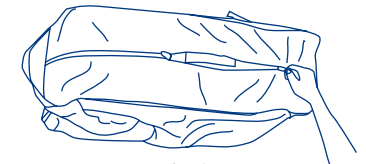

Fig. 1

2. **DO NOT** push center down yet.

3. Top rails must be fully erected before lowering center. Pull up one rail at a time, hold one hand on each side of the rail and pull up sharply, do not pull from the middle where the center latch release is located, make sure both tubes latch in place and each rail is rigid. (Fig. 2).

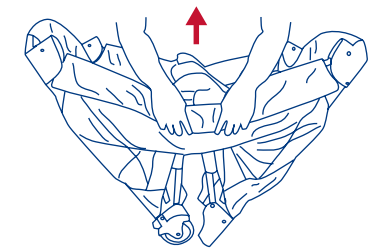

Fig. 2

IMPORTANT: The center must be raised while locking the rails. If one rail will lock but the other side will not then, unlock the rail by squeezing the release in the center and try again.

4. Once all four (4) top rails are locked in place, push down on the center handle (Fig. 3). The center mechanism will rotate clockwise 90 degrees and automatically lock in place.

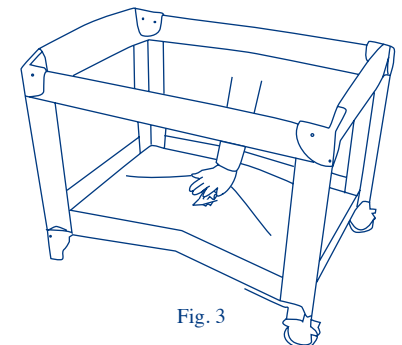

Fig. 3

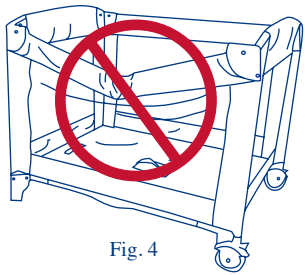

Fig. 4

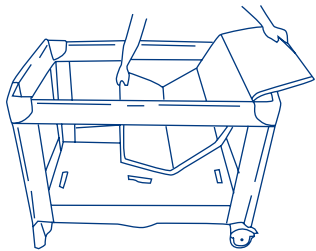

Fig. 5

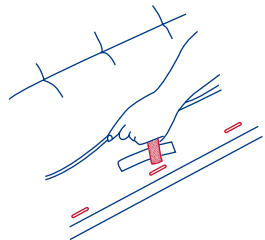

Fig. 6

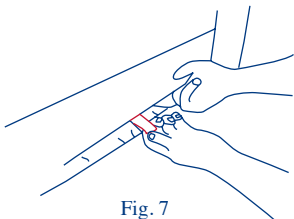

Fig. 7

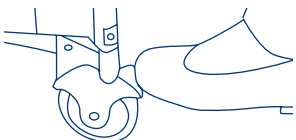

Fig. 8

IMPORTANT: Test each top rail by pushing down slightly to confirm each is rigid and locked securely in place before use. (Fig. 4)

5. Place the Mattress on the floor of the Playard with the padded side facing up. (Fig. 5)

6. Insert the three (3) Velcro® straps located on the underside of the Mattress through the slots in the floor of each end of the Playard (Fig. 6). Fasten the hook and loop straps to the underside of the Playard floor to prevent the Mattress from moving. (Fig. 7)

IMPORTANT: The handle located in the center of the Playard floor **MUST** remain raised (Approx. 45.7 cm or 18 inches) while locking the side rails in place. If the center is not raised the rails will **NOT** lock.

If you experience difficulty and one side of the rail will lock but the other side will not then, unlock the rail by squeezing the release in the center and try again. If you still have difficulty, contact our Customer Service Center at 1-800-328-7363 or visit us online at www.babytrend.com.

7. To operate the brakes on the Wheels, press downward on the brake levers. To release, lift upward on the lever. (Fig. 8)

ATTENTION:

To use as a bassinet, skip to page 8 for bassinet installation instructions.

FOLDING PLAYARD

1. Release the three (3) Velcro® straps holding the Mattress from underneath the Playard floor or the Bassinet and set the mattress aside.

2. Do not unlock top rails yet, center of floor must be raised before top rails will unlock.

3. Rotate the center handle counter-clockwise 90 degrees and raise the center as high as the top rails (Fig. 9). Gather the Legs and Wheels together towards the center as close as possible so that they nearly touch.

4. Locate the rail latch release in the center and bottom side of each rail. Squeeze the lever with two hands until the rail releases the two tubes (Fig. 10), then push down (Fig. 11). **NOTE:** If the top rail(s) do not release completely, **DO NOT FORCE!** Lift the center of floor higher. Both tubes must be released for the top rail to fold.

5. Gather four (4) corners and center all together tightly (Fig. 12). Wrap Mattress around Playard frame with padded side facing inward. Secure the three (3) hook and loop straps by feeding them through the loops on the end of the Mattress and folding them back onto themselves.

6. Wrap Mattress around Playard frame with padded side facing inward.

7. Secure the three (3) hook and loop straps by feeding them through the loops on the end of the Mattress and folding them back onto themselves. (Fig. 13)

8. Place folded Playard into carry bag so that the handle comes through the opening between each side of the zipper.

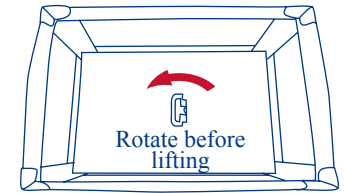
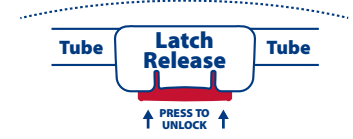

Fig. 9



TOP RAIL

Fig. 10

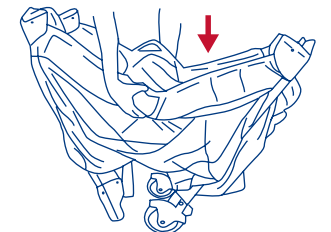

Fig. 11



Fig. 12

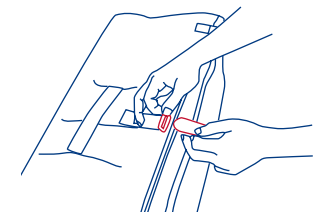

Fig. 13

ACCESSORIES

⚠ WARNING: Failure to follow these warnings and the instructions could result in serious injury or death.

⚠ FALL HAZARD: To help prevent falls, do not use this product when the infant begins to push up on hands and knees or has reached the height of 25 in. (635 mm), weight of 15 lbs. (6.8 kgs) or 4 months old, whichever comes first.

⚠ SUFFOCATION HAZARD: Infants can suffocate

- In gaps between an extra pad and sides of the bassinet/cradle
- On soft bedding

Never add a mattress, pillow, comforter, or padding.
Use only the pad provided by manufacturer.
Never use a water mattress with this product.

- To reduce the risk of **SIDS**, pediatricians recommend healthy infants be placed on their back to sleep, unless otherwise advised by your physician.
- The playard, including side rails, must be fully erected prior to use. **Make sure each latch is secure.**
- Strings can cause strangulation! **NEVER** place items with a string around a child's neck such as hood strings or pacifier cords. **NEVER** suspend strings over bassinet or attach strings to toys.
- Discontinue use of the bassinet or the changing table when child begins to push up on hands and knees or has reached the height of 25 in. (635 mm), weight of 15 lbs. (6.8 kgs) or 4 months old, whichever comes first.
- **NEVER** place product near a window where cords from blinds or drapes can strangle a child.
- Always provide the supervision necessary for the continued safety of your child. **NEVER** leave child unattended.
- **NEVER** use plastic shipping bags or other plastic film as mattress covers not sold and intended for that purpose. They can cause suffocation.
- Use bassinet with only one child at a time.
- **NEVER** place a child under the bassinet.
- **NEVER** store the bassinet in the playard while in use.
- The bassinet must be fully assembled and installed before using.
- **STRANGULATION HAZARD: NEVER** leave the changing table in place when the child is in the bassinet or the playard. Always flip changing table down while not in use.
- To prevent your child from falls and other injuries, always use safety belt when child is on the changing table, always stay within arm's reach of your child when using the changing table.
- To help prevent heat build-up inside the playard and to avoid overheating your child, when using the bassinet **NEVER** use an outdoor canopy.

TO ASSEMBLE BASSINET

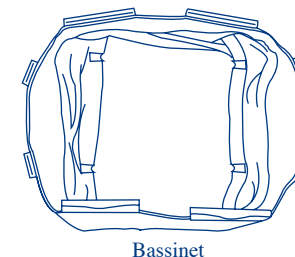
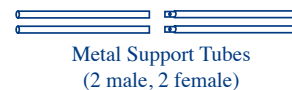

ATTENTION:

Playard must be fully assembled and securely locked before installing or using the bassinet feature. (See To Assemble Playard section)

You will need to remove the mattress from the bottom of the Playard to use inside your Bassinet.

1. Position the Bassinet over and down into the fully assembled Playard. Secure in place by pushing down firmly on each plastic support clip until all are snapped into place (Fig. 14).

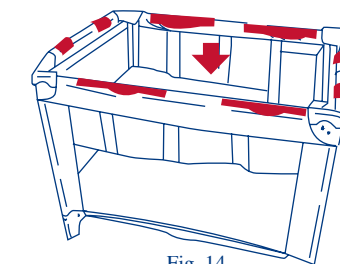

2. Assemble Mattress Support Tubes by inserting the two (2) male tubes into the two (2) female tubes (Fig. 15).



3. Insert both, assembled, Mattress Support Tubes into the loops provided on the bottom of the Bassinet (Fig. 16).

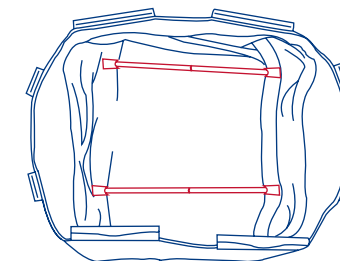

4. Place the Mattress into the Bassinet with the padded side facing upward (Fig. 17)

NOTE: Fasten tabs underneath the Mattress secure it in place.

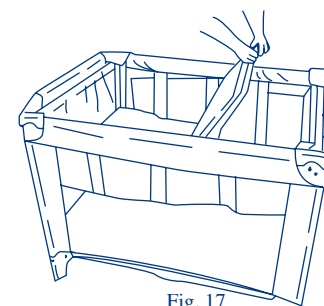

TO REMOVE BASSINET

1. Remove Mattress from Bassinet.
2. Remove Canopy.
3. Unsnap all clips and lift Bassinet.

PARENT ORGANIZER ASSEMBLY

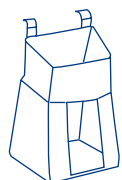

Diaper Stacker

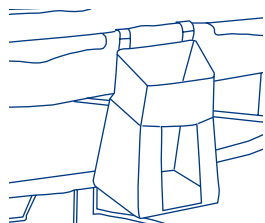

Fig. 18

Connect the Parent Organizer/Diaper Stacker to the Playard by sliding the two (2) connecting clips over an open portion of the top rail of the Playard. (Fig. 18)

NOTE: The Parent Organizer/Diaper Stacker can only be installed on open sides of the Playard where the connecting clips can easily be attached without interfering with other features.

MOBILE ASSEMBLY

ATTENTION:

A crib mobile is intended for visual stimulation and is not intended to be grasped by the child. If attached to the crib or playpen, remove when baby begins to push up on hands and knees. If so designed, mount on wall or ceiling clearly out of a standing baby's reach. Always attach all provided fasteners (strings, straps, clamps, etc.) tightly to a crib or playpen according to the instructions. Check frequently. DO NOT add additional strings and straps to attach to a crib or playpen. DO NOT attach the Mobile with child in Playard or Bassinet.

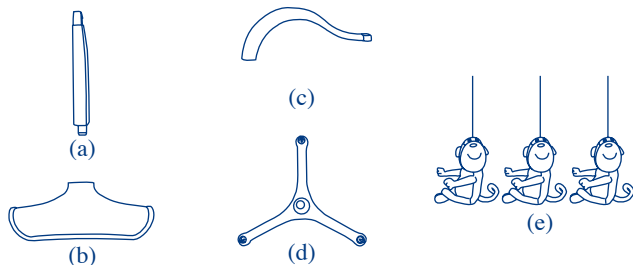

Contents:

- (a) 1 Mobile Lower Arm
- (b) 1 Mobile Arm Holder
- (c) 1 Mobile Upper Curved Arm
- (d) 1 Mobile Tri-shaped Arm
- (e) 3 Toys (toys may vary)

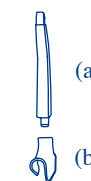

Fig. 19

1. Insert the Mobile Lower Arm (a) into the Mobile Arm Holder (b) until locked together (Fig. 19).

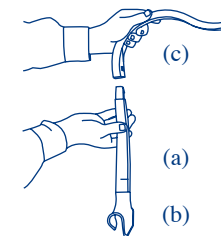

Fig. 20

2. Insert the Mobile Upper Curved Arm (c) into the Mobile Lower Arm (a, b) until locked together (Fig. 20).

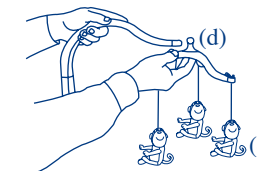

Fig. 21

3. Snap the Mobile Tri-shaped Arm (d) onto the end of the Upper Curved Arm (a, b, c) (Fig. 21). Connect each of the three Toys (e) to the Mobile by threading the string into the slot at the end of each arm.

4. Insert the bottom of the Mobile Arm into the frame of the Playard (Fig. 22).

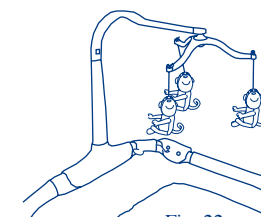

Fig. 22

Free Manuals Download Website

<http://myh66.com>

<http://usermanuals.us>

<http://www.somanuals.com>

<http://www.4manuals.cc>

<http://www.manual-lib.com>

<http://www.404manual.com>

<http://www.luxmanual.com>

<http://aubethermostatmanual.com>

Golf course search by state

<http://golfingnear.com>

Email search by domain

<http://emailbydomain.com>

Auto manuals search

<http://auto.somanuals.com>

TV manuals search

<http://tv.somanuals.com>