

1. Description

Aube's TH114 Series non-programmable thermostats can be used to control ambient or floor temperature. The following models are available:

- | | |
|-----------|-----------------------------------------------------------------------------------------------------------------------------------------------------|
| A model: | ▶ controls and displays the ambient temperature |
| F model: | ▶ controls and displays the floor temperature
▶ uses an external temperature sensor |
| AF model: | ▶ controls and displays the ambient temperature
▶ maintains the floor temperature within desired limits
▶ uses an external temperature sensor |

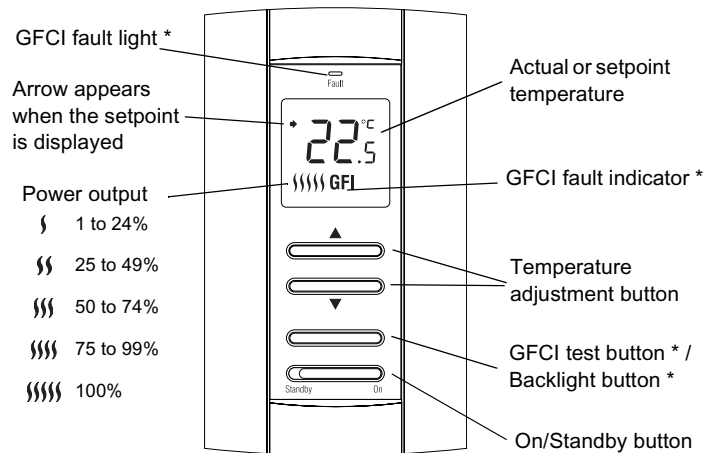

* available on certain models only

Each thermostat consists of a control module which must be mounted on a PB112 Series power base. For the selection and installation of the power base, refer to its installation instructions.

2. DIP Switch Configuration

The DIP switches are located at the back of the control module.

2.1 Temperature Display (S1)

To switch between °C and °F.

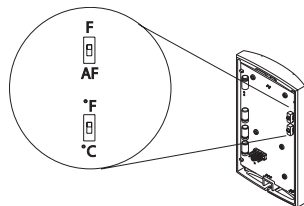

2.2 Model (S2)

Note: Available on certain models only

- F: To select the F model
- AF: To select the A or AF model

3. Installation

- 1 Refer to the installation instructions of the power base.
- 2 Insert the tabs at the top of the control module in the slots at the top of the power base.
- 3 Secure the control module using the captive screw underneath the base.

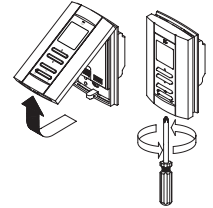

Note: Do not obstruct the thermostat's vents.

4. Power-up

As soon as the thermostat is powered, it undergoes a series of tests before displaying the actual temperature.



5. Error Messages



The measured temperature is below 0°C (32°F). Heating is turned On.



The measured temperature is above 50°C (122°F) (A or AF model) or 60°C (140°F) (F model).



The floor sensor is defective or not properly connected (F model only), or the thermostat is defective.

6. GFCI Test

Note: This procedure must be performed if the thermostat is mounted on a GFCI-equipped power base.

Test the GFCI immediately after installing the control module, and once a month thereafter.

- 1 Raise the temperature ▲ until the heating power indicator (|||||) appears.
- 2 Press the Test button.
- 3 If the test is successful, you will hear a click caused by the GFCI relay tripping. The heating power indicator will disappear, GFI will appear and the Fault light will illuminate. Reset the thermostat by switching it to Standby and back to On.
- 4 If the test has failed, cut power to the heating system from the main electrical panel and call customer service.

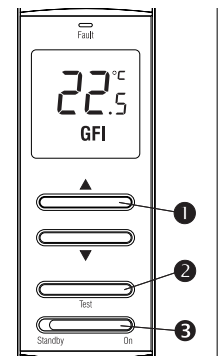

Note: If the Fault light is On during normal operation, cut power to heating system at the main electrical panel and have an electrician verify the installation.

7. Operation

7.1 Backlight

When either of the ▲▼ buttons is pressed, the display is lit for 10 seconds. The setpoint appears for 5 seconds, then the actual temperature is displayed.

When the backlight button is pressed, the display is lit for 5 seconds. **NOTE:** *If the thermostat is mounted on a GFCI-equipped power base, this button is used for the GFCI test.*

7.2 Displaying and Setting the Temperature

The thermostat normally displays the actual temperature. To view the setpoint, press once on one of the ▲▼ buttons. The setpoint is displayed for 5 seconds. During the setpoint display, press one of the ▲▼ buttons to change it. To scroll the setpoint faster, press and hold the button.

7.3 Setting the Floor Temperature Limits (AF model only)

The thermostat generally turns heating On or Off to control the ambient temperature. However, if the floor temperature drops below the set minimum floor temperature limit or rises above the maximum limit, the thermostat will turn heating On or Off respectively, regardless of the ambient temperature, to maintain the floor temperature within the desired limits.

The minimum and maximum floor temperature limits are factory-set at 10°C (50°F) and 28°C (82°F) respectively. To modify the limits, proceed as follows:



- 1 Switch the thermostat to Standby.
- 2 While pressing any button, switch the thermostat back to On to access the floor temperature limit settings.
- 3 Press the Test button briefly to switch between minimum and maximum floor temperature settings.
- 4 Press the ▲▼ buttons to set the desired limit.
- 5 Press the Test button for 3 seconds to save your modifications. After the data are saved, the thermostat displays the actual ambient temperature or “—”.

Note: Your modifications are also saved if no button is pressed for 60 seconds.

- 6 Switch the thermostat to Standby and back to On to reset the GFCI and return to the normal display.

8. Technical Specifications

Power supply: Refer to the power base installation instructions.

Ambient setpoint range (A/AF models): 5°C to 30°C (40°F - 86°F)

Floor limit range (AF model): 5°C to 40°C (40°F - 104°F)

Floor setpoint range (F model): 5°C to 40°C (40°F - 104°F)

Setpoint resolution: ± 0.5°C (1.0°F)

Display resolution: ± 0.5°C (1.0°F)

Duty cycle: Refer to the power base installation instructions.

Storage: -20°C to 50°C (-4°F - 120°F)

9. Warranty

AUBE TECHNOLOGIES INC. ONE (1) YEAR LIMITED WARRANTY

This product is guaranteed against workmanship defects for a one year period following the initial date of purchase. During this period, AUBE Technologies Inc. will repair or replace, at our option and without charge, any defective product which has been used under normal conditions.

The warranty does not cover delivery costs and does not apply to products poorly installed or randomly damaged following installation. This warranty cancels and replaces any other manufacturer's express or implied warranty as well as any other company commitment.

AUBE Technologies Inc. cannot be held liable for related or random damages following the installation of this product. The defective product as well as the purchase invoice must be returned to the place of purchase or mailed, prepaid and insured, to the following address.

10. Service

705 Montrichard
Saint-Jean-sur-Richelieu, Quebec
J2X 5K8
Canada

T: (450) 358-4600
1-800-831-AUBE (2823)
F: (450) 358-4650
service@aubetech.com

For more information on our products, visit us at:
www.aubetech.com

1 Applications

The PB112-024T-15S power base can be used on any TH11x series thermostat (with the exception of the TH110 model). This low-voltage power base operates on 15-second cycles and can be connected to a line-voltage load using a solid-state relay. The PB112-024T-15S is compatible with most solid-state relays; however, the following Aube relays are optimized for use with this power base:

- RT850 solid-state relay (SSR)
- RT850T solid-state relay (SSR) with built-in 24-V transformer

WARNING

This power base **MUST** be used **ONLY** with solid-state relays. The use of electromechanical relays will result in reduced life expectancy and in the possibility of overheating of these devices.

2 Supplied Parts

- 1 One (1) power base
- 2 Two (2) plastic anchors
- 2 Two (2) mounting screws

3 Installation Guidelines

- ▶ For a new installation, choose a location about 1.5 m (5 ft.) above the floor.
- ▶ The thermostat must be installed on an inside wall facing the heating system (except for floor heating systems).
- ▶ Avoid locations where there are air drafts (top of staircase, air outlet), dead air spots (behind a door), direct sunlight or concealed chimney or stove pipes (except for floor heating systems).

4 Installation Procedure

The installation must be carried out by an electrician and comply with local electrical codes.

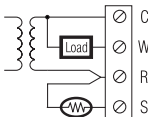
- 1 Turn off power to the heating system at the main electrical panel to avoid electrical shock.
- 2 Wire the base according to your application. See typical wiring diagrams in sections 4.1 and 4.2.
- 3 For a floor heating system installation, connect the floor sensor between the S and R terminals.
 
- 4 Secure the base to the wall using the provided screws and wall anchors.
- 5 Configure the switches located on the control module (if any). Refer to the user guide.

- 6 Install the control module onto the base.
- 7 Apply power to the heating system.
- 8 Verify the installation by checking that the heating system can be turned on or off using the thermostat.

4.1 Single SSR with Built-in Transformer

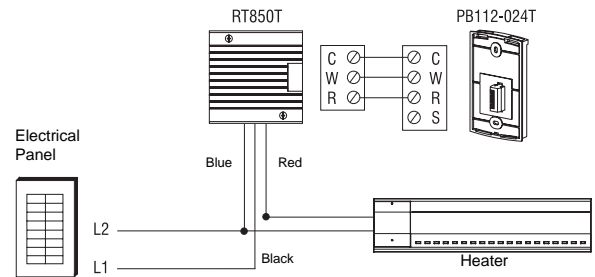

4.2 Multiple SSRs with External Transformer

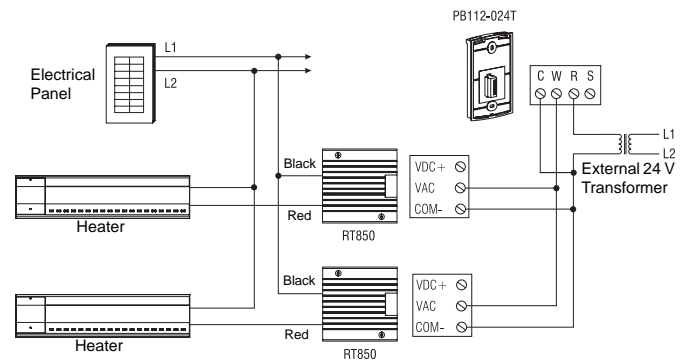

5 Technical Specifications

Maximum load: 0.5 A / 24 VAC

Heating cycle length: 15 seconds

Operating temperature: 32°F to 122°F (0°C to 50°C)

Storage: -4°F to 122°F (-20°C to 50°C)

Size (H • W • D): 124 x 70 x 23 mm (4.89 x 2.76 x 0.91 in)

Wire gauge: 14 to 22 AWG

Free Manuals Download Website

<http://myh66.com>

<http://usermanuals.us>

<http://www.somanuals.com>

<http://www.4manuals.cc>

<http://www.manual-lib.com>

<http://www.404manual.com>

<http://www.luxmanual.com>

<http://aubethermostatmanual.com>

Golf course search by state

<http://golfingnear.com>

Email search by domain

<http://emailbydomain.com>

Auto manuals search

<http://auto.somanuals.com>

TV manuals search

<http://tv.somanuals.com>