

I-See H171

17"

A05-17BM-F01



USER'S MANUAL

A05-17BM-F01_ME01

Federal Communications Commission (F.C.C.) Statement

This equipment has been tested and found to comply with the limits for a class B digital device, pursuant to Part 15 of the FCC rules. These limits are designed to provide reasonable protection against harmful interference in a residential installation. This equipment generates, uses and can radiate radio frequency energy and, if not installed and used in accordance with the instructions, may cause harmful interference to radio communications. However, there is no guarantee that interference will not occur in a particular installation. If this equipment does cause harmful interference to radio or television reception, which can be determined by turning the equipment off and on, the user is encouraged to try to correct the interference by one or more of the following measures:

- Relocate the receiving antenna.
- Increase the distance between the equipment and receiver.
- Connect the equipment into an outlet on a circuit different from that which the receiver is connected.
- Consult the dealer or an experienced radio/TV technician for help.

Use only shielded cables or connect I/O devices to this equipment.

You are cautioned that changes or modifications not expressly approved by the party responsible for compliance could void your authority to operate the equipment.

Copyright

This publication including all photographs, illustrations and software, is protected under international copyright laws, with all rights reserved. Neither this manual nor any of the material contained herein may be reproduced without the express written consent of the manufacturer.

Disclaimer

The information in this document is subject to change without notice. The manufacturer makes no representations or warranties with respect to the contents here of merchantability or fitness for any particular purpose. Further, the manufacturer reserves the right to revise this publication ad to make changes from time to time in the content hereof without obligation of the manufacturer to notify any person of such revision or changes.

Trademark Recognition

Microsoft, MS-DOS, and Windows are registered trademarks of Microsoft Corp. Intel, Pentium, and Pentium II are register trademarks of Intel Corporation. IBM, PC/AT, VGA, OS/2, and PS/2 are registered trademarks of international Business Machines. Macintosh II Family, LC, LCII, Quandra, and Power Macintosh are registered trademarks of Apply Computer, Inc. VESA is a registered trademark of the Video Electronics Standards Association. DPMS and DDC are trademarks of VESA. The ENERGY STAR name is a registered mark of the U.S. EnvironmentalProtection Agency. Other product names used in this manual are the properties of their respective owners and acknowledged.

TABLE OF CONTENTS

| | |
|--|-----------------------------------|
| IMPORTANT SAFETY INSTRUCTIONS | 2 |
| INTRODUCTION | 3 |
| Product Description | 3 |
| Package Overview | 3 |
| Installation of the Monitor Arm | 4 |
| Recommended Use of the Monitor | 5 |
| LCD Monitor Base Installation Guide | 6 |
| Guidelines for Operating the Viewing Angle of LCD Monitor | 7 |
| CONTROLS AND ADJUSTMENTS | 8 |
| Front User Controls. | 8 |
| OSD Directly Adjustment | 9 |
| Brightness | 9 |
| Contrast | 9 |
| Audio | 9 |
| OSD Main menu (VGA) | 9 |
| Volume | 9 |
| Auto-Tune | 10 |
| Color | 11 |
| Image | Clock/Phase/Image Position/Smooth |
| Language | 13 |
| Source | 13 |
| OSD Position | 13 |
| Reset | 13 |
| OSD Main menu (DVI) | 14 |
| Volume | 14 |
| Auto-Tune | 14 |
| Color | 15 |
| Image | Smooth |
| Language | 16 |
| Source | 16 |
| OSD Position | 16 |
| Reset | 16 |
| Energy Declaration | 17 |
| TROUBLESHOOTING | 18 |
| TECHNICAL INFORMATION | 19 |
| Compatibility | 19 |
| Pin Assignment | 19 |
| Preset Modes | 19 |
| Other Modes | 19 |
| Pin Assignment (DVI) | 20 |
| DVI Modes | 20 |
| Specification | 21 |

IMPORTANT SAFETY INSTRUCTIONS

Please read the following instructions carefully. This manual should be retained for future reference.

1. To clean the LCD Monitor screen make sure the Monitor is in the power off mode. Unplug the Monitor from its power source before cleaning it. Stand away from the LCD Monitor and spray cleaning solution onto a rag. Without applying excessive pressure clean the screen with the slightly dampened rag.
2. Do not place your LCD Monitor near a window. Exposing the Monitor to rain, water, moisture or sunlight can severely damage it.
3. Do not place anything on top of the Monitor/PC signal cord. Make sure the cord is placed in an area where it will not be stepped on.
4. Do not apply pressure to the LCD screen. Excessive pressure may cause permanent damage to the display.
5. Do not remove the cover or attempt to service this unit by yourself. You may void the warranty. Servicing of any nature should be performed only by an authorized technician.
6. Safe storage of the LCD Monitor is in a range of minus 20 to plus 60 degrees Celsius. Storing your LCD Monitor outside this range could result in permanent damage.
7. If any of the following occurs immediately unplug your Monitor and call an authorized technician.
 - The power or Monitor-to-PC signal cord is frayed or damaged.
 - Liquid has been spilled into the Monitor, or it has been exposed to rain.
 - The Monitor has been dropped or the case has been damaged.

Notice :

Actual safety specifications please refer to the label on the back of monitor.

INTRODUCTION

Product Description

Congratulations on purchasing this new generation monitor. Your LCD monitor incorporates high quality display into a small light-weight module. It has power-saving capabilities and emits no X-ray radiation.

The features are:

- 17" TFT Liquid Crystal Display
- Compatible with IBM VGA, VESA
- Direct RGB input
- Direct DVI input
- SXGA 1280x1024 resolution, up to 16M colors
- Lightweight compact design, weighting less than 6.6 Kgs
- DPMS (power saving) Compatible
- Built in universal power supply
- Anti-glare display
- On-Screen Display (OSD) controls and adjustments
- 1W x2 Audio function inside the monitor
- Audio volume adjustment by OSD

Package Overview

Your monitor package contains:

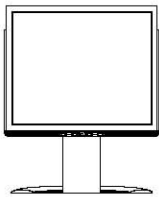

LCD Monitor

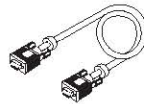

RGB Cable



Audio Cable

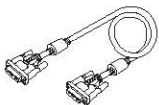

DVI Cable

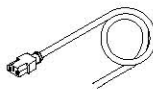

Power Cord



User's Manual

CAUTION

Keep the shipping carton in case the need arises to store or transport the unit. Let the LCD lie on its face when you put it into the carton.

INTRODUCTION

Installation of the Monitor Arm

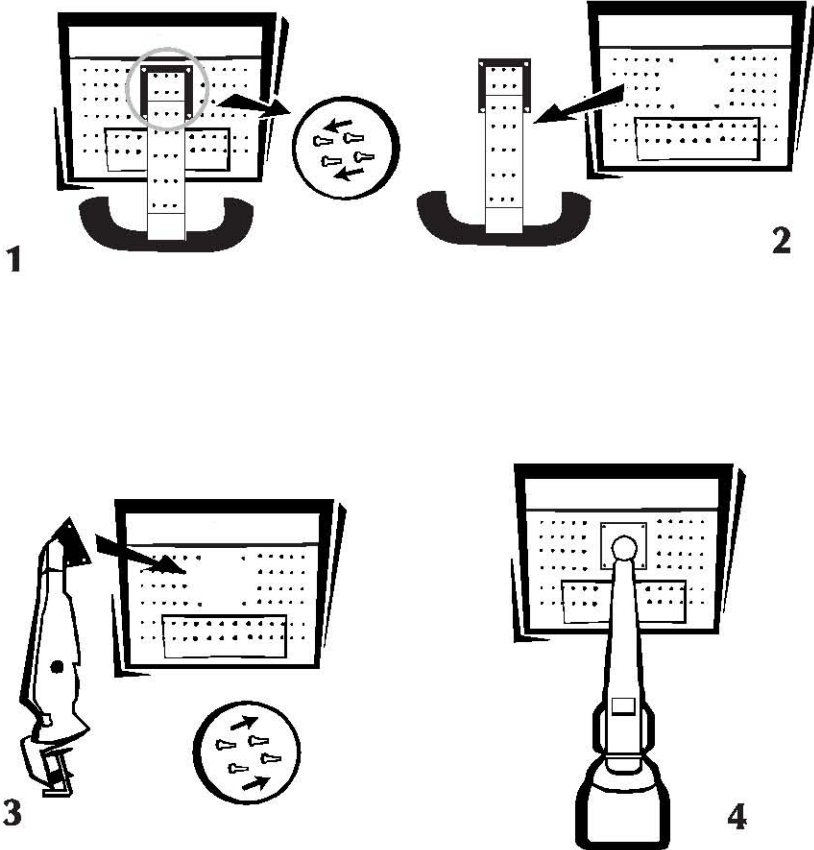

CAUTION

1. The Monitor Arm is an optional item.
2. The Arm Mounting Device must be VESA Flat Physical Mounting Interface Standard.
3. Please fix LCD monitor to monitor arm with 4x12mm screw.

INTRODUCTION

Recommended Use of the Monitor

- Power
 - Use the type of power indicated on the marking label.
- Plugs
 - Do not remove any of the prongs of the monitor's three-pronged power plug.
 - Disconnect the power plug from the AC outlet if you are not going to use it for an indefinite period of time.
- Power cords
 - Use the proper power cord with correct attachment plug type. If the power source is 120 VC, use a power cord that has UL and CSA approvals. If the power source is a 240 VAC supply, use the tandem (T blade) type attachment plug with ground conductor power cord that meets the respective European country's safety regulations, such as VDE for Germany.
 - We recommend using the power cord supplied with the product. However, if another type of power cord is required power cord H05VV-F or VW-1, 18AWG x 3G should be used.
 - Do not overload wall outlets or power cords. Ensure that the total of all units plugged into the wall outlet does not exceed 7 amperes.
 - Ensure that the total ampere ratings on all units plugged into the extension cord is not above the cord's rating.
 - If the power supply cord which came with your monitor is to be connected to the PC instead of the wall outlet, this equipment should be used with UL/TUV approved computers with receptacle rated 100 ~ 240V AC, 50/60Hz, 1.1A (minimum).
 - Do not allow anything to rest on the power cord. Do not locate this product where persons will walk on the cord.
- Environment
 - Place the monitor on a flat level surface.
 - Place the monitor in a well-ventilated place.
 - Keep the monitor away from:
 - rain or water
 - overly hot, cold or humid places
 - sunlight
 - dusty surroundings
 - equipment that generates strong magnetic fields

INTRODUCTION

LCD Monitor Base Installation Guide

1. First attach the back cover to the monitor. Carefully match up the three hinges at the top of the cover with the three corresponding slots; slide and lock into place.
2. Once the back cover is attached, you can rotate it down to a fully closed position.
3. Using a flathead screwdriver, insert the screws and tighten in the direction indicated.

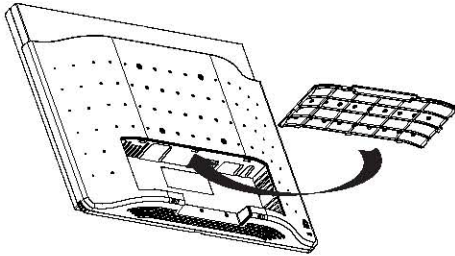

2. Once the back cover is attached, you can rotate it down to a fully closed position.

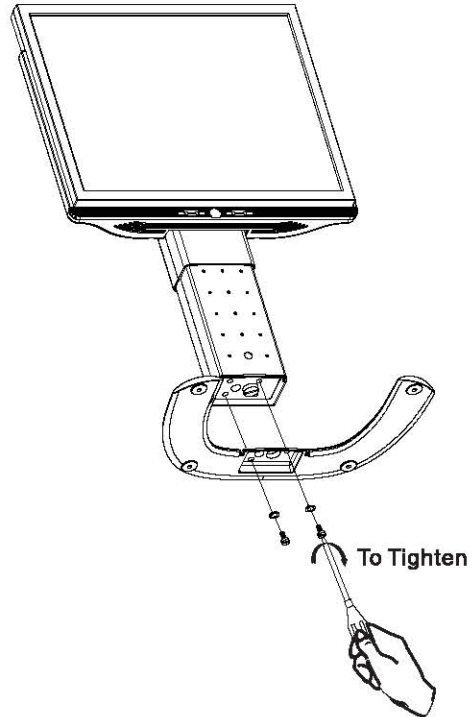
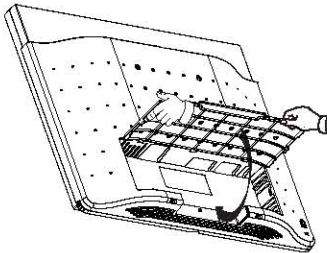

INTRODUCTION

Guidelines for Operating the Viewing Angle of LCD Monitor

1. Height Adjustment

You can adjust the height of the monitor by securely holding the base with one hand and pulling up the monitor stand with the other. The height of the monitor can be adjusted from 383.5mm to 502.5mm.

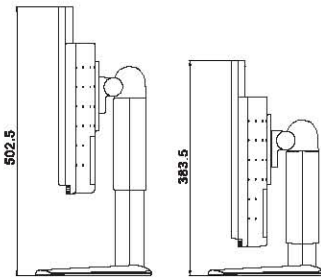

3. Rotate

The monitor screen can be swiveled left or right by holding the monitor support at the top, grabbing the edge of the screen and turning it to face 35 degrees left or right.

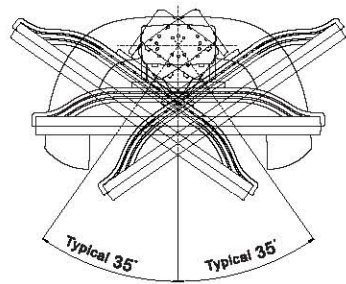

2. Backward/Forward Angle Adjustment

The vertical angle of the monitor can be adjusted 5 degrees forward and 35 degrees backward by holding the monitor support at the top and moving the monitor screen forward or backward from the bottom.

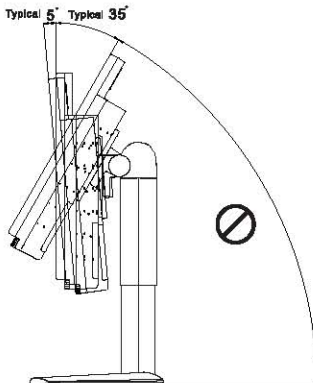

4. Pivoting

Grab the opposite corners and rotate the screen 90 degrees.

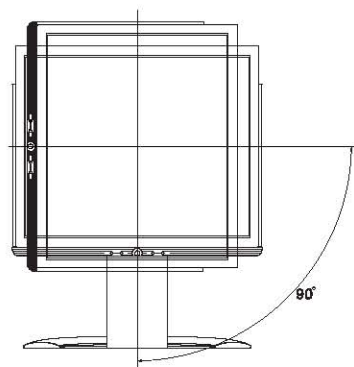

CONTROLS AND ADJUSTMENTS

Once you have installed this monitor with your system, please read the instructions in this section, they give you some guidelines on how to use the monitor more efficiently. And lead you through the various functions of the user controls and explain how to adjust the monitor to your personal preference.

Front User Controls

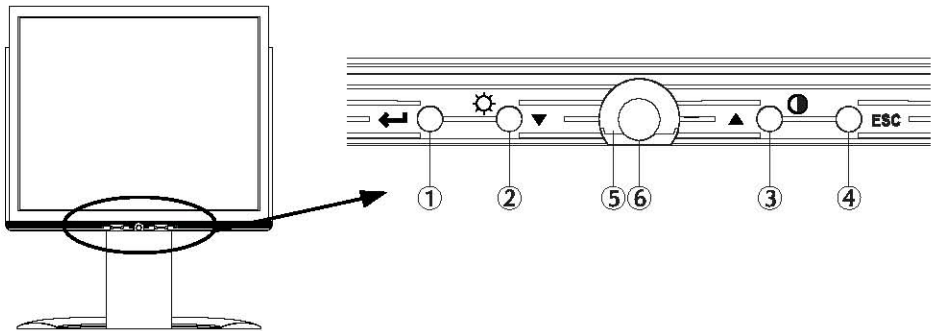

(1) Enter "↵" button

To display the OSD manual and select functions.

(2) Down "▼" button

To adjust the selected OSD function or the brightness directly.

(3) Up "▲" button

To adjust the selected OSD function or the contrast directly.

(4) "ESC" button

To close the OSD manual and to escape function or audio mute.

(5) Power LED Indicator

As long as the monitor is powered, this indicator is lit. In normal operation, it lights blue. While in power saving mode, the indicator will turn to amber.

(6) Power Switch

To turn the monitor On or Off.

CONTROLS AND ADJUSTMENTS

OSD Directly Adjustment

BRIGHTNESS

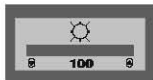

Press the "▼" button to enter the brightness, and press the "▼" or "▲" button to increase or decrease the brightness level, then press "ESC" button to exit.

CONTRAST

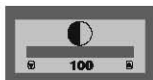

Press the "▲" button to enter the contrast, and press the "▼" or "▲" button to increase or decrease the contrast level, then press "ESC" button to exit.

AUDIO

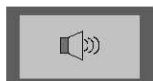

- **Normal Mode**

- Press the "ESC" button to enter sound playing mode in mute mode
- Press the "ESC" button to enter mute mode in sound playing mode.
- Press the "↓" to turn on the OSD main menu.



- **Power Saving Mode (when power indication lights amber)**

- Mute Hot Key (When playing music)

Press "ESC" to enter Mute Mode, and press "ESC" again to return to sound playing mode.

- Control the volume

In Power Saving Mode, press "▼" or "▲" to enter the volume tuning window, and press "▲" or "▼" key to adjust the volume. After 6 seconds, the volume tuning window will close automatically.

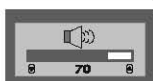

On Screen Display (OSD) Main menu (VGA)

- Press "↓" to open the OSD main menu.
- Use the "▼" and "▲" buttons to move through the displayed functions.
- Press "↓" to confirm your selected function.

1. Volume



Press "↓" to adjust volume and enter sound playing mode.



- Press "▼" or "▲" to adjust volume .
- Press "ESC" to leave this function.

CONTROLS AND ADJUSTMENTS

2. Auto-Tune



Here are some items which can be adjusted as below, please press "↓" to enter the item menu.



- Auto Geometry
Press "↓" button, the system will automatically adjust the clock, phase, H-position and V-position values for optimal settings.

ADVANCED AUTO TUNE PATTERN PROGRAM USAGE GUIDE

- AUTO_TUNE.exe is used for Windows the display mode adjustment. It will adjust the VGA input level and video quality to optimum.
- DOS_TUNE.exe is used for 720x400 70Hz & 640x 350 70Hz under DOS mode adjustment. It will adjust the video quality to optimum.
- For the adjustment, please execute the program, then select the "Auto Tune" function in the OSD menu, to get the optimum picture.



- Auto Color
Press "↓" button, the system will automatically adjust color balance for optimal setting.

ADVANCED AUTO TUNE PATTERN PROGRAM USAGE GUIDE

- As some VGA Cards do not match the VESA standard they cannot output 0.7 V p-p VESA standard. Therefore, you need the "ADVANCED AUTO TUNE PATTERN PROGRAM" to modify the parameters of the monitor to match the different output level of the VGA card.
- AUTO_TUNE.exe is used for Windows the display mode adjustment. It will adjust the VGA input level and video quality to optimum.
- For the adjustment, please execute the program, then select the "Auto Color" function in the OSD menu, to get the optimum picture.

CONTROLS AND ADJUSTMENTS

3. Color



You can choose either the 6500°k, 9300°K color temperature mode, User mode or Motion Picture to store your user defined color settings.



- User Mode
 - a. Press "↵" button to enter User mode.
 - b. Press the "▽" or "△" button to select the R/G/B gain , then press "↵" button to proceed.
 - c. Press "ESC" button to leave this function.



- Motion Picture Mode
 - Press "↵" button to enter Motion Picture mode.
 - a. Saturation:
 - Press the "▽" or "△" button to adjust Saturation.
 - b. Tint:
 - Press the "▽" or "△" button to adjust Tint.
 - c. Flesh Tone:
 - Press the "▽" or "△" button to adjust Flesh Tone.
 - d. Black Level:
 - Press the "▽" or "△" button to adjust Black Level.
 - e. Recall:
 - Press the "↵" button to recall factory default settings.

CONTROLS AND ADJUSTMENTS

4. Image



Here are some items which can be adjusted as below, please press "↵" to enter the item menu.



- **Clock:**
Press the "∇" or "Δ" button to adjust the width of the screen.



- **Phase:**
Press the "∇" or "Δ" button to reduce the noise on the screen.



- **Image Position**
- a. **H - Position:**
Press the "∇" or "Δ" button to reposition the Image to the right or left.



- b. **V - Position:**
Press the "∇" button to move the Image downwards and "Δ" to move it upwards.



- **Smooth:**
Press the "∇" or "Δ" button to adjust smooth. The "Smooth" function key will perform only under the resolution range 1280 x 1024.

CONTROLS AND ADJUSTMENTS

5. Language



Press the "▼" or "▲" button to select between English, German, French, Spanish or Italian languages.

6. Source



Press the "▼" or "▲" button to select "DVI" or "VGA".

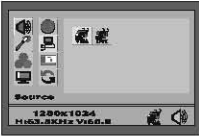

7. OSD Setting



To adjust the OSD position.

- **H - Position:**

Press the "▼" or "▲" button to reposition the OSD window to the right or left.

- **V - Position:**

Press the "▼" button to move the OSD window downwards and "▲" to move it upwards.

- **Center:**

The OSD window will be adjusted automatically to the center of the screen.

8. Reset



- Press the "▼" or "▲" button to select "Yes" or "No".

- Choose Reset to call-back all the settings for the current Input Signal mode to factory preset.

CONTROLS AND ADJUSTMENTS

On Screen Display (OSD) Main menu (DVI)

1. Press "↵" to open the OSD main menu.
2. Use the "▽" and "△" buttons to move through the displayed functions.
3. Press "↵" to confirm your selected function.

1. Volume



Press "↵" to adjust volume and enter sound playing mode.



- a. Press "▽" or "△" to adjust volume .
- b. Press "ESC " to leave this function.

2. Auto-Tune



Auto-Tune is disabled in DVI mode.

CONTROLS AND ADJUSTMENTS

3. Color



You can choose either the 6500°K, 9300°K color temperature mode, User mode or Motion Picture to store your user defined color settings.

- User Mode
 - a. Press "↓" button to enter User mode.
 - b. Press the "▽" or "△" button to select the R/G/B gain , then press "↓" button to proceed.
 - c. Press "ESC" button to leave this function.



- Motion Picture Mode
Press "↓" button to enter Motion Picture mode.



- a. Saturation:
Press the "▽" or "△" button to adjust Saturation.
- b. Tint:
Press the "▽" or "△" button to adjust Tint.
- c. Flesh Tone:
Press the "▽" or "△" button to adjust Flesh Tone.
- d. Black Level:
Press the "▽" or "△" button to adjust Black Level.
- e. Recall:
Press the "↓" button to recall factory default settings.

4. Image

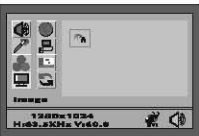

Press "↓" to enter the item menu.

- Smooth:
Press the "▽" or "△" button to adjust smooth. The "Smooth" function key will perform only under the resolution range 1280 x 1024.



CONTROLS AND ADJUSTMENTS

5. Language



Press the "▼" or "▲" button to select between English, German, French, Spanish or Italian languages.

6. Source



Press the "▼" or "▲" button to select "DVI" or "VGA".

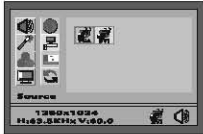

7. OSD Setting



To adjust the OSD position.

- **H - Position:**

Press the "▼" or "▲" button to reposition the OSD window to the right or left.

- **V - Position:**

Press the "▼" button to move the OSD window downwards and "▲" to move it upwards.

- **Center:**

The OSD window will be adjusted automatically to the center of the screen.



8. Reset



- Press the "▼" or "▲" button to select "Yes" or "No".
- Choose Reset to call-back all the settings for the current Input Signal mode to factory preset.

CONTROLS AND ADJUSTMENTS

Energy Declaration

This monitor is equipped with a function for saving energy, which supports the VESA Display Power Management Signaling (DPMS) standard. This means that the monitor must be connected to a computer. The time settings for switching to a power saving mode are adjusted from the system unit by software. From the first indication of inactivity to power saving position the total time must not be set to more than 70 minutes.

Power Consumption (120/230 Vac)

| NUTEK | VESA state | LED indicator | Power Consumption |
|------------------|------------|---------------|-------------------|
| Normal operation | On | Blue | ≤39W |
| Power Saving | Off | Amber | ≤2W * |
| Power Switch Off | Off | Off | ≤1W |

* Audio mute mode

This display unit is an electronic product and may contain substances or materials that require end-of-life processing by a designated organization or agency.

TROUBLESHOOTING

Troubleshooting

If you are experiencing trouble with the LCD display refer to the following. If the problem persists please contact your local dealer or our service center.

The monitor does not respond after you turn on the system.

- Check if the monitor is turned on.
- Turn off the power and check the monitor power cord and signal cable are properly connected.

The characters on the screen are dim.

- Refer to the Controls and Adjustments section to adjust the brightness (BRIGHTNESS on the OSD sub-menu.)

The screen is blank.

- During use the monitor screen may automatically turn off as a result of the Power Saving feature. Press any key to see if the screen comes back.
- Refer to the Controls and Adjustments section to adjust the brightness (BRIGHTNESS on the OSD sub-menu.)

The screen flashes when it initializes.

- Turn off the monitor and turn it on again.
- Refer to the Controls and Adjustments section to reload the default setting (RESET on the OSD main-menu.)

Partial image or incorrectly displayed image

- Check to see if the resolution of your computer is higher than that of the LCD display
- Reconfigure the resolution of your computer to make it less than or equal to 1280x1024 or to make sure refresh rate is under 75Hz.

Image has vertical flickering line bars

- Use "Clock" to make an adjustment
- Check and reconfigure the display mode of the vertical refresh rate of your graphic card to make it compatible with the LCD display

Image is unstable and flickering

- Use "Phase" to make an adjustment.

Signal out of Range:

- When the input signal is outside the normal specifications the screen will display a "Signal out of Range" message.

No Signal Input:

- The "No Signal Input" message indicates that the cable may not be plugged properly into the host system.

WARNING

Do not disassemble the monitor. Contact your dealer if needed.

TECHNICAL INFORMATION

Compatibility

This LCD monitor supports multiple operating platforms such as IBM compatible computers. This section provides you with detailed information on pin assignment of the D-Sub connector and the preset timing chart of the prevailing video standards.

Pin Assignment

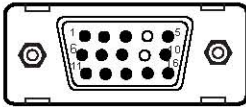

Male Mini D-15 Connector

| Signal | 15 Pin Mini D-Sub |
|-----------------|-------------------|
| Red Video | 1 |
| Green Video | 2 |
| Blue Video | 3 |
| Horizontal Sync | 13 |
| Vertical Sync | 14 |
| Ground | 5,6,7,8,10,11 |
| No Connection | 4 |
| SDA (DDC) | 12 |
| SCL (DDC) | 15 |
| +5V (DDC) | 9 |

Preset Modes

| Resolution | VCLK(MHz) | Horizontal Frequency(KHz) | Vertical Frequency(Hz) | Standard |
|------------|-----------|---------------------------|------------------------|----------|
| 720*400 | 28.322 | 31.469 | 70.000 | IBM VGA |
| 640*480 | 25.175 | 31.469 | 59.940 | IBM VGA |
| 640*480 | 31.500 | 37.861 | 72.000 | VESA |
| 640*480 | 31.500 | 37.500 | 75.000 | VESA |
| 800*600 | 40.000 | 37.879 | 60.317 | VESA |
| 800*600 | 50.000 | 48.077 | 72.188 | VESA |
| 800*600 | 49.500 | 46.875 | 75.000 | VESA |
| 1024*768 | 65.000 | 48.363 | 60.000 | VESA |
| 1024*768 | 75.000 | 56.746 | 70.069 | VESA |
| 1024*768 | 78.750 | 60.023 | 75.029 | VESA |
| 1152*864 | 108.000 | 67.500 | 75.000 | VESA |
| 1280*1024 | 108.000 | 63.981 | 60.000 | VESA |
| 1280*1024 | 135.000 | 79.976 | 75.000 | VESA |

Other Modes

| | |
|-----------|-----------------------------|
| 640*350 | @70 Hz |
| 640*480 | @70 Hz |
| 800*600 | @70 Hz |
| 1024*768 | @72 Hz |
| 1152*864 | @60 Hz, 70 Hz, 72 Hz |
| 1280*720 | @60 Hz |
| 1280*960 | @60 Hz, 70 Hz, 72 Hz, 75 Hz |
| 1280*1024 | @72 Hz |
| 1280*1024 | @70 Hz |

TECHNICAL INFORMATION

Pin Assignment (DVI)

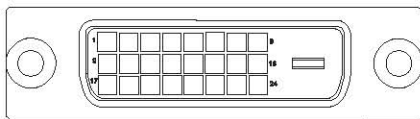

DVI Connector

| Pin | Signal Assignment | Pin | Signal Assignment | Pin | Signal Assignment |
|-----|--------------------------|-----|--------------------------|-----|--------------------------|
| 1 | T.M.D.S. Data 2- | 9 | T.M.D.S. Data 1- | 17 | T.M.D.S. Data 0- |
| 2 | T.M.D.S. Data 2+ | 10 | T.M.D.S. Data 1+ | 18 | T.M.D.S. Data0+ |
| 3 | T.M.D.S. Data 2/4 Shield | 11 | T.M.D.S. Data 1/3 Shield | 19 | T.M.D.S. Data 0/5 Shield |
| 4 | T.M.D.S. NC | 12 | T.M.D.S. NC | 20 | T.M.D.S. NC |
| 5 | T.M.D.S. NC | 13 | T.M.D.S. NC | 21 | T.M.D.S. NC |
| 6 | DDC Clock | 14 | +5V Power | 22 | T.M.D.S. Clock Shield |
| 7 | DDC Data | 15 | Ground (for +5V) | 23 | T.M.D.S. Clock+ |
| 8 | No Connect | 16 | Hot Plug Detect | 24 | T.M.D.S. Clock- |

DVI Modes

| Resolution | VCLK(MHz) | Horizontal Frequency(KHz) | Vertical Frequency(Hz) | Standard |
|------------|-----------|---------------------------|------------------------|----------|
| 640*480 | 25.175 | 31.469 | 59.940 | IBM VGA |
| 800*600 | 40.000 | 37.879 | 60.000 | VESA |
| 1024*768 | 65.000 | 48.363 | 60.000 | VESA |
| 1280*1024 | 108.000 | 63.981 | 60.000 | VESA |

TECHNICAL INFORMATION

Specifications

| | |
|---------------------------------|--|
| LCD Panel | 17" TFT LCD module with wide-viewing angle, 0.264 (H)x0.264(V)mm pixel |
| [Monitor] | |
| Effective display size | 17" (43.2cm diagonal) |
| Resolution (max.) | SXGA 1280x1024 |
| Displayable colors | 16M True color |
| Brightness | 260 cd/m ² (typical) |
| Contrast ratio | 500:1 |
| Response time | 16ms |
| Scan Frequency(D-15) | Horizontal: 30 to 80kHz Vertical: 59 to 75 Hz |
| Scan Frequency(DVI) | Horizontal: 30 to 66kHz Vertical: 59 to 61 Hz |
| Audio Input | 1V(RMS). typical |
| Audio Output | 1W x 2 |
| User controls | Power/Enter/Up/Down/Escape/Volume |
| Power Consumption | ≤39W ≤2W Power Saving (Audio mute mode) ≤1W Power switch off |
| Input signal D-15 | Analog 0.7V peak to peak separate TTL Positive or Negative |
| Input signal DVI | DVI Rev.1 TMDS 165MHz 1-channel |
| Power Supply | 100 ~ 240V, 50/60Hz (automatically) |
| Plug & Play | DDC 2B+ |
| [Dimension & Weight] | |
| Size (WxDxH) | 379.5x197.5x383.5 (smallest) /502.5 (greatest) mm |
| Weight (net) | 6.6 Kgs |
| [Operating Environment] | |
| Temperature | 5°C ~ 35°C |
| Humidity | 20% ~ 80% (non-condensing) |
| [Storage Environment] | |
| Temperature | -20°C ~ 60°C |
| Humidity | 10% ~ 90% (non-condensing) |

Note : Specifications are subject to change without notice

Free Manuals Download Website

<http://myh66.com>

<http://usermanuals.us>

<http://www.somanuals.com>

<http://www.4manuals.cc>

<http://www.manual-lib.com>

<http://www.404manual.com>

<http://www.luxmanual.com>

<http://aubethermostatmanual.com>

Golf course search by state

<http://golfingnear.com>

Email search by domain

<http://emailbydomain.com>

Auto manuals search

<http://auto.somanuals.com>

TV manuals search

<http://tv.somanuals.com>