

**ASUS<sup>®</sup> TX97-LE**  
Pentium<sup>®</sup> Motherboard

**USER'S MANUAL**

# USER'S NOTICE

---

No part of this manual, including the products and software described in it, may be reproduced, transmitted, transcribed, stored in a retrieval system, or translated into any language in any form or by any means, except documentation kept by the purchaser for backup purposes, without the express written permission of ASUSTeK COMPUTER INC. ("ASUS").

ASUS PROVIDES THIS MANUAL "AS IS" WITHOUT WARRANTY OF ANY KIND, EITHER EXPRESS OR IMPLIED, INCLUDING BUT NOT LIMITED TO THE IMPLIED WARRANTIES OR CONDITIONS OF MERCHANTABILITY OR FITNESS FOR A PARTICULAR PURPOSE. IN NO EVENT SHALL ASUS, ITS DIRECTORS, OFFICERS, EMPLOYEES OR AGENTS BE LIABLE FOR ANY INDIRECT, SPECIAL, INCIDENTAL, OR CONSEQUENTIAL DAMAGES (INCLUDING DAMAGES FOR LOSS OF PROFITS, LOSS OF BUSINESS, LOSS OF USE OR DATA, INTERRUPTION OF BUSINESS AND THE LIKE), EVEN IF ASUS HAS BEEN ADVISED OF THE POSSIBILITY OF SUCH DAMAGES ARISING FROM ANY DEFECT OR ERROR IN THIS MANUAL OR PRODUCT.

Product warranty or service will not be extended if: (1) the product is repaired, modified or altered, unless such repair, modification or alteration is authorized in writing by ASUS; or (2) the serial number of the product is defaced or missing.

Products and corporate names appearing in this manual may or may not be registered trademarks or copyrights of their respective companies, and are used only for identification or explanation and to the owners' benefit, without intent to infringe.

- Intel, LANDesk, and Pentium are registered trademarks of Intel Corporation.
- IBM and OS/2 are registered trademarks of International Business Machines.
- Symbios is a registered trademark of Symbios Logic Corporation.
- Windows and MS-DOS are registered trademarks of Microsoft Corporation.
- Sound Blaster AWE32 and SB16 are trademarks of Creative Technology Ltd.
- Adobe and Acrobat are registered trademarks of Adobe Systems Incorporated.

The product name and revision number are both printed on the product itself. Manual revisions are released for each product design represented by the digit before and after the period of the manual revision number. Manual updates are represented by the third digit in the manual revision number.

For previous or updated manuals, BIOS, drivers, or product release information, contact ASUS at <http://www.asus.com.tw> or through any of the means indicated on the following page.

SPECIFICATIONS AND INFORMATION CONTAINED IN THIS MANUAL ARE FURNISHED FOR INFORMATIONAL USE ONLY, AND ARE SUBJECT TO CHANGE AT ANY TIME WITHOUT NOTICE, AND SHOULD NOT BE CONSTRUED AS A COMMITMENT BY ASUS. ASUS ASSUMES NO RESPONSIBILITY OR LIABILITY FOR ANY ERRORS OR INACCURACIES THAT MAY APPEAR IN THIS MANUAL, INCLUDING THE PRODUCTS AND SOFTWARE DESCRIBED IN IT.

**Copyright © 1998 ASUSTeK COMPUTER INC. All Rights Reserved.**

Product Name:	<b>ASUS TX97-LE</b>
Manual Revision:	<b>1.00</b>
Release Date:	<b>January 1998</b>

# ASUS CONTACT INFORMATION

---

## ASUSTeK COMPUTER INC.

### *Marketing Info*

Address: 150 Li-Te Road, Peitou, Taipei, Taiwan 112, ROC  
Telephone: +886-2-2894-3447  
Fax: +886-2-2894-3449  
Email: info@asus.com.tw

### *Technical Support*

Fax: +886-2-2895-9254  
BBS: +886-2-2896-4667  
Email: tsd@asus.com.tw  
WWW: www.asus.com.tw  
Gopher: gopher.asus.com.tw  
FTP: ftp.asus.com.tw/pub/ASUS

## ASUS COMPUTER INTERNATIONAL

### *Marketing Info*

Address: 721 Charcot Avenue, San Jose, CA 95131, USA  
Telephone: +1-408-474-0567  
Fax: +1-408-474-0568  
Email: info-usa@asus.com.tw

### *Technical Support*

BBS: +1-408-474-0569  
Email: tsd-usa@asus.com.tw  
WWW: www.asus.com

## ASUS COMPUTER GmbH

### *Marketing Info*

Address: Harkort Str. 25, 40880 Ratingen, BRD, Germany  
Telephone: 49-2102-445011  
Fax: 49-2102-442066  
Email: info-ger@asus.com.tw

### *Technical Support*

BBS: 49-2102-448690  
Email: tsd-ger@asus.com.tw  
Hotline: 49-2102-499712

# CONTENTS

---

<b>I. INTRODUCTION .....</b>	<b>7</b>
How this manual is organized .....	7
Item Checklist .....	7
<b>II. FEATURES .....</b>	<b>8</b>
Features of the ASUS TX97-LE Motherboard .....	8
Introduction to ASUS Smart Series of motherboards .....	9
Parts of the ASUS TX97-LE Motherboard .....	11
<b>III. INSTALLATION .....</b>	<b>12</b>
ASUS TX97-LE Motherboard Layout .....	12
Installation Steps .....	14
1. Jumpers .....	14
Jumper Settings .....	15
Compatible Cyrix CPU Identification .....	18
2. System Memory (SIMM & DIMM) .....	19
SIMM Memory Installation .....	20
DIMM Memory Installation .....	21
3. Central Processing Unit (CPU) .....	22
4. Expansion Cards .....	23
.....	23
Expansion Card Installation Procedure: .....	23
Assigning IRQs for Expansion Cards .....	23
Assigning DMA Channels for ISA Cards .....	24
ISA Cards and Hardware Monitor .....	24
5. External Connectors .....	25
Power Connection Procedures .....	33
<b>IV. BIOS SOFTWARE .....</b>	<b>34</b>
Support Software .....	34
Flash Memory Writer Utility .....	34
Main Menu .....	34
Advanced Features Menu .....	35
Managing & Updating your Motherboard's BIOS .....	36
6. BIOS Setup .....	37
Load Defaults .....	38
Standard CMOS Setup .....	38
Details of Standard CMOS Setup .....	38
BIOS Features Setup .....	41
Details of BIOS Features Setup .....	41
Chipset Features Setup .....	43
Details of Chipset Features Setup .....	43

# CONTENTS

---

Power Management Setup .....	46
Details of Power Management Setup .....	46
PNP and PCI Setup .....	48
Details of PNP and PCI Setup .....	49
Load BIOS Defaults .....	50
Load Setup Defaults .....	50
Supervisor Password and User Password .....	51
IDE HDD Auto Detection .....	52
Save & Exit Setup .....	53
Exit Without Saving .....	53
ASUS Smart Motherboard Support CD 3.10 .....	55
Desktop Management Interface (DMI) .....	56
Introducing the ASUS DMI Configuration Utility .....	56
System Requirements .....	56
Using the ASUS DMI Configuration Utility .....	57
<b>VI. ASUS PCI SCSI Cards .....</b>	<b>59</b>
Symbios SCSI BIOS and Drivers .....	59
ASUS PCI-SC200 & PCI-SC860 SCSI Cards .....	59
Setting Up the ASUS PCI-SC200 & PCI-SC860 .....	60
Setting the INT Assignment for the ASUS PCI-SC200 .....	60
Terminator Requirements for SCSI Devices .....	60
Terminator Settings for the ASUS PCI-SC860 .....	61
Terminator Settings for the ASUS PCI-SC200 .....	61
SCSI ID Numbers for SCSI Devices .....	62
SCSI ID Priority .....	62
<b>VII. ASUS LAN Card .....</b>	<b>63</b>
ASUS PCI-L101 Fast Ethernet Card .....	63
Features .....	64
Software Driver Support .....	64
Question and Answer .....	64

# FCC & DOC COMPLIANCE

---

## ***Federal Communications Commission Statement***

This device complies with FCC Rules Part 15. Operation is subject to the following two conditions:

- This device may not cause harmful interference, and
- This device must accept any interference received, including interference that may cause undesired operation.

This equipment has been tested and found to comply with the limits for a Class B digital device, pursuant to Part 15 of the FCC Rules. These limits are designed to provide reasonable protection against harmful interference in a residential installation. This equipment generates, uses and can radiate radio frequency energy and, if not installed and used in accordance with manufacturer's instructions, may cause harmful interference to radio communications. However, there is no guarantee that interference will not occur in a particular installation. If this equipment does cause harmful interference to radio or television reception, which can be determined by turning the equipment off and on, the user is encouraged to try to correct the interference by one or more of the following measures:

- Re-orient or relocate the receiving antenna.
- Increase the separation between the equipment and receiver.
- Connect the equipment to an outlet on a circuit different from that to which the receiver is connected.
- Consult the dealer or an experienced radio/TV technician for help.

**WARNING!** The use of shielded cables for connection of the monitor to the graphics card is required to assure compliance with FCC regulations. Changes or modifications to this unit not expressly approved by the party responsible for compliance could void the user's authority to operate this equipment.

## ***Canadian Department of Communications Statement***

This digital apparatus does not exceed the Class B limits for radio noise emissions from digital apparatus set out in the Radio Interference Regulations of the Canadian Department of Communications.

# I. INTRODUCTION

---

## How this manual is organized

This manual is divided into the following sections:

- I. Introduction:** Manual information and checklist
- II. Features:** Information and specifications concerning this product
- III. Installation:** Instructions on setting up the motherboard
- IV. BIOS Software:** Instructions on setting up the BIOS software
- V. Support Software:** Information on the included support software
- VI. ASUS SCSI Cards:** Installation of ASUS SCSI cards (optional)
- VII. ASUS L101 Card:** Installation of the ASUS LAN card (optional)

## Item Checklist

Please check that your package is complete. If you discover damaged or missing items, please contact your retailer.

- (1) ASUS Motherboard
- (1) 9pin male serial + 25pin male serial external connector set
- (1) 25pin female parallel + 6pin female PS/2 mouse external connector set
- (1) IDE ribbon cable for master and slave drives
- (1) Floppy ribbon cable for (1) 5.25inch floppy and (2) 3.5inch floppies
- (1) bag of spare jumpers
- (1) diskette or CD with support drivers and utilities:
  - Flash Memory Writer utility to update the onboard programmable BIOS
  - Desktop Management Interface (DMI) utility
  - LANdesk Client Manager (LDCM) Software (with optional onboard LM78)
  - Readme files for descriptions and use of the files
  - Technical Support Form
- (1) User's Manual
- PS/2 Mouse, Infrared, USB1, and USB2 external connector module (optional)
- ASUS PCI-SC200 Fast-SCSI or PCI-SC860 Ultra-Fast SCSI card (optional)
- ASUS PCI-L101 Wake-on-LAN 10/100 Ethernet Card (optional)



## II. FEATURES

---

### Features of the ASUS TX97-LE Motherboard

The ASUS TX97-LE is carefully designed for the demanding PC user who wants many intelligent features in a small package. This motherboard:

- **Intel Chipset:** Features Intel's 430TX PCIset with I/O subsystems.
- **Multi-Processor/Multi-Speed Support:** Intel Pentium® 75–233MHz (P55C-MMX™, P54C/P54CS), IBM®/Cyrix® 6x86-PR166+ (Rev 2.7 or later), IBM®/Cyrix® 6x86MX™ (PR166 & faster), AMD-K5™ (PR75–PR133), AMD-K6™ (PR166 & faster).
- **Versatile Memory Support:** Is equipped with two DIMM sockets to support 8-256MB 168-pin 3.3Volt SDRAM/EDO memory modules up to 256MB. Is also equipped with four SIMM sockets to support 4-64MB 72-pin Fast Page Mode (FPM) or Extended Data Out (EDO) memory modules up to 256MB. SIMMs and DIMMs cannot be used at the same time.
- **Easy Installation:** Is equipped with BIOS that supports auto detection of hard drives, PS/2 mouse, and Plug and Play devices to make setup of hard drives, expansion cards, and other devices virtually automatic.
- **Dual Power Supply:** Has both AT and ATX power connectors onboard to support an AT or ATX power supply with soft-on/off features.
- **ISA and PCI Expansion Slots:** Provides three 16-bit ISA slots and four 32-bit PCI slots.
- **Super Multi-I/O:** Provides two high-speed UART compatible serial ports and one parallel port with EPP and ECP capabilities. UART2 can also be directed from COM2 to the Infrared Module for wireless connections.
- **Desktop Management Interface (DMI):** Supports DMI through BIOS which allows hardware to communicate within a standard protocol creating a higher level of compatibility. (Requires DMI-enabled components.) (See section V)
- **PCI Bus Master IDE Controller:** Comes with an onboard PCI Bus Master IDE controller with two connectors that supports four IDE devices in two channels, supports PIO Modes 3 and 4 and Bus Master IDE DMA Mode 2, and supports Enhanced IDE devices such as Tape Backup and CD-ROM drives. Supports two drives of either 5.25-inch (360KB or 1.2MB) or 3.5-inch (720KB, 1.44MB, or 2.88MB) disk drives. Supports Japanese "Floppy 3 mode" (3.5-inch disk drive: 1.2MB) and LS-120 floppy disk drives (3.5-inch disk drive: 120 MB, 1.44MB, 720K). BIOS supports IDE CD-ROM or SCSI device boot-up.
- **Level 2 Cache:** 512KB Pipelined Burst SRAM onboard.
- **Optional PS/2 Mouse, USB, IrDA Connector:** Supports an optional cable and bracket set to mount the connectors to an unused expansion slot on the system chassis. A second IrDA connector is available for a standard individual infrared cable set.
- **Symbios SCSI BIOS:** Supports optional ASUS SCSI controller cards through onboard firmware.
- **Wake on LAN:** Supports Wake on LAN activity through optional ASUS PCI-L101 Fast Ethernet card.



# II. FEATURES

---

## *Introduction to ASUS Smart Series of motherboards*

### **Performance**

- **SDRAM Optimized Performance** - ASUS TX97 series of motherboards support the new generation memory - Synchronous Dynamic Random Access Memory (SDRAM) which increases the data transfer rate from 264MB/s max using EDO memory to 528MB/s max using SDRAM.
- **Double the IDE Transfer Speed** - ASUS TX97 series of motherboards with Intel 430TX PCIset improves IDE transfer rate using Bus Master UltraDMA/33 IDE which can handle data transfer up to 33MB/s. The best of all is that this new technology is compatible with existing ATA-2 IDE specs so there is no need to upgrade current hard drives or cables.
- **Concurrent PCI** - Concurrent PCI allows multiple PCI transfers from PCI master busses to memory to CPU.
- **ACPI Ready** - ACPI (Advanced Configuration and Power Interface) is also implemented on all ASUS 430TX series of motherboards. ACPI provide more Energy Saving Features for the future operating systems (OS) supporting OS Direct Power Management (OSPM) functionality. With these features implemented in the OS, PCs can be ready around the clock everyday, yet satisfy all the energy saving standards. To fully utilize the benefits of ACPI, an ACPI-supported OS such as in the next release of Windows 95 must be used.
- **PC '97 Compliant** - Both the BIOS and hardware levels of ASUS TX97 series of motherboards meet PC '97 compliancy. The new PC 97 requirements for systems and components are based on the following high-level goals: Support for Plug and Play compatibility and power management for configuring and managing all system components, and 32-bit device drivers and installation procedures for both Windows 95 and Windows NT.

### **Intelligence: (with optional LM78/75 Hardware Monitor only)**

- **Fan Status Monitoring and Alarm** - To prevent system overheat and system damage, the CPU fan and system fans are monitored for RPM and failure. Each fan can be set for its normal RPM range and alarm thresholds.
- **Temperature Monitoring and Alert** - To prevent system overheat and system damage, there is a heat sensor under the CPU and on the motherboard itself to monitor CPU and system temperature to make sure the system is operating at a safe heat level to avoid any failures triggered by extremely high temperature.

## II. FEATURES

---

- **Voltage Monitoring and Alert** - System voltage levels are monitored to ensure stable current to critical motherboard components. Voltage specifications are more critical for future processors, so monitoring is necessary to ensure proper system configuration and management.
- **System Resources Alert** - Today's operating systems such as Windows 95, Windows NT, and OS/2, require much more memory and hard drive space to present enormous user interfaces and run large applications. The system resource monitor will warn the user before the system resources are used up to prevent possible application crashes. Suggestions will give the user information on managing their limited resources more efficiently.
- **CPU Slow Down** - When CPU fans or system fans are malfunctioning, the system will deactivate the CPU Clock line to decrease CPU utilization to the speed upon detection of system overheat. This will prevent CPU damage from system overheat. The CPU utilization will restore normal operations when temperature falls below a safe level.
- **Auto Fan Off** - The system fans will power off automatically **even in sleep mode**. This function reduces both energy consumption *and* **system noise**, and is an important feature to implement silent PC systems.
- **Dual Function Power Button (requires ATX power supply)** - The system can be in one of two states, one is Sleep mode and the other is the Soft-Off mode. Pushing the power button for less than 4 seconds places the system into Sleep mode. When the power button is pressed for more than 4 seconds, it enters the Soft-Off mode.
- **Remote Ring On (requires ATX power supply)** - This allows a computer to be turned on remotely through a modem. With this benefit on-hand, any user can access vital information from their computer from anywhere in the world!
- **Message LED** - Chassis LEDs now act as information providers. Through the way a particular LED illuminates, the user can determine the stage the computer is in. A simple glimpse provides useful information to the user.

# II. FEATURES

## Parts of the ASUS TX97-LE Motherboard

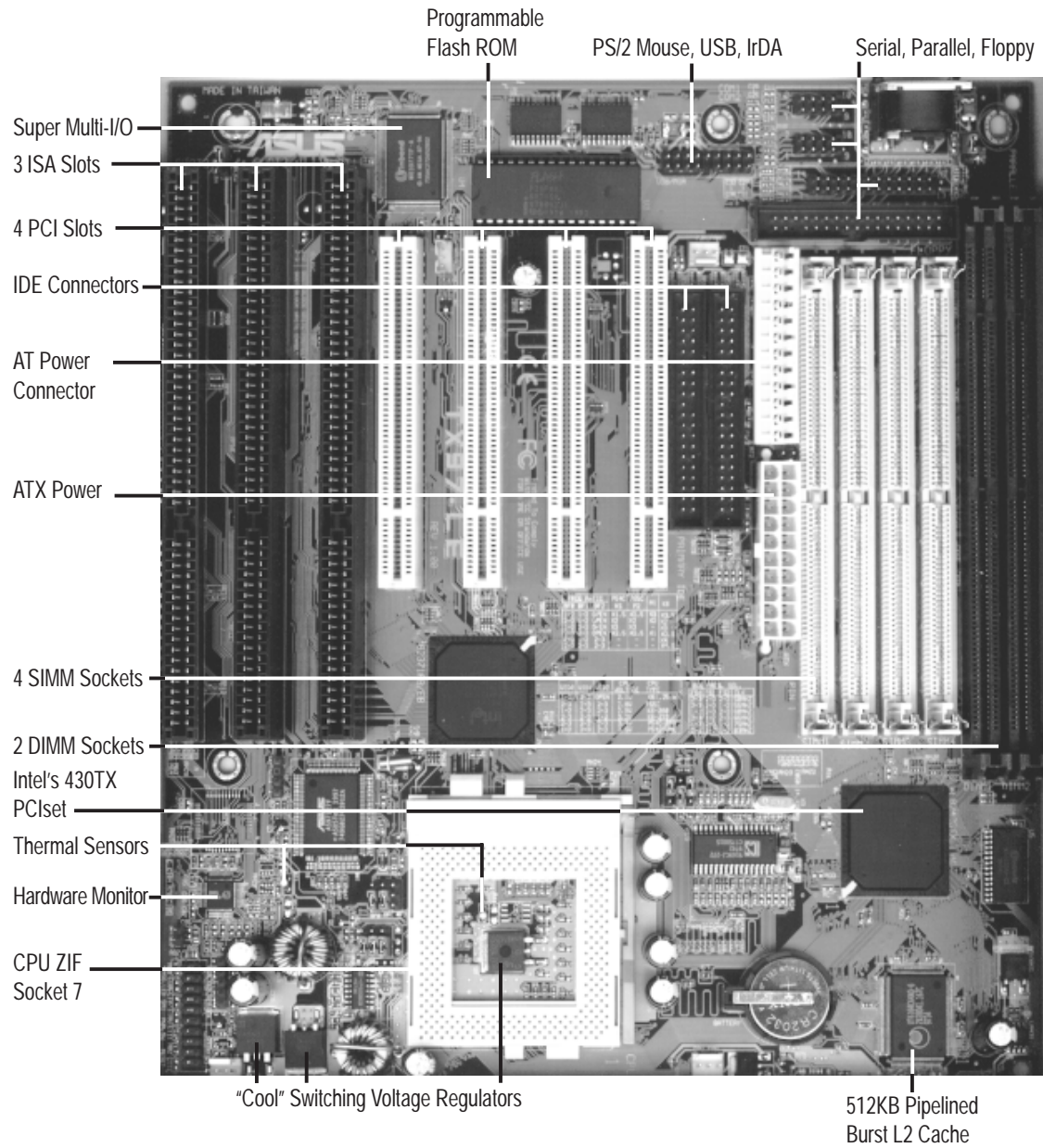

**II. FEATURES**  
(Motherboard Parts)

# III. INSTALLATION

## ASUS TX97-LE Motherboard Layout

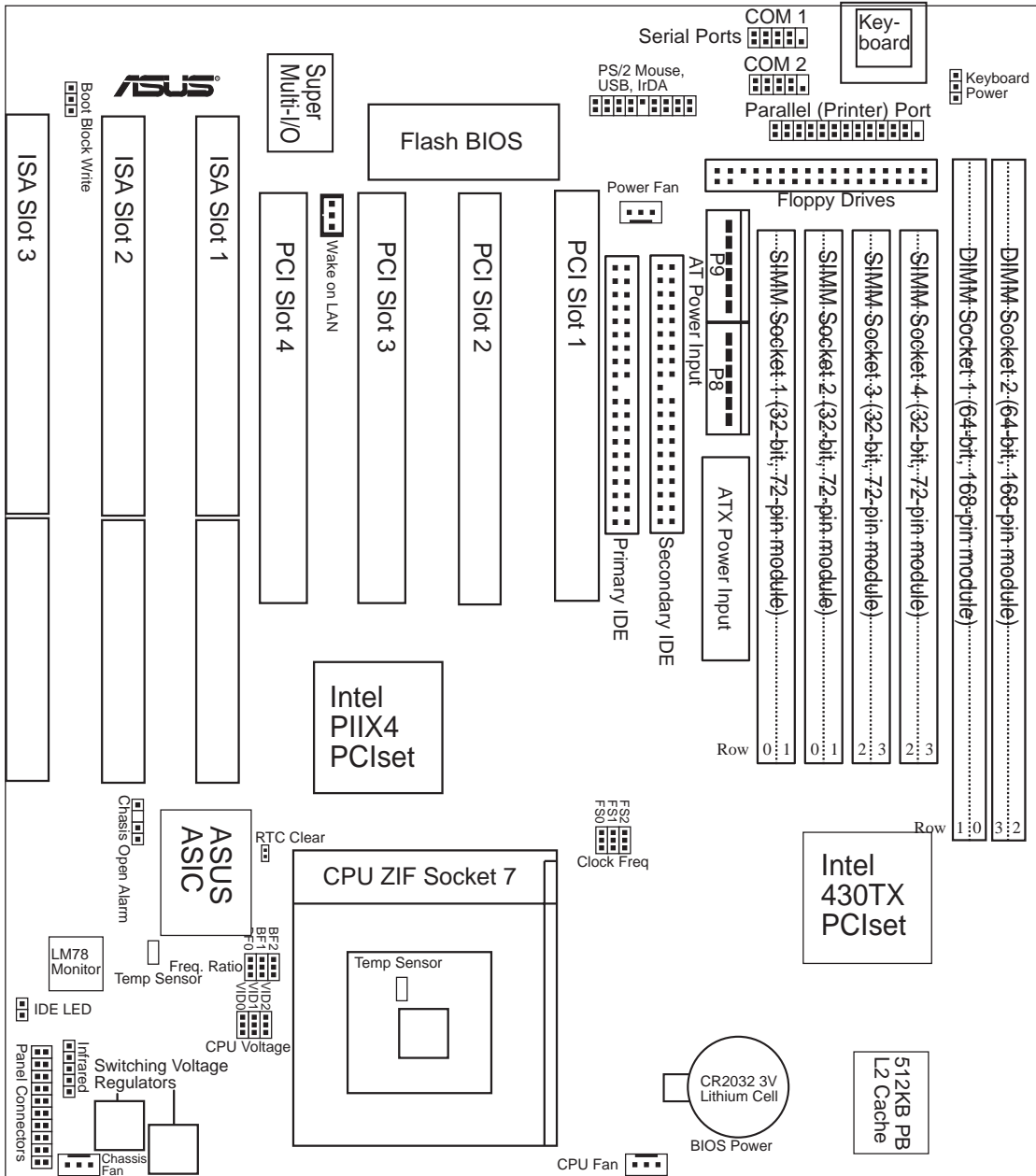

III. INSTALLATION  
(Motherboard Layout)

# III. INSTALLATION

## Jumpers

- |                     |       |   |
|---------------------|-------|---|
| 1) BBLKW            | p. 15 | Flash ROM Boot Block Program (Disable/Enable) |
| 2) CLRTC            | p. 15 | Real Time Clock RAM (Clear Data)              |
| 3) KBPWR            | p. 16 | Keyboard Power Up (Enable/Disable)            |
| 4) FS0, FS1, FS2    | p. 16 | CPU External Clock (BUS) Frequency Selection  |
| 5) BF0, BF1, BF2    | p. 16 | CPU:BUS Frequency Ratio                       |
| 6) VID0, VID1, VID2 | p. 18 | CPU Voltage Selection                         |

## Expansion Slots

- |                     |       |                                       |
|---------------------|-------|---------------------------------------|
| 1) SIMM Sockets     | p. 19 | 72-Pin SIMM Memory Expansion Sockets  |
| 2) DIMM Sockets     | p. 19 | 168-Pin DIMM Memory Expansion Sockets |
| 3) CPU ZIF Socket 7 | p. 22 | Central Processing Unit (CPU) Socket  |
| 4) SLOT 1, 2, 3     | p. 23 | 16-bit ISA Bus Expansion Slots*       |
| 5) PCI 1, 2, 3, 4   | p. 23 | 32-bit PCI Bus Expansion Slots        |

## Connectors

- |                         |       |   |
|-------------------------|-------|---|
| 1) KBCON                | p. 25 | Keyboard Connector (5-pin Female)                   |
| 2) FLOPPY               | p. 25 | Floppy Drive Connector (34-1pin Block)              |
| 3) PRINTER              | p. 26 | Parallel (Printer) Port Connector (26-1pin Block)   |
| 4) COM1, COM2           | p. 26 | Serial Port COM1 & COM2 (10-1pin Blocks)            |
| 5) FAN                  | p. 27 | Power Supply, Chassis, CPU Fan Power Leads          |
| 6) CHASSIS              | p. 27 | Chassis Open Alarm Lead (4-1pin Block)              |
| 7) Primary / Second IDE | p. 28 | Primary / Secondary IDE Connector (40-1pin Blocks)  |
| 8) IDELED               | p. 28 | IDE LED Activity Light                              |
| 9) ATX POWER            | p. 29 | ATX Motherboard Power Connector (20-pin Block)      |
| 10) AT POWER            | p. 29 | AT Motherboard Power Connector (12-pin Block)       |
| 11) PS2MOUSE/USB/IR     | p. 31 | PS/2 Mouse/USB/IR Combo-Connector (18-1pin Block)   |
| 12) IR                  | p. 31 | Second Infrared Port Module Connector (5-pin Block) |
| 13) MSG.LED (PANEL)     | p. 31 | System Message LED (2 pins)                         |
| 14) SMI (PANEL)         | p. 31 | SMI Switch Lead (2 pins)                            |
| 15) PWR SW. (PANEL)     | p. 31 | ATX Power & Soft-Off Switch Lead (2 pins)           |
| 16) RESET (PANEL)       | p. 31 | Reset Switch Lead (2 pins)                          |
| 17) PWR.LED (PANEL)     | p. 31 | System Power LED Lead (3 pins)                      |
| 18) KEYLOCK (PANEL)     | p. 31 | Keyboard Lock Switch Lead (2 pins)                  |
| 19) SPEAKER (PANEL)     | p. 31 | Speaker Output Connector (4 pins)                   |
| 20) WOL_CON             | p. 32 | Wake on LAN Activity Connector (3-pins)             |

\*The onboard hardware monitor uses the address 290H-297H so legacy ISA cards must not use this address or else conflicts will occur.









# III. INSTALLATION

## Installation Steps

Before using your computer, you must complete the following steps:

1. Set Jumpers on the Motherboard
2. Install System Memory Modules
3. Install the Central Processing Unit (CPU)
4. Install Expansion Cards
5. Connect Ribbon Cables, Cabinet Wires, and Power Supply
6. Setup the BIOS Software

### 1. Jumpers

Several hardware settings are made through the use of jumper caps to connect jumper pins (JP) on the motherboard. See motherboard layout for locations of jumpers. The jumper settings will be described numerically, such as [---], [1-2], [2-3] for no connection, connect pins 1&2, and connect pins 2&3 respectively. Pin 1 for our motherboards is always on top  or on the left  when holding the motherboard with the keyboard connector away from yourself. A “1” is written besides pin 1 on jumpers with three pins. The jumpers will also be shown graphically such as  to connect pins 1&2 and  to connect pins 2&3. Jumpers with two pins will be shown as  for Short (On) and  for Open (Off). For manufacturing simplicity, the jumpers may be sharing pins from other groups. Use the diagrams in this manual instead of following the pin layout on the board. Settings with two jumper numbers require that both jumpers be moved together. To connect the pins, simply place a plastic jumper cap over the two pins as diagramed.

**WARNING!** Computer motherboards, baseboards and components, such as SCSI cards, contain very delicate Integrated Circuit (IC) chips. To protect them against damage from static electricity, you should follow some precautions whenever you work on your computer.

1. Unplug your computer when working on the inside.
2. Use a grounded wrist strap before handling computer components. If you do not have one, touch both of your hands to a safely grounded object or to a metal object, such as the power supply case.
3. Hold components by the edges and try not to touch the IC chips, leads or connectors, or other components.
4. Place components on a grounded antistatic pad or on the bag that came with the component whenever the components are separated from the system.

# III. INSTALLATION

## Jumper Settings

### 1. Flash ROM Boot Block Programming (BBLKW)

This sets the operation mode of the boot block area of the Programmable Flash ROM to allow programming in the *Enabled* position. This is required only if prompted by the **Flash Memory Writer Utility** as shown in BIOS SOFTWARE.

<u>Programming</u>	<u>BBLKW</u>
Disabled	[1-2] (Default)
Enabled	[2-3]

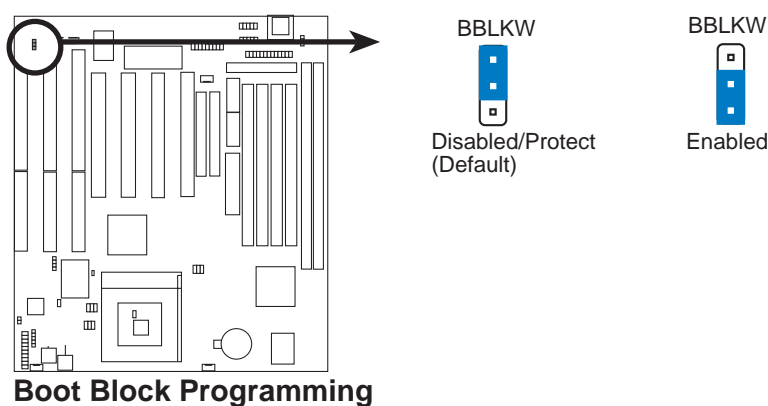

### 2. Real Time Clock (RTC) RAM (CLRTC)

The CMOS RAM is powered by the onboard button cell battery. To clear the RTC data: (1) Turn off your computer, (2) Short solder points using a small metallic object, (3) Turn on your computer, (4) Hold down <Delete> during bootup and enter BIOS setup to re-enter user preferences.

<u>RTC RAM</u>	<u>CLRTC</u>
Clear Data	[short solder points momentarily]

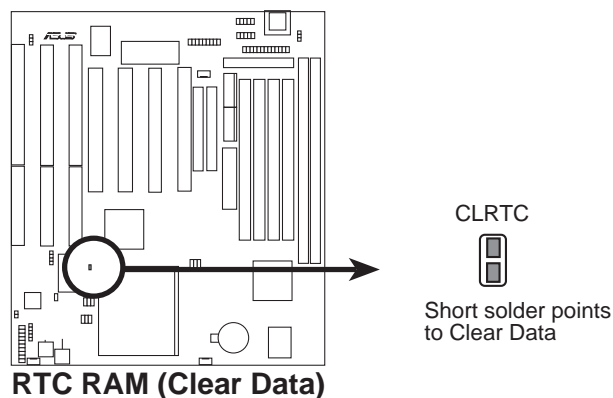



# III. INSTALLATION

## 3. Keyboard Power Up (KBPWR) (Reserved for future use)

Set this jumper to Enable if you wish to use your keyboard to power up your system. Requires an ATX power supply that can supply at least 300mA on the +5VSB lead and new BIOS support. The default is set to Disable because your system will not function without the proper ATX power supply.

<b>Setting</b>	<b>KBPWR</b>
Disable	[1-2] (default)
Enable	[2-3]

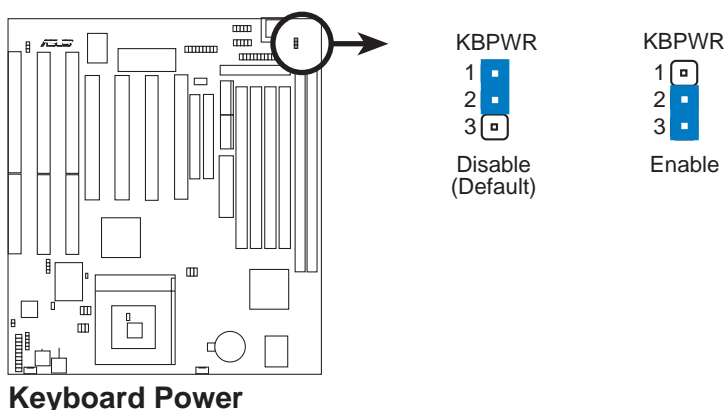

## 4. CPU External (BUS) Frequency Selection (FS0, FS1, FS2)

These jumpers tell the clock generator what frequency to send to the CPU. These allow the selection of the CPU's *External* frequency (or *BUS Clock*). The *BUS Clock* times the *BUS Ratio* equals the CPU's *Internal* frequency (the advertised CPU speed).

## 5. CPU to BUS Frequency Ratio (BF0, BF1, BF2)

These jumpers set the frequency ratio between the *Internal* frequency of the CPU and the *External* frequency (called the *BUS Clock*) within the CPU. These must be set together with the above jumpers *CPU External (BUS) Frequency Selection*.

**WARNING!** Frequencies above 66MHz exceed the specifications for the onboard Intel Chipset and are not guaranteed to be stable. The following table is for general reference purposes only. Always refer to the instructions included with your CPU when possible.

# III. INSTALLATION

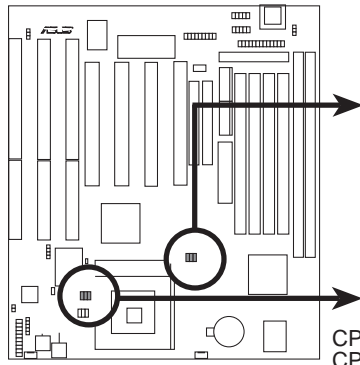

Match the table's Ratio column to these CPU types:

		CPU External Clock (BUS) Frequency Selection					
		FS0	FS1	FS2	FS0	FS1	FS2
		50MHz	55MHz	60MHz	66MHz	75MHz	83MHz
CPU A	→ 1.5x(3/2)	2.0x(2/1)	2.5x(5/2)	3.0x(3/1)	---	---	---
CPU B	→ 3.5x(7/2)	2.0x(2/1)	2.5x(5/2)	3.0x(3/1)	---	---	---
CPU C	→ 3.0x(3/1)	2.0x(2/1)	1.0x(1/1)	---	---	---	---
CPU D	→ 3.0x(3/1)	2.0x(2/1)	2.0x(2/1)	---	---	---	---
CPU E	→ 3.5x(7/2)	2.0x(2/1)	2.5x(5/2)	3.0x(3/1)	4.0x(4/1)	(4.5x)(9/2)	---

Set the jumpers by the Internal speed of the Intel, AMD, IBM, or Cyrix CPU as follows:

CPU Model	Freq.	Ratio	(BUS Freq.)			(Freq. Ratio)			
			BUS F.	FS0	FS1	FS2	BF0	BF1	BF2
Intel Pentium P54C	166MHz	A-2.5x	66MHz	[2-3]	[1-2]	[2-3]	[2-3]	[2-3]	[----]
Intel Pentium P54C	150MHz	A-2.5x	60MHz	[1-2]	[2-3]	[2-3]	[2-3]	[2-3]	[----]
Intel Pentium P54C	133MHz	A-2.0x	66MHz	[2-3]	[1-2]	[2-3]	[2-3]	[1-2]	[----]
Intel Pentium P54C	120MHz	A-2.0x	60MHz	[1-2]	[2-3]	[2-3]	[2-3]	[1-2]	[----]
Intel Pentium P54C	100MHz	A-1.5x	66MHz	[2-3]	[1-2]	[2-3]	[1-2]	[1-2]	[----]
Intel Pentium P54C	90MHz	A-1.5x	60MHz	[1-2]	[2-3]	[2-3]	[1-2]	[1-2]	[----]
Intel Pentium P54C	75MHz	A-1.5x	50MHz	[2-3]	[2-3]	[2-3]	[1-2]	[1-2]	[----]
AMD-K5-PR133	100MHz	A-1.5x	66MHz	[2-3]	[1-2]	[2-3]	[1-2]	[1-2]	[----]
AMD-K5-PR120	90MHz	A-1.5x	60MHz	[1-2]	[2-3]	[2-3]	[1-2]	[1-2]	[----]
AMD-K5-PR100	100MHz	A-1.5x	66MHz	[2-3]	[1-2]	[2-3]	[1-2]	[1-2]	[----]
AMD-K5-PR90	90MHz	A-1.5x	60MHz	[1-2]	[2-3]	[2-3]	[1-2]	[1-2]	[----]
AMD-K5-PR75	75MHz	A-1.5x	50MHz	[2-3]	[2-3]	[2-3]	[1-2]	[1-2]	[----]
Intel Pentium P55C	233MHz	B-3.5x	66MHz	[2-3]	[1-2]	[2-3]	[1-2]	[1-2]	[----]
Intel Pentium P55C	200MHz	B-3.0x	66MHz	[2-3]	[1-2]	[2-3]	[1-2]	[2-3]	[----]
Intel Pentium P55C	166MHz	B-2.5x	66MHz	[2-3]	[1-2]	[2-3]	[2-3]	[2-3]	[----]
IBM/Cyrix 6x86MX-PR233	200MHz	B-3.0x	66MHz	[2-3]	[1-2]	[2-3]	[1-2]	[2-3]	[----]
IBM/Cyrix 6x86MX-PR200	166MHz	B-2.5x	66MHz	[2-3]	[1-2]	[2-3]	[2-3]	[2-3]	[----]
IBM/Cyrix 6x86MX-PR166	150MHz	B-2.5x	60MHz	[1-2]	[2-3]	[2-3]	[2-3]	[2-3]	[----]
*IBM/Cyrix 6x86-PR166+	133MHz	C-2.0x	66MHz	[2-3]	[1-2]	[2-3]	[2-3]	[1-2]	[----]
*IBM/Cyrix 6x86L-PR166+	133MHz	D-2.0x	66MHz	[2-3]	[1-2]	[2-3]	[2-3]	[1-2]	[----]
AMD-K6-PR233	233MHz	E-3.5x	66MHz	[2-3]	[1-2]	[2-3]	[1-2]	[1-2]	[----]
AMD-K6-PR200	200MHz	E-3.0x	66MHz	[2-3]	[1-2]	[2-3]	[1-2]	[2-3]	[----]
AMD-K6-PR166	166MHz	E-2.5x	66MHz	[2-3]	[1-2]	[2-3]	[2-3]	[2-3]	[----]

\*NOTE: The only IBM or Cyrix 6x86(L) (or M1) that is supported on this motherboard is revision 2.7 or later. (see next page).

# III. INSTALLATION

## Compatible Cyrix CPU Identification

The only Cyrix 6x86-PR166+ CPU that is supported on this motherboard must be Revision 2.7 or later. Look on the underside of the CPU for the serial number. The number should read G8DC6620A or later.

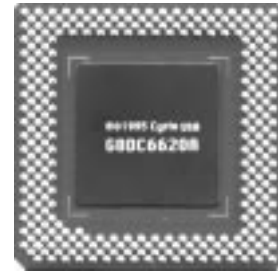

### 6. Voltage Regulator Output Selection (VID0, 1, 2)

These jumpers set the voltage supplied to the CPU. Switching regulators allow some jumper settings to be the same for two voltages of different power planes.

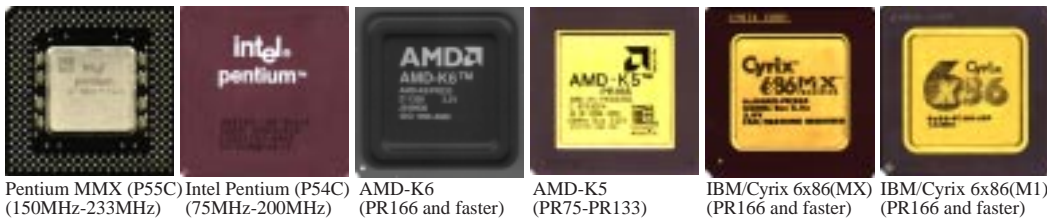

**WARNING!** Because CPU designs change rapidly, the table below is only intended as a simple guideline and thus may not be true for your CPU. Always refer to the CPU documentation for your CPU's voltage and then set the appropriate VID jumpers according to the illustration below.

Manufacturer	CPU Type	Single Plane	Dual Plane	VID0	VID1	VID2
Intel	P54C/P54CS	3.5V(VRE)	----	[1-2]	[2-3]	[2-3]
AMD	K5	3.5V(VRE)	----	[1-2]	[2-3]	[2-3]
IBM/Cyrix	6x86	3.5V(VRE)	----	[1-2]	[2-3]	[2-3]
Intel	P54C/P54CS	3.4V(STD)	----	[2-3]	[2-3]	[2-3]
AMD	K5	3.4V(STD)	----	[2-3]	[2-3]	[2-3]
AMD (.35micron)	K6-PR233	----	3.2V(Dual)	[2-3]	[2-3]	[1-2]
AMD (.35micron)	K6-166,200	----	2.9V(Dual)	[1-2]	[2-3]	[2-3]
IBM/Cyrix	6x86MX	----	2.9V(Dual)	[1-2]	[2-3]	[2-3]
Intel	P55C-MMX	----	2.8V(Dual)	[2-3]	[2-3]	[2-3]
AMD (.25micron)	K6-233,266,300	----	2.2V(Dual)	[----]	[1-2]	[----]

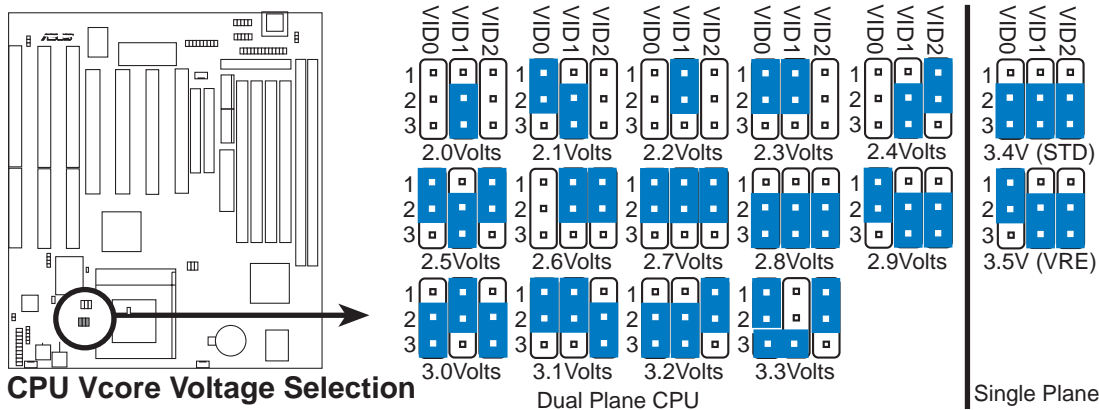

# III. INSTALLATION

## 2. System Memory (SIMM & DIMM)

This motherboard supports four 72-pin, 32-bit SIMMs (Single Inline Memory Modules) of 4, 8, 16, 32, or 64MB to form a memory size between 8MB to 256MB. The SIMMs can be either 60ns or 70ns Fast Page Mode (FPM) (Asymmetric or Symmetric), or Enhanced Data Out (EDO) (BEDO & Parity are not supported). SIMMs must be installed in pairs so that each Row (see motherboard layout for row locations) contains 64-bits of the same size and type of memory chips. One side (with memory chips) of the SIMM module takes up half a row on the motherboard.

Dual Inline Memory Modules (DIMMs) can be used when the SIMM sockets are not used. Two sockets are available for **3.3Volt** (power level) Unbuffered Synchronous DRAMs (SDRAM) or EDO DRAM of either 8, 16, 32, 64, 128, 256MB to form a memory size between 8MB to 256MB. One side (with memory chips) of the DIMM module takes up one row on the motherboard.

**IMPORTANT:** Memory speed setup is required through “Auto Configuration” in BIOS Chipset Setup of the BIOS SOFTWARE. If both 60ns and 70ns memory are used, set “Auto Configuration” to 70ns. Do not use memory modules with more than 18 chips per module. Modules with more than 18 chips exceed the design specifications of the memory subsystem and will be unstable.

Memory Socket	SIMM Memory Module		Total Memory
SIMM Sockets 1&2 (Rows 0 & 1)	4MB, 8MB, 16MB, 32MB, 64MB 72-pin FPM or EDO SIMM (DIMM Sockets must be empty)	x2	
SIMM Sockets 3&4 (Rows 2 & 3)	4MB, 8MB, 16MB, 32MB, 64MB 72-pin FPM or EDO SIMM (DIMM Sockets must be empty)	x2	
	<b>Total System Memory (Max 256MB)</b>	=	

**WARNING!** Do not install both SIMMs and DIMMs at the same time or else you will burn your memory. Mixing SIMMs and DIMMs require 5.0Volt (signal level) tolerant memory chips which are currently unavailable.

Memory Socket	DIMM Memory Module		Total Memory
DIMM Socket 1 (Rows 0 & 1)	8, 16, 32, 64, 128, 256MB 168-pin SDRAM or EDO DIMM (SIMM Sockets must be empty)	x1	
DIMM Socket 2 (Rows 2 & 3)	8, 16, 32, 64, 128, 256MB 168-pin SDRAM or EDO DIMM (SIMM Sockets must be empty)	x1	
	<b>Total System Memory (Max 256MB)</b>	=	

# III. INSTALLATION

## *SIMM Memory Installation*

1. The SIMM memory modules will fit in only one orientation as shown because the plastic safety tab on one end of the SIMM sockets requires the notched end of the SIMM memory modules.

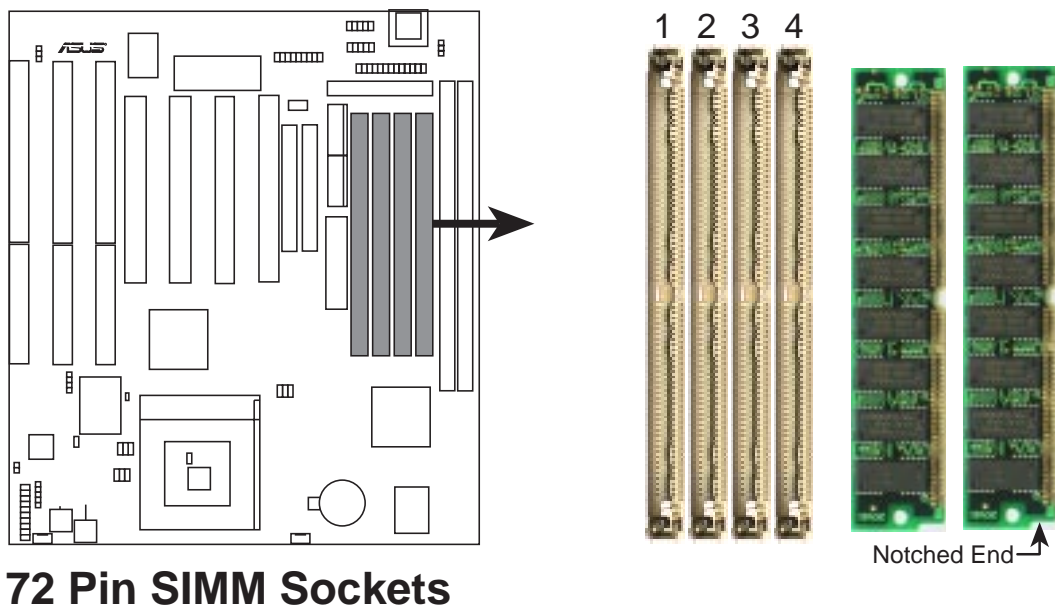

2. Press the memory module firmly into place starting from a 45-degree angle, making sure that all the contacts are aligned with the socket.
3. With your fingertips, rock the memory module into a vertical position so that it clicks into place. The plastic guides should go through the two mounting holes and the support clips should snap.

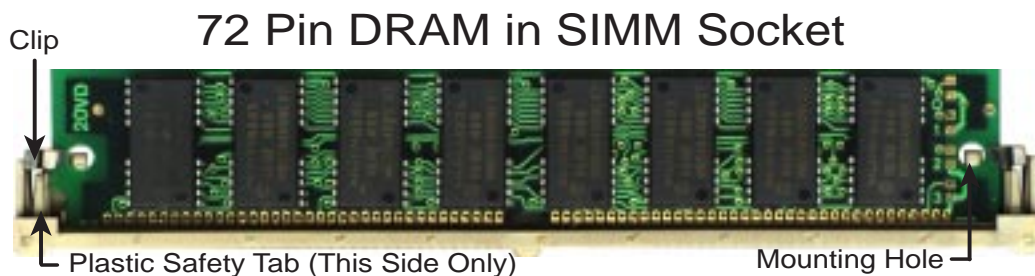

To release the memory module, push both support clips outward and rock the module out of the support clips.

# III. INSTALLATION

## *DIMM Memory Installation*

Insert the module(s) as shown. Because the number of pins are different on either side of the breaks, the module will only fit in the orientation as shown. SIMM modules have the same pin contact on both sides. DIMM modules are longer and have different pin contact on each side and therefore have a higher pin density.

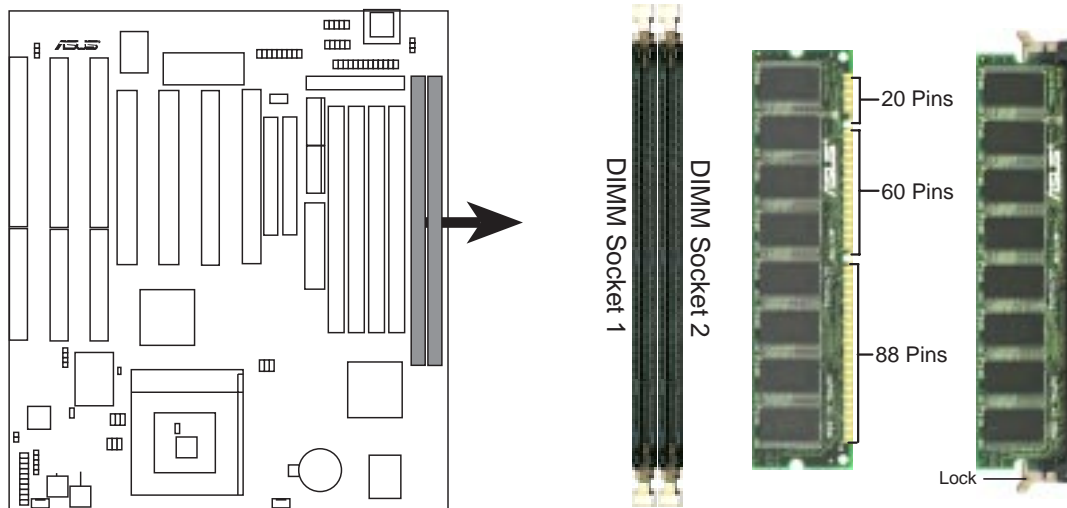

### 168 Pin DIMM Memory Sockets

The Dual Inline Memory Module (DIMM) must be **3.3V Unbuffered** for this motherboard. You can identify the type of DIMM module by the illustration below:

#### 168-Pin DIMM Notch Key Definitions (3.3V)

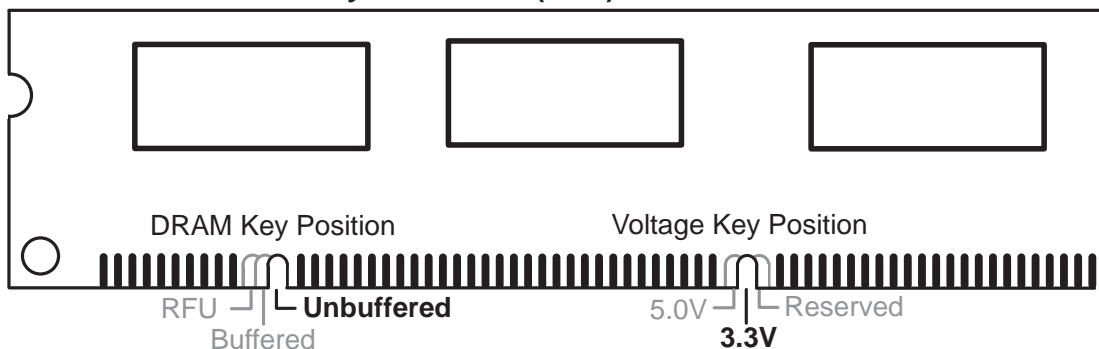

The notch on the DIMM module will shift between left, center, or right to identify the type and also to prevent the wrong type of DIMM to be inserted into the DIMM socket on the motherboard. Four clock signals are supported on this motherboard. You must ask your retailer for the specifications before purchasing memory modules.



# III. INSTALLATION

## 3. Central Processing Unit (CPU)

The motherboard provides a 321-pin ZIF Socket 7 that is backwards compatible with ZIF Socket 5 processors. The CPU that came with the motherboard should have a fan attached to it to prevent overheating. If this is not the case then purchase a fan before you turn on your system.

**WARNING!** Without a fan circulating air on the CPU, the CPU can overheat and cause damage to both the CPU and the motherboard.

To install a CPU, first turn off your system and remove its cover. Locate the ZIF socket and open it by first pulling the lever sideways away from the socket then upwards to a 90-degree right angle. Insert the CPU with the correct orientation as shown. Use the notched corner of the CPU with the white dot as your guide. The white dot should point towards the end the of the lever. Notice that there is a blank area where one hole is missing from that corner of the square array of pin holes and a “1” printed on the motherboard next to that corner. Because the CPU has a corner pin for three of the four corners, the CPU will only fit in the one orientation as shown. The picture is for reference only; you should have a CPU fan that will cover the face of the CPU. With the added weight of the CPU fan, no force is required to insert the CPU. Once completely inserted, hold down on the fan and close the socket’s lever.

**IMPORTANT:** You must set jumpers for “CPU to BUS Frequency Ratio” and jumpers for “BUS Frequency Selection” depending on the CPU that you install.

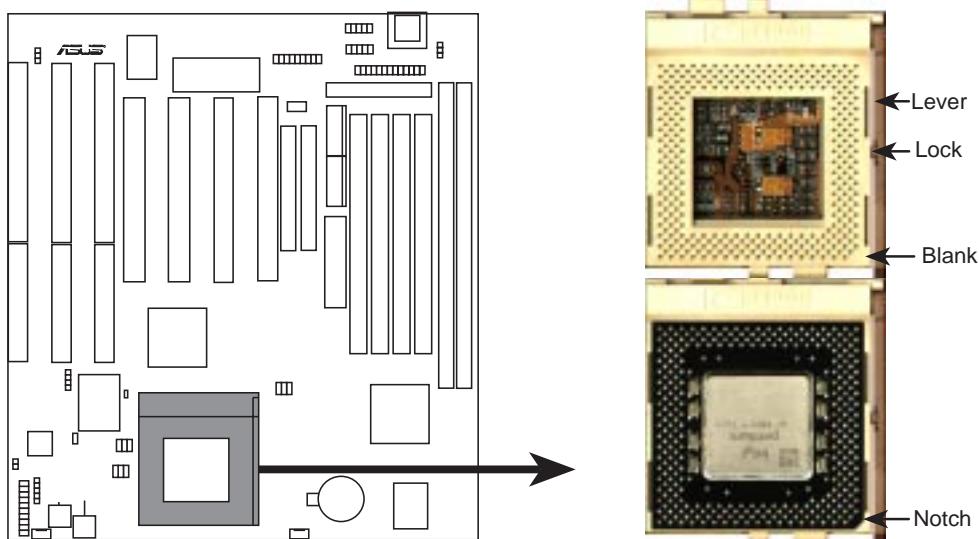

**ZIF Socket 7 with Pentium Processor**



# III. INSTALLATION

---

## 4. Expansion Cards

**WARNING!** Make sure that you unplug your power supply when adding or removing expansion cards or other system components. Failure to do so may cause severe damage to both your motherboard and expansion cards.

First read your expansion card documentation on any hardware and software settings that may be required to setup your specific card.

### *Expansion Card Installation Procedure:*

1. Read the documentation for your expansion card.
2. Set any necessary jumpers on your expansion card.
3. Remove your computer system's cover.
4. Remove the bracket on the slot you intend to use.  
Keep the bracket for possible future use.
5. Carefully align the card's connectors and press firmly.
6. Secure the card on the slot with the screw you removed in step 4.
7. Replace the computer system's cover.
8. Setup the BIOS if necessary  
(such as "IRQ xx Used By ISA: Yes" in PNP AND PCI SETUP)
9. Install the necessary software drivers for your expansion card.

### *Assigning IRQs for Expansion Cards*

Some expansion cards need to use an IRQ to operate. Generally an IRQ must be exclusively assigned to one use. In a standard design there are 16 IRQs available but most of them are already in use by parts of the system which leaves 6 free for expansion cards.

Both ISA and PCI expansion cards may need to use IRQs. System IRQs are available to cards installed in the ISA expansion bus first, and any remaining IRQs are then used by PCI cards. Currently, there are two types of ISA cards.

# III. INSTALLATION

---

The original ISA expansion card design, now referred to as “Legacy” ISA cards, requires that you configure the card’s jumpers manually and then install it in any available slot on the ISA bus. You may use Microsoft’s Diagnostic (MSD.EXE) utility included in the Windows directory to see a map of your used and free IRQs. For Windows 95 users, the “Control Panel” icon in “My Computer,” contains a “System” icon which gives you a “Device Manager” tab. Double clicking on a specific device give you “Resources” tab which shows the Interrupt number and address. Make sure that no two devices use the same IRQs or your computer will experience problems when those two devices are in use at the same time.

To simplify this process this motherboard has complied with the Plug and Play (PNP) specification which was developed to allow automatic system configuration whenever a PNP-compliant card is added to the system. For PNP cards, IRQs are assigned automatically from those available.

If the system has both Legacy and PNP ISA cards installed, IRQs are assigned to PNP cards from those not used by Legacy cards. The PCI and PNP configuration of the BIOS setup utility can be used to indicate which IRQs are being used by Legacy cards. For older Legacy cards that does not work with the BIOS, you can contact your vendor for an ISA Configuration Utility.

An IRQ number is automatically assigned to PCI expansion cards after those used by Legacy and PNP ISA cards. In the PCI bus design, the BIOS automatically assigns an IRQ to a PCI slot that has a card in it that requires an IRQ. To install a PCI card, you need to set something called the INT (interrupt) assignment. Since all the PCI slots on this motherboard use an INTA #, be sure that the jumpers on your PCI cards are set to INT A.

## *Assigning DMA Channels for ISA Cards*

Some ISA cards, both legacy and PnP, may also need to use a DMA (Direct Memory Access) channel. DMA assignments for this motherboard are handled the same way as the IRQ assignment process described earlier. You can select a DMA channel in the PCI and PnP configuration section of the BIOS Setup utility.

**IMPORTANT:** To avoid conflicts, reserve the necessary IRQs and DMAs for legacy ISA cards (under PNP AND PCI SETUP of the BIOS SOFTWARE, choose *Yes* in *IRQ xx Used By ISA* and *DMA x Used By ISA* for those IRQs and DMAs you want to reserve).

## *ISA Cards and Hardware Monitor*

The onboard hardware monitor uses the address 290H-297H so legacy ISA cards must not use this address or else conflicts will occur.

# III. INSTALLATION

## 5. External Connectors

**WARNING!** Some pins are used for connectors or power sources. These are clearly separated from jumpers in “Map of the ASUS Motherboard.” Placing jumper caps over these will cause damage to your motherboard.

**IMPORTANT:** Ribbon cables should always be connected with the red stripe on the Pin 1 side of the connector. The four corners of the connectors are labeled on the motherboard. Pin 1 is the side closest to the power connector on hard drives and some floppy drives. IDE ribbon cable must be less than 18in. (46cm), with the second drive connector no more than 6in. (15cm) from the first connector.

### 1. Keyboard Connector (KBCON, 5-pin female)

This connector supports either a standard IBM-compatible, 101/102-key, or 104-key keyboard (Windows 95-compatible).

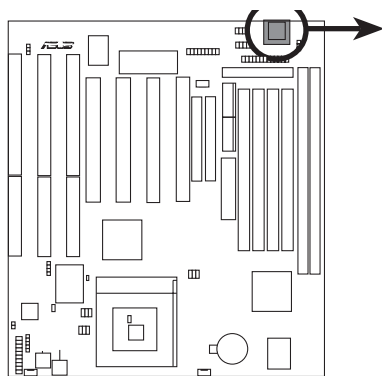

**Keyboard Connector**



Keyboard Connector (5-pin female)



This motherboard accepts an AT Keyboard Connector Plug as shown here.

### 2. Floppy drive connector (FLOPPY, 34-1 pin block)

This connector supports the provided floppy drive ribbon cable. After connecting the single end to the board, connect the two plugs on the other end to the floppy drives. (Pin 5 is removed to prevent inserting in the wrong orientation when using ribbon cables with pin 5 plugged).

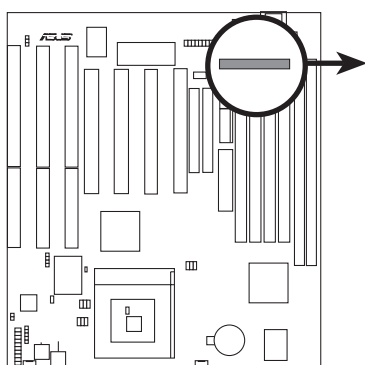

**Floppy Drive Connector**



Pin 1

Connect the Red stripe to Pin 1

**NOTE:** Most 3.5inch floppy drive's Pin 1 is away from the power connector. If your 3.5inch floppy drive's light remains constantly lit, try reversing the connection to the floppy drive.

# III. INSTALLATION

## 3. Parallel Printer Connector (PRINTER, 26-1 pin block)

This connector supports the included parallel port ribbon cable with mounting bracket. Connect the ribbon cable to this connection and mount the bracket to the case on an open slot. A PS/2 mouse connector is included for the USB/IR/Mouse onboard connector if the optional USB/MIR connector is not used. You can make available the parallel port and choose the IRQ through the *Onboard Parallel Port* in **Chipset Features** of the BIOS SOFTWARE. **(Pin 26 is removed to prevent inserting in the wrong orientation when using ribbon cables with pin 26 plugged).**

**NOTE:** Serial printers must be connected to the serial port.

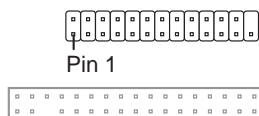
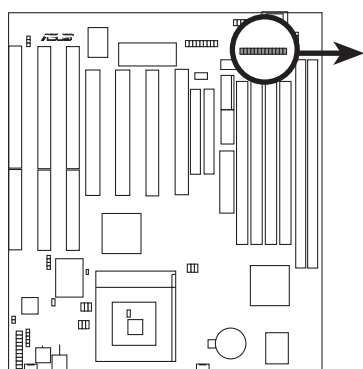

Connect the Red stripe to Pin 1

**TIP:** You may also remove the bracket connectors and mount them directly to the case to save expansion slot space.



**Parallel (Printer) Connector**

## 4. Serial Port Connectors (COM1/COM2, two 10-1 pin blocks)

These connectors support the provided serial port ribbon cables with mounting bracket. Connect the ribbon cables to these connectors and mount the bracket to the case on an open slot. You can make available the parallel port and choose the IRQ through the *Onboard Serial Port* in **Chipset Features** of the BIOS SOFTWARE. **(Pin 10 is removed to prevent inserting in the wrong orientation when using ribbon cables with pin 10 plugged).**

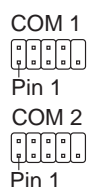
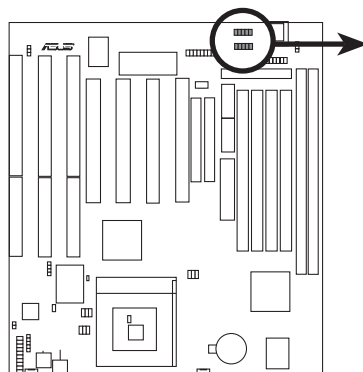

For these connectors to be available, you must connect the included Serial cable set from COM1 (using the 9-Pin male) & COM2 (using the 25-Pin male) to a free expansion slot opening.

**TIP:** You may also remove the bracket connectors and mount them directly to the case to save expansion slot space.

**Onboard Serial Port Connectors**

# III. INSTALLATION

## 5. CPU Cooling Fan Connectors (FAN, 3 pins)

This connector supports a 3-pin CPU cooling fan of 500mAMP (6WATT) or less with a minimum of 3,500RPM. Depending on the fan manufacturer, the wiring and plug may be different. The red wire should be *Positive*, the black should be *Ground*, and the yellow wire should be *Rotation* signal.

**WARNING!** The CPU and/or motherboard will overheat if there is no airflow across the CPU. Damage may occur to the motherboard and/or the CPU fan if these pins are incorrectly used. **These are not jumpers, do not place jumper caps over these pins.**

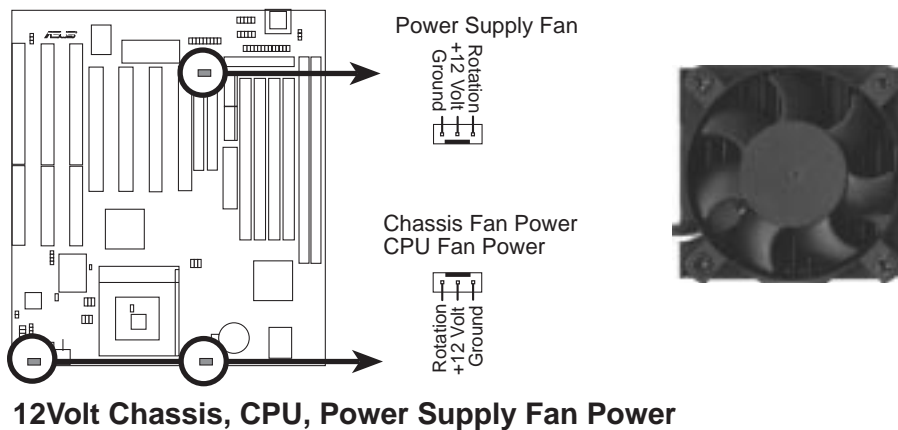

## 6. Chassis Open Alarm Lead (CHASSIS, 4-1 pins)

This lead is for an open chassis monitor. A high level signal to the CHASSIS lead will indicate to the system that the chassis has been opened.

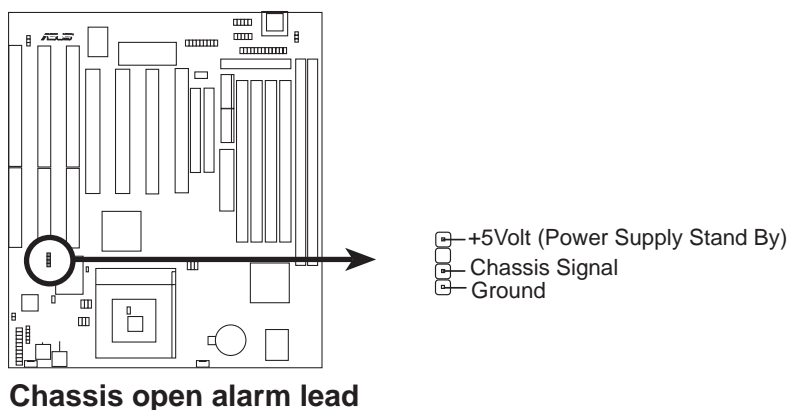

# III. INSTALLATION

## 7. Primary / Secondary IDE connectors (Two 40-1 pin block)

These connectors support the provided IDE hard disk ribbon cable. After connecting the single end to the board, connect the two plugs at the other end to your hard disk(s). If you install two hard disks, you must set the second drive to Slave mode. Refer to the documentation of your hard disk for the jumper settings. BIOS now supports SCSI device or IDE CD-ROM bootup (see *HDD Sequence SCSI/IDE First & Boot Sequence* in the **BIOS Features Setup** of the BIOS SOFTWARE) (**Pin 20 is removed to prevent inserting in the wrong orientation when using ribbon cables with pin 20 plugged**).

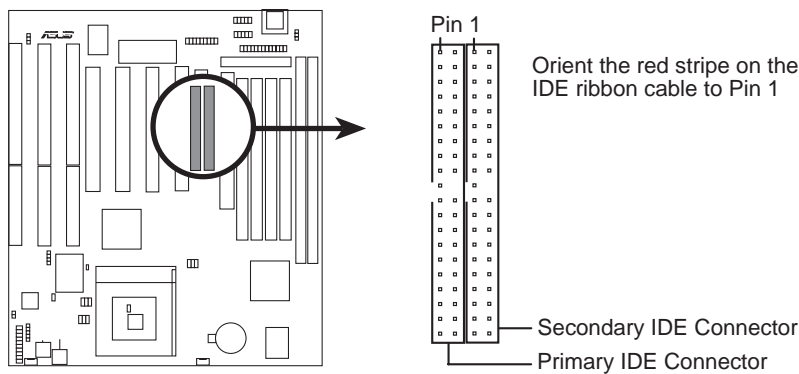

**IDE (Hard Disk Drive) Connectors**

**TIP:** You may configure two hard disks to be both Masters using one ribbon cable on the primary IDE connector and another ribbon cable on the secondary IDE connector. You may install one operating system on an IDE drive and another on a SCSI drive and select the boot disk through BIOS Features Setup.

## 8. IDE activity LED (IDE LED, 2 pins)

This connector supplies power to the cabinet's IDE activity LED. Read and write activity by devices connected to the Primary or Secondary IDE connectors will cause the LED to light up.

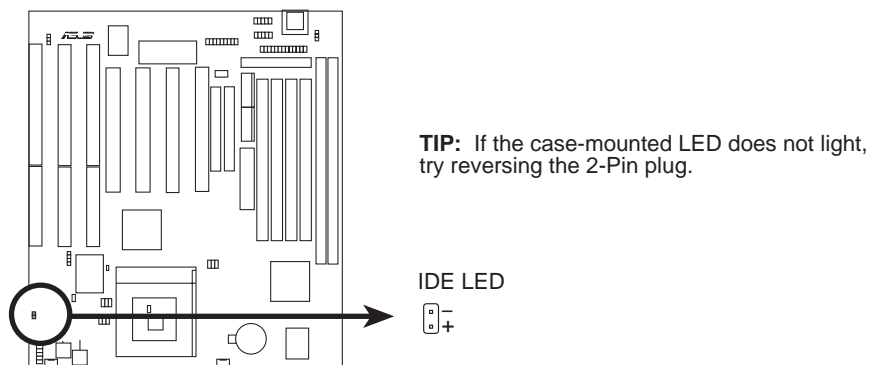

**IDE (Hard Drive) LED Lead**

# III. INSTALLATION

## 9. ATX Power Supply Connector (ATXPWR, 20-pin block)

This connector connects to a ATX power supply. The plug from the power supply will only insert in one orientation because of the different hole sizes. Find the proper orientation and push down firmly making sure that the pins are aligned.

**IMPORTANT:** Make sure that your ATX power supply can supply at least 10mA on the 5-volt standby lead (5VSB). You may experience difficulty in powering on your system if your power supply cannot support the load. For Wake on LAN support, your ATX power supply must supply at least 720mA.

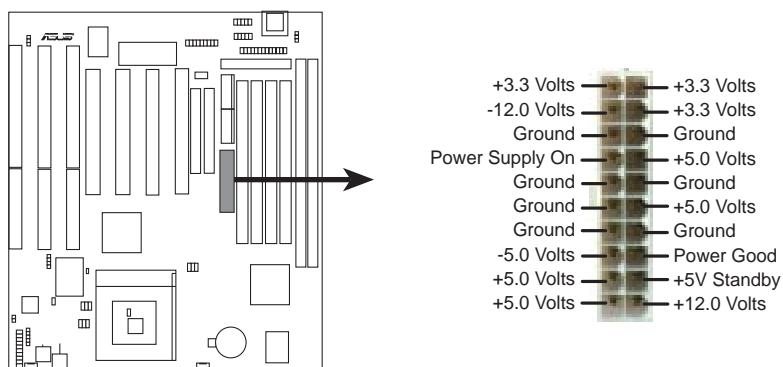

ATX Power Connector

## 10. AT Power Supply Connector (POWER, 12-pin block)

This connector connects to a standard 5 Volt power supply. To connect the leads from the power supply, ensure first that the power supply is not plugged. Most power supplies provide two plugs (P8 and P9), each containing six wires, two of which are black. Orient the connectors so that the black wires are together.

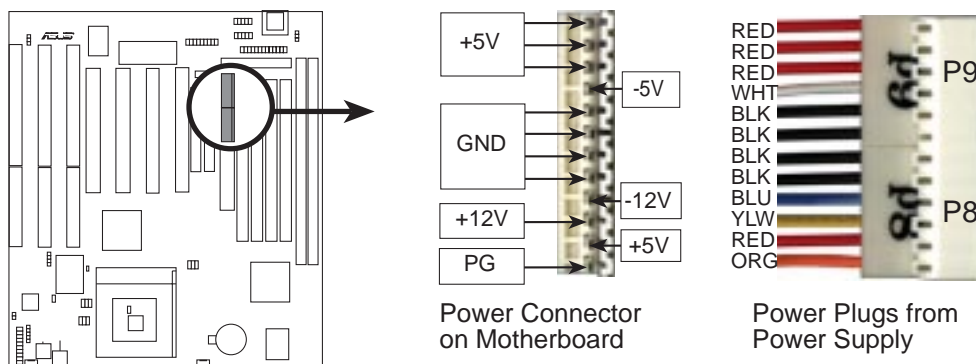

AT Power Connector

Using a slight angle, align the plastic guide pins on the lead to their receptacles on the connector. Once aligned, press the lead onto the connector until the lead locks into place.



# III. INSTALLATION

## 11. USB, Infrared, PS/2 Mouse Module Connector (USB\_IR\_MOUSE, 18-1 pin block)

If you want to use USB, PS/2 mouse, or infrared (IrDA) devices, you need to purchase an external connector set. The external connector set connects to the 18-pin block and mounts to an open slot on your computer's chassis. The system will direct IRQ12 to the PS/2 mouse if one is detected. If not detected, expansion cards can use IRQ12. See *PS/2 Mouse Control* in **BIOS Features Setup** and *USB Function* in **PnP and PCI Setup** of the BIOS SOFTWARE. See *Second IrDA...* connector for details on the infrared connector.

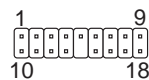
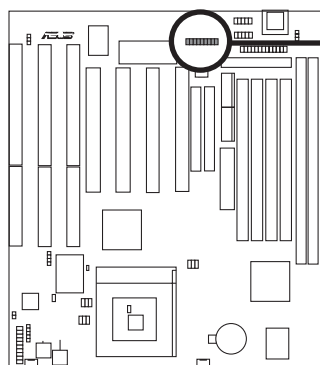

- |                     |                       |
|---------------------|-----------------------|
| 1: USB +5 Volt      | 10: USB +5 Volt       |
| 2: USB Port 0 -     | 11: USB Port 1 -      |
| 3: USB Port 0 +     | 12: USB Port 1 +      |
| 4: Ground           | 13: Ground            |
| 5: (no connection)  | 14: (no connection)   |
| 6: PS/2 Mouse Clock | 15: PS/2 Mouse Data   |
| 7: Ground           | 16: Ground            |
| 8: (no connection)  | 17: Infrared Receive  |
| 9: +5 Volt          | 18: Infrared Transmit |

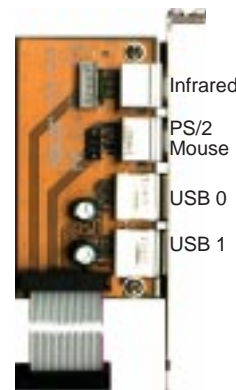

PS/2 Mouse, USB, IrDA Module Connector

Optional USB/MIR

III. INSTALLATION  
(Connectors)

## 12. Second IrDA-Compliant Infrared Connector (IR, 5-pin block)

This connector supports the optional wireless transmitting and receiving infrared module. This module mounts to a small opening on system cases that support this feature. You must also configure the setting through *UART2 Use Infrared* in **Chipset Features Setup** to select whether UART2 is directed for use with COM2 or IrDA. Use the five pins as shown below (Back View) and connect a ribbon cable from the module to the motherboard according to the pin definitions.

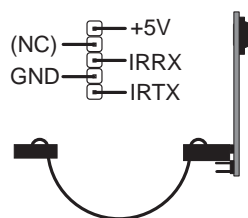
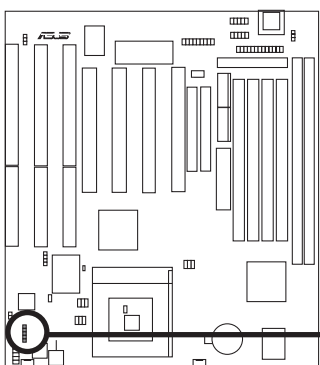

Front View



Back View

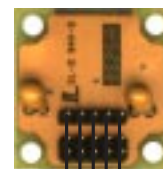

For the infrared feature to be available, you must connect an optional Infrared module to the motherboard.

Infrared Module Connector

# III. INSTALLATION

## 13. Message LED Lead (MSG.LED, 2 pins)

This indicates whether a message has been received from a fax/modem. The LED will remain lit when there is no signal and blink when there is data transfer or messages waiting in the inbox. This function requires ACPI OS support.

## 14. SMI Suspend Switch Lead (SMI, 2 pins)

This allows the user to manually place the system into a suspend mode or “Green” mode where system activity will be instantly decreased to save electricity and expand the life of certain components when the system is not in use. This 2-pin connector (see the figure below) connects to the case-mounted suspend switch. If you do not have a switch for the connector, you may use the “Turbo Switch” since it does not have a function. SMI is activated when it detects a *short to open* moment and therefore leaving it shorted will not cause any problems. May require one or two pushes depending on the position of the switch. Wake-up can be controlled by settings in the BIOS but the keyboard will always allow wake-up (the SMI lead cannot wake-up the system). If you want to use this connector, “Suspend Switch” in the **Power Management Setup** of the BIOS SOFTWARE section should be on the default setting of *Enable*.

## 15. ATX Power Switch/Soft Power Switch Lead (PWR.SW, 2 pins)

The system power can be controlled by a momentary switch connected to this lead. Pushing the button once will switch the system between ON and SLEEP. Pushing the switch while in the ON mode for more than 4 seconds will turn the system off. The system power LED shows the status of the system’s power.

## 16. Reset Switch Lead (RESET, 2 pins)

This 2-pin connector connects to the case-mounted reset switch for rebooting your computer without having to turn off your power switch. This is a preferred method of rebooting in order to prolong the life of the system’s power supply.

## 17. System Power LED (PWR.LED, 3 pins)

This 3-pin connector connects the system power LED, which lights when the system is powered on and blinks when it is in sleep mode.

## 18. Keyboard Lock Switch Lead (KEYLOCK, 2 pins)

This 2-pin connector connects to the case-mounted key switch to allow keyboard locking.

## 19. Speaker Connector (SPEAKER, 4 pins)

This 4-pin connector connects to the case-mounted speaker.

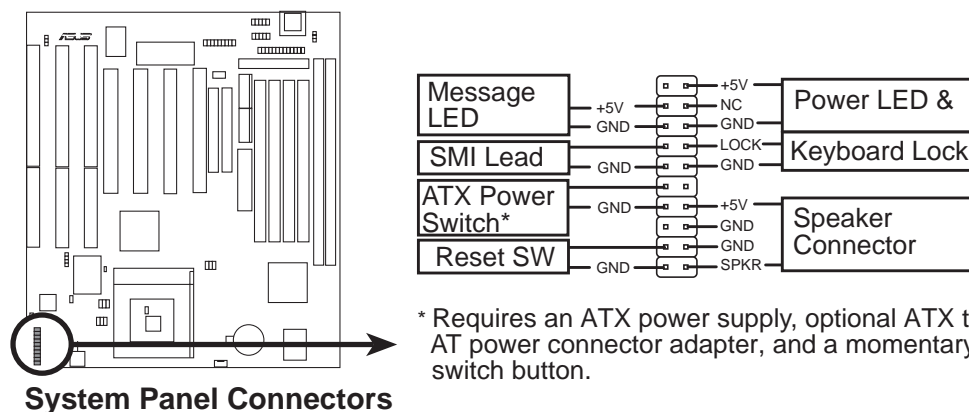

# III. INSTALLATION

## 20. Wake on LAN Activity Connector (3-pin WAKE\_LAN)

The WAKE\_LAN connector allows the system to power up when there is a wakeup package (signal) received from the network through the ASUS PCI-L101 LAN card. Requires the ASUS PCI-L101 and an ATX power supply with at least 720mA 5VSB.

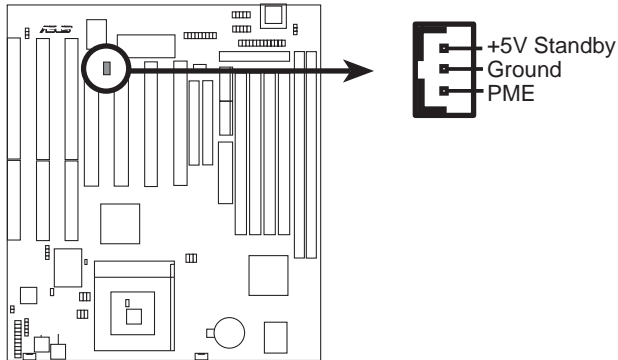

**Wake on LAN Activity**

# III. INSTALLATION

---

## Power Connection Procedures

1. After all jumpers and connections are made, close the system case cover.
  2. Be sure that all switches are off (in some systems, marked with ○).
  3. Connect the power supply cord into the power supply located on the back of your system case according to your system user's manual.
  4. Connect the power cord into a power outlet that is equipped with a surge protector.
  5. You may then turn on your devices in the following order:
    - a. Your monitor
    - b. External SCSI devices (starting with the last device on the chain)
    - c. Your system power. For ATX power supplies, you need to switch on the power supply as well as press the ATX power switch on the front of the case.
  6. The power LED on the front panel of the system case will light. For ATX power supplies, the system LED will light when the ATX power switch is pressed. The monitor LED may light up after the system's if it complies with "green" standards or if it has a power standby feature. The system will then run power-on tests. While the tests are running, additional messages will appear on the screen. If you do not see anything within 30 seconds from the time you turn on the power, the system may have failed a power-on test. Recheck your jumper settings and connections or call your retailer for assistance.
  7. During power-on, hold down <Delete> to enter BIOS setup. Follow the instructions in the next section, BIOS SOFTWARE.
- \* **Powering Off your computer:** You must first exit or shut down your operating system before switching off the power switch. For ATX power supplies, you can press the ATX power switch after exiting or shutting down your operating system. If you use Windows 95, click the **Start** button, click **Shut Down**, and then click **Shut down the computer?**. The system will give three quick beeps after about 30 seconds and then power off after Windows shuts down.

**NOTE:** The message "You can now safely turn off your computer" will not appear when shutting down with ATX power supplies.

# IV. BIOS SOFTWARE

## Support Software

**PFLASH.EXE** - This is the Flash Memory Writer utility that updates the BIOS by uploading a new BIOS file to the programmable flash ROM chip on the motherboard. To determine the BIOS version, check the last four numbers of the code displayed on the upper left-hand corner of your screen during bootup. Larger numbers represent a newer BIOS file. This file works in DOS or Windows mode.

**NOTE:** The following screen contents in this user's manual are provided as examples only and may not reflect the screen contents displayed on your system.

## Flash Memory Writer Utility

**IMPORTANT!** If “unknown” is displayed after **Flash Type --**, the memory chip is either not programmable or is not supported with the PnP BIOS and therefore cannot be programmed by the Flash Memory Writer utility.



```
ASUSTek PnP BIOS
FLASH MEMORY WRITER V1.5
Copyright (C) 1995, ASUSTek COMPUTER INC.

Flash Type -- INTEL 28F001BKT
Current BIOS Revision: #40190-0204-0
Choose one of the following:
1. Save Current BIOS To File
2. Update BIOS Main Block From File
3. Advanced Feature

Enter choice: III

Press ESC To Exit
```

### Main Menu

#### 1. Save Current BIOS To File

This option allows you to save a copy of the original motherboard BIOS in case you need to reinstall it. It is recommended that you save PFLASH and the BIOS file to a bootable floppy diskette.

#### 2. Update BIOS Main Block From File

This option updates the BIOS from a file on the disk. The file can be either a new file or a backup file created by the “Save Current BIOS To File” option. If the boot block in the file is different from the current boot block, this option will not update the main block. Instead, it will display the following messages.

## IV. BIOS SOFTWARE

---

```
Update BIOS Main Block From File

Flash Type -- INTEL 28F001BK1
Current BIOS Revision: #40100-0204-0
Please Enter File Name for NEW BIOS: a:\0205.003
Are you Sure (Y/N) ? [Y]

Boot Block of New BIOS is different from old one !!!
Please Use 'Advanced Feature' to flash whole bios !!!

Press ESC To Return to Main Menu
```

### 3. Advanced Features

This option displays the Advanced Features screen for clearing the PnP configuration record and updating the motherboard BIOS.

```
Advanced Feature

Flash Type -- INTEL 28F001BK1
Current BIOS Revision: #40100-0204-0
Choose one of the following:
1. Clear PNP ESCD Parameter Block
2. Update BIOS Including Boot Block and ESCD

Enter choice: [2]

Press ESC To Return to Main Menu
```

### *Advanced Features Menu*

#### 1. Clear PNP ESCD Parameter Block

This option erases the Plug-and-Play (PnP) configuration record.

#### 2. Update BIOS Including Boot Block and ESCD

This option updates the boot block, the baseboard BIOS, and the PnP extended system configuration data (ESCD) parameter block from a new BIOS file.

```
Update BIOS Including Boot Block and ESCD

Flash Type -- INTEL 28F001BK1
Current BIOS Revision: #40100-0204-0
Please Enter File Name for NEW BIOS: 0205.003
Are you Sure (Y/N) ? [Y]

Block Erasing -- Done
Programming -- 1FFF
Block Erasing -- Done
Programming -- 1FFF

Flashed Successfully

Press ESC To Continue
```

# IV. BIOS SOFTWARE

## Managing & Updating your Motherboard's BIOS

### Upon first use of the computer system, you should:

1. Create a bootable system floppy diskette by typing [FORMAT A:/S] from the DOS prompt without creating "AUTOEXEC.BAT" and "CONFIG.SYS" files.
2. Copy PFLASH.EXE to your new diskette.
3. Run PFLASH.EXE from your new diskette and select option 1 "Save Current BIOS to File." Enter the "Current BIOS Revision:" for the file name.

### Updating BIOS Procedures (only when necessary)

**IMPORTANT:** If "unknown" is displayed after **Flash Type** — , the memory chip is not programmable or is not supported with the PnP BIOS and therefore cannot be programmed by the Flash Memory Writer utility.

1. Download an updated ASUS BIOS file from the internet (WWW), FTP, or a BBS (Bulletin Board Service) and save to the diskette you created above. See ASUS CONTACT INFORMATION on Page II of the User's Manual for details.
2. Turn off your computer and open the system cabinet to *Enable* "Boot Block Programming" jumper as shown in section III of the User's Manual.
3. Boot from the floppy diskette you created above.
4. At the "A:\>" prompt, type: [PFLASH] and then the <Enter> key.
5. Enter 2 "Update BIOS Main Block From File" from the Main Menu or option 2 "Update BIOS Including Boot Block and ESCD" from the Advanced Features Menu if prompted by option 2 of the Main Menu.
6. The program displays a second screen prompting you for the name of the BIOS file. Type in the complete file name and extension of the new BIOS, and then press the <Enter> key. The utility then updates the BIOS file from disk.

**WARNING!** If you encounter problems while updating the new BIOS, DO NOT turn off your system since this might prevent your system from booting up. Just repeat the process, and if the problem still persists, update the original BIOS file you saved to disk above. If the Flash Memory Writer utility was not able to successfully update a complete BIOS file, your system may not be able to boot up. If this happens, your system will need service.

7. After successfully updating the new BIOS file, exit the Flash Memory Writer utility and then turn off your system. Set the jumper back to its default setting of Programming "*Disabled or Protected.*"
8. Turn on your computer and hold down the <Delete> key to enter BIOS setup. You must select "Setup Default" to affect the new BIOS, then you may set other items from the Main Menu.



# IV. BIOS SOFTWARE

## 6. BIOS Setup

The motherboard supports two programmable Flash ROM chips: 5 volt and 12 volt. Either of these memory chips can be updated when BIOS upgrades are released. Use the Flash Memory Writer utility to download the new BIOS file into the ROM chip as described in detail in this section.

All computer motherboards provide a Setup utility program for specifying the system configuration and settings. If your motherboard came in a computer system, the proper configuration entries may have already been made. If so, invoke the Setup utility, as described later, and take note of the configuration settings for future reference; in particular, the hard disk specifications.

If you are installing the motherboard, reconfiguring your system or you receive a Run Setup message, you will need to enter new setup information. This section describes how to configure your system using this utility.

The BIOS ROM of the system stores the Setup utility. When you turn on the computer, the system provides you with the opportunity to run this program. This appears during the Power-On Self Test (POST). Press <Delete> to call up the Setup utility. If you are a little bit late pressing the mentioned key(s), POST will continue with its test routines, thus preventing you from calling up Setup. If you still need to call Setup, reset the system by pressing <Ctrl> + <Alt> + <Delete>, or by pressing the Reset button on the system case. You can also restart by turning the system off and then back on again. But do so only if the first two methods fail.

When you invoke Setup, the CMOS SETUP UTILITY main program screen will appear with the following options:



# IV. BIOS SOFTWARE

## Load Defaults

The **Load BIOS Defaults** option loads the minimum settings for troubleshooting. **Load Setup Defaults**, on the other hand, is for loading optimized defaults for regular use. Choosing defaults at this level will modify all applicable settings.

A section at the bottom of the preceding screen displays the control keys for this screen. Take note of these keys and their respective uses.

## Standard CMOS Setup

**Standard CMOS Setup** allows you to record some basic system hardware configuration and set the system clock and error handling. If the motherboard is already installed in a working system, you will not need to select this option anymore. However, if the configuration stored in the CMOS memory on the board gets lost or damaged, or if you change your system hardware configuration, you will need to respecify the configuration values. The configuration values usually get lost or corrupted when the power of the onboard CMOS battery weakens.

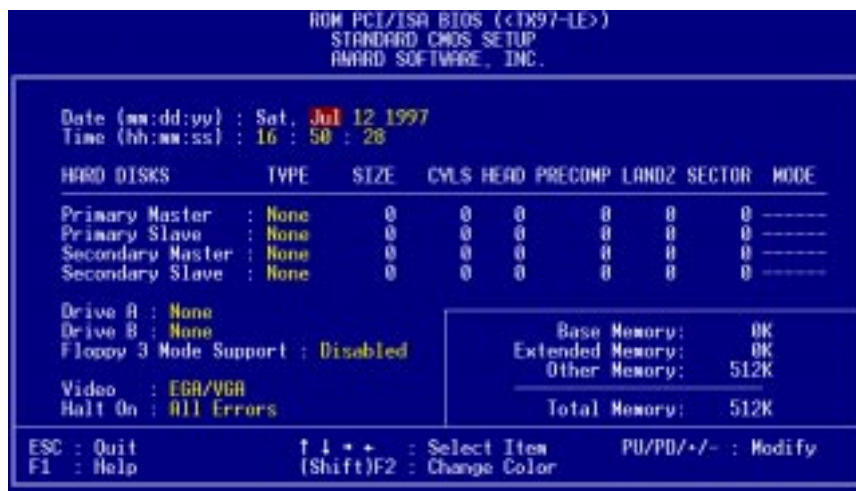

The preceding screen provides you with a list of options. At the bottom of this screen are the control keys. Take note of these keys and their respective uses.

User-configurable fields appear in a different color. If you need information on the selected field, press <F1>. The help menu will then appear to provide you with the information you need. The memory display at the lower right of the screen is read-only and automatically adjusts accordingly.

## Details of Standard CMOS Setup

### Date

To set the date, highlight the “Date” field and then press either <Page Up>/<Page Down> or <+>/<-> to set the current date. Follow the month, day and year format. Valid values for month, day and year are: **Month: (1 to 12), Day: (1 to 31), Year: (up to 2079)**

# IV. BIOS SOFTWARE

---

## Time

To set the time, highlight the “Time” field and then press either <Page Up>/<Page Down> or <+>/<-> to set the current time. Follow the hour, minute and second format. Valid values for hour, minute and second are: **(Hour: (00 to 23), Minute: (00 to 59), Second: (00 to 59)**. If you do not want to modify the current time, press <Enter> three times to go to **Hard Disks**.

**NOTE:** You can bypass the date and time prompts by creating an AUTOEXEC.BAT file. For information on how to create this file, refer to the MS-DOS manual.

## Hard Disk Drives

This field records the specifications for all non-SCSI hard disk drives installed in your system. The onboard PCI IDE connectors provide Primary and Secondary channels for connecting up to four IDE hard disks or other IDE devices. Each channel can support up to two hard disks; the first of which is the “master” and the second is the “slave”.

Specifications for SCSI hard disks need not to be entered here since they operate using device drivers and are not supported by any the BIOS. If you install either the optional PCI-SC200 or PCI-SC860 SCSI controller card into the motherboard, see section VI for instructions. If you install other vendor’s SCSI controller card, refer to their respective documentations on how to install the required SCSI drivers.

### For IDE hard disk drive setup, you can:

- Use the *Auto* setting for detection during bootup.
- Use the IDE HDD AUTO DETECTION in the main menu to automatically enter the drive specifications.
- Enter the specifications yourself manually by using the “User” option.

The entries for specifying the hard disk type include **CYLS** (number of cylinders), **HEAD** (number of read/write heads), **PRECOMP** (write precompensation), **LANDZ** (landing zone), **SECTOR** (number of sectors) and **MODE**. The **SIZE** field automatically adjusts according to the configuration you specify. The documentation that comes with your hard disk should provide you with the information regarding the drive specifications.

The **MODE** entry is for IDE hard disks only, and can be ignored for MFM and ESDI drives. This entry provides three options: *Normal*, *Large*, *LBA*, or *Auto* (see below). Set **MODE** to the *Normal* for IDE hard disk drives smaller than 528MB; set it to *LBA* for drives over 528MB that support Logical Block Addressing (LBA) to allow larger IDE hard disks; set it to *Large* for drives over 528MB that do not support LBA. *Large* type of drive can only be used with MS-DOS and is very uncommon. Most IDE drives over 528MB support the *LBA* mode.

# IV. BIOS SOFTWARE

---

## **Auto detection of hard disks on bootup**

For each field: Primary Master, Primary Slave, Secondary Master, and Secondary Slave, you can select *Auto* under the TYPE and MODE fields. This will enable auto detection of your IDE hard disk during bootup. This will allow you to change your hard disks (with the power off) and then power on without having to reconfigure your hard disk type. If you use older hard disks that do not support this feature, then you must configure the hard disk in the standard method as described earlier by the “User” option.

**NOTE:** After the IDE hard disk drive information has been entered into BIOS, new IDE hard disk drives must be partitioned (such as with FDISK) and then formatted before data can be read from and write on. Primary IDE hard disk drives must have its partition set to *active* (also possible with FDISK).

**NOTE:** SETUP Defaults are noted in parenthesis next to each function heading.

## **Drive A / Drive B (None)**

These fields record the types of floppy disk drives installed in your system. The available options for drives A and B are: *360KB, 5.25 in.; 1.2MB, 5.25 in.; 720KB, 3.5 in.; 1.44MB, 3.5 in.; 2.88MB, 3.5 in.; None*

To enter the configuration value for a particular drive, highlight its corresponding field and then select the drive type using the left- or right-arrow keys.

## **Floppy 3 Mode Support (Disabled)**

This is the Japanese standard floppy drive. The standard stores 1.2MB in a 3.5inch diskette. This is normally disabled but you may choose from either: *Drive A, Drive B, Both, and Disabled*

## **Video (EGA/VGA)**

Set this field to the type of video display card installed in your system. The options are *EGA/VGA, CGA 49, CGA 80, and Mono* (for Hercules or MDA).

If you are using a VGA or any higher resolution card, choose *EGA/VGA*.

## **Halt On (All Errors)**

This field determines which types of errors will cause the system to halt. Choose from *All Errors; No Errors; All,But Keyboard, All,But Diskette; and All,But Disk/Key*.

# IV. BIOS SOFTWARE

## BIOS Features Setup

**BIOS Features Setup** consists of configuration entries that allow you to improve your system performance, or let you set up some system features according to your preference. Some entries are required by the motherboard's design to remain in their default settings.



A section at the lower right of the screen displays the control keys you can use. Take note of these keys and their respective uses. If you need information on a particular entry, highlight it and then press <F1>. A pop-up help menu will appear to provide you with the information you need. <F5> loads the last set values, <F6> and <F7> loads the BIOS default values and Setup default values, respectively.

**NOTE:** SETUP Defaults are noted in parenthesis next to each function heading.

### Details of BIOS Features Setup

#### Virus Warning (Disabled)

This field protects the boot sector and partition table of your hard disk against accidental modifications. Any attempt to write to them will cause the system to halt and display a warning message. If this occurs, you can either allow the operation to continue or use a bootable virus-free floppy disk to reboot and investigate your system. This setting is recommended because of conflicts with new operating systems or some programs. Installation of these programs requires that you disable *Virus Warning* to prevent write errors.

#### CPU Internal Cache (Enabled)

Choose *Disable* to turn off the CPU's built-in level 1 cache.

#### External Cache (Enabled)

Choose *Disable* to turn off the CPU's external level 2 cache (Pentium Pro is built-in).

#### Quick Power On Self Test (Enabled)

This field speeds up the Power-On Self Test (POST) routine by skipping retesting a second, third, and fourth time. Setup default setting for this field is *Enabled*. A complete test of the system is done on each test.



# IV. BIOS SOFTWARE

---

## **HDD Sequence SCSI/IDE First (IDE)**

When using both SCSI and IDE hard disk drives, IDE is always the boot disk using drive letter C (default setting of *IDE*). This new feature allows a SCSI hard disk drive to be the boot disk when set to *SCSI*. This allows multiple operating systems to be used on both IDE and SCSI drives or the primary operating system to boot using a SCSI hard disk drive.

## **Boot Sequence (C,A)**

This field determines where the system looks first for an operating system. Options are *C,A; A,CDROM,C; CDROM,C,A; D,A; E,A; F,A; A,C* and *C only*; The setup default setting is to check first the hard disk and then the floppy disk drive; that is, *C, A*.

## **Boot Up Floppy Seek (Disabled)**

When enabled, the BIOS will seek drive A one time.

## **Floppy Disk Access Control (R/W)**

This allows protection of files from the computer system to be copied to floppy disk drives by allowing the setting of *Read Only* to only allow reads from the floppy disk drive but not writes. The setup default *R/W* allows both reads and writes.

## **IDE HDD Block Mode Sectors (HDD MAX)**

This field enhances hard disk performance by making multi-sector transfers instead of one sector per transfer. Most IDE drives, except older versions, can utilize this feature. Selections are *HDD MAX, Disabled, 2, 4, 8, 16, and 32*.

## **Security Option (System)**

This field determines when the system prompts for the password. The default setting is *System*, where the system prompts for the User Password every time you boot up. The other option is *Setup*, where the system always boots up, and prompts for the Supervisor Password only when the Setup utility is called up. You can specify a password by using the *Supervisor Password* or *User Password* option from the main screen as explained later in this section.

## **PS/2 Mouse Function Control (Auto)**

The setting of *Auto* allows the system to detect a PS/2 Mouse on bootup. If detected, IRQ12 will be used for the PS/2 Mouse. If not detected, IRQ12 will be reserved for expansion cards. *Enabled* will reserve IRQ12 for the PS/2 Mouse.

## **PCI/VGA Palette Snoop (Disabled)**

Some display cards that are nonstandard VGA such as graphics accelerators or MPEG Video Cards may not show colors properly. The setting *Enabled* should correct this problem. Otherwise leave this on the setup default setting of *Disabled*.

## **OS/2 Onboard Memory > 64M (Disabled)**

When using OS/2 operating systems with installed DRAM of greater than 64MB, you need to *Enable* this option otherwise leave this on the setup default of *Disabled*.

.....

## **Video ROM BIOS Shadow (Enabled)**

This field allows you to change the video BIOS location from ROM to RAM. Relocating to RAM enhances system performance, as information access is faster than the ROM.

# IV. BIOS SOFTWARE

## C8000 - CBFFF Shadow to DC000 - DFFFF Shadow (Disabled)

These fields are used for shadowing other expansion card ROMs. If you install other expansion cards with ROMs on them, you will need to know which addresses the ROMs use to shadow them specifically. Shadowing a ROM reduces the memory available between 640KB and 1024KB by the amount used for this purpose.

## Boot Up NumLock Status (On)

This field enables users to activate the Number Lock function upon system boot.

## Typematic Rate Setting (Disabled)

When enabled, you can set the two typematic controls listed below. Default setting is *Disabled*.

## Typematic Rate (Chars/Sec) (6)

This field controls the speed at which the system registers repeated keystrokes. Options range from 6 to 30 characters per second. Setup default setting is **6**; other settings are **8, 10, 12, 15, 20, 24, and 30**.

## Typematic Delay (Msec) (250)

This field sets the time interval for displaying the first and second characters. Four delay rate options are available: 250, 500, 750, and 1000.

## Chipset Features Setup

This “Chipset Features Setup” option controls the configuration of the board’s chipset. Control keys for this screen are the same as in the **BIOS Features Setup** screen.



**NOTE:** SETUP Defaults are noted in parenthesis next to each function heading.

### Details of Chipset Features Setup

#### Auto Configuration (60ns DRAM)

The default setting of *60ns DRAM* sets the optimal timings for items 2 through 9 for 60ns DRAM modules. If you are using 70ns DRAM modules, you must change this item to *70ns DRAM*. See section III for DRAM installation information.

IV. BIOS  
(Chipset Features)



## IV. BIOS SOFTWARE

---

### **SDRAM CAS# Latency (3T)**

If you use ASUS SDRAM DIMM modules, you can set this to *2T* for better performance, otherwise leave on default or check with your vendor for DIMM specs.

### **SDRAM Speculative Read (Disabled)**

If *Enabled*, the CPU will issue predict commands to access the DRAM, if a miss occurs, the CPU will cancel this command. Some operating systems under certain situations have a problem utilizing this feature so it is normally *Disabled*.

### **Passive Release (Enabled)**

This is a mechanism that allows concurrency of ISA/EISA cycles and CPU-to-PCI cycles. When this feature is enabled, the TXC will be possible to re-arbitrate PCI bus and allow the CPU to access PCI even when the PCEB has been granted the bus.

### **Delayed Transaction (Disabled)**

If *Enabled*, this frees the PCI Bus during CPU accessing of 8-bit ISA cards which normally consume about 50-60 PCI Clocks without PCI delayed transaction. If PCI Bus Masters cannot use the PCI Bus, leave this on the default setting of *Disabled* for some ISA cards that are not PCI 2.1 compliant.

### **16-bit I/O Recovery Time (1 BUSCLK)**

Timing for 16-bit ISA cards

### **8-bit I/O Recovery Time (1 BUSCLK)**

Timing for 8-bit ISA cards

### **Video BIOS Cacheable (Enabled)**

Allows the Video BIOS to be cached to allow faster execution. Leave on default setting of *Enabled* for better performance, otherwise *Disabled*.

### **Memory Hole at Address (None)**

This features reserves either *14MB-16MB* or *15MB-16MB* memory address space to ISA expansion cards that specifically require this setting. Memory from 14MB and up or 15MB and up will be unavailable to the system because expansion cards can only access memory up to 16MB.

.....

### **Onboard FDC Controller (Enabled)**

When enabled, this field allows you to connect your floppy disk drives to the on-board floppy drive connector instead of a separate controller card. If you want to use a different controller card to connect the floppy drives, set this field to *Disabled*.

### **Onboard FDC Swap A: B: (No Swap)**

This field allows you to reverse the hardware drive letter assignments of your floppy disk drives. Two options are available: *Swap AB* and *No Swap* (default). If you want to switch drive letter assignments, set this field to *Swap AB*, and the swap will be controlled by the onboard chipset.

## IV. BIOS SOFTWARE

---

### **Onboard Serial Port 1 (3F8H/IRQ4)**

Settings are *3F8H/IRQ4*, *2F8H/IRQ3*, *3E8H/IRQ4*, *2E8H/IRQ10*, and *Disabled* for the onboard serial connector.

### **Onboard Serial Port 2 (2F8H/IRQ3)**

Settings are *3F8H/IRQ4*, *2F8H/IRQ3*, *3E8H/IRQ4*, *2E8H/IRQ10*, and *Disabled* for the onboard serial connector.

### **Onboard Parallel Port (378H/IRQ7)**

This field sets the address of the onboard parallel port connector. You can select either *3BCH/IRQ7*, *378H/IRQ7*, *278H/IRQ5*, or *Disabled*. If you install an I/O card with a parallel port, ensure that there is no conflict in the address assignments. The PC can support up to three parallel ports as long as there are no conflicts for each port.

### **Parallel Port Mode (ECP+EPP)**

This field allows you to set the operation mode of the parallel port. The setting *Normal*, allows normal-speed operation but in one direction only; *EPP* allows bidirectional parallel port operation at maximum speed; *ECP* allows the parallel port to operate in bidirectional mode and at a speed faster than the maximum data transfer rate; *ECP+EPP* allows normal speed operation in a two-way mode.

### **ECP DMA Select (3)**

This selection is available only if you select *ECP* or *ECP+EPP* in the **Parallel Port Mode**. Select either DMA Channel *1*, *3*, or *Disabled*.

### **UART2 Use Infrared (Disabled)**

When enabled, this field activates the onboard infrared feature and sets the second serial UART to support the infrared module connector on the motherboard. If your system already has a second serial port connected to the onboard COM2 connector, it will no longer work if you enable the infrared feature. By default, this field is set to *Disabled*, which leaves the second serial port UART to support the COM2 serial port connector.

### **Onboard PCI IDE Enable (Both)**

You can select to enable the *Primary* IDE channel, *Secondary* IDE channel, *Both*, or *Disable* both channels (for systems with only SCSI drives).

### **IDE Ultra DMA Mode (Auto)**

This sets the IDE UltraDMA to be active when using UltraDMA-capable IDE devices. The BIOS will automatically adjust or disable this setting for slower IDE devices so that Auto or high settings will not cause problems for older IDE devices. Choose *Disable* if you do not want this feature for all devices.

### **IDE 0 Master/Slave PIO/DMA Mode, IDE 1 Master/Slave PIO/DMA Mode (Auto)**

Each channel (0 and 1) has both a master and a slave making four IDE devices possible. Because each IDE device may have a different Mode timing (0, 1, 2, 3, 4), it is necessary for these to be independent. PIO and DMA timings can be independently set. The default setting of *Auto* will allow autodetection to ensure optimal performance.

# IV. BIOS SOFTWARE

## Power Management Setup

This “Power Management Setup” option allows you to reduce power consumption. This feature turns off the video display and shuts down the hard disk after a period of inactivity.

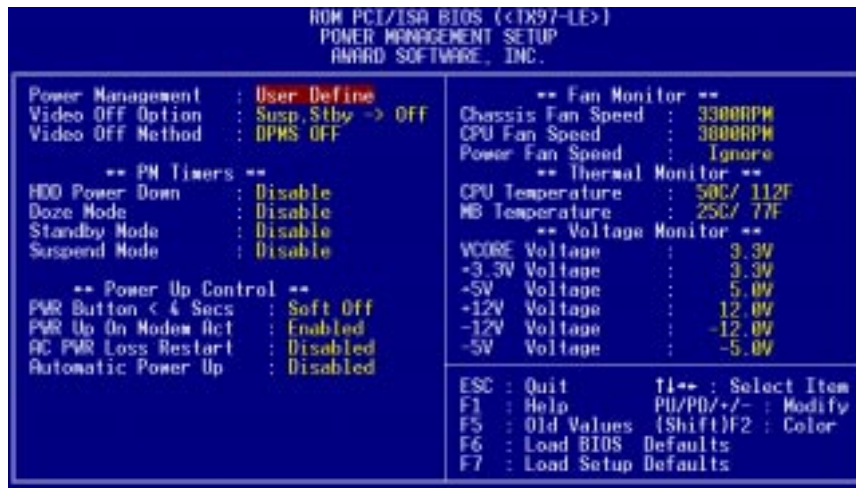

**NOTE:** SETUP Defaults are noted in parenthesis next to each function heading.

### Details of Power Management Setup

#### Power Management (User Define)

This field acts as the master control for the power management modes. *User Define* allows you to set power saving options according to your preference; *Disable* disables the power saving features; *Min Saving* puts the system into power saving mode after 40 min of system inactivity; *Max Saving* puts the system into power saving mode after 30 sec of system inactivity.

**IMPORTANT:** Advanced Power Management (APM) should be installed to keep the system time updated when the computer enters suspend mode activated by the BIOS Power Management. For DOS environments, you need to add `DEVICE=C:\DOS\POWER.EXE` in you `CONFIG.SYS`. For Windows 3.x and Windows 95, you need to install Windows with the APM feature. A battery and power cord icon labeled “Power” will appear in the “Control Panel.” Choose “Advanced” in the Power Management Field.

#### Video Off Option (Susp,Stby -> Off )

This field determines when to activate the video off feature for monitor power management. The settings are *All Modes -> Off*; *Always On*; *Suspend -> Off*; and *Susp,Stby -> Off*.

# IV. BIOS SOFTWARE

---

## **Video Off Method (DPMS OFF)**

This field defines the video off features. These options are available: *DPMS OFF*, *DPMS Reduce ON*, *Blank Screen*, *V/H SYNC+Blank*, *DPMS Standby*, and *DPMS Suspend*. The DPMS (Display Power Management System) features allow the BIOS to control the video display card if it supports the DPMS feature. *Blank Screen* only blanks the screen (or monitors without power management or “green” features). If set up in your system, your screen saver will not display with *Blank Screen* selected). *V/H SYNC+Blank* blanks the screen and turns off vertical and horizontal scanning.

.....

## **PM Timers**

This section controls the time-out settings for the Power Management scheme. The fields included in this section are **HDD Power Down**, which places the hard disk into its lowest power consumption mode, and the **Doze**, **Standby** and **Suspend** system inactivation modes.

The system automatically “wakes up” from any power saving mode when there is system activity, such as when a key is pressed from the keyboard, or when there is activity detected from the enabled IRQ channels.

### **HDD Power Down (Disable)**

This shuts down any IDE hard disk drives in the system after a period of inactivity. This time period is user-configurable to *1-15 Mins* or *Disable*. This feature does not affect SCSI hard disks.

### **Suspend Mode (Disable)**

These fields set the period of time after which each of these modes activate: *30 Sec*, *1 Min*, *2 Min*, *4 Min*, *8 Min*, *20 Min*, *30 Min*, *40 Min*, *1 Hour*, and *Disable*.

.....

## **Power Up Control**

This section determines the ways the system can be controlled when it is started or restarted, when modem activity is detected, or when power to the computer is interrupted and reapplied. The Soft-Off mode refers to powering off the system through a momentary button switch (ATX switch) or through the software as opposed to disconnecting the AC power by way of a rocker switch or other means.

### **PWR Button < 4 Secs (Soft Off)**

When set to *Soft Off*, the ATX switch can be used as a normal system power-off button when pressed for less than 4 seconds. *Suspend* allows the button to have a dual function where pressing less than 4 seconds will place the system in sleep mode. *No Function* disables the ATX switch function when the button is pressed under 4 seconds. Regardless of the setting, holding the ATX switch for more than 4 seconds will power off the system.

### **PWR Up On Modem Act (Enabled)**

This allows either settings of *Enabled* or *Disabled* for powering up the computer (turns the ATX power supply on) when the modem receives a call while the computer is off. NOTE: The computer cannot receive or transmit data until the computer and applications are fully running, thus connection cannot be made on the first try. Turning an external modem off and then back on while the computer is off causes an initialization string that will also cause the system to power on.



# IV. BIOS SOFTWARE

## AC PWR Loss Restart (Disabled)

This allows you to set whether you want your system to boot up after the power has been interrupted. *Disabled* leaves your system off after reapplying power and *Enabled* boots up your system after reapplying power.

## Automatic Power Up (Disabled)

This allows you to have an unattended or automatic power up of your system. You may configure your system to power up at a certain time of the day by selecting *Every-day*, which will allow you to set the time or at a certain time and day by selecting *By Date*.

## Fan Monitor (xxxxRPM)

The onboard hardware monitor is able to detect the Chassis Fan Speed, CPU Fan Speed, and the Power Supply Fan Speed in Rotations Per Minute (RPM). These values refresh upon any key entries in the BIOS setup screen. Set to *Ignore* if one of these are not used so that error messages will not be given.

## Thermal Monitor (xxxC/xxxF)

The onboard hardware monitor is able to detect the CPU and MB (motherboard) temperatures. These values refresh upon key entries. Set to *Ignore* only if necessary.

## Voltage Monitor (xx.xV)

The onboard hardware monitor is able to detect the voltages put out by the voltage regulators. These values refresh upon key entries. Set to *Ignore* only if necessary.

**NOTE:** If any of the monitored items are out of range, an error message will appear: "Hardware Monitor found an error, enter POWER MANAGEMENT SETUP for details". You will then be prompted to "Press **F1** to continue, **DEL** to enter SETUP".

## PNP and PCI Setup

This "PNP and PCI Setup" option configures the PCI bus slots. All PCI bus slots on the system use INTA#, thus all installed PCI cards must be set to this value.

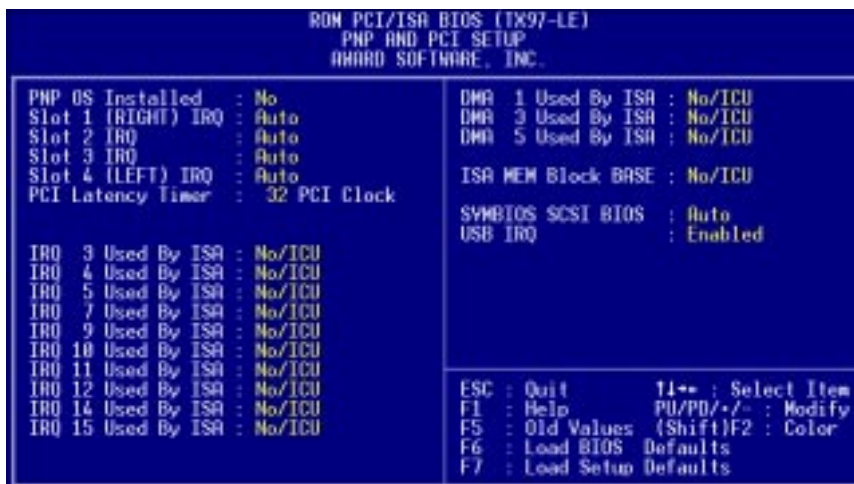

## IV. BIOS SOFTWARE

---

**NOTE:** SETUP Defaults are noted in parenthesis next to each function heading.

### *Details of PNP and PCI Setup*

#### **PNP OS Installed (No)**

This field allows you to use a Plug-and-Play (PnP) operating system to configure the PCI bus slots instead of using the BIOS. Thus interrupts may be reassigned by the OS when *Yes* is selected. When a non-PnP OS is installed or to prevent reassigning of interrupt settings, select the default setting of *No*.

#### **Slot 1 (RIGHT) IRQ to Slot 4 (LEFT) IRQ (Auto)**

These fields set how IRQ use is determined for each PCI slot. The default setting for each field is *Auto*, which uses auto-routing to determine IRQ use. The other options are manual settings of *NA, 5, 7, 9, 10, 11, 12, 14* or *15* for each slot.

#### **PCI Latency Timer (32 PCI Clock)**

The default setting of *32 PCI Clock* enables maximum PCI performance.

#### **IRQ xx Used By ISA (No/ICU)**

These fields indicate whether or not the displayed IRQ for each field is being used by a legacy (non-PnP) ISA card. Two options are available: *No/ICU* and *Yes*. The first option, the default value, indicates either that the displayed IRQ is not used or an ISA Configuration Utility (ICU) is being used to determine if an ISA card is using that IRQ. If you install a legacy ISA card that requires a unique IRQ, and you are not using an ICU, you must set the field for that IRQ to *Yes*. For example: If you install a legacy ISA card that requires IRQ 10, then set **IRQ10 Used By ISA** to *Yes*.

.....

#### **DMA x Used By ISA (No/ICU)**

These fields indicate whether or not the displayed DMA channel for each field is being used by a legacy (non-PnP) ISA card. Available options include: *No/ICU* and *Yes*. The first option, the default setting, indicates either that the displayed DMA channel is not used or an ICU is being used to determine if an ISA card is using that channel. If you install a legacy ISA card that requires a unique DMA channel, and you are not using an ICU, you must set the field for that channel to *Yes*.

#### **ISA MEM Block BASE (No/ICU)**

This field allows you to set the base address and block size of a legacy ISA card that uses any memory segment within the C800H and DFFFH address range. If you have such a card, and you are not using an ICU to specify its address range, select a base address from the six available options; the **ISA MEM Block SIZE** field will then appear for selecting the block size. If you have more than one legacy ISA card in your system that requires to use this address range, you can increase the block size to either 8K, 16K, 36K, or 64K. If you are using an ICU to accomplish this task, leave **ISA MEM Block BASE** to its default setting of *No/ICU*.

#### **SYMBIOS SCSI BIOS (Auto)**

The default uses *Auto* settings for the onboard SCSI BIOS. If you do not want to use the onboard SCSI BIOS, choose *Disabled*.

# IV. BIOS SOFTWARE

## Load BIOS Defaults

This “Load BIOS Defaults” option allows you to load the troubleshooting default values permanently stored in the BIOS ROM. These default settings are non-optimal and disable all high performance features. To load these default settings, highlight “Load BIOS Defaults” on the main screen and then press <Enter>. The system displays a confirmation message on the screen. Press <Y> and then <Enter> to confirm. Press <N> and then <Enter> to abort. This feature does not affect the fields on the Standard CMOS Setup screen.

## Load Setup Defaults

This “Load Setup Defaults” option allows you to load the default values to the system configuration fields. These default values are the optimized configuration settings for the system. To load these default values, highlight “Load Setup Defaults” on the main screen and then press <Enter>. The system displays a confirmation message on the screen. Press <Y> and then <Enter> to confirm. Press <N> and then <Enter> to abort. This feature does not affect the fields on the Standard CMOS Setup screen.



IV. BIOS  
(Load Defaults)



# IV. BIOS SOFTWARE

## Supervisor Password and User Password

These two options set the system passwords. “Supervisor Password” sets a password that will be used to protect the system and the Setup utility; “User Password” sets a password that will be used exclusively on the system. By default, the system comes without any passwords. To specify a password, highlight the type you want and then press <Enter>. A password prompt appears on the screen. Taking note that the password is case sensitive, and can be up to 8 alphanumeric characters long, type in your password and then press <Enter>. The system confirms your password by asking you to type it again. After setting a password, the screen automatically reverts to the main screen.



To implement password protection, specify in the “Security Option” field of the BIOS Features Setup screen when the system will prompt for the password. If you want to disable either password, press <Enter> instead of entering a new password when the “Enter Password” prompt appears. A message confirms the password has been disabled.

**NOTE:** If you forget the password, see CMOS RAM in section III for procedures on clearing the CMOS.

# IV. BIOS SOFTWARE

## IDE HDD Auto Detection

This “IDE HDD Auto Detection” option detects the parameters of an IDE hard disk drive, and automatically enters them into the Standard CMOS Setup screen.

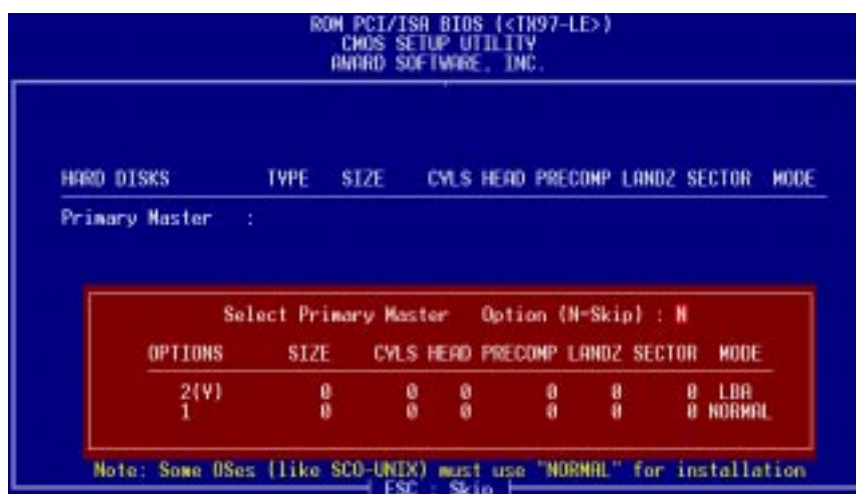

Up to four IDE drives can be detected, with parameters for each listed inside the box. To accept the optimal entries, press <Y> or else select from the numbers displayed under the OPTIONS field (2, 1, 3 in this case); to skip to the next drive, press <N>. If you accept the values, the parameters will appear listed beside the drive letter on the screen. The process then proceeds to the next drive letter. Pressing <N> to skip rather than to accept a set of parameters causes the program to enter zeros after that drive letter.

Remember that if you are using another IDE controller that does not feature Enhanced IDE support for four devices, you can only install two IDE hard disk drives. Your IDE controller must support the Enhanced IDE features in order to use Drive E and Drive F. The onboard PCI IDE controller supports Enhanced IDE, with two connectors for connecting up to four IDE devices. If you want to use another controller that supports four drives, you must disable the onboard IDE controller in the Chipset Features Setup screen.

When auto-detection is completed, the program automatically enters all entries you accepted on the field for that drive in the Standard CMOS Setup screen. Skipped entries are ignored and are not entered in the screen.

If you are auto-detecting a hard disk that supports the LBA mode, three lines will appear in the parameter box. Choose the line that lists LBA for an LBA drive. Do not select Large or Normal.

The auto-detection feature can only detect one set of parameters for a particular IDE hard drive. Some IDE drives can use more than one set. This is not a problem if the drive is new and empty.

## IV. BIOS SOFTWARE

**IMPORTANT:** If your hard disk was already formatted on an older previous system, incorrect parameters may be detected. You will need to enter the correct parameters manually or use low-level format if you do not need the data stored on the hard disk.

If the parameters listed differ from the ones used when the disk was formatted, the disk will not be readable. If the auto-detected parameters do not match the ones that should be used for your disk, do not accept them. Press <N> to reject the presented settings and enter the correct ones manually from the Standard CMOS Setup screen.

### Save & Exit Setup

Select this option to save into the CMOS memory all modifications you specified during the current session. To save the configuration changes, highlight the “Save & Exit Setup” option on the main screen, type “Y”, and then press <Enter>.



### Exit Without Saving

Select this option to exit the Setup utility without saving the modifications you specify during the current session. To exit without saving, highlight the “Exit Without Saving” option on the main screen and then press <Enter>.

---

(This page was intentionally left blank)

# V. SUPPORT SOFTWARE

---

## ASUS Smart Motherboard Support CD 3.10

(Included only with motherboards with onboard LM78 hardware monitoring)

**Inserting the support CD brings up a selection menu described as follows:**

(NOTE: CD version and contents are constantly modified without notice.)

- **LDCM Local Setup:** Installs software to monitor the local system. The LANDesk Client Manager must be installed in order to use the hardware manager features.
- **LDCM Administrator Setup:** Installs software to monitor PC systems on the network within the same bridge address with the Local software installed. The administrator should install both Local and Administrator Software.
- **Adobe Acrobat Reader:** Installs the Adobe Acrobat Reader software necessary to view the LDCM manual in the LDCM directory.
- **BusMaster:** Installs the Intel BusMaster IDE drivers.
- **Patch for PIIX4 chipset:** Installs the necessary drivers for PCI card and PCI bridge for Windows 95/95a (OSR1) and 95b (OSR2) for ASUS motherboards.
- **Browse this CD:** Allows you to see the contents of the ASUS support CD.
- **Technical Support Form:** View the Technical Support Form with Notepad.
- **LDCM Introduction (MPEG):** View a video on the LDCM features.
- **Read Me:** View additional notes with Notepad.
- **Exit:** Exit the selection menu .

**Additional CD contents are:** DMI Configuration utility in the **DMI** directory and Flash BIOS writer in the **PFLASH** directory.

# V. SUPPORT SOFTWARE

---

## Desktop Management Interface (DMI)

### *Introducing the ASUS DMI Configuration Utility*

This motherboard supports DMI within the BIOS level and provides a DMI Configuration Utility to maintain the Management Information Format Database (MIFD). DMI is able to auto-detect and record information pertinent to a computer's system such as the CPU type, CPU speed, and internal/external frequencies, and memory size. The onboard BIOS will detect as many system information as possible and store those collected information in a 4KB block in the motherboard's Flash EPROM and allow the DMI to retrieve data from this database. Unlike other BIOS software, the BIOS on this motherboard uses the same technology implemented for Plug and Play to allow dynamic real-time updating of DMI information versus creating a new BIOS image file and requiring the user to update the whole BIOS. This DMI Configuration Utility also allows the system integrator or end user to add additional information into the MIFD such as serial numbers, housing configurations, and vendor information. Those information not detected by the motherboard BIOS and has to be manually entered through the DMI Configuration Utility and updated into the MIFD. This DMI Configuration Utility provides the same reliability as PnP updating and will prevent the refreshing failures associated with updating the entire BIOS.

### *System Requirements*

The DMI Configuration Utility (DMICFG.EXE) must be used in real mode in order for the program to run, the base memory must be at least 180K. Memory managers like HIMEM.SYS (required by windows) must not be installed. You can boot up from a system diskette without AUTOEXEC.BAT and CONFIG.SYS files, "REM" HIMEM.SYS in the CONFIG.SYS, or press <F5> during bootup to bypass your AUTOEXEC.BAT and CONFIG.SYS files.

# V. SUPPORT SOFTWARE

## Using the ASUS DMI Configuration Utility

### Edit DMI (or delete)

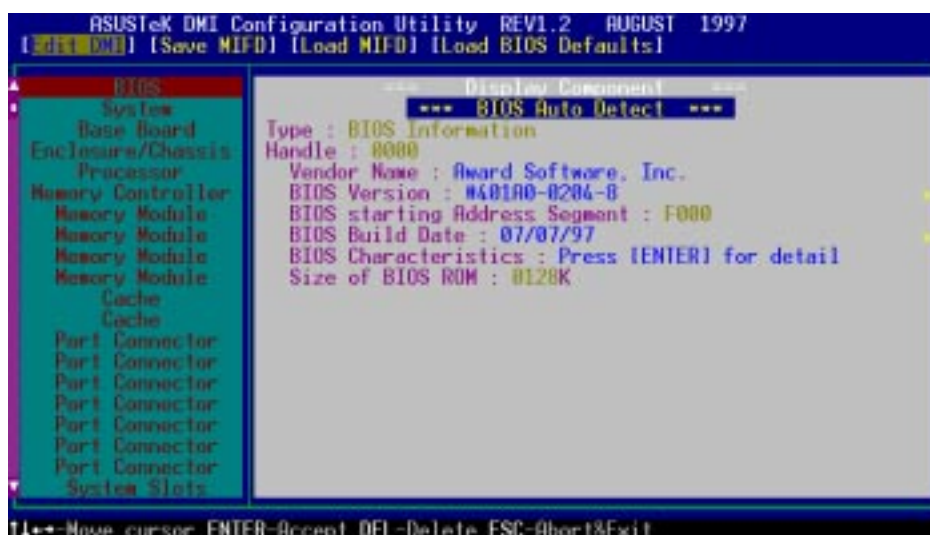

Use the ←→ (left-right) cursors to move the top menu items and the ↑↓ (up-down) cursor to move between the left hand menu items. The bottom of the screen will show the available keys for each screen. Press enter at the menu item to enter the right hand screen for editing. “Edit component” appears on top. The reversed color field is the current cursor position and the blue text are available for editing. The orange text shows auto-detected information and are not available for editing. The blue text “Press [ENTER] for detail” contains a second pop-up menu is available, use the + - (plus-minus) keys to change the settings. Enter to exit *and save*, ESC to exit *and not save*.

If the user has made changes, ESC will prompt you to answer Y or N. Enter Y to go back to the left-hand screen *and save*, enter N to go back to left-hand screen and *not save*. If editing has not been made, ESC will send you back to the left hand menu without any messages.

### Notes

A heading, \*\*\* BIOS Auto Detect, appears on the right for each menu item on the left side that has been auto detected by the system BIOS.

A heading, \*\*\* User Modified, will appear on the right for menu items that have been modified by the user.





# V. SUPPORT SOFTWARE

## Save MIFD

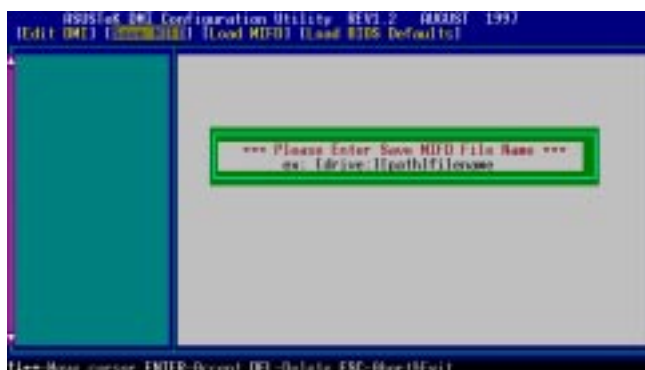

You can save the MIFD (normally only saved to flash ROM) to a file by entering the drive and path here. If you want to cancel save, you may press ESC and a message “Bad File Name” appears here to show it was not saved.

## Load MIFD



You can load the disk file to memory by entering a drive and path and file name here.

## Load BIOS Defaults



You can load the BIOS defaults from a MIFD file and can clear all user modified and added data. You must reboot your computer in order for the defaults to be saved back into the Flash BIOS.

# VI. ASUS PCI SCSI Cards

## Symbios SCSI BIOS and Drivers

Aside from the system BIOS, the Flash memory chip on the motherboard also contains the Symbios SCSI BIOS. This Symbios SCSI BIOS works in conjunction with the optional ASUS PCI-SC200 controller card to provide Fast SCSI-2 interface when using compatible SCSI devices or the ASUS PCI-SC860 SCSI controller cards to provide Ultra-Fast SCSI-2 interface when using Ultra-Fast SCSI-2 devices.

All SCSI devices you install on your system require driver software to function. The Symbios SCSI BIOS directly supports SCSI hard disks under the DOS, Windows and OS/2 environments. It also uses device drivers from the DOS floppy disk included in the ASUS PCI-SC200 and ASUS PCI-SC860 controller card packages to support hard disks and other SCSI devices working under DOS, Microsoft Windows, Microsoft Windows NT, Novell NetWare and IBM OS/2. These drivers provide higher performance than the direct BIOS support. To use these drivers, you must install them into your system and add them to your system configuration files. Driver support for SCSI devices used with SCO UNIX is also provided. These drivers are included in the second SCO UNIX floppy disk. Windows 95 support is also available using the device drivers included within the Windows software. The ASUS PCI-SC200 and ASUS PCI-SC860 are Plug and Play adapters that are auto detected by BIOS and current operating systems that support Plug and Play features.

For information about these drivers and their usage, view the Readme files included in the driver packages.

## ASUS PCI-SC200 & PCI-SC860 SCSI Cards

The ASUS PCI-SC200 or the ASUS PCI-SC860 may be bundled with your motherboard or purchased separately. Both cards provide the option of connecting internal or external SCSI devices for a total of 7 devices on each SCSI card.

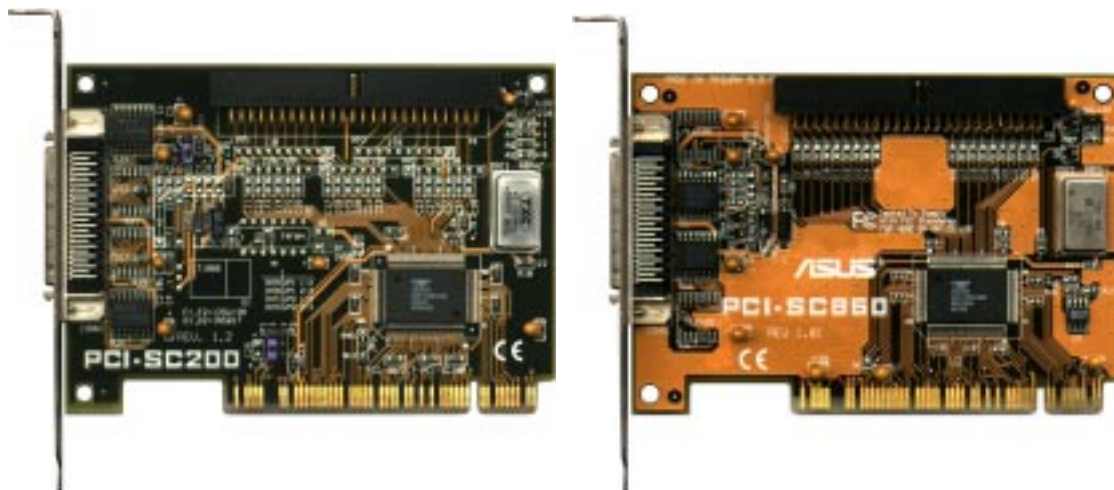

# VI. ASUS PCI SCSI Cards

## Setting Up the ASUS PCI-SC200 & PCI-SC860

There are two jumper settings you may need to make on the ASUS PCI-SC200 to set it up. One setting assigns the PCI INT interrupt, the other sets the card's termination. The ASUS PCI-SC860 has no jumper settings but you should read the "Terminator Requirements."

## Setting the INT Assignment for the ASUS PCI-SC200

You must use PCI INT A setting in order to properly assign the ASUS PCI-SC200's interrupt. On the ASUS PCI-SC200, you assign the INT by setting jumper JP1 or JP2. The default setting for the card already is INT A, so you do not need to change the setting to use the ASUS PCI-SC200 with this motherboard.

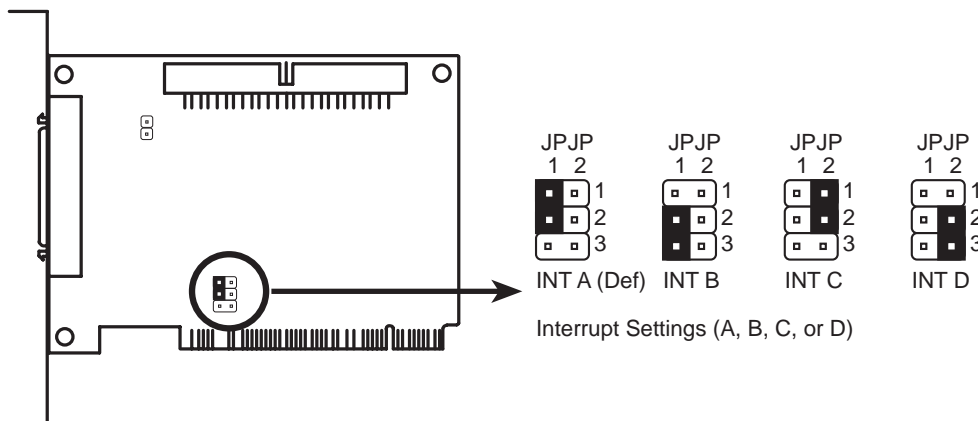

## Terminator Requirements for SCSI Devices

SCSI devices are connected together in a "chain" by cables. Internal devices connect to the ASUS PCI-SC200 or ASUS PCI-SC860 with a fifty-pin flat ribbon cable. External devices connect to the external port with a SCSI-2 cable. If there are more than one internal or external devices, additional devices are connected with cables to form a "daisy chain." Terminating the devices on the ends of the SCSI Bus "chain" is necessary for SCSI devices to work properly. Termination of the devices between the ends must be *Disabled*.

# VI. ASUS PCI SCSI Cards

## Terminator Settings for the ASUS PCI-SC860

Many SCSI devices including the ASUS PCI-SC860 use a set of onboard active resistors to terminate the devices at the ends automatically. Automatic termination requires that the SCSI devices be connected in a straight linear connection or “chain.” Connect SCSI devices to one or two of the SCSI connectors in a linear “chain” for auto termination of the ASUS PCI-SC860 to be effective. Other formations will cause your SCSI devices to not mount properly. You must use the **end** of the ribbon cable when using the internal connector(s) to keep a linear path.

**Additional Note: The Symbios Logic SCSI Configuration Utility is a powerful tool. If, while using it, you somehow disable all your controllers or cannot enter the configuration utility, pressing “Ctrl-A” after memory count during reboot allows you to recover and reconfigure.**

## Terminator Settings for the ASUS PCI-SC200

The ASUS PCI-SC200, on the other hand, has “active” termination that you must set using jumper JP5. There are two settings, “terminated” and “not terminated,” as shown below.

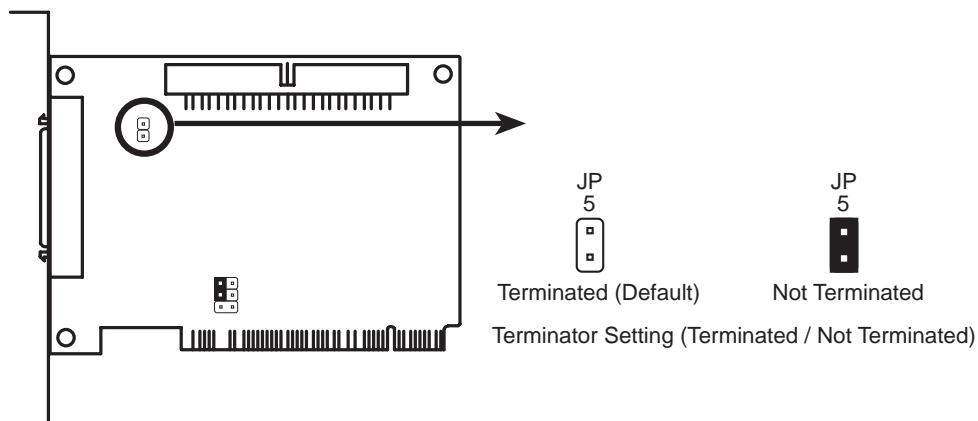

Decide whether or not you need to terminate the ASUS PCI-SC200 based on its position in the SCSI chain. Only the devices at each end of the chain need to be terminated. If you have **only** internal or **only** external devices connected to the ASUS PCI-SC200, then you **must** terminate the ASUS PCI-SC200. If you have **both** internal and external devices connected, you **must not** terminate the card. See the following example which illustrates this concept.

## VI. ASUS PCI SCSI Cards

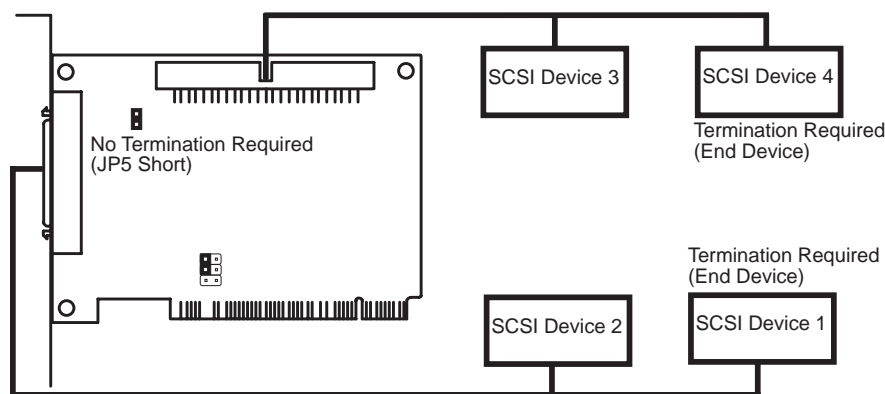
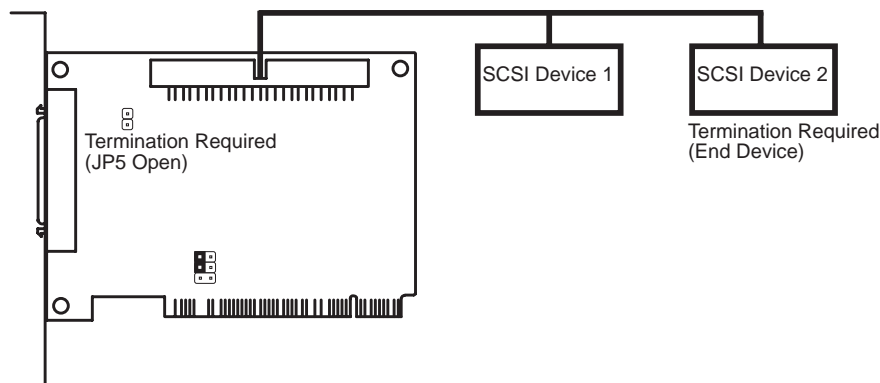

### SCSI ID Numbers for SCSI Devices

All SCSI devices, including the ASUS PCI-SC200 and ASUS PCI-SC860 interface card must have a SCSI identification number that is not in use by any other SCSI device. There are eight possible ID numbers, 0 through 7. The ASUS PCI-SC200 and ASUS PCI-SC860 cards have fixed SCSI IDs of 7. The SCSI ID serves two purposes:

- It uniquely defines each SCSI device on the bus.
- It determines which device controls the bus when two or more devices try to use it at the same time.

SCSI IDs on one channel do not interfere with the IDs on another channel. This applies to two SCSI host adapters that implement different buses as well as dual channels on a single host adapter. You can connect up to seven SCSI devices to the interface card. You must set a SCSI ID number (ID 0 to ID 6) for each device. SCSI devices vary in how they set the ID number. Some use jumpers, others have some kind of selector switch. Refer to the manual for any device you install for details on how to set its ID number.

### SCSI ID Priority

The ASUS PCI-SC200 and ASUS PCI-SC860 are 8bit single-channel SCSI cards. SCSI ID 7 has the highest priority, and SCSI ID 0 has the lowest priority.

# VII. ASUS LAN Card

## ASUS PCI-L101 Fast Ethernet Card

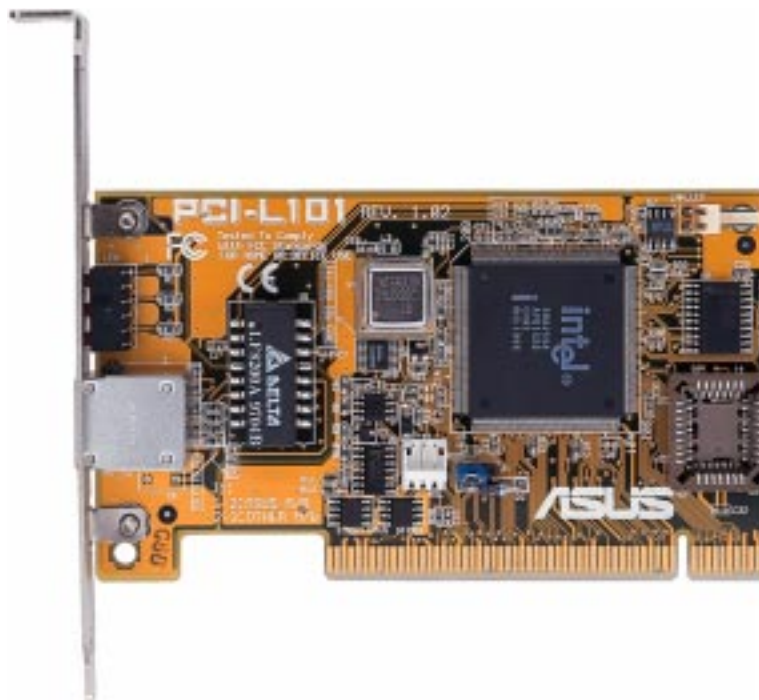

VII. ASUS LAN Card  
(Parts / Layout)

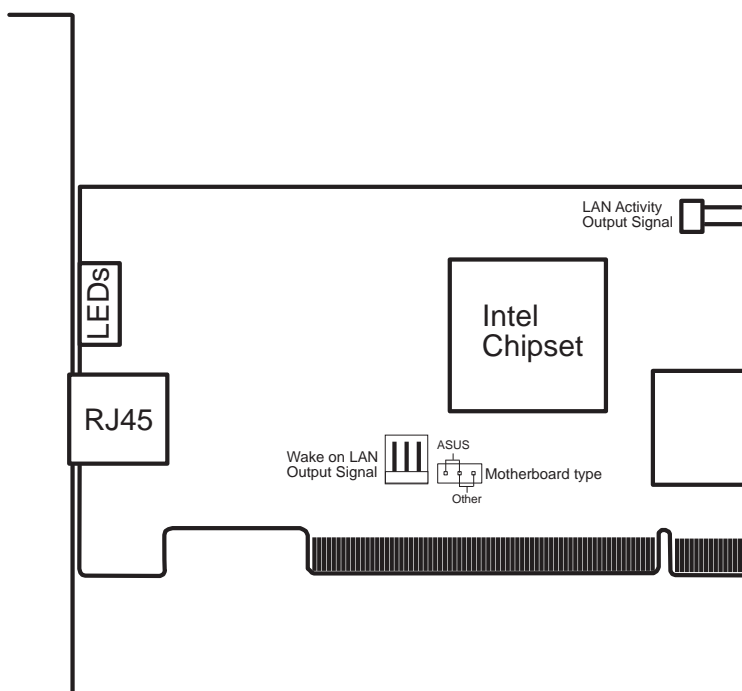

If you are using the ASUS PCI-L101 on an ASUS motherboard, leave the jumper on its default setting of “ASUS.” If you are using another brand of motherboard, set the jumper to “Other.” Connect the Wake on LAN (WOL) output signal to the motherboard’s WOL\_CON in order to utilize the wake on LAN feature of the motherboard. Connect the LAN activity output signal (LAN\_LED) to the system cabinet’s front panel LAN\_LED in order to display the LAN data activity.



# VII. ASUS LAN Card

---

## Features

- Intel 82558 Ethernet LAN Controller (Fully integrated 10BASE-T/100BASE-TX)
- Wake-On-LAN Remote Control Function Supported
- PCI Bus Master Complies to PCI Local Bus Rev. 2.1 specifications
- Consists of MAC & PHY (10/100Mbps) interfaces
- Complies to IEEE 802.3 10BASE-T and IEEE 802.3u 100BASE-TX interfaces
- Fully supports 10BASE-T & 100BASE-TX operations through a single RJ45 port
- Supports 32-bit Bus Master Technology / PCI Rev. 2.1
- Enhancements on ACPI & APM
- Adheres to PCI Bus Power Management Interface Rev. 1.0, ACPI Rev. 1.0, and Device Class Power Management Rev. 1.0
- IEEE 802.3u auto-negotiation for 10Mbps/100Mbps Network Data Transfer Rates.
- Provides LED indicators for monitoring network conditions
- Plug and Play

## Software Driver Support

- **NetWare ODI Drivers** - Novell Netware 3.x, 4.x, DOS, OS/2 Client
- **NDIS 2.01 Drivers** - Microsoft LAN Manager, Microsoft Windows 3.11, IBM LAN Server
- **NDIS 3.0 Drivers** - Microsoft Windows NT, Microsoft Windows 95, Microsoft Windows 3.11

## Question and Answer

Q: What is Wake-On-LAN ?

A: The Wake-On-LAN feature provides the capability to remotely power on systems supporting Wake-On-LAN by simply sending a wake-up frame. With this feature, remotely uploading/downloading data to/from systems during off-peak hours will be feasible.

Q: What can Wake-On-LAN do for you ?

A: Wake-On-LAN is a remote management tool with advantages that can reduce system management workload, provide flexibility to the system administrator's job, and then of course save you time-consuming efforts and costs.

Q: What components does Wake-On-LAN require to be enable?

A: To enable Wake-On-LAN function, your system requires Ethernet LAN adapter card that can activate Wake-On-LAN function, a client with Wake-On-LAN capability, and software such as LDCM Rev. 3.10 or up that can trigger wake-up frame.



## Free Manuals Download Website

<http://myh66.com>

<http://usermanuals.us>

<http://www.somanuals.com>

<http://www.4manuals.cc>

<http://www.manual-lib.com>

<http://www.404manual.com>

<http://www.luxmanual.com>

<http://aubethermostatmanual.com>

Golf course search by state

<http://golfingnear.com>

Email search by domain

<http://emailbydomain.com>

Auto manuals search

<http://auto.somanuals.com>

TV manuals search

<http://tv.somanuals.com>