

A8V-XE



Motherboard

E2235

**First Edition
January 2006**

Copyright © 2006 ASUSTeK COMPUTER INC. All Rights Reserved.

No part of this manual, including the products and software described in it, may be reproduced, transmitted, transcribed, stored in a retrieval system, or translated into any language in any form or by any means, except documentation kept by the purchaser for backup purposes, without the express written permission of ASUSTeK COMPUTER INC. ("ASUS").

Product warranty or service will not be extended if: (1) the product is repaired, modified or altered, unless such repair, modification or alteration is authorized in writing by ASUS; or (2) the serial number of the product is defaced or missing.

ASUS PROVIDES THIS MANUAL "AS IS" WITHOUT WARRANTY OF ANY KIND, EITHER EXPRESS OR IMPLIED, INCLUDING BUT NOT LIMITED TO THE IMPLIED WARRANTIES OR CONDITIONS OF MERCHANTABILITY OR FITNESS FOR A PARTICULAR PURPOSE. IN NO EVENT SHALL ASUS, ITS DIRECTORS, OFFICERS, EMPLOYEES OR AGENTS BE LIABLE FOR ANY INDIRECT, SPECIAL, INCIDENTAL, OR CONSEQUENTIAL DAMAGES (INCLUDING DAMAGES FOR LOSS OF PROFITS, LOSS OF BUSINESS, LOSS OF USE OR DATA, INTERRUPTION OF BUSINESS AND THE LIKE), EVEN IF ASUS HAS BEEN ADVISED OF THE POSSIBILITY OF SUCH DAMAGES ARISING FROM ANY DEFECT OR ERROR IN THIS MANUAL OR PRODUCT.

SPECIFICATIONS AND INFORMATION CONTAINED IN THIS MANUAL ARE FURNISHED FOR INFORMATIONAL USE ONLY, AND ARE SUBJECT TO CHANGE AT ANY TIME WITHOUT NOTICE, AND SHOULD NOT BE CONSTRUED AS A COMMITMENT BY ASUS. ASUS ASSUMES NO RESPONSIBILITY OR LIABILITY FOR ANY ERRORS OR INACCURACIES THAT MAY APPEAR IN THIS MANUAL, INCLUDING THE PRODUCTS AND SOFTWARE DESCRIBED IN IT.

Products and corporate names appearing in this manual may or may not be registered trademarks or copyrights of their respective companies, and are used only for identification or explanation and to the owners' benefit, without intent to infringe.

Table of contents

Notices	vi
Safety information	vii
Operation Safety	vii
About this guide.....	viii
A8V-XE specifications summary.....	x

Chapter 1: Hardware information

1.1	Welcome!	1-2
1.2	Package contents	1-2
1.3	Special features	1-3
	1.3.1 Product highlights	1-3
	1.3.2 Innovative ASUS features	1-4
1.4	Before you proceed	1-5
1.5	Motherboard Overview.....	1-6
	1.5.1 Placement direction	1-6
	1.5.2 Screw holes.....	1-6
	1.5.3 Motherboard layout	1-7
1.6	Central Processing Unit (CPU)	1-8
	1.6.1 Overview	1-8
	1.6.2 Installing the CPU	1-8
	1.6.3 Installing the CPU heatsink and fan.....	1-10
1.7	System memory.....	1-12
	1.7.1 Overview	1-12
	1.7.2 Memory Configurations	1-12
	1.7.3 Installing a DIMM	1-15
	1.7.4 Removing a DIMM.....	1-15
1.8	Expansion slots	1-16
	1.8.1 Installing an expansion card	1-16
	1.8.2 Configuring an expansion card	1-16
	1.8.3 PCI slots	1-18
	1.8.4 PCI Express x16 slot	1-18
	1.8.5 PCI Express x1 slot	1-18
1.9	Jumpers	1-19
1.10	Connectors	1-21
	1.7.1 Rear panel connectors	1-21

Table of contents

1.7.2	Internal connectors.....	1-22
Chapter 2: BIOS setup		
2.1	Managing and updating your BIOS.....	2-2
2.1.1	Creating a bootable floppy disk.....	2-2
2.1.2	Updating the BIOS.....	2-3
2.1.3	Saving the current BIOS file.....	2-5
2.1.4	ASUS CrashFree BIOS 2 utility.....	2-6
2.1.5	ASUS EZ Flash utility.....	2-8
2.1.6	ASUS Update utility.....	2-9
2.2	BIOS setup program.....	2-12
2.2.1	BIOS menu screen.....	2-13
2.2.2	Menu bar.....	2-13
2.2.3	Legend bar.....	2-14
2.2.4	Menu items.....	2-14
2.2.5	Sub-menu items.....	2-14
2.2.6	Configuration fields.....	2-14
2.2.7	Pop-up window.....	2-15
2.2.8	General help.....	2-15
2.3	Main menu.....	2-16
2.3.1	System Time.....	2-16
2.3.2	System Date.....	2-16
2.3.3	Legacy Diskette A.....	2-16
2.3.4	Primary and Secondary IDE Master/Slave.....	2-17
2.3.5	HDD SMART Monitoring.....	2-18
2.4	Advanced menu.....	2-19
2.4.1	JumperFree Configuration.....	2-19
2.4.2	CPU Configuration.....	2-21
2.4.3	Chipset.....	2-21
2.4.4	PCI PnP.....	2-23
2.4.5	Onboard Devices Configuration.....	2-25
2.4.6	USB Configuration.....	2-26
2.5	Power menu.....	2-27
2.5.1	ACPI Suspend Type.....	2-27
2.5.2	ACPI APIC Support.....	2-27

Contents

2.5.3	APM Configuration	2-28
2.5.4	Hardware Monitor.....	2-29
2.6	Boot menu	2-30
2.6.1	Boot Device Priority	2-31
2.6.2	Removable Drives.....	2-31
2.6.3	Hard Disk Drives.....	2-31
2.6.4	Boot Settings Configuration	2-32
2.6.5	Security.....	2-33
2.7	Exit menu.....	2-35

Chapter 3: Software support

3.1	Installing an operating system.....	3-2
3.2	Support CD Information	3-2
3.2.1	Running the support CD.....	3-2
3.2.2	Drivers menu.....	3-3
3.2.3	Utilities menu	3-4
3.2.4	Make Disk menu	3-5
3.2.5	Manuals menu	3-6
3.2.6	ASUS Contact information	3-7

Notices

Federal Communications Commission Statement

This device complies with Part 15 of the FCC Rules. Operation is subject to the following two conditions:

- This device may not cause harmful interference, and
- This device must accept any interference received including interference that may cause undesired operation.

This equipment has been tested and found to comply with the limits for a Class B digital device, pursuant to Part 15 of the FCC Rules. These limits are designed to provide reasonable protection against harmful interference in a residential installation. This equipment generates, uses and can radiate radio frequency energy and, if not installed and used in accordance with manufacturer's instructions, may cause harmful interference to radio communications. However, there is no guarantee that interference will not occur in a particular installation. If this equipment does cause harmful interference to radio or television reception, which can be determined by turning the equipment off and on, the user is encouraged to try to correct the interference by one or more of the following measures:

- Reorient or relocate the receiving antenna.
- Increase the separation between the equipment and receiver.
- Connect the equipment to an outlet on a circuit different from that to which the receiver is connected.
- Consult the dealer or an experienced radio/TV technician for help.



WARNING! The use of shielded cables for connection of the monitor to the graphics card is required to assure compliance with FCC regulations. Changes or modifications to this unit not expressly approved by the party responsible for compliance could void the user's authority to operate this equipment.

Canadian Department of Communications Statement

This digital apparatus does not exceed the Class B limits for radio noise emissions from digital apparatus set out in the Radio Interference Regulations of the Canadian Department of Communications.

This class B digital apparatus complies with Canadian ICES-003.

Safety information

Electrical safety

- To prevent electrical shock hazard, disconnect the power cable from the electrical outlet before relocating the system.
- When adding or removing devices to or from the system, ensure that the power cables for the devices are unplugged before the signal cables are connected. If possible, disconnect all power cables from the existing system before you add a device.
- Before connecting or removing signal cables from the motherboard, ensure that all power cables are unplugged.
- Seek professional assistance before using an adapter or extension cord. These devices could interrupt the grounding circuit.
- Make sure that your power supply is set to the correct voltage in your area. If you are not sure about the voltage of the electrical outlet you are using, contact your local power company.
- If the power supply is broken, do not try to fix it by yourself. Contact a qualified service technician or your retailer.

Operation safety

- Before installing the motherboard and adding devices on it, carefully read all the manuals that came with the package.
- Before using the product, make sure all cables are correctly connected and the power cables are not damaged. If you detect any damage, contact your dealer immediately.
- To avoid short circuits, keep paper clips, screws, and staples away from connectors, slots, sockets and circuitry.
- Avoid dust, humidity, and temperature extremes. Do not place the product in any area where it may become wet.
- Place the product on a stable surface.
- If you encounter technical problems with the product, contact a qualified service technician or your retailer.



The symbol of the crossed out wheeled bin indicates that the product (electrical and electronic equipment) should not be placed in municipal waste. Check local regulations for disposal of electronic products.

About this guide

This user guide contains the information you need when installing and configuring the motherboard.

How this guide is organized

This manual contains the following parts:

- **Chapter 1: Product introduction**

This chapter describes the features of the motherboard and the new technology it supports. It also lists the hardware setup procedures that you have to perform when installing system components. It includes description of the jumpers and connectors on the motherboard.

- **Chapter 2: BIOS setup**

This chapter tells how to change system settings through the BIOS Setup menus. Detailed descriptions of the BIOS parameters are also provided.

- **Chapter 3: Software support**

This chapter describes the contents of the support CD that comes with the motherboard package.

Where to find more information

Refer to the following sources for additional information and for product and software updates.

1. **ASUS websites**

The ASUS website provides updated information on ASUS hardware and software products. Refer to the ASUS contact information.

2. **Optional documentation**

Your product package may include optional documentation, such as warranty flyers, that may have been added by your dealer. These documents are not part of the standard package.

Conventions used in this guide

To make sure that you perform certain tasks properly, take note of the following symbols used throughout this manual.



DANGER/WARNING: Information to prevent injury to yourself when trying to complete a task.



CAUTION: Information to prevent damage to the components when trying to complete a task.



IMPORTANT: Instructions that you **MUST** follow to complete a task.



NOTE: Tips and additional information to help you complete a task.

Typography

Bold text

Indicates a menu or an item to select

Italics

Used to emphasize a word or a phrase

<Key>

Keys enclosed in the less-than and greater-than sign means that you must press the enclosed key

Example: <Enter> means that you must press the Enter or Return key

<Key1>+<Key2>+<Key3>

If you must press two or more keys simultaneously, the key names are linked with a plus sign (+)

Example: <Ctrl>+<Alt>+<D>

Command

Means that you must type the command exactly as shown, then supply the required item or value enclosed in brackets

Example: At the DOS prompt, type the command line:

awdflash A8V-XE.BIN

A8V-XE specifications summary

CPU	Socket 939 for AMD® Athlon™ 64FX/ Athlon™ 64 X2/ Athlon™ 64/ Sempron processor Supports AMD Cool 'n' Quiet!™ Technology
Chipset	Northbridge: VIA® K8T890 Southbridge: VIA® VT8251
System Bus	2000/ 1600 MHz
Memory	Dual-channel memory architecture 4 x 184-pin DIMM sockets support unbuffered ECC/ non-ECC DDR 400/333/266 MHz memory modules Supports up to 4 GB system memory
Expansion slots	1 x PCI-E x16 slot for discrete graphic card 2 x PCI-E x1 slots 3 x PCI slots
Storage	VIA® VT8251 South Bridge supports: - 2 x Ultra DMA 133/100/66/33 connectors for up to four IDE devices - 4 x Serial ATA 3Gb/s devices with RAID 0, RAID 1, RAID 0+1, RAID 5 and JBOD
Audio	ADI AD1986A SoundMax 6-channel High Definition Audio CODEC Supports Jack Sensing and Enumeration Technology Supports S/PDIF out interface
USB	Supports up to 8 USB 2.0 ports
LAN	Realtek RTL8201CL 10/100M LAN PHY
ASUS special features	ASUS C.P.R. (CPU Parameter Recall) ASUS JumperFree ASUS MyLogo ASUS EZ Flash ASUS CrashFree BIOS 2 SFS (Stepless Frequency Selection) from 200MHz up to 300 MHz at 1MHz increment
BIOS features	4 Mb Flash ROM, Award BIOS, PnP, DMI2.0, WfM2.0, SM BIOS 2.3
Back Panel I/O Ports	1 x Parallel port 1 x Serial port 1 x PS/2 keyboard port 1 x PS/2 mouse port 1 x RJ45 port 4 x USB 2.0/1.1 ports 1 x 6-Channel Audio I/O port 1 x S/PDIF Out (Coaxial) port

(continued on the next page)

A8V-XE specifications summary

Internal I/O connectors	1 x Floppy disk drive connector 2 x IDE connectors 4 x Serial ATA connectors 1 x 24-pin ATX power connector 1 x 4-pin ATX 12V power connector 2 x USB connectors for 4 additional USB 2.0 ports 1 x GAME/MIDI connector 1 x Front panel High Definition Audio connector 1 x S/PDIF out connector CPU/Chassis Fan connectors CD/ AUX audio-in connectors Chassis Intrusion connector System panel connector
Manageability	Wfm2.0, DMI2.0, WOL by PME, WOR by PME, PXE, RPL
Support CD contents	Drivers ASUS PC Probe II ASUS LiveUpdate Utility Anti-Virus software
Form Factor	ATX Form Factor: 12 in x 8.3 in (30.5 cm x 21.0 cm)

*Specifications are subject to change without notice.

This chapter describes the motherboard features and the new technologies it supports.

1 Product introduction

1.1 Welcome!

Thank you for buying an ASUS® A8V-XE motherboard!

The motherboard delivers a host of new features and latest technologies, making it another standout in the long line of ASUS quality motherboards!

Before you start installing the motherboard, and hardware devices on it, check the items in your package with the list below.

1.2 Package contents

Check your motherboard package for the following items.

Motherboard	ASUS A8V-XE motherboard
Cables	1 x 2 in 1 FD/ATA cable 1 x SATA power cable 1 x SATA signal cable
Accessories	I/O shield
Application CDs	ASUS motherboard support CD
Documentation	User guide



If any of the above items is damaged or missing, contact your retailer.

1.3 Special features

1.3.1 Product highlights



Latest processor and 64-bit computing technology

The AMD Athlon™ 64FX, Athlon™ 64, Athlon™ 64 X2, and AMD Sempron™ desktop processors are based on AMD's 64-bit and 32-bit architecture, which represents the landmark introduction of the industry's first x86-64 technology. These processors provide a dramatic leap forward in compatibility, performance, investment protection, and reduced total cost of ownership and development. See page 1-8 for details.



ADI SoundMAX High-Definition audio

The onboard 6-channel AD1986A High Definition audio CODEC enables high-quality audio which automatically detects and identifies what type of peripherals are plugged into the audio I/O jacks. It also notifies the user of inappropriate connection. See pages 1-21 and 1-22 for details.



Serial ATA 3Gb/s technology

The motherboard supports the Serial ATA 3 Gb/s technology through the Serial ATA interfaces. The Serial ATA II 3 Gb/s specification provides twice the bandwidth of the current Serial ATA products with a host of new features, including Native Command Queuing (NCQ), and Power Management (PM) Implementation Algorithm. Serial ATA allows for thinner, more flexible cables with lower pin count, reduced voltage requirement. See pages 1-24 for details.

AMD Cool 'n' Quiet!™ Technology



The motherboard supports the AMD Cool 'n' Quiet!™ Technology that dynamically and automatically changes the CPU speed, voltage and amount of power depending on the task the CPU performs.

Dual Channel DDR memory support



Employing the Double Data Rate (DDR) memory technology, the motherboard supports up to 4GB of system memory using DDR400/333/266 DIMMs. The ultra-fast 400MHz memory bus delivers the required bandwidth for the latest 3D graphics, multimedia, and Internet applications. See page 1-12.

USB 2.0 technology

The motherboard implements the Universal Serial Bus (USB) 2.0 specification, dramatically increasing the connection speed from the 12 Mbps bandwidth on USB 1.1 to a fast 480 Mbps on USB 2.0. USB 2.0 is backward compatible with USB 1.1. See pages 1-20 and 1-26 for details.

S/PDIF-out on Back I/O Port

This motherboard provides convenient connectivity to external home theater audio systems via an S/PDIF-out (SONY-PHILIPS Digital Interface) jack. It allows to transfer digital audio without converting to analog format and keeps the best signal quality. See pages 1-22 for details.

PCI Express™ interface

The motherboard fully supports PCI Express, the latest I/O interconnect technology that speeds up the PCI bus. PCI Express features point-to-point serial interconnections between devices and allows higher clockspeeds by carrying data in packets. This high speed interface is software compatible with existing PCI specifications. See page 1-18 for details.

1.3.2 Innovative ASUS features

C.P.R. (CPU Parameter Recall)

The C.P.R. feature of the motherboard BIOS allows automatic re-setting to the BIOS default settings in case the system hangs due to overclocking. When the system hangs due to overclocking, C.P.R. eliminates the need to open the system chassis and clear the RTC data. Simply shut down and reboot the system, and the BIOS automatically restores the CPU default setting for each parameter.

CrashFree BIOS 2

This feature allows you to restore the original BIOS data from the support CD in case when the BIOS codes and data are corrupted. This protection eliminates the need to buy a replacement ROM chip. See page 2-6 for details.

ASUS MyLogo™

This new feature present in the motherboard allows you to personalize and add style to your system with customizable boot logos.

ASUS EZ Flash BIOS

With the ASUS EZ Flash, you can easily update the system BIOS even before loading the operating system. No need to use a DOS-based utility or boot from a floppy disk. See page 2-8 for details.

1.4 Before you proceed

Take note of the following precautions before you install components into the system.



- Unplug the power cord from the wall socket before touching any component.
- Use a grounded wrist strap or touch a safely grounded object or a metal object, such as the power supply case, before handling components to avoid damaging them due to static electricity.
- Hold components by the edges to avoid touching the ICs on them.
- Whenever you uninstall any component, place it on a grounded antistatic pad or in the bag that came with the component.
- **Before you install or remove any component, ensure that the ATX power supply is switched off or the power cord is detached from the power supply.** Failure to do so may cause severe damage to the motherboard, peripherals, and/or components.

Onboard LED

The motherboard comes with a green standby power LED. This LED lights up to indicate that the system is ON, in sleep mode or in soft-off mode, and not powered OFF. Unplug the power cable from the power outlet and make sure that the standby power LED is OFF before installing any system component.

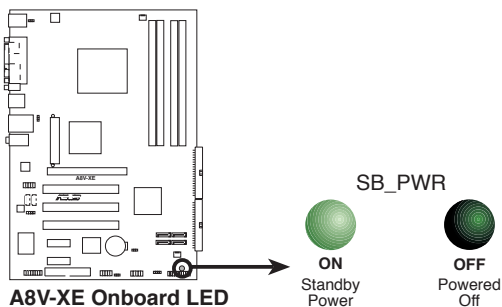

1.5 Motherboard overview

Before you install the motherboard, study the configuration of your chassis to ensure that the motherboard fits into it.



Make sure to unplug the power cord before installing or removing the motherboard. Failure to do so can cause you physical injury and damage motherboard components.

1.5.1 Placement direction

When installing the motherboard, make sure that you place it into the chassis in the correct orientation. The edge with external ports goes to the rear part of the chassis as indicated in the image below.

1.5.2 Screw holes

Place seven (6) screws into the holes indicated by circles to secure the motherboard to the chassis.



Do not overtighten the screws! Doing so can damage the motherboard.

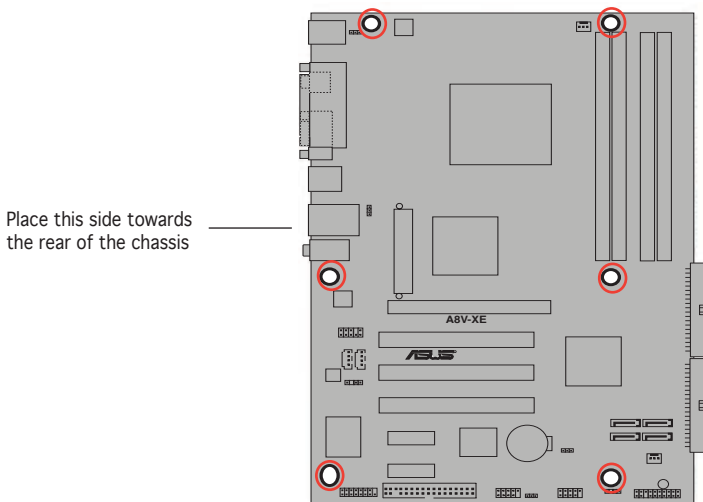

1.5.3 Motherboard layout

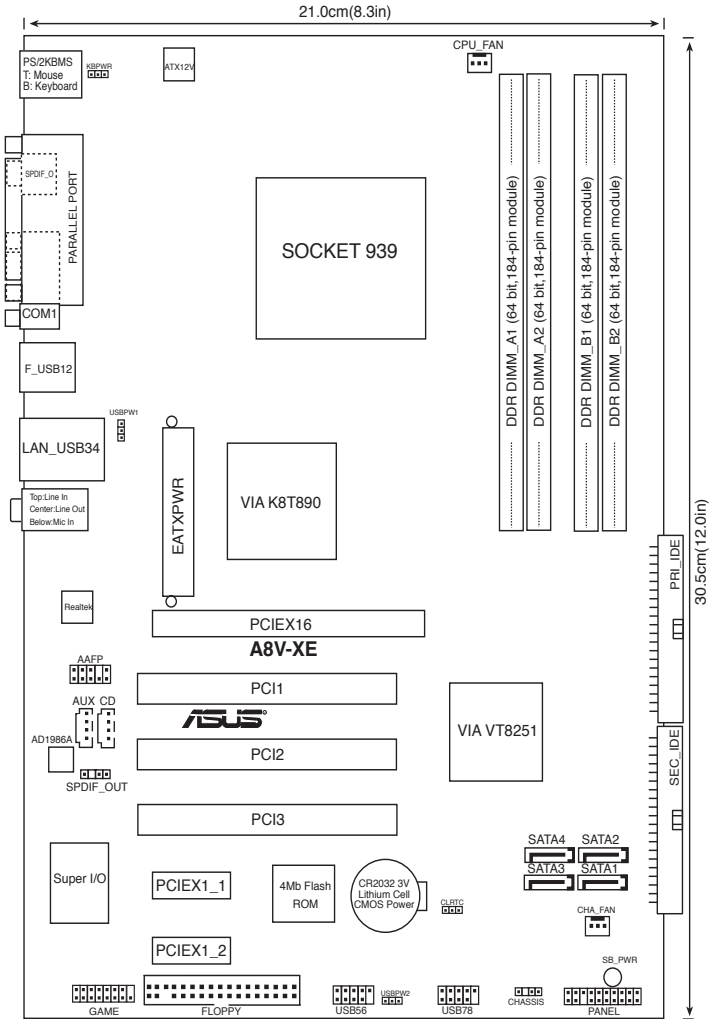

1.6 Central Processing Unit (CPU)

1.6.1 Overview

The motherboard comes with a surface mount 939-pin Zero Insertion Force (ZIF) socket designed for the AMD Athlon™ 64FX, AMD Athlon 64™ ,AMD Athlon 64 X2 or AMD Sempron™ processor.

The 128-bit-wide data paths of these processors can run applications faster than processors with only 32-bit or 64-bit wide data paths.

Take note of the marked corner (with gold triangle) on the CPU. This mark should match a specific corner on the socket to ensure correct installation.

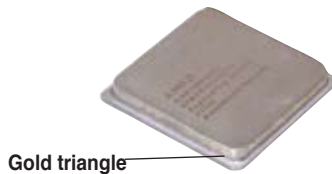

1.6.2 Installing the CPU

To install a CPU:

1. Locate the CPU socket on the motherboard.

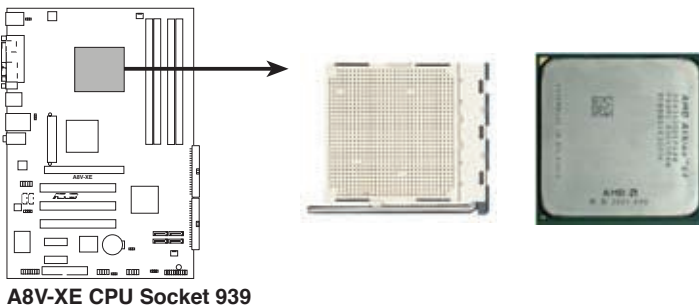

Before installing the CPU, make sure that the socket box is facing towards you and the load lever is on your left.

2. Unlock the socket by pressing the lever sideways, then lift it up to a 90°-100° angle.



Make sure that the socket lever is lifted up to 90°-100° angle, otherwise the CPU does not fit in completely.

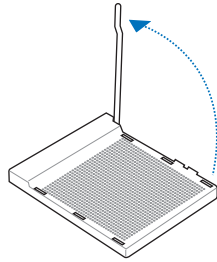

3. Position the CPU above the socket such that the CPU corner with the gold triangle matches the socket corner with a small triangle.
4. Carefully insert the CPU into the socket until it fits in place.

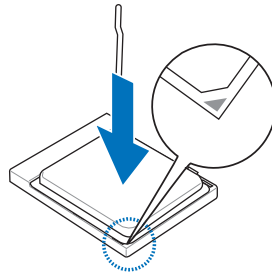

The CPU fits only in one correct orientation. DO NOT force the CPU into the socket to prevent bending the pins and damaging the CPU!

5. When the CPU is in place, push down the socket lever to secure the CPU. The lever clicks on the side tab to indicate that it is locked.

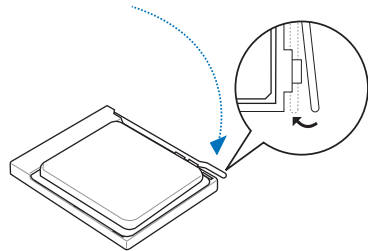

1.6.3 Installing the heatsink and fan

The AMD Athlon™ 64FX, Athlon™ 64X2, AMD Athlon 64™ or AMD Sempron™ processor require a specially designed heatsink and fan assembly to ensure optimum thermal condition and performance.

Follow these steps to install the CPU heatsink and fan.

1. Place the heatsink on top of the installed CPU, making sure that the heatsink fits properly on the retention module base.



- The retention module base is already installed on the motherboard upon purchase.
- You do not have to remove the retention module base when installing the CPU or installing other motherboard components.
- If you purchased a separate CPU heatsink and fan assembly, make sure that a Thermal Interface Material is properly applied to the CPU heatsink or CPU before you install the heatsink and fan assembly.

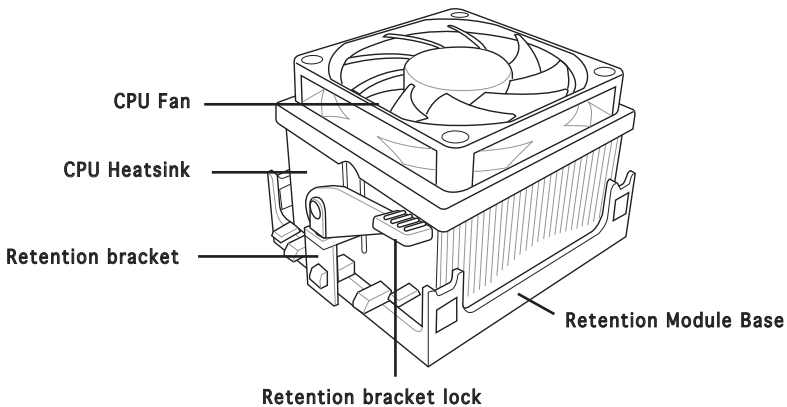

Your boxed CPU heatsink and fan assembly should come with installation instructions for the CPU, heatsink, and the retention mechanism. If the instructions in this section do not match the CPU documentation, follow the latter.

2. Attach one end of the retention bracket to the retention module base.

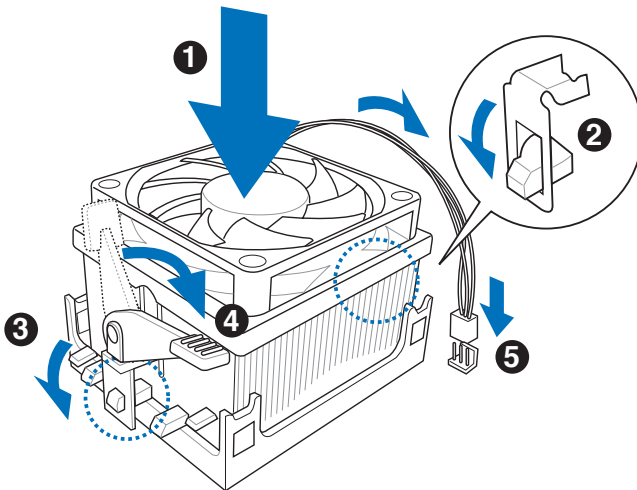

3. Align the other end of the retention bracket (near the retention bracket lock) to the retention module base. A clicking sound denotes that the retention bracket is in place.



Make sure that the fan and heatsink assembly perfectly fits the retention mechanism module base, otherwise you cannot snap the retention bracket in place.

4. Push down the retention bracket lock on the retention mechanism to secure the heatsink and fan to the module base.
5. When the fan and heatsink assembly is in place, connect the CPU fan cable to the connector on the motherboard labeled CPU_FAN.

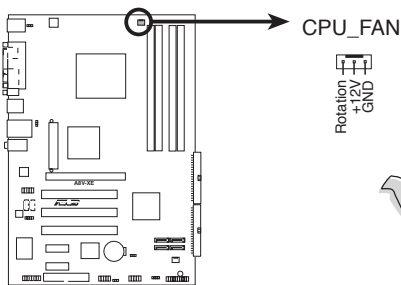

A8V-XE CPU Fan Connector



Do not forget to connect the CPU fan connector! Hardware monitoring errors can occur if you fail to plug this connector.

1.7 System memory

1.7.1 Overview

The motherboard comes with two Double Data Rate (DDR) Dual Inline Memory Module (DIMM) sockets.

The following figure illustrates the location of the sockets:

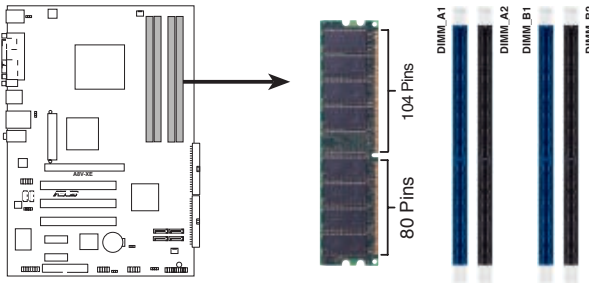

A8V-XE 184-pin DDR DIMM Sockets

Channel	Sockets
Channel A	DIMM_A1 and DIMM_A2
Channel B	DIMM_B1 and DIMM_B2

1.7.2 Memory configurations

You may install 64MB, 128 MB, 256 MB, 512 MB, and 1 GB unbuffered ECC or non-ECC DDR DIMMs into the DIMM sockets using the memory configuration in this section.



- When you installed four 1 GB DDR memory modules, the system may detect not more than 3 GB of total system memory because of address space allocation. This limitation applies only to systems with Windows® XP 32-bit operating system since it does not support PAE (Physical Address Extension) mode.
- We recommend that you install less than 3GB of total system memory when using windows XP 32-bit operating system.
- Always install DIMMs with the same CAS latency. For optimum compatibility, we recommend that you obtain memory modules from the same vendor. Refer to the DDR400 Qualified Vendors List on page 1-14 for details.

Table 1 Recommended memory configurations

Mode		Sockets			
		DIMM_A1	DIMM_A2	DIMM_B1	DIMM_B2
Single-channel	(1)	—	—	Populated	—
Dual-channel*	(1)	Populated	—	Populated	—
	(2)	Populated	Populated	Populated	Populated

* Use only identical DDR DIMM pairs.

* For dual-channel configuration (3), you may:

- install identical DIMMs in all four sockets **OR**
- install identical DIMM pair in DIMM_A1 and DIMM_B1 (blue sockets)

DDR400 Qualified Vendors List

Size	Vendor	Model	CL	Brand	Side(s)	Component	DIMM support		
							A	B	C
256MB	KINGSTON	V58C2256804SAT5(ECC)	N/A	N/A	SS	KVR400X72C3A/256	•	•	•
512MB	KINGSTON	V58C2256804SAT5(ECC)	N/A	N/A	DS	KVR400X72C3A/512	•	•	•
512MB	KINGSTON	Heat-Sink Package	N/A	N/A	DS	KHX3200A/512	•	•	•
256MB	KINGSTON	D3208DL3T-5A	N/A	N/A	SS	KVR400X64C3A/256	•	•	•
256MB	KINGSTON	A2S56D30BTP	N/A	N/A	SS	KVR400X64C3A/256	•	•	•
512MB	KINGSTON	V58C2256804SAT5	N/A	N/A	DS	KVR400X64C3A/512	•	•	•
512MB	KINGSTON	HYS5DU12822BT-D43	N/A	N/A	SS	KVR400X64C3A/512	•	•	•
1024MB	KINGSTON	HYB25D512800BE-5B	N/A	N/A	DS	KVR400X64C3A/1G	•	•	•
256MB	SAMSUNG	K4H560838E-TCCC(ECC)	N/A	SAMSUNG	SS	M381L3223ETM-CCC	•	•	•
512MB	SAMSUNG	K4H560838E-TCCC(ECC)	N/A	SAMSUNG	DS	M381L6423ETM-CCC	•	•	•
512MB	SAMSUNG	K4H560838F-TCCC	N/A	SAMSUNG	DS	M368L6423FTN-CCC	•	•	•
256MB	MICRON	MT46V32M8TG-5BC	N/A	MICRON	SS	MT8VDDT3264AG-40BCB	•	•	•
512MB	MICRON	MT46V32M8TG-5BC	N/A	MICRON	DS	MT16VDDT6464AG-40BCB	•	•	•
256MB	Infineon	HYB25D256800CE-5C	3	Infineon	SS	HYS64D32300HU-5-C	•	•	•
512MB	Infineon	HYB25D256800CE-5C	N/A	Infineon	DS	HYS64D64320HU-5-C	•	•	•
256MB	Infineon	HYB25D512160CE-5C	3	Infineon	SS	HYS64D32301HU-5-C	•	•	•
1024MB	Infineon	HYB25D512800CE-5B	3	Infineon	DS	HYS64D128320HU-5-C	•	•	•
256MB	CORSAIR	W942508BH-5	N/A	N/A	SS	CMX256A-3200C2PT	•	•	•
512MB	CORSAIR	V32M8-5	N/A	N/A	DS	V5S12M8400	•	•	•
1024MB	CORSAIR	Heat-Sink Package	N/A	N/A	DS	TWINX2048-3200C2	•	•	•
256MB	Hynix	HYS5DU56822CT-D43	N/A	N/A	SS	HYMD232646D8J-D43	•	•	•
256MB	Transcend	K4H560838F-TCCC	3	SAMSUNG	SS	TS32MLD64V4F3	•	•	•
512MB	Transcend	K4H560838F-TCCC	3	SAMSUNG	DS	TS64MLD64V4F3	•	•	•
1024MB	Transcend	K4H510838B-TCCC	3	SAMSUNG	DS	TS128MLD64V4J	•	•	•
256MB	A DATA	K4H560838E-TCCC	3	SAMSUNG	SS	MDOSS6F3G31YOK1E0Z	•	•	•
512MB	A DATA	K4H560838F-TCCC	3	SAMSUNG	DS	MDOSS6F3H41YON1E0Z	•	•	•
256MB	A DATA	HYS5DU56822CT-D43	3	Hynix	SS	MDOHY6F3G31YON1E0Z	•	•	•
512MB	A DATA	HYS5DU56822CT-D43	3	Hynix	DS	MDOHY6F3H41YON1E0Z	•	•	•
256MB	A DATA	ADD8608A8A-5B	2.5	N/A	SS	MDOADS5F3G31YOD1E0Z	•	•	•
512MB	A DATA	ADD8608A8A-5B	2.5	N/A	DS	MDOADS5F3H41YOD1E0Z	•	•	•
256MB	KINGMAX	KDL388P4LA-50	N/A	N/A	SS	MPXB62D-38KT3R	•	•	•
512MB	KINGMAX	KDL388P4LA-50	N/A	N/A	DS	MPXC22D-38KT3R	•	•	•
256MB	crucial	Heat-Sink Package	2	Ballistix	SS	BL32642402.8TG	•		
512MB	crucial	Heat-Sink Package	2	Ballistix	DS	BL64642402.16TG	•		

Side(s): SS - Single-Sided

DS - Double-Sided

DIMM Support:

- A** - supports one module inserted into either the blue slots, in a Single-channel memory configuration.
- B** - supports on pair of modules inserted into either the blue slots or the black slots as one pair of Dual-channel memory configuration.
- C** - support for 4 modules inserted into the blue and black slots as two pairs of Dual-channel memory configuration.



Visit the ASUS website (www.asus.com) for the latest DDR 400 Qualified Vendors List.

1.7.3 Installing a DIMM



Make sure to unplug the power supply before adding or removing DIMMs or other system components. Failure to do so may cause severe damage to both the motherboard and the components.

1. Unlock a DIMM socket by pressing the retaining clips outward.
2. Align a DIMM on the socket such that the notch on the DIMM matches the break on the socket.

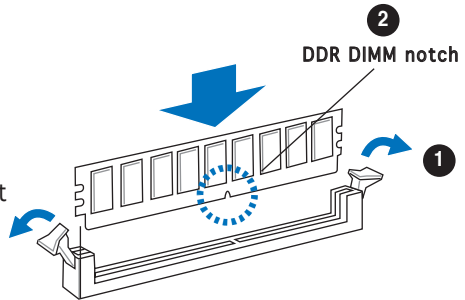

Unlocked retaining clip



A DDR DIMM is keyed with a notch so that it fits in only one direction. DO NOT force a DIMM into a socket to avoid damaging the DIMM.

3. Firmly insert the DIMM into the socket until the retaining clips snap back in place and the DIMM is properly seated.

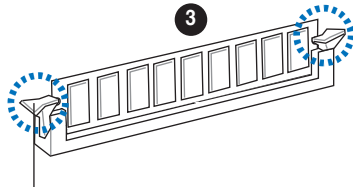

Locked Retaining Clip

1.7.4 Removing a DIMM

Follow these steps to remove a DIMM.

1. Simultaneously press the retaining clips outward to unlock the DIMM.

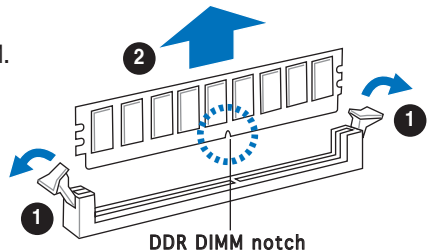

Support the DIMM lightly with your fingers when pressing the retaining clips. The DIMM might get damaged when it flips out with extra force.

2. Remove the DIMM from the socket.

1.8 Expansion slots

In the future, you may need to install expansion cards. The following sub-sections describe the slots and the expansion cards that they support.



Make sure to unplug the power cord before adding or removing expansion cards. Failure to do so may cause you physical injury and damage motherboard components.

1.8.1 Installing an expansion card

To install an expansion card:

1. Before installing the expansion card, read the documentation that came with it and make the necessary hardware settings for the card.
2. Remove the system unit cover (if your motherboard is already installed in a chassis).
3. Remove the bracket opposite the slot that you intend to use. Keep the screw for later use.
4. Align the card connector with the slot and press firmly until the card is completely seated on the slot.
5. Secure the card to the chassis with the screw you removed earlier.
6. Replace the system cover.

1.8.2 Configuring an expansion card

After installing the expansion card, configure it by adjusting the software settings.

1. Turn on the system and change the necessary BIOS settings, if any. See Chapter 2 for information on BIOS setup.
2. Assign an IRQ to the card. Refer to the tables on the next page.
3. Install the software drivers for the expansion card.

Standard interrupt assignments

IRQ	Priority	Standard Function
0	1	System Timer
1	2	Keyboard Controller
2	-	Programmable interrupt
3	11	Communications Port (COM2)*
4	12	-
5	13	IRQ holder for PCI steering*
6	14	Floppy Disk Controller
7	15	Printer Port (LPT1)*
8	3	System CMOS/Real Time Clock
9	4	IRQ holder for PCI steering*
10	5	MIDI port*
11	6	IRQ holder for PCI steering*
12	7	PS/2 Compatible Mouse Port*
13	8	Numeric Data Processor
14	9	Primary IDE Channel
15	10	Secondary IDE Channel

* These IRQs are usually available for ISA or PCI devices.

IRQ assignments for this motherboard

	A	B	C	D	E	F	G	H
PCI slot 1	shared	—	—	—	—	—	—	—
PCI slot 2	—	shared	—	—	—	—	—	—
PCI slot 3	—	—	shared	—	—	—	—	—
PCI Express x16 slot	shared	—	—	—	—	—	—	—
PCI Express x1 slot 1	shared	—	—	—	—	—	—	—
PCI Express x1 slot 2	shared	—	—	—	—	—	—	—
Onboard USB controller 0	shared	—	—	—	—	—	—	—
Onboard USB controller 1	—	—	shared	—	—	—	—	—
Onboard USB controller 2	—	shared	—	—	—	—	—	—
Onboard USB controller 3	—	—	—	shared	—	—	—	—
Onboard EHCI controller	—	—	shared	—	—	—	—	—
Onboard SATA Controller	—	shared	—	—	—	—	—	—
Onboard Audio Controller	—	shared	—	—	—	—	—	—
Onboard LAN	shared	—	—	—	—	—	—	—



When using PCI cards on shared slots, ensure that the drivers support “Share IRQ” or that the cards do not need IRQ assignments; otherwise, conflicts will arise between the two PCI groups, making the system unstable and the card inoperable.

1.8.3 PCI Express x1 slot

This motherboard supports PCI Express x1 network cards, SCSI cards and other cards that comply with the PCI Express specifications. The figure shows a network card installed on the PCI Express x1 slot.



1.8.4 PCI slots

The PCI slots support cards such as a LAN card, SCSI card, USB card, and other cards that comply with PCI specifications. The figure shows a LAN card installed on a PCI slot.



Before using a PCI VGA card, make sure to set the Graphics Adapter Priority to PCI/Int-VGA in the BIOS.

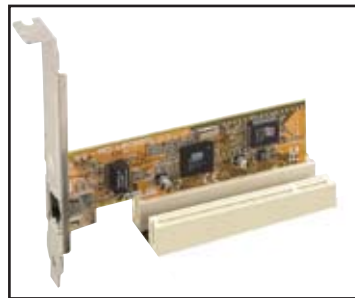

1.8.5 PCI Express x16 slot

This motherboard supports PCI Express x16 graphic cards that comply with the PCI Express specifications. The figure shows a graphics card installed on the PCI Express x16 slot.



1.9 Jumpers

1. Clear RTC RAM (CLRRTC)

This jumper allows you to clear the Real Time Clock (RTC) RAM in CMOS. You can clear the CMOS memory of date, time, and system setup parameters by erasing the CMOS RTC RAM data. The onboard button cell battery powers the RAM data in the CMOS, which includes the system setup information such as system passwords.

To erase the RTC RAM:

1. Turn OFF the computer and unplug the power cord.
2. Remove the battery.
3. Move the jumper cap from pins 1-2 (default) to pins 2-3. Keep the cap on pins 2-3 for about 5-10 seconds, then move the cap back to pins 1-2.
4. Re-install the battery.
5. Plug the power cord and turn ON the computer.
6. Hold down the key during the boot process and enter BIOS setup to re-enter data.

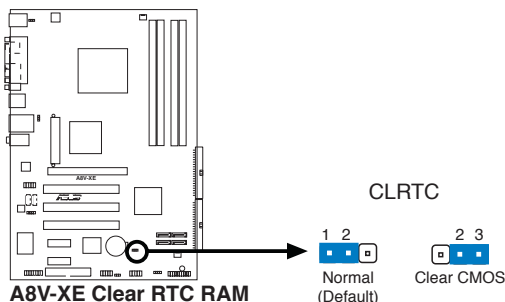

Except when clearing the RTC RAM, never remove the cap on CLRRTC jumper default position. Removing the cap will cause system boot failure.

2. USB device wake-up (3-pin USBPW1, USBPW2)

Set these jumpers to +5V to wake up the computer from S1 sleep mode (CPU stopped, DRAM refreshed, system running in low power mode) using the connected USB devices. Set to +5VSB to wake up from S3 and S4 sleep modes (no power to CPU, DRAM in slow refresh, power supply in reduced power mode).

The USBPW1 jumper is for the rear USB ports. The USBPW2 jumper is for the internal USB connectors.

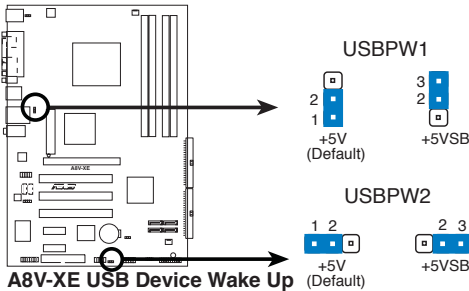

- The USB device wake-up feature requires a power supply that can provide 500mA on the +5VSB lead for each USB port; otherwise, the system would not power up.
- The total current consumed must NOT exceed the power supply capability (+5VSB) whether under normal condition or in sleep mode.

3. Keyboard power (3-pin KBPWR)

This jumper allows you to enable or disable the keyboard wake-up feature. Set this jumper to pins 2-3 (+5VSB) if you wish to wake up the computer when you press a key on the keyboard (the default is the Space Bar). This feature requires an ATX power supply that can supply at least 1A on the +5VSB lead, and a corresponding setting in the BIOS.

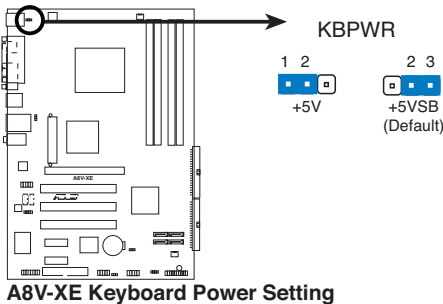

1.10 Connectors

1.10.1 Rear panel connectors

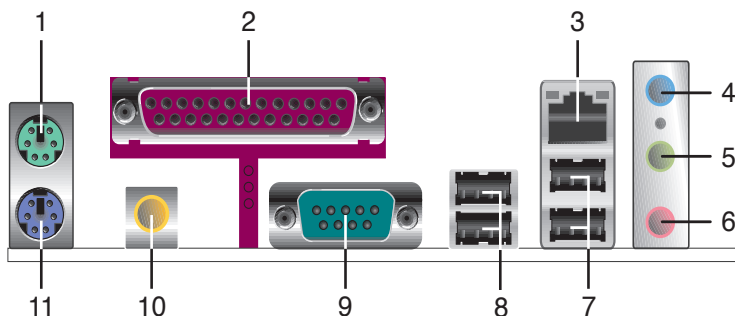

1. **PS/2 mouse port (green).** This port is for a PS/2 mouse.
2. **Parallel port.** This 25-pin port connects a parallel printer, a scanner, or other devices.
3. **LAN (RJ-45) port.** This port allows Gigabit connection to a Local Area Network (LAN) through a network hub. Refer to the table below for the LAN port LED indications.

LAN port LED indications

SPEED LED	
Status	Description
GREEN (Right)	10 Mbps connection
Orange (Left)	100 Mbps connection

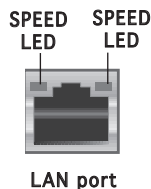

4. **Line In port (light blue).** This port connects a tape, CD, DVD player, or other audio sources.
5. **Line Out port (lime).** This port connects a headphone or a speaker.
6. **Microphone port (pink).** This port connects a microphone.



Refer to the audio configuration table below for the function of the audio ports in 2, 4, or 6-channel configuration.

Audio 2, 4, or 6-channel configuration

Port	2-channel	4-channel	6-channel
Light Blue	Line In	Back Surround	Back Surround
Green	Line Out	Front Speaker Out	Front Speaker Out
Pink	Mic In	Mic In	Center/Base

- USB 2.0 ports 3 and 4.** These two 4-pin Universal Serial Bus (USB) ports are available for connecting USB 2.0 devices.
- USB 2.0 ports 1 and 2.** These two 4-pin Universal Serial Bus (USB) ports are available for connecting USB 2.0 devices.
- Serial port.** This port connects a mouse, modem, or other devices that conform with serial specification.
- Coaxial S/PDIF Out port.** This port connects an external audio output device via a coaxial S/PDIF cable.
- PS/2 keyboard port (purple).** This port is for a PS/2 keyboard.

1.10.2 Rear panel connectors

1. Floppy disk drive connector (34-1 pin FLOPPY)

This connector is for the provided floppy disk drive (FDD) signal cable. Insert one end of the cable to this connector, then connect the other end to the signal connector at the back of the floppy disk drive.



Pin 5 on the connector is removed to prevent incorrect cable connection when using a FDD cable with a covered Pin 5.

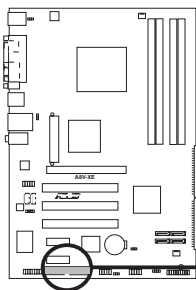

A8V-XE Floppy Disk Drive Connector

FLOPPY



PIN 1

NOTE: Orient the red markings on the floppy ribbon cable to PIN 1.

2. IDE connectors (40-1 pin PRI_IDE, SEC_IDE)

These connectors are for Ultra DMA 133/100/66/33 signal cables. The Ultra DMA 133/100/66/33 signal cable has three connectors: a blue connector for the primary IDE connector on the motherboard, a black connector for an Ultra DMA 133/100/66/33 IDE slave device (optical drive/hard disk drive), and a gray connector for an Ultra DMA 133/100/66/33 IDE master device (hard disk drive). If you install two hard disk drives, you must configure the second drive as a slave device by setting its jumper accordingly. Refer to the hard disk documentation for the jumper settings.



- Pin 20 on the IDE connector is removed to match the covered hole on the Ultra DMA cable connector. This prevents incorrect insertion when you connect the IDE cable.
- Use the 80-conductor IDE cable for Ultra DMA 133/100/66/33 IDE devices.

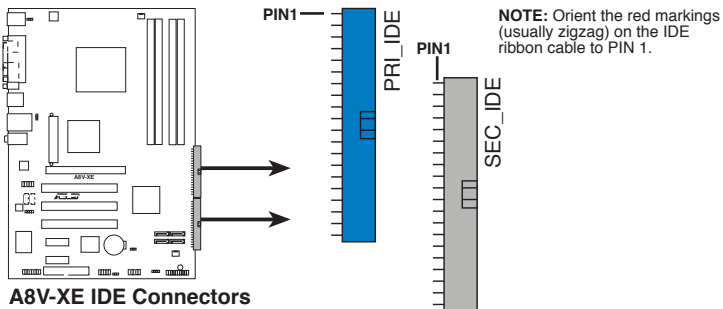

3. Serial ATA connectors (7-pin SATA1, SATA2, SATA3, SATA4)

These connectors are for the Serial ATA signal cables for Serial ATA hard disk devices. The current Serial ATA I interface allows up to 150 MB/s data transfer rate while Serial ATA II allows up to 300 MB/s data transfer rate, faster than the standard parallel ATA with 133 MB/s (DMA/133).

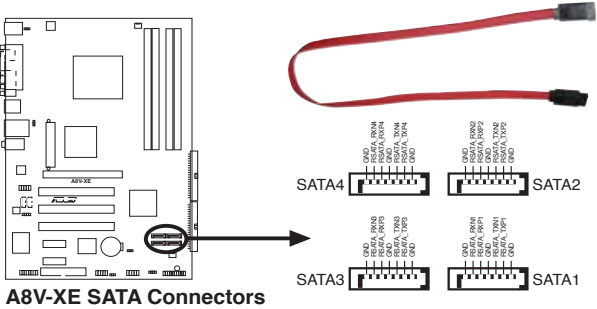

Install the Windows® 2000 Service Pack 4 or the Windows® XP Service Pack1 before using Serial ATA.



For detailed instructions on how to configure RAID 0, RAID1, RAID0+1, RAID5, and JBOD, refer to the RAID manual in the support CD.

4. CPU and Chassis Fan connectors (3-pin CPU_FAN, 3-pin CHA_FAN)

The fan connectors support cooling fans of 350 mA~740 mA (8.88 W max.) or a total of 1 A~2.22 A (26.64 W max.) at +12V. Connect the fan cables to the fan connectors on the motherboard, making sure that the black wire of each cable matches the ground pin of the connector.



Do not forget to connect the fan cables to the fan connectors. Insufficient air flow inside the system may damage the motherboard components. These are not jumpers! Do not place jumper caps on the fan connectors!

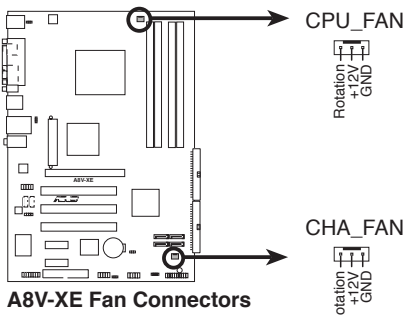

5. USB connectors (10-1 pin USB56, USB78)

These connectors are for USB 2.0 ports. Connect the USB/GAME module cable to any of these connectors, then install the module to a slot opening at the back of the system chassis. These USB connectors comply with USB 2.0 specification that supports up to 480 Mbps connection speed.

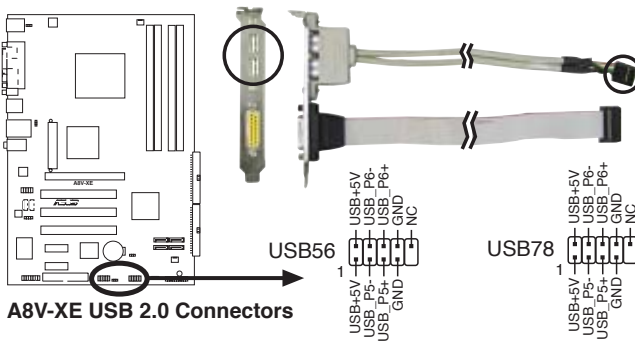

Never connect a 1394 cable to the USB connectors. Doing so will damage the motherboard!



The USB connector is purchased separately .

6. ATX power connectors (24-pin ATXPWR, 4-pin ATX12V)

These connectors are for ATX power supply plugs. The plugs from the power supply are designed to fit these connectors in only one orientation. Find the proper orientation and push down firmly until the connectors completely fit.

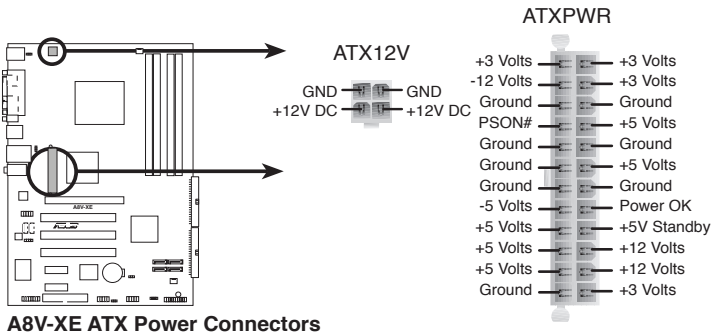

- We recommend that you use an ATX 12 V Specification 2.0-compliant power supply unit (PSU) with a minimum of 300 W power rating. This PSU type has 24-pin and 4-pin power plugs.
- If you intend to use a PSU with 20-pin and 4-pin power plugs, make sure that the 20-pin power plug can provide at least 15 A on +12 V and that the PSU has a minimum power rating of 300 W. The system may become unstable or may not boot up if the power is inadequate.
- Do not forget to connect the 4-pin ATX +12 V power plug; otherwise, the system will not boot up.
- We recommend that you use a PSU with higher power output when configuring a system with more power-consuming devices. The system may become unstable or may not boot up if the power is inadequate.
- You must install a PSU with a higher power rating if you intend to install additional devices.

7. Internal Audio connector (4-pin CD,AUX)

This connector is for the 4-pin audio cable that connects to the audio connector at the back of the optical drive.

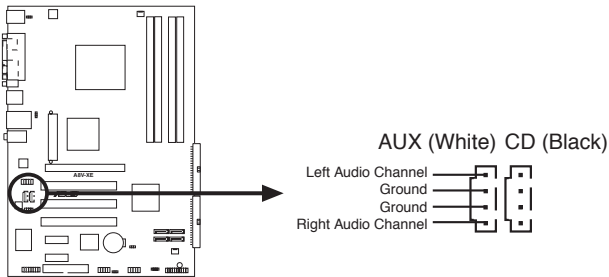

A8V-XE Internal Audio Connectors



Enable the CD-IN , AUX-IN function in the audio utility when using this connector.

8. GAME/MIDI port connector (16-1 pin GAME)

This connector is for a GAME/MIDI port. Connect the USB/GAME module cable to this connector, then install the module to a slot opening at the back of the system chassis. The GAME/MIDI port connects a joystick or game pad for playing games, and MIDI devices for playing or editing audio files.

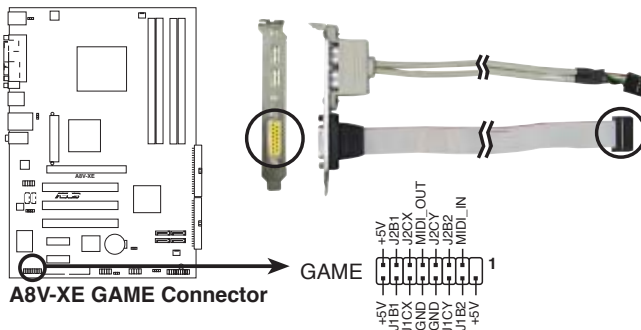

A8V-XE GAME Connector



The Game/MIDI port is purchased separately .

9. Digital audio connector (4-1 pin SPDIF_OUT)

This connector is for an additional Sony/Philips Digital Interface (S/PDIF) port(s). Connect the S/PDIF module cable to this connector, then install the module to a slot opening at the back of the system chassis.



The S/PDIF module is purchased separately.

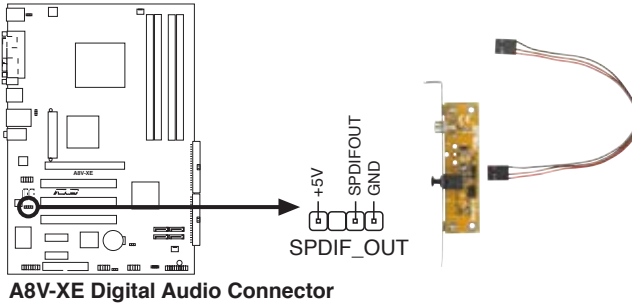

10. Front panel audio connector (10-1 pin AAFP)

This connector is for a chassis-mounted front panel audio I/O module that supports either High Definition Audio or AC `97 audio standard. Connect one end of the front panel audio I/O module cable to this connector.

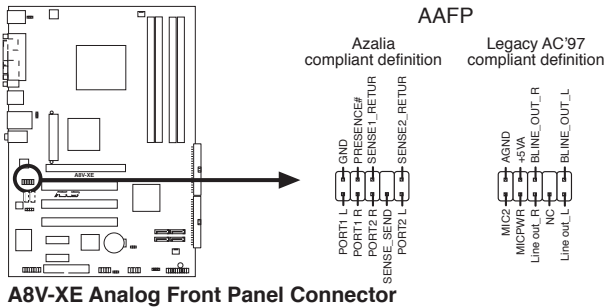

We recommend that you connect a high-definition front panel audio module to this connector to avail of the motherboard high-definition audio capability.

11. System panel connector (20-1 pin PANEL)

This connector supports several chassis-mounted functions.

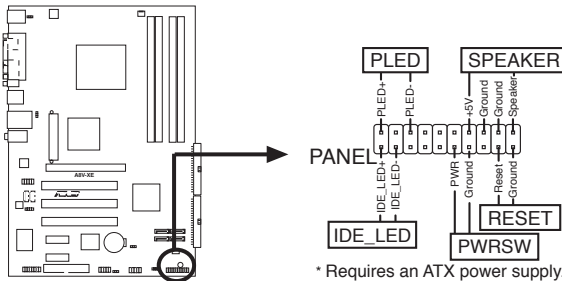

A8V-XE System Panel Connector



The system panel connector is color-coded for easy connection. Refer to the connector description below for details.

- **Power LED (Green 3-pin PLED)**
This 3-pin connector is for the Power LED. Connect the 3-pin power LED cable from the system chassis to this connector. The LED lights up when you turn on the system power, and blinks when the system is in sleep mode.
- **System warning speaker (Orange 4-pin SPEAKER)**
This 4-pin connector is for the chassis-mounted system warning speaker. The speaker allows you to hear system beeps and warnings.
- **Hard disk drive activity LED (Red 2-pin IDELED)**
This 2-pin connector is for the HDD Activity LED. Connect the HDD Activity LED cable to this connector. The IDE LED lights up or flashes when data is read from or written to the HDD.
- **ATX power button/soft-off button (Yellow 2-pin PWRSW)**
This connector is for the system power button. Pressing the power button turns the system on or puts the system in sleep or soft-off mode depending on the BIOS settings. Pressing the power switch for more than four seconds while the system is ON turns the system OFF.
- **Reset button (Blue 2-pin RESET)**
This 2-pin connector is for the chassis-mounted reset button for system reboot without turning off the system power.

This chapter tells how to change the system settings through the BIOS Setup menus. Detailed descriptions of the BIOS parameters are also provided.

BIOS setup **2**

2.1 Managing and updating your BIOS

The following utilities allow you to manage and update the motherboard Basic Input/Output System (BIOS) setup.

1. **Award BIOS Flash Utility** (Updates the BIOS in DOS mode using a bootable floppy disk.)
2. **ASUS CrashFree BIOS 2** (Updates the BIOS using a bootable floppy disk or the motherboard support CD when the BIOS file fails or gets corrupted.)
3. **ASUS EZ Flash** (Updates the BIOS in DOS using a floppy disk or the motherboard support CD.)
4. **ASUS Update** (Updates the BIOS in Windows® environment.)

Refer to the corresponding sections for details on these utilities.



Save a copy of the original motherboard BIOS file to a bootable floppy disk in case you need to restore the BIOS in the future. Copy the original motherboard BIOS using the ASUS Update or AwardBIOS Flash utilities.

2.1.1 Creating a bootable floppy disk

1. Do either one of the following to create a bootable floppy disk.
 - DOS environment*
 - a. Insert a 1.44MB floppy disk into the drive.
 - b. At the DOS prompt, type **format a: /s** then press <Enter>.
 - Windows® XP environment*
 - a. Insert a 1.44 MB floppy disk to the floppy disk drive.
 - b. Click **Start** from the Windows® desktop, then select **My Computer**.
 - c. Select the 3 1/2 Floppy Drive icon.
 - d. Click File from the menu, then select Format. A **Format 3 1/2 Floppy Disk** window appears.
 - e. Select **Create an MS-DOS startup disk** from the format options field, then click **Start**.

Windows® 2000 environment

To create a set of boot disks for Windows® 2000:

- a. Insert a formatted, high density 1.44 MB floppy disk into the drive.

- b. Insert the Windows® 2000 CD to the optical drive.
 - c. Click **Start**, then select **Run**.
 - d. From the Open field, type
D:\bootdisk\makeboot a:
 assuming that D: is your optical drive.
 - e. Press <Enter>, then follow screen instructions to continue.
2. Copy the original or the latest motherboard BIOS file to the bootable floppy disk.

2.1.2 Updating the BIOS

The Basic Input/Output System (BIOS) can be updated using the AwardBIOS Flash Utility. Follow these instructions to update the BIOS using this utility.

1. Download the latest BIOS file from the ASUS web site. Rename the file to A8V-XE.BIN and save it to a floppy disk.



Save only the updated BIOS file in the floppy disk to avoid loading the wrong BIOS file.

2. Copy the AwardBIOS Flash Utility (awdfash.exe) from the Software folder of the support CD to the floppy disk with the latest BIOS file.
3. Boot the system in DOS mode using the bootable floppy disk you created earlier.
4. When the A:> appears, replace the bootable floppy disk with the floppy disk containing the new BIOS file and the Award BIOS Flash Utility.
5. At the prompt, type awdfash then press <Enter>. The Award BIOS Flash Utility screen appears.

```

AwardBIOS Flash Utility for ASUS V1.01
(C) Phoenix Technologies Ltd. All Rights Reserved

For K8T890-8251-A8V-XE-00          DATE: 09/06/2005
Flash Type

File Name to Program: 

Message: Please input File Name!
  
```

2.1.4 ASUS CrashFree BIOS 2 utility

The ASUS CrashFree BIOS 2 is an auto recovery tool that allows you to restore the BIOS file when it fails or gets corrupted during the updating process. You can update a corrupted BIOS file using the motherboard support CD or the floppy disk that contains the updated BIOS file.



Prepare the motherboard support CD or the floppy disk containing the updated motherboard BIOS before using this utility.

Recovering the BIOS from the support CD

To recover the BIOS from the support CD:

1. Turn on the system.
2. Insert the motherboard support CD to the optical drive.
3. The utility displays the following message and automatically checks the CD for the BIOS file.

```
Award BootBlock BIOS v1.0
Copyright (c) 2000, Award Software, Inc.

BIOS ROM checksum error
Detecting IDE ATAPI device...
```

When found, the utility reads the BIOS file and starts flashing the corrupted BIOS file.

```
Award BootBlock BIOS v1.0
Copyright (c) 2000, Award Software, Inc.

BIOS ROM checksum error
Detecting IDE ATAPI device...
Found CDROM, try to Boot from it... Pass
```



DO NOT shut down or reset the system while updating the BIOS! Doing so can cause system boot failure!

4. Restart the system after the utility completes the updating process.

Recovering the BIOS from a floppy disk

To recover the BIOS from the support CD:

1. Remove any CD from the optical drive, then turn on the system.
2. Insert the floppy disk with the original or updated BIOS file to the floppy disk drive.
3. The utility displays the following message and automatically checks the floppy disk for the original or updated BIOS file.

```
Award BootBlock BIOS v1.0
Copyright (c) 2000, Award Software, Inc.

BIOS ROM checksum error
Detecting IDE ATAPI device...
```

When no CD is found, the utility automatically checks the optical drive for the original or updated BIOS file. The utility then updates the corrupted BIOS file.

```
Award BootBlock BIOS v1.0
Copyright (c) 2000, Award Software, Inc.

BIOS ROM checksum error
Detecting IDE ATAPI device...
  Found CDROM, try to Boot from it... Fail

Detecting floppy drive A media...
```



DO NOT shut down or reset the system while updating the BIOS! Doing so can cause system boot failure!

4. Restart the system after the utility completes the updating process.



The recovered BIOS may not be the latest BIOS version for this motherboard. Visit the ASUS website (www.asus.com) to download the latest BIOS file.

2.1.5 ASUS EZ Flash utility

The ASUS EZ Flash feature allows you to update the BIOS without having to go through the long process of booting from a floppy disk and using a DOS-based utility. The EZ Flash utility is built-in the BIOS chip so it is accessible by pressing <Alt> + <F2> during the Power-On Self-Test (POST).

To update the BIOS using EZ Flash:

1. Visit the ASUS website (www.asus.com) to download the latest BIOS file for the motherboard.
2. Save the BIOS file to a floppy disk, then restart the system.
3. Press <Alt> + <F2> during POST to display the following.

```
Insert Disk then press Enter or ESC to continue POST
```

4. Insert the floppy disk that contains the BIOS file to the floppy disk drive then press <Enter>. The following screen appears.

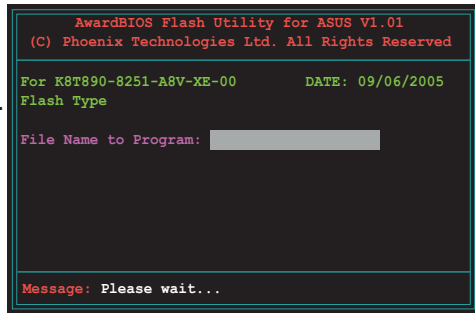

5. When the correct BIOS file is found, EZ Flash performs the BIOS update process and automatically reboots the system when done.



Do not shutdown or reset the system while updating the BIOS to prevent system boot failure!

2.1.6 ASUS Update utility

The ASUS Update is a utility that allows you to manage, save, and update the motherboard BIOS in Windows® environment. The ASUS Update utility allows you to:

- Save the current BIOS file
- Download the latest BIOS file from the Internet
- Update the BIOS from an updated BIOS file
- Update the BIOS directly from the Internet, and
- View the BIOS version information.

This utility is available in the support CD that comes with the motherboard package.



ASUS Update requires an Internet connection either through a network or an Internet Service Provider (ISP).

Installing ASUS Update

To install ASUS Update:

1. Place the support CD in the optical drive. The Drivers menu appears.
2. Click the **Utilities** tab, then click **Install ASUS Update VX.XX.XX**. See page 3-4 for the Utilities screen menu.
3. The ASUS Update utility is copied to your system.



Quit all Windows® applications before you update the BIOS using this utility.

Updating the BIOS through the Internet

To update the BIOS through the Internet:

1. Launch the ASUS Update utility from the Windows® desktop by clicking **Start > Programs > ASUS > ASUSUpdate > ASUSUpdate**. The ASUS Update main window appears.

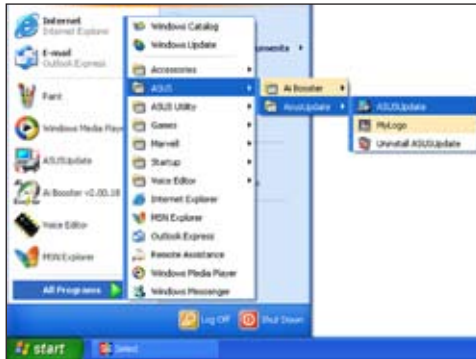

2. Select Update BIOS from the Internet option from the drop-down menu, then click **Next**.



3. Select the ASUS FTP site nearest you to avoid network traffic, or click **Auto Select**. Click **Next**.

- From the FTP site, select the BIOS version that you wish to download. Click **Next**.
- Follow the screen instructions to complete the update process.



The ASUS Update utility is capable of updating itself through the Internet. Always update the utility to avail all its features.



Updating the BIOS through a BIOS file

To update the BIOS through a BIOS file:

- Launch the ASUS Update utility from the Windows® desktop by clicking **Start > Programs > ASUS > ASUSUpdate > ASUSUpdate**. The ASUS Update main window appears.
- Select Update BIOS from a file option from the drop-down menu, then click **Next**.



- Locate the BIOS file from the **Open** window, then click **Open**.
- Follow the screen instructions to complete the update process.

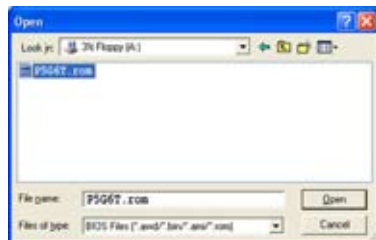

2.2 BIOS setup program

This motherboard supports a programmable Low-Pin Count (LPC) chip that you can update using the provided utility described in section “2.1 Managing and updating your BIOS.”

Use the BIOS Setup program when you are installing a motherboard, reconfiguring your system, or prompted to “Run Setup”. This section explains how to configure your system using this utility.

Even if you are not prompted to use the Setup program, you can change the configuration of your computer in the future. For example, you can enable the security password feature or change the power management settings. This requires you to reconfigure your system using the BIOS Setup program so that the computer can recognize these changes and record them in the CMOS RAM of the LPC chip.

The LPC chip on the motherboard stores the Setup utility. When you start up the computer, the system provides you with the opportunity to run this program. Press during the Power-On Self-Test (POST) to enter the Setup utility; otherwise, POST continues with its test routines.

If you wish to enter Setup after POST, restart the system by pressing <Ctrl+Alt+Del>, or by pressing the reset button on the system chassis. You can also restart by turning the system off and then back on. Do this last option only if the first two failed.

The Setup program is designed to make it as easy to use as possible. Being a menu-driven program, it lets you scroll through the various sub-menus and make your selections from the available options using the navigation keys.



- The default BIOS settings for this motherboard apply for most conditions to ensure optimum performance. If the system becomes unstable after changing any BIOS settings, load the default settings to ensure system compatibility and stability. Select the **Load Default Settings** item under the Exit Menu. See section “2.7 Exit Menu.”
 - The BIOS setup screens shown in this section are for reference purposes only, and may not exactly match what you see on your screen.
 - Visit the ASUS website (www.asus.com) to download the latest BIOS file for this motherboard and .
-

2.2.1 BIOS menu screen

Menu items	Menu bar	Configuration fields	General help
Phoenix-Award BIOS CMOS Setup Utility			
Main Advanced Power Boot Exit			
System Time System Date Legacy Diskette A: ▶ Primary IDE Master ▶ Primary IDE Slave ▶ Secondary IDE Master ▶ Secondary IDE Slave HDD SMART Monitoring Installed Memory Usable Memory	F5 : 30 : 36 Wed, Nov 5 2004 [1.44M, 3.5 in.] [ST321122A] [ASUS CDS520/A] [None] [None] [Disabled] 256MB 255MB	Select Menu Item Specific Help▶ Press [Enter] to enter next page for detail hard drive settings	
F1: Help ↑↓ : Select Item -/+ : Change Value F5: Setup Defaults ESC: Exit ←→ : Select Menu Enter: Select Sub-menu F10: Save and Exit			
	Sub-menu items		Legend bar

2.2.2 Menu bar

The menu bar on top of the screen has the following main items:

Main	For changing the basic system configuration
Advanced	For changing the advanced system settings
Power	For changing the advanced power management (APM) configuration
Boot	For changing the system boot configuration
Exit	For selecting the exit options and loading default settings



- The BIOS setup screens shown in this chapter are for reference purposes only, and may not exactly match what you see on your screen.
- Visit the ASUS website (www.asus.com) to download the latest BIOS information.

2.2.3 Legend bar

At the bottom of the Setup screen is a legend bar. The keys in the legend bar allow you to navigate through the various setup menus. The following table lists the keys found in the legend bar with their corresponding functions.

Navigation Key	Function
<F1>	Displays the General Help screen
<F5>	Loads setup default values
<Esc>	Exits the BIOS setup or returns to the main menu from a sub-menu
Left or Right arrow	Selects the menu item to the left or right
Up or Down arrow	Moves the highlight up or down between fields
Page Down or - (minus)	Scrolls backward through the values for the highlighted field
Page Up or + (plus)	Scrolls forward through the values for the highlighted field
<Enter>	Brings up a selection menu for the highlighted field
<F10>	Saves changes and exit

2.2.4 Menu items

The highlighted item on the menu bar displays the specific items for that menu. For example, selecting **Main** shows the Main menu items.

The other items (Advanced, Power, Boot, and Exit) on the menu bar have their respective menu items.

2.2.5 Sub-menu items

A solid triangle before each item on any menu screen means that the item has a sub-menu. To display the sub-menu, select the item and press <Enter>.

2.2.6 Configuration fields

These fields show the values for the menu items. If an item is user-configurable, you can change the value of the field opposite the item. You cannot select an item that is not user-configurable.

A configurable field is enclosed in brackets, and is highlighted when selected. To change the value of a field, select it then press <Enter> to display a list of options. Refer to "2.2.7 Pop-up window."

2.2.7 Pop-up window

Select a menu item then press <Enter> to display a pop-up window with the configuration options for that item.

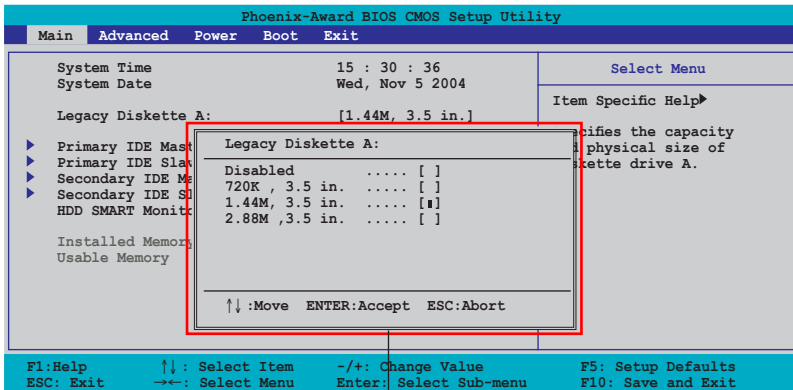

Pop-up menu

2.2.8 General help

At the top right corner of the menu screen is a brief description of the selected item.

2.3 Main menu

When you enter the BIOS Setup program, the Main menu screen appears, giving you an overview of the basic system information.



Refer to section “2.2.1 BIOS menu screen” for information on the menu screen items and how to navigate through them.

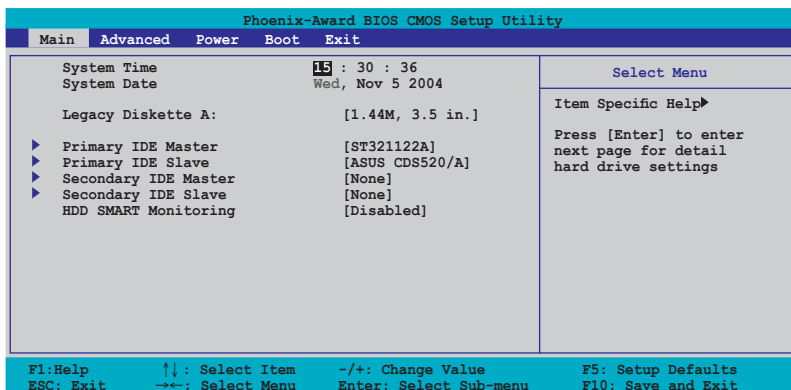

2.3.1 System Time [xx:xx:xxxx]

Allows you to set the system time.

2.3.2 System Date [Day xx/xx/xxxx]

Allows you to set the system date.

2.3.3 Legacy Diskette A [1.44M, 3.5 in.]

Sets the type of floppy drive installed. Configuration options: [Disabled] [720K , 3.5 in.] [1.44M, 3.5 in.] [2.88M, 3.5 in.]

2.3.4 Primary and Secondary IDE Master/Slave

While entering Setup, the BIOS automatically detects the presence of IDE devices. There is a separate sub-menu for each IDE device. Select a device item then press <Enter> to display the IDE device information.

Phoenix-Award BIOS CMOS Setup Utility			
Main			
Primary IDE Master		Select Menu	
Primary IDE Master	[Auto]	Item Specific Help▶▶ Press [Enter] to select	
Access Mode	[Auto]		
Capacity	0 MB		
Cylinder	0		
Head	0		
Sector	0		
PIO Mode	[Auto]		
UDMA Mode	[Auto]		
Transfer Mode	None		
F1: Help	↑↓ : Select Item		-/+ : Change Value
ESC: Exit	→← : Select Menu	Enter: Select Sub-menu	F10: Save and Exit

The BIOS automatically detects the values opposite the dimmed items (Capacity, Cylinder, Head, Sector and Transfer Mode). These values are not user-configurable. These items show N/A if no IDE device is installed in the system.

IDE Primary Master/Slave [Auto]; IDE Secondary Master/Slave [Auto]

Select [Auto] to automatically detect an IDE hard disk drive. If automatic detection is successful, the BIOS automatically fills in the correct values for the remaining fields on this sub-menu. If the hard disk was already formatted on a previous system, the setup BIOS may detect incorrect parameters. Select [Manual] to manually enter the IDE hard disk drive parameters. If no drive is installed select [None].
Configuration options: [None] [Auto] [Manual]

Access Mode [Auto]

The default [Auto] allows automatic detection of an IDE hard disk drive. Select [CHS] for this item if you set the IDE Primary Master/Slave to [Manual]. Configuration options: [CHS] [LBA] [Large] [Auto]



Before attempting to configure a hard disk drive, make sure you have the correct configuration information supplied by the drive manufacturer. Incorrect settings may cause the system to fail to recognize the installed hard disk.

Capacity

Displays the auto-detected hard disk capacity. This item is not configurable.

Cylinder

Shows the number of the hard disk cylinders. This item is not configurable.

Head

Shows the number of the hard disk read/write heads. This item is not configurable.

Sector

Shows the number of sectors per track. This item is not configurable.

PIO Mode [Auto]

Sets the PIO mode for the IDE device.

Configuration options: [Auto] [Mode 0] [Mode 1] [Mode 2] [Mode 3] [Mode 4]

UDMA Mode [Auto]

Disables or sets the UDMA mode. Configuration options: [Disabled] [Auto]

Transfer Mode

Shows the Transfer mode. This item is not configurable.



After entering the IDE hard disk drive information into BIOS, use a disk utility, such as FDISK, to partition and format new IDE hard disk drives. This is necessary so that you can write or read data from the hard disk. Make sure to set the partition of the Primary IDE hard disk drives to active.

2.3.5 HDD SMART Monitoring [Disabled]

Allows you to enable or disable the HDD Self-Monitoring Analysis and Reporting Technology (SMART) feature.

Configuration options: [Disabled] [Enabled]

2.4 Advanced menu

The Advanced menu items allow you to change the settings for the CPU and other system devices.



Take caution when changing the settings of the Advanced menu items. Incorrect field values can cause the system to malfunction.

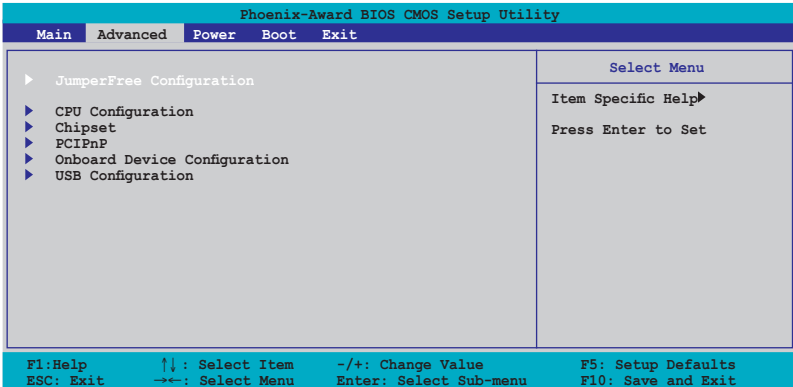

2.4.1 JumperFree Configuration

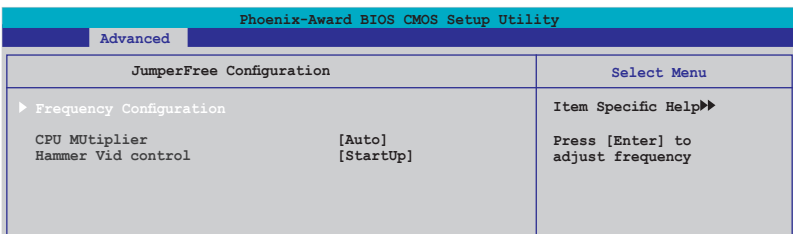

Frequency Configuration

The items in this sub-menu show the frequency information auto-detected by the BIOS.

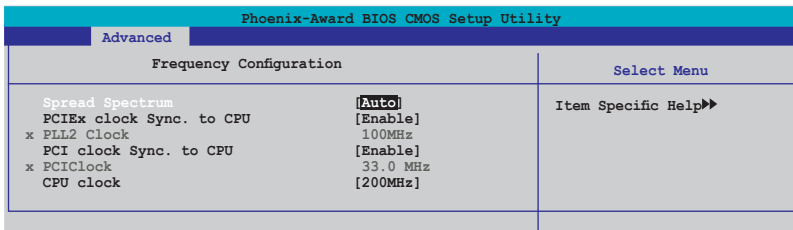

Spread Spectrum [Auto]

Enables or disables the clock generator spread spectrum.

Configuration options: [Disabled] [+/- 0.1%] [+/- 0.2%] [+/- 0.3%] [+/- 0.4%] [+/- 0.5%] [+/- 0.6%] [+/- 0.7%] [+/- 0.8%] [+/- 0.9%] [+/- 1.0%] [Auto]

PCIEx clock Sync. to CPU [Enable]

Enables or disables the PCI Express™ synchronous clock to the CPU.

Configuration options: [Disable] [Enable]

x PLL2 Clock [XXX] (value is auto-detected)

Allows you to set the x PLL2 clock frequency. This item is user-configurable only when the PCIEx clock Sync. to CPU item is set to Disabled. The BIOS detects the default value of this item. Press <Enter> then key-in desired x PLL2 clock frequency within range.

PCI clock Sync. to CPU [Enable]

Enables or disables the PCI synchronous clock to the CPU.

Configuration options: [Disable] [Enable]

PCI Clock [XXX] (value is auto-detected)

Allows you to set the PCI clock frequency. This item is user-configurable only when the PCI clock Sync. to CPU item is set to Disabled. The BIOS detects the default value of this item. Press <Enter> then key-in desired PCI clock frequency within range.

CPU Clock [XXX] [200 MHz]

Displays the frequency sent by the clock generator to the system bus and PCI bus. The default value of this item is auto-detected by the BIOS. Use the <+> and <-> keys to adjust the CPU frequency.



Selecting a very high CPU frequency may cause the system to become unstable! If this happens, revert to the default setting.

CPU Multiplier [Auto]

Sets the CPU multiplier. The configuration options vary depending on the type of CPU installed. Configuration options: [Auto] [x4] [x4.5] [x5] [x5.5] [x6] [x6.5] [x7] [x7.5] [x8] [x8.5] [x9]

Hammer Vid control [Startup]

Sets the Hammer Voltage ID control.

Configuration options: [Startup] [1.550 v] [1.525 v] [1.500 v] [1.475 v] [1.450 v] [1.425 v] [1.400 v] [1.375 v] [1.350 v] [1.325 v] [1.300 v] [1.275 v] [1.250 v] [1.225 v] [1.200 v] [1.175 v] [1.150 v] [1.125 v] [1.100 v] [1.075 v] [1.050 v] [1.025 v] [1.000 v] [0.975 v] [0.950 v] [0.925 v] [0.900 v] [0.875 v] [0.850 v] [0.825 v] [0.800 v] [0.775 v] [0.750 v]

2.4.2 CPU Configuration

Phoenix-Award BIOS CMOS Setup Utility		
Advanced		
CPU Configuration		Select Menu
CPU Type	AMD Sempron(tm) Processor 3000+	Item Specific Help▶▶
CPU Spee	1800MHz	Enable/Disable AMD
Cache RAM	128K	Coll'n'Quiet function
Current FSB Frequency	200 MHz	which support P-state
AMD K8 Cool'n'Quiet control	[Disabled]	transitions in AMD
		processors.

AMD K8 Cool'n'Quiet control [Disabled]

Allows you to disable or set the AMD Cool 'n' Quiet!™ Technology feature. Configuration options: [Enabled] [Disabled]



This feature requires the AMD CPU heatsink, fan assembly with monitor chip and BIOS utility.

2.4.3 Chipset

Phoenix-Award BIOS CMOS Setup Utility		
Advanced		
Chipset		Select Menu
▶ DRAM Configuration		Item Specific Help▶▶
Upstream LDT Bus Width	[16 bit]	DRAM timing and
Downstream LDT Bus Width	[16 bit]	control
LDT Bus Frequency	[Auto]	
VLink Mode Selection	[Auto]	
Primary Display Adapter	[PCI]	

DRAM Configuration

The items in this sub-menu show the DRAM-related information auto-detected by the BIOS.

Phoenix-Award BIOS CMOS Setup Utility			
Advanced			
DRAM Configuration		Select Menu	
Current DRAM Frequency	166 MHz	Item Specific Help▶▶▶ <Enter> to select DARM configuration by [Auto] is recommended. [Manual] allows you to set each configuration on your own.	
Timing Mode	[Auto]		
x Memclock index value (Mhz)	200Mhz		
x CAS# latency (Tcl)	3		
x Min RAS# active time (Tras)	8T		
x RAS# to CAS# delay (Trcd)	4T		
x Row precharge Time (Trp)	4T		
x 1T/2T Memory Timing	2T		
S/W DRAM Over 4G Remapping	[Enabled]		
H/W DRAM Over 4G Remapping	[Enabled]		
MTRR mapping mode	[Continuous]		
F1: Help ↑↓: Select Item -/+ : Change Value F5: Setup Defaults ESC: Exit ←→: Select Menu Enter: Select Sub-menu F10: Save and Exit			

Current DRAM Frequency

Shows the Transfer mode. This item is not configurable.

Timing Mode [Auto]

Sets the timing mode. Configuration options: [Auto] [Manual]

Memclock index value (Mhz)

Shows the memory clock index value. This item is not configurable.

CAS# latency (Tcl)

Shows the latency between the SDRAM read command and the time the data actually becomes available. This item is not configurable.

Min RAS# active time (Tras)

Shows the minimum RAS# active time. This item is not configurable.

RAS# to CAS# delay (Trcd)

Shows the latency between the DDR SDRAM active command and the read/write command. This item is not configurable.

Row precharge Time (Trp)

Shows the Row precharge time. This item is not configurable.

1T/2T Memory Timing

Shows the memory timing. This item is not configurable.

S/W DRAM Over 4G Remapping [Enabled]

Enables or disables the S/W DRAM over 4G remapping mode
Configuration options: [Disabled] [Enabled]

H/W DRAM Over 4G Remapping [Enabled]

Enables or disables the H/W DRAM over 4G remapping mode
Configuration options: [Disabled] [Enabled]

MTRR mapping mode [Continuous]

Sets the MTRR mapping mode.

Configuration options: [Continuous] [Discrete]

Upstream LDT Bus Width [16 bit]

Sets the upstream Lightning Data Transport (LDT) Bus Width.

Configuration options: [8 bit] [16 bit]

Downstream LDT Bus Width [16 bit]

Sets the downstream Lightning Data Transport (LDT) Bus Width.

Configuration options: [8 bit] [16 bit]

LDT Bus Frequency [Auto]

Sets the Lightning Data Transport (LDT) Bus frequency.

Configuration options: [Auto] [1 GHz] [800 MHz] [600 MHz] [400 MHz] [200 MHz]

VLink Mode Selection [Auto]

Sets the VLink mode. Configuration options: [By Auto] [Mode 0] [Mode 1]

[Mode 2] [Mode 3] [Mode 4]

Primary Display Adapter [PCI]

Sets the primary boot device. Configuration options: [PCI] [PCI-E]

2.4.4 PCIPnP

Phoenix-Award BIOS CMOS Setup Utility		
Advanced		
PCIPnP		Select Menu
Plug & Play O/S	[No]	Item Specific Help▶▶
Resources Controlled By	[Auto]	
x IRQ Resources		
Assign IRQ For VGA	[Enabled]	
PCI Express relative items		
Maximum Payload Size	[4096]	

Plug & Play O/S [No]

When set to [No], the BIOS configures all the devices in the system.

When set to [Yes] and if you install a Plug and Play operating system, the operating system configures the Plug and Play devices not required for boot.

Configuration options: [No] [Yes]

Resources Controlled By [Auto]

When set to [Auto], the BIOS automatically configures all the boot and Plug and Play compatible devices. Set to [Manual] if you want to assign the IRQ DMA and memory base address fields.
Configuration options: [Auto] [Manual]



When the item Resources Controlled By is set to [Auto], the item IRQ Resources is grayed out and not user-configurable. Refer to the section "IRQ Resources" for information on how to enable this item.

IRQ Resources

This sub-menu is activated only when the Resources Controlled By item is set to Manual.

Phoenix-Award BIOS CMOS Setup Utility		
Advanced		
IRQ Resources		Select Menu
IRQ-3 assigned to	[PCI Device]	Item Specific Help▶▶▶
IRQ-4 assigned to	[PCI Device]	
IRQ-5 assigned to	[PCI Device]	Legacy ISA for devices
IRQ-7 assigned to	[PCI Device]	compliant with the
IRQ-9 assigned to	[PCI Device]	original PC AT bus
IRQ-10 assigned to	[PCI Device]	specification, PCI/ISA
IRQ-11 assigned to	[PCI Device]	PnP for devices
IRQ-12 assigned to	[PCI Device]	compliant with the
IRQ-14 assigned to	[PCI Device]	Plug and Play standard
IRQ-15 assigned to	[PCI Device]	whether designed for
		PCI or ISA bus
		architecture

F1: Help ↑↓: Select Item -/+ : Change Value F5: Setup Defaults
ESC: Exit →←: Select Menu Enter: Select Sub-menu F10: Save and Exit

IRQ-xx assigned to

When set to [PCI Device], the specific IRQ is free for use of PCI/PnP devices. When set to [Reserved], the IRQ is reserved for legacy ISA devices. Configuration options: [PCI Device] [Reserved]

Assign IRQ for VGA [Enabled]

When set to [Enabled], the BIOS assigns an IRQ to PCI VGA card if the card requests for an IRQ. When set to [Disabled], the BIOS does not assign an IRQ to the PCI VGA card even if requested.
Configuration options: [Disabled] [Enabled]

Maximum Payload Size [4096]

Sets the maximum payload size in bytes for PCI Express devices.
Configuration options: [128] [256] [512] [1024] [2048] [4096]

2.4.5 Onboard Devices Configuration

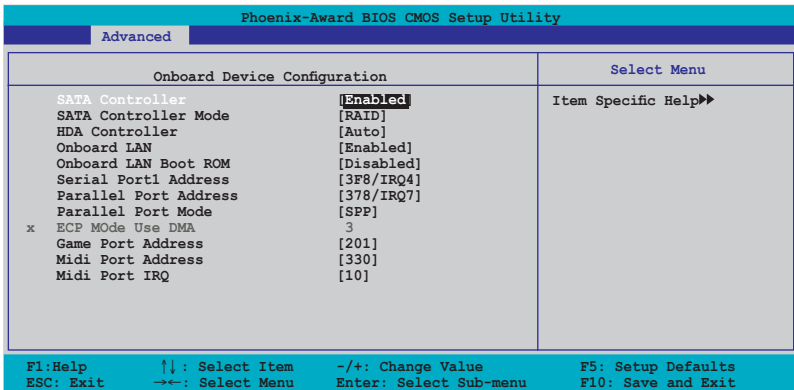

SATA Controller [Enabled]

Allows you to enable or disable the SATA controller.
Configuration options: [Disabled] [Enabled]

SATA Controller Mode [RAID]

Allows you to set the SATA controller mode.
Configuration options: [IDE] [RAID] [AHCI]

HDA Controller [Auto]

Allows you to disable or set the Azalia HDA controller.
Configuration options: [Disabled] [Auto]

Onboard LAN [Enabled]

Allows you to enable or disable the Onboard LAN.
Configuration options: [Disabled] [Enabled]

OnBoard LAN Boot ROM [Disabled]

Allows you to enable or disable the onboard LAN boot ROM.
Configuration options: [Disabled] [Enabled]

Serial Port1 Address [3F8/IRQ4]

Allows you to select the Serial Port1 base address.
Configuration options: [Disabled] [3F8/IRQ4] [2F8/IRQ3] [3E8/IRQ4] [2E8/IRQ3] [Auto]

Parallel Port Address [378/IRQ7]

Allows you to select the Parallel Port base addresses.

Configuration options: [Disabled] [378/IRQ7] [278/IRQ5] [3BC/IRQ7]

Parallel Port Mode [SPP]

Allows you to select the Parallel Port mode.

Configuration options: [SPP] [EPP] [ECP] [ECP+EPP]

ECP Mode Use DMA

Shows the ECP Mode. This item is not configurable.

Game Port Address [201]

Allows you to set the Game Port Address.

Configuration options: [Disabled] [201] [209]

Midi Port Address [330]

Allows you to set the Midi Port Address.

Configuration options: [Disabled] [330] [300]

Midi Port IRQ [10]

Allows you to set the Midi Port IRQ.

Configuration options: [5] [10]

2.4.6 USB Configuration

The items in this menu allows you to change the USB-related features. Select an item then press <Enter> to display the configuration options.

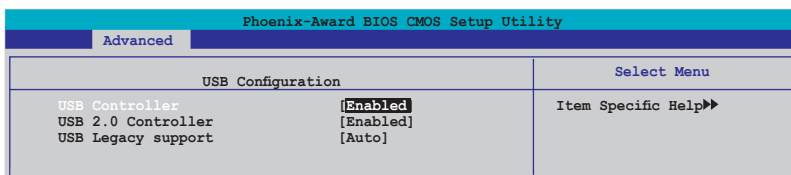

USB Controller [Enabled]

Allows you to enable or disable the USB controller.

Configuration options: [Enabled] [Disabled]

USB 2.0 Controller [Enabled]

Allows you to enable or disable the USB 2.0 controller.

Configuration options: [Disabled] [Enabled]

USB Legacy Support [Auto]

Allows you to enable or disable support for USB devices on legacy operating systems (OS). Configuration options: [Auto] [Disabled] [Enabled]

2.5 Power menu

The Power menu items allow you to change the settings for the Advanced Configuration and Power Interface (ACPI) and the Advanced Power Management (APM). Select an item then press <Enter> to display the configuration options.

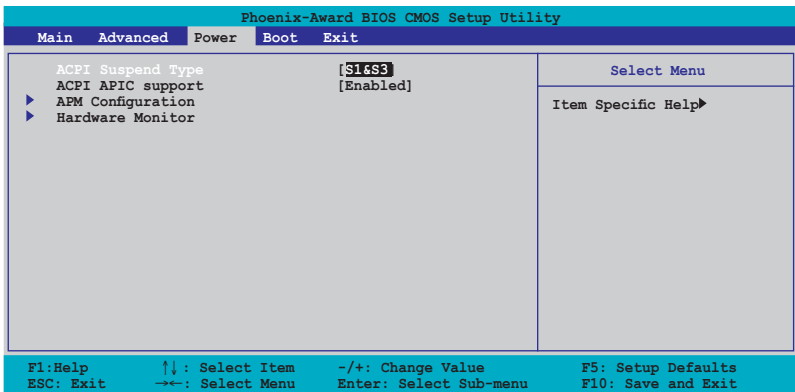

2.5.1 ACPI Suspend Type [S1&S3]

Allows you to select the Advanced Configuration and Power Interface (ACPI) state to be used for system suspend.

Configuration options: [S1 (POS)] [S3 (STR)] [S1&S3]

2.5.2 ACPI APIC Support [Enabled]

Allows you to enable or disable the Advanced Configuration and Power Interface (ACPI) support in the Application-Specific Integrated Circuit (ASIC). When set to Enabled, the ACPI APIC table pointer is included in the RSDT pointer list. Configuration options: [Disabled] [Enabled]

2.5.3 APM Configuration

Phoenix-Award BIOS CMOS Setup Utility			
Power			
APM Configuration			Select Menu
PS2KB Wakeup from S5		Power Key	Item Specific Help▶▶
PS2MS Wakeup from S5		[Disabled]	
Power On By PCI Devices		[Enabled]	
Modem Ring Resume		[Enabled]	
Wake Up On LAN		[Enabled]	
Power On By RTC Alarm		[Disabled]	
x Date (of Month)		0	
x Alarm Time (hh:mm:ss)		0 : 0 : 0	
Restore on AC Power Loss		[Power On]	
PWR Button < 4 secs		[Instant-Off]	
F1: Help ↑↓: Select Item -/+ : Change Value F5: Setup Defaults			
ESC: Exit ←→: Select Menu Enter: Select Sub-menu F10: Save and Exit			

PS2KB Wakeup from S5 [Power Key]

Allows you to disable the Power On by PS/2 keyboard function or set specific keys on the PS/2 keyboard to turn on the system. This feature requires an ATX power supply that provides at least 1A on the +5VSB lead. Configuration options: [Disabled] [Space Bar] [Ctrl+ESC] [Power Key]

PS2MS Wakeup from S5 [Disabled]

When set to [Enabled], this parameter allows you to use the PS/2 mouse to turn on the system. This feature requires an ATX power supply that provides at least 1A on the +5VSB lead. Configuration options: [Disabled] [Enabled]

Power On By PCI Devices [Enabled]

Allows you to disable or enable the Power On By PCI Devices. This feature requires an ATX power supply that provides at least 1A on the +5VSB lead. Configuration options: [Disabled] [Enabled]

Modem Ring Resume [Enabled]

Allows you to disable or enable the Modem Ring Resume. This feature requires an ATX power supply that provides at least 1A on the +5VSB lead. Configuration options: [Disabled] [Enabled]

Wake Up On LAN [Enabled]

Allows you to disable or enable the Wake Up On LAN function. This feature requires an ATX power supply that provides at least 1A on the +5VSB lead. Configuration options: [Disabled] [Enabled]

Power On By RTC Alarm [Disabled]

Allows you to enable or disable RTC to generate a wake event. When this item is set to Enabled, the items Date (of Month) and Resume Time (hh:mm:ss) become configurable with set values.

Configuration options: [Disabled] [Enabled]

Restore on AC Power Loss [Power On]

When set to Power Off, the system goes into off state after an AC power loss. When set to Power On, the system goes on after an AC power loss. When set to Last State, the system goes into either off or on state, whatever the system state was before the AC power loss.

Configuration options: [Power Off] [Power On] [Last State]

PWR Button < 4 secs [Instant-Off]

Allows you to set the event after the power button is pressed for more than 4 seconds. Configuration options: [Suspend] [Instant-Off]

2.5.4 Hardware Monitor

The items in this sub-menu displays the hardware monitor values automatically detected by the BIOS. Select an item then press <Enter> to display the configuration options.

Phoenix-Award BIOS CMOS Setup Utility		
Power		
Hardware Monitor		Select Menu
Vcore Voltage	[1.64V	Item Specific Help▶▶
3.3V Voltage	[3.24V]	Press [Enter] to set.
5V Voltage	[5.21V]	
12V Voltage	[11.71V]	
CPU Temperature	57°C	
M/B Temperature	35°C	
CPU Fan speed	4265 RPM	
Chassis Fan speed	0 RPM	

F1: Help	↑↓: Select Item	-/+ : Change Value	F5: Setup Defaults
ESC: Exit	→←: Select Menu	Enter: Select Sub-menu	F10: Save and Exit

VCORE Voltage, 12V Voltage, 3.3V Voltage, 5V Voltage[xx.x°C] or [Ignored]

The onboard hardware monitor automatically detects the voltage output through the onboard voltage regulators. Select [Ignored] if you do not want to display the detected temperatures.

CPU Temperature

M/B Temperature

The onboard hardware monitor automatically detects and displays the motherboard and CPU temperatures. These items are not user-configurable

CPU Fan Speed

Chassis Fan Speed

The onboard hardware monitor automatically detects and displays the Chassis, CPU, and Power fan speeds in rotations per minute (RPM). If the fan is not connected to the motherboard, the field shows 0. These items are not user-configurable..

2.6 Boot menu

The Boot menu items allow you to change the system boot options. Select an item then press <Enter> to display the sub-menu.

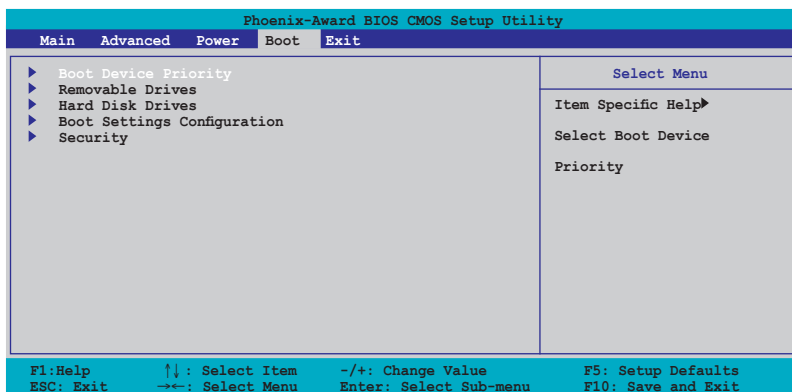

2.6.1 Boot Device Priority

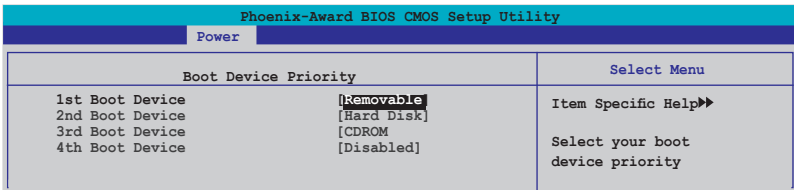

Phoenix-Award BIOS CMOS Setup Utility		
Power		
Boot Device Priority		Select Menu
1st Boot Device	[Removable]	Item Specific Help▶▶ Select your boot device priority
2nd Boot Device	[Hard Disk]	
3rd Boot Device	[CDROM]	
4th Boot Device	[Disabled]	

1st ~ xxth Boot Device [Removable]

These items specify the boot device priority sequence from the available devices. The number of device items that appears on the screen depends on the number of devices installed in the system.

Configuration options: [Removable] [xxxxx Drive] [Disabled]

2.6.2 Removable Drives

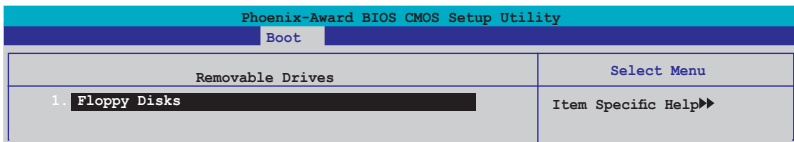

Phoenix-Award BIOS CMOS Setup Utility		
Boot		
Removable Drives		Select Menu
1.	Floppy Disks	Item Specific Help▶▶

1. Floppy Disks

Allows you to select a removable drive attached to the system.

2.6.3 Hard Disk Drives

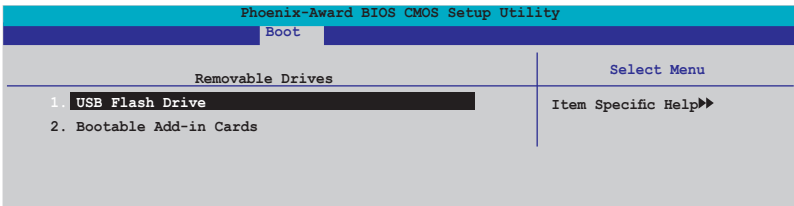

Phoenix-Award BIOS CMOS Setup Utility		
Boot		
Removable Drives		Select Menu
1	USB Flash Drive	Item Specific Help▶▶
2.	Bootable Add-in Cards	

1. USB Flash Drive

Allows you to select a flash disk drive attached to the system.

2. Bootable Add-in Cards

Allows you to select an add-in disk drive attached to the system.

2.6.4 Boot Settings Configuration

Phoenix-Award BIOS CMOS Setup Utility		
Boot		
Boot Settings Configuration		Select Menu
Case Open Warning	Enabled	Item Specific Help▶▶ Press [Enter] to enable or disable.
Quick Boot	[Enabled]	
Boot Up Floppy Seek	[Disabled]	
Bootup Num-Lock	[On]	
Typematic Rate Setting	[Disabled]	
x Typematic Rate (Chars/Sec)	6	
x Typematic Delay (Msec)	250	
OS Select For DRAM > 64MB	[Non-OS2]	
Full Screen LOGO	[Enabled]	
Halt On	[All, But Keyboard]	

Case Open Warning [Enabled]

Enables or disables the chassis open status feature. Setting to Enabled, clears the chassis open status. Configuration options: [Disabled] [Enabled]

Quick Boot [Enabled]

Enables or disables the quick boot feature. When Enabled, the system skips certain tests while booting. Configuration options: [Disabled] [Enabled]

Boot Up Floppy Seek [Disabled]

Enable this item to check for a boot floppy disk during POST. Configuration options: [Disabled] [Enabled]



The items Typematic Rate (Chars/Sec) and Typematic Delay (Msec) becomes user-configurable only when the item Typematic Rate Setting is enabled.

Bootup Num-Lock [On]

Allows you to select the power-on state for the NumLock. Configuration options: [Off] [On]

Typematic Rate Setting [Disabled]

Allows you to set the keystroke rate. Enable this item to configure the Typematic Rate (Chars/Sec) and the Typematic Delay (Msec). Configuration options: [Disabled] [Enabled]

OS Select for DRAM > 64MB [Non-OS2]

Set this item to OS2 only when you are running on an OS/2 operating system with an installed RAM of greater than 64 KB.

Configuration options: [Non-OS2] [OS2]

Full Screen LOGO [Enabled]

Allows you to enable or disable the full screen logo display feature.

Configuration options: [Disabled] [Enabled]



Make sure that the above item is set to [Enabled] if you want to use the ASUS MyLogo™ feature.

Halt On [All, But Keyboard]

Allows you to error report type.

Configuration options: [All Errors] [No Errors] [All, But Keyboard]

[All, But Diskette] [All, But Disk/Key]

2.6.5 Security

Phoenix-Award BIOS CMOS Setup Utility	
Boot	
Boot Settings Configuration	Select Menu
Supervisor Password Clear	Item Specific Help▶▶
User Password Clear	Supervisor password
Password Check [Setup]	controls full access,
	<Enter> to change
	password.

Supervisor Password User Password

These fields allow you to set passwords:

To set a password:

1. Select an item then press <Enter>.
2. Type in a password using a combination of a maximum of eight (8) alpha-numeric characters, then press <Enter>.
3. When prompted, confirm the password by typing the exact characters again, then press <Enter>. The password field setting is changed to Set.

To clear the password:

1. Select the password field and press <Enter> twice. The following message appears:



2. Press any key to continue. The password field setting is changed to Clear.

A note about passwords

The Supervisor password is required to enter the BIOS Setup program preventing unauthorized access. The User password is required to boot the system preventing unauthorized use.

Forgot your password?

If you forget your password, you can clear it by erasing the CMOS Real Time Clock (RTC) RAM. The RAM data containing the password information is powered by the onboard button cell battery. If you need to erase the CMOS RAM, refer to section “1.9 Jumpers” for instructions.

Password Check

This field requires you to enter the password before entering the BIOS setup or the system. Select [Setup] to require the password before entering the BIOS Setup. Select [System] to require the password before entering the system. Configuration options: [Setup] [System]

2.7 Exit menu

The Exit menu items allow you to load the optimal or failsafe default values for the BIOS items, and save or discard your changes to the BIOS items.

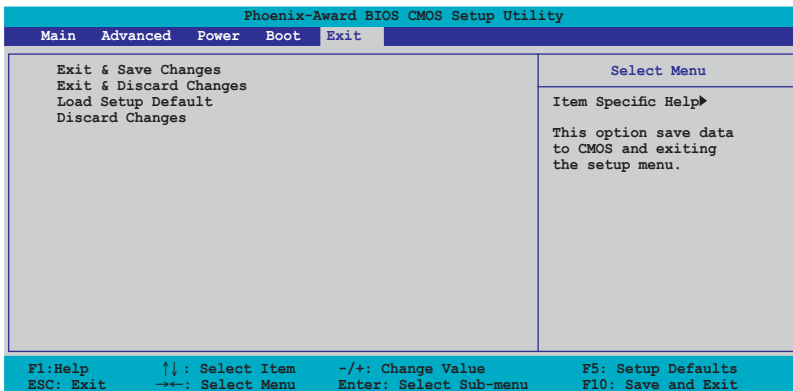

Pressing <Esc> does not immediately exit this menu. Select one of the options from this menu or <F10> from the legend bar to exit.

Exit & Save Changes

Once you are finished making your selections, choose this option from the Exit menu to ensure the values you selected are saved to the CMOS RAM. An onboard backup battery sustains the CMOS RAM so it stays on even when the PC is turned off. When you select this option, a confirmation window appears. Select **Yes** to save changes and exit.



If you attempt to exit the Setup program without saving your changes, the program prompts you with a message asking if you want to save your changes before exiting. Press <Enter> to save the changes while exiting.

Exit & Discard Changes

Select this option only if you do not want to save the changes that you made to the Setup program. If you made changes to fields other than System Date, System Time, and Password, the BIOS asks for a confirmation before exiting.

Load Setup Defaults

This option allows you to load the default values for each of the parameters on the Setup menus. When you select this option or if you press <F5>, a confirmation window appears. Select Yes to load default values. Select **Exit & Save** Changes or make other changes before saving the values to the non-volatile RAM.

Discard Changes

This option allows you to discard the selections you made and restore the previously saved values. After selecting this option, a confirmation appears. Select **Yes** to discard any changes and load the previously saved values.

This chapter describes the contents of the support CD that comes with the motherboard package.

3 Software support

3.1 Installing an operating system

This motherboard supports Windows® 2000/2003 Server/XP/64-bit XP operating systems (OS). Always install the latest OS version and corresponding updates to maximize the features of your hardware.



- Motherboard settings and hardware options vary. Use the setup procedures presented in this chapter for reference only. Refer to your OS documentation for detailed information.
- Make sure that you install Windows® 2000 Service Pack 4 or the Windows® XP Service Pack 2 or later versions before installing the drivers for better compatibility and system stability.

3.2 Support CD information

The support CD that came with the motherboard package contains the drivers, software applications, and utilities that you can install to avail all motherboard features.



The contents of the support CD are subject to change at any time without notice. Visit the ASUS website(www.asus.com) for updates.

3.2.1 Running the support CD

Place the support CD to the optical drive. The CD automatically displays the Drivers menu if Autorun is enabled in your computer.

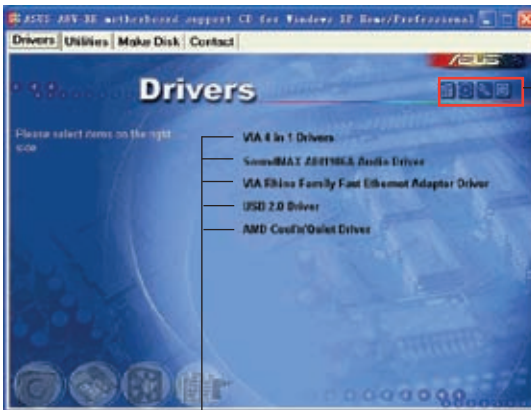

Click an icon to display support CD/motherboard information

Click an item to install



If Autorun is NOT enabled in your computer, browse the contents of the support CD to locate the file ASSETUP.EXE from the BIN folder. Double-click the **ASSETUP.EXE** to run the CD.

3.2.2 Drivers menu

The drivers menu shows the available device drivers if the system detects installed devices. Install the necessary drivers to activate the devices.

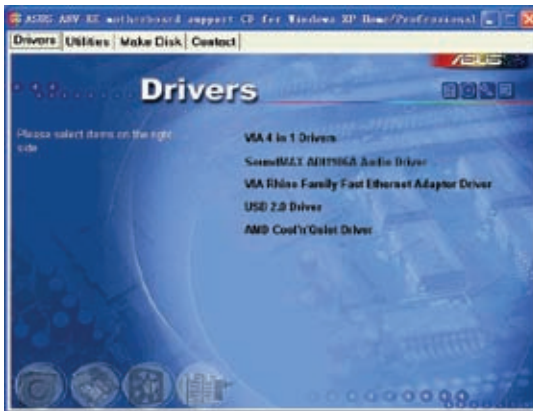

VIA 4 in 1 Drivers

Installs the VIA 4 in 1 Drivers.

SoundMAX AD1986A Audio Driver

Installs the AD1986A Audio Driver.

VIA Rhine Family Fast Ethernet Adapter Driver

Install the VIA Rhine Family Fast Ethernet Adapter Driver.

USB 2.0 Driver

Installs the USB 2.0 Driver.

AMD Cool 'n' Quiet Driver

Installs the AMD Cool 'n' Quiet Driver.

3.2.3 Utilities menu

The Utilities menu shows the applications and other software that the motherboard supports.



ASUS PC Probe II

This smart utility monitors the fan speed, CPU temperature, and system voltages, and alerts you of any detected problems. This utility helps you keep your computer in healthy operating condition.

ASUS Update

Allows you to download the latest version of the BIOS from the ASUS website.



Before using the ASUS Update, make sure that you have an Internet connection so you can connect to the ASUS website.

Microsoft DirectX

Installs the Microsoft® DirectX 9.0c driver. The Microsoft DirectX® 9.0c is a multimedia technology that enhances computer graphics and sound. DirectX® improves the multimedia features of your computer so you can enjoy watching TV and movies, capturing videos, or playing games in your computer. Visit the Microsoft website (www.microsoft.com) for updates.

ADOBE Acrobat Reader

Installs the Adobe® Acrobat® Reader V7.0 that allows you to open, view, and print documents in Portable Document Format (PDF).

ASUS Screen Saver

Bring life to your computer screen by installing the ASUS screen saver.

ASUS Cool'n'Quiet Utility

Launches the ASUS Cool 'n' Quiet!™ Technology driver installation wizard.

Anti-virus Utility

The anti-virus application scans, identifies, and removes computer viruses. View the online help for detailed information.

3.2.4 Make Disk menu

The Make Disk menu allows you to make RAID/Serial ATA driver disks.



VIA 8251 RAID Driver Disk

Allows you to create an VIA 8251 RAID driver disk.

3.2.5 Manuals menu

The Manuals menu contains a list of supplementary user manuals. Click an item to open the folder of the user manual.



Most user manual files are in Portable Document Format (PDF). Install the Adobe® Acrobat® Reader from the Utilities menu before opening a user manual file.



VT8251 RAID User Guide

Allows you to open the VT8251 RAID user guide.

3.2.6 ASUS Contact information

Click the Contact tab to display the ASUS contact information. You can also find this information on the inside front cover of this user guide.



Free Manuals Download Website

<http://myh66.com>

<http://usermanuals.us>

<http://www.somanuals.com>

<http://www.4manuals.cc>

<http://www.manual-lib.com>

<http://www.404manual.com>

<http://www.luxmanual.com>

<http://aubethermostatmanual.com>

Golf course search by state

<http://golfingnear.com>

Email search by domain

<http://emailbydomain.com>

Auto manuals search

<http://auto.somanuals.com>

TV manuals search

<http://tv.somanuals.com>