

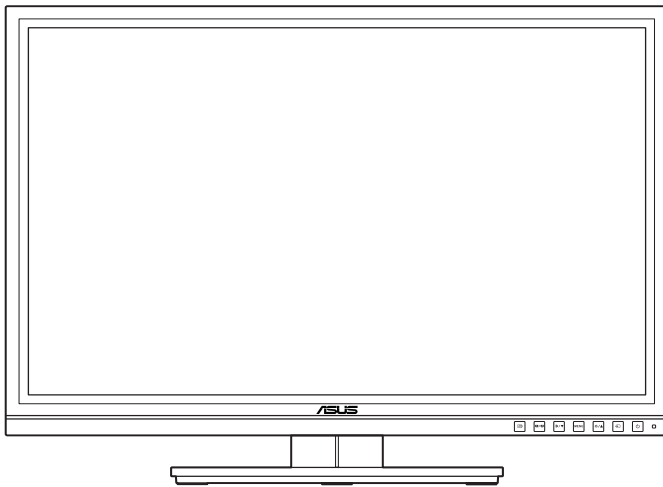

PA246 Series

LCD Monitor

User Guide



Contents

Contents	ii
Notices.....	iii
Safety information	iv
Care & Cleaning.....	v
Chapter 1: Product introduction	
1.1 Welcome!	1-1
1.2 Package contents.....	1-1
1.3 Monitor introduction	1-2
1.3.1 Front view	1-2
1.3.2 Back view.....	1-3
1.3.3 QuickFit Function	1-4
Chapter 2: Setup	
2.1 Detaching the arm/base (for VESA wall mount)	2-1
2.2 Adjusting the monitor.....	2-2
2.3 Connecting the cables.....	2-3
2.4 Turning on the monitor.....	2-3
Chapter 3: General instructions	
3.1 OSD (On-Screen Display) menu	3-1
3.1.1 How to reconfigure.....	3-1
3.1.2 OSD function introduction	3-1
3.2 Specifications summary (PA246)	3-7
3.3 Troubleshooting (FAQ).....	3-8
3.4 Supported operating modes	3-9

Notices

Federal Communications Commission Statement

This device complies with Part 15 of the FCC Rules. Operation is subject to the following two conditions:

- This device may not cause harmful interference, and
- This device must accept any interference received including interference that may cause undesired operation.

This equipment has been tested and found to comply with the limits for a Class B digital device, pursuant to Part 15 of the FCC Rules. These limits are designed to provide reasonable protection against harmful interference in a residential installation. This equipment generates, uses and can radiate radio frequency energy and, if not installed and used in accordance with manufacturer's instructions, may cause harmful interference to radio communications. However, there is no guarantee that interference will not occur in a particular installation. If this equipment does cause harmful interference to radio or television reception, which can be determined by turning the equipment off and on, the user is encouraged to try to correct the interference by one or more of the following measures:

- Reorient or relocate the receiving antenna.
- Increase the separation between the equipment and receiver.
- Connect the equipment to an outlet on a circuit different from that to which the receiver is connected.
- Consult the dealer or an experienced radio/TV technician for help.



The use of shielded cables for connection of the monitor to the graphics card is required to assure compliance with FCC regulations. Changes or modifications to this unit not expressly approved by the party responsible for compliance could void the user's authority to operate this equipment.

Canadian Department of Communications Statement

This digital apparatus does not exceed the Class B limits for radio noise emissions from digital apparatus set out in the Radio Interference Regulations of the Canadian Department of Communications.

This class B digital apparatus complies with Canadian ICES-003.

This Class B digital apparatus meets all requirements of the Canadian Interference - Causing Equipment Regulations.

Cet appareil numérique de la classe B respecte toutes les exigences du Règlement sur le matériel brouiller du Canada.

Safety information

- Before setting up the monitor, carefully read all the documentation that came with the package.
- To prevent fire or shock hazard, never expose the monitor to rain or moisture.
- Never try to open the monitor cabinet. The dangerous high voltages inside the monitor may result in serious physical injury.
- If the power supply is broken, do not try to fix it by yourself. Contact a qualified service technician or your retailer.
- Before using the product, make sure all cables are correctly connected and the power cables are not damaged. If you detect any damage, contact your dealer immediately.
- Slots and openings on the back or top of the cabinet are provided for ventilation. Do not block these slots. Never place this product near or over a radiator or heat source unless proper ventilation is provided.
- The monitor should be operated only from the type of power source indicated on the label. If you are not sure of the type of power supply to your home, consult your dealer or local power company.
- Use the appropriate power plug which complies with your local power standard.
- Do not overload power strips and extension cords. Overloading can result in fire or electric shock.
- Avoid dust, humidity, and temperature extremes. Do not place the monitor in any area where it may become wet. Place the monitor on a stable surface.
- Unplug the unit during a lightning storm or if it will not be used for a long period of time. This will protect the monitor from damage due to power surges.
- Never push objects or spill liquid of any kind into the slots on the monitor cabinet.
- To ensure satisfactory operation, use the monitor only with UL listed computers which have appropriate configured receptacles marked between 100-240V AC.
- If you encounter technical problems with the monitor, contact a qualified service technician or your retailer.



This symbol of the crossed out wheeled bin indicates that the product (electrical, electronic equipment, and mercury-containing button cell battery) should not be placed in municipal waste. Please check local regulations for disposal of electronic products.

Care & Cleaning

- Before you lift or reposition your monitor, it is better to disconnect the cables and power cord. Follow the correct lifting techniques when positioning the monitor. When lifting or carrying the monitor, grasp the edges of the monitor. Do not lift the display by the stand or the cord.
- Cleaning. Turn your monitor off and unplug the power cord. Clean the monitor surface with a lint-free, non-abrasive cloth. Stubborn stains may be removed with a cloth dampened with mild cleaner.
- Avoid using a cleaner containing alcohol or acetone. Use a cleaner intended for use with the monitor. Never spray cleaner directly on the screen, as it may drip inside the monitor and cause an electric shock.

The following symptoms are normal with the monitor:

- The screen may flicker during the initial use due to the nature of the fluorescent light. Turn off the Power Switch and turn it on again to make sure that the flicker disappears.
- You may find slightly uneven brightness on the screen depending on the desktop pattern you use.
- When the same image is displayed for hours, an afterimage of the previous screen may remain after switching the image. The screen will recover slowly or you can turn off the Power Switch for hours.
- When the screen becomes black or flashes, or cannot work anymore, contact your dealer or service center to fix it. Do not repair the screen by yourself!

Conventions used in this guide



WARNING: Information to prevent injury to yourself when trying to complete a task.



CAUTION: Information to prevent damage to the components when trying to complete a task.



IMPORTANT: Information that you **MUST** follow to complete a task.



NOTE: Tips and additional information to aid in completing a task.

Where to find more information

Refer to the following sources for additional information and for product and software updates.

1. ASUS websites

The ASUS websites worldwide provide updated information on ASUS hardware and software products. Refer to <http://www.asus.com>

2. Optional documentation

Your product package may include optional documentation that may have been added by your dealer. These documents are not part of the standard package.

1.1 Welcome!

Thank you for purchasing the ASUS® LCD monitor!

The latest widescreen LCD monitor from ASUS provides a crisper, broader, and brighter display, plus a host of features that enhance your viewing experience.

With these features, you can enjoy the convenience and delightful visual experience that the monitor brings to you!

1.2 Package contents

Check your package for the following items:

- ✓ LCD monitor
- ✓ Quick start guide
- ✓ Warranty card
- ✓ Power cord
- ✓ VGA cable
- ✓ DVI cable
- ✓ DisplayPort cable
- ✓ USB cable
- ✓ Support CD
- ✓ Cable tie
- ✓ Color Calibration Testing Report





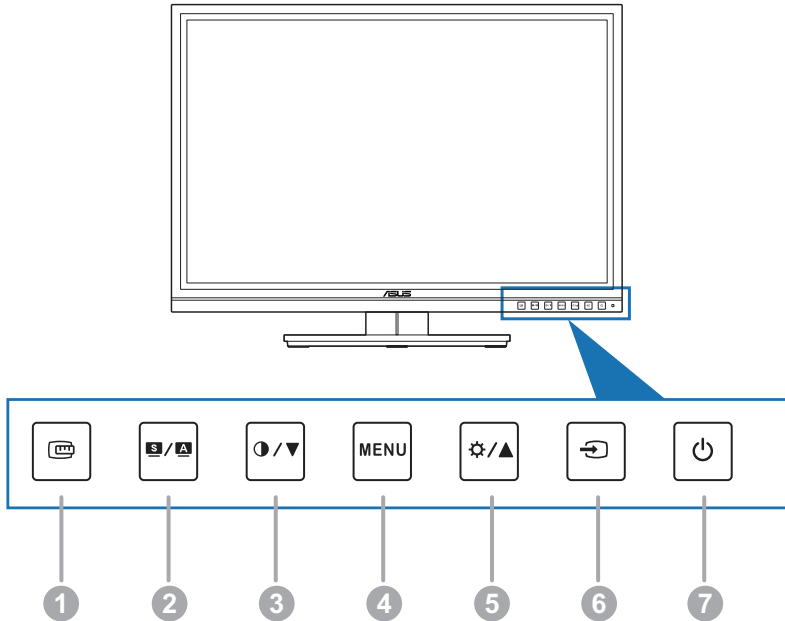

If any of the above items is damaged or missing, contact your retailer immediately.

1.3 Monitor introduction

1.3.1 Front view



1.  QuickFit button:
 - Activates the QuickFit function designed for alignment.
 - The QuickFit function contains 7 pages of common grid patterns and paper and photo sizes. (Please refer to 1.3.3 QuickFit Function).
2.  S / A button:
 - Selects a desired preset mode.
 - Exits the OSD menu or goes back to the previous menu when the OSD menu is active.
 - Automatically adjusts the image to its optimized position, clock, and phase by pressing this button for 2-4 seconds (for VGA mode only).
3. 
 - Decreases values or moves your selection left/down.
 - Contrast hotkey
4. MENU button:
 - Turns on the OSD menu. Enacts the selected OSD menu item.
 - Exits the hotkey OSD menu.

5. 
 - Increases values or moves your selection right/up.
 - Brightness hotkey
6.  button:
 - Selects an available input source.



Press  button (Input Select button) to display HDMI/DisplayPort signals after you connect HDMI/DisplayPort cable with the monitor.

7.  Power button/power indicator
 - Turns the monitor on/off.
 - The color definition of the power indicator is as the below table.

Status	Description
White	ON
Orange	Standby mode
OFF	OFF

1.3.2 Back view

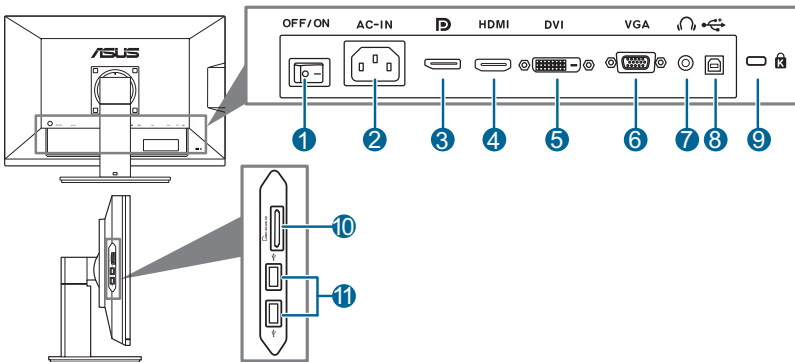

Rear connectors

1. **Power switch.** Press the switch to turn on/off power.
2. **AC-IN port.** This port connects the power cord.
3. **DisplayPort.** This port is for connection for a DisplayPort compatible device.
4. **HDMI port.** This port is for connection with an HDMI compatible device.

5. **DVI port.** This 24-pin port is for PC (Personal Computer) DVI-D digital signal connection.
6. **VGA port.** This 15-pin port is for PC VGA connection.
7. **Earphone jack.**
8. **USB upstream port.** This port is for connection with a USB upstream cable. The cable enables the USB ports and card reader on the monitor.
9. **Kensington lock slot.**
10. **Card reader.** See below for more information about the card reader specifications.
11. **USB downstream ports.** These ports are for connection with USB devices, such as USB keyboard/mouse, USB flash drive, etc.

Card reader specifications

Supported Media Types :	Memory Stick (MS), High Speed Memory Stick (HSMS), Memory Stick PRO (MSPRO), Memory Stick Duo(w Adapter), MS Duo Secure Digital (Mini-SD), Secure Digital Card, Mini Secure Digital(w Adaptor), TransFlash(SD, including SDHC), MultiMediaCard(MMC), Reduced Size MultiMediaCard(RS-MMC), NAND Flash, xD
Card Slots :	Lower Slot (built-in Push Ejection Mechanism): SD / MS / MMC/xD – direct insertion MS Duo / Mini-SD / TransFlash Card / RS-MMC – with adapter

1.3.3 QuickFit Function

The QuickFit function contains three kinds of patterns: (1) Grid patterns (2) Paper size (3) Photo size.

1. Grid patterns

The grid patterns facilitate designers and users to organize content and layout on a page and achieve a consistent look and feel.

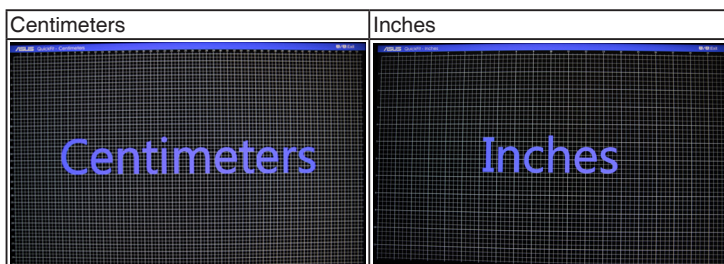



2. Paper size

QuickFit provides numerous commonly used standard paper sizes for users to view their documents in real size on the screen.

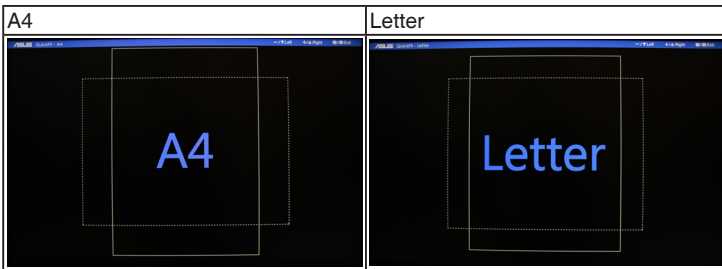

3. Photo size

The various real photo sizes displayed in the QuickFit function provides photographers and other users to accurately view and edit their photos in real size on the screen.

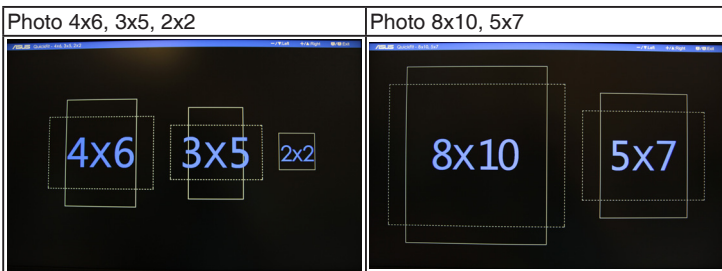

2.1 Detaching the arm/base (for VESA wall mount)

The detachable arm/base of this monitor is specially designed for VESA wall mount.

To detach the arm/base:

1. Have the front of the monitor face down on a table.
2. Use a screwdriver to remove the four screws on the arm (Figure 1), and then detach the arm/base from the monitor (Figure 2).

(Figure 1)

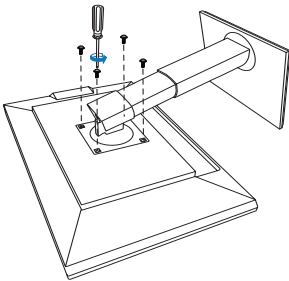

(Figure 2)

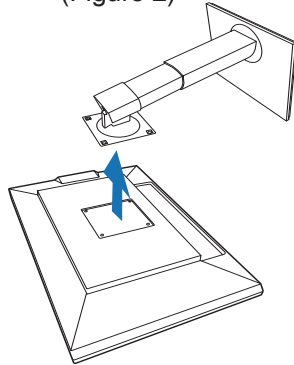

We recommend that you cover the table surface with soft cloth to prevent damage to the monitor.

2.2 Adjusting the monitor

- For optimal viewing, we recommend that you look at the full face of the monitor, then adjust the monitor to the angle that is most comfortable for you.
- Hold the stand to prevent the monitor from falling when you change its angle.
- You can adjust the monitor's angle from $+20^\circ$ to -5° and it allows 60° swivel adjustment from either left or right. You can also adjust the monitor's height within ± 10 cm.

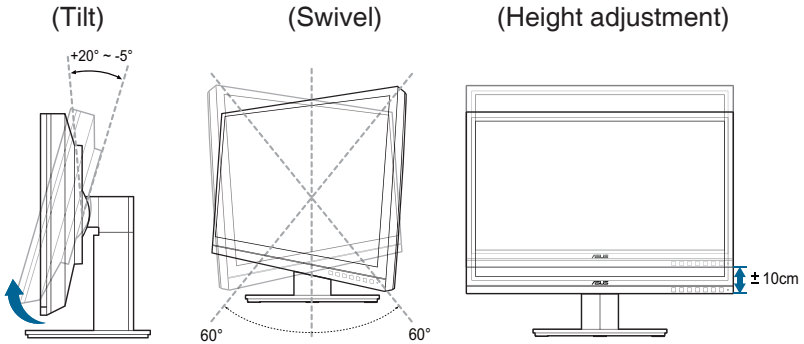

Pivoting the monitor

1. Lift the monitor to the highest position.
2. Tilt the monitor to its maximum angle.
3. Pivot the monitor clockwise to the angle you need.

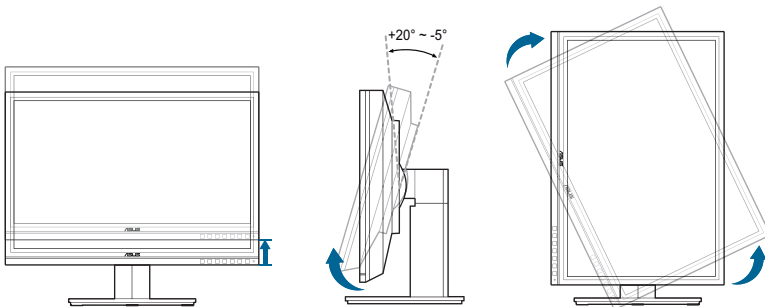

It is normal that the monitor slightly shakes while you adjust the viewing angle.

2.3 Connecting the cables

1. Connect the cables as the following instructions:

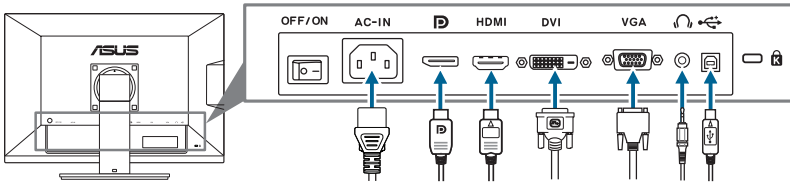



- **To connect the power cord:** connect one end of the power cord securely to the monitor's AC input port, the other end to a power outlet.
- **To connect the VGA/HDMI/DVI/DisplayPort cable:**
 - a. Plug one end of the VGA/HDMI/DVI/DisplayPort cable to the monitor's VGA/HDMI/DVI/DisplayPort jack.
 - b. Connect the other end of the VGA/HDMI/DVI/DisplayPort cable to your computer's VGA/HDMI/DVI/DisplayPort jack.
 - c. Tighten the two screws to secure the VGA/DVI connector.
- **To use the earphone:** connect the end with plug type to the monitor's earphone jack when an HDMI or DisplayPort signal is fed.
- **To use the USB ports:** Plug the smaller end (type B) of the USB upstream cable to the monitor's USB upstream port, and the larger end (type A) to your computer's USB port. That will enable the USB ports and card reader on the monitor to work.



When these cables are connected, you can choose the desired signal from the Input Select item in the OSD menu.

2.4 Turning on the monitor

Press the power button . See page 1-2 for the location of the power button. The power indicator  lights up in white to show that the monitor is ON.

3.1 OSD (On-Screen Display) menu

3.1.1 How to reconfigure

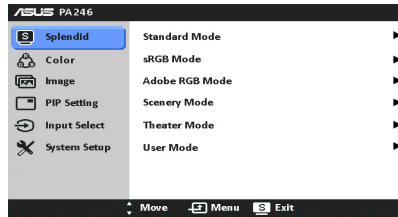

1. Press the MENU button to activate the OSD menu.
2. Press **○ / ▼**, and **⚙ / ▲** to navigate through the functions. Highlight the desired function and press the MENU button to activate it. If the function selected has a sub-menu, press **○ / ▼** and **⚙ / ▲** again to navigate through the sub-menu functions. Highlight the desired sub-menu function and press the MENU button to activate it.
3. Press **○ / ▼**, and **⚙ / ▲** to change the settings of the selected function.
4. To exit and save the OSD menu, press the **S / A** button repeatedly until the OSD menu disappears. To adjust other functions, repeat steps 1-3.

3.1.2 OSD function introduction

1. Splendid

This function contains six sub-functions you can select for your preference. Each mode has the Reset selection, allowing you to maintain your setting or return to the preset mode.

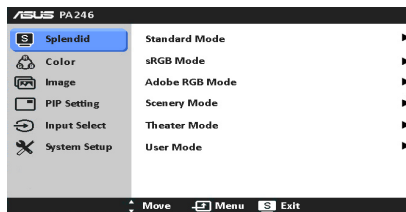

- **Standard Mode:** best choice for document editing with SPLENDID™ Video Enhancement.
- **sRGB Mode:** compatible with sRGB color space, sRGB mode is the best choice for document editing.

Color Space	White Point		Primaries					
	X _w	Y _w	X _r	Y _r	X _g	Y _g	X _b	Y _b
sRGB	0.3127	0.329	0.64	0.33	0.3	0.6	0.15	0.06

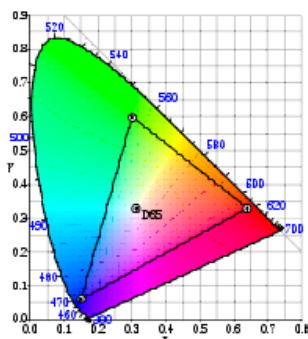

- **Adobe RGB Mode:** compatible with Adobe RGB color space.

Color Space	White Point		Primaries					
	X _w	Y _w	X _r	Y _r	X _g	Y _g	X _b	Y _b
Adobe RGB	0.3127	0.329	0.64	0.33	0.21	0.71	0.15	0.06

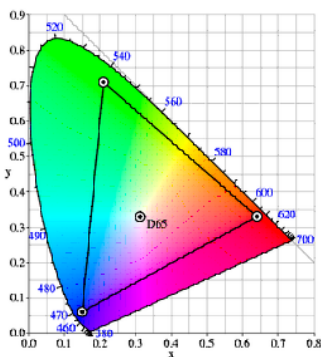

- **Scenery Mode:** best choice for scenery photo display with SPLENDID™ Video Enhancement.
- **Theater Mode:** best choice for movies with SPLENDID™ Video Enhancement.
- **User Mode:** More items are adjustable in the Color menu.

Function		Standard Mode	sRGB Mode	Adobe RGB Mode	Scenery Mode	Theater Mode	User Mode
Brightness		Yes	Yes	Yes	Yes	Yes	Yes
Contrast		Yes	No	No	Yes	Yes	Yes
Saturation		No	No	No	Yes	Yes	Yes
Hue		No	No	No	No	No	Yes
Color Temperature		Yes	No	No	Yes	Yes	No
Gamma		Yes	No	No	No	No	Yes
Advanced Setting	Six-axis Hue	No	No	No	No	No	Yes
	Six-axis Saturation	No	No	No	No	No	Yes
	Gain	No	No	No	No	No	Yes
	Offset	No	No	No	No	No	Yes

2. Color

Set a desired color setting from this menu.

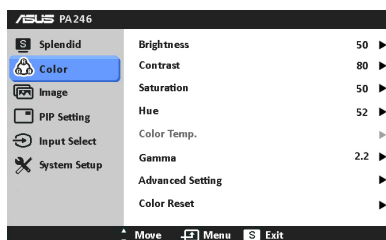

- **Brightness:** the adjusting range is from 0 to 100. / is a hotkey to activate this function.
- **Contrast:** the adjusting range is from 0 to 100. / is a hotkey to activate this function.
- **Saturation:** the adjusting range is from 0 to 100.
- **Hue:** shifts the image color between green and purple.
- **Color Temp.:** contains 3 modes including 9300K, 6500K and 5000K.
- **Gamma:** allows you to set the color mode to 2.2 or 1.8 (D50).
- **Advanced Setting:**
 - * 6-axis Hue adjustment.

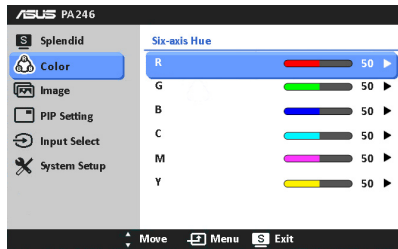

- * 6-axis Saturation adjustment.

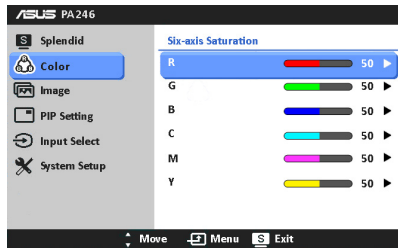

- * Adjusts the gain levels for R, G, B.
- * Adjusts the black level offset values for R, G, B.
- **Color Reset:**
 - * Current Splendid color mode reset:
Resets the color settings of current color mode to the factory default value.
 - * All Splendid color mode reset:
Resets the color settings of all color modes to the factory default value.

3. Image

Set the image related setting from this menu.

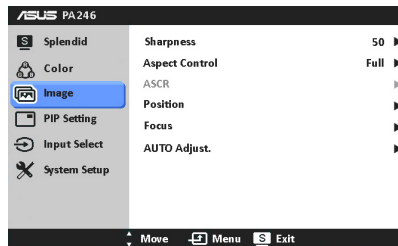

- **Sharpness:** the adjusting range is from 0 to 100.
- **Aspect Control:** adjusts the aspect ratio to full, 4:3, 1:1, or OverScan (only available for the HDMI input).
- **ASCR:** turns on/off the ASCR (ASUS Smart Contrast Ratio) function.

- **Position:** adjusts the horizontal position (H-Position) and the vertical position (V-Position) of the image. The adjusting range is from 0 to 100.
- **Focus:** reduces Horizontal-line noise and Vertical-line noise of the image by adjusting (Phase) and (Clock) separately. The adjusting range is from 0 to 100.
- **AUTO Adjust.:** Automatically adjusts the image to its optimized position, clock, and phase.



- Phase adjusts the phase of the pixel clock signal. With a wrong phase adjustment, the screen shows horizontal disturbances.
- Clock (pixel frequency) controls the number of pixels scanned by one horizontal sweep. If the frequency is not correct, the screen shows vertical stripes and the image is not proportional.

4. PIP Setting

The PIP Setting allows you to open up another sub-window connected from another video source besides the main-window from your original video source. By activating this function, you can have two pictures from two different video sources displayed by the monitor.

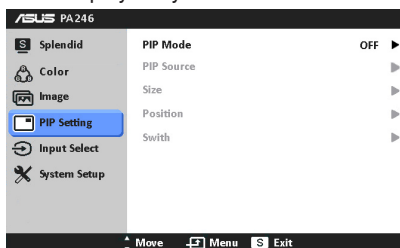

- **PIP Mode:** turns the PIP function on or off.
- **PIP Source:** Selects the video input source from among VGA, DVI, HDMI, and DisplayPort.
- **Size:** Adjusts the PIP size to Small, Middle, or Large.
- **Position:** Adjusts the position of the sub-window to Right-Top, Left-Top, Right-Bottom, or Left-Bottom.
- **Switch:** Switches the sources of the main and sub-windows.



The DVI and HDMI input sources should not be selected as the main-window or sub-window at the same time. See the table below for details.

		Main-window			
		VGA	DVI	HDMI	DisplayPort
Sub-window	VGA		Yes	Yes	Yes
	DVI	Yes		No	Yes
	HDMI	Yes	No		Yes
	DisplayPort	Yes	Yes	Yes	

5. Input Select

In this function, you can select your desired input source.

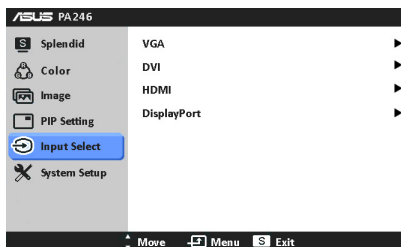

6. System Setup

Allows you to adjust the system.

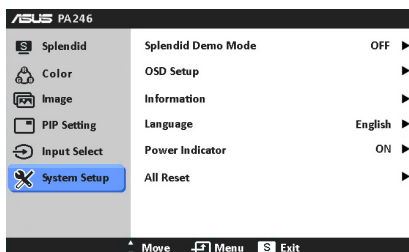





- **Splendid Demo Mode:** splits the screen into two for Splendid modes comparison. (Scenery mode/theater mode only)
- **OSD Setup:**
 - * Adjusts the horizontal position (H-Position)/the vertical position (V-Position) of the OSD from 0 to 100.
 - * Adjusts the OSD timeout from 10 to 120 seconds.
 - * Enables or disables the DDC/CI function.
 - * Adjusts the OSD background from opaque to transparent.
- **Information:** shows the monitor information.
- **Language:** there are 10 languages for your selection, including English, French, German, Spanish, Italian, Dutch, Russian, Traditional Chinese, Simplified Chinese, and Japanese.
- **Power Indicator:** turns the power LED indicator on/off.
- **All Reset:** “Yes” allows you to restore the default settings.

3.2 Specifications summary (PA246)

Panel Type	TFT LCD
Panel size	24.1" (16:10, 61.13 cm) wide screen
Max. Resolution	1920 x 1200
Pixel pitch	0.270 mm
Brightness (Max.)	400 cd/m ²
Contrast Ratio (Typ.)	1000:1
Contrast Ratio (Max.)	50,000:1 (with ASCR on)
Viewing angle(H/V) CR>10	178°/178°
Display colors	1.07 Billion
Response time	6 ms (Gray to gray)
SPLendid™ Video Enhancement	Yes
SPLendid™ selection	6 video preset modes (by hotkey)
Auto adjustment	Yes
Color temperature selection	3 color temperatures
Digital input	HDMI v1.3, DisplayPort V1.1a, DVI-D with HDCP
Analog input	D-Sub
Earphone jack	Yes
Colors	Black
Power LED	White (On)/Orange (Standby)
Tilt	+20° ~ -5°
Swivel	+60° ~ -60°
Height Adjustment	100 mm
Kensington lock	Yes
AC input voltage	AC: 100~240V
Power consumption	Power On: < 130 W (Max.), Standby: < 1 W (Typ.), Power Off: 0 W (Switch off)
Temperature (Operating)	0°C~40°C
Temperature (Non-operating)	-20°C~+60°C
Dimension (W x H x D)	559 mm x 381 mm x 235 mm (machine) 683 mm x 457 mm x 298 mm (package)
Weight (Esti.)	7.3 kg (Net); 10.7 kg (Gross)
Multi-languages	10 languages (English, German, Italian, French, Dutch, Spanish, Russian, Traditional Chinese, Simplified Chinese, Japanese)
Accessories	VGA cable, DVI cable, DisplayPort cable, Power cord, USB cable, Quick start guide, Warranty card, Support CD, Cable tie, Color Calibration Testing Report
Regulation approvals	TCO03, TUV-GS, TUV-Ergo, ErP, UL/cUL, CB, CE, FCC, CCC, BSMI, Gost-R, C-Tick, VCCI, PSB, J-MOSS, RoHS, WEEE, Windows 7 WHQL

*Specifications are subject to change without notice.

3.3 Troubleshooting (FAQ)

Problem	Possible Solution
Power LED is not ON	<ul style="list-style-type: none"> • Press the  button to check if the monitor is in the ON mode. • Check if the power cord is properly connected to the monitor and the power outlet. • Check if the power switch is ON.
The power LED lights amber and there is no screen image	<ul style="list-style-type: none"> • Check if the monitor and the computer are in the ON mode. • Make sure the signal cable is properly connected the monitor and the computer. • Inspect the signal cable and make sure none of the pins are bent. • Connect the computer with another available monitor to check if the computer is properly working.
Screen image is too light or dark	<ul style="list-style-type: none"> • Adjust the Contrast and Brightness settings via OSD.
Screen image is not centered or sized properly	<ul style="list-style-type: none"> • Press the  /  button for 2-4 seconds to automatically adjust the image (for VGA mode only). • Adjust the H-Position or V-Position settings via OSD.
Screen image bounces or a wave pattern is present in the image	<ul style="list-style-type: none"> • Make sure the signal cable is properly connected to the monitor and the computer. • Move electrical devices that may cause electrical interference.
Screen image has color defects (white does not look white)	<ul style="list-style-type: none"> • Inspect the signal cable and make sure that none of the pins are bent. • Perform All Reset via OSD. • Adjust the R/G/B color settings or select the Color Temperature via OSD.
Screen image is blurry or fuzzy	<ul style="list-style-type: none"> • Press the  /  button for 2-4 seconds to automatically adjust the image (for VGA mode only). • Adjust the Phase and Clock settings via OSD.
No sound or sound is low	<ul style="list-style-type: none"> • Ensure that the HDMI cable is properly connected to the monitor and the computer. • Adjust the volume settings of both your monitor and HDMI device. • Ensure that the computer sound card driver is properly installed and activated.

3.4 Supported operating modes

Resolution Frequency	Horizontal Frequency (KHz)	Vertical Frequency (Hz)	Pixel (MHz)
640x480	31.47(N)	59.94(N)	25.18
640x480	35.00(N)	66.66(N)	30.24
640x480	37.87(N)	72.82(N)	31.5
640x480	37.5(N)	75.00(N)	31.5
720x400	31.47(N)	70.08(P)	28.32
800x600	35.16(P)	56.25(P)	36
800x600	37.88(P)	60.32(P)	40
800x600	48.08(P)	72.12(P)	50
800x600	46.86(P)	75.00(P)	49.5
832X624	49.72(P/N)	74.55(P/N)	57.28
1024x768	48.36(N)	60.00(N)	65
1024x768	56.476(N)	70.069(N)	75
1024x768	60.02(N)	75.00(N)	78.75
1152x864	67.5(P/N)	75.00(P/N)	108
1280x960	60.00(P)	60.00(N)	108
1280x1024	63.98(P)	60.02(P)	108
1280x1024	79.98(P)	75.02(P)	135
1366x768	47.712(P)	59.79(P)	85.5
1440x900	55.94(N)	59.89(P)	106.5
1600x1200	75.00(P)	60.00(P)	162
1680x1050	65.29(N)	60.00(P)	146.25
1920x1080	67.5(P)	60.00(P)	148.5
1920x1200 (Reduced Blanking)	74.038(P)	59.95(N)	154
1920x1200	74.556(N)	59.885(P)	193.25

* Modes not listed in the table may not be supported. For optimal resolution, we recommend that you choose a mode listed in the table above.

* This monitor supports full HD (480p, 576p, 720p, 1080i/p) video content from game consoles, DVD players and other consumer video devices via HDMI or DisplayPort.

Free Manuals Download Website

<http://myh66.com>

<http://usermanuals.us>

<http://www.somanuals.com>

<http://www.4manuals.cc>

<http://www.manual-lib.com>

<http://www.404manual.com>

<http://www.luxmanual.com>

<http://aubethermostatmanual.com>

Golf course search by state

<http://golfingnear.com>

Email search by domain

<http://emailbydomain.com>

Auto manuals search

<http://auto.somanuals.com>

TV manuals search

<http://tv.somanuals.com>