



M3N-HT Deluxe Series

Motherboard

E3653

Second Edition V2

February 2008

Copyright © 2008 ASUSTeK COMPUTER INC. All Rights Reserved.

No part of this manual, including the products and software described in it, may be reproduced, transmitted, transcribed, stored in a retrieval system, or translated into any language in any form or by any means, except documentation kept by the purchaser for backup purposes, without the express written permission of ASUSTeK COMPUTER INC. ("ASUS").

Product warranty or service will not be extended if: (1) the product is repaired, modified or altered, unless such repair, modification or alteration is authorized in writing by ASUS; or (2) the serial number of the product is defaced or missing.

ASUS PROVIDES THIS MANUAL "AS IS" WITHOUT WARRANTY OF ANY KIND, EITHER EXPRESS OR IMPLIED, INCLUDING BUT NOT LIMITED TO THE IMPLIED WARRANTIES OR CONDITIONS OF MERCHANTABILITY OR FITNESS FOR A PARTICULAR PURPOSE. IN NO EVENT SHALL ASUS, ITS DIRECTORS, OFFICERS, EMPLOYEES OR AGENTS BE LIABLE FOR ANY INDIRECT, SPECIAL, INCIDENTAL, OR CONSEQUENTIAL DAMAGES (INCLUDING DAMAGES FOR LOSS OF PROFITS, LOSS OF BUSINESS, LOSS OF USE OR DATA, INTERRUPTION OF BUSINESS AND THE LIKE), EVEN IF ASUS HAS BEEN ADVISED OF THE POSSIBILITY OF SUCH DAMAGES ARISING FROM ANY DEFECT OR ERROR IN THIS MANUAL OR PRODUCT.

SPECIFICATIONS AND INFORMATION CONTAINED IN THIS MANUAL ARE FURNISHED FOR INFORMATIONAL USE ONLY, AND ARE SUBJECT TO CHANGE AT ANY TIME WITHOUT NOTICE, AND SHOULD NOT BE CONSTRUED AS A COMMITMENT BY ASUS. ASUS ASSUMES NO RESPONSIBILITY OR LIABILITY FOR ANY ERRORS OR INACCURACIES THAT MAY APPEAR IN THIS MANUAL, INCLUDING THE PRODUCTS AND SOFTWARE DESCRIBED IN IT.

Products and corporate names appearing in this manual may or may not be registered trademarks or copyrights of their respective companies, and are used only for identification or explanation and to the owners' benefit, without intent to infringe.

Contents

Contents	iii
Notices	vii
Safety information	viii
About this guide	ix
M3N-HT Deluxe Series specifications summary	xi

Chapter 1: Product introduction

1.1	Welcome!	1-1
1.2	Package contents	1-1
1.3	Special features	1-2
1.3.1	Product highlights	1-2
1.3.2	ASUS AI Lifestyle unique features	1-5
1.3.3	ASUS intelligent performance and overclocking features	1-8

Chapter 2: Hardware information

2.1	Before you proceed	2-1
2.2	Motherboard overview	2-2
2.2.1	Placement direction	2-2
2.2.2	Screw holes	2-2
2.2.3	Motherboard layout	2-3
2.2.4	Layout contents	2-4
2.3	Central Processing Unit (CPU)	2-6
2.3.1	Installing the CPU	2-6
2.3.2	Installing the heatsink and fan	2-8
2.3.3	Installing the optional fans	2-11
2.4	System memory	2-12
2.4.1	Overview	2-12
2.4.2	Memory configurations	2-13
2.4.3	Installing a DIMM	2-14
2.4.4	Removing a DIMM	2-14
2.4.5	Installing ASUS Cool Mempipe (Mempipe Edition only)	2-18
2.5	Expansion slots	2-20
2.5.1	Installing an expansion card	2-20
2.5.2	Configuring an expansion card	2-20
2.5.3	Interrupt assignments	2-21
2.5.4	PCI slots	2-22

Contents

- 2.5.5 PCI Express x1 slot..... 2-22
- 2.5.6 Three PCI Express x16 slots 2-22
- 2.6 Jumper 2-24**
- 2.7 Connectors 2-25**
 - 2.7.1 Rear panel connectors..... 2-25
 - 2.7.2 Internal connectors 2-28

- Chapter 3: Powering up**
- 3.1 Starting up for the first time..... 3-1**
- 3.2 Turning off the computer..... 3-2**
 - 3.2.1 Using the OS shut down function..... 3-2
 - 3.2.2 Using the dual function power switch..... 3-2

- Chapter 4: BIOS setup**
- 4.1 Managing and updating your BIOS 4-1**
 - 4.1.1 ASUS Update utility 4-1
 - 4.1.2 Creating a bootable floppy disk..... 4-4
 - 4.1.3 ASUS EZ Flash 2 utility..... 4-5
 - 4.1.4 Updating the BIOS 4-6
 - 4.1.5 Saving the current BIOS file..... 4-8
- 4.2 BIOS setup program 4-9**
 - 4.2.1 BIOS menu screen..... 4-10
 - 4.2.2 Menu bar..... 4-10
 - 4.2.3 Legend bar..... 4-11
 - 4.2.4 Menu items 4-11
 - 4.2.5 Sub-menu items..... 4-11
 - 4.2.6 Configuration fields 4-11
 - 4.2.7 Pop-up window 4-12
 - 4.2.8 General help 4-12
- 4.3 Main menu 4-13**
 - 4.3.1 System Time [xx:xx:xx] 4-13
 - 4.3.2 System Date [Day xx/xx/xxxx]..... 4-13
 - 4.3.3 Language [English] 4-13
 - 4.3.4 Legacy Diskette A [1.44M, 3.5 in.]..... 4-13
 - 4.3.5 Primary IDE Master/Slave..... 4-14
 - 4.3.6 SATA1/2/3/4 4-16

4.3.7	HDD SMART Monitoring [Disabled]	4-17
4.3.8	Installed Memory [xxx MB]	4-17
4.3.9	Usable Memory [XXX MB]	4-17
4.4	Advanced menu	4-18
4.4.1	JumperFree Configuration	4-18
4.4.2	AI NET2	4-20
4.4.3	CPU Configuration	4-20
4.4.4	Chipset	4-24
4.4.5	PCIPnP	4-26
4.4.6	Onboard Device Configuration	4-27
4.4.7	USB Configuration	4-29
4.5	Power menu	4-30
4.5.1	ACPI Suspend Type [S1&S3]	4-30
4.5.2	APM Configuration	4-30
4.5.3	Hardware Monitor	4-32
4.6	Boot menu	4-34
4.6.1	Boot Device Priority	4-34
4.6.2	Removable Drives	4-34
4.6.3	Hard Disk Drives	4-35
4.6.4	CDROM Drives	4-35
4.6.5	Boot Settings Configuration	4-36
4.6.6	Security	4-37
4.7	Tools menu	4-39
4.7.1	ASUS O.C. Profile	4-39
4.7.2	ASUS EZ Flash 2	4-41
4.7.3	ASUS Express Gate	4-42
4.8	Exit menu	4-43

Chapter 5: Software support

5.1	Installing an operating system	5-1
5.2	Support DVD information	5-1
5.2.1	Running the support DVD	5-1
5.2.2	Drivers menu	5-2
5.2.3	Utilities menu	5-3
5.2.4	Make Disk menu	5-5
5.2.5	Manual menu	5-6

5.2.6	ASUS Contact information	5-6
5.2.7	Other information	5-7
5.3	Software information	5-9
5.3.1	ASUS MyLogo2™	5-9
5.3.2	Cool 'n' Quiet!™ Technology	5-11
5.3.3	AI Audio 2 (SoundMAX® High Definition Audio utility) ...	5-13
5.3.4	ASUS PC Probe II.....	5-22
5.3.5	ASUS AI Suite.....	5-28
5.3.6	ASUS AI Gear 2.....	5-30
5.3.7	ASUS AI Nap	5-31
5.3.9	ASUS Q-Fan 2.....	5-32
5.3.10	ASUS AI Booster 2.....	5-33
5.3.12	ASUS Express Gate	5-34
5.4	RAID configurations	5-41
5.4.1	RAID definitions	5-41
5.4.2	NVIDIA® RAID configurations.....	5-42
5.5	Creating a RAID driver disk.....	5-49
5.5.1	Creating a RAID driver disk without entering the OS....	5-49
5.5.2	Creating a RAID/SATA driver disk in Windows®	5-49
 Chapter 6: NVIDIA® SLI™ technology support		
6.1	Overview	6-1
	Requirements.....	6-1
6.2	Graphics card setup	6-2
6.2.1	Installing three SLI-ready graphics cards.....	6-2
6.2.2	Installing two SLI-ready graphics cards	6-5
6.2.3	Installing the device drivers.....	6-6
6.2.4	Enabling the NVIDIA® SLI™ technology in Windows®	6-6

Notices

Federal Communications Commission Statement

This device complies with Part 15 of the FCC Rules. Operation is subject to the following two conditions:

- This device may not cause harmful interference, and
- This device must accept any interference received including interference that may cause undesired operation.

This equipment has been tested and found to comply with the limits for a Class B digital device, pursuant to Part 15 of the FCC Rules. These limits are designed to provide reasonable protection against harmful interference in a residential installation. This equipment generates, uses and can radiate radio frequency energy and, if not installed and used in accordance with manufacturer's instructions, may cause harmful interference to radio communications. However, there is no guarantee that interference will not occur in a particular installation. If this equipment does cause harmful interference to radio or television reception, which can be determined by turning the equipment off and on, the user is encouraged to try to correct the interference by one or more of the following measures:

- Reorient or relocate the receiving antenna.
- Increase the separation between the equipment and receiver.
- Connect the equipment to an outlet on a circuit different from that to which the receiver is connected.
- Consult the dealer or an experienced radio/TV technician for help.



The use of shielded cables for connection of the monitor to the graphics card is required to assure compliance with FCC regulations. Changes or modifications to this unit not expressly approved by the party responsible for compliance could void the user's authority to operate this equipment.

Canadian Department of Communications Statement

This digital apparatus does not exceed the Class B limits for radio noise emissions from digital apparatus set out in the Radio Interference Regulations of the Canadian Department of Communications.

This class B digital apparatus complies with Canadian ICES-003.

Safety information

Electrical safety

- To prevent electrical shock hazard, disconnect the power cable from the electrical outlet before relocating the system.
- When adding or removing devices to or from the system, ensure that the power cables for the devices are unplugged before the signal cables are connected. If possible, disconnect all power cables from the existing system before you add a device.
- Before connecting or removing signal cables from the motherboard, ensure that all power cables are unplugged.
- Seek professional assistance before using an adapter or extension cord. These devices could interrupt the grounding circuit.
- Make sure that your power supply is set to the correct voltage in your area. If you are not sure about the voltage of the electrical outlet you are using, contact your local power company.
- If the power supply is broken, do not try to fix it by yourself. Contact a qualified service technician or your retailer.

Operation safety

- Before installing the motherboard and adding devices on it, carefully read all the manuals that came with the package.
- Before using the product, make sure all cables are correctly connected and the power cables are not damaged. If you detect any damage, contact your dealer immediately.
- To avoid short circuits, keep paper clips, screws, and staples away from connectors, slots, sockets and circuitry.
- Avoid dust, humidity, and temperature extremes. Do not place the product in any area where it may become wet.
- Place the product on a stable surface.
- If you encounter technical problems with the product, contact a qualified service technician or your retailer.



This symbol of the crossed out wheeled bin indicates that the product (electrical, electronic equipment, and mercury-containing button cell battery) should not be placed in municipal waste. Check local regulations for disposal of electronic products.

About this guide

This user guide contains the information you need when installing and configuring the motherboard.

How this guide is organized

This guide contains the following parts:

- **Chapter 1: Product introduction**
This chapter describes the features of the motherboard and the new technology it supports.
- **Chapter 2: Hardware information**
This chapter lists the hardware setup procedures that you have to perform when installing system components. It includes description of the switches, jumpers, and connectors on the motherboard.
- **Chapter 3: Powering up**
This chapter describes the power up sequence and ways of shutting down the system.
- **Chapter 4: BIOS setup**
This chapter tells how to change system settings through the BIOS Setup menu. Detailed descriptions of the BIOS parameters are also provided.
- **Chapter 5: Software support**
This chapter describes the contents of the support DVD that comes with the motherboard package and the software.
- **Chapter 6: NVIDIA® SLI™ support**
This chapter describes the NVIDIA SLI™ feature and shows the graphics card installation procedures.

Where to find more information

Refer to the following sources for additional information and for product and software updates.

1. ASUS websites

The ASUS website provides updated information on ASUS hardware and software products. Refer to the ASUS contact information.

2. Optional documentation

Your product package may include optional documentation, such as warranty flyers, that may have been added by your dealer. These documents are not part of the standard package.

Conventions used in this guide

To make sure that you perform certain tasks properly, take note of the following symbols used throughout this manual.



DANGER/WARNING: Information to prevent injury to yourself when trying to complete a task.



CAUTION: Information to prevent damage to the components when trying to complete a task.



IMPORTANT: Instructions that you **MUST** follow to complete a task.



NOTE: Tips and additional information to help you complete a task.

Typography

Bold text

Indicates a menu or an item to select.

Italics

Used to emphasize a word or a phrase.

<Key>

Keys enclosed in the less-than and greater-than sign means that you must press the enclosed key.

Example: <Enter> means that you must press the Enter or Return key.

<Key1+Key2+Key3>

If you must press two or more keys simultaneously, the key names are linked with a plus sign (+).

Example: <Ctrl+Alt+D>

Command

Means that you must type the command exactly as shown, then supply the required item or value enclosed in brackets.

Example: At the DOS prompt, type the command line:

afudos /im3NHTDLX.BIN

M3N-HT Deluxe Series

specifications summary

CPU	<p>AMD® Socket AM2+ Phenom™ FX / Phenom / Athlon™ / Sempron™ processor</p> <p>AMD® Socket AM2 Athlon 64 X2 / Athlon 64 FX / Athlon 64 / Sempron processor</p> <p>AMD® Cool'n'Quiet™ Technology</p>
Chipset	NVIDIA® nForce 780a SLI
System bus	<p>Up to 5200 MT/s; HyperTransport™ 3.0 interface for AM2+ CPU</p> <p>2000 / 1600 MT/s for AM2 CPU</p>
Memory	<p>Dual-channel memory architecture</p> <ul style="list-style-type: none"> - 4 x 240-pin DIMM sockets support unbuffered ECC/non-ECC DDR2 1066*/800/667/533 MHz memory modules - Supports up to 8 GB system memory <p>*DDR2 1066 is supported by AM2+ CPUs only. Refer to www.asus.com for the supported CPU models and the Memory QVL (Qualified Vendors Lists).</p>
VGA	<p>Integrated NVIDIA® GPU</p> <p>Hybrid SLI Support (supports Windows® Vista only)</p> <p>Maximum shared memory of 512MB</p> <p>Supports HDMI™ Technology with max. resolution up to 1920 x 1200</p> <p>Supports DVI with max. resolution up to 1920 x 1440 @60Hz</p> <p>Supports D-Sub with max. resolution up to 1920 x 1440 @75Hz</p> <p>HDMI/DVI/RGB support</p> <p>Supports Microsoft® DirectX® 10, OpenGL® 2.0, Pixel Shader 4.0</p> <p>Support PCIe 2.0/1.0 architecture</p>
Expansion slots	<p>3 x PCIe x16 support NVIDIA® 3-way SLI™ Tech @ dual x16 mode or triple x8</p> <p>1 x PCIe x1</p> <p>2 x PCI 2.2</p>
Storage	<p>Chipset:</p> <ul style="list-style-type: none"> - 6 x SATA 3 Gb/s connectors (Use SATA 1-4 connectors for IDE mode) - NVIDIA® MediaShield RAID supports RAID 0, RAID1, RAID 0+1, RAID 5 and JBOD - 1 x Ultra DMA 133/100/66/33 <p>Marvell® 6111 SATA controller</p> <ul style="list-style-type: none"> - 1 x External SATA 3Gb/s port (SATA-On-The-Go)

(continued on the next page)

M3N-HT Deluxe Series

specifications summary

LAN	NVIDIA Gigabit MAC Atheros F1 Gigabit PHY featuring AI NET2
IEEE 1394	LSI® FW322 controller supports 2 x IEEE 1394a connectors (at mid-board)
USB	10 x USB 2.0 ports (6 at mid-board; 4 on the rear panel)
High Definition audio	ADI® AD1988B BH 8-channel High Definition audio CODEC <ul style="list-style-type: none"> - Supports Jack-Detection and Multi-Streaming - ASUS AI Audio 2 - Coaxial/Optical S/PDIF Out ports at back I/O
ASUS AI Lifestyle unique features	<p>ASUS Express Gate:</p> <ul style="list-style-type: none"> - Web browser, *file downloading and uploading - Further free features upgradable on ASUS websites - Onboard flash with Express Gate installed <p>*File downloading and uploading progresses through USB devices only.</p> <p>ASUS Quiet Thermal Solution:</p> <ul style="list-style-type: none"> - ASUS AI Cool Mempipe (Mempipe edition only) - ASUS AI Gear 2 - ASUS 8+2 Phase Power Design - ASUS AI Nap - ASUS Fanless Design: Heat-pipe solution & Stack Cool 2 - ASUS Q-Fan 2 - ASUS Optional Fan for Water-cooling or Passive-cooling only <p>ASUS Crystal Sound:</p> <ul style="list-style-type: none"> - ASUS Noise Filter - ASUS AI Audio 2 <p>ASUS EZ DIY:</p> <ul style="list-style-type: none"> - ASUS Q-Shield - ASUS Q-Connector - ASUS O.C. Profile - ASUS EZ Flash 2

(continued on the next page)

M3N-HT Deluxe Series specifications summary

<p>ASUS exclusive overclocking features</p>	<p>Intelligent overclocking tools:</p> <ul style="list-style-type: none"> - AI Overclocking (Intelligent CPU frequency tuner) - ASUS AI Booster 2 utility <p>Precision Tweaker 2:</p> <ul style="list-style-type: none"> - vCore: Adjustable CPU voltage at 0.0125V increment - vDIMM: 35-step DRAM voltage control - vChipset: 16-step Chipset voltage control <p>SFS (Stepless Frequency Selection):</p> <ul style="list-style-type: none"> - FSB tuning from 200 MHz up to 600 MHz at 1 MHz increment - Memory tuning from 533 MHz up to 1066 MHz - PCI Express frequency tuning from 100 MHz to 200 MHz at 1 MHz increment <p>Overclocking protection:</p> <ul style="list-style-type: none"> - ASUS C.P.R. (CPU Parameter Recall)
<p>Other features</p>	<p>Uses 100% All High-quality Conductive Polymer Capacitors! ASUS MyLogo 2™ Multi-language BIOS</p>
<p>Rear panel I/O ports</p>	<p>1 x PS/2 keyboard port (purple) 1 x S/PDIF Out (Coaxial + Optical) 1 x HDMI 1 x D-Sub 1 x External SATA 1 x LAN (RJ-45) 4 x USB 2.0/1.1 8-channel audio I/O</p>
<p>Internal I/O connectors</p>	<p>3 x USB connectors support additional 6 USB ports 1 x Floppy disk drive connector 1 x COM connector 1 x IDE connector 6 x SATA connectors (Use SATA 1–4 for IDE mode) 1 x CPU Fan connector 2 x Chassis Fan connector 1 x Power Fan connector 2 x IEEE1394a connector Front panel audio connector 1 x S/PDIF Out Header Chassis Intrusion connector CD audio in 24-pin ATX Power connector 1 x 8-pin ATX 12V Power connector System Panel (Q-Connector)</p>

(continued on the next page)

M3N-HT Deluxe Series specifications summary

BIOS features	8 Mb Flash ROM, Award BIOS, PnP, DMI 2.0, WfM2.0, SM BIOS 2.5, ACPI 2.0, ASUS EZ Flash 2
Manageability	WfM 2.0, DMI 2.0, WOL by PME, WOR by PME, PXE
Support CD contents	Drivers ASUS Express Gate ASUS AI Suite ASUS PC Probe II ASUS Update Anti-virus Utility (OEM version)
Form factor	ATX form factor: 12 in x 9.6 in (30.5 cm x 24.4 cm)

*Specifications are subject to change without notice.

This chapter describes the motherboard features and the new technologies it supports.

1 Product introduction

Chapter summary

1

1.1	Welcome!	1-1
1.2	Package contents.....	1-1
1.3	Special features.....	1-2

1.1 Welcome!

Thank you for buying an ASUS® M3N-HT Deluxe Series motherboard!

The motherboard delivers a host of new features and latest technologies, making it another standout in the long line of ASUS quality motherboards!

Before you start installing the motherboard, and hardware devices on it, check the items in your package with the list below.

1.2 Package contents

Check your motherboard package for the following items.

Motherboard	ASUS M3N-HT Deluxe Series
I/O modules	1 x Multi-functional module (1-port IEEE 1394a module and 2-port USB 2.0 module)
Cables	1 x Serial ATA power cable for 2 devices 6 x Serial ATA signal cables 1 x Ultra DMA 133/100/66 cable 1 x Floppy disk drive cable
Accessories	ASUS Cool Mempipe (Mempipe edition only) ASUS Q-Shield (I/O Shield) 1 x HDMI-to-DVI converter 1 x ASUS Q-Connector Kit (USB, 1394, system panel; Retail version only) 1 x ASUS 3-way SLI bridge connector 1 x ASUS SLI bridge Optional fan for Water-Cooling or Passive-cooling only
Application DVD	ASUS motherboard support DVD
Documentation	User guide



If any of the above items is damaged or missing, contact your retailer.

1.3 Special features

1.3.1 Product highlights

Green ASUS



This motherboard and its packaging comply with the European Union's Restriction on the use of Hazardous Substances (RoHS). This is in line with the ASUS vision of creating environment-friendly and recyclable products/packaging to safeguard consumers' health while minimizing the impact on the environment.

AMD® Socket AM2+ Phenom™ FX / Phenom / Athlon™ / Sempron™ CPU support



This motherboard supports AMD® Socket AM2+ multi-core processors with unique L3 cache and delivers better overclocking capabilities with less power consumption. It features dual-channel DDR2 1066 memory support and accelerates data transfer rate up to 5200MT/s via HyperTransport™ 3.0 based system bus. See page 2-6 for details.

HyperTransport™ 3.0 support



HyperTransport™ 3.0 technology provides 2.6 times more bandwidth than HyperTransport™ 1.0, radically improving system efficiency to create a smoother, faster computing environment.

AMD® Socket AM2 Athlon™ 64 X2 / Athlon™ 64 FX / Athlon™ 64 / Sempron™ CPU support



This motherboard supports AMD® Socket AM2 single-core Athlon™ 64 / Sempron™ and dual-core Athlon™ 64 X2 / Athlon™ 64 FX processors with 2MB / 1MB / 512KB L2 cache based on 64-bit architecture. It features 2000 / 1600 MT/s HyperTransport™-based system bus, dual-channel un-buffered DDR2 800 memory support, and AMD® Cool 'n' Quiet™ Technology. See page 2-6 for details.

NVIDIA® nForce® 780a SLI chipset

The NVIDIA® nForce 780a SLI chipset supports the NVIDIA® Scalable Link Interface (SLI™) technology that allows three graphics processing units (GPUs) in a single system. It's designed for enthusiast, extreme overclocking capability, ultimate gaming performance with SLI technology support. It's definitely one of the fastest platform in the world. The NVIDIA® nForce 780a SLI chipset also supports six (6) Serial ATA 3 Gb/s devices, PCI Express™ x16 slots with NVIDIA® SLI™ support at dual x16 mode or at tripple x8 mode, and up to 10 USB 2.0 ports.

Native DDR2 1066 support

This motherboard natively supports DDR2 1066. It provides faster data transfer rate and more bandwidth to increase memory computing efficiency, enhancing system performance in 3D graphics and other memory demanding applications. See page 2-12 for details.



DDR2 1066 is supported by some of the AM2+ CPUs only. Refer to www.asus.com for the supported CPU models.

NVIDIA® 3-Way SLI™ (Scalable Link Interface)

NVIDIA 3-Way SLI™ (Scalable Link Interface) takes advantage of the increased bandwidth of the PCI Express 2.0 bus architecture and features intelligent hardware and software that allows three graphics cards to efficiently work together to deliver earth-shattering, scalable performance. For some applications nearly triple performance!

PCIe 2.0 support

This motherboard supports the latest PCIe 2.0 devices for double speed and bandwidth which enhances system performance. See page 2-22 for details.

Hybrid SLI™

Hybrid SLI™ technology is a unique hybrid multi-GPU technology built upon NVIDIA. Hybrid SLI technology today includes two primary features: GeForce® Boost and HybridPower™. GeForce® Boost turbo-charges performance of NVIDIA discrete graphics cards when combined with this series motherboard GPUs. HybridPower™ unleashes graphics performance when needed and enables low-power operation when performance is not needed. You can switch from the discrete GeForce® GPU(s) to the motherboard GPU for a quiet, low power PC experience.



GeForce® Boost and HybridPower™ are independent on selected GeForce® GPUs. Refer to www.nvidia.com/hybridсли for more information.

Serial ATA 3 Gb/s technology and SATA-On-The-Go

This motherboard supports the next-generation hard disk drives based on the Serial ATA (SATA) 3Gb/s storage specifications, delivering enhanced scalability and doubling the bus bandwidth for high-speed data retrieval and save. The external SATA port located at the back I/O provides smart setup and hot-plug functions, enabling easy backup of media files to external devices. See pages 2-26 and 2-30 for details.

The NVIDIA® MediaShield™ RAID controller integrated in the NVIDIA® nForce® 780a SLI™ chipset allows RAID 0, RAID 1, RAID 0+1, RAID 5, and JBOD configurations for six SATA 3 Gb/s connectors. See page 2-30 for details.

HDMI Interface

HDMI (High-Definition Multimedia Interface) is a set of digital video standards that delivers multi-channel audio and uncompressed digital video through a single cable for full HD 1080p visuals. Supporting HDCP copy protection such as HD DVD and Blu-ray Discs, HDMI provides you with the highest-quality home theater experience.

IEEE 1394a support

The IEEE 1394a interface provides high speed digital interface for audio/video appliances such as digital television, digital video camcorders, storage peripherals, and other PC portable devices. See pages 2-25 and 2-31 for details.

S/PDIF digital sound ready

This motherboard provides convenient connectivity to external home theater audio systems via coaxial and optical S/PDIF (SONY-PHILIPS Digital Interface) Out jacks. It allows digital audio transferring without converting it to analog format, and therefore well preserves signal quality. See page 2-36 for details.

High Definition Audio

Enjoy high-end sound quality on your PC! The onboard 8-channel HD audio (High Definition Audio, previously codenamed Azalia) CODEC enables high-quality 192KHz/24-bit audio output that simultaneously sends different audio streams to different destinations. You can now talk to your partners on the headphones while playing multi-channel network games. See pages 2-25 and 2-26 for details.

Gigabit LAN solution

The NVIDIA® native Gigabit LAN controller delivers transfer speeds up to ten times faster than conventional 10/100/1000 Ethernet connections. Gigabit LAN is the networking standard for the early future and is ideal for handling large amounts of data such as video, audio, and voice. See page 2-25 for details.

1.3.2 ASUS AI Lifestyle unique features



ASUS Quiet Thermal Solution

ASUS Quiet Thermal solution makes system more stable and enhances the overclocking capability.

ASUS Cool Mempipe (Mempipe Edition only)



ASUS Cool Mempipe supports unparalleled memory overclocking via innovative thermal solutions. By lowering the memory and system temperatures, the Cool Mempipe contributes to a stable computing environment. See pages 2-18 and 2-19 for details.



ASUS Cool Mempipe supports the thermal dissipation of memory modules on DIMM_A1 and DIMM_B1 sockets only.

8+2 Phase Power Design



ASUS 8+2 Phase Power Design, with independent power to vital components, ultimately enhances memory performance and ensures quick response and stability of CPU under heavy loading or overclocking modes.

Fanless Design–Stack Cool 2



ASUS Stack Cool 2 is a fan-less and zero-noise cooling solution that lowers the temperature of critical heat generating components. The motherboard uses a special design on the printed circuit board (PCB) to dissipate heat these critical components generate.

AI Gear 2



AI Gear 2 allows you to choose from profiles to adjust CPU frequency and vCore voltage, minimizing system noise and saving CPU power consumption at most. You can real-time change the mode under operating system to suit your needs.

AI Nap



With AI Nap, the system can continue running at minimum power and noise when you are temporarily away. To wake the system and return to the OS environment, simply click the mouse or press a key.

Fanless Design–Heat-pipe



The Heat Pipe design effectively directs the heat generated by the chipsets to the heatsink near the back IO ports, where it can be carried away by existing airflow from CPU fan or bundled optional fan. The purpose of the innovative heat pipe design on this motherboard is that the groundbreaking fanless design does not have lifetime problems as a chipset fan does. Furthermore, it provides options for users to install side-flow fan or passive cooler. The Heat Pipe design is the most reliable fanless thermal solution to date.



DO NOT uninstall the heat-pipe by yourself. Doing so may bend the tubing and affect the heat dissipation performance.

Optional Fan (for Water-Cooling or Passive-Cooling only)



The optional fan is specifically designed to provide sufficient airflow over the CPU power modules and chipset area when water-cooling or passive-cooling is utilized, ensuring effective heat dissipation for the entire system. See page 2-11 for details.

Q-Fan 2



ASUS Q-Fan2 technology intelligently adjusts both CPU fan and chassis fan speeds according to system loading to ensure quiet, cool and efficient operation.

ASUS Crystal Sound

This feature can enhance speech-centric applications like Skype, online game, video conference and recording.

Noise Filter



This feature detects repetitive and stationary noises (non-voice signals) like computer fans, air conditioners, and other background noises then eliminates it in the incoming audio stream while recording.

AI Audio 2



AI Audio 2 creates a virtual center channel that expands the overall sound field without introducing a picket fencing effect. Preserving the dialogue or solo performances with downmixing from multi-channels allows you to experience true-to-life high quality audio. See page 5-13 for details.

ASUS EZ DIY

ASUS EZ DIY feature collection provides you easy ways to install computer components, update the BIOS or back up your favorite settings.

ASUS Express Gate



With only 5 seconds boot-up time, the ASUS Express Gate allows you to instantly surf the Internet without entering Windows or the Hard Disk. You can now enjoy Skype, IM, YouTube, webmail and internet file downloads and sharing whenever and wherever you want! See page 5-34 for details.



- Systems with onboard GPU may take longer to boot up.
- File downloading and uploading progresses through USB devices only
- Due to Skype limitation under Linux OS, file downloading and uploading are not supported under Skype.

ASUS Q-Shield



The specially designed ASUS Q-Shield does without the usual “fingers”—making it convenient and easy to install. With better electric conductivity, it ideally protects your motherboard against static electricity and shields it against Electronic Magnetic Interference (EMI).

ASUS Q-Connector



ASUS Q-Connector allows you to easily connect or disconnect the chassis front panel cables to the motherboard. This unique module eliminates the trouble of connecting the system panel cables one at a time and avoiding wrong cable connections. See page 2-38 for details.

ASUS O.C. Profile



The motherboard features the ASUS O.C. Profile that allows users to conveniently store or load multiple BIOS settings. The BIOS settings can be stored in the CMOS or a separate file, giving users freedom to share and distribute their favorite settings. See page 4-39 for details.

ASUS EZ Flash 2



ASUS EZ Flash 2 is a user-friendly BIOS update utility. Simply press the predefined hotkey to launch the utility and update the BIOS without entering the OS. Update your BIOS easily without preparing a bootable diskette or using an OS-based flash utility. See pages 4-5 and 4-41 for details.

ASUS MyLogo 2™

This feature allows you to convert your favorite photo into a 256-color boot logo for a more colorful and vivid image on your screen. See page 5-9 for details.

ASUS Multi-language BIOS

The multi-language BIOS allows you to select the language of your choice from the available options. The localized BIOS setup menu helps you configure your system easier and faster. See page 4-13 for details.

1.3.3 ASUS intelligent performance and overclocking features

HDMI/DVI/RGB support

With the bundled HDMI to DVI conversion adapter, this motherboard can support both DVI and HDMI output. DVI (Digital Visual Interface) provides high quality visuals for digital display devices like LCD monitors. The interface of this motherboard supports digital HDMI/DVI and analog D-Sub standards. See page 2-27 for details.

Precision Tweaker 2

Precision Tweaker 2 allows the user to adjust the northbridge voltage, HT Bus, and DRAM voltage in 0.02V steps to achieve the most precise settings for th ultimate customized overclocking configuration.

AI Booster 2

Overclocking has never been so fun with a user-friendly utility under Window that provides accurate settings for the CPU, chipset and memory. Now it's even easier to achieve astounding overclocking results without any hassles!

C.P.R. (CPU Parameter Recall)

The C.P.R. feature of the motherboard BIOS allows automatic re-setting to the BIOS default settings in case the system hangs due to overclocking. When the system hangs due to overclocking, C.P.R. eliminates the need to open the system chassis and clear the RTC data. Simply shut down and reboot the system, and the BIOS automatically restores the CPU default setting for each parameter.

This chapter lists the hardware setup procedures that you have to perform when installing system components. It includes description of the jumpers and connectors on the motherboard.

Hardware information

A large, light gray, stylized number '2' is positioned behind the word 'Hardware' in the title.

2.1	Before you proceed	2-1
2.2	Motherboard overview.....	2-2
2.3	Central Processing Unit (CPU)	2-6
2.4	System memory	2-12
2.5	Expansion slots.....	2-20
2.6	Jumper	2-24
2.7	Connectors	2-25

2.1 Before you proceed

Take note of the following precautions before you install motherboard components or change any motherboard settings.



- Unplug the power cord from the wall socket before touching any component.
- Use a grounded wrist strap or touch a safely grounded object or to a metal object, such as the power supply case, before handling components to avoid damaging them due to static electricity.
- Hold components by the edges to avoid touching the ICs on them.
- Whenever you uninstall any component, place it on a grounded antistatic pad or in the bag that came with the component.
- Before you install or remove any component, ensure that the ATX power supply is switched off or the power cord is detached from the power supply. Failure to do so may cause severe damage to the motherboard, peripherals, and/or components.

Onboard LED

The motherboard comes with a standby power LED. The green LED lights up to indicate that the system is ON, in sleep mode, or in soft-off mode. This is a reminder that you should shut down the system and unplug the power cable before removing or plugging in any motherboard component. The illustration below shows the location of the onboard LED.

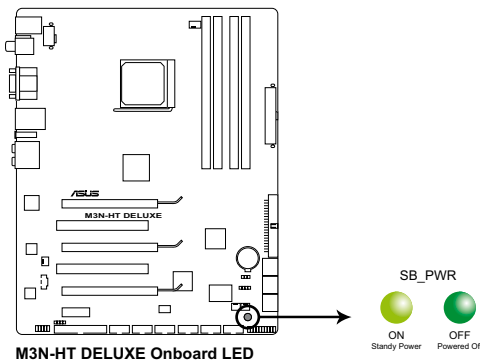

2.2 Motherboard overview

Before you install the motherboard, study the configuration of your chassis to ensure that the motherboard fits into it.



Make sure to unplug the power cord before installing or removing the motherboard. Failure to do so can cause you physical injury and damage motherboard components.

2.2.1 Placement direction

When installing the motherboard, make sure that you place it into the chassis in the correct orientation. The edge with external ports goes to the rear part of the chassis as indicated in the image below.

2.2.2 Screw holes

Place nine (9) screws into the holes indicated by circles to secure the motherboard to the chassis.



Do not overtighten the screws! Doing so can damage the motherboard.

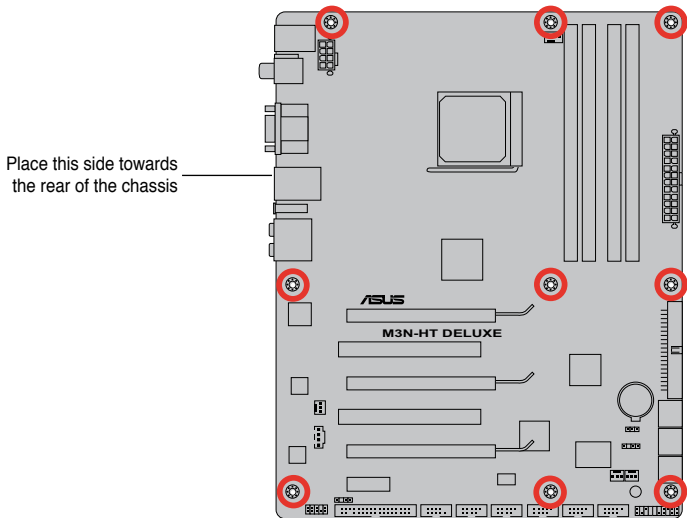

2.2.3 Motherboard layout

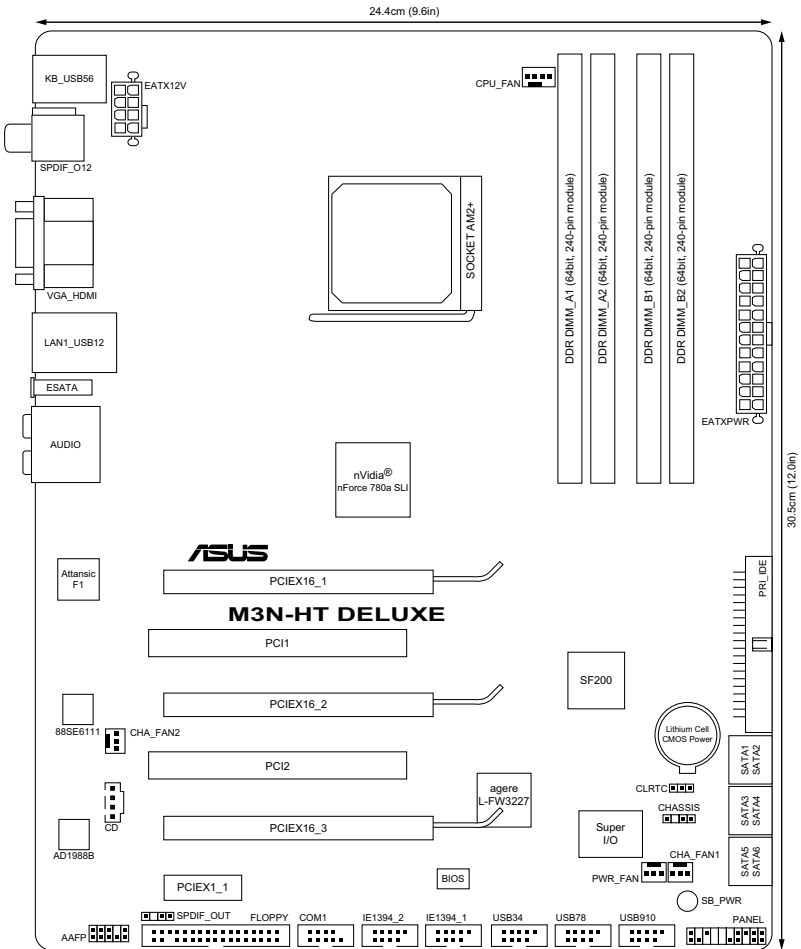

Refer to **2.7 Connectors** for more information about rear panel connectors and internal connectors.

2.2.4 Layout contents

Slots		Page
1.	DDR2 DIMM slots	2-12
2.	PCI slots	2-22
3.	PCI Express x1 slot	2-2
3.	PCI Express x16 slots	2-22

Jumper		Page
1.	Clear RTC RAM (3-pin CLRRTC)	2-24

Rear panel connectors		Page
1.	PS/2 keyboard port (purple)	2-25
2.	Coaxial S/PDIF Out port	2-25
3.	VGA port	2-25
4.	LAN (RJ-45) port.	2-25
5.	Center/Subwoofer port (orange)	2-25
6.	Rear Speaker Out port (black)	2-25
7.	Line In port (light blue)	2-25
8.	Line Out port (lime)	2-25
9.	Microphone port (pink)	2-25
10.	Side Speaker Out port (gray)	2-25
11.	External SATA port	2-26
12.	USB 2.0 ports 1 and 2	2-26
13.	HDMI port	2-26
14.	Optical S/PDIF Out port	2-27
15.	USB 2.0 ports 3 and 4	2-27

Internal connectors		Page
1.	Floppy disk drive connector (34-1 pin FLOPPY)	2-28
2.	IDE connector (40-1 pin PRI_IDE)	2-29
3.	NVIDIA® nForce 780a SLI Serial ATA connectors (7-pin SATA1-4 [red]; SATA5-6 [black])	2-30
4.	USB connectors (10-1 pin USB34; 10-1 pin USB78; 10-1 pin USB910)	2-31
5.	IEEE 1394a port connector (10-1 pin IE1394_1; 10-1 pin IE1394_2)	2-31
6.	CPU, chassis, and power fan connectors (4-pin CPU_FAN; 3-pin CHA_FAN1; 3-pin CHA_FAN2; 3-pin PWR_FAN)	2-32
7.	Chassis intrusion connector (4-1 pin CHASSIS)	2-33
8.	Optical drive audio connector (4-pin CD)	2-33
9.	ATX power connectors (24-pin EATXPWR; 8-pin ATX12V)	2-34
10.	Front panel audio connector (10-1 pin AAFP)	2-36
11.	Serial port connector (10-1 pin COM1)	2-37
12.	Digital audio connector (4-1 pin SPDIF_OUT)	2-37
13.	System panel connector (20-8-pin PANEL) <ul style="list-style-type: none"> • System power LED (2-pin PLED) • Hard disk drive activity LED (2-pin IDE_LED) • System warning speaker (4-pin SPEAKER) • ATX power button/soft-off button (2-pin PWRSW) • Reset button (2-pin RESET) 	2-38
	ASUS Q-Connector (system panel)	2-39

2.3 Central Processing Unit (CPU)

The motherboard comes with an AM2+/AM2 socket designed for AMD® Socket AM2+ Phenom™ FX / Phenom / Athlon™ / Sempron™ processor or for Socket AM2 Athlon 64 X2 / Athlon 64 FX / Athlon 64 / Sempron processor.



The AM2+/AM2 socket has a different pinout from the 940-pin socket designed for the AMD Opteron processor. Make sure you use a CPU designed for the AM2+/AM2 socket. The CPU fits in only one correct orientation. DO NOT force the CPU into the socket to prevent bending the connectors on the socket and damaging the CPU!

2.3.1 Installing the CPU

To install a CPU:

1. Locate the CPU socket on the motherboard.

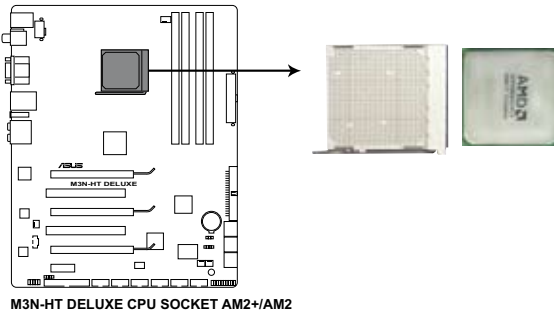

M3N-HT DELUXE CPU SOCKET AM2+/AM2

2. Unlock the socket by pressing the lever sideways, then lift it up to a 90° angle.

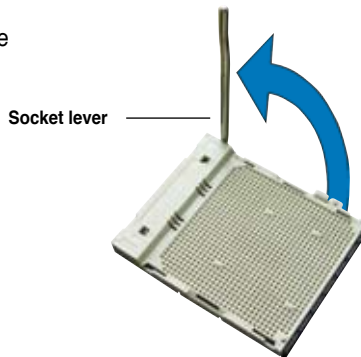

Make sure that the socket lever is lifted up to a 90° angle; otherwise, the CPU will not fit in completely.

3. Position the CPU above the socket such that the CPU corner with the gold triangle matches the socket corner with a small triangle.
4. Carefully insert the CPU into the socket until it fits in place.

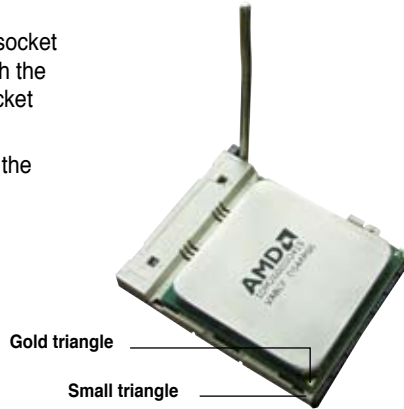

5. When the CPU is in place, push down the socket lever to secure the CPU. The lever clicks on the side tab to indicate that it is locked.
6. Install a CPU heatsink and fan following the instructions that came with the heatsink package.



2.3.2 Installing the heatsink and fan

The AMD® AM2+ Phenom™ FX / Phenom / Athlon™ / Sempron™ processor or AMD® AM2 Athlon 64 X2 / Athlon 64 FX / Athlon 64 / Sempron processor requires a specially designed heatsink and fan assembly to ensure optimum thermal condition and performance.



Make sure that you use only AMD-certified heatsink and fan assembly.

To install the CPU heatsink and fan:

1. Place the heatsink on top of the installed CPU, making sure that the heatsink fits properly on the retention module base.



- The retention module base is already installed on the motherboard upon purchase.
 - You do not have to remove the retention module base when installing the CPU or installing other motherboard components.
 - If you purchased a separate CPU heatsink and fan assembly, make sure that a Thermal Interface Material is properly applied to the CPU heatsink or CPU before you install the heatsink and fan assembly.
-

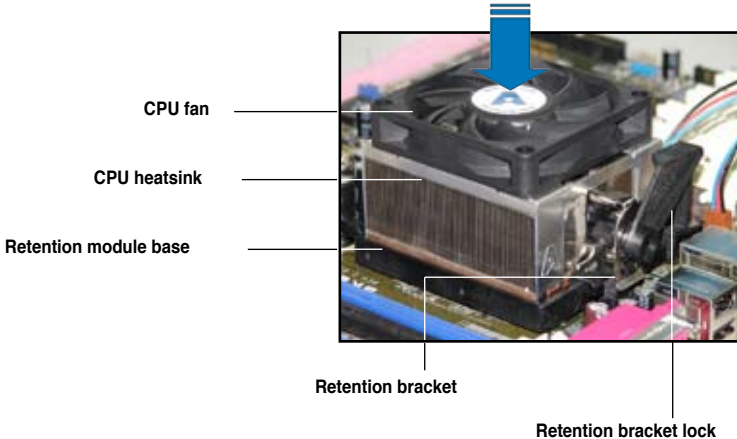

Your boxed CPU heatsink and fan assembly should come with installation instructions for the CPU, heatsink, and the retention mechanism. If the instructions in this section do not match the CPU documentation, follow the latter.

2. Attach one end of the retention bracket to the retention module base.

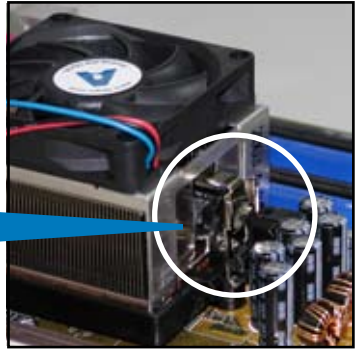

3. Align the other end of the retention bracket (near the retention bracket lock) to the retention module base. A clicking sound denotes that the retention bracket is in place.



Make sure that the fan and heatsink assembly perfectly fits the retention mechanism module base, otherwise you cannot snap the retention bracket in place.



4. Push down the retention bracket lock on the retention mechanism to secure the heatsink and fan to the module base.

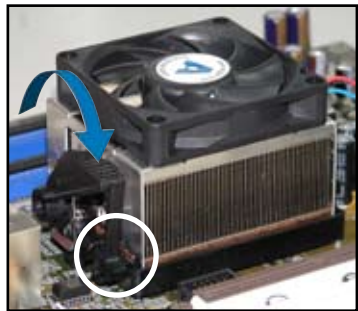

- When the fan and heatsink assembly is in place, connect the CPU fan cable to the connector on the motherboard labeled CPU_FAN.

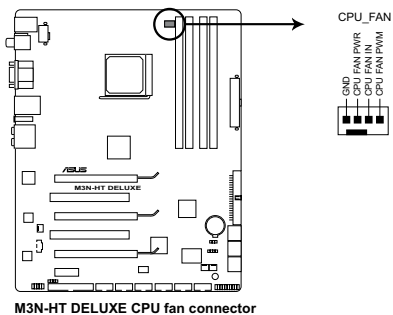

-
- Do not forget to connect the CPU fan connector! Hardware monitoring errors can occur if you fail to plug this connector.
 - This connector is backward compatible with old 3-pin CPU fan.
-

2.3.3 Installing the optional fans



Install the optional fan only if you are using a passive cooler or a water cooler. Installing the optional fan with an active CPU cooler will interfere with the airflow and destabilize the system.

1. Position the fan above the pipe and heatsink assembly.
2. Fit the fan to the grooved edge of the heatsink.

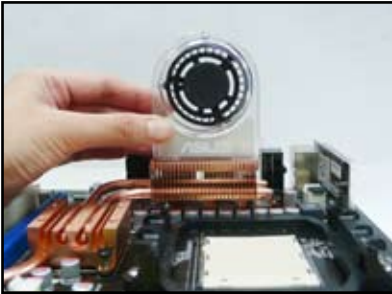

Make sure that the ASUS logo faces to the CPU socket.



3. Carefully push down the fan until it snugly fits the heatsink, then connect the fan cable.
4. The photo shows the fan installed on the motherboard.

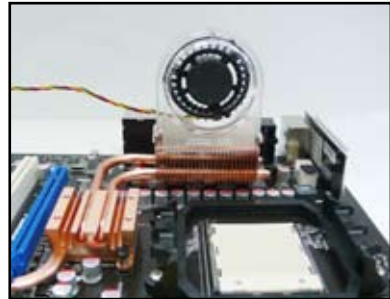
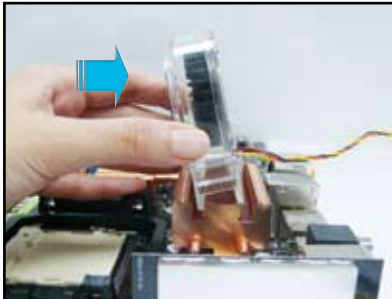

- Plug the optional fan cable to the CHA_FAN1/2 connector on the motherboard.
- Make sure the optional fan is installed correctly to prevent damage to the fan and motherboard components.

2.4 System memory

2.4.1 Overview

The motherboard comes with four Double Data Rate 2 (DDR2) Dual Inline Memory Modules (DIMM) sockets.

The figure illustrates the location of the DDR2 DIMM sockets:

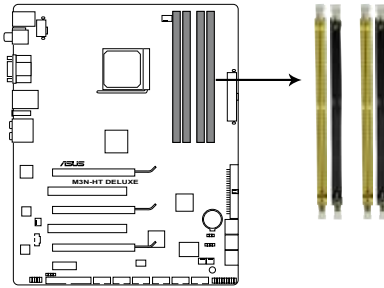

M3N-HT DELUXE 240-pin DDR2 DIMM sockets

Channel	Sockets
Channel A	DIMM_A1 and DIMM_A2
Channel B	DIMM_B1 and DIMM_B2

2.4.2 Memory configurations

You may install 256 MB, 512 MB, 1 GB, and 2 GB unbuffered ECC and non-ECC DDR2 DIMMs into the DIMM sockets.

Recommended Memory Configurations

Mode	Sockets			
	DIMM_A1 (yellow)	DIMM_A2 (black)	DIMM_B1 (yellow)	DIMM_B2 (black)
Single-Channel	–	–	Populated	–
	Populated	–	–	–
Dual-channel (1)	Populated	–	Populated	–
Dual-channel (2)	Populated	Populated	Populated	Populated



- You may install varying memory sizes in Channel A and Channel B. The system maps the total size of the lower-sized channel for the dual-channel configuration. Any excess memory from the higher-sized channel is then mapped for single-channel operation.
- Always install DIMMs with the same CAS latency. For optimum compatibility, it is recommended that you obtain memory modules from the same vendor.
- If you install four 1 GB memory modules, the system may only recognize less than 3GB because the address space is reserved for other critical functions. This limitation appears on Windows® XP/Vista 32-bit operation system which does not support Physical Address Extension (PAE).
- If you install Windows® XP/Vista 32-bit operation system, a total memory of less than 3GB is recommended.
- This motherboard does not support memory modules made up of 128 Mb chips.

2.4.3 Installing a DIMM



Unplug the power supply before adding or removing DIMMs or other system components. Failure to do so can cause severe damage to both the motherboard and the components.

To install a DIMM:

1. Unlock a DIMM socket by pressing the retaining clips outward.
2. Align a DIMM on the socket such that the notch on the DIMM matches the break on the socket.
3. Firmly insert the DIMM into the socket until the retaining clips snap back in place and the DIMM is properly seated.

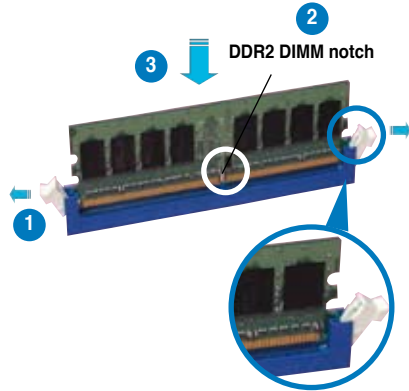

Unlocked retaining clip



- A DDR2 DIMM is keyed with a notch so that it fits in only one direction. Do not force a DIMM into a socket to avoid damaging the DIMM.
- The DDR2 DIMM sockets do not support DDR DIMMs. DO not install DDR DIMMs to the DDR2 DIMM sockets.

2.4.4 Removing a DIMM

To remove a DIMM:

1. Simultaneously press the retaining clips outward to unlock the DIMM.



Support the DIMM lightly with your fingers when pressing the retaining clips. The DIMM might get damaged when it flips out with extra force.

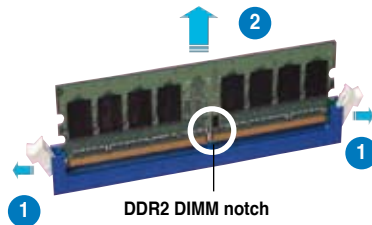

2. Remove the DIMM from the socket.

M3N-HT Deluxe Motherboard Qualified Vendors Lists (QVL) DDR2-800MHz capability

Size	Vendor	Chip No.	SS/DS	Part No.	DIMM support		
					A*	B*	C*
512MB	KINGSTON	K4T51083QC	SS	KVR800D2N5/512	•	•	•
1024MB	KINGSTON	Heat-Sink Package	DS	KHX6400D2LL/1G	•	•	•
1024MB	KINGSTON	Heat-Sink Package	SS	KHX6400D2LLK2/1GN	•	•	
1024MB	KINGSTON	V59C1512804QBF25	DS	KVR800D2N5/1G	•	•	•
1024MB	KINGSTON	Heat-Sink Package	SS	KHX6400D2ULK2/1G	•	•	•
2048MB	KINGSTON	Heat-Sink Package	DS	KHX6400D2ULK2/2G			•
512MB	Qimonda	HYB18T512800BF25F	SS	HYS64T64000HU-25F-B	•	•	•
1024MB	Qimonda	HYB18T512800BF25F	DS	HYS64T128020HU-25F-B	•	•	
1024MB	Hynix	HY5PS12821CFP-S5	DS	HYMP512U64CP8-S5	•	•	
512MB	MICRON	D9GKX	SS	MT8HTF6464AY-80ED4	•		
512MB	CORSAIR	Heat-Sink Package	SS	CM2X512A-6400	•		•
1024MB	CORSAIR	Heat-Sink Package	DS	CM2X1024-6400C4			•
1024MB	ELPIDA	E1108AB-8E-E(ECC)	SS	EBE10EE8ABFA-8E-E	•	•	•
2048MB	ELPIDA	E1108AB-8E-E(ECC)	DS	EBE21EE8ABFA-8E-E	•	•	
512MB	Crucial	Heat-Sink Package	SS	BL6464AA804.8FD			•
512MB	Crucial	Heat-Sink Package	SS	BL6464AA804.8FD3			•
1024MB	Crucial	Heat-Sink Package	DS	BL12864AL804.16FD3	•		
1024MB	Crucial	Heat-Sink Package	DS	BL12864AA804.16FD3		•	•
2048MB	Apacer	AM4B5808CQJS8E	DS	78.A1GA0.9K4	•		
1024MB	A-DATA	AD26908A8A-25EG	DS	M2OAD6G3I41701E58	•	•	•
512MB	Super Talent	Heat-Sink Package	SS	T800UA12C4			•
1024MB	Super Talent	Heat-Sink Package	DS	T800UB1GC4		•	
512MB	NANYA	NT5TU64M8BE-25C	SS	NT512T64U8B0BY-25C	•	•	•
1024MB	NANYA	NT5TU64M8BE-25C	DS	NT11GT64U8HB0BY-25C	•	•	•
1024MB	NANYA	NT5TU64M8CE-25D	DS	NT11GT64U8HCOBY-25D	•		
512MB	PSC	A3R12E3HEF641B9A05	SS	AL6E8E63B8E1K	•	•	•
1024MB	PSC	A3R12E3HEF641B9A05	DS	AL7E8E63B-8E1K	•	•	•
256MB	TwinMOS	E2508AB-GE-E	SS	8G-24IK2-EBT		•	
1024MB	Elixir	N2TU51280BE-25C	DS	M2Y1G64TU8HB0B-25C	•	•	•

SS - Single-sided / DS - Double-sided

DIMM support:

- **A***: Supports one module inserted in any slot as Single-channel memory configuration.
- **B***: Supports one pair of modules inserted into either the yellow slots or the black slots as one pair of Dual-channel memory configuration.
- **C***: Supports four modules inserted into both the yellow and black slots as two pairs of Dual-channel memory configuration.



Visit the ASUS website for the latest DDR2-800/667/533 MHz QVL.

M3N-HT Deluxe Motherboard Qualified Vendors Lists (QVL) DDR2-667MHz capability

Size	Vendor	Chip No.	SS/DS	Part No.	DIMM support		
					A*	B*	C*
512MB	KINGSTON	D6408TEBGL3U	SS	KVR667D2N5/512	•	•	•
256MB	KINGSTON	HYB18T256800AF3S	SS	KVR667D2N5/256	•	•	
256MB	KINGSTON	6SBI2D9DCG	SS	KVR667D2N5/256	•	•	
1024MB	KINGSTON	E5108AGBG-6E-E	DS	KVR667D2N5/1G	•	•	•
2048MB	KINGSTON	E1108AB-6E-E	DS	KVR667D2N5/2G	•	•	
512MB	Qimonda	HYB18T512800BF3S(ECC)	SS	HYS72T64000HU-3S-B	•	•	•
1024MB	Qimonda	HYB18T512800BF3S(ECC)	DS	HYS72T128020HU-3S-B	•	•	•
512MB	Qimonda	HYB18T512800BF3S	SS	HYS64T64000HU-3S-B	•	•	•
1024MB	Qimonda	HYB18T512800BF3S	DS	HYS64T128020HU-3S-B	•	•	
512MB	SAMSUNG	K4T51163QE-ZCE6	DS	M378T3354EZ3-CE6	•	•	•
256MB	SAMSUNG	K4T51083QE	SS	M378T6553EZS-CE6	•	•	
1024MB	SAMSUNG	K4T51083QE	DS	M378T2953EZ3-CE6	•	•	•
256MB	Hynix	HY5PS121621CFP-Y5	SS	HYMP532U64CP8-Y5	•	•	•
1024MB	Hynix	HY5PS12821CFP-Y5	DS	HYMP512U64CP8-Y5			•
256MB	CORSAIR	MIII00605	SS	VS256MB667D2			•
512MB	CORSAIR	64M8CFEG	SS	VS512MB667D2	•	•	
1024MB	CORSAIR	64M8CFEG	DS	VS1GB667D2	•	•	•
256MB	ELPIDA	E2508AB-6E-E	SS	EBE25UC8ABFA-6E-E	•	•	•
512MB	ELPIDA	E5108AE-6E-E	SS	EBE51UD8AEFA-6E-E			
512MB	A-DATA	AD29608A8A-3EG	SS	M20AD5G3H316611C52	•	•	•
1024MB	A-DATA	AD29608A8A-3EG	DS	M20AD5G3I417161C52	•	•	
2048MB	A-DATA	NT5TU128M8BJ-3C	DS	M20NY5H3J41701C5Z	•	•	•
512MB	crucial	Heat-Sink Package	SS	BL6464AA663.8FD		•	•
1024MB	crucial	Heat-Sink Package	DS	BL12864AA663.16FD	•	•	•
1024MB	crucial	Heat-Sink Package	DS	BL12864AL664.16FD	•	•	•
1024MB	crucial	Heat-Sink Package	DS	BL12864AA663.16FD2	•	•	•
512MB	Apacer	AM4B5708GQJS7E0628F	SS	AU512E667C5KBGC	•	•	•
1024MB	Apacer	AM4B5708GQJS7E	DS	AU01GE667C5KBGC			
256MB	Kingmax	N2TU51216AG-3C	SS	KLCB68F-36KH5	•	•	
512MB	Kingmax	KKEA88B4LAUG-29DX	SS	KLCC28F-A8KB5	•	•	•
1024MB	Kingmax	KKEA88B4LAUG-29DX	DS	KLCD48F-A8KB5	•	•	
512MB	Super Talent	Heat-Sink Package	SS	T6UA512C5	•	•	•
1024MB	Super Talent	Heat-Sink Package	DS	T6UB1GC5	•	•	•
2048MB	NANYA	NT5TU128M8BJ-3C	DS	NT2GT64U88B0JY-3C	•	•	
512MB	NANYA	NT5TU64M8BE-3C	SS	NT512T64U88B0BY-3C			
512MB	PSC	A3R12E3GEF637BLC5N	SS	AL6E8E63B-6E1K	•	•	•
1024MB	PSC	A3R12E3GEF637BLC5N	DS	AL7E8E63B-6E1K	•	•	•

M3N-HT Deluxe Motherboard Qualified Vendors Lists (QVL) DDR2-667MHz capability

Size	Vendor	Chip No.	SS/DS	Part No.	DIMM support		
					A*	B*	C*
512MB	TwinMOS	E5108AE-GE-E	SS	8G-25JK5-EBT	*	*	*
512MB	TwinMOS	TMM6208G8M30C	SS	8D-23JK5M2ETP	*	*	*

M3N-HT Deluxe Motherboard Qualified Vendors Lists (QVL) DDR2-533MHz capability

Size	Vendor	Chip No.	SS/DS	Part No.	DIMM support		
					A*	B*	C*
512MB	KINGSTON	HYB18T512800AF37	SS	KVR533D2N4/512	*	*	*
1024MB	KINGSTON	D6408TPAGGL3U	DS	KVR533D2N4/1G	*	*	*
2048MB	KINGSTON	E1108AB-6E-E	DS	KVR533D2N4/2G	*	*	*
512MB	Qimonda	HYB18T512800BF37	SS	HYS64T64000HU-3.7-B	*	*	*
1024MB	Qimonda	HYB18T512800BF37	DS	HYS64T128020HU-3.7-B	*	*	*
256MB	Hynix	HY5PS121621CFP-C4	SS	HYMP532U64CP6-C4	*	*	*
1024MB	Hynix	HY5PS12821CFP-C4	DS	HYMP512U64CP8-C4	*	*	*
256MB	CORSAIR	32M16CEDG	SS	VS256MB533D2	*	*	*
512MB	CORSAIR	MI110052432M8CEC	DS	VS512MB533D2	*	*	*
1024MB	CORSAIR	64M8CEDG	DS	VS1GB533D2	*	*	*
512MB	ELPIDA	E5108AB-5C-E	SS	EBE51UD8ABFA-5C	*	*	*
512MB	ELPIDA	E5108AB-5C-E	SS	EBE51UD8ABFA-5C-E	*	*	*
1024MB	ELPIDA	E5108AB-5C-E	DS	EBE11UD8ABFA-5C-E	*	*	*
512MB	KINGMAX	E5108AE-5C-E	SS	KLBC28F-A8EB4	*	*	*
1024MB	KINGMAX	E5108AE-5C-E	DS	KLBD48F-A8EB4	*	*	*
512MB	KINGMAX	KKEA88E4AAK-37	SS	KLBC28F-A8KE4	*	*	*
1024MB	KINGMAX	5MB22D9DCN	DS	KLBD48F-A8ME4	*	*	*
512MB	Apacer	AM4B5708GQJS5D	SS	AU512E533C4KBGC	*	*	*
1024MB	Apacer	AM4B5708GQJS5D	DS	AU01GE533C4KBGC	*	*	*
512MB	Super Talent	Heat-Sink Package	SS	T5UA512C4	*	*	*
1024MB	Super Talent	Heat-Sink Package	DS	T5UB1G8C4	*	*	*
1024MB	PQI	64MX8D2-E	DS	MEAB-323LA	*	*	*
512MB	PQI	64MX8D2-E	SS	MEAB-423LA	*	*	*
512MB	TwinMOS	K4T51083QB-GCD5	SS	8D-22JB5-K2T	*	*	*

2.4.5 Installing ASUS Cool Mempipe (Mempipe Edition only)

Install ASUS Cool Mempipe to your motherboard to achieve excellent thermal dissipation for your memory modules.

To install ASUS Cool Mempipe:

1. Secure the motherboard to your chassis with nine screws.
2. Install memory modules to sockets DIMM_A1/B1 first.



3. Loosen the four nuts to part the heat spreaders.
4. Remove the four pieces of protective film on the heat spreaders.

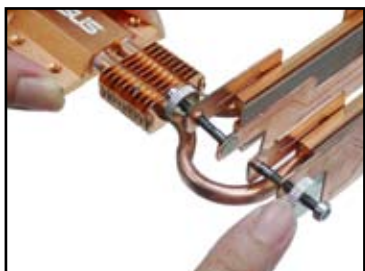

5. Align the Cool Mempipe with the northbridge heatsink and ensure the memory modules are located between the heat spreaders.
6. Fasten the Cool Mempipe to the northbridge heatsink with four screws.



7. Adjust the heatpipe until the heat spreaders contact the memory modules.

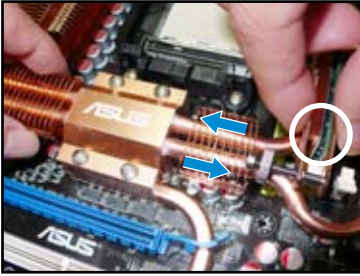

8. Firmly press the heat spreaders against the memory modules.

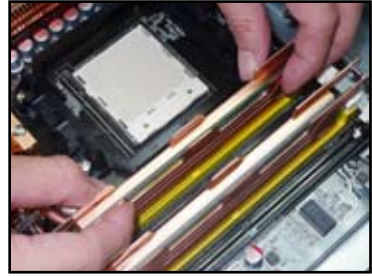

9. Hold the heat spreaders and secure the four nuts. DO NOT overtighten the nuts.

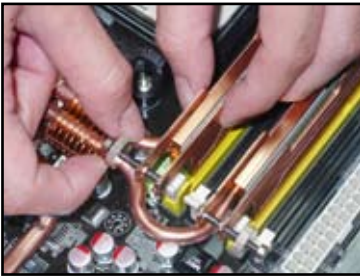

10. Install another two memory modules to sockets DIMM_A2/ B2 if necessary.

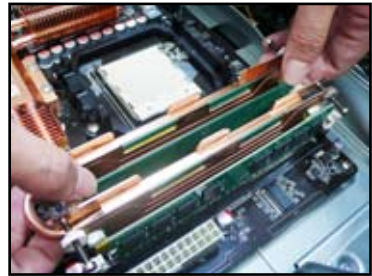

Install memory modules to sockets DIMM_A2 and DIMM_B2 after the completion of Cool Mempipe installation.

2.5 Expansion slots

In the future, you may need to install expansion cards. The following sub-sections describe the slots and the expansion cards that they support.



Make sure to unplug the power cord before adding or removing expansion cards. Failure to do so may cause you physical injury and damage motherboard components.

2.5.1 Installing an expansion card

To install an expansion card:

1. Before installing the expansion card, read the documentation that came with it and make the necessary hardware settings for the card.
2. Remove the system unit cover (if your motherboard is already installed in a chassis).
3. Remove the bracket opposite the slot that you intend to use. Keep the screw for later use.
4. Align the card connector with the slot and press firmly until the card is completely seated on the slot.
5. Secure the card to the chassis with the screw you removed earlier.
6. Replace the system cover.

2.5.2 Configuring an expansion card

After installing the expansion card, configure the it by adjusting the software settings.

1. Turn on the system and change the necessary BIOS settings, if any. See Chapter 4 for information on BIOS setup.
2. Assign an IRQ to the card. Refer to the tables on the next page.
3. Install the software drivers for the expansion card.



When using PCI cards on shared slots, ensure that the drivers support "Share IRQ" or that the cards do not need IRQ assignments; otherwise, conflicts will arise between the two PCI groups, making the system unstable and the card inoperable.

2.5.3 Interrupt assignments

Standard interrupt assignments

IRQ	Priority	Standard function
0	1	System Timer
1	2	Keyboard Controller
2	–	Redirect to IRQ#9
4	12	Communications Port (COM1)*
5	13	IRQ Holder for PCI Steering*
6	14	Floppy Disk Controller
7	15	Reserved
8	3	System CMOS/Real Time Clock
9	4	IRQ Holder for PCI Steering*
10	5	IRQ Holder for PCI Steering*
11	6	IRQ Holder for PCI Steering*
12	7	Reserved
13	8	Numeric Data Processor
14	9	Primary IDE Channel

* These IRQs are usually available for ISA or PCI devices.

IRQ assignments for this motherboard

	A	B	C	D	E	F	G	H
PCIE x16_1	shared	shared	shared	shared	–	–	–	–
PCIE x16_2	shared	shared	shared	shared	–	–	–	–
PCIE x16_3	shared	shared	shared	shared	–	–	–	–
USB 1.0 controller 1	–	–	–	shared	–	–	–	–
USB 1.0 controller 2	–	–	–	shared	–	–	–	–
USB 1.0 controller 3	–	–	–	shared	–	–	–	–
USB 1.0 controller 4	–	–	–	shared	–	–	–	–
USB 2.0 controller	–	–	–	shared	–	–	–	–
HD audio	shared	–	–	–	–	–	–	–
Onboard SATA	–	–	–	–	–	shared	–	–

2.5.4 PCI slots

The PCI slots support cards such as a LAN card, SCSI card, USB card, and other cards that comply with PCI specifications. Refer to the figure below for the location of the slots.

2.5.5 PCI Express x1 slot

This motherboard supports PCI Express x1 network cards, SCSI cards and other cards that comply with the PCI Express specifications. Refer to the figure below for the location of the slot.

2.5.6 Three PCI Express x16 slots

This motherboard has three PCI Express x16 slots that support PCI Express x16 graphic cards complying with the PCI Express specifications. With three graphics cards installed, the motherboard can enable multi-display. All of the three PCI Express x16 slots support PCIe 2.0 devices.

This motherboard supports 3 SLI-ready Express x16 graphics cards that comply with the PCI Express specifications.

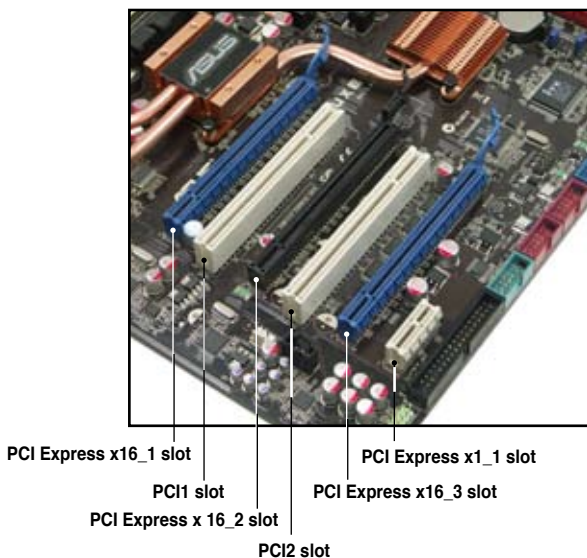

Primary PCI Express x16 slot

The primary PCI Express x16 slots support PCI Express x16 graphic cards that comply with the PCI Express specifications.

Universal PCI Express slot (max. x8 mode)

This motherboard also supports a Universal PCI Express slot with a maximum speed of 2 GB/s. The operating frequency of this slot changes, depending on the type of PCI Express card you install. Refer to the table below for details.

The figure shows two graphics cards installed on the primary PCI Express x16 slot and the Universal PCI Express slot.



- We recommend that you install a VGA card on the primary (blue) PCI Express slots, and install any other PCI Express device on the PCI Express slot (black).
- Currently, only NVIDIA® SLI™-Ready **GeForce® 8800 Ultra** and **GeForce® 8800 GTX** graphics cards support 3-Way SLI™ mode.
- 3-Way SLI™ mode is supported only under Windows® Vista OS. For more information, go to the NVIDIA® official website (www.nvidia.com).
- Currently, only NVIDIA® **GeForce® 8500 GT**, **GeForce® 8400 GS**, and **GeForce® 8400** graphics cards support GeForce Boost function under Hybrid SLI™ mode.
- Currently, only NVIDIA® **GeForce® 9800 GX2** graphics card supports HybridPower™ function under Hybrid SLI™ mode.
- Hybrid SLI™ mode is supported only under Windows® Vista OS. For more information, go to www.nvidia.com/hybridсли.
- Before enabling the HybridPower™ function, ensure that you have connected your display to the onboard VGA port or the HDMI/DVI port at the rear panel. Refer to **2.7.1 Rear panel connectors** for details.
- Connect a rear chassis fan to the chassis (CHA_FAN1 or CHA_FAN2) connector when using two (or three) graphics cards for better thermal environment. See page 2-32 for details.
- We recommend that you provide sufficient power when running NVIDIA® SLI™ mode. See pages 2-34 to 2-37 for details.

VGA configuration	PCI Express operating mode		
	PClex16_1	PClex16_2	PClex16_3
Single VGA/PCIe card	x16	x1	x16
Dual VGA/PCIe card	x16	x1	x16
Triple VGA/PCIe card	x8	x8	x8



- When using one VGA card and a x4 PCIe card at the same time, install them to the blue slots.
- If you install two VGA cards to the blue slots and use other x4 PCIe cards simultaneously, the x4 PCIe cards will downgrade to x1 mode for optimum VGA performance.

2.6 Jumper

Clear RTC RAM (3-pin CLRRTC)

This jumper allows you to clear the Real Time Clock (RTC) RAM in CMOS. You can clear the CMOS memory of date, time, and system setup parameters by erasing the CMOS RTC RAM data. The onboard button cell battery powers the RAM data in CMOS, which include system setup information such as system passwords.

To erase the RTC RAM:

1. Turn OFF the computer and unplug the power cord.
2. Remove the onboard battery.
3. Move the jumper cap from pins 1-2 (default) to pins 2-3. Keep the cap on pins 2-3 for about 5~10 seconds, then move the cap back to pins 1-2.
4. Reinstall the battery.
5. Plug the power cord and turn ON the computer.
6. Hold down the key during the boot process and enter BIOS setup to re-enter data.



Except when clearing the RTC RAM, never remove the cap on CLRRTC jumper default position. Removing the cap will cause system boot failure!

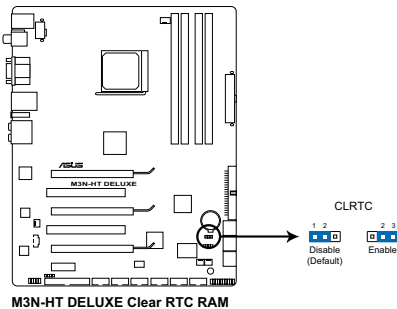

- You do not need to clear the RTC when the system hangs due to overclocking. For system failure due to overclocking, use the C.P.R. (CPU Parameter Recall) feature. Shut down and reboot the system so the BIOS can automatically reset parameter settings to default values.
 - Due to the chipset limitation, AC power off is required prior using C.P.R. function. You must turn off and on the power supply or unplug and plug the power cord before reboot the system.
-

2.7 Connectors

2.7.1 Rear panel connectors

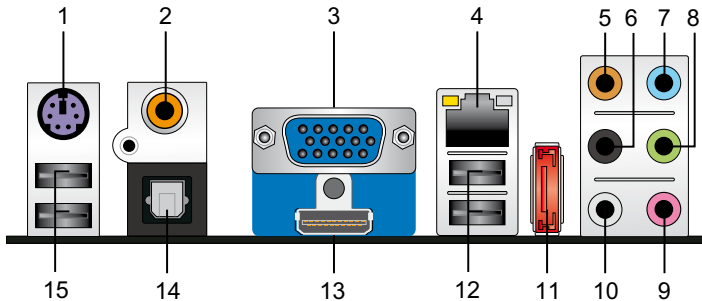

1. **PS/2 keyboard port (purple).** This port is for a PS/2 keyboard.
2. **Coaxial S/PDIF Out port.** This port connects an external audio output device via a coaxial S/PDIF cable.
3. **VGA port.** This port is for a VGA monitor or other VGA-compatible devices.
4. **LAN (RJ-45) port.** Supported by Gigabit LAN controller, this port allows Gigabit connection to a Local Area Network (LAN) through a network hub. Refer to the table below for the LAN port LED indications.
5. **Center/Subwoofer port (orange).** This port connects the center/subwoofer speakers.

LAN port LED indications

Activity/Link LED		Speed LED	
Status	Description	Status	Description
OFF	No link	OFF	10 Mbps connection
ORANGE	Linked	ORANGE	100 Mbps connection
BLINKING	Data activity	GREEN	1 Gbps connection

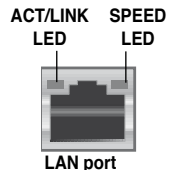

6. **Rear Speaker Out port (black).** This port connects the rear speakers in a 4-channel, 6-channel, or 8-channel audio configuration.
7. **Line In port (light blue).** This port connects the tape, CD, DVD player, or other audio sources.
8. **Line Out port (lime).** This port connects a headphone or a speaker. In 4-channel, 6-channel, and 8-channel configuration, the function of this port becomes Front Speaker Out.
9. **Microphone port (pink).** This port connects a microphone.
10. **Side Speaker Out port (gray).** This port connects the side speakers in an 8-channel audio configuration.



Refer to the audio configuration table below for the function of the audio ports in 2, 4, 6, or 8-channel configuration.

Audio 2, 4, 6, or 8-channel configuration

Port	Headset 2-channel	4-channel	6-channel	8-channel
Light Blue	Line In	Line In	Line In	Line In
Lime	Line Out	Front Speaker Out	Front Speaker Out	Front Speaker Out
Pink	Mic In	Mic In	Mic In	Mic In
Orange	–	–	Center/Subwoofer	Center/Subwoofer
Black	–	Rear Speaker Out	Rear Speaker Ou	Rear Speaker Out
Gray	–	–	–	Side Speaker Out

- 11. External SATA port.** This port connects an external Serial ATA hard disk drive.



The external SATA port supports external Serial ATA 3.0 Gb/s devices. Longer cables support higher power requirements to deliver signal up to two meters away, and enables improved hot-swap function.



DO NOT insert a different connector to this port.

- 12. USB 2.0 ports 1 and 2.** These 4-pin Universal Serial Bus (USB) ports are available for connecting USB 2.0 devices.
- 13. HDMI port.** This port is for a high-definition multimedia interface (HDMI) connector.



- This motherboard comes with dual-VGA output that features different displays on 2 monitors at the same time if you connect 2 monitors to both the onboard VGA and HDMI ports.
- With the bundled HDMI-to-DVI converter, this motherboard can also support DVI output.





Before enabling the HybridPower™ function, ensure that you have connected your display to the onboard VGA port or the HDMI/DVI port at the rear panel.



Playback of HD DVD and Blu-Ray Discs

The speed and bandwidth of the CPU/Memory, DVD player, and drivers will affect the playback quality. Following is a configuration example for your reference. Using the CPU/Memory of higher speed and bandwidth with the higher-version DVD player and drivers will upgrade the playback quality.

CPU: AMD Athlon 4400+

DIMM: DDR2-800 512MB

Playback software: PowerDVD Ultra v7.3

- 14. Optical S/PDIF Out port.** This port connects an external audio output device via an optical S/PDIF cable.
- 15. USB 2.0 ports 5 and 6.** These 4-pin Universal Serial Bus (USB) ports are available for connecting USB 2.0 devices.

2.7.2 Internal connectors

1. Floppy disk drive connector (34-1 pin FLOPPY)

This connector is for the provided floppy disk drive (FDD) signal cable. Insert one end of the cable to this connector, then connect the other end to the signal connector at the back of the floppy disk drive.



Pin 5 on the connector is removed to prevent incorrect cable connection when using a FDD cable with a covered Pin 5.

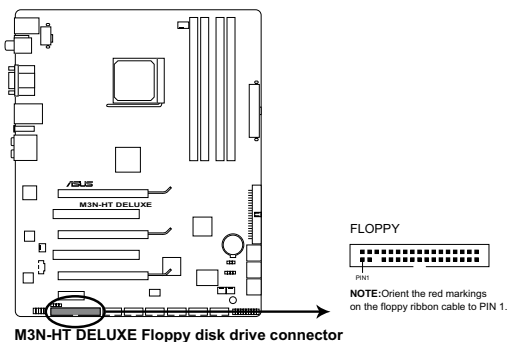

2. IDE connector (40-1 pin PRI_IDE)

The onboard IDE connector is for the Ultra DMA 133/100/66 signal cable. There are three connectors on each Ultra DMA 133/100/66 signal cable: blue, black, and gray. Connect the blue connector to the motherboard's IDE connector, then select one of the following modes to configure your device.

	Drive jumper setting	Mode of device(s)	Cable connector
Single device	Cable-Select or Master	–	Black
Two devices	Cable-Select	Master	Black
		Slave	Gray
	Master	Master	Black or gray
	Slave	Slave	



- Pin 20 on the IDE connector is removed to match the covered hole on the Ultra DMA cable connector. This prevents incorrect insertion when you connect the IDE cable.
- Use the 80-conductor IDE cable for Ultra DMA 100/66 IDE devices.



If any device jumper is set as "Cable-Select," make sure all other device jumpers have the same setting.

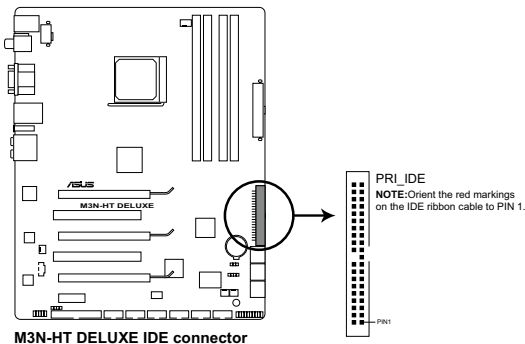

3. NVIDIA® nForce 780a SLI Serial ATA connectors (7-pin SATA1–4 [red]; 7-pin SATA5–6 [black])

These connectors are for the Serial ATA signal cables for Serial ATA hard disk and optical disk drives.

If you install SATA hard disk drives to the SATA1/2/3/4/5/6 connectors, you can create a RAID 0, RAID 1, RAID 0+1, RAID 5 and JBOD configuration through the onboard NVIDIA® nForce 780a SLI controller.



- SATA1–4 connectors are set to [IDE] by default. If you intend to create a Serial ATA RAID set using these connectors, set the **Onchip SATA Type** item in the BIOS to [RAID].
- Before creating a RAID set, refer to the manual bundled in the motherboard support DVD.

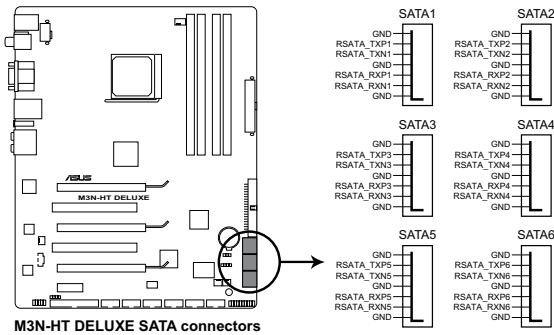

- SATA 5–6 connectors support AHCI mode and RAID mode only. Make sure to install the AHCI driver or RAID driver in the bundled support DVD before connecting devices to SATA 5–6 connectors. Otherwise, the devices will not work.
- You must install the Windows® XP Service Pack 1 before using Serial ATA hard disk drives. The Serial ATA RAID feature (RAID 0 and RAID 1) is available only if you are using Windows® XP or later version.



Connect the right-angle side of SATA signal cable to SATA device. Or you may connect the right-angle side of SATA cable to the onboard SATA port to avoid mechanical conflict with huge graphics cards.

right angle side

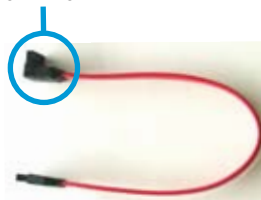

4. USB connectors (10-1 pin USB34; 10-1 pin USB78; 10-1 pin USB910)

These connectors are for USB 2.0 ports. Connect the USB module cable to any of these connectors, then install the module to a slot opening at the back of the system chassis. These USB connectors comply with USB 2.0 specification that supports up to 480 Mbps connection speed.

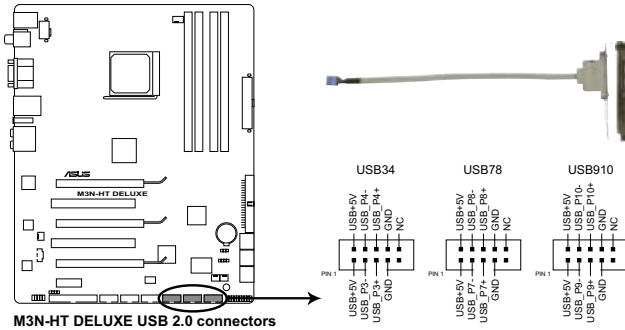

M3N-HT DELUXE USB 2.0 connectors



Never connect a 1394 cable to the USB connectors. Doing so will damage the motherboard!



You can connect the front panel USB cable to the ASUS Q-Connector (USB, blue) first, and then install the Q-Connector (USB) to the USB connector onboard if your chassis supports front panel USB ports.

5. IEEE 1394a port connector (10-1 pin IE1394_1; 10-1 pin IE1394_2)

These connectors are for IEEE 1394a ports. Connect the IEEE 1394a module cable to one of the connectors, then install the module to a slot opening at the back of the system chassis.

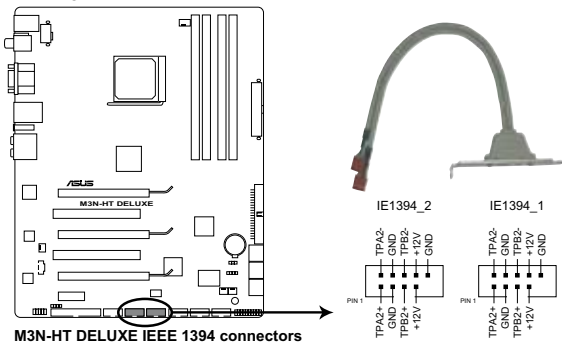

M3N-HT DELUXE IEEE 1394 connectors



Never connect a USB cable to the IEEE 1394a connector. Doing so will damage the motherboard!



You can connect the front panel 1394 cable to the ASUS Q-Connector (1394, red) first, and then install the Q-Connector (1394) to the 1394 connector onboard if your chassis supports front panel 1394 ports.

6. CPU, chassis, and power fan connectors (4-pin CPU_FAN; 3-pin CHA_FAN1; 3-pin CHA_FAN2; 3-pin PWR_FAN)

The fan connectors support cooling fans of 350 mA~2000 mA (24 W max.) or a total of 1 A~7 A (84 W max.) at +12V. Connect the fan cables to the fan connectors on the motherboard, making sure that the black wire of each cable matches the ground pin of the connector.



Do not forget to connect the fan cables to the fan connectors. Insufficient air flow inside the system may damage the motherboard components. These are not jumpers! Do not place jumper caps on the fan connectors!

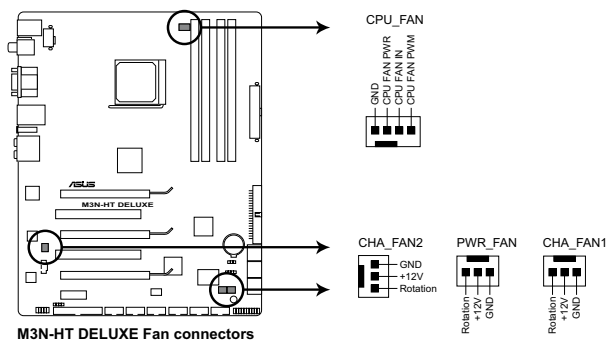

- Only the CPU_FAN and CHA_FAN 1/2 connectors support the ASUS Q-FAN 2 feature.
- If you install two graphics cards, we recommend that you plug the rear chassis fan cable to the motherboard connector labeled CHA_FAN1 or CHA_FAN2 for better thermal environment.

7. Chassis intrusion connector (4-1 pin CHASSIS)

This connector is for a chassis-mounted intrusion detection sensor or switch. Connect one end of the chassis intrusion sensor or switch cable to this connector. The chassis intrusion sensor or switch sends a high-level signal to this connector when a chassis component is removed or replaced. The signal is then generated as a chassis intrusion event.

By default, the pin labeled “Chassis Signal” and “Ground” are shorted with a jumper cap. Remove the jumper caps only when you intend to use the chassis intrusion detection feature.

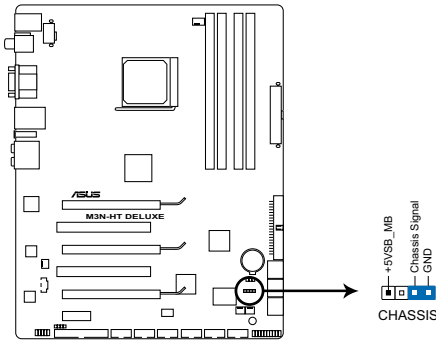

M3N-HT DELUXE Chassis intrusion connector

8. Optical drive audio connector (4-pin CD)

These connectors allow you to receive stereo audio input from sound sources such as a CD-ROM, TV tuner, or MPEG card.

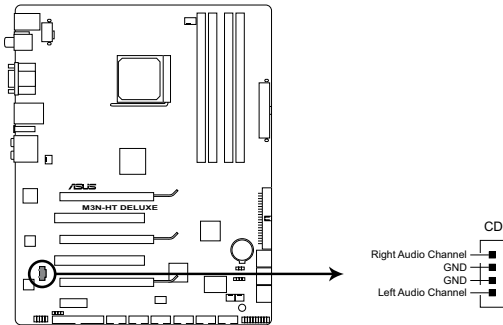

M3N-HT DELUXE Internal audio connector

9. ATX power connectors (24-pin EATXPWR; 8-pin ATX12V)

These connectors are for ATX power supply plugs. The power supply plugs are designed to fit these connectors in only one orientation. Find the proper orientation and push down firmly until the connectors completely fit.

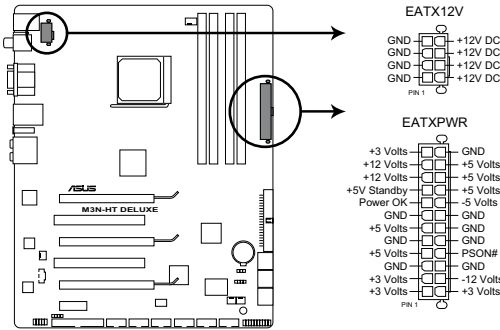

M3N-HT DELUXE ATX power connectors



- For a fully configured system, we recommend that you use a power supply unit (PSU) that complies with ATX 12 V Specification 2.0 (or later version) and provides a minimum power of 600 W.
- Do not forget to connect the 8-pin ATX +12 V power plug; otherwise, the system will not boot.
- Use of a PSU with a higher power output is recommended when configuring a system with more power-consuming devices. The system may become unstable or may not boot up if the power is inadequate.
- If you are uncertain about the minimum power supply requirement for your system, refer to the **Recommended Power Supply Wattage Calculator** at <http://support.asus.com/PowerSupplyCalculator/PSCalculator.aspx?SLanguage=en-us> for details.
- If you want to use two or more high-end PCI Express x16 cards, use a PSU with 1000 W power or above to ensure the system stability.

PSU suggested list

PSU suggested list
SilverStone ST1000
Seasonic SS-600HT
Thermaltake W0083RE
Thermaltake PUREPower-600AP
Silverstone SST-ST75ZF
EnerMAX EG701AX-VE (E)(24P)

- If you want to use 3-Way SLI™ configuration, visit the NVIDIA website (www.nvidia.com) for the qualified PSU vendor list.

Power supply requirements

Heavy Loading	
CPU	SMF 3.2XE
Memory	1 GB*4
VGA	8800 Ultra*3
SATA-HDD	6
eSATA-HDD	1
IDE-CDROM	1
IDE-HDD	1
USB	4

	+12V_8Pin	+12V_24pin	+5V_24pin	+3V_24pin	+12V_VGA1	+12V_VGA2	+12V_VGA3
Voltage (V)	12.14	12.21	5.22	3.456	12.2	12.2	12.2
Current (A)	11.32	13.71	6.41	6.98	6.51	6.59	6.6
Power (W)	137.425	167.399	33.460	24.123	79.422	80.398	80.52
	SATA-HDD	eSATA-HDD	IDE-CDROM	IDE-HDD	USB	Total PSU	
Voltage (V)	6	1	1	1	4	Po_max(w)	
Current (A)	10.45	10.45	10	12.68	2.5	708.577	
Power (W)	62.7	10.45	10	12.68	10		

Normal Loading	
CPU	KSF 3.0XE
Memory	1 GB*4
VGA	8800 Ultra*2
SATA-HDD	4
eSATA-HDD	1
IDE-CDROM	1
IDE-HDD	0
USB	4

	+12V_8Pin	+12V_24pin	+5V_24pin	+3V_24pin	+12V_VGA1	+12V_VGA2	+12V_VGA3
Voltage (V)	12.14	12.21	5.225	3.455	12.2	12.2	
Current (A)	6.74	8.92	6.22	6.87	6.52	6.82	
Power (W)	81.824	108.913	32.500	23.736	79.544	83.204	0
	SATA-HDD	eSATA-HDD	IDE-CDROM	IDE-HDD	USB	Total PSU	
Voltage (V)	4	1	1	0	4	Po_max(w)	
Current (A)	10.45	10.45	10	12.68	2.5	481.970	
Power (W)	41.8	10.45	10	0	10		

Light Loading

CPU	Conroe 3.0+EM64T
Memory	1 GB*2
VGA	8800 Ultra*1
SATA-HDD	2
eSATA-HDD	1
IDE-CDROM	1
IDE-HDD	0
USB	4

	+12V_8Pin	+12V_24pin	+5V_24pin	+3V_24pin	+12V_VGA1	+12V_VGA2	+12V_VGA3
Voltage (V)	12.19	12.21	5.22	3.456	12.16		
Current (A)	3.19	5.55	5.04	5.36	6.5		
Power (W)	38.886	67.766	26.309	18.524	79.04	0	0
	SATA-HDD	eSATA-HDD	IDE-CDROM	IDE-HDD	USB	Total PSU	
Voltage (V)	2	1	1	0	4	Po_max(w)	
Current (A)	10.45	10.45	10	12.68	2.5		
Power (W)	20.9	10.45	10	0	10	281.875	

10. Front panel audio connector (10-1 pin AAFP)

This connector is for a chassis-mounted front panel audio I/O module that supports either HD Audio or legacy AC'97 audio standard. Connect one end of the front panel audio I/O module cable to this connector.

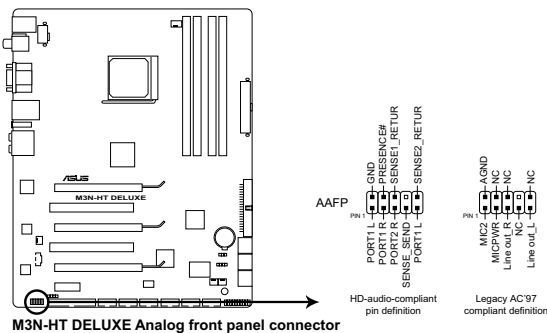

- We recommend that you connect a high-definition front panel audio module to this connector to avail of the motherboard's high-definition audio capability.
- If you want to connect a high-definition front panel audio module to this connector, set the **Front Panel Support Type** item in the BIOS setup to **[HD Audio]**; if you want to connect an AC'97 front panel audio module to this connector, set the item to **[AC97]**. By default, this connector is set to **[HD Audio]**.

11. Serial port connector (10-1 pin COM1)

This connector is for a serial (COM) port. Connect the serial port module cable to this connector, then install the module to a slot opening at the back of the system chassis.

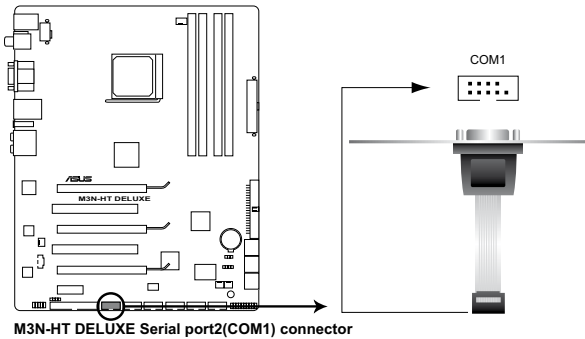

The COM module is purchased separately.

12. Digital audio connector (4-1 pin SPDIF_OUT)

This connector is for an additional Sony/Philips Digital Interface (S/PDIF) port(s). Connect the S/PDIF Out module cable to this connector, then install the module to a slot opening at the back of the system chassis.

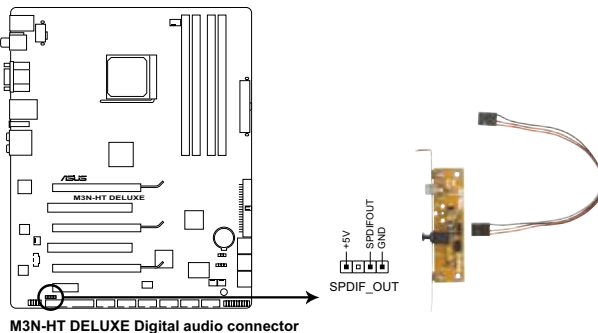

The S/PDIF module is purchased separately.

13. System panel connector (20-8 pin PANEL)

This connector supports several chassis-mounted functions.

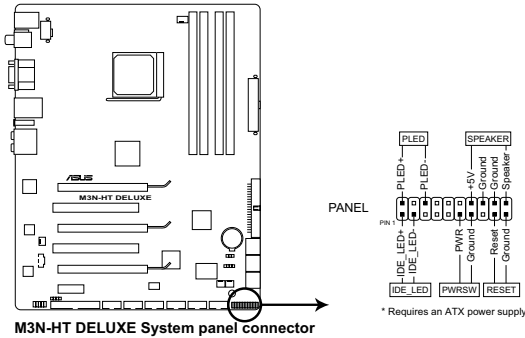

- **System power LED (2-pin PLED)**

This 2-pin connector is for the system power LED. Connect the chassis power LED cable to this connector. The system power LED lights up when you turn on the system power, and blinks when the system is in sleep mode.

- **Hard disk drive activity LED (2-pin IDE_LED)**

This 2-pin connector is for the HDD Activity LED. Connect the HDD Activity LED cable to this connector. The IDE LED lights up or flashes when data is read from or written to the HDD.

- **System warning speaker (4-pin SPEAKER)**

This 4-pin connector is for the chassis-mounted system warning speaker. The speaker allows you to hear system beeps and warnings.

- **ATX power button/soft-off button (2-pin PWR)**

This connector is for the system power button. Pressing the power button turns the system on or puts the system in sleep or soft-off mode depending on the BIOS settings. Pressing the power switch for more than four seconds while the system is ON turns the system OFF.

- **Reset button (2-pin RESET)**

This 2-pin connector is for the chassis-mounted reset button for system reboot without turning off the system power.

ASUS Q-Connector (system panel)

You can use the ASUS Q-Connector to connect/disconnect chassis front panel cables in a few steps. Refer to the instructions below to install the ASUS Q-Connector.

1. Connect the front panel cables to the ASUS Q-Connector.
Refer to the labels on the Q-Connector to know the detailed pin definitions, then match them to the respective front panel cable labels.

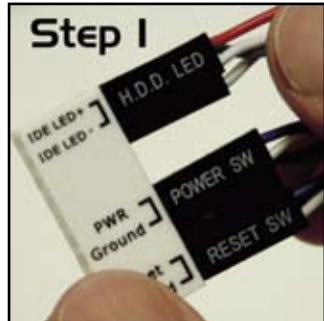

2. Install the ASUS Q-Connector to the system panel connector, making sure the orientation matches the labels on the motherboard.

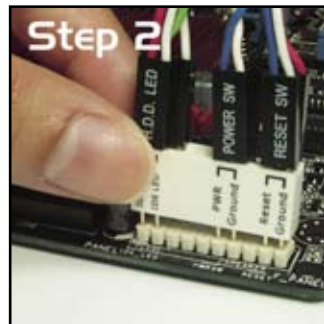

3. The front panel functions are now enabled. The figure shows the Q-Connector properly installed on the motherboard.

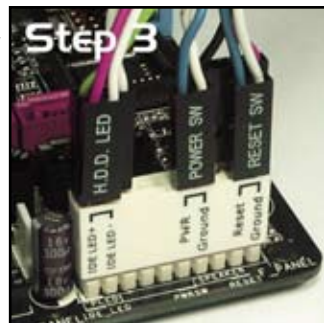

This chapter describes the power up sequence, the vocal POST messages, and ways of shutting down the system.

Powering up **3**

Chapter summary

3

3.1	Starting up for the first time.....	3-1
3.2	Turning off the computer.....	3-2

3.1 Starting up for the first time

1. After making all the connections, replace the system case cover.
2. Be sure that all switches are off.
3. Connect the power cord to the power connector at the back of the system chassis.
4. Connect the power cord to a power outlet that is equipped with a surge protector.
5. Turn on the devices in the following order:
 - a. Monitor
 - b. External SCSI devices (starting with the last device on the chain)
 - c. System power
6. After applying power, the system power LED on the system front panel case lights up. For systems with ATX power supplies, the system LED lights up when you press the ATX power button. If your monitor complies with “green” standards or if it has a “power standby” feature, the monitor LED may light up or switch between orange and green after the system LED turns on.

The system then runs the power-on self tests or POST. While the tests are running, the BIOS beeps (see BIOS beep codes table below) or additional messages appear on the screen. If you do not see anything within 30 seconds from the time you turned on the power, the system may have failed a power-on test. Check the jumper settings and connections or call your retailer for assistance.

BIOS beep codes

BIOS Beep	Description
One short beep	No keyboard detected
One continuous beep followed by two short beeps then a pause (repeated)	No memory detected
One continuous beep followed by three short beeps	No VGA detected
One continuous beep followed by four short beeps	Hardware component failure

7. At power on, hold down the <Delete> key to enter the BIOS Setup.

3.2 Turning off the computer

3.2.1 Using the OS shut down function

If you are using Windows® XP:

1. Click the **Start** button then select **Turn Off Computer**.
2. Click the **Turn Off** button to shut down the computer.
3. The power supply should turn off after Windows® shuts down.

If you are using Windows® Vista™:

1. Click the **Start** button then select **ShutDown**.
2. The power supply should turn off after Windows® shuts down.

3.2.2 Using the dual function power switch

While the system is ON, pressing the power switch for less than four seconds puts the system to sleep mode or to soft-off mode, depending on the BIOS setting. Pressing the power switch for more than four seconds lets the system enter the soft-off mode regardless of the BIOS setting.

This chapter tells how to change the system settings through the BIOS Setup menus. Detailed descriptions of the BIOS parameters are also provided.

BIOS setup 4

4.1	Managing and updating your BIOS	4-1
4.2	BIOS setup program	4-9
4.3	Main menu	4-13
4.4	Advanced menu	4-18
4.5	Power menu	4-30
4.6	Boot menu	4-34
4.7	Tools menu	4-39
4.8	Exit menu	4-43

4.1 Managing and updating your BIOS

The following utilities allow you to manage and update the motherboard Basic Input/Output System (BIOS) setup.

1. **ASUS Update** (Updates the BIOS in Windows® environment.)
2. **ASUS EZ Flash 2** (Updates the BIOS in DOS using a floppy disk or a USB flash disk.)
3. **Award BIOS Flash Utility** (Updates the BIOS in DOS mode using a bootable floppy disk.)

Refer to the corresponding sections for details on these utilities.



Save a copy of the original motherboard BIOS file to a bootable floppy disk in case you need to restore the BIOS in the future. Copy the original motherboard BIOS using the ASUS Update or Award BIOS Flash utilities.

4.1.1 ASUS Update utility

The ASUS Update is a utility that allows you to manage, save, and update the motherboard BIOS in Windows® environment. The ASUS Update utility allows you to:

- Save the current BIOS file
- Download the latest BIOS file from the Internet
- Update the BIOS from an updated BIOS file
- Update the BIOS directly from the Internet, and
- View the BIOS version information.

This utility is available in the support DVD that comes with the motherboard package.



ASUS Update requires an Internet connection either through a network or an Internet Service Provider (ISP).

Installing ASUS Update

To install ASUS Update:

1. Place the support DVD in the optical drive. The Drivers menu appears.
2. Click the Utilities tab, then click Install ASUS Update VX.XX.XX. See page 5-3 for the Utilities screen menu.
3. The ASUS Update utility is copied to your system.



Quit all Windows® applications before you update the BIOS using this utility.

Updating the BIOS through the Internet

To update the BIOS through the Internet:

1. Launch the ASUS Update utility from the Windows® desktop by clicking **Start > Programs > ASUS > ASUSUpdate > ASUSUpdate**. The ASUS Update main window appears.

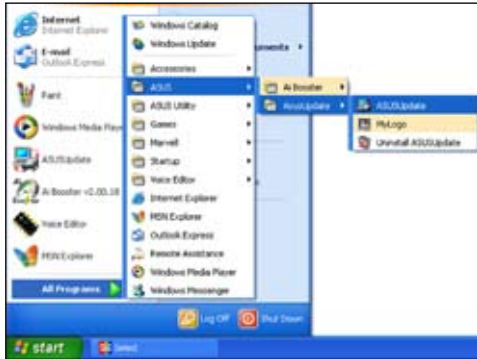

2. Select **Update BIOS** from the Internet option from the drop-down menu, then click **Next**.
3. Select the ASUS FTP site nearest you to avoid network traffic, or click **Auto Select**. Click **Next**.

- From the FTP site, select the BIOS version that you wish to download. Click **Next**.
- Follow the screen instructions to complete the update process.



The ASUS Update utility is capable of updating itself through the Internet. Always update the utility to avail all its features.



Updating the BIOS through a BIOS file

To update the BIOS through a BIOS file:

- Launch the ASUS Update utility from the Windows® desktop by clicking **Start > Programs > ASUS > ASUSUpdate > ASUSUpdate**. The ASUS Update main window appears.
- Select Update BIOS from a file option from the drop-down menu, then click **Next**.



- Locate the BIOS file from the Open window, then click **Open**.
- Follow the screen instructions to complete the update process.

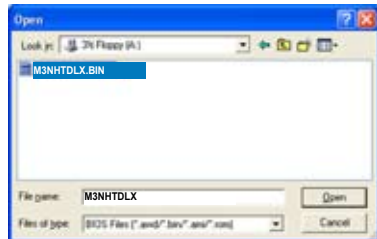

4.1.2 Creating a bootable floppy disk

1. Do either one of the following to create a bootable floppy disk.

DOS environment

- a. Insert a 1.44MB floppy disk into the drive.
- b. At the DOS prompt, type `format A: /s` then press <Enter>.

Windows® XP environment

- a. Insert a 1.44 MB floppy disk to the floppy disk drive.
- b. Click **Start** from the Windows® desktop, then select **My Computer**.
- c. Select the 3 1/2 Floppy Drive icon.
- d. Click File from the menu, then select **Format. A Format 3 1/2 Floppy Disk** window appears.
- e. Select **Create an MS-DOS startup disk** from the format options field, then click **Start**.

4.1.3 ASUS EZ Flash 2 utility

The ASUS EZ Flash 2 feature allows you to update the BIOS without having to go through the long process of booting from a floppy disk and using a DOS-based utility. The EZ Flash 2 utility is built-in the BIOS chip so it is accessible by pressing <Alt> + <F2> during the Power-On Self Tests (POST).

To update the BIOS using EZ Flash 2:

1. Visit the ASUS website (www.asus.com) to download the latest BIOS file for the motherboard.
2. Save the BIOS file to a floppy disk or a USB flash disk, then restart the system.
3. You can launch the EZ Flash 2 by two methods.
 - (1) Insert the floppy disk / USB flash disk that contains the BIOS file to the floppy disk drive or the USB port.

Press <Alt> + <F2> during POST to display the following.

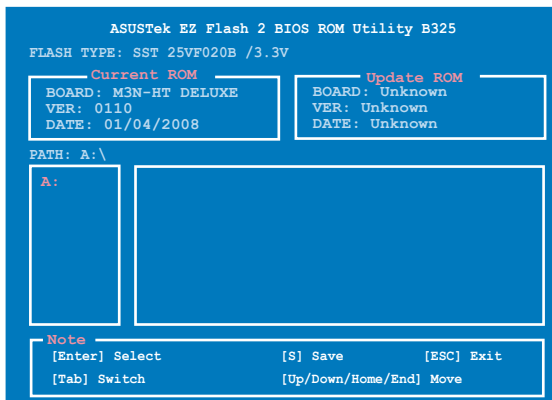

- (2) Enter BIOS setup program. Go to the **Tools** menu to select **EZ Flash 2** and press <Enter> to enable it.
You can switch between drives by pressing <Tab> before the correct file is found. Then press <Enter>.
4. When the correct BIOS file is found, EZ Flash 2 performs the BIOS update process and automatically reboots the system when done.



- This function can support devices such as USB flash disk, or floppy disk with **FAT 32/16** format and single partition only.
- DO NOT shut down or reset the system while updating the BIOS to prevent system boot failure!

4.1.4 Updating the BIOS

The Basic Input/Output System (BIOS) can be updated using the AwardBIOS Flash Utility. Follow these instructions to update the BIOS using this utility.

1. Visit the ASUS website (www.asus.com) and download the latest BIOS file for the motherboard. Save the BIOS file to a bootable floppy disk.



Write the BIOS filename on a piece of paper. You need to type the exact BIOS filename at the DOS prompt.

2. Copy the AwardBIOS Flash Utility (`awdf flash.exe`) from the Software folder of the support DVD to the floppy disk, DVDROM or a USB flash disk with the latest BIOS file.
3. Boot the system in DOS mode using the bootable floppy disk, DVDROM or a USB flash disk you created earlier.
4. Under the DOS mode, use `<X:>` (X stands for the name of the disk assignment) to switch to the folder of floppy disk, DVDROM or USB flash disk you saved the BIOS file and AwardBIOS Flash Utility.
5. At the prompt, type `awdf flash` then press `<Enter>`. The Award BIOS Flash Utility screen appears.

```
AwardBIOS Flash Utility for ASUS V1.17
(C) Phoenix Technologies Ltd. All Rights Reserved

For MCP72XE-M3N-HT-D-00          DATE:01/04/2008
Flash Type -

File Name to Program: 

Message: Please input File Name!
```

6. Type the BIOS file name in the File Name to Program field, then press <Enter>.

```
AwardBIOS Flash Utility for ASUS V1.17
(C) Phoenix Technologies Ltd. All Rights Reserved

For MCP72XE-M3N-HT-D-00          DATE:01/04/2008
Flash Type -

File Name to Program: M3NHTDLX.bin

Message: Do You Want To Save Bios (Y/N)
```

7. Press <N> when the utility prompts you to save the current BIOS file. The following screen appears.
8. The utility verifies the BIOS file in the floppy disk, DVDROM or a USB flash disk and starts flashing the BIOS file.

```
AwardBIOS Flash Utility for ASUS V1.17
(C) Phoenix Technologies Ltd. All Rights Reserved

For MCP72XE-M3N-HT-D-00          DATE:01/04/2008
Flash Type -

File Name to Program: M3NHTDLX.bin

Programming Flash Memory - OFE00 OK

Write OK      No Update      Write Fail

Warning: Don't Turn Off Power Or Reset System!
```



Do not turn off or reset the system during the flashing process!

9. The utility displays a Flashing Complete message indicating that you have successfully flashed the BIOS file. Remove the disk then press <F1> to restart the system.

```
AwardBIOS Flash Utility for ASUS V1.17
(C) Phoenix Technologies Ltd. All Rights Reserved

For MCP72XE-M3N-HT-D-00          DATE:01/04/2008
Flash Type -

File Name to Program: M3NHTDLX.bin
Flashing Complete
Press <F1> to Continue

Write OK      No Update      Write Fail

F1 Reset
```

4.1.5 Saving the current BIOS file

You can use the AwardBIOS Flash Utility to save the current BIOS file. You can load the current BIOS file when the BIOS file gets corrupted during the flashing process.



Make sure that the floppy disk, DVD ROM, or a USB flash disk has enough disk space to save the file.

To save the current BIOS file using the AwardBIOS Flash Utility:

1. Follow steps 1 to 6 of the previous section.
2. Press <Y> when the utility prompts you to save the current BIOS file. The following screen appears.

```
AwardBIOS Flash Utility for ASUS V1.17
(C) Phoenix Technologies Ltd. All Rights Reserved

For MCP72XE-M3N-HT-D-00      DATE:01/04/2008
Flash Type -

File Name to Program: 0112.bin
Save current BIOS as:

Message:
```

3. Type a filename for the current BIOS file in the Save current BIOS as field, then press <Enter>.

```
AwardBIOS Flash Utility for ASUS V1.17
(C) Phoenix Technologies Ltd. All Rights Reserved

For MCP72XE-M3N-HT-D-00      DATE:01/04/2008
Flash Type -

File Name to Program: 0112.bin
Checksum: 810DH
Save current BIOS as: 0113.bin

Message: Please Wait!
```

4. The utility saves the current BIOS file to the floppy disk, then returns to the BIOS flashing process.

```
AwardBIOS Flash Utility for ASUS V1.17
(C) Phoenix Technologies Ltd. All Rights Reserved

For MCP72XE-M3N-HT-D-00      DATE:01/04/2008
Flash Type -

File Name to Program: 0113.bin
Now Backup System BIOS to
File!

Message: Please Wait!
```

4.2 BIOS setup program

This motherboard supports a programmable Low-Pin Count (LPC) chip that you can update using the provided utility described in section “4.1 Managing and updating your BIOS.”

Use the BIOS Setup program when you are installing a motherboard, reconfiguring your system, or prompted to “Run Setup.” This section explains how to configure your system using this utility.

Even if you are not prompted to use the Setup program, you can change the configuration of your computer in the future. For example, you can enable the security password feature or change the power management settings. This requires you to reconfigure your system using the BIOS Setup program so that the computer can recognize these changes and record them in the CMOS RAM of the LPC chip.

The LPC chip on the motherboard stores the Setup utility. When you start up the computer, the system provides you with the opportunity to run this program. Press during the Power-On Self-Test (POST) to enter the Setup utility; otherwise, POST continues with its test routines.

If you wish to enter Setup after POST, restart the system by pressing <Ctrl+Alt+Delete>, or by pressing the reset button on the system chassis. You can also restart by turning the system off and then back on. Do this last option only if the first two failed.

The Setup program is designed to make it as easy to use as possible. Being a menu-driven program, it lets you scroll through the various sub-menus and make your selections from the available options using the navigation keys.



-
- The default BIOS settings for this motherboard apply for most conditions to ensure optimum performance. If the system becomes unstable after changing any BIOS settings, load the default settings to ensure system compatibility and stability. Select the **Load Default Settings** item under the Exit Menu. See section “4.8 Exit Menu.”
 - The BIOS setup screens shown in this section are for reference purposes only, and may not exactly match what you see on your screen.
 - Visit the ASUS website (www.asus.com) to download the latest BIOS file for this motherboard.
-

4.2.1 BIOS menu screen

The screenshot shows the BIOS menu screen with the following components labeled:

- Menu items:** Main, Advanced, Power, Boot, Tools, Exit
- Menu bar:** Phoenix-AwardBIOS CMOS Setup Utility
- Configuration fields:** System Time (15 : 30 : 36), System Date (Sat, Oct 26 2007), Language ([English]), Legacy Diskette A: (1.44M, 3.5 in.), Primary IDE Master ([ST321122A]), Primary IDE Slave ([ASUS CDS520/A]), SATA1 ([None]), SATA2 ([None]), SATA3 ([None]), SATA4 ([None]), HDD SMART Monitoring ([Disabled]), Installed Memory (512MB), Usable Memory (511MB)
- General help:** Select Menu, Item Specific Help, Change the day, month, year and century.
- Sub-menu items:** System Time, System Date, Language, Legacy Diskette A: (Primary IDE Master, Primary IDE Slave, SATA1, SATA2, SATA3, SATA4, HDD SMART Monitoring), Installed Memory, Usable Memory
- Legend bar:** F1: Help, ↓: Select Item, -/+ : Change Value, F5: Setup Defaults, ESC: Exit, ←: Select Menu, Enter: Select SubMenu, F10: Save and Exit

4.2.2 Menu bar

The menu bar on top of the screen has the following main items:

- Main** For changing the basic system configuration
- Advanced** For changing the advanced system settings
- Power** For changing the advanced power management (APM) configuration
- Boot** For changing the system boot configuration
- Tools** For configuring options for special functions
- Exit** For selecting the exit options and loading default settings

To select an item on the menu bar, press the right or left arrow key on the keyboard until the desired item is highlighted.



- The BIOS setup screens shown in this chapter are for reference purposes only, and may not exactly match what you see on your screen.
- Visit the ASUS website (www.asus.com) to download the latest BIOS information.

4.2.3 Legend bar

At the bottom of the Setup screen is a legend bar. The keys in the legend bar allow you to navigate through the various setup menus. The following table lists the keys found in the legend bar with their corresponding functions.

Navigation Key	Function
<F1>	Displays the General Help screen
<F5>	Loads setup default values
<Esc>	Exits the BIOS setup or returns to the main menu from a sub-menu
Left or Right arrow	Selects the menu item to the left or right
Up or Down arrow	Moves the highlight up or down between fields
Page Down or - (minus)	Scrolls backward through the values for the highlighted field
Page Up or + (plus)	Scrolls forward through the values for the highlighted field
<Enter>	Brings up a selection menu for the highlighted field
<F10>	Saves changes and exit

4.2.4 Menu items

The highlighted item on the menu bar displays the specific items for that menu. For example, selecting **Main** shows the Main menu items.

The other items (Advanced, Power, Boot, and Exit) on the menu bar have their respective menu items.

4.2.5 Sub-menu items

A solid triangle before each item on any menu screen means that the item has a sub-menu. To display the sub-menu, select the item and press <Enter>.

4.2.6 Configuration fields

These fields show the values for the menu items. If an item is user-configurable, you can change the value of the field opposite the item. You cannot select an item that is not user-configurable.

A configurable field is enclosed in brackets, and is highlighted when selected. To change the value of a field, select it then press <Enter> to display a list of options. Refer to "4.2.7 Pop-up window."

4.2.7 Pop-up window

Select a menu item then press <Enter> to display a pop-up window with the configuration options for that item.

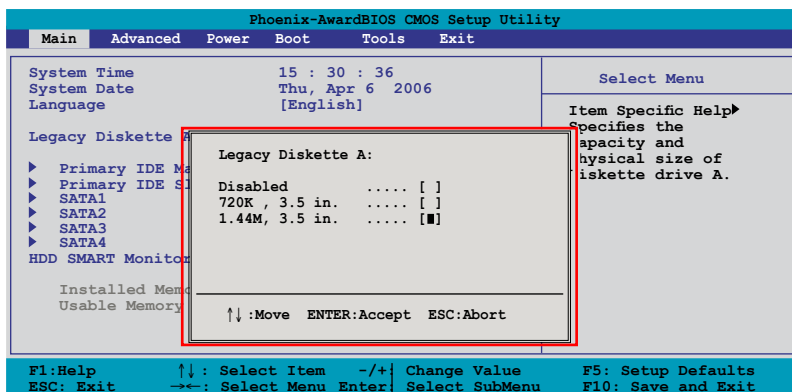

Pop-up menu

4.2.8 General help

At the top right corner of the menu screen is a brief description of the selected item.

4.3 Main menu

When you enter the BIOS Setup program, the Main menu screen appears, giving you an overview of the basic system information.



Refer to section “4.2.1 BIOS menu screen” for information on the menu screen items and how to navigate through them.

Phoenix-AwardBIOS CMOS Setup Utility					
Main	Advanced	Power	Boot	Tools	Exit
System Time	15 : 30 : 36				
System Date	Sat, Oct 26 2007				
Language	[English]				
Legacy Diskette A:	[1.44M, 3.5 in.]				
▶ Primary IDE Master	[ST321122A]				
▶ Primary IDE Slave	[ASUS CDS520/A]				
▶ SATA1	[None]				
▶ SATA2	[None]				
▶ SATA3	[None]				
▶ SATA4	[None]				
HDD SMART Monitoring	[Disabled]				
Installed Memory	512MB				
Usable Memory	511MB				
			Select Menu		
			Item Specific Help▶ Change the day, month, year and century.		
F1: Help	↑↓: Select Item	-/+ : Change Value	F5: Setup Defaults		
ESC: Exit	→←: Select Menu	Enter: Select SubMenu	F10: Save and Exit		

4.3.1 System Time [xx:xx:xx]

Allows you to set the system time.

4.3.2 System Date [Day xx/xx/xxxx]

Allows you to set the system date.

4.3.3 Language [English]

Allows you to choose the BIOS language version from the options. Configuration options: [English] [French] [Deutsch] [Chinese (Trad.)] [Chinese (Simp.)] [Japanese]

4.3.4 Legacy Diskette A [1.44M, 3.5 in.]

Sets the type of floppy drive installed.

Configuration options: [Disabled] [720K , 3.5 in.] [1.44M, 3.5 in.]

4.3.5 Primary IDE Master/Slave

While entering Setup, the BIOS automatically detects the presence of IDE devices. There is a separate sub-menu for each IDE device. Select a device item then press <Enter> to display the IDE device information.

Phoenix-Award BIOS CMOS Setup Utility			
Main			
Primary IDE Master		Select Menu	
PIO Mode	[Auto]	Item Specific Help▶▶ Set a PIO mode for IDE device. Mode0 through 4 successive increase in performance.	
UDMA Mode	[Auto]		
Primary IDE Master Access Mode	[Auto]		
Capacity	82 GB		
Cylinder	39420		
Head	16		
Sector	255		
Transfer Mode	UDMA 5		
F1: Help ↑↓: Select Item -/+ : Change Value F5: Setup Defaults			
ESC: Exit →←: Select Menu Enter: Select SubMenu F10: Save and Exit			

The BIOS automatically detects the values opposite the dimmed items (Capacity, Cylinder, Head, Sector and Transfer Mode). These values are not user-configurable. These items show N/A if no IDE device is installed in the system.

PIO Mode [Auto]

Sets the PIO mode for the IDE device.

Configuration options: [Auto] [Mode 0] [Mode 1] [Mode 2] [Mode 3] [Mode 4]

UDMA Mode [Auto]

Disables or sets the UDMA mode. Configuration options: [Disable] [Auto]

Primary IDE Master/Slave [Auto]

Select [Auto] to automatically detect an IDE hard disk drive. If automatic detection is successful, the BIOS automatically fills in the correct values for the remaining fields on this sub-menu. If the hard disk was already formatted on a previous system, the setup BIOS may detect incorrect parameters. Select [Manual] to manually enter the IDE hard disk drive parameters. If no drive is installed select [None]. Configuration options: [None] [Auto] [Manual]

Access Mode [Auto]

The default [Auto] allows automatic detection of an IDE hard disk drive. Select [CHS] for this item if you set the IDE Primary Master/Slave to [Manual]. Configuration options: [CHS] [LBA] [Large] [Auto]



Before attempting to configure a hard disk drive, make sure you have the correct configuration information supplied by the drive manufacturer. Incorrect settings may cause the system to fail to recognize the installed hard disk.

Capacity

Displays the auto-detected hard disk capacity. This item is not configurable.

Cylinder

Shows the number of the hard disk cylinders. This item is not configurable.

Head

Shows the number of the hard disk read/write heads. This item is not configurable.

Sector

Shows the number of sectors per track. This item is not configurable.

Transfer Mode

Shows the Transfer mode. This item is not configurable.



After entering the IDE hard disk drive information into BIOS, use a disk utility, such as FDISK, to partition and format new IDE hard disk drives. This is necessary so that you can write or read data from the hard disk. Make sure to set the partition of the Primary IDE hard disk drives to active.

4.3.6 SATA1/2/3/4

While entering Setup, the BIOS automatically detects the presence of Serial ATA devices. There is a separate sub-menu for each SATA device. Select a device item then press <Enter> to display the SATA device information.

Phoenix-Award BIOS CMOS Setup Utility		
Main		
SATA 1		Select Menu
Extended IDE Drive Access Mode	[Auto] [Auto]	Item Specific Help▶▶ Selects the type of fixed disk connected to the system.
Capacity	80 GB	
Cylinder	0	
Head	0	
Landing Zone	0	
Sector	0	
F1: Help ↑↓: Select Item -/+ : Change Value F5: Setup Defaults ESC: Exit ←→: Select Menu Enter: Select SubMenu F10: Save and Exit		

The BIOS automatically detects the values opposite the dimmed items (Capacity, Cylinder, Head, Landing Zone and Sector). These values are not user-configurable. These items show 0 if no SATA device is installed in the system.



Only SATA 1–4 connectors support IDE mode. If you want to use SATA 5–6 connectors, set the **SATA Operation Mode** item to [AHCI] or [RAID]. Refer to page 4-28 for more details.

Extended IDE Drive [Auto]

Selects the type of fixed disk connected to the system.

Configuration options: [None] [Auto]

Access Mode [Auto]

Sets the sector addressing mode. Configuration options: [Large] [Auto]



Before attempting to configure a hard disk drive, make sure you have the correct configuration information supplied by the drive manufacturer. Incorrect settings may cause the system to fail to recognize the installed hard disk.

Capacity

Displays the auto-detected hard disk capacity. This item is not configurable.

Cylinder

Shows the number of the hard disk cylinders. This item is not configurable.

Head

Shows the number of the hard disk read/write heads. This item is not configurable.

Landing Zone

Shows the number of landing zone per track. This item is not configurable.

Sector

Shows the number of sectors per track. This item is not configurable.



After entering the IDE hard disk drive information into BIOS, use a disk utility, such as FDISK, to partition and format new IDE hard disk drives. This is necessary so that you can write or read data from the hard disk. Make sure to set the partition of the Primary IDE hard disk drives to active.

4.3.7 HDD SMART Monitoring [Disabled]

Allows you to enable or disable the HDD Self-Monitoring Analysis and Reporting Technology (SMART) feature. Configuration options: [Disabled] [Enabled]

4.3.8 Installed Memory [xxx MB]

Shows the size of installed memory.

4.3.9 Usable Memory [XXX MB]

Shows the size of usable memory.

4.4 Advanced menu

The Advanced menu items allow you to change the settings for system devices.



Take caution when changing the settings of the Advanced menu items. Incorrect field values can cause the system to malfunction.

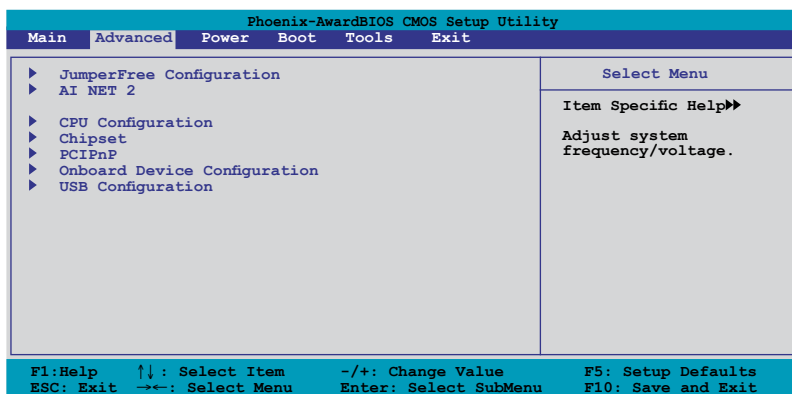

4.4.1 JumperFree Configuration

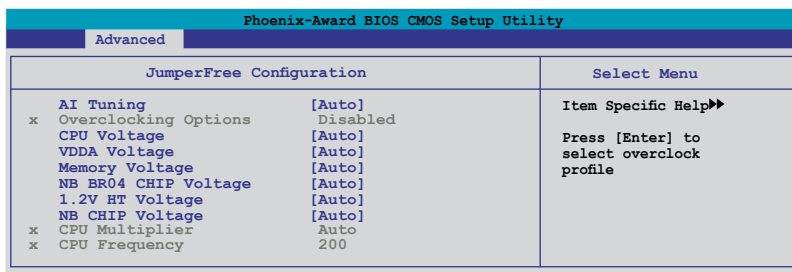

AI Tuning [Auto]

Allows selection of CPU overclocking options to achieve desired CPU internal frequency. Select either one of the preset overclocking configuration options:

Manual Allows you to individually set overclocking parameters.

Auto Loads the optimal settings for the system.

Standard Loads the standard settings for the system.

AI Overclock Loads overclocking profiles with optimal parameters for stability when overclocking.



The following item becomes user-configurable when you set **AI Tuning** to [AI Overclock].

Overclock Options [Disabled]

Allows you to set the overclocking options.

Configuration options: [Disabled] [Overclock 3%] [Overclock 5%] [Overclock 8%] [Overclock 10%]

CPU Voltage [AUTO]

Allows you to set the CPU voltage.

Configuration options: [AUTO] [0.8000v] [0.8125v]...[1.6750v] [1.6875v]

VDDA Voltage [AUTO]

Allows you to set the VDDA voltage.

Configuration options: [AUTO] [2.52V] [2.622V].[2.728V] [2.83V]

Memory Voltage [Auto]

Allows you to set the memory voltage.

Configuration options: [Auto] [1.800V] [1.820V]...[2.480V] [2.500V]

NB BR04 CHIP Voltage [Auto]

Configuration options: [Auto] [1.20V] [1.22V]...[1.54V] [1.56V]

1.2V HT Voltage [Auto]

Configuration options: [Auto] [1.20V] [1.22V]...[1.48V] [1.50V]

NB CHIP Voltage [Auto]

Configuration options: [Auto] [1.10V] [1.12V]...[1.68V] [1.70V]



The following items become user-configurable when you set **AI Tuning** to [Manual].

CPU Multiplier [Auto]

This item appears when you are using an unlocked CPU.

Configuration options: [Auto] [5x] [5.5x] [6x] [6.5x]...[10.5x] [11x]

CPU Frequency [200]

Allows you to set the CPU frequency. Key in the desired value using the numeric keypad and press the <Enter> key.

Configuration options: [200]–[600]

4.4.2 AI NET2

Phoenix-AwardBIOS CMOS Setup Utility		
Advanced		
AI NET2		Select Menu
POST Check LAN Cable [Disabled]		Item Specific Help▶▶
Pair	Status	Length
LAN1 (1-2)	Open	N/A
LAN1 (3-6)	Open	N/A
LAN1 (4-5)	Open	N/A
LAN1 (7-8)	Open	N/A
		Enable or Disable LAN cable check during POST.
F1: Help		↑↓: Select Item
ESC: Exit		-/+ : Change Value
		F5: Setup Defaults
		Enter: Select Sub-menu
		F10: Save and Exit

POST Check LAN Cable [Disabled]

Enables or disables checking of the LAN cable during the Power-On Self-Test (POST). Configuration options: [Disabled] [Enabled]

4.4.3 CPU Configuration

Phoenix-Award BIOS CMOS Setup Utility		
Advanced		
CPU Configuration		Select Menu
CPU Type AMD Phenom(tm) 9500 Quad-Core Processor		Item Specific Help▶▶
CPU Speed	2200MHz	Thermal Monitor 1 (On-die throttling)
Cache RAM (L2)	512K x4	Thermal Monitor 2 (Ratio & VID transition)
Cache RAM (L3)	2048K	
▶ DRAM Configuration		
AMD Virtualization	[Enabled]	
AMD Live!	[Disabled]	
AMD Cool "n" Quiet Function	[Disabled]	
Cache Mapping Cycle	[Auto]	

DRAM Configuration

Phoenix-Award BIOS CMOS Setup Utility		
Advanced		
DRAM Configuration		Select Menu
Memory Clock Frequency [Auto]		Item Specific Help▶▶
Tcl	[Auto]	Setting platform Memclock or limit value.
Trcd	[Auto]	
Trp	[Auto]	
Tras	[Auto]	
1T/T Memory Timing	[Auto]	
Memory Hole Remapping	[Enabled]	
Bottom of UMA DRAM [31:24]	[FC]	
AI Clock Skew	[Auto]	
x Channel A Clock Skew	Advance 300ps	
x Channel B Clock Skew	Advance 300ps	
▶ Advance Memory Settings		
▶ DRAM Timing Control		
▶ Output Driver Control		

Memory Clock Frequency [Auto]

Configuration options: [Auto] [DDR2 553] [DDR2 667] [DDR2 800] [DDR2 1066]

Tcl [Auto]

Configuration options: [Auto] [3] [4] [5] [6]

Trcd [Auto]

Configuration options: [Auto] [3] [4] [5] [6]

Trp [Auto]

Configuration options: [Auto] [3] [4] [5] [6]

Tras [Auto]

Configuration options: [Auto] [5] [6] [7] [8]...[18]

1T/2T Memory Timing [Auto]

Configuration options: [Auto] [1T] [2T]

Memory Hole Remapping [Enabled]

Allows you to enable or disable the remapping of the overlapped PCI memory above the total physical memory. Configuration options: [Enabled] [Disabled]

AI Clock Skew [Auto]

Configuration options: [Auto] [Manual]



The following items become user-configurable when you set **AI Clock Skew** to [Manual].

Channel A Clock Skew [Normal]

Allows you to adjust the DRAM clock skew for Channel A.

Configuration options: [Advance 900ps] [Advance 750ps] [Advance 600ps] [Advance 450ps] [Advance 300ps] [Advance 150ps] [Normal] [Delay 150ps] [Delay 300ps] [Delay 450ps] [Delay 600ps] [Delay 750ps] [Delay 900ps]

Channel B Clock Skew [Normal]

Allows you to adjust the DRAM clock skew for Channel B.

Configuration options: [Advance 900ps] [Advance 750ps] [Advance 600ps] [Advance 450ps] [Advance 300ps] [Advance 150ps] [Normal] [Delay 150ps] [Delay 300ps] [Delay 450ps] [Delay 600ps] [Delay 750ps] [Delay 900ps]

Advanced Memory Settings

CPU On-die Termination [Auto]

Configuration options: [Auto] [300 ohm] [150 ohm] [75 ohm]

Trc [Auto]

Configuration options: [Auto] [11] [12] [13] [14] [15] [16] [17]...[26]

Twr [Auto]

Configuration options: [Auto] [3] [4] [5] [6]

Trrd[Auto]

Configuration options: [Auto] [2] [3] [4] [5]

Trwt [Auto]

Configuration options: [Auto] [2] [3] [4] [5] [6] [7] [8]

Twtr [Auto]

Configuration options: [Auto] [1] [2] [3]

Trtp [Auto]

Configuration options: [Auto] [2/4] [3/5]

Twrrd [Auto]

Configuration options: [Auto] [0] [1] [2] [3]

Twrrr [Auto]

Configuration options: [Auto] [1] [2] [3]

Trdrd [Auto]

Configuration options: [Auto] [2] [3] [4] [5]

Tref [Auto]

Configuration options: [Auto] [7.8 us] [3.9 us]

Trfc [Auto]

Configuration options: [Auto] [0] [1] [2] [3]

DRAM Termination [Auto]

Configuration options: [Auto] [Disabled] [75 ohms] [150 ohms] [50 ohms]

Dynamic Idle Cycle Counter [Auto]

Configuration options: [Auto] [Disabled] [Enabled]

Idle Cycle Limit [Auto]

Configuration options: [Auto] [16 cycles] [32 cycles] [64 cycles] [96 cycles]

DCQ Bypass Maximum [Auto]

Configuration options: [Auto] [0x] [1x] [2x] [3x] [4x] [5x] [6x]...[15x]

DRAM Burst Length [Auto]

Configuration options: [Auto] [64-byte] [32-byte]

DRAM Bank Interleaving [Enabled]

Configuration options: [Disabled] [Enabled]

Bank Swizzle Mode [Enabled]

Configuration options: [Disabled] [Enabled]

DRAM Timing Control

CKE Fine Delay [Auto]

Configuration options: [Auto] [No delay] [1/64 MEMCLK delay] [2/64 MEMCLK delay] [3/64 MEMCLK delay] [4/64 MEMCLK delay]...[31/64 MEMCLK delay]

CKE Setup Time [Auto]

Configuration options: [Auto] [1/2 MEMCLK] [1 MEMCLK]

CS/ODT Fine Delay [Auto]

Configuration options: [Auto] [No delay] [1/64 MEMCLK delay] [2/64 MEMCLK delay] [3/64 MEMCLK delay] [4/64 MEMCLK delay]...[31/64 MEMCLK delay]

CS/ODT Setup Time [Auto]

Configuration options: [Auto] [1/2 MEMCLK] [1 MEMCLK]

Address/Command Fine Delay [Auto]

Configuration options: [Auto] [No delay] [1/64 MEMCLK delay] [2/64 MEMCLK delay] [3/64 MEMCLK delay] [4/64 MEMCLK delay]...[31/64 MEMCLK delay]

Address/Command Setup Time [Auto]

Configuration options: [Auto] [1/2 MEMCLK] [1 MEMCLK]

Read DQS Timing Control [Auto]

Configuration options: [Auto] [no delay] [1/96 MEMCLK delay] [2/96 MEMCLK delay] [3/96 MEMCLK delay] [4/96 MEMCLK delay]...[47/96 MEMCLK delay]

Write Data Timing Control [Auto]

Configuration options: [Auto] [no delay] [1/96 MEMCLK delay] [2/96 MEMCLK delay] [3/96 MEMCLK delay] [4/96 MEMCLK delay]...[47/96 MEMCLK delay]

DQS Receiver Enable Timing [Auto]

Configuration options: [0 ps] [50 ps] [100 ps] [150 ps] [200 ps]...[8650 ps] [8700 ps]

Output Driver Control

CKE Drive Strength [Auto]

Configuration options: [Auto] [1.00x] [1.25x] [1.50x] [2.00x]

CS/ODT Drive Strength [Auto]

Configuration options: [Auto] [1.00x] [1.25x] [1.50x] [2.00x]

Add/CMD Drive Strength [Auto]

Configuration options: [Auto] [1.00x] [1.25x] [1.50x] [2.00x]

MEMCLK Drive Strength [Auto]

Configuration options: [Auto] [0.75x] [1.00x] [1.25x] [1.50x]

Data Drive Strength [Auto]

Configuration options: [Auto] [0.75x] [1.00x] [1.25x] [1.50x]

DQS Drive Strength [Auto]

Configuration options: [Auto] [0.75x] [1.00x] [1.25x] [1.50x]

DRAM Drivers Weak Mode [Auto]

Configuration options: [Auto] [Normal] [Weak]

AMD Virtualization [Enabled]

Enabling this functions allows hardware facilitated capacities for running several 386 virtual machines on the system simultaneously.

Configuration options: [Disabled] [Enabled]

AMD Live! [Disabled]

Enables or disables the AMD Live! technology.

Configuration options: [Disabled] [Enabled]

AMD Cool “n” Quiet Function [Disabled]

Enables the AMD Cool “n” Quiet technology which supports P-state transitions in AMD processors. Configuration options: [Disabled] [Enabled]

Cache Mapping Cycle [Auto]

Configuration options: [Auto] [Disabled] [Enabled]

4.4.4 Chipset

Phoenix-AwardBIOS CMOS Setup Utility	
Advanced	
Chipset	Select Menu
iGPU Frame Buffer Control [Auto]	Item Specific Help▶▶▶
x Frame Buffer Size 32M	
Onboard GPU [Auto]	
K8<->NB HT Speed [Auto]	
K8<->NB HT Width [Auto]	
CPU Spread Spectrum [Disabled]	
PCIE Spread Spectrum [Disabled]	
SATA Spread Spectrum [Down Spread]	
Primary Display Adapter [PCI-E]	

iGPU Frame Buffer Control [Auto]

Configuration options: [Auto] [Manual]

Frame Buffer Size [32M]

Configuration options: [16M] [32M] [64M] [128M] [256M] [512M]

Onboard GPU [Auto]

Setting this item to [Auto] will disable onboard GPU and frame buffer if system detects any external graphics card.

Configuration options: [Auto] [Always Enable]

K8<->NB HT Speed [Auto]

Configuration options: [Auto] [200 MHz] [400 MHz] [600 MHz] [800 MHz] [1 GHz]



If you are using an AM2+ CPU, the configuration options will be as follows:
[Auto] [200 MHz] [400 MHz] [600 MHz] [800 MHz] [1 GHz] [1.2 GHz]...[2.6GHz]

K8<->NB HT Width [Auto]

Configuration options: [8,8] [16,16] [Auto]

CPU Spread Spectrum [Disabled]

Configuration options: [Disabled] [Enabled]

PCIE Spread Spectrum [Disabled]

Configuration options: [Disabled] [Enabled]

SATA Spread Spectrum [Down Spread]

Configuration options: [Disabled] [Down Spread]

Primary Display Adapter [Disabled]

Allows you to select which graphics controller to use as the primary boot device.

Configuration options: [PCI] [Onboard] [PCI-E]

4.4.5 PCIPnP

Phoenix-AwardBIOS CMOS Setup Utility	
Advanced	
PCIPnP	Select Menu
Plug & Play O/S [No]	Item Specific Help▶▶
Resources Controlled By [Auto]	Select Yes if you are using a Plug and Play capable operating system. Select No if you need the BIOS to configure non-boot devices.
x IRQ Resources	
** PCI Express relative items **	
Maximum payload Size [4096]	

Plug & Play O/S [No]

When set to [No], the BIOS configures all the devices in the system. When set to [Yes] and if you install a Plug and Play operating system, the operating system configures the Plug and Play devices not required for boot.

Configuration options: [No] [Yes]

Resources Controlled By [Auto]

When set to [Auto], the BIOS automatically configures all the boot and Plug and Play compatible devices. Set to [Manual] if you want to assign the IRQ DMA and memory base address fields. Configuration options: [Auto] [Manual]



The item **IRQ Resources** becomes user-configurable when you set **Resources Controlled By** to [Manual].

IRQ Resources

Phoenix-Award BIOS CMOS Setup Utility	
Advanced	
IRQ Resources	Select Menu
IRQ-5 assigned to [PCI Device]	Item Specific Help▶▶
IRQ-7 assigned to [PCI Device]	Legacy ISA for devices compliant with the original PC AT bus specification, PCI/ISA PnP for devices compliant with the Plug and Play standard whether designed for PCI or ISA bus architecture.
IRQ-9 assigned to [PCI Device]	
IRQ-10 assigned to [PCI Device]	
IRQ-11 assigned to [PCI Device]	
IRQ-14 assigned to [PCI Device]	

IRQ-xx assigned to

When set to [PCI Device], the specific IRQ is free for use of PCI/PnP devices. When set to [Reserved], the IRQ is reserved for legacy ISA devices.

Configuration options: [PCI Device] [Reserved]

Maximum Payload Size [4096]

Sets maximum TLP payload size for the PCI Express devices.

Configuration options: [128] [256] [512] [1024] [2048] [4096]

4.4.6 Onboard Device Configuration

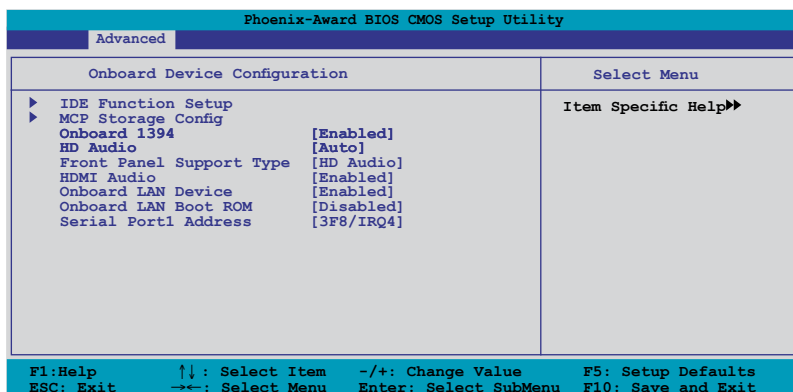

IDE Function Setup

This sub-menu contains IDE function-related items. Select an item then press <Enter> to edit.

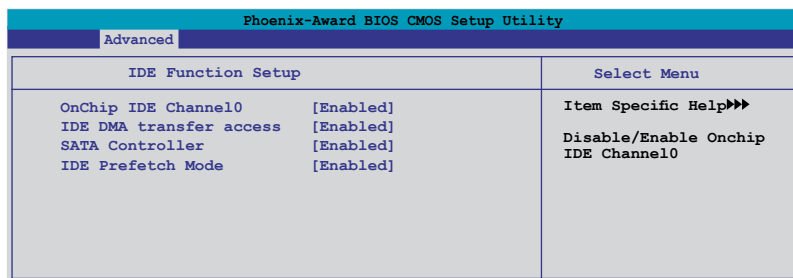

OnChip IDE Channel0 [Enabled]

Allows you to enable or disable the onchip IDE channel 0 controller .
Configuration options: [Disabled] [Enabled]

IDE DMA transfer access [Enabled]

Allows you to enable or disable the IDE DMA transfer access.
Configuration options: [Disabled] [Enabled]

SATA Controller [Enabled]

Allows you to enable or disable the SATA controller.
Configuration options: [Disabled] [Enabled]

IDE Prefetch Mode [Enabled]

Allows you to enable or disable the IDE PIO read prefetch mode.
Configuration options: [Disabled] [Enabled]

MCP Storage Config

This sub-menu allows you to change Serial ATA settings. Select an item then press <Enter> to edit.

Phoenix-Award BIOS CMOS Setup Utility		
Advanced		
MCP Storage Config		Select Menu
SATA Operation Mode	[IDE]	Item Specific Help▶▶▶

SATA Operation Mode [IDE]

Sets the configuration for the Serial ATA connectors supported by the Southbridge chip. Configuration options: [IDE] [RAID] [AHCI]

The AHCI allows the onboard storage driver to enable advanced Serial ATA features that increases storage performance on random workloads by allowing the drive to internally optimize the order of commands.

If you want to create a RAID 0, RAID 1, RAID 5, or RAID 10 configuration from the Serial ATA hard disk drives, set this item to [RAID].

If you want to use the Serial ATA hard disk drives as Parallel ATA physical storage devices, keep the default setting [IDE].

If you want the Serial ATA hard disk drives to use the Advanced Host Controller Interface (AHCI), set this item to [AHCI].



SATA 5–6 connectors support AHCI mode and RAID mode only. Make sure to install the AHCI driver or RAID driver in the bundled support DVD before connecting devices to SATA 5–6 connectors. Otherwise, the devices will not work.

Onboard 1394 [Enabled]

Allows you to enable or disable the onboard 1394 device support.

Configuration options: [Disabled] [Enabled]

HD Audio [Enabled]

Allows you to disable or set the High-Definition audio function.

Configuration options: [Enabled] [Disabled]

Front Panel Support Type [HD Audio]

Allows you to set the front panel audio connector (AAFP) mode to legacy AC'97 or high-definition audio depending on the audio standard that the front panel audio module supports. Configuration options: [AC97] [HD Audio]

HDMI Audio [Auto]

Allows you to disable or set the HDMI audio function.

Configuration options: [Disabled] [Enabled]

Onboard LAN Device [Enabled]

Enables or disables the onboard NVIDIA® LAN controller.

Configuration options: [Disabled] [Enabled]

Onboard LAN Boot ROM [Disabled]

Allows you to enable or disable the onboard LAN boot ROM.

Configuration options: [Enabled] [Disabled]

Serial Port1 Address [3F8/IRQ4]

Allows you to select the Serial Port1 base address.

Configuration options: [Disabled] [3F8/IRQ4] [2F8/IRQ3] [3E8/IRQ4] [2E8/IRQ3] [Auto]

4.4.7 USB Configuration

The items in this menu allows you to change the USB-related features. Select an item then press <Enter> to display the configuration options.

Phoenix-Award BIOS CMOS Setup Utility	
Advanced	
USB Configuration	Select Menu
USB Controller [Enabled]	Item Specific Help▶▶▶
USB2.0 Controller [Enabled]	Enable or Disable USB
USB Legacy support [Enabled]	1.1 and 2.0 Controller

USB Controller [Enabled]

Allows you to enable or disable the onchip USB controller.

Configuration options: [Disabled] [Enabled]

USB 2.0 Controller [Enabled]

Allows you to enable or disable the USB 2.0 controller.

Configuration options: [Disabled] [Enabled]

USB Legacy Support [Enabled]

Allows you to enable or disable support for USB devices on legacy operating systems (OS). Configuration options: [Disabled] [Enabled]

4.5 Power menu

The Power menu items allow you to change the settings for the Advanced Configuration and Power Interface (ACPI) and the Advanced Power Management (APM). Select an item then press <Enter> to display the configuration options.

Phoenix-Award BIOS CMOS Setup Utility			
Main	Advanced	Power	Boot Tools Exit
ACPI Suspend Type [S1&S3] ▶ APM Configuration ▶ Hardware Monitor		Select Menu Item Specific Help▶▶ Select the ACPI state used for System Suspend.	
F1: Help	↑↓: Select Item	-/+ : Change Value	F5: Setup Defaults
ESC: Exit	→←: Select Menu	Enter: Select SubMenu	F10: Save and Exit

4.5.1 ACPI Suspend Type [S1&S3]

Allows you to select the Advanced Configuration and Power Interface (ACPI) state to be used for system suspend.

Configuration options: [S1 (POS)] [S3(STR)] [S1&S3]

4.5.2 APM Configuration

Phoenix-Award BIOS CMOS Setup Utility			
Power			
APM Configuration		Select Menu	
Restore on AC Power Loss	[Power-Off]	Item Specific Help▶▶ Press [Enter] to select whether or not to restart the system after AC power loss	
PWR Button < 4 secs	[Instant-Off]		
Power On By PCI/PCIE Devices	[Disabled]		
Power On By External Modems	[Disabled]		
Power On by RTC Alarm	[Disabled]		
x Date(of Month) Alarm	0		
x Alarm Time (hh:mm)	0 : 0 : 0		
HPET Support	[Enabled]		
Power Up By PS/2 Keyboard	[Disabled]		
F1: Help	↑↓: Select Item		
ESC: Exit	→←: Select Menu	Enter: Select SubMenu	F10: Save and Exit

Restore on AC Power Loss [Power-Off]

Allows you to enable or disable the Restore on AC Power Loss function.

Configuration options: [Power-Off] [Power-On] [Last State]

PWR Button < 4 secs [Instant-Off]

When set to [Instant-Off], the system goes into Soft-off mode after you press the power button for less than 4 seconds. When set to [Suspend], the system goes into Suspend mode after you press the power button for less than 4 seconds. Configuration options: [Suspend] [Instant-Off]

Power On By PCI/PCIE Devices [Disabled]

Allows you to enable or disable the PME to wake up from S5 by PCI/PCIE devices and the NVIDIA® onboard LAN. Configuration options: [Disabled] [Enabled]

Power On By External Modem [Disabled]

This allows either settings of [Enabled] or [Disabled] for powering up the computer when the external modem receives a call while the computer is in Soft-off mode. Configuration options: [Disabled] [Enabled]



The computer cannot receive or transmit data until the computer and applications are fully running. Thus, connection cannot be made on the first try. Turning an external modem off and then back on while the computer is off causes an initialization string that turns the system power on.

Power On By RTC Alarm [Disabled]

Allows you to enable or disable RTC to generate a wake event. When this item is set to [Enabled], the items **Date (of Month) Alarm** and **Alarm Time (hh:mm)** become user-configurable with set values. Configuration options: [Disabled] [Enabled]

Date (of Month) Alarm [XX]

To set the date of alarm, highlight this item and press <Enter> to display the Date (of Month) Alarm pop-up menu. Key-in a value within the specified range then press <Enter>. Value '0' means everyday. Configuration options: [Min=0] [Max=31]

Alarm Time (hh:mm) [XX: XX: XX]

To set the time of alarm, highlight this item and press <Enter> to display the Alarm Time pop-up menu. Key-in a value within the specified range then press <Enter>. Configuration options: [Min=0] [Max=23]---hour
[Min=0] [Max=59]---minute
[Min=0] [Max=59]---second

HPET Support [Enabled]

The hardware high precision efficient timer (HPET) is to increase the performance of the Vista Multimedia player and can meet Vista's requirement. Disable this feature if your system is running under XP environment. Configuration options: [Disabled] [Enabled]

Power Up By PS/2 Keyboard [Disabled]

Allows you to disable the Power On by PS/2 keyboard function or set specific keys on the PS/2 keyboard to turn on the system. This feature requires an ATX power supply that provides at least 1A on the +5VSB lead.

Configuration options: [Disabled] [Space Bar] [Ctrl-ESC] [Power Key]

4.5.3 Hardware Monitor

The items in this sub-menu displays the hardware monitor values automatically detected by the BIOS. It also allows you to change CPU Q-Fan feature-related parameters. Select an item then press <Enter> to display the configuration options.

Phoenix-Award BIOS CMOS Setup Utility		
Power		
Hardware Monitor		Select Menu
CPU Fan Type	[DC]	Item Specific Help▶▶
CPU Q-Fan Control	[Disabled]	
x CPU Q-Fan Profile	Performance	Press [Enter] to enable or disable
Chassis Q-Fan Control	[Disabled]	
x Chassis Q-Fan Profile	Performance	
Vcore Voltage	[1.34V]	
3.3V Voltage	[3.20V]	
5V Voltage	[4.83V]	
12V Voltage	[11.52V]	
CPU Temperature	48°C	
M/B Temperature	36°C	
CPU Fan Speed	1464 RPM	
CHA_FAN1 Speed	0 RPM	
CHA_FAN2 Speed	0 RPM	
FWR_FAN Speed	0 RPM	
CPU Fan Speed Warning	[800 RPM]	

F1: Help ↑↓: Select Item ~/+: Change Value F5: Setup Defaults
ESC: Exit →←: Select Menu Enter: Select SubMenu F10: Save and Exit

CPU Fan Type [DC]

Allows you to select the CPU fan type.

Configuration options: [DC] [PWM]

CPU Q-Fan Control [Enabled]

Allows you to enable or disable the CPU Q-Fan controller.

Configuration options: [Disabled] [Enabled]



The **CPU Fan Profile** item becomes user-configurable when you enable the CPU Q-Fan Control feature.

CPU Q-Fan Profile [Performance]

Allows you to set the appropriate performance level of the CPU Q-Fan. When set to [Optimal], the CPU fan automatically adjusts depending on the CPU temperature. Set this item to [Silent Mode] to minimize fan speed for quiet CPU fan operation, or [Performance Mode] to achieve maximum CPU fan speed.

Configuration options: [Performance] [Optimal] [Silent]

Chassis Q-Fan Control [Enabled]

Allows you to enable or disable the Chassis Q-fan.

Configuration options: [Disabled] [Enabled]



The **Chassis Q-Fan Profile** item becomes user-configurable when you enable the Chassis Q-Fan Control feature.

Chassis Q-Fan Profile [Performance]

Allows you to set the appropriate performance level of the Chassis Q-Fan.

Configuration options: [Performance] [Optimal] [Silent]

Vcore Voltage, 3.3V Voltage, 5V Voltage, 12V Voltage

The onboard hardware monitor automatically detects the voltage output through the onboard voltage regulators. Select [Ignored] if you do not want to detect this item.

CPU Temperature [xxx°C/xxx°F]

M/B Temperature [xxx°C/xxx°F]

The onboard hardware monitor automatically detects and displays the motherboard and CPU temperatures. Select [Ignored] if you do not wish to display the detected temperatures.

CPU Fan Speed [xxxxRPM]

CHA_FAN 1/2 Speed [xxxxRPM]

PWR_FAN Speed [xxxxRPM]

The onboard hardware monitor automatically detects and displays the CPU/Chassis/Power fan speed in rotations per minute (RPM). If the fan is not connected to the motherboard, the field shows 0 RPM.

CPU Fan Speed warning [800 RPM]

Allows you to set the CPU fan warning speed function, which gives off a warning when the CPU fan speed is too low. If you set this item to [Disabled], the system will not warn you even if no fan is installed or if the fan is not functioning properly.

Configuration options: [Disabled] [800 RPM] [1200 RPM] [1600 RPM]

4.6 Boot menu

The Boot menu items allow you to change the system boot options. Select an item then press <Enter> to display the sub-menu.

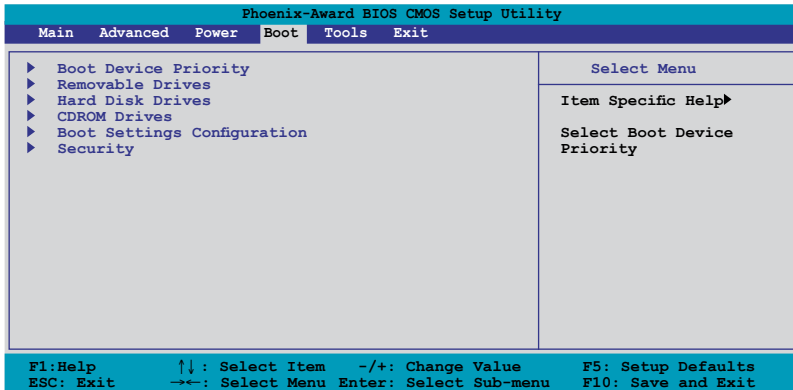

4.6.1 Boot Device Priority

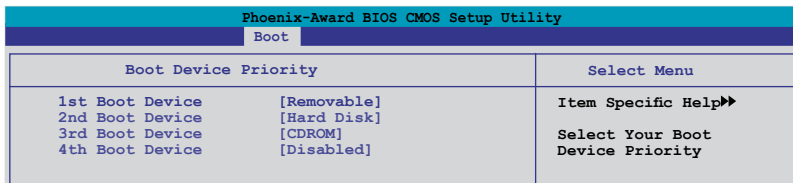

1st ~ 4th Boot Device [Removable]

These items specify the boot device priority sequence from the available devices. The number of device items that appears on the screen depends on the number of devices installed in the system.

Configuration options: [Removable] [Hard Disk] [CDROM] [Disabled]

4.6.2 Removable Drives

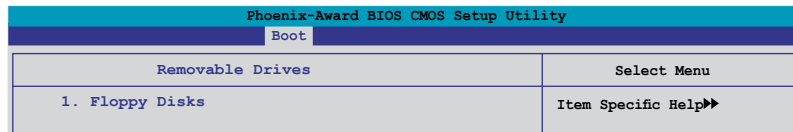

1. Floppy Disks

Allows you to assign a removable drive attached to the system.

4.6.3 Hard Disk Drives

Phoenix-Award BIOS CMOS Setup Utility	
Boot	
Hard Disk Drives	Select Menu
1. SATA X: XXXXXXXXX	Item Specific Help▶▶

1. SATA X: XXXXXXXXX

Allows you to assign hard disk drives attached to the system.

4.6.4 CDROM Drives

Phoenix-Award BIOS CMOS Setup Utility	
Boot	
CDROM Drives	Select Menu
1. 1st Slave: XXXXXXXXX	Item Specific Help▶▶

1. 1st Slave: XXXXXXXXX

Allows you to assign optical drives attached to the system.

4.6.5 Boot Settings Configuration

Phoenix-AwardBIOS CMOS Setup Utility		
Boot		
Boot Settings Configuration		Select Menu
Case Open Warning	[Enabled]	Item Specific Help▶▶ Press [Enter] to enable or disable.
Quick Boot	[Enabled]	
Boot Up Floppy Seek	[Disabled]	
Bootup Num-Lock	[On]	
Typematic Rate Setting	[Disabled]	
x Typematic Rate (Chars/Sec)	6	
x Typematic Delay (Msec)	250	
OS Select For DRAM > 64MB	[Non-OS2]	
Full Screen LOGO	[Enabled]	
Halt On	[All, But Keyboard]	
F1: Help ↑↓: Select Item ~/+: Change Value F5: Setup Defaults ESC: Exit ←→: Select Menu Enter: Select Sub-menu F10: Save and Exit		

Case Open Warning [Enabled]

Enables or disables the chassis open status feature. Setting to Enabled, clears the chassis open status. Refer to section “2.7.2 Internal connectors” for setting details. Configuration options: [Disabled] [Enabled]

Quick Boot [Enabled]

Allows you to enable or disable the system quick boot feature. When Enabled, the system skips certain tests while booting. Configuration options: [Disabled] [Enabled]

Boot Up Floppy Seek [Disabled]

Enables or disables the chassis open status feature. Setting to Enabled, clears the chassis open status. Configuration options: [Disabled] [Enabled]

Bootup Num-Lock [On]

Allows you to select the power-on state for the NumLock. Configuration options: [Off] [On]

Typematic Rate Setting [Disabled]

Allows you to set the keystroke rate. Enable this item to configure the Typematic Rate (Chars/Sec) and the Typematic Delay (Msec). Configuration options: [Disabled] [Enabled]



The items **Typematic Rate (Chars/Sec)** and **Typematic Delay (Msec)** become user-configurable only when the item **Typematic Rate Setting** is enabled.

Typematic Rate (Chars/Sec) [6]

Allows you to select the rate at which a character repeats when you hold a key. Configuration options: [6] [8] [10] [12] [15] [20] [24] [30]

Typematic Delay (Msec) [250]

Allows you to set the delay before keystrokes begin to repeat.

Configuration options: [250] [500] [750] [1000]

OS Select for DRAM > 64MB [Non-OS2]

Set this item to [OS2] only when you are running on an OS/2 operating system with an installed RAM of greater than 64 MB. Configuration options: [Non-OS2] [OS2]

Full Screen LOGO [Enabled]

Allows you to enable or disable the full screen logo display feature.

Configuration options: [Disabled] [Enabled]



Make sure that the above item is set to [Enabled] if you want to use the ASUS MyLogo 3 feature.

Halt On [All Errors]

Allows you to set the error report type.

Configuration options: [All Errors] [No Errors] [All, But Keyboard] [All, But Diskette] [All, But Disk/Key]

4.6.6 Security

Phoenix-Award BIOS CMOS Setup Utility		
Boot		
Security		Select Menu
Supervisor Password	Clear	Item Specific Help▶▶
User Password	Clear	
Password Check	[Setup]	

Supervisor Password

User Password

These fields allow you to set passwords:

To set a password:

1. Select an item then press <Enter>.
2. Type in a password using a combination of a maximum of eight (8) alpha-numeric characters, then press <Enter>.
3. When prompted, confirm the password by typing the exact characters again, then press <Enter>. The password field setting is changed to Set.

To clear the password:

1. Select the password field and press <Enter> twice. The following message appears:



2. Press any key to continue. The password field setting is changed to Clear.

A note about passwords

The Supervisor password is required to enter the BIOS Setup program preventing unauthorized access. The User password is required to boot the system preventing unauthorized use.

Forgot your password?

If you forget your password, you can clear it by erasing the CMOS Real Time Clock (RTC) RAM. The RAM data containing the password information is powered by the onboard button cell battery. If you need to erase the CMOS RAM, refer to section "2.6 Jumper" for instructions.

Password Check

This field requires you to enter the password before entering the BIOS setup or the system. Select [Setup] to require the password before entering the BIOS Setup.

Select [System] to require the password before entering the system.

Configuration options: [Setup] [System]

4.7 Tools menu

The Tools menu items allow you to configure options for special functions. Select an item then press <Enter> to display the sub-menu.

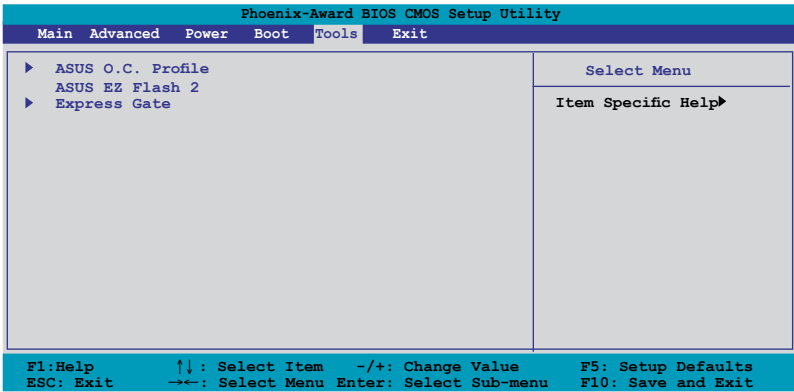

4.7.1 ASUS O.C. Profile

This item allows you to store or load multiple BIOS settings.

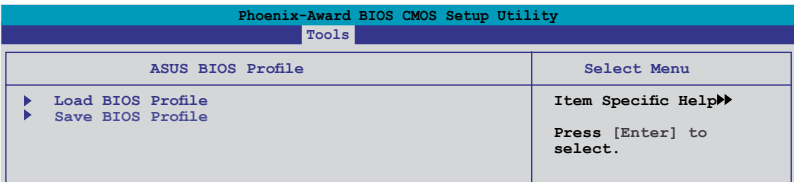

Load BIOS Profile

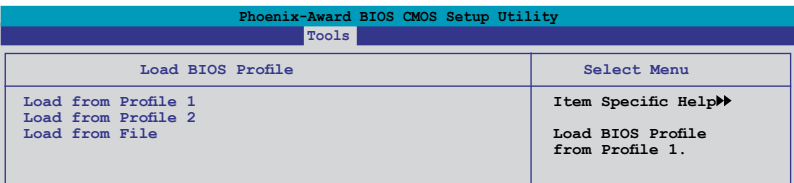

Load from Profile 1/2

Allows you to load the previous BIOS settings saved in the BIOS Flash. Press <Enter> to load the file.

Load from File

Allows you to load the previous BIOS file saved in the hard disk/floppy disk/USB flash disk with the FAT32/16/12 format. Follow the instructions below to load the BIOS file.

1. Insert the storage devices that contains the “xxx.CMO” file.
2. Turn on the system.
3. Enter BIOS setup program. Go to the “Tools” menu to select **ASUS O.C. Profile > Load from File**. Press <Enter> then the setup screen will appear.
4. Press <Tab> to switch between drives before the correct “xxx.CMO” file is found. Then press <Enter> to load the file.
5. A pop-up message will inform you when the loading process finishes.



- Suggest only to update the BIOS file coming from the same memory/CPU configuration and BIOS version.
- Only the “xxx.CMO” file can be loaded.

Save BIOS Profile

Phoenix-Award BIOS CMOS Setup Utility	
Tools	
Save BIOS Profile	Select Menu
Save to Profile 1 Save to Profile 2 Save to File	Item Specific Help▶▶ Save current BIOS Profile to Profile 1.

Save to Profile 1/2

Allows you to save the current BIOS file to the BIOS Flash. Press <Enter> to save the file.

Save to File

Allows you to save the current BIOS file to the hard disk/floppy disk/USB flash disk with FAT32/16/12 format. Follow the instructions below to save the BIOS file.

1. Insert the storage devices with enough space.
2. Turn on the system.
3. Enter the BIOS setup program. Go to the “Tools” menu to select “Save to File.” Press <Enter> then the setup screen will appear.
4. Press <Tab> to switch between the drives. Press hot-key <S> to save the file.
5. Key in the file name. Then press <Enter>.
6. A pop-up message will inform you when the saving process finishes.

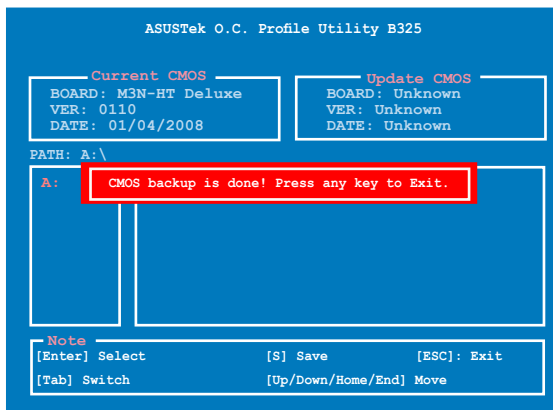

The BIOS file will be saved as "xxx.CMO".

4.7.2 ASUS EZ Flash 2

Allows you to run ASUS EZ Flash 2. When you press <Enter>, a confirmation message appears. Use the left/right arrow key to select between [Yes] or [No], then press <Enter> to confirm your choice.

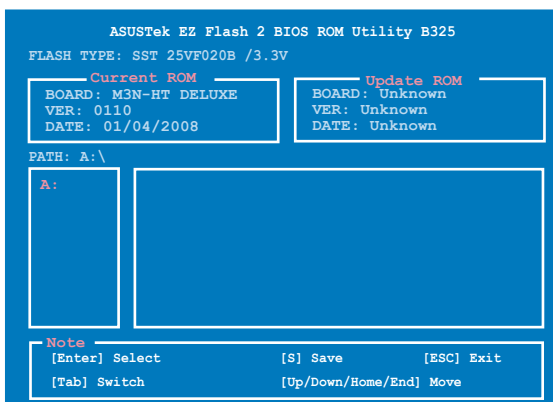

4.7.3 ASUS Express Gate

This item allows you to configure related ASUS Express Gate settings.

Phoenix-Award BIOS CMOS Setup Utility		
Tools		
ASUS Express Gate		Select Menu
Express Gate	[Enabled]	Item Specific Help▶▶
Enter OS Timer	[10 Seconds]	
Reset User Data	[No]	

Express Gate [Enabled]

Allows you to enable or disable the ASUS Express Gate feature. The ASUS Express Gate feature is a unique instant-on environment that provides quick access to the Internet browser and Skype. Refer to **section 5.3.12** for details.

Configuration options: [Enabled] [Disabled]

Enter OS Timer [10 Seconds]

Sets the amount of time the system waits at the Express Gate's first screen before starting Windows or other installed OS. Set this item to [Prompt User] to stay at the first screen of the Express Gate for user action.

Configuration options: [Prompt User] [1 second] [3 second] [5 second] [10 second] [15 second] [20 second] [30 seconds]

Reset User Data [No]

Allows you to clear Express Gate's user data.

Configuration options: [No] [Reset]

When set to [Reset], the user data will be cleared and this item will return to the default setting. Set to [No] to keep the user data and personal information you have saved under the Express Gate.



The first time wizard will run again when you enter the Express Gate environment after clearing its settings.

4.8 Exit menu

The Exit menu items allow you to load the optimal or failsafe default values for the BIOS items, and save or discard your changes to the BIOS items.

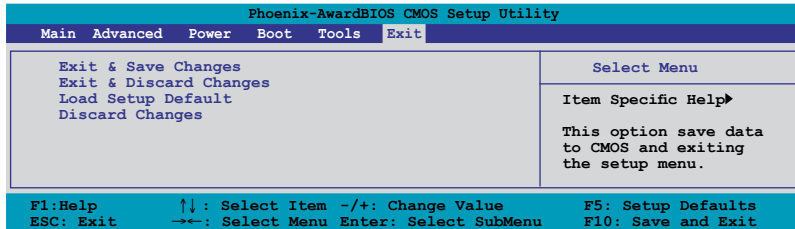

Pressing <Esc> does not immediately exit this menu. Select one of the options from this menu or <F10> from the legend bar to exit.

Exit & Save Changes

Once you are finished making your selections, choose this option from the Exit menu to ensure the values you selected are saved to the CMOS RAM. An onboard backup battery sustains the CMOS RAM so it stays on even when the PC is turned off. When you select this option, a confirmation window appears. Select **YES** to save changes and exit.



If you attempt to exit the Setup program without saving your changes, the program prompts you with a message asking if you want to save your changes before exiting. Press <Enter> to save the changes while exiting.

Exit & Discard Changes

Select this option only if you do not want to save the changes that you made to the Setup program. If you made changes to fields other than System Date, System Time, and Password, the BIOS asks for a confirmation before exiting.

Load Setup Default

This option allows you to load the default values for each of the parameters on the Setup menus. When you select this option or if you press <F5>, a confirmation window appears. Select **YES** to load default values. Select Exit & Save Changes or make other changes before saving the values to the non-volatile RAM.

Discard Changes

This option allows you to discard the selections you made and restore the previously saved values. After selecting this option, a confirmation appears. Select **YES** to discard any changes and load the previously saved values.

This chapter describes the contents of the support DVD that comes with the motherboard package.

5 Software support

5.1	Installing an operating system	5-1
5.2	Support DVD information	5-1
5.3	Software informtion	5-9
5.4	RAID configurations	5-41
5.5	Creating a RAID driver disk.....	5-49

5.1 Installing an operating system

This motherboard supports Windows® XP / Vista operating systems (OS). Always install the latest OS version and corresponding updates to maximize the features of your hardware.



- Motherboard settings and hardware options vary. Use the setup procedures presented in this chapter for reference only. Refer to your OS documentation for detailed information.
- Make sure that you install Windows® XP Service Pack 2 or later versions before installing the drivers for better compatibility and system stability.

5.2 Support DVD information

The support DVD that came with the motherboard package contains the drivers, software applications, and utilities that you can install to avail all motherboard features.



The contents of the support DVD are subject to change at any time without notice. Visit the ASUS website(www.asus.com) for updates.

5.2.1 Running the support DVD

Place the support DVD to the optical drive. The DVD automatically displays the Drivers menu if Autorun is enabled in your computer.



Click an icon to display support DVD/motherboard information

Click an item to install



If Autorun is NOT enabled in your computer, browse the contents of the support DVD to locate the file ASSETUP.EXE from the BIN folder. Double-click the ASSETUP.EXE to run the DVD.

5.2.2 Drivers menu

The drivers menu shows the available device drivers if the system detects installed devices. Install the necessary drivers to activate the devices.



ASUS InstAll - Installation Wizard for Drivers

Installs all of the drivers through the installation wizard.

NVIDIA Chipset Program Driver

Installs the NVIDIA® chipset drivers for the NVIDIA® nForce 780a SLI chipset.

AMD Cool 'n' Quiet Driver

Installs the AMD® Cool 'n' Quiet™ technology driver.

USB 2.0 Driver

Installs the Universal Serial Bus 2.0 (USB 2.0) driver.

5.2.3 Utilities menu

The Utilities menu shows the applications and other software that the motherboard supports.



Click to display the next screen



Click to display the previous screen

ASUS InstAll - Installation Wizard for Utilities

Installs all of the utilities through the installation wizard.

ASUS PC Probe II

This smart utility monitors the fan speed, CPU temperature, and system voltages, and alerts you of any detected problems. This utility helps you keep your computer in healthy operating condition.

ASUS AI Suite

Installs the ASUS AI Suite.

ASUS Update

The ASUS Update utility allows you to update the motherboard BIOS in Windows® environment. This utility requires an Internet connection either through a network or an Internet Service Provider (ISP).



Before using the ASUS Update, make sure that you have an Internet connection so that you can connect to the ASUS website.

ASUS Cool 'n' Quiet Utility

Installs the ASUS Cool 'n' Quiet™ software.

ASUS Express Gate Updater

Installs the ASUS Express Gate™ update application.

Adobe Reader V7.0

Installs the Adobe® Acrobat® Reader that allows you to open, view, and print documents in Portable Document Format (PDF).

Microsoft DirectX 9.0c

Installs the Microsoft® DirectX 9.0c driver. The Microsoft DirectX® 9.0c is a multimedia technology that enhances computer graphics and sound. DirectX® improves the multimedia features of your computer so you can enjoy watching TV and movies, capturing videos, or playing games in your computer. Visit the Microsoft website (www.microsoft.com) for updates.

Anti-Virus Utility

The anti-virus application scans, identifies, and removes computer viruses. View the online help for detailed information.

WinDVD Copy5 Trial

Installs the WinDVD Copy5 Trial version.

InterVideo MediaOne Gallery

Installs the InterVideo MediaOne Gallery software.

Ulead PhotoImpact 12 SE

Installs the Ulead PhotoImpact 12 SE software.

CyberLink PowerBackup

Installs the CyberLink PowerBackup software.

Corel Snapfire Plus SE

Installs the Corel Snapfire Plus SE software.

5.2.4 Make Disk menu

The Make Disk menu contains items to create the NVIDIA® nForce 780a SLI SATA/RAID driver disk.



NVIDIA 32bit/64bit XP SATA RAID Driver

Allows you to create an NVIDIA SATA RAID driver disk for Windows®XP.

NVIDIA 32bit/64bit XP AHCI Driver

Allows you to create an NVIDIA AHCI driver disk for Windows®XP.



Due to floppy disk capacity limitation, when creating a RAID configuration under Windows® Vista, install the AHCI/RAID driver through the motherboard support CD/DVD or a USB device.

Find RAID driver in the support CD/DVD through the path below:

Drivers\Chipset\Disk\RAID

Find AHCI driver in the support CD/DVD through the path below:

Drivers\Chipset\Disk\AHCI

5.2.5 Manual menu

The Manual menu contains a list of supplementary user manuals. Click an item to open the folder of the user manual.



Most user manual files are in Portable Document Format (PDF). Install the Adobe® Acrobat® Reader from the Utilities menu before opening a user manual file.



5.2.6 ASUS Contact information

Click the Contact tab to display the ASUS contact information. You can also find this information on the inside front cover of this user guide.



5.3 Software information

Most of the applications in the support DVD have wizards that will conveniently guide you through the installation. View the online help or readme file that came with the software application for more information.

5.3.1 ASUS MyLogo2™

The ASUS MyLogo2™ utility lets you customize the boot logo. The boot logo is the image that appears on screen during the Power-On Self-Tests (POST). The ASUS MyLogo2™ is automatically installed when you install the ASUS Update utility from the support DVD. See section “5.2.3 Utilities menu” for details.



- Before using the ASUS MyLogo2™, use the Award BIOS Flash utility to make a copy of your original BIOS file, or obtain the latest BIOS version from the ASUS website. See section 4.1.4 **Updating the BIOS**.
- Make sure that the BIOS item Full Screen Logo is set to [Enabled] if you wish to use ASUS MyLogo2. See section 4.6.5 **Boot Settings Configuration**.
- You can create your own boot logo image in GIF, or BMP file formats.
- The file size should be smaller than 150 K.

To launch the ASUS MyLogo2™:

1. Launch the ASUS Update utility. Refer to section “4.1.1 ASUS Update utility” for details.
2. Select **Options** from the drop down menu, then click **Next**.
3. Check the option **Launch MyLogo** to replace system boot logo before flashing BIOS, then click **Next**.
4. Select **Update BIOS** from a file from the drop down menu, then click **Next**.
5. When prompted, locate the new BIOS file, then click **Next**. The ASUS MyLogo window appears.
6. From the left window pane, select the folder that contains the image you intend to use as your boot logo.

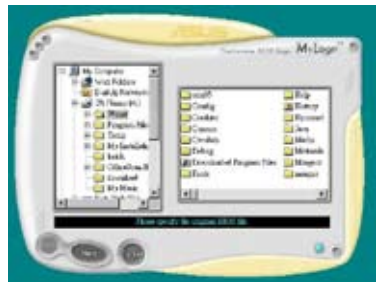

7. When the logo images appear on the right window pane, select an image to enlarge by clicking on it.

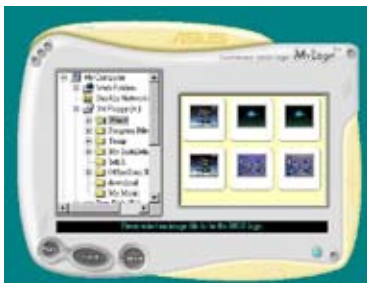

8. Adjust the boot image to your desired size by selecting a value on the Ratio box.



9. When the screen returns to the ASUS Update utility, flash the original BIOS to load the new boot logo.
10. After flashing the BIOS, restart the computer to display the new boot logo during POST.

5.3.2 Cool 'n' Quiet!™ Technology

The motherboard supports the AMD Cool 'n' Quiet!™ Technology that dynamically and automatically change the CPU speed, voltage, and amount of power depending on the task the CPU performs.

Enabling Cool 'n' Quiet!™ Technology

To enable Cool 'n' Quiet!™ Technology:

1. Turn on the system and enter BIOS by pressing the key during the Power On Self-Tests (POST).
2. Go to **Advanced > CPU Configuration > AMD Cool 'n'Quiet function** and set it to [Enabled]. See section “4.4 Advanced Menu.”
3. Save your changes and exit BIOS Setup.
4. Reboot your computer and set your Power Option Properties depending on your operating system.

Windows® 2000/XP

1. From the Windows® 2000/XP operating system, click **Start**. Select **Settings > Control Panel**.
2. Make sure the Control Panel is set to Classic View.
3. Double-click the **Display** icon in the Control Panel then select the Screen Saver tab.
4. Click the **Power** button. The following dialogue box appears.
5. From the Power schemes combo list box, select **Minimal Power Management**.
6. Click **OK** to effect settings.

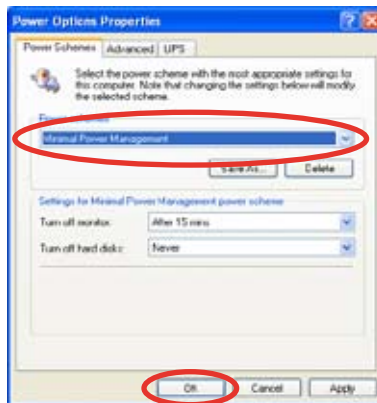



- Make sure to install the AMD Cool 'n' Quiet!™ driver and application before using this feature.
- The AMD Cool 'n' Quiet!™ technology feature works only with the AMD heatsink and fan assembly with monitor chip
- If you purchased a separate heatsink and fan package, use the ASUS Q-Fan technology feature to automatically adjust the CPU fan speed according to your system loading.

Launching the Cool 'n' Quiet!™ software

The motherboard support DVD includes the Cool 'n' Quiet!™ software that enables you to view your system's real-time CPU Frequency and voltage.



Make sure to install the Cool 'n' Quiet!™ software from the motherboard support DVD. Refer to section **5.2.3 Utilities menu** for details.

To launch the Cool 'n' Quiet!™ program:

1. If you are using Windows® 2000, click the Start button. Select **Programs > ASUS > Cool & Quiet > Cool & Quiet**.
2. If you are using Windows® XP, click the Start button. Select **All Programs > ASUS > Cool & Quiet > Cool & Quiet**.
3. The Cool 'n' Quiet!™ technology screen appears and displays the current CPU Frequency and CPU Voltage.

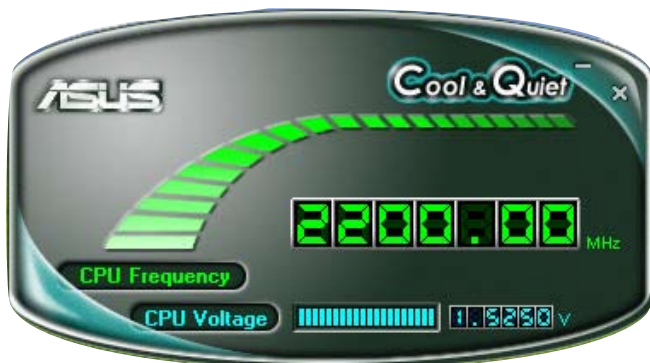

5.3.3 AI Audio 2 (SoundMAX® High Definition Audio utility)

The ADI AD1988 High Definition Audio CODEC provides 8-channel audio capability through the SoundMAX® audio utility with AudioESP™ software to deliver the ultimate audio experience on your PC. The software implements high quality audio synthesis/rendering, 3D sound positioning, and advanced voice-input technologies.

Follow the installation wizard to install the ADI AD1988 Audio Driver from the support DVD that comes with the motherboard package to activate the SoundMAX® audio utility.



You must use 4-channel, 6-channel or 8-channel speakers for this setup.

If the SoundMAX® audio utility is correctly installed, you will find the SoundMAX®/ SoundMAX® BlackHawk icon on the taskbar.



A. SoundMAX BlackHawk (AI Audio 2)

If you are using Windows Vista™ operating system, from the taskbar, double-click on the SoundMAX® BlackHawk icon to display the SoundMAX® control panel.



Enabling AI Audio 2

Click the power button  to activate digital signal processing. AI Audio 2, with the new SoundMAX® BlackHawk by Sonic Focus, brings you more multimedia enjoyment.

Fidelity Compensation

After you click the power button, the utility will compensate for the fidelity lost in the compression process and make the audio output quasi-original when reverting the compressed audio streams back to the uncompressed condition.

Sound Field Expansion

AI Audio 2 also expands the stereophonic sound field to a multi-channel one with realistic front and rear environment.

Surround Virtualization

Activating this function virtualizes surround sound with the vocal clarity added for use with stereo speakers or headphones.



SoundMAX BlackHawk (AI Audio2) is available only under the Windows® Vista™ operating system.

Playback Settings

To configure the playback settings, click the **Playback** button on the control panel. You can adjust the volume of the **Speakers** and **SPDIF Interface** or mute the audio.

Preset settings

Click and expand the drop-down menu to select your preferred Digital Signal Processing (DSP) preset. Move the sliders to customize the values of **Voice Clarity**, **Dynamics**, **Brilliance**, and **Deep Bass** of each preset. Click Save to save the changes to the current preset. Or, click **Reset** to discard the changes and restore the preset to the factory defaults.



Surround settings

Allows you to change the settings of the stereo speakers. Move the sliders to change the listener position or adjust the center channel volume. Press the **Test Speakers** button to perform speaker test.



Port settings

Click this port settings tab to display the rear panel ports configuration for the speakers or rear panel digital port configuration for the SPDIF interface.



Recording Settings

To change the recording settings, click the **Recording** button on the control panel. You can adjust the speaker delay of **Microphone** or **Line In** by moving the slider rightward or leftward.

Record testing

Click the tab to perform test recording and play the test sample through the speakers or the SPDIF interface.

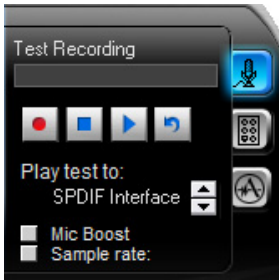

Port settings

Click the tab to display the rear panel ports for Microphone or Line In.



ANDREA settings

Allows you to select an enhanced microphone input features, including **No Filtering**, **Speakerphone**, **Voice Recording**, and **Directional Beam**.



More Settings

Click  for the further configurations.

Equalizer

Allows you to configure and customize all the DSP presets frequencies.



Speakers

Allows you to adjust the **Speaker Trim** and **Speaker Delay**.



Bass

Allows you to do the Bass management.



Preferences

Displays the preference options for this utility, version information, AudioESP, etc.



B. SoundMAX

If you are using Windows XP operating system, from the taskbar, double-click on the SoundMAX® icon to display the SoundMAX® Control Panel.



Audio Setup Wizard

By clicking the  icon from the SoundMAX® control panel, you can easily configure your audio settings. Simply follow the succeeding screen instructions and begin enjoying High Definition Audio.



Jack configuration

This screen helps you configure your computer's audio ports, depending on the audio devices you have installed.



Adjust speaker volume

This screen helps you adjust speaker volume. Click the **Test** button to hear the changes you have made.



Adjust microphone volume

This screen helps you adjust microphone volume. You will be asked to read pre-written text to allow the AudioWizard to adjust the volume as you speak.



Audio preferences



Click the  icon to go to the Preferences page. This page allows you to change various audio settings.

General options

Click the General tab to choose your playback and recording devices, enable/disable the AudioESP™ feature, and enable/disable digital output.

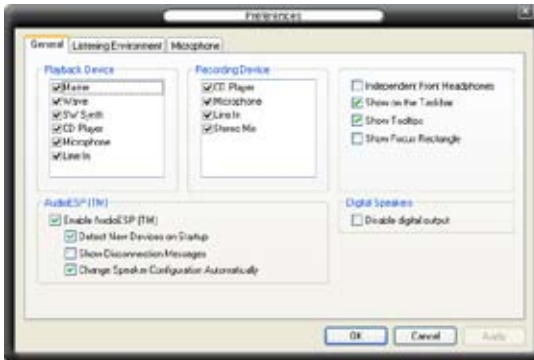

Listening Environment options

Click the Listening Environment tab to set up your speaker, acoustic environment, and enable/disable the Virtual Theater Surround function.

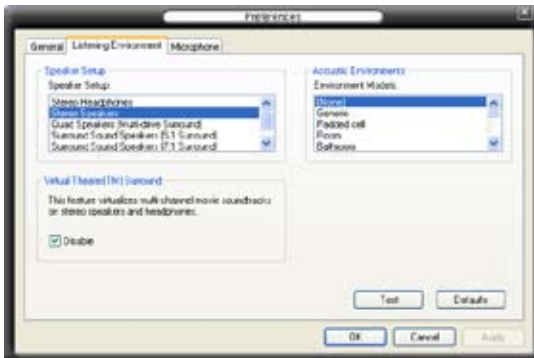

Microphone options

Click the Microphone tab allows you to optimize your microphone input settings.



Enhanced Microphone Features

Noise Filtering

Enables Noise Filter function. Detects repetitive and stationary noises like computer fans, air conditioners, and other background noises then eliminates it in the incoming audio stream while recording. You can enable it for a better recording quality.

Directional Array

Receives only the sound coming from the reception cone and eliminates interferences including neighboring speakers and reverberations. You can enable it to transit clearer sound during on-line games, MSN, or Skype.

Speaker Phone

Advanced de-reverberation techniques can help to reduce echo and minimize its effect on the speech engine. You can enable it when you have conference call to reduce echoes in the other side.



- The directional Array and Speaker Phone are purchased separately and function only when working with the ASUS Array Mic.
- If you are using Windows Vista, you have to manually enable the directional Array and Speaker Phone function. Go to **Control panel > Sound**. Click the **Recording** tab on the top and select **Microphone**. Click the **Microphone Enhancement** tab and check **Array Mic**.



5.3.4 ASUS PC Probe II

PC Probe II is a utility that monitors the computer's vital components, and detects and alerts you of any problem with these components. PC Probe II senses fan rotations, CPU temperature, and system voltages, among others. Because PC Probe II is software-based, you can start monitoring your computer the moment you turn it on. With this utility, you are assured that your computer is always at a healthy operating condition. Refer to page 1-9 for the OS that supports this utility.

Installing PC Probe II

To install PC Probe II on your computer:

1. Place the support DVD to the optical drive. The Drivers installation tab appears if your computer has an enabled Autorun feature.



If Autorun is not enabled in your computer, browse the contents of the support DVD to locate the setup.exe file from the ASUS PC Probe II folder. Double-click the **setup.exe** file to start installation.

2. Click the **Utilities** tab, then click **ASUS PC Probe II**.
3. Follow the screen instructions to complete installation.

Launching PC Probe II

You can launch the PC Probe II right after installation or anytime from the Windows® desktop.

To launch the PC Probe II from the Windows® desktop, click **Start > All Programs > ASUS > PC Probe II > PC Probe II v1.xx.xx**. The PC Probe II main window appears.

After launching the application, the PC Probe II icon appears in the Windows® taskbar. Click this icon to close or restore the application.









Using PC Probe II

Main window

The PC Probe II main window allows you to view the current status of your system and change the utility configuration. By default, the main window displays the Preference section. You can close or restore the Preference section by clicking on the triangle on the main window right handle.



Click to close the Preference panel

Button	Function
	Opens the Configuration window
	Opens the Report window
	Opens the Desktop Management Interface window
	Opens the Peripheral Component Interconnect window
	Opens the Windows Management Instrumentation window
	Opens the hard disk drive, memory, CPU usage window
	Shows/Hides the Preference section
	Minimizes the application
	Closes the application

Sensor alert

When a system sensor detects a problem, the main window right handle turns red, as the illustrations below show.



When displayed, the monitor panel for that sensor also turns red. Refer to the Monitor panels section for details.

Preference

You can customize the application using the Preference section in the main window. Click the box before each preference to activate or deactivate.

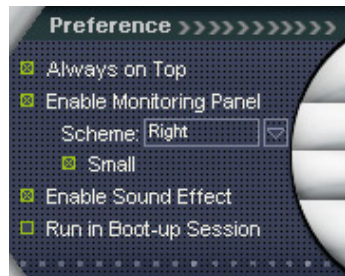

Hardware monitor panels

The hardware monitor panels display the current value of a system sensor such as fan rotation, CPU temperature, and voltages.

The hardware monitor panels come in two display modes: hexagonal (large) and rectangular (small). When you check the Enable Monitoring Panel option from the Preference section, the monitor panels appear on your computer's desktop.



Large display



Small display

Changing the monitor panels position

To change the position of the monitor panels in the desktop, click the arrow down button of the Scheme options, then select another position from the list box. Click OK when finished.



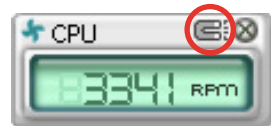

Moving the monitor panels

All monitor panels move together using a magnetic effect. If you want to detach a monitor panel from the group, click the horseshoe magnet icon. You can now move or reposition the panel independently.



Adjusting the sensor threshold value

You can adjust the sensor threshold value in the monitor panel by clicking the  or  buttons. You can also adjust the threshold values using the Config window.

You cannot adjust the sensor threshold values in a small monitoring panel.

Click to increase value

Click to decrease value



Monitoring sensor alert

The monitor panel turns red when a component value exceeds or is lower than the threshold value. Refer to the illustrations below.



Large display



Small display

WMI browser

Click **WMI** to display the WMI (Windows Management Instrumentation) browser. This browser displays various Windows® management information. Click an item from the left panel to display on the right panel. Click the plus sign (+) before WMI Information to display the available information.



You can enlarge or reduce the browser size by dragging the bottom right corner of the browser.

DMI browser

Click **DMI** to display the DMI (Desktop Management Interface) browser. This browser displays various desktop and system information. Click the plus sign (+) before DMI Information to display the available information.



PCI browser

Click **PCI** to display the PCI (Peripheral Component Interconnect) browser. This browser provides information on the PCI devices installed on your system. Click the plus sign (+) before the PCI Information item to display available information.

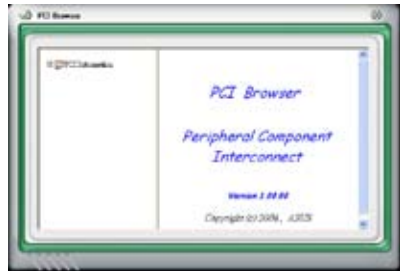

Usage

The Usage browser displays real-time information on the CPU, hard disk drive space, and memory usage. Click **USAGE** to display the Usage browser.

CPU usage

The CPU tab displays real-time CPU usage in line graph representation. If the CPU has an enabled Hyper-Threading, two separate line graphs display the operation of the two logical processors.



Hard disk drive space usage

The Hard Disk tab displays the used and available hard disk drive space. The left panel of the tab lists all logical drives. Click a hard disk drive to display the information on the right panel. The pie chart at the bottom of the window represents the used (blue) and the available HDD



Memory usage

The Memory tab shows both used and available physical memory. The pie chart at the bottom of the window represents the used (blue) and the available physical memory.



Configuring PC Probe II

Click **CONFIG** to view and adjust the sensor threshold values.

The Config window has two tabs: Sensor/Threshold and Preference. The Sensor/Threshold tab enables you to activate the sensors or to adjust the sensor threshold values. The Preference tab allows you to customize sensor alerts, or change the temperature scale.



Loads the default threshold values for each sensor

Applies your changes

Cancels or ignores your changes

Loads your saved configuration
 Saves your configuration

5.3.5 ASUS AI Suite

ASUS AI Suite allows you to launch AI Gear 2, AI N.O.S., AI Booster, AI Nap, and Q-Fan 2 utilities easily.

Installing AI Suite

To install AI Suite on your computer:

1. Place the support DVD to the optical drive. The Drivers installation tab appears if your computer has an enabled Autorun feature.
2. Click the Utilities tab, then click **AI Suite**.
3. Follow the screen instructions to complete installation.

Launching AI Suite

You can launch the AI Suite right after installation or anytime from the Windows® desktop.

To launch the AI Suite from the Windows® desktop, click **Start > All Programs > ASUS > AI Suite > AI Suite v1.xx.xx**. The AI Suite main window appears.

After launching the application, the AI Suite icon appears in the Windows® taskbar. Click this icon to close or restore the application.

Using AI Suite

Click the AI N.O.S., AI Gear 2, AI Nap, AI Booster, or Q-Fan 2 icon to launch the utility, or click the Normal icon to restore the system to normal state.

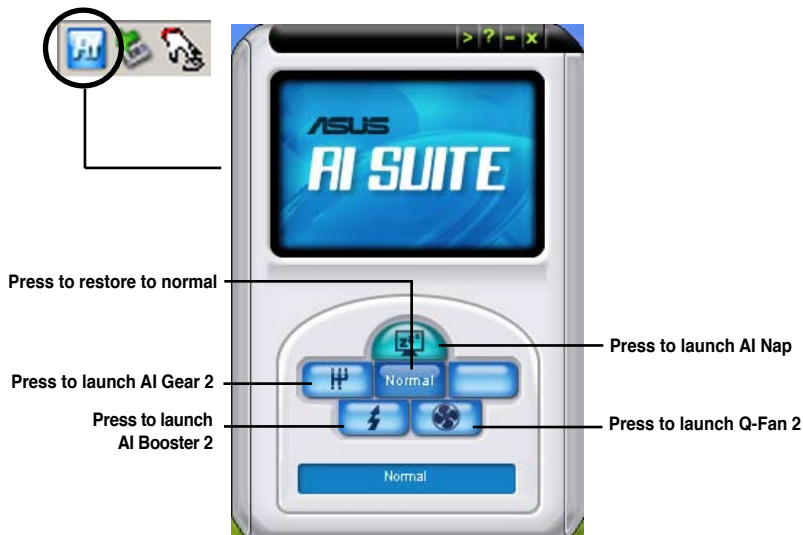

Other feature buttons

Click  on right corner of the main window to open the monitor window.

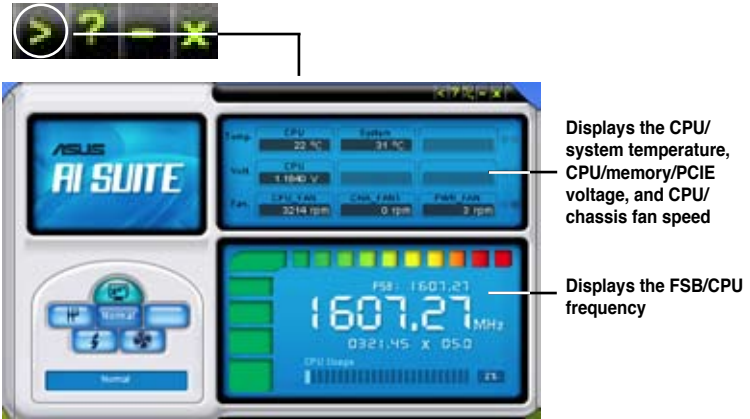

Click  on right corner of the expanded window to switch the temperature from degrees Centigrade to degrees Fahrenheit.



5.3.6 ASUS AI Gear 2

ASUS AI Gear 2 provides four system performance options that allows you to select the best performance setting for your computing needs. This easy-to-use utility adjusts the processor frequency and vCore voltage to minimize system noise and power consumption.

After installing AI Suite from the bundled support DVD, you can launch AI Gear 2 by double-clicking the AI Suite icon on your Windows OS taskbar and then click the AI Gear 2 button on the AI Suite main window.

Shift the gear to the performance setting that you like.

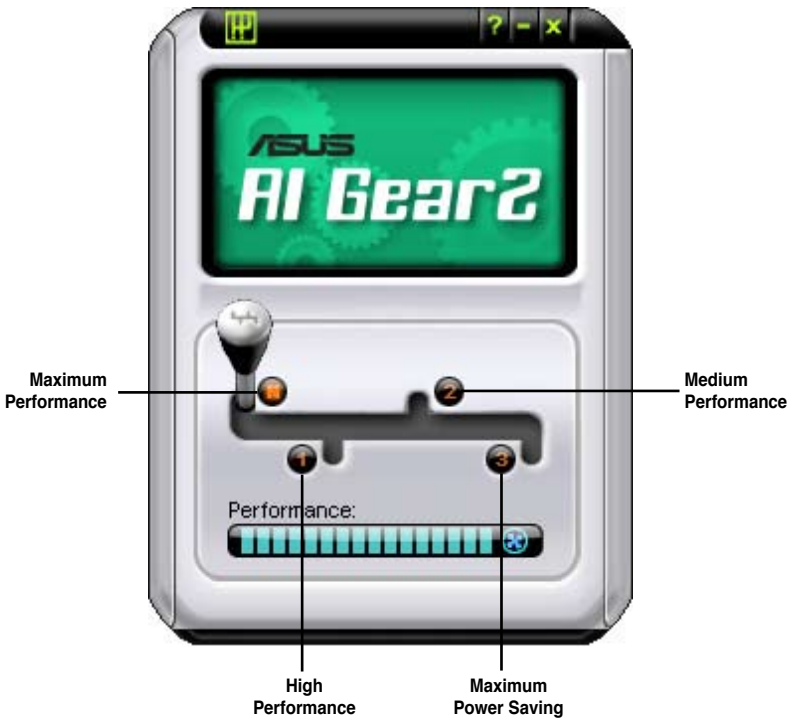

5.3.7 ASUS AI Nap

This feature allows you to minimize the power consumption of your computer whenever you are away. Enable this feature for minimum power consumption and a more quiet system operation.

After installing AI Suite from the bundled support DVD, you can launch the utility by double-clicking the AI Suite icon on the Windows OS taskbar and click the AI Nap button on the AI Suite main window.

Click **Yes** on the confirmation screen.

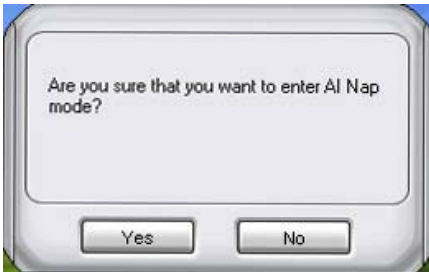

To exit AI Nap mode, press the system power or mouse button then click **Yes** on the confirmation screen.

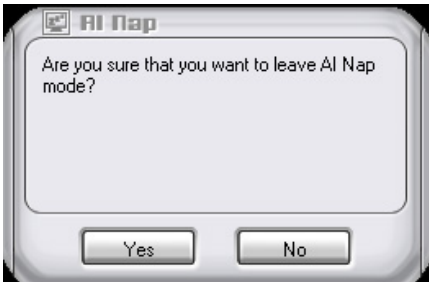

To switch the power button functions from AI Nap to shutting down, just right click the **AI Suite** icon on the OS taskbar, select **AI Nap** and click **Use power button**. Unclick the the item to switch the function back.

5.3.9 ASUS Q-Fan 2

This ASUS Q-Fan 2 Control feature allows you to set the appropriate performance level of the CPU Q-Fan 2 or the Chassis Q-Fan 2 for more efficient system operation. After enabling the Q-Fan 2 function, the fans can be set to automatically adjust depending on the temperature, to decrease fan speed, or to achieve the maximum fan speed.

After installing AI Suite from the bundled support DVD, you can launch the utility by double-clicking the AI Suite icon on the Windows® OS taskbar and click the Q-Fan 2 button on the AI Suite main window.

Click the drop-down menu button and display the fan names. Select **CPU Q-Fan 2** or **CHASSIS Q-Fan 2**. Click the box of **Enable Q-Fan 2** to activate this function.



Profile list appears after clicking the **Enable Q-Fan 2** box. Click the drop-down list button and select a profile. **Optimal** mode makes the fans adjust speed with the temperature; **Silent** mode minimizes fan speed for quiet fan operation; **Performance** mode boosts the fan to achieve maximal fan speed for the best cooling effect.

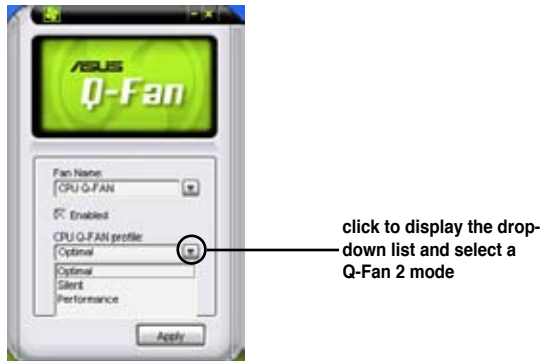

Click **Apply** at the bottom to save the setup.

5.3.10 ASUS AI Booster 2

The ASUS AI Booster 2 application allows you to overclock the CPU speed in Windows® environment without the hassle of booting the BIOS.

After installing AI Suite from the bundled support DVD, you can launch the utility by double-clicking the AI Suite icon on the Windows® OS taskbar and click the AI Booster 2 button on the AI Suite main window.

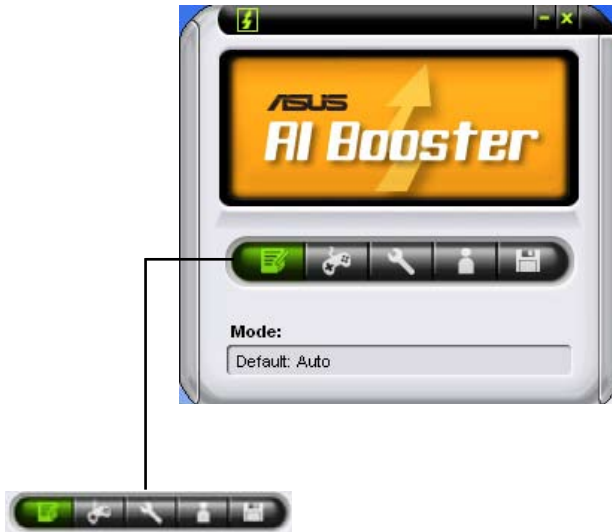

The options on the taskbar allow you to use the default settings, adjust CPU/ Memory/PCI-E frequency manually, or create and apply your personal overclocking configurations.

5.3.12 ASUS Express Gate

ASUS Express Gate is an instant-on environment that gives you quick access to web and Skype. Within a few seconds of powering on your computer, you will be at the Express Gate menu where you can start the web browser, Skype, or other Express Gate applications.



Express Gate is entirely self-contained on the motherboard, so you can use it at any time, even without a hard drive attached!

The First Screen

Express Gate's first screen appears within a few seconds after you power on. From here, you can immediately start the web browser or Skype.

You can also choose to continue booting normally (e.g. to your installed OS such as Windows), enter BIOS setup, or power off.

If you don't make any selection, Express Gate will automatically exit and boot to your normal OS after a certain amount of time. The timer countdown is shown on-screen inside the "boot to OS" button. As you move the mouse or type a key, the countdown stops and the timer disappears, so you can take your time to make a selection.

The Express Gate Environment

The very first time you enter the Express Gate environment (by launching either web or Skype from the first screen), a first time wizard will guide you through basic Express Gate configurations. Basic configurations include language, date and time and screen resolution.

Once inside the Express Gate environment, click on the icons on the LaunchBar, by default at bottom of the screen, to launch or switch between applications. You can re-arrange, re-size and move windows. Bring a window to the foreground by clicking within it or by clicking on its corresponding application icon. Re-size a window by dragging any of its four corners. Move a window by dragging its title bar.

Besides using the LaunchBar, you can also switch between applications by pressing <Alt> +<Tab> on the keyboard. You can also right-click anywhere on the desktop to bring up a menu of applications.

The red triangle on an application icon in the LaunchBar denotes that the application is already running. This means that you can switch to it without any delay. In the rare case where an application stops responding, right-click on its icon to force close it.

Configuration Panel

Use the configuration panel to change various Express Gate settings.



Click on an icon to open a particular configuration tool. The following tools are available:

Date and Time: set current date and time as well as time zone.

Input Method: choose your preferred input language and method.

Language and Keyboard: choose your language and keyboard preferences.

LaunchBar Setting: customize your LaunchBar (where it docks, whether it auto-hides, etc.)

Network Configuration

Specify how your computer connects to the Internet. Enable all the network ports that you may use (LAN1, LAN2, and/or wireless [optional]). LAN1 and LAN2 refer to the two RJ-45 network ports on your computer.





- The number of the LAN ports may differ from motherboards.
- You can connect the LAN cable to either port, and Express Gate will automatically use the connected port.

Also specify whether each port uses DHCP (most common) or static IP. For PPPoE and wireless (optional), set the login credentials (user name, password, SSID, etc.) as well.

Reset Express Gate

This function allows you to clear the Express Gate settings, as well as any personal information stored by the web browser (Bookmarks, Cookies, History, etc.). The user data will be reset to the original default configuration.

After you click Restore System, a confirmation dialog box will open. If you click “Yes” in the confirmation dialog box, your system will immediately restart and then re-enter Express Gate, in order to finish clearing the settings. This is also useful in the rare case where settings might become corrupted.



The first-time Wizard will run again when you enter the Express Gate environment after clearing its settings.

Screen Resolution

Choose the most optimal screen resolution for your display.



Volume Control

Control the volume for your speaker output, microphone input, etc.

LaunchBar

The LaunchBar has several system icons that show you various system statuses and let you configure individual Express Gate settings. The LaunchBar can be configured to auto-hide, if you want more screen space for the applications. It can also be configured to dock on any of the four sides of the screen.



This icon tells you whether or not a removable USB device is inserted into the system. If a USB device is detected, the icon contains a green arrow . Click this icon to open the File Manager window, which lets you conveniently access the folders/files in the USB device. If no USB device is detected, then the icon will display as .



click to show network status; click to configure network.



click to show mute status; click to change volume.



click to choose input language and method as well as keyboard shortcuts (Ctrl-Space by default)



click to change LaunchBar options (auto-hide, docking position, etc).



click to show "About Express Gate".



click to open Express Gate Help.



click to bring up power options window to boot to OS, restart or power down.



left-click to set date and time; right-click to choose between 12-hour and 24-hour display formats.

This power option window is also shown when you press Ctrl-Alt-Del on the keyboard.



How Do I Get on to the Internet

If Internet does not work in the Express Gate environment, check the following:

1. Open the Configuration Panel.



2. Open Network tool.

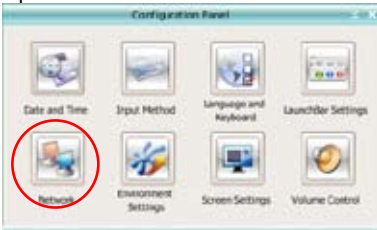

3. Make the proper network configurations in the **Network** dialog box. Each network interface is enabled immediately when you check the box next to it.



- If you use a network cable connected to a home router (which is then connected to your DSL/cable modem), enable both LAN1 and LAN2. Express Gate will automatically use whichever port (LAN1 or LAN2) is connected.



If you plug the network cable into a different port while Express Gate is running (e.g. move the cable from LAN1 to LAN2), you may need to restart Express Gate for it to detect the change.

- The most common scenario is for your computer to automatically obtain network settings (i.e. DHCP). If this is the case, you don't need to go into "Setup" for any LAN port. If this is not the case, enter "Setup" to configure the static IP settings manually.
- If you use wireless, go into "Setup" for the WiFi option. Under the WiFi tab, enter the SSID (name of your wireless access point). If your wireless access point has security enabled, select the security algorithm from the pulldown menu (e.g. WEPAUTO) and enter the password. Then enable WiFi to establish the wireless connection.
- If you use a network cable connected directly to your DSL/cable modem (no router in between), go into "Setup" for xDSL/cable dial-up. This method is also referred to as PPPoE. Choose whether the DSL/cable modem is connected to your computer's LAN port. (Refer to the drawing in the Network tool to figure out which is LAN1 or LAN2.) Then enter the username and password for your dial-up account.

Then enable xDSL/cable dial-up to establish the PPPoE connection. When PPPoE is enabled, the LAN port it uses will automatically be unchecked and grayed out.

Configuring Express Gate in BIOS Setup

Enter BIOS setup by pressing DEL key after powering on or by clicking on the BIOS setup icon on Express Gate's first screen. Express Gate configuration options are under Tools configuration menu page.

Phoenix-Award BIOS CMOS Setup Utility		
Tools		
ASUS Express Gate		Select Menu
Express Gate	[Enabled]	Item Specific Help▶▶
Enter OS Timer	[10 Seconds]	
Reset User Date	[No]	

Express Gate [Enabled]

Allows you to enable or disable the ASUS Express Gate feature. The ASUS Express Gate feature is a unique instant-on environment that provides quick access to the Internet browser and Skype.

Configuration options: [Enabled] [Disabled]

Enter OS Timer [10]

Sets the amount of time the system waits at the Express Gate's first screen before starting Windows or other installed OS. Set this item to [Prompt User] to stay at the first screen of the Express Gate for user action.

Configuration options: [Prompt User] [1 second] [3 second] [5 second] [10 second] [15 second] [20 second] [30 seconds]

Reset User Data [No]

Allows you to clear Express Gate's user data.

Configuration options: [No] [Reset]

When set to [Reset], the user data will be cleared and this item will return to the default setting. Set to [No] to keep the user data and personal information you have saved under the Express Gate.



The first time wizard will run again when you enter the Express Gate environment after clearing its settings.

Express Gate Updater

Use the Express Gate Updater to update your existing Express Gate software to new versions or to restore the Express Gate software if it is ever corrupted. You can find **Express Gate Updater Installer** on the support DVD or download it from the ASUS support website. It runs on Windows.

New versions of the Express Gate software will be released regularly, adding refinements or new applications. You can find original version of the software on the support DVD or download new versions from the ASUS support website. Express Gate software is released as an image file with .DFI extension.

To install the Express Gate Updater, launch the installer and follow on-screen prompts.



To use the Express Gate Updater, launch the application and follow on-screen prompts.

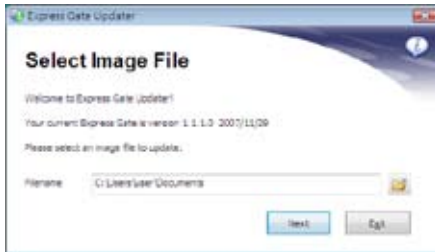

The Updater can preserve your Express Gate settings and personal data (web browser bookmarks, etc.) while doing an update. Use the checkbox “Keep user profile” to decide whether the Updater should do so.

Clearing the user data is useful in the rare case where corrupt settings prevent the Express Gate environment from launching properly.



The first time wizard will run again when you enter the Express Gate environment after clearing its settings.

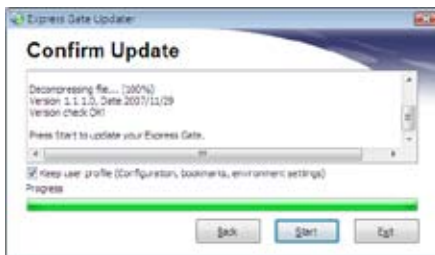

5.4 RAID configurations

The motherboard comes with one RAID controllers that allow you to configure Serial ATA hard disk drives as RAID sets.

- The **NVIDIA® nForce™ 780a SLI Southbridge** includes a high performance SATA RAID controller that supports RAID 0, RAID 1, RAID 0+1, RAID 5 and JBOD for six independent Serial ATA channels.

5.4.1 RAID definitions

RAID 0 (Data striping) optimizes two identical hard disk drives to read and write data in parallel, interleaved stacks. Two hard disks perform the same work as a single drive but at a sustained data transfer rate, double that of a single disk alone, thus improving data access and storage. Use of two new identical hard disk drives is required for this setup.

RAID 1 (Data mirroring) copies and maintains an identical image of data from one drive to a second drive. If one drive fails, the disk array management software directs all applications to the surviving drive as it contains a complete copy of the data in the other drive. This RAID configuration provides data protection and increases fault tolerance to the entire system. Use two new drives or use an existing drive and a new drive for this setup. The new drive must be of the same size or larger than the existing drive.

RAID 5 stripes both data and parity information across three or more hard disk drives. Among the advantages of RAID 5 configuration include better HDD performance, fault tolerance, and higher storage capacity. The RAID 5 configuration is best suited for transaction processing, relational database applications, enterprise resource planning, and other business systems. Use a minimum of three identical hard disk drives for this setup.

RAID 0+1 (RAID 10) is data striping and data mirroring combined without parity (redundancy data) having to be calculated and written. With the RAID 10* configuration you get all the benefits of both RAID 0 and RAID 1 configurations. Use four new hard disk drives or use an existing drive and three new drives for this setup.

JBOD (Spanning) stands for Just a Bunch of Disks and refers to hard disk drives that are not yet configured as a RAID set. This configuration stores the same data redundantly on multiple disks that appear as a single disk on the operating system. Spanning does not deliver any advantage over using separate disks independently and does not provide fault tolerance or other RAID performance benefits.



For Windows® XP, if you want to boot the system from a hard disk drive included in a RAID set, first copy the RAID driver from the Support DVD to a floppy disk before you install an operating system to a selected hard disk drive. Refer to section “5.5 Creating a RAID driver disk” for details.

5.4.2 NVIDIA® RAID configurations

The motherboard includes a high performance SATA RAID controller integrated in the NVIDIA® nForce™ 780a SLI southbridge chipset. It supports RAID 0, RAID 1, RAID 0+1, RAID 5 and JBOD for six independent Serial ATA channels.

Installing Serial ATA (SATA) hard disks

The motherboard supports Ultra DMA 133/100/66 and Serial ATA hard disk drives. For optimal performance, install identical drives of the same model and capacity when creating a disk array.

To install the SATA hard disks for a RAID configuration:

1. Install the SATA hard disks into the drive bays.
2. Connect the SATA signal cables.
3. Connect a SATA power cable to the power connector on each drive.



Refer to the RAID controllers user manual in the motherboard support DVD for detailed information on RAID configurations. See section “5.2.5 Manuals menu.”

Setting the BIOS RAID items

After installing the hard disk drives, make sure to set the necessary RAID items in the BIOS before setting your RAID configuration.

To set the BIOS RAID items:

1. Boot the system and press during the Power-On Self-Test (POST) to enter the BIOS Setup Utility.
2. Enable the **RAID Enabled** item in the BIOS. See section “**4.5.3 Onboard Device Configuration > Serial-ATA Configuration**” for details.
3. Select and enable the SATA drive(s) that you want to configure as RAID. See section “**4.5.3 Onboard Device Configuration > Serial-ATA Configuration**” for details.
4. Save your changes and Exit Setup.



Make sure to re-enter your NVRAID settings after the CMOS is cleared; otherwise, the system will not recognize your RAID setup.



- For detailed descriptions on the NVIDIA® RAID configuration, refer to the “NVIDIA® RAID User Guide” found in your motherboard Support DVD.
- When using Windows® XP operating system, make sure to install the Windows® XP Service Pack 2 or later versions.

Entering the NVIDIA® RAID utility

To enter the NVIDIA® RAID utility:

1. Boot up your computer.
2. During POST, press <F10> to display the main menu of the utility.



The RAID BIOS setup screens shown in this section are for reference only, and may not exactly match the items on your screen.

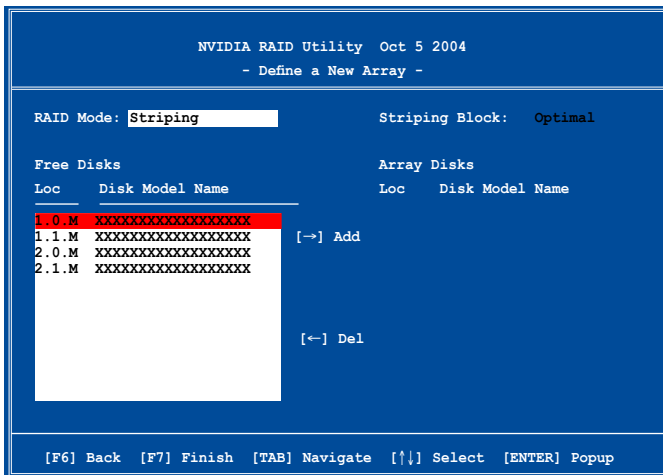

At the bottom of the screen are the navigation keys. These keys allow you to move through and select menu options.

Creating a RAID Volume

To create a RAID volume:

1. From the NVIDIA® RAID utility Define a New Array menu, select RAID Mode then press <Enter>. The following submenu appears.

Use the up or down arrow keys to select a RAID mode then press <Enter>.

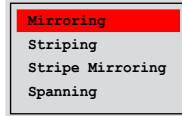

2. Press <TAB> select the Striping Block then press <Enter>. The following submenu appears:

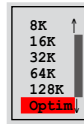

If you selected Striping or Stripe Mirroring, use the up or down arrow keys to select the stripe size for your RAID 0 array then press <Enter>. The available values range from 8 KB to 128 KB. The default selection is 128 KB. The stripe value should be chosen based on the planned drive usage.

- 8 /16 KB - low disk usage
- 64 KB - typical disk usage
- 128 KB - performance disk usage



TIP: For server systems, we recommend using a lower array block size. For multimedia computer systems used mainly for audio and video editing, we recommend a higher array block size for optimum performance.

3. Press <TAB> to select the Free Disks area. Use the left or right arrow keys to assign the array disks.
4. Press <F7> to create RAID set. The following message box appears.

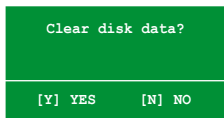

5. Press <Y> to clear the selected disks or <N> to proceed without clearing the disks. The following screen appears.



Take caution in using this option. All data on the RAID drives will be lost!

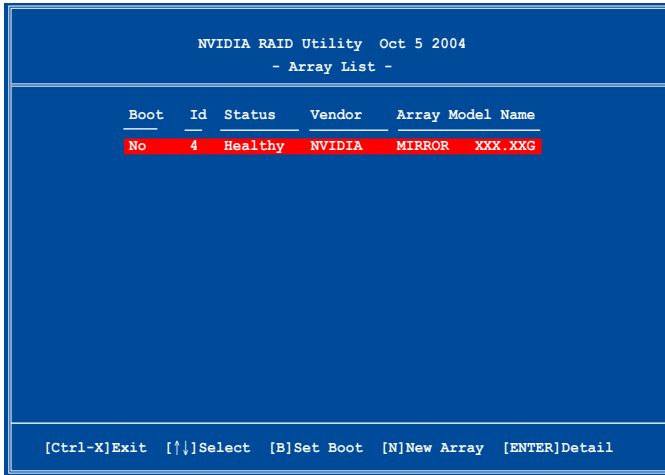

A new set of navigation keys is displayed on the bottom of the screen.

6. Press <Ctrl+X> to save settings and exit.

Rebuilding a RAID array

To rebuild a RAID array:

1. From the Array List menu, use the up or down arrow keys to select a RAID array then press <Enter>. The RAID Array details appear.

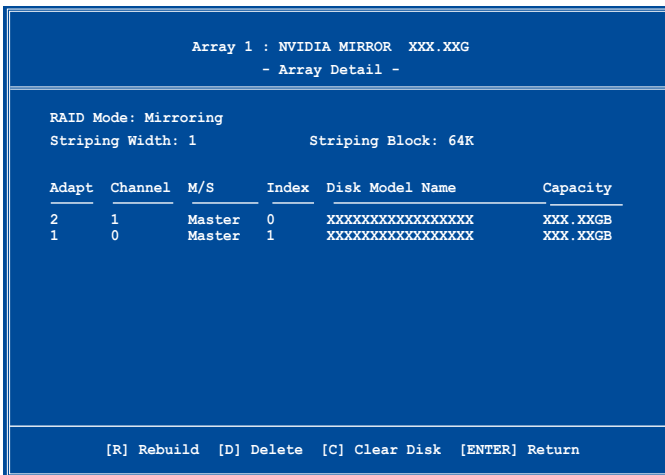

- A new set of navigation keys is displayed on the bottom of the screen.
2. Press <R> to rebuild a RAID array. The following screen appears.

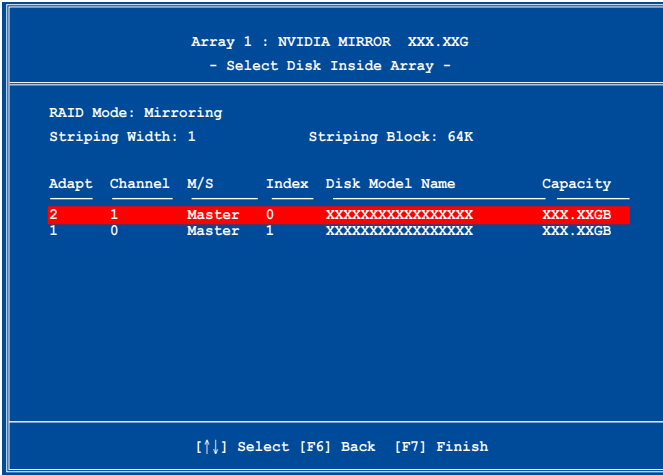

3. Use the up or down arrow keys to select a RAID array to rebuild, then press <F7>. The following confirmation message appears.



4. Press <Enter> to start rebuilding array or press <Esc> to cancel.
5. After the rebuild process, the Array list menu appears.



You will need to enter Window® XP and run the NVIDIA utility in order to complete the rebuilt process.

Deleting a RAID array

To delete a RAID array:

1. From the Array List menu, use the up or down arrow keys to select a RAID array then press <Enter>. The RAID Array details appear.

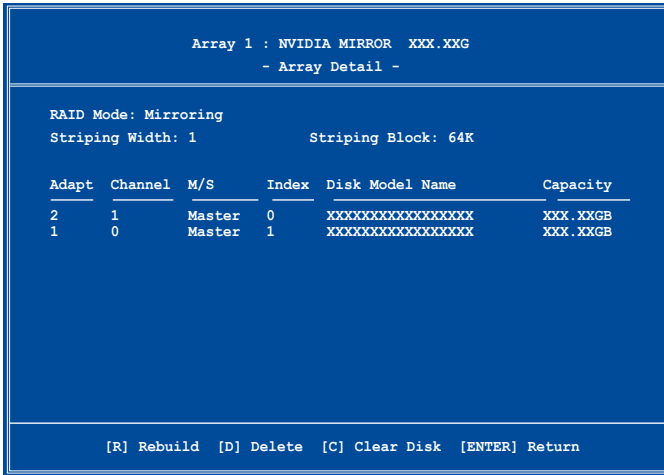

A new set of navigation keys is displayed on the bottom of the screen.

2. Press <D> to delete a RAID array. The following confirmation message appears.

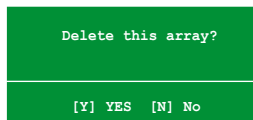

3. Press <Y> to delete array or press <N> to cancel.



Take caution in using this option. All data on the RAID drives will be lost!

4. If you selected Yes, the Define a New Array menu appears.

Clearing a disk data

To clear disk data:

1. From the Array List menu, use the up or down arrow keys to select a RAID array then press <Enter>. The RAID Array details appear.

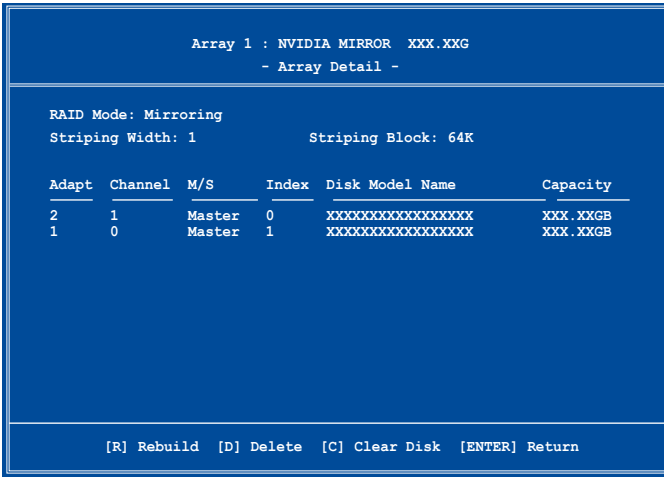

A new set of navigation keys is displayed on the bottom of the screen.

2. Press <C> to clear disk. The following confirmation message appears.

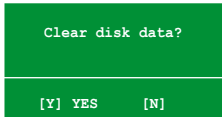

3. Press <Y> to clear the disk data or press <N> to cancel.



Take caution in using this option. All data on the RAID drives will be lost!

5.5 Creating a RAID driver disk

A floppy disk with the RAID driver is required when installing Windows® XP operating system on a hard disk drive that is included in a RAID set. For Windows® Vista™ operating system, use either the motherboard support DVD or a USB device with the RAID driver.

5.5.1 Creating a RAID driver disk without entering the OS

To create a RAID/SATA driver disk without entering the OS:

1. Boot your computer.
2. Press during POST to enter the BIOS setup utility.
3. Set the optical drive as the primary boot device.
4. Insert the support DVD into the optical drive.
5. Save changes and exit BIOS.
6. Press any key when the system prompts "Press any key to boot from the optical drive."
7. When the menu appears, press <1> to create a RAID driver disk.
8. Insert a formatted floppy disk into the floppy drive then press <Enter>.
9. Follow succeeding screen instructions to complete the process.

5.5.2 Creating a RAID/SATA driver disk in Windows®

To create a RAID driver disk in Windows®:

1. Start Windows®.
2. Place the motherboard support DVD into the optical drive.
3. Go to the Make Disk menu, then click **NVIDIA 32/64 bit XP Driver** to create a NVIDIA® 32/64 bit XP SATA RAID driver disk.
4. Insert a floppy disk/USB device into the floppy disk drive/USB port.
5. Follow succeeding screen instructions to complete the process.



Write-protect the floppy disk to avoid computer virus infection.

To install the RAID driver in Windows® XP:

1. During the OS installation, the system prompts you to press the F6 key to install third-party SCSI or RAID driver.
2. Press <F6> then insert the floppy disk with RAID driver into the floppy disk drive.
3. Follow the succeeding screen instructions to complete the installation.

To install the RAID driver in Windows® Vista™:

1. Insert the motherboard support DVD or a USB device with RAID driver into the optical drive/USB port.
Find RAID driver in the support DVD through the path below:
Drivers\Chipset\Disk\RAID
Find AHCI driver in the support DVD through the path below:
Drivers\Chipset\Disk\AHCI
2. Follow the succeeding screen instructions to complete the installation.



Due to chipset limitation, the Serial ATA ports supported by the NVIDIA chipset doesn't support Serial Optical Disk Drives (Serial ODD) under DOS.

This chapter tells how to install SLI-ready
PCI Express graphics cards.

NVIDIA® SLI™ technology support

Chapter summary

6.1	Overview	6-1
6.2	Graphics card setup	6-2

6.1 Overview

The motherboard supports the NVIDIA® SLI™ (Scalable Link Interface) technology that allows you to install up to three identical PCI Express™ x16 graphics cards. Follow the installation procedures in this section.

Requirements

- In Dual SLI mode, you should have two identical SLI-ready graphics cards that are NVIDIA® certified.
- In 3-way SLI mode, you should have three identical SLI-ready graphics cards that are NVIDIA® certified.
- Make sure that your graphics card driver supports the NVIDIA SLI technology. Download the latest driver from the NVIDIA website (www.nvidia.com).
- Make sure that your power supply unit (PSU) can provide at least the minimum power required by your system. See page 2-31 for details.



-
- The NVIDIA 3-way SLI technology supports Windows® Vista operating system only.
 - Visit the NVIDIA zone website (<http://www.nzone.com>) for the latest certified graphics card and supported 3D application list.
-

6.2 Graphics card setup

6.2.1 Installing three SLI-ready graphics cards



Install only identical SLI-ready graphics cards that are NVIDIA®-certified. Different types of graphics cards will not work together properly.

To install the graphics cards:

1. Prepare three graphics cards. Each graphics card should have goldfingers for the 3-way SLI bridge connector.

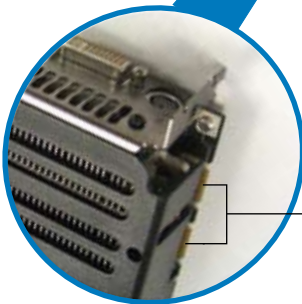
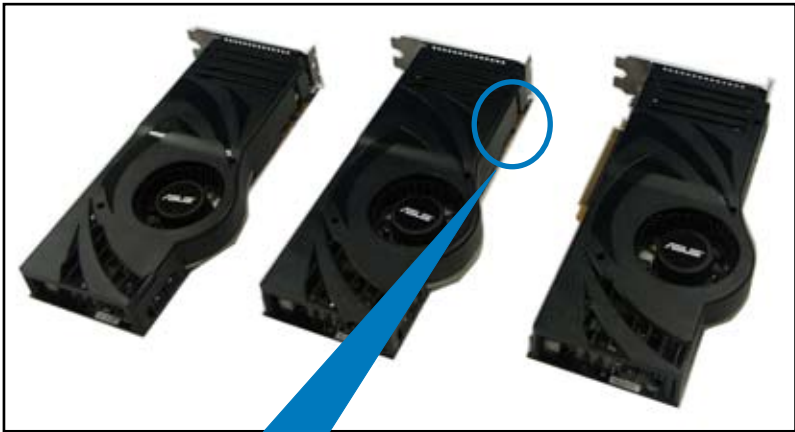

Goldfingers

2. Insert the first graphics card into the PCIEX16_1 slot (blue), the second into the PCIEX16_2 slot (black), and the third into the PCIEX16_3 slot (blue). Make sure that the cards are properly seated on the slots.

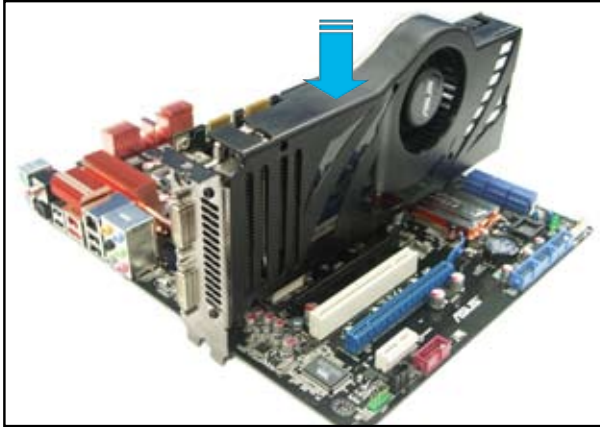

3. Align and firmly insert the 3-way SLI bridge connector to the goldfingers on each graphics card. Make sure that the connector is firmly in place.

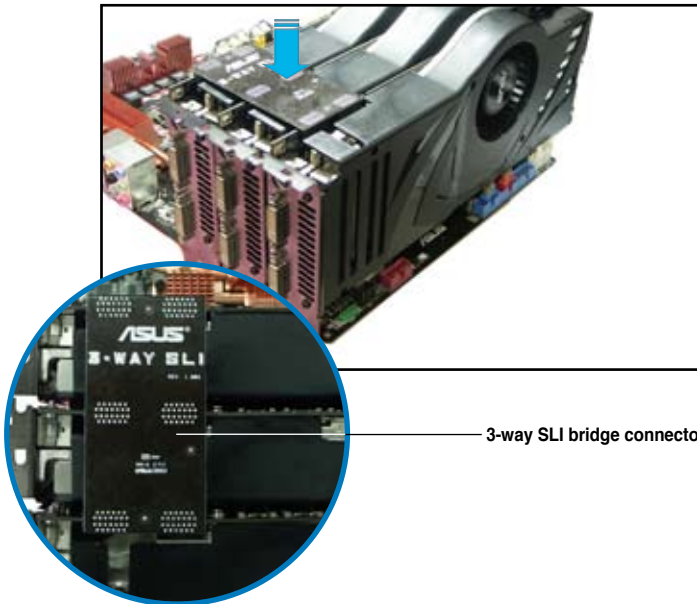

4. Connect auxiliary power source from the power supply to the three graphics cards separately.

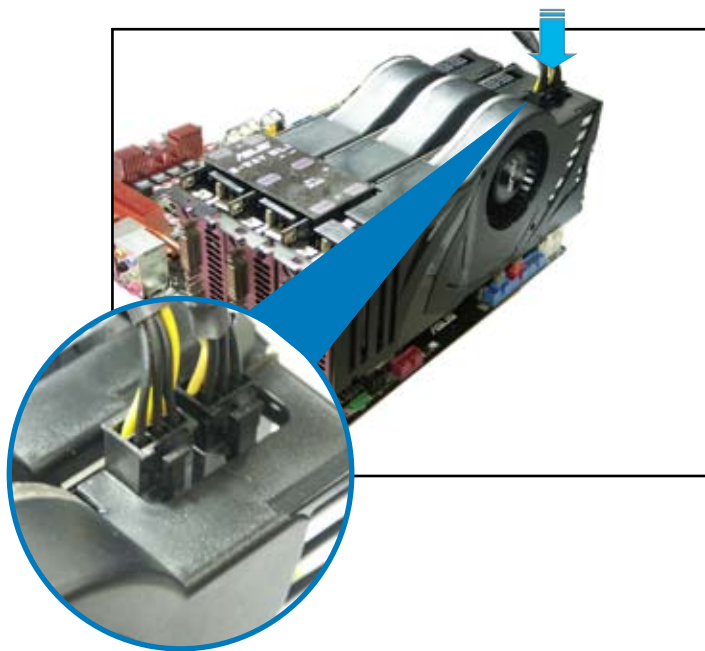

5. Connect a VGA or a DVI-I cable to the graphics card/s.



We recommend that you install an additional chassis fan for better thermal environment.

6.2.2 Installing two SLI-ready graphics cards

1. Insert one graphics card into the PCIEX16_1 slot (blue) and the other into the PCIEX16_3 slot (blue). Make sure that the cards are properly seated on the slots.
2. Align and insert the SLI connector to the goldfingers on each graphics card. Make sure that the connector is firmly in place.
3. Connect auxiliary power source from the power supply to the two graphics cards separately.
4. Connect a VGA or a DVI-I cable to the graphics card/s.



We recommend that you install an additional chassis fan for better thermal environment.

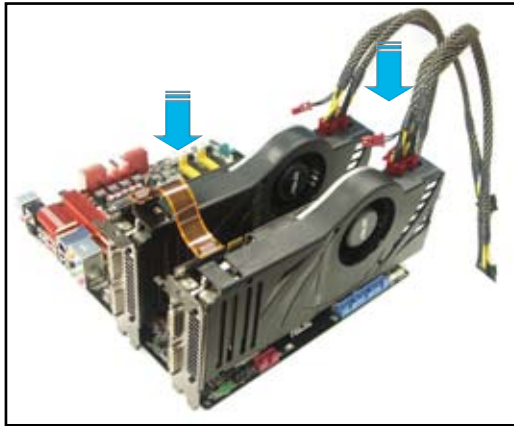

6.2.3 Installing the device drivers

Refer to the documentation that came with your graphics card package to install the device drivers.



- Make sure that your PCI Express graphics card driver supports the NVIDIA® SLI™ technology. Download the latest driver from the NVIDIA website (www.nvidia.com).
- If you are using a 3-way SLI system, make sure to install the 3-way SLI driver under Windows® Vista OS. The NVIDIA 3-way SLI technology supports Windows® Vista OS only.

6.2.4 Enabling the NVIDIA® SLI™ technology in Windows®

After installing your graphics cards and the device drivers, enable the SLI feature in NVIDIA® Control Panel under the Windows® Vista operating system.

Launching the NVIDIA Control Panel

You can launch the NVIDIA Control Panel by two methods.

- (a) Right click on the empty space of Windows® desktop and select **NVIDIA Control Panel**.

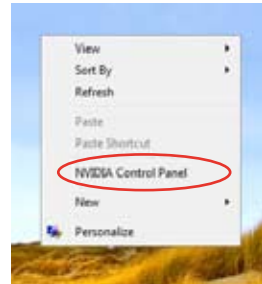

- (b) If you cannot see the NVIDIA Control Panel item in step (a), select **Personalize**.

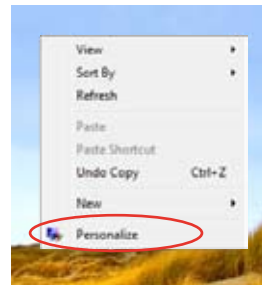

From the **Personalization** window, select **Display Settings**.

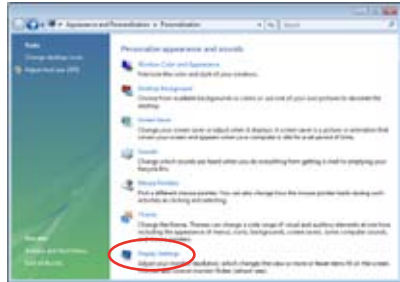

From the Display Settings dialog box, click **Advanced Settings**.



Select the NVIDIA GeForce tab, then click **Start the NVIDIA Control Panel**.



Free Manuals Download Website

<http://myh66.com>

<http://usermanuals.us>

<http://www.somanuals.com>

<http://www.4manuals.cc>

<http://www.manual-lib.com>

<http://www.404manual.com>

<http://www.luxmanual.com>

<http://aubethermostatmanual.com>

Golf course search by state

<http://golfingnear.com>

Email search by domain

<http://emailbydomain.com>

Auto manuals search

<http://auto.somanuals.com>

TV manuals search

<http://tv.somanuals.com>