

AT3N7A-I



Motherboard

E4877

First Edition V1

August 2009

Copyright © 2009 ASUSTeK Computer Inc. All Rights Reserved.

No part of this manual, including the products and software described in it, may be reproduced, transmitted, transcribed, stored in a retrieval system, or translated into any language in any form or by any means, except documentation kept by the purchaser for backup purposes, without the express written permission of ASUSTeK Computer Inc. ("ASUS").

Product warranty or service will not be extended if: (1) the product is repaired, modified or altered, unless such repair, modification or alteration is authorized in writing by ASUS; or (2) the serial number of the product is defaced or missing.

ASUS PROVIDES THIS MANUAL "AS IS" WITHOUT WARRANTY OF ANY KIND, EITHER EXPRESS OR IMPLIED, INCLUDING BUT NOT LIMITED TO THE IMPLIED WARRANTIES OR CONDITIONS OF MERCHANTABILITY OR FITNESS FOR A PARTICULAR PURPOSE. IN NO EVENT SHALL ASUS, ITS DIRECTORS, OFFICERS, EMPLOYEES OR AGENTS BE LIABLE FOR ANY INDIRECT, SPECIAL, INCIDENTAL, OR CONSEQUENTIAL DAMAGES (INCLUDING DAMAGES FOR LOSS OF PROFITS, LOSS OF BUSINESS, LOSS OF USE OR DATA, INTERRUPTION OF BUSINESS AND THE LIKE), EVEN IF ASUS HAS BEEN ADVISED OF THE POSSIBILITY OF SUCH DAMAGES ARISING FROM ANY DEFECT OR ERROR IN THIS MANUAL OR PRODUCT.

SPECIFICATIONS AND INFORMATION CONTAINED IN THIS MANUAL ARE FURNISHED FOR INFORMATIONAL USE ONLY, AND ARE SUBJECT TO CHANGE AT ANY TIME WITHOUT NOTICE, AND SHOULD NOT BE CONSTRUED AS A COMMITMENT BY ASUS. ASUS ASSUMES NO RESPONSIBILITY OR LIABILITY FOR ANY ERRORS OR INACCURACIES THAT MAY APPEAR IN THIS MANUAL, INCLUDING THE PRODUCTS AND SOFTWARE DESCRIBED IN IT.

Products and corporate names appearing in this manual may or may not be registered trademarks or copyrights of their respective companies, and are used only for identification or explanation and to the owners' benefit, without intent to infringe.

Contents

Notices.....	v
Safety information	vi
About this guide	vii
AT3N7A-I specifications summary.....	viii

Chapter 1: Product introduction

1.1 Before you proceed	1-1
1.2 Motherboard overview.....	1-2
1.2.1 Motherboard layout.....	1-2
1.2.2 Layout contents.....	1-2
1.3 Central Processing Unit (CPU)	1-3
1.4 System memory	1-3
1.4.1 Overview	1-3
1.4.2 Memory configurations.....	1-4
1.5 Expansion slot.....	1-7
1.5.1 Installing an expansion card	1-7
1.5.2 Configuring an expansion card	1-7
1.5.3 PCI slot	1-7
1.6 Jumpers	1-8
1.7 Connectors	1-9
1.7.1 Rear panel connectors.....	1-9
1.7.2 Internal connectors	1-11
1.8 Software support.....	1-16
1.8.1 Installing an operating system	1-16
1.8.2 Support DVD information	1-16

Chapter 2: BIOS information

2.1 Managing and updating your BIOS	2-1
2.1.1 ASUS Update utility	2-1
2.1.2 ASUS EZ Flash 2.....	2-2
2.1.3 ASUS CrashFree BIOS.....	2-3
2.2 BIOS setup program	2-4
2.3 Main menu	2-4
2.3.1 System Time	2-5
2.3.2 System Date	2-5
2.3.3 SATA 1~3, ESATA	2-5

Contents

- 2.3.4 Storage Configuration 2-6
- 2.3.5 System Information 2-6
- 2.4 Advanced menu 2-6**
 - 2.4.1 CPU Configuration 2-7
 - 2.4.2 JumperFree Configuration 2-7
 - 2.4.3 Chipset 2-8
 - 2.4.4 Onboard Devices Configuration 2-9
 - 2.4.5 USB Configuration 2-9
 - 2.4.6 PCI PnP 2-10
- 2.5 Power menu 2-10**
 - 2.5.1 Suspend Mode 2-10
 - 2.5.2 ACPI 2.0 Support 2-11
 - 2.5.3 ACPI APIC Support 2-11
 - 2.5.4 APM Configuration 2-11
 - 2.5.5 Hardware Monitor 2-11
- 2.6 Boot menu 2-12**
 - 2.6.1 Boot Device Priority 2-12
 - 2.6.2 Boot Settings Configuration 2-12
 - 2.6.3 Security 2-13
- 2.7 Tools menu 2-14**
 - 2.7.1 ASUS EZ Flash 2 2-14
 - 2.7.2 Express Gate 2-15
 - 2.7.3 AI NET 2 2-15
- 2.8 Exit menu 2-15**

Notices

Federal Communications Commission Statement

This device complies with Part 15 of the FCC Rules. Operation is subject to the following two conditions:

- This device may not cause harmful interference, and
- This device must accept any interference received including interference that may cause undesired operation.

This equipment has been tested and found to comply with the limits for a Class B digital device, pursuant to Part 15 of the FCC Rules. These limits are designed to provide reasonable protection against harmful interference in a residential installation. This equipment generates, uses and can radiate radio frequency energy and, if not installed and used in accordance with manufacturer's instructions, may cause harmful interference to radio communications. However, there is no guarantee that interference will not occur in a particular installation. If this equipment does cause harmful interference to radio or television reception, which can be determined by turning the equipment off and on, the user is encouraged to try to correct the interference by one or more of the following measures:

- Reorient or relocate the receiving antenna.
- Increase the separation between the equipment and receiver.
- Connect the equipment to an outlet on a circuit different from that to which the receiver is connected.
- Consult the dealer or an experienced radio/TV technician for help.



The use of shielded cables for connection of the monitor to the graphics card is required to assure compliance with FCC regulations. Changes or modifications to this unit not expressly approved by the party responsible for compliance could void the user's authority to operate this equipment.

Canadian Department of Communications Statement

This digital apparatus does not exceed the Class B limits for radio noise emissions from digital apparatus set out in the Radio Interference Regulations of the Canadian Department of Communications.

This class B digital apparatus complies with Canadian ICES-003.

REACH

Complying with the REACH (Registration, Evaluation, Authorisation, and Restriction of Chemicals) regulatory framework, we published the chemical substances in our products at ASUS REACH website at <http://green.asus.com/english/REACH.htm>.



DO NOT throw the motherboard in municipal waste. This product has been designed to enable proper reuse of parts and recycling. This symbol of the crossed out wheeled bin indicates that the product (electrical and electronic equipment) should not be placed in municipal waste. Check local regulations for disposal of electronic products.



DO NOT throw the mercury-containing button cell battery in municipal waste. This symbol of the crossed out wheeled bin indicates that the battery should not be placed in municipal waste.

Safety information

Electrical safety

- To prevent electric shock hazard, disconnect the power cable from the electric outlet before relocating the system.
- When adding or removing devices to or from the system, ensure that the power cables for the devices are unplugged before the signal cables are connected. If possible, disconnect all power cables from the existing system before you add a device.
- Before connecting or removing signal cables from the motherboard, ensure that all power cables are unplugged.
- Seek professional assistance before using an adapter or extension cord. These devices could interrupt the grounding circuit.
- Ensure that your power supply is set to the correct voltage in your area. If you are not sure about the voltage of the electrical outlet you are using, contact your local power company.
- If the power supply is broken, do not try to fix it by yourself. Contact a qualified service technician or your retailer.
- The optical S/PDIF is an optional component (may or may not be included in your motherboard) and is defined as a CLASS 1 LASER PRODUCT.



INVISIBLE LASER RADIATION, AVOID EXPOSURE TO BEAM.

- Never dispose of the battery in fire. It could explode and release harmful substances into the environment.
- Never dispose of the battery with your regular household waste. Take it to a hazardous material collection point.
- Never replace the battery with an incorrect battery type.



- RISK OF EXPLOSION IF BATTERY IS REPLACED BY AN INCORRECT TYPE.
 - DISPOSE OF USED BATTERIES ACCORDING TO THE ABOVE BATTERY-RELATED INSTRUCTIONS.
-

Operation safety

- Before installing the motherboard and adding devices on it, carefully read all the manuals that came with the package.
- Before using the product, ensure that all cables are correctly connected and the power cables are not damaged. If you detect any damage, contact your dealer immediately.
- To avoid short circuits, keep paper clips, screws, and staples away from connectors, slots, sockets and circuitry.
- Avoid dust, humidity, and temperature extremes. Do not place the product in any area where it may become wet.



This motherboard should only be used in environments with ambient temperatures between 5°C (41°F) and 40°C (104°F).

- Place the product on a stable surface.
- If you encounter technical problems with the product, contact a qualified service technician or your retailer.

About this guide

This user guide contains the information you need when installing and configuring the motherboard.

How this guide is organized

This guide contains the following parts:

- **Chapter 1: Product introduction**

This chapter describes the features of the motherboard and the new technology it supports.

- **Chapter 2: BIOS information**

This chapter tells how to change system settings through the BIOS Setup menus. Detailed descriptions of the BIOS parameters are also provided.

Conventions used in this guide

To ensure that you perform certain tasks properly, take note of the following symbols used throughout this manual.



DANGER/WARNING: Information to prevent injury to yourself when trying to complete a task.



CAUTION: Information to prevent damage to the components when trying to complete a task.



IMPORTANT: Instructions that you **MUST** follow to complete a task.



NOTE: Tips and additional information to help you complete a task.

Where to find more information

Refer to the following sources for additional information and for product and software updates.

1. **ASUS websites**

The ASUS website provides updated information on ASUS hardware and software products. Refer to the ASUS contact information.

2. **Optional documentation**

Your product package may include optional documentation, such as warranty flyers, that may have been added by your dealer. These documents are not part of the standard package.

Typography

Bold text

Indicates a menu or an item to select.

Italics

Used to emphasize a word or a phrase.

<Key>

Keys enclosed in the less-than and greater-than sign means that you must press the enclosed key.

Example: <Enter> means that you must press the Enter or Return key.

<Key1>+<Key2>+<Key3>

If you must press two or more keys simultaneously, the key names are linked with a plus sign (+).

Example: <Ctrl>+<Alt>+<D>

AT3N7A-I specifications summary

CPU	Integrated Dual-Core Intel® Atom™ 330 processor
Chipset	NVIDIA® ION™
Front Side Bus	533 MHz
Memory	<p>Dual channel memory architecture</p> <ul style="list-style-type: none"> - 2 x 240-pin DIMM sockets support maximum 4GB unbuffered non-ECC 800/667 MHz DDR2 memory modules <p>* Refer to www.asus.com or this user manual for the Memory QVL (Qualified Vendors Lists).</p> <p>** When you install a total memory of 4GB capacity or more, Windows® 32-bit operating system may only recognize less than 3GB. We recommend a maximum of 3GB system memory if you are using a Windows® 32-bit operating system.</p>
Graphics	<p>Integrated NVIDIA® GeForce Series DirectX10 graphics processor</p> <p>Supports CUDA technology</p> <p>Supports PhysX technology</p> <p>Supports RGB with max. resolution up to 1920 x 1440 x 32 Bpp @75Hz</p> <p>Supports HDMI with max. resolution up to 1920 x 1200 x 32 Bpp @60Hz</p> <p>Dual VGA output supports: RGB&HDMI</p> <p>* The minimum system requirements of playing HD-DVD and Blu-ray disc: Graphics shared memory of 256MB / 1GB dual-channel DDR2 667 or single-channel DDR2 800.</p>
Expansion slot	1 x PCI slot
Storage	3 x Serial ATA 3Gb/s ports
Audio	VIA® VT1708S High Definition Audio 8-channel CODEC
LAN	Realtek® RTL8112L PCIe Gigabit LAN controller
USB	Supports up to 10 USB 2.0/1.1 ports (2 ports at mid-board, 8 ports at back panel)
Fan	Rated Speed: 6000 ± 15% RPM
ASUS special features	<p>ASUS CrashFree BIOS 3</p> <p>ASUS EZ Flash 2</p> <p>ASUS MyLogo 2™</p> <p>ASUS AI NET 2</p> <p>ASUS Express Gate</p>

(continued on the next page)

AT3N7A-I specifications summary

Rear panel ports	<ul style="list-style-type: none"> 1 x PS/2 Keyboard port 1 x Bluetooth adapter 1 x eSATA port 2 x S/PDIF out ports (Optical & Coaxial) 1 x VGA port 1 x HDMI port 1 x LAN (RJ-45) port 8 x USB 2.0/1.1 ports 8-channel audio I/O ports
Internal connectors	<ul style="list-style-type: none"> 1 x USB 2.0/1.1 connector supports additional 2 USB 2.0/1.1 ports 1 x CPU fan connector 1 x Chassis fan connector 1 x Power fan connector 1 x Chassis intrusion connector 3 x Serial ATA connectors 1 x System panel connector 1 x High definition front panel audio connector 1 x 24-pin EATX power connector 1 x 4-pin ATX 12V power connector
BIOS features	8 Mb Flash ROM, AMI BIOS, PnP, DMI2.0, WfM2.0, SMBIOS 2.5, ACPI v2.0a
Accessories	<ul style="list-style-type: none"> 2 x Serial ATA cables 1 x I/O shield 1 x User Manual
Support DVD contents	<ul style="list-style-type: none"> Drivers ASUS PC Probe II ASUS Update Anti-virus software (OEM version)
Form Factor	Mini ITX form factor: 6.75 in x 6.75 in (17.1cm x 17.1cm)

*Specifications are subject to change without notice.

Chapter 1

Product introduction

Thank you for buying an ASUS® AT3N7A-I motherboard!

Before you start installing the motherboard, and hardware devices on it, check the items in your motherboard package. Refer to page ix for the list of accessories.



If any of the items is damaged or missing, contact your retailer.

1.1 Before you proceed

Take note of the following precautions before you install motherboard components or change any motherboard settings.



- Unplug the power cord from the wall socket before touching any component.
 - Before handling components, use a grounded wrist strap or touch a safely grounded object or a metal object, such as the power supply case, to avoid damaging them due to static electricity.
 - Hold components by the edges to avoid touching the ICs on them.
 - Whenever you uninstall any component, place it on a grounded antistatic pad or in the bag that came with the component.
 - Before you install or remove any component, ensure that the ATX power supply is switched off or the power cord is detached from the power supply. Failure to do so may cause severe damage to the motherboard, peripherals, or components.
-

Onboard LED

The motherboard comes with a standby power LED that lights up to indicate that the system is ON, in sleep mode, or in soft-off mode. This is a reminder that you must shut down the system and unplug the power cable before removing or plugging in any motherboard component. The illustration below shows the location of the onboard LED.

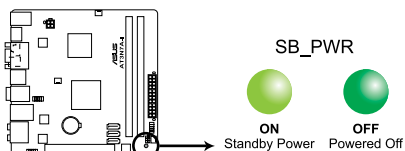

AT3N7A-I Onboard LED

1.2 Motherboard overview

1.2.1 Motherboard layout



Ensure that you install the motherboard into the chassis in the correct orientation. The edge with external ports goes to the rear part of the chassis.

Place this side towards the rear of the chassis.

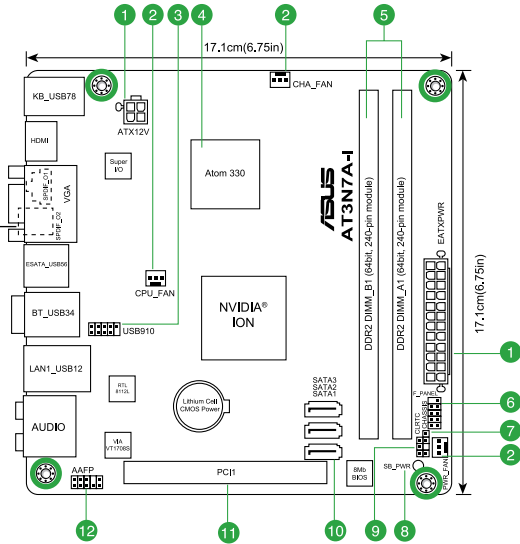

Place four screws into the holes indicated by circles to secure the motherboard to the chassis. DO NOT overtighten the screws! Doing so can damage the motherboard.

1.2.2 Layout contents

Connectors/Jumpers/Slots/LED	Page	Connectors/Jumpers/Slots/LED	Page
1. ATX power connectors (24-pin EATXPWR, 4-pin ATX12V)	1-11	7. Chassis intrusion connector (4-1 pin CHASSIS)	1-13
2. CPU, power, and chassis fan connectors (3-pin CPU_FAN, 3-pin PWR_FAN, 3-pin CHA_FAN)	1-14	8. Onboard LED (SB_PWR)	1-1
3. USB connector (10-1 pin USB910)	1-13	9. Clear RTC RAM (3-pin CLRTC)	1-8
4. Atom 330 processor	1-3	10. Serial ATA connectors (7-pin SATA1, SATA2, SATA3)	1-12
5. DDR2 DIMM slots	1-3	11. PCI slot	1-7
6. System panel connector (10-1 pin F_PANEL)	1-15	12. Front panel audio connector (10-1 pin AAFP)	1-14

1.3 Central Processing Unit (CPU)

The motherboard comes with an onboard Dual-Core Intel® Atom™ 330 processor and a specially designed CPU heatsink and fan.

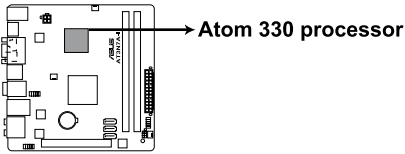

AT3N7A-I CPU Atom 330



Ensure that the CPU fan cable is connected to the onboard CPU_Fan connector.

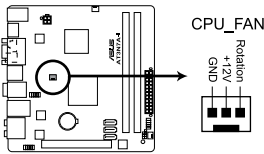

AT3N7A-I CPU fan connector

1.4 System memory

1.4.1 Overview

The motherboard comes with two Double Data Rate 2 (DDR2) Dual Inline Memory Modules (DIMM) sockets. The figure illustrates the location of the DDR2 DIMM sockets:

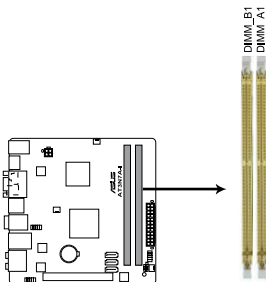

AT3N7A-I 240-pin DDR2 DIMM sockets

Channel	Sockets
Channel A	DIMM_A1
Channel B	DIMM_B1

1.4.2 Memory configurations

You may install 512MB, 1GB, and 2GB unbuffered non-ECC DDR2 DIMMs into the DIMM sockets.



- You may install varying memory sizes in Channel A and Channel B. The system maps the total size of the lower-sized channel for the dual-channel configuration. Any excess memory from the higher-sized channel is then mapped for the single-channel operation.
- Always install DIMMs with the same CAS latency. For optimum compatibility, it is recommended that you obtain memory modules from the same vendor.
- Due to the memory address limitation on 32-bit Windows® OS, when you install 4GB or more memory on the motherboard, the actual usable memory for the OS can be about 3GB or less. For effective use of memory, we recommend that you do any of the following:
 - Use a maximum of 3GB system memory if you are using a 32-bit Windows® OS.
 - Install a 64-bit Windows® OS when you want to install 4GB or more memory on the motherboard.
- This motherboard does not support DIMMs made up of 256 megabits (Mb) chips or less.



This motherboard supports up to 4GB on Windows® XP Professional x64 and Windows® Vista x64 editions. You may install a maximum of 2GB DIMMs on each slot.

AT3N7A-I Motherboard Qualified Vendors Lists (QVL)

DDR2-667 MHz capability

Size	Vendor	Part No.	SS/ DS	Chip Brand	Chip NO.	CL	DIMM support	
							A*	B*
2048MB	A-Data	M20AD5H3J41701C53	DS	ADATA	AD20908A8A-3EG 30724	N/A	•	•
512MB	Apacer	78.91G92.9K5	SS	Apacer	AM4B5708JQJS7E0751C	5	•	•
512MB	Apacer	AU 512E667C5KBGC	SS	Apacer	AM4B5708GQJS7E06332F	5	•	•
512MB	Apacer	AU 512E667C5KBGC	SS	Apacer	AM4B5708MIJS7E0627B	5	•	•
1024MB	Apacer	78.01G90.9K5	SS	Apacer	AM4B5808CQJS7E0751C	5	•	•
1024MB	Apacer	AU01GE667C5KBGC	DS	Apacer	AM4B5708GQJS7E0636B	N/A	•	•
1024MB	Apacer	AU01GE667C5KBGC	DS	Apacer	AM4B5708MIJS7E0627B	5	•	•
2048MB	Apacer	78.A1G90.9K4	DS	Apacer	AM4B5808CQJS7E0749B	5	•	•
512MB	Corsair	VS 512MB667D2	DS	Corsair	MIII0052532M8CEC	N/A	•	•
1024MB	Corsair	VS1GB667D2	DS	Corsair	MID095D62864M8CEC	N/A	•	•
2048MB(Kit of 2)G.SKILL	F2-5400PHU2-2GBNT		DS	G.SKILL	D2 64M8CCF 0815 C7173S	5-5-5-15	•	•

DDR2-800 MHz capability

Size	Vendor	Part No.	SS/DS	Chip Brand	Chip NO.	CL	DIMM support A* B*
2048MB(Kit of 2)	A-Data	AD2800E001G0U	SS	N/A	Heat-Sink Package	4-4-4-12	• •
1024MB	A-Data	M2GV06G314170Q1E58	DS	VDATA	VD29608A8A-25EG80813	N/A	• •
2048MB	A-Data	AD2800002GMU	DS	Hynix	Heat-Sink Package	N/A	• •
4096MB(Kit of 2)	A-Data	AD2800E002G0U	DS	N/A	Heat-Sink Package	4-4-4-12	• •
512MB	Apacer	78.91G91.9K5	SS	Apacer	AM4B5708JQJS8E0751C	5	• •
1024MB	Apacer	78.01GA0.9L5	SS	Apacer	AM4B5808FEWS8E0909C5	•	• •
2048MB	Apacer	78.A1GA0.9L4	DS	Apacer	AM4B5808FEWS8E0909C5	•	• •
1024MB	Corsair	CM2X1024-6400	DS	Corsair	Heat-Sink Package	N/A	• •
1024MB	Corsair	XMS2-6400	DS	Corsair	Heat-Sink Package	4	• •
1024MB	Corsair	XMS2-6400	DS	Corsair	Heat-Sink Package	5	• •
4096MB(Kit of 2)	Corsair	CM2X2048-6400C5DHX	DS	N/A	Heat-Sink Package	5	• •
4096MB(Kit of 2)	Corsair	CM2X2048-6400C5	DS	N/A	Heat-Sink Package	5	• •
2048MB(kit of 2)	Crucial	BL12864AL80A.8FE5(EPP)	SS	N/A	Heat-Sink Package	4-4-4-12	• •
2048MB	Crucial	CT25664AA800.16FG	DS	Micron	8ZG27 D9JWB	6-6-6-12	• •
4096MB(kit of 2)	Crucial	BL25664AL80A.16FE5(EPP)	DS	N/A	Heat-Sink Package	4-4-4-12	• •
4096MB(kit of 2)	Crucial	BL25664AR80A.16FE5(EPP)	DS	N/A	Heat-Sink Package	4-4-4-12	• •
512MB	G.SKILL	F2-6400CL5D-1GBNQ	SS	G.SKILL	Heat-Sink Package SN :8151030036642	5-5-5-15	• •
1024MB	G.SkILL	F2-6400PHU2-2GBNR	SS	N/A	Heat-Sink Package	5-5-5-15	• •
1024MB	G.SKILL	F2-6400CL4D-2GBPK	DS	G.SKILL	Heat-Sink Package	4	• •
1024MB	G.SKILL	F2-6400CL5D-2GBNQ	DS	G.SKILL	Heat-Sink Package	5	• •
2048MB	G.SKILL	F2-6400CL4D-4GBPK	DS	G.SKILL	Heat-Sink Package	4	• •
2048MB	G.SKILL	F2-6400CL5D-4GBPQ	DS	G.SKILL	Heat-Sink Package	5	• •
4096MB(Kit of 2)	G.SkILL	F2-6400CL6D-4GBMQ	DS	N/A	Heat-Sink Package	6-6-6-18	• •
4096MB	G.SKILL	F2-6400CL6Q-16GMQ	DS	N/A	Heat-Sink Package	5	• •
1024MB	GEIL	GB22GB6400C4DC	DS	GEIL	GL2L64M088BA30EB	5	• •
1024MB	GEIL	GB22GB6400C5DC	DS	GEIL	GL2L64M088BA30EB	5	• •
1024MB	GEIL	GB24GB6400C4QC	DS	GEIL	GL2L64M088BA30EB	4	• •
1024MB	GEIL	GB24GB6400C5QC	DS	GEIL	GL2L64M088BA30EB	5	• •
1024MB	GEIL	GE22GB800C4DC	DS	GEIL	Heat-Sink Package	4	• •
1024MB	GEIL	GE22GB800C5DC	DS	GEIL	Heat-Sink Package	5	• •
1024MB	GEIL	GE24GB800C4QC	DS	GEIL	Heat-Sink Package	4	• •
1024MB	GEIL	GE24GB800C5QC	DS	GEIL	Heat-Sink Package	5	• •
1024MB	GEIL	GX22GB6400DC	DS	GEIL	Heat-Sink Package	5	• •
1024MB	GEIL	GX22GB6400UDC	DS	GEIL	Heat-Sink Package	4	• •
2048MB	GEIL	GB24GB6400C4DC	DS	GEIL	Heat-Sink Package	5	• •
2048MB	GEIL	GB24GB6400C5DC	DS	GEIL	GL2L128M88BA25AB	5	• •
2048MB	GEIL	GB28GB6400C4DC	DS	GEIL	GL2L128M88BA25AB	4	• •
2048MB	GEIL	GB28GB6400C5QC	DS	GEIL	GL2L128M88BA25AB	5	• •
2048MB	GEIL	GE24GB800C4DC	DS	GEIL	Heat-Sink Package	4	• •
2048MB	GEIL	GE24GB800C5DC	DS	GEIL	Heat-Sink Package	5	• •
2048MB	GEIL	GE28GB800C4QC	DS	GEIL	Heat-Sink Package	4	• •
2048MB	GEIL	GE28GB800C5QC	DS	GEIL	Heat-Sink Package	5	• •
2048MB	GEIL	GX22GB6400C4JUC	DS	GEIL	Heat-Sink Package	4	• •
2048MB	GEIL	GX22GB6400LX	DS	GEIL	Heat-Sink Package	5	• •
2048MB	GEIL	GX24GB6400DC	DS	GEIL	Heat-Sink Package	5	• •
1024MB	Kingmax	KLDD48F-B8KU5 NGES	SS	Kingmax	KKB8FNUBF-DNX-25A	N/A	• •
2048MB	kingmax	KLDE88F-B8KU5 NHES	DS	kingmax	KKB8FNUBF-DNX-25A	N/A	• •
512MB	Kingston	KVR800D2N5/ 512(low profile)	SS	ELPIDA	E5108AJBG-8E-E	N/A	• •
512MB	Kingston	KVR800D2N6/ 512	SS	Elpida	E5108AJBG-8E-E	6	• •
1024MB(Kit of 2)	Kingston	KHX6400D2LLK2/1GN	SS	Kingston	Heat-Sink Package	4-4-4-12	• •
1024MB	Kingston	KVR800D2N5/1G(low profile)	SS	Elpida	E1108AEBG-8E-F	5	• •
1024MB	Kingston	KVR800D2N6/1G(low profile)	SS	Samsung	K4T1G084QE	6	• •
2048MB(Kit of 2)	Kingston	KHX6400D2K2/2G	DS	N/A	Heat-Sink Package	5-5-5-15	• •
2048MB	Kingston	KVR800D2N5/2G(low profile)	DS	Kingston	D1288TEFCGL25U	5	• •
2048MB	Kingston	KVR800D2N6/2G(low profile)	DS	Samsung	K4T1G084QE	6	• •
4096MB	Kingston	KVR800D2N6/4G	DS	Elpida	E2108ABSE-8G-E	6	• •
2048MB	Micron	MT16HTF25664AY-800G1	DS	Micron	8ZG27 D9JWB	6-6-6-12	• •
1024MB	OCZ	OC22P800R22GK	DS	OCZ	Heat-Sink Package	4-4-4-15	• •
1024MB	OCZ	OC22RPR8002GK	DS	OCZ	Heat-Sink Package	4-4-4-15	• •

(continued on the next page)

DDR2-800 MHz capability

Size	Vendor	Part No.	SS/DS	Chip Brand	Chip NO.	CL	DIMM support A* B*
1024MB	OCZ	OCZ2VU8004GK	DS	OCZ	Heat-Sink Package	5-6-6-18	• •
2048MB(Kit of 2)	OCZ	OCZ2SE8002GK	DS	N/A	Heat-Sink Package	5-5-5-15	• •
2048MB	OCZ	OCZ2F8004GK(EPP)	DS	N/A	Heat-Sink Package	5-4-4-18	• •
4096MB(Kit of 2)	OCZ	OCZ2P8004GK	DS	N/A	Heat-Sink Package	5-4-4-15	• •
4096MB(Kit of 2)	OCZ	OCZ2VU8004GK	DS	N/A	Heat-Sink Package	5-6-6-18	• •
1024MB	PSC	AL7E8G73F-8E1	SS	PSC	P3R1GE3FGF850MAC19	N/A	• •
2048MB	PSC	AL8E8F73C-8E1	DS	PSC	A3R1GE3CFF734MAA0E	5	• •
2048MB	PSC	AL8E8G73F-8E1	DS	PSC	P3R1GE3FGF850MAC19	N/A	• •
2048MB	PSC	PL8E8F73C-8E1	DS	PSC	SHG772-AA3G	5	• •
2048MB	PSC	PL8E8G73E-8E1	DS	PSC	XCP271A3G-A	5	• •
512MB	SAMSUNG	M378T6553GZS-CF7	SS	Qimonda	K4T51083QG-HCF7	6	• •
1024MB	SAMSUNG	M378T2863EHS-CF7	SS	Samsung	K4T1G084QE	N/A	• •
1024MB	SAMSUNG	M378T2863QZS-CF7	SS	Qimonda	K4T1G084QQ-HCF7	6	• •
1024MB	SAMSUNG	M378T2953GZ3-CF7	DS	Samsung	K4T51083QG	N/A	• •
1024MB	SAMSUNG	M378T2953GZ3-CF7	DS	Samsung	K4T51083QG-HCF7	6	• •
2048MB	SAMSUNG	M37875663QZ3-CF7	DS	Samsung	K4T1G084QQ-HCF7	6	• •
4096MB	SAMSUNG	M378T5263AZ3-CF7	DS	Samsung	K4T2G084QA-HCF7	N/A	• •
1024MB	Super Talent	T800UB1GC4	DS	Super Talent	Heat-Sink Package	4	• •
512MB	Transcend	TS64MLQ64V8J	SS	Micron	7HD22 D9GMH	5	• •
1024MB	Transcend	JM800QLU-1G	SS	Transced	TQ1243PCF8	5	• •
1024MB	Transcend	TS128MLQ64V8U	SS	ELPIDA	E1108ACBG-8E-E	5	• •
1024MB	Transcend	JM800QLJ-1G	DS	Transced	TQ123PJF8F081	5	• •
1024MB	Transcend	JM800QLJ-1G	DS	Transced	TQ123YBF8 T0747	5	• •
1024MB	Transcend	TS128MLQ64V8J	DS	Mircon	7HD22D9GMH	5	• •
2048MB	Transcend	JM800QLU-2G	DS	Transced	TQ243PCF8	5	• •
2048MB	Transcend	TS256MLQ64V8U	DS	Elpida	E1108ACBG-8E-E	5	• •
1024MB	ASINT	SLY2128M8-JGE	SS	ASINT	DDR11208-GE 8115	N/A	• •
2048MB	ASINT	SLZ2128M8-JGE	DS	ASINT	DDR11208-GE 8115	N/A	• •
1024MB	Century	28V0H8	DS	Hynix	HY5PS12821CFPP-S5	5	• •
1024MB	Elixir	M2Y1G64TU88D5B-AC 0828_GS	SS	Elixir	N2TU16800E-AC	N/A	• •
2048MB	Elixir	M2Y2G64TU88HD5B-AC 0826_SG	DS	Elixir	N2TUG80DE-AC	N/A	• •
1024MB	Kingtiger	M9CA0Y6109	DS	Hynix	HY5PS12821C FP-S5	N/A	• •
2048MB	Kingtiger	KTG2G800PG2	DS	N/A	Heat-Sink Package	N/A	• •
2048MB	Kingtiger	M9CA0X8793	DS	Hynix	HY5PS1G831C FP-S6	N/A	• •
1024MB	MDT	MDT 1024MB	DS	MDT	18D 51280D-2.50726E	5	• •
4096MB(Kit of 2)	PATRIOT	PDC24G6400ELK	DS	N/A	Heat-Sink Package	5-5-5-12	• •
512MB	TAKEMS	TMS51B264C081-805EP	SS	takeMS	MS18T 51280-2.5P0710	5	• •
1024MB	TAKEMS	TMS1GB264D082-805EE	SS	TAKEMS	WS18T1G80-205 E0905	5	• •
1024MB	TAKEMS	TMS1GB264C081-804EE	DS	TAKEMS	Heat-Sink Package	4-4-4-12	• •
1024MB	TAKEMS	TMS1GB264C081-805EP	DS	takeMS	MS18T 51280-2.5P0716	5	• •
2048MB	TAKEMS	TMS2GB264D081-805KE	DS	TAKEMS	MS18T1G80-205 E0907	5	• •
1024MB	UMAX	D48001GP3-63BJU	DS	UMAX	U2S12D30TP-8E	N/A	• •
2048MB	UMAX	D48002GP0-73BCJU	DS	UMAX	U2S24D30TP-8E	5	• •
512MB	V-Data	M2GVD6G3H3160Q1E52	SS	VDATA	VD29608A8A-25EG20813	N/A	• •
1024MB	V-Data	M2XSSK3147C1L1C5Z	DS	Samsung	K4T51083QE	N/A	• •



SS: Single-sided / **DS:** Double-sided

DIMM support:

- **A*:** Supports one module inserted into either slot as the single-channel memory configuration.
- **B*:** Supports one pair of modules inserted into both the yellow slots as one pair of dual-channel memory configuration.



Visit the ASUS website at www.asus.com for the latest QVL.

1.5 Expansion slot

In the future, you may need to install expansion cards. The following sub-sections describe the slot and the expansion cards that it supports.



Unplug the power cord before adding or removing expansion cards. Failure to do so may cause you physical injury and damage motherboard components.

1.5.1 Installing an expansion card

To install an expansion card:

1. Before installing the expansion card, read the documentation that came with it and make the necessary hardware settings for the card.
2. Remove the system unit cover (if your motherboard is already installed in a chassis).
3. Remove the bracket opposite the slot that you intend to use. Keep the screw for later use.
4. Align the card connector with the slot and press firmly until the card is completely seated on the slot.
5. Secure the card to the chassis with the screw you removed earlier.
6. Replace the system cover.

1.5.2 Configuring an expansion card

After installing the expansion card, configure it by adjusting the software settings.

1. Turn on the system and change the necessary BIOS settings, if any. See Chapter 2 for information on BIOS setup.
2. Assign an IRQ to the card.
3. Install the software drivers for the expansion card.

1.5.3 PCI slot

The PCI slot supports cards such as a LAN card, SCSI card, USB card, and other cards that comply with PCI specifications.

1.6 Jumpers

1. Clear RTC RAM (3-pin CLRRTC)

This jumper allows you to clear the Real Time Clock (RTC) RAM in CMOS. You can clear the CMOS memory of date, time, and system setup parameters by erasing the CMOS RTC RAM data. The onboard button cell battery powers the RAM data in CMOS, which include system setup information such as system passwords.

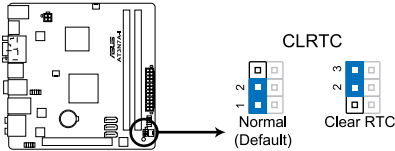

AT3N7A-I Clear RTC RAM

To erase the RTC RAM:

1. Turn OFF the computer and unplug the power cord.
2. Move the jumper cap from pins 1-2 (default) to pins 2-3. Keep the cap on pins 2-3 for about 5-10 seconds, then move the cap back to pins 1-2.
3. Plug the power cord and turn ON the computer.
4. Hold down the key during the boot process and enter BIOS setup to re-enter data.



Except when clearing the RTC RAM, never remove the cap on CLRRTC jumper default position. Removing the cap will cause system boot failure!



If the steps above do not help, remove the onboard battery and move the jumper again to clear the CMOS RTC RAM data. After clearing the CMOS, reinstall the battery.

1.7 Connectors

1.7.1 Rear panel connectors

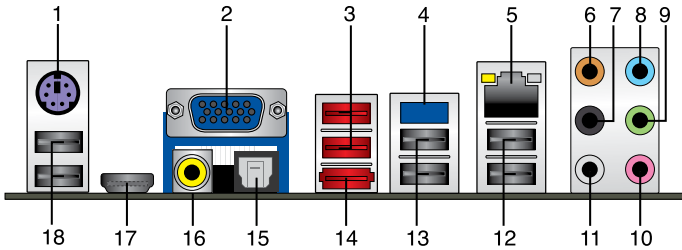

1. **PS/2 Keyboard port (purple).** This port is for a PS/2 keyboard.
2. **Video Graphics Adapter (VGA) port.** This 15-pin port is for a VGA monitor or other VGA-compatible devices.
3. **USB 2.0 ports 5 and 6.** These two 4-pin Universal Serial Bus (USB) ports are available for connecting USB 2.0 devices.
4. **Onboard Bluetooth module.** This onboard Bluetooth module allows wireless connection and data transfer between your system and other Bluetooth devices.



- Due to the limitations of the Bluetooth driver and the Windows® 7 OS beta version, some Bluetooth functions may not be supported in Windows® 7 OS beta version, and Windows® 7 beta version may not recognize the onboard Bluetooth module.
- When Windows® 7 OS is officially released, we will release an updated Bluetooth driver, which will provide the complete Bluetooth functions. Download the latest Bluetooth driver from the ASUS support website at <http://support.asus.com>.

5. **LAN (RJ-45) port.** This port allows Gigabit connection to a Local Area Network (LAN) through a network hub. Refer to the table below for the LAN port LED indications.

LAN port LED indications

ACT/LINK LED		SPEED LED	
Status	Description	Status	Description
OFF	No link	OFF	10 Mbps connection
ORANGE	Linked	ORANGE	100 Mbps connection
BLINKING	Data activity	GREEN	1 Gbps connection

ACT/LINK LED SPEED LED



LAN port

6. **Center/Subwoofer port (orange).** This port connects to the center/subwoofer speakers.
7. **Rear Speaker Out port (black).** This port connects to the rear speakers in the 4, 6, and 8-channel audio configurations.
8. **Line In port (light blue).** This port connects to the tape, CD, DVD player, or other audio sources.

9. **Line Out port (lime).** This port connects to a headphone or a speaker. In the 4, 6 and 8-channel configurations, the function of this port becomes Front Speaker Out.
10. **Microphone port (pink).** This port connects to a microphone.
11. **Side Speaker Out port (gray).** This port connects to the side speakers in the 8-channel audio configuration.



Refer to the audio configuration table below for the function of the audio ports in the 2, 4, 6, or 8-channel configuration.

Audio 2, 4, 6, or 8-channel configuration

Port	Headset 2-channel	4-channel	6-channel	8-channel
Light Blue	Line In	Line In	Line In	Line In
Lime	Line Out	Front Speaker Out	Front Speaker Out	Front Speaker Out
Pink	Mic In	Mic In	Mic In	Mic In
Orange	–	–	Center/Subwoofer	Center/Subwoofer
Black	–	Rear Speaker Out	Rear Speaker Out	Rear Speaker Out
Gray	–	–	–	Side Speaker Out



Ensure the audio device of sound playback is **VIA High Definition Audio** (the name may be different based on the OS). Go to **Start > Control Panel > Sounds and Audio Devices > Sound Playback** to configure the settings.

12. **USB 2.0 ports 1 and 2.** These two 4-pin Universal Serial Bus (USB) ports are for USB 2.0 devices.
13. **USB 2.0 ports 3 and 4.** These two 4-pin Universal Serial Bus (USB) ports are for USB 2.0 devices.
14. **eSATA port.** This port connects to an external Serial ATA hard disk drive.



To use hot-plug, set the **SATA Mode Select** item in the BIOS to **[AHCI Mode]**. See section **2.3.4 Storage Configuration** for details.

15. **Optical S/PDIF Out port.** This port connects to an external audio output device via an optical S/PDIF cable.
16. **Coaxial S/PDIF Out port.** This port connects to an external audio output device via a coaxial S/PDIF cable.
17. **HDMI port.** This port is for a High-Definition Multimedia Interface (HDMI) connector, and is HDCP compliant allowing playback of HD DVD, Blu-Ray, and other protected content.
18. **USB 2.0 ports 7 and 8.** These two 4-pin Universal Serial Bus (USB) ports are for USB 2.0 devices.

1.7.2 Internal connectors

1. ATX power connectors (24-pin EATXPWR, 4-pin ATX12V)

These connectors are for ATX power supply plugs. The power supply plugs are designed to fit these connectors in only one orientation. Find the proper orientation and push down firmly until the connectors completely fit.

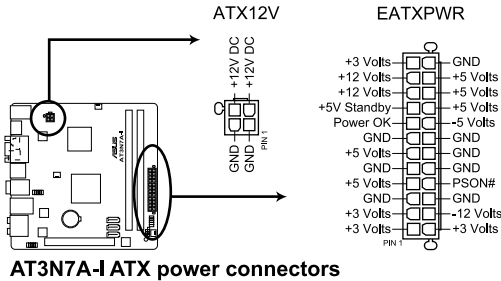

AT3N7A-I ATX power connectors



- We recommend that you use an ATX 12V Specification 2.0-compliant power supply unit (PSU) with a minimum of 400W power rating. This PSU type has 24-pin and 4-pin power plugs.
- If you intend to use a PSU with 20-pin and 4-pin power plugs, ensure that the 20-pin power plug can provide at least 15 A on +12 V and that the PSU has a minimum power rating of 400W. The system may become unstable or may not boot up if the power is inadequate.
- DO NOT forget to connect the 4-pin ATX +12V power plug. Otherwise, the system will not boot up.
- We recommend that you use a PSU with higher power output when configuring a system with more power-consuming devices or when you intend to install additional devices. The system may become unstable or may not boot up if the power is inadequate.
- If you are uncertain about the minimum power supply requirement for your system, refer to the Recommended Power Supply Wattage Calculator at <http://support.asus.com/PowerSupplyCalculator/PSCalculator.aspx?SLanguage=en-us> for details.

2. Serial ATA connectors (7-pin SATA1, SATA2, SATA3)

These connectors are for the Serial ATA signal cables for Serial ATA 3Gb/s hard disk drives and optical disk drives. The Serial ATA 3Gb/s is backward compatible with the Serial ATA 1.5Gb/s specification. The data transfer rate of the Serial ATA 3Gb/s is faster than the standard parallel ATA (133 MB/s).

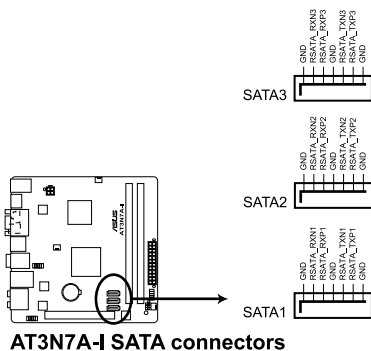

AT37A-I SATA connectors



- Install the Windows® XP Service Pack 1 or later versions before using Serial ATA.
- If you intend to create a Serial ATA RAID set using these connectors, set the **SATA Mode Select** item in the BIOS to **[RAID Mode]**. See **2.3.4 Storage Configuration** for details.
- The motherboard does not provide a floppy disk drive connector. You could use a USB floppy disk drive when installing Windows® XP operating system on a hard disk drive that includes a RAID/AHCI set.
- Due to Windows® XP limitation, Windows® XP may not recognize the USB floppy disk drive.
- The motherboard does not support installing Windows® XP OS with SATA ODD under RAID/AHCI mode.
- You need to copy RAID driver to other media such as a USB flash disk and load RAID driver during installing Windows® Vista OS with SATA ODD.
- For more details on RAID/AHCI, refer to the RAID/AHCI Supplementary Guide included in the folder named Manual in the support DVD.

3. USB connector (10-1 pin USB910)

This connector is for a USB 2.0 port. Connect the USB module cable to this connector, then install the module to a slot opening at the back of the system chassis. This USB connector complies with USB 2.0 specification that supports up to 480 Mbps connection speed.

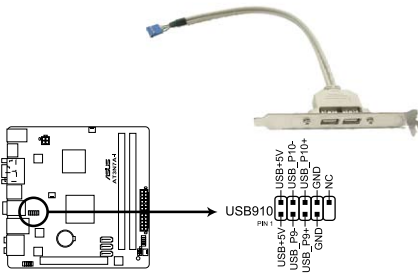

AT3N7A-I USB2.0 connector



Never connect a 1394 cable to the USB connector. Doing so will damage the motherboard!



The USB module cable is purchased separately.

4. Chassis intrusion connector (4-1 pin CHASSIS)

This connector is for a chassis-mounted intrusion detection sensor or switch. Connect one end of the chassis intrusion sensor or switch cable to this connector. The chassis intrusion sensor or switch sends a high-level signal to this connector when a chassis component is removed or replaced. The signal is then generated as a chassis intrusion event.

By default, the pin labeled “Chassis Signal” and “Ground” are shorted with a jumper cap. Remove the jumper caps only when you intend to use the chassis intrusion detection feature.

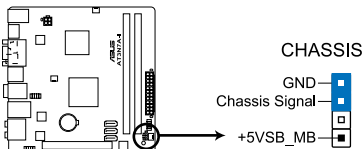

AT3N7A-I Chassis intrusion connector

5. CPU, power, and chassis fan connectors (3-pin CPU_FAN, 3-pin PWR_FAN, 3-pin CHA_FAN)

The fan connectors support cooling fans of 350 mA~2000 mA (24 W max.) or a total of 1 A~3.48 A (41.76 W max.) at +12V. Connect the fan cables to the fan connectors on the motherboard, ensuring that the black wire of each cable matches the ground pin of the connector.



Do not forget to connect the fan cables to the fan connectors. Insufficient air flow inside the system may damage the motherboard components. These are not jumpers! Do not place jumper caps on the fan connectors!

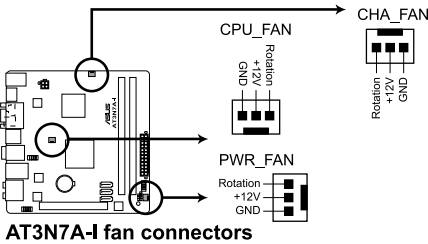

6. Front panel audio connector (10-1 pin AAFP)

This connector is for a chassis-mounted front panel audio I/O module that supports either HD Audio or legacy AC '97 audio standard. Connect one end of the front panel audio I/O module cable to this connector.

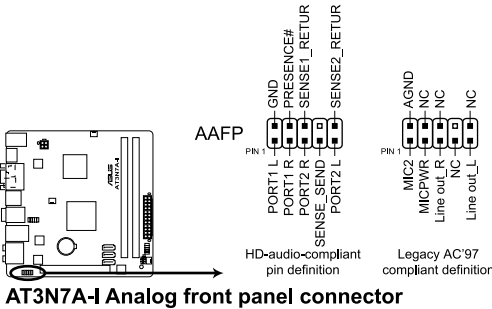

- We recommend that you connect a high-definition front panel audio module to this connector to avail of the motherboard's high-definition audio capability.
- If you want to connect a high-definition front panel audio module to this connector, set the **Front Panel Select** item in the BIOS setup to **[HD Audio]**. If you want to connect an AC'97 front panel audio module to this connector, set the item to **[AC97]**. By default, this connector is set to **[HD Audio]**. See section 2.4.4 **Onboard Devices Configuration** for details.

7. System panel connector (10-1 pin F_PANEL)

This connector supports several chassis-mounted functions.

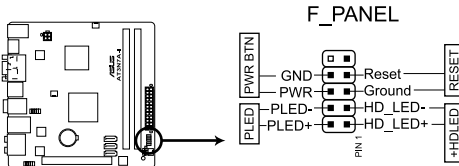

AT3N7A-I System panel connector

- **System power LED (2-pin PLED)**

This 2-pin connector is for the system power LED. Connect the chassis power LED cable to this connector. The system power LED lights up when you turn on the system power, and blinks when the system is in sleep mode.

- **Hard disk drive activity LED (2-pin HD_LED)**

This 2-pin connector is for the HDD Activity LED. Connect the HDD Activity LED cable to this connector. The HD LED lights up or flashes when data is read from or written to the HDD.

- **ATX power button/soft-off button (2-pin PWRBTN)**

This connector is for the system power button. Pressing the power button turns the system on or puts the system in sleep or soft-off mode depending on the BIOS settings. Pressing the power switch for more than four seconds while the system is ON turns the system OFF.

- **Reset button (2-pin RESET)**

This 2-pin connector is for the chassis-mounted reset button for system reboot without turning off the system power.

1.8 Software support

1.8.1 Installing an operating system

This motherboard supports Windows® XP/Vista Operating Systems (OS). Always install the latest OS version and corresponding updates to maximize the features of your hardware.



- Motherboard settings and hardware options vary. Refer to your OS documentation for detailed information.
- Ensure that you install Windows® XP Service Pack 3 or later versions / Windows® Vista Service Pack 1 or later versions before installing the drivers for better compatibility and system stability.

1.8.2 Support DVD information

The Support DVD that comes with the motherboard package contains the drivers, software applications, and utilities that you can install to avail all motherboard features.



The contents of the Support DVD are subject to change at any time without notice. Visit the ASUS website at www.asus.com for updates.

To run the Support DVD

Place the Support DVD to the optical drive. The DVD automatically displays the Drivers menu if Autorun is enabled in your computer.



The following screen is for reference only.



Click an icon to display Support DVD/ motherboard information

Click an item to install



If Autorun is NOT enabled in your computer, browse the contents of the Support DVD to locate the file ASSETUP.EXE from the BIN folder. Double-click the ASSETUP.EXE to run the DVD.

Chapter 2

BIOS information

2.1 Managing and updating your BIOS



Save a copy of the original motherboard BIOS file to a USB flash disk in case you need to restore the BIOS in the future. Copy the original motherboard BIOS using the ASUS Update utility.

2.1.1 ASUS Update utility

The ASUS Update is a utility that allows you to manage, save, and update the motherboard BIOS in Windows® environment.



- ASUS Update requires an Internet connection either through a network or an Internet Service Provider (ISP).
 - This utility is available in the support DVD that comes with the motherboard package.
-

Installing ASUS Update

To install ASUS Update:

1. Place the support DVD in the optical drive. The **Drivers** menu appears.
2. Click the **Utilities** tab, then click **ASUS Update**.
3. Follow the onscreen instructions to complete the installation.



Quit all Windows® applications before you update the BIOS using this utility.

Updating the BIOS

To update the BIOS:

1. From the Windows® desktop, click **Start > Programs > ASUS > ASUSUpdate > ASUSUpdate** to launch the ASUS Update utility.
2. From the dropdown list, select any of the updating process:

Updating from the Internet

- a. Select **Update BIOS from the Internet**, then click **Next**.
- b. Select the ASUS FTP site nearest you to avoid network traffic, or click **Auto Select** then click **Next**.
- c. From the FTP site, select the BIOS version that you wish to download then click **Next**.



The ASUS Update utility is capable of updating itself through the Internet. Always update the utility to avail all its features.

Updating from a BIOS file

- a. Select **Update BIOS from a file**, then click **Next**.
 - b. Locate the BIOS file from the **Open** window, then click **Open**.
3. Follow the onscreen instructions to complete the updating process.

2.1.2 ASUS EZ Flash 2

The ASUS EZ Flash 2 feature allows you to update the BIOS without using an OS-based utility.



Before you start using this utility, download the latest BIOS file from the ASUS website at www.asus.com.

To update the BIOS using EZ Flash 2:

1. Insert the USB flash disk that contains the latest BIOS file to the USB port, then launch EZ Flash 2 in any of these two ways:
 - Press **<Alt> + <F2>** during POST.
 - Enter the BIOS setup program. Go to the **Tools** menu to select **EZ Flash 2** and press **<Enter>** to enable it.

Press **<Tab>** to switch between drives until the correct BIOS file is found.

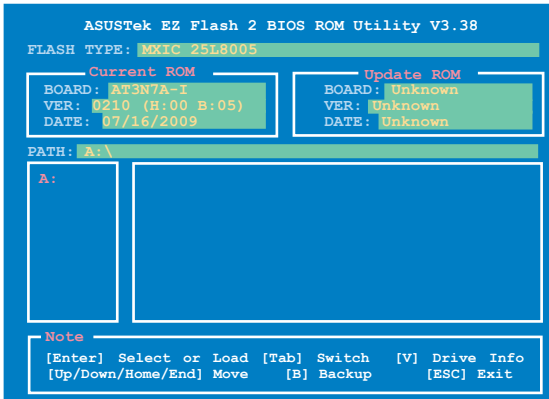

2. When the correct BIOS file is found, EZ Flash 2 performs the BIOS update process and automatically reboots the system when done.



-
- This function supports USB flash disks with **FAT 32/16** format and single partition only.
 - **DO NOT** shut down or reset the system while updating the BIOS to prevent system boot failure!
-

2.1.3 ASUS CrashFree BIOS

The ASUS CrashFree BIOS is an auto recovery tool that allows you to restore the BIOS file when it fails or gets corrupted during the updating process. You can restore a corrupted BIOS file using the motherboard support DVD or a removable device that contains the updated BIOS file.



-
- The BIOS file in the support DVD may not be the latest version. Download the latest BIOS file from the ASUS website at www.asus.com.
 - The removable devices that ASUS CrashFree BIOS support vary with motherboard models. For motherboards without the floppy connector, prepare a USB flash disk before using this utility.
-

Recovering the BIOS

To recover the BIOS:

1. Turn on the system.
2. Insert the support DVD to the optical drive or the removable device that contains the BIOS file to the USB port or to the floppy disk drive, if supported.
3. The utility automatically checks the devices for the BIOS file. When found, the utility reads the BIOS file and starts flashing the corrupted BIOS file.
4. Turn off the system after the utility completes the updating process and turn on again.



DO NOT shut down or reset the system while updating the BIOS! Doing so can cause system boot failure!



Ensure to load the BIOS default settings to ensure system compatibility and stability. Select the **Load Setup Defaults** item under the Exit menu. Refer to section **2.8 Exit menu** for details.

2.2 BIOS setup program

Use the BIOS Setup program to update the BIOS or configure its parameters. The BIOS screens include navigation keys and brief online help to guide you in using the BIOS Setup program.

Entering BIOS Setup at startup

To enter BIOS Setup at startup:

- Press <Delete> during the Power-On Self Test (POST). If you do not press <Delete>, POST continues with its routines.

Entering BIOS Setup after POST

To enter BIOS Setup after POST:

- Press <Ctrl>+<Alt>+ simultaneously.
- Press the reset button on the system chassis.
- Press the power button to turn the system off then back on. Do this option only if you failed to enter BIOS Setup using the first two options.



Using the **power button**, **reset button**, or the <Ctrl>+<Alt>+ keys to force reset from a running operating system can cause damage to your data or system. We recommend to always shut down the system properly from the operating system.



- The default BIOS settings for this motherboard apply for most conditions to ensure optimum performance. If the system becomes unstable after changing any BIOS settings, load the default settings to ensure system compatibility and stability. Select the **Load Setups Default** item under the Exit Menu. See section 2.8 Exit Menu.
- The BIOS setup screens shown in this section are for reference purposes only, and may not exactly match what you see on your screen.
- Visit the ASUS website at www.asus.com to download the latest BIOS file for this motherboard.

2.3 Main menu

When you enter the BIOS Setup program, the **Main** menu screen appears, giving you an overview of the basic system information.

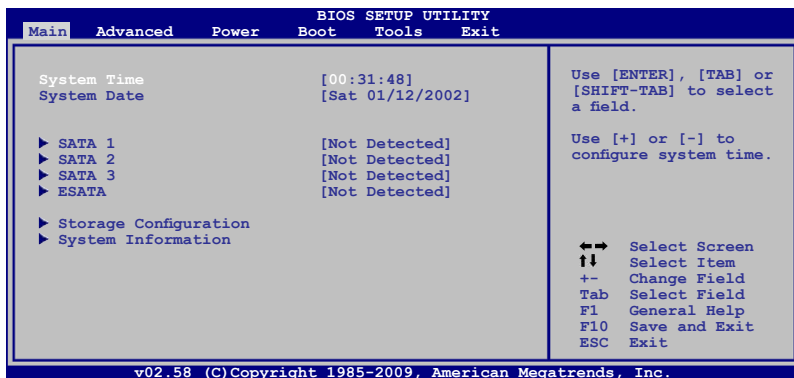

2.3.1 System Time [xx:xx:xx]

Allows you to set the system time.

2.3.2 System Date [Day xx/xx/xxxx]

Allows you to set the system date.

2.3.3 SATA 1~3, ESATA

While entering Setup, the BIOS automatically detects the presence of SATA devices. There is a separate sub-menu for each SATA device. Select a device item then press <Enter> to display the SATA device information.

The BIOS automatically detects the values opposite the dimmed items (Device, Vendor, Size, LBA Mode, Block Mode, PIO Mode, Async DMA, Ultra DMA, and SMART Monitoring). These values are not user-configurable. These items show Not Detected if no Serial ATA device is installed in the system.

Type [Auto]

Selects the type of SATA drive. Setting to Auto allows automatic selection of the appropriate SATA device type. Select CDROM if you are specifically configuring a CD-ROM drive. Select ARMD (ATAPI Removable Media Device) if your device is either a ZIP, LS-120, or MO drive. Configuration options: [Not Installed] [Auto] [CDROM] [ARMD]

LBA/Large Mode [Auto]

Enables or disables the LBA mode. Setting to [Auto] enables the LBA mode if the device supports this mode, and if the device was not previously formatted with LBA mode disabled. Configuration options: [Disabled] [Auto]

Block (Multi-sector Transfer) M [Auto]

Enables or disables data multi-sectors transfers. When set to [Auto], the data transfer from and to the device occurs multiple sectors at a time if the device supports multi-sector transfer feature. When set to [Disabled], the data transfer from and to the device occurs one sector at a time. Configuration options: [Disabled] [Auto]

PIO Mode [Auto]

Selects the PIO mode. Configuration options: [Auto] [0] [1] [2] [3] [4]

DMA Mode [Auto]

Selects the DMA mode. Configuration options: [Auto]

SMART Monitoring [Auto]

Sets the Smart Monitoring, Analysis, and Reporting Technology. Configuration options: [Auto] [Disabled] [Enabled]

32Bit Data Transfer [Enabled]

Enables or disables 32-bit data transfer. Configuration options: [Disabled] [Enabled]

2.3.4 Storage Configuration

The items in this menu allow you to set or change the configurations for the SATA devices installed in the system. Select an item then press <Enter> if you want to configure the item.

OnChip S-ATA Controller [Enabled]

Enables or disables the OnChip SATA controller. Configuration options: [Disabled] [Enabled]

SATA Mode Select [SATA Mode]

This item appears only when you set the OnChip SATA Controller item to [Enabled]. Allows you to set the OnChip SATA mode. Configuration options: [SATA Mode] [RAID Mode] [AHCI Mode]

Hard Disk Write Protect [Disabled]

Disables or enables device write protection. This will be effective only if device is accessed through BIOS. Configuration option: [Disabled] [Enabled]

IDE Detect Time Out (Sec) [5]

Selects the time out value for detecting ATA/ATAPI devices. Configuration options: [0] [5] [10] [15] [20] [25] [30] [35]

2.3.5 System Information

This menu gives you an overview of the general system specifications. The BIOS automatically detects the items in this menu.

BIOS Information

Displays the auto-detected BIOS information.

Processor

Displays the auto-detected CPU specification.

System Memory

Displays the auto-detected system memory.

2.4 Advanced menu

The **Advanced** menu items allow you to change the settings for the CPU and other system devices.



Take caution when changing the settings of the Advanced menu items. Incorrect field values can cause the system to malfunction.

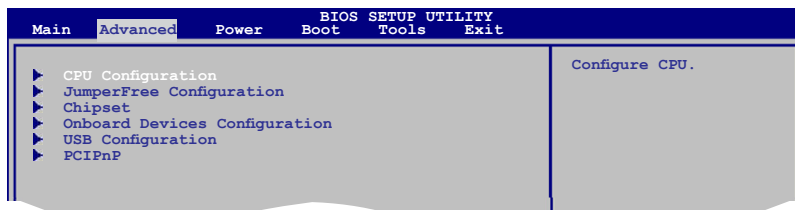

2.4.1 CPU Configuration

The items in this menu show the CPU-related information that the BIOS automatically detects.

Max CPUID Value Limit [Disabled]

Allows you to determine whether to limit CPUID maximum value. Set this item to [Disabled] for Windows XP operating system; set this item to [Enabled] for legacy operating system such as Windows NT4.0. Configuration options: [Disabled] [Enabled]

CPU TM function [Enabled]

Enables or disables Intel® CPU Thermal Monitor (TM) function, a CPU overheating protection function. When enabled, the CPU core frequency and voltage are reduced when the CPU overheats. Configuration options: [Disabled] [Enabled]

Execute-Disable Bit Capability [Enabled]

Allows you to enable or disable the No-Execution Page Protection Technology. Setting this item to [Disabled] forces the XD feature flag to always return to zero (0). Configuration options: [Disabled] [Enabled]

Hyper Threading Technology [Enabled]

Allows you to enable or disable the Intel® Hyper Threading technology. Configuration options: [Disabled] [Enabled]

2.4.2 JumperFree Configuration

The items in this menu allows you to adjust the system frequency/voltage.

System Clock Mode [Auto]

Allows you to select the system clock mode. Configuration options: [Auto] [Linked] [Unlinked] [Profiled]

iGPU OverClock Mode [Auto]

Allows selection of GPU overclocking options to achieve desired GPU frequency. Configuration options: [Auto] [Manual]



The following two items appear only when you set the **iGPU OverClock Mode** item to **[Manual]**.

iGPU OverClock [450]

Allows you to enter an integer value from 450MHz to 999MHz to overclock for GPU. Configuration options: [Min.=450] [Max.=999]

Shader OverClock [1200]

Allows you to enter an integer value from 1200MHz to 2000MHz to overclock for shader. Configuration options: [Min.=1200] [Max.=2000]

DRAM Over Voltage [Auto]

Manually set memory voltage or set to Auto for safe mode. Configuration options: [Auto] [1.92V] [2.00V]

Chipset Voltage [Auto]

Sets the chipset voltage. Configuration options: [Auto] [1.0V] [1.05V]

CPU Vcore Over Voltage Control [Auto]

Sets the CPU Vcore over voltage. Configuration options: [Auto] [+100mV]

Memory Timings [Auto]

Sets the memory timings. Configuration options: [Auto] [Manual]



The following items appear only when you set the **Memory Timings** item to **[Manual]**.

tCL (CAS Latency) [Auto]

Configuration options: [Auto] [5] [6] [7]

tRCD [Auto]

Configuration options: [Auto] [1] [2] [3] [4] [5] [6] [7]

tRP [Auto]

Configuration options: [Auto] [1] [2] [3] [4] [5] [6] [7]

tRAS [Auto]

Configuration options: [Auto] [1] [2] [3] [4] [5] [6] [7] [8]

Command Per Clock (CMD) [Auto]

Configuration options: [Auto] [1T] [2T]

tRRD [Auto]

Configuration options: [Auto] [1] [2] [3] [4] [5] [6] [7] [8]

tRC [Auto]

Configuration options: [Auto] [1] [2] [3] [4] [5] [6] [7] [8]

tWR [Auto]

Configuration options: [Auto] [2] [3] [4] [5] [6]

tWTR [Auto]

Configuration options: [Auto] [1] [2] [3] [4] [5] [6] [7] [8]

Burst Length [Auto]

Configuration options: [Auto] [4]

2.4.3 Chipset

The **Chipset** menu allows you to change the advanced chipset settings. Select an item then press **<Enter>** to display the sub-menu.

ION Configuration

Primary Graphics Adapter [Internal VGA First]

Allows you to set the primary graphics adapter. Configuration options: [PCI VGA Card First] [Internal VGA First]

iGPU Frame Buffer Detect [Auto]

Allows you to disable the iGPU frame buffer detect or set it to Auto for safe mode. Configuration options: [Auto] [Disabled]

iGPU Frame Buffer Size [Auto]

This item becomes user-configurable only when you set the iGPU Frame Buffer Detect item to [Disabled]. Allows you to select the iGPU frame buffer size. Configuration options: [32MB] [64MB] [128MB] [256MB] [512MB] [Disabled]

2.4.4 Onboard Devices Configuration

AZALIA AUDIO [Auto]

Allows you to set the Azalia audio.
Configuration options: [Auto] [Disabled]

Front Panel Select [HD Audio]

Allows you to select the front panel type. If High Definition Audio Front Panel used, please set HD Audio mode. Configuration options: [AC97] [HD Audio]

Onboard Gigabit LAN [Enabled]

Allows you to enable or disable the onboard LAN controller.
Configuration options: [Enabled] [Disabled]

LAN Option ROM [Disabled]

Allows you to enable or disable the boot ROM in the onboard LAN controller. This item appears only when the Onboard LAN item is set to Enabled. Configuration options: [Disabled] [Enabled]

Onboard Bluetooth [Enabled]

Allows you to enable or disable the onboard Bluetooth controller.
Configuration options: [Enabled] [Disabled]

2.4.5 USB Configuration

The items in this menu allows you to change the USB-related features. Select an item then press **<Enter>** to display the configuration options.



The Module Version and USB Devices Enabled items show the auto-detected values. If no USB device is detected, the item shows **None**.

USB Functions [Enabled]

Allows you to disable or enable the USB functions.
Configuration options: [Disabled] [Enabled]

USB 2.0 Controller [Enabled]

Allows you to enable or disable USB 2.0 controller.
Configuration options: [Enabled] [Disabled]

Legacy USB Support [Auto]

Allows you to enable or disable support for Legacy USB storage devices, including USB flash drives and USB hard drives. Setting to **[Auto]** allows the system to detect the presence of USB devices at startup. If detected, the USB controller legacy mode is enabled. If no USB device is detected, the legacy USB support is disabled.
Configuration options: [Disabled] [Enabled] [Auto]

USB 2.0 Controller Mode [HiSpeed]

Allows you to configure the USB 2.0 controller in HiSpeed (480Mbps) or Full Speed (12Mbps). Configuration options: [FullSpeed] [HiSpeed]



The following items may only appear when a USB storage device is plugged.

USB Mass Storage Device Configuration

USB Mass Storage Reset Delay [20 Sec]

Allows you to set the maximum time that the BIOS waits for the USB storage device to initialize. Configuration options: [10 Sec] [20 Sec] [30 Sec] [40 Sec]

Emulation Type [Auto]

Allows you to select the emulation type. Configuration options: [Auto] [Floppy] [Forced FDD] [Hard Disk] [CDROM]

2.4.6 PCI PnP

The PCI PnP menu items allow you to change the advanced settings for PCI/PnP devices. The menu includes setting IRQ and DMA channel resources for either PCI/PnP or legacy ISA devices, and setting the memory size block for legacy ISA devices.



Take caution when changing the settings of the PCI PnP menu items. Incorrect field values can cause the system to malfunction.

Plug and Play O/S [No]

When set to [No], BIOS configures all the devices in the system. When set to [Yes] and if you install a Plug and Play operating system, the operating system configures the Plug and Play devices not required for boot. Configuration options: [No] [Yes]

2.5 Power menu

The Power menu items allow you to change the settings for the Advanced Power Management (APM). Select an item then press **<Enter>** to display the configuration options.

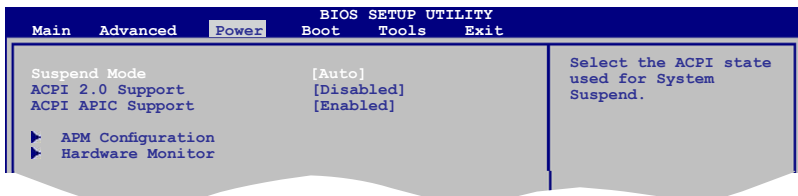

2.5.1 Suspend Mode [Auto]

Allows you to select the Advanced Configuration and Power Interface (ACPI) state to be used for system suspend. Configuration options: [S1 (POS) Only] [S3 Only] [Auto]

[S1(POS) Only] - Enables the system to enter the ACPI S1 (Power on Suspend) sleep state. In S1 sleep state, the system appears suspended and stays in a low power mode. The system can be resumed at any time.

[S3 Only] - Enables the system to enter the ACPI S3 (Suspend to RAM) sleep state (default). In S3 sleep state, the system appears to be off and consumes less power than in the S1 state. When signaled by a wake-up device or event, the system resumes to its working state exactly where it was left off.

[Auto] - Detected by OS.

2.5.2 ACPI 2.0 Support [Disabled]

Allows you to add more tables for Advanced Configuration and Power Interface (ACPI) 2.0 specifications. Configuration options: [Disabled] [Enabled]

2.5.3 ACPI APIC Support [Enabled]

Allows you to enable or disable the Advanced Configuration and Power Interface (ACPI) support in the Application-Specific Integrated Circuit (ASIC). When set to Enabled, the ACPI APIC table pointer is included in the RSDT pointer list. Configuration options: [Disabled] [Enabled]

2.5.4 APM Configuration

Restore on AC Power Loss [Power Off]

When set to **[Power Off]**, the system goes into off state after an AC power loss. When set to **[Power On]**, the system goes on after an AC power loss. When set to **[Last State]**, the system goes into either off or on state, whatever the system state was before the AC power loss. Configuration options: [Power Off] [Power On] [Last State]

Power On By PCI(E) Device [Disabled]

Allows you to enable or disable PME to generate a wake event. This feature requires an ATX power supply that provides at least 1A on the +5VSB lead. Configuration options: [Disabled] [Enabled]

Power On By PS/2 [Disabled]

When set to [Enabled], this parameter allows you to use the PS/2 keyboard/mouse to turn on the system. This feature requires an ATX power supply that provides at least 1A on the +5VSB lead. Configuration options: [Disabled] [Enabled]

Power On By RTC Alarm [Disabled]

Allows you to enable or disable RTC to generate a wake event. When this item is set to Enabled, the items RTC Alarm Date, RTC Alarm Hour, RTC Alarm Minute, and RTC Alarm Second appear with set values. Configuration options: [Disabled] [Enabled]

2.5.5 Hardware Monitor

CPU Temperature [xxx°C/xxx°F] or [Ignored]

The onboard hardware monitor automatically detects and displays the CPU temperature. Select Ignored if you do not wish to display the detected temperatures.

CPU/Chassis/Power Fan Speed [xxxxRPM] or [Ignored]

The onboard hardware monitor automatically detects and displays the CPU/chassis/power fan speeds in rotations per minute (RPM). If the fan is not connected to the motherboard, the field shows **N/A**. Select Ignored if you do not wish to display the detected speed.

VCORE Voltage, 3.3V Voltage, 5V Voltage, 12V Voltage [xxxV] or [Ignored]

The onboard hardware monitor automatically detects the voltage output through the onboard voltage regulators.

2.6 Boot menu

The **Boot** menu items allow you to change the system boot options. Select an item then press **<Enter>** to display the sub-menu.

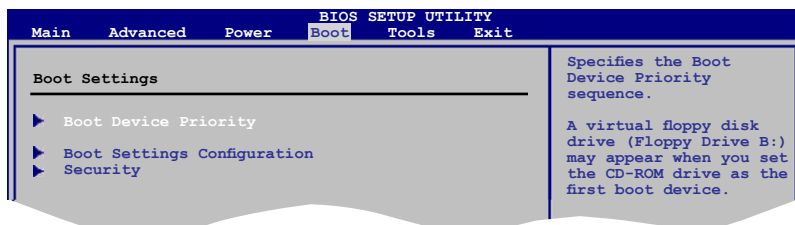

2.6.1 Boot Device Priority

1st ~ xxth Boot Device

These items specify the boot device priority sequence from the available devices. The number of device items that appears on the screen depends on the number of devices installed in the system. Configuration options: [Removable Dev.] [Hard Drive] [ATAPI CD-ROM] [Disabled]



- To select the boot device during system startup, press **<F8>** when ASUS Logo appears.
- To access Windows® OS in Safe Mode, do any of the following:
 - Press **<F5>** when ASUS Logo appears.
 - Press **<F8>** after POST.

2.6.2 Boot Settings Configuration

Quick Boot [Enabled]

Enabling this item allows the BIOS to skip some power on self tests (POST) while booting to decrease the time needed to boot the system. When set to **[Disabled]**, BIOS performs all the POST items. Configuration options: [Disabled] [Enabled]

Full Screen Logo [Enabled]

This allows you to enable or disable the full screen logo display feature. Configuration options: [Disabled] [Enabled]



Set this item to **[Enabled]** to use the ASUS MyLogo2™ feature.

AddOn ROM Display Mode [Force BIOS]

Sets the display mode for option ROM. Configuration options: [Force BIOS] [Keep Current]

Bootup Num-Lock [On]

Allows you to select the power-on state for the NumLock. Configuration options: [Off] [On]

Wait For 'F1' If Error [Enabled]

When set to **Enabled**, the system waits for the F1 key to be pressed when error occurs.
Configuration options: [Disabled] [Enabled]

Hit 'DEL' Message Display [Enabled]

When set to **[Enabled]**, the system displays the message **Press DEL to run Setup** during POST. Configuration options: [Disabled] [Enabled]

2.6.3 Security

The **Security** menu items allow you to change the system security settings. Select an item then press **<Enter>** to display the configuration options.

Change Supervisor Password

Select this item to set or change the supervisor password. The **Supervisor Password** item on top of the screen shows the default **Not Installed**. After you set a password, this item shows **Installed**.

To set a Supervisor Password:

1. Select the **Change Supervisor Password** item and press **<Enter>**.
2. In the password box, key in a password containing up to six letters or numbers, or both, then press **<Enter>**.
3. Confirm the password when prompted.

The message **Password Installed** appears after you successfully set your password.

To change the supervisor password, follow the same steps in setting a supervisor password.

To clear the supervisor password, select the **Change Supervisor Password** then press **<Enter>** twice. The message **Password uninstalled** appears.



If you forget your BIOS password, you can clear it by erasing the CMOS Real Time Clock (RTC) RAM. See section **1.6 Jumpers** for information on how to erase the RTC RAM.

After you have set a supervisor password, the other items appear to allow you to change other security settings.

User Access Level [Full Access]

This item allows you to select the access restriction to the Setup items.

Configuration options: [No Access] [View Only] [Limited] [Full Access]

[No Access] - prevents user access to the Setup utility.

[View Only] - allows access but does not allow change to any field.

[Limited] - allows changes only to selected fields, such as Date and Time.

[Full Access] - allows viewing and changing all the fields in the Setup utility.

Change User Password

Select this item to set or change the user password. The **User Password** item on top of the screen shows the default **Not Installed**. After you set a password, this item shows **Installed**.

To set a User Password:

1. Select the **Change User Password** item and press **<Enter>**.
2. In the password box, key in a password containing up to six letters or numbers, or both, then press **<Enter>**.
3. Confirm the password when prompted.

The message **Password Installed** appears after you set your password successfully.

To change the user password, follow the same steps in setting a user password.

Clear User Password

Select this item to clear the user password.

Password Check [Setup]

When set to **[Setup]**, BIOS checks for user password when accessing the Setup utility. When set to **[Always]**, BIOS checks for user password both when accessing Setup and booting the system. Configuration options: [Setup] [Always]

2.7 Tools menu

The Tools menu items allow you to configure options for special functions. Select an item then press **<Enter>** to display the sub-menu.

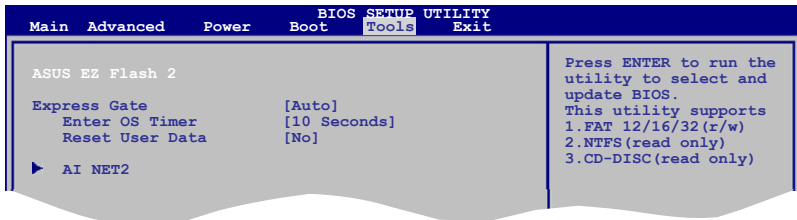

2.7.1 ASUS EZ Flash 2

Allows you to run ASUS EZ Flash 2. When you press **<Enter>**, a confirmation message appears. Use the left/right arrow key to select between **[Yes]** or **[No]**, then press **<Enter>** to confirm your choice. See section 2.1.2 **ASUS EZ Flash 2** for details.

2.7.2 Express Gate [Auto]

Allows you to enable or disable the ASUS Express Gate feature. ASUS Express Gate is a unique instant-on environment that provides quick access to the Internet and Skype. Configuration options: [Enabled] [Disabled] [Auto]

Enter OS Timer [10 Seconds]

Sets countdown duration that the system waits at the Express Gate's first screen before starting Windows or other installed OS. Choose **[Prompt User]** to stay at the first screen of Express Gate for user action. Configuration options: [Prompt User] [1 second] [3 seconds] [5 seconds] [10 seconds] [15 seconds] [20 seconds] [30 seconds]

Reset User Data [No]

Allows you to clear Express Gate's user data. Configuration options: [No] [Reset] When setting this item to **[Reset]**, ensure to save the setting to the BIOS so that the user data will be cleared the next time you enter the Express Gate. User data includes the Express Gate's settings as well as any personal information stored by the web browser (bookmarks, cookies, browsing history, etc.). This is useful in the rare case where corrupt settings prevent the Express Gate environment from launching properly.



The first time wizard will run again when you enter the Express Gate environment after clearing its settings.

2.7.3 AI NET 2

Check Realtek LAN cable [Disabled]

Enables or disables checking of the Realtek LAN cable during the Power-On Self-Test (POST). Configuration options: [Disabled] [Enabled]

2.8 Exit menu

The Exit menu items allow you to load the optimal or failsafe default values for the BIOS items, and save or discard your changes to the BIOS items.

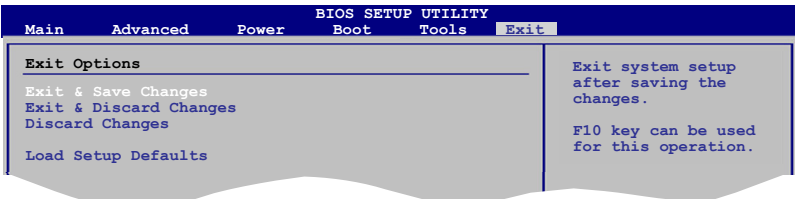

Pressing **<Esc>** does not immediately exit this menu. Select one of the options from this menu or **<F10>** from the legend bar to exit.

Free Manuals Download Website

<http://myh66.com>

<http://usermanuals.us>

<http://www.somanuals.com>

<http://www.4manuals.cc>

<http://www.manual-lib.com>

<http://www.404manual.com>

<http://www.luxmanual.com>

<http://aubethermostatmanual.com>

Golf course search by state

<http://golfingnear.com>

Email search by domain

<http://emailbydomain.com>

Auto manuals search

<http://auto.somanuals.com>

TV manuals search

<http://tv.somanuals.com>