

A8S-X SE



Motherboard

E2387

**First Edition
January 2006**

Copyright © 2006 ASUSTeK COMPUTER INC. All Rights Reserved.

No part of this manual, including the products and software described in it, may be reproduced, transmitted, transcribed, stored in a retrieval system, or translated into any language in any form or by any means, except documentation kept by the purchaser for backup purposes, without the express written permission of ASUSTeK COMPUTER INC. ("ASUS").

Product warranty or service will not be extended if: (1) the product is repaired, modified or altered, unless such repair, modification or alteration is authorized in writing by ASUS; or (2) the serial number of the product is defaced or missing.

ASUS PROVIDES THIS MANUAL "AS IS" WITHOUT WARRANTY OF ANY KIND, EITHER EXPRESS OR IMPLIED, INCLUDING BUT NOT LIMITED TO THE IMPLIED WARRANTIES OR CONDITIONS OF MERCHANTABILITY OR FITNESS FOR A PARTICULAR PURPOSE. IN NO EVENT SHALL ASUS, ITS DIRECTORS, OFFICERS, EMPLOYEES OR AGENTS BE LIABLE FOR ANY INDIRECT, SPECIAL, INCIDENTAL, OR CONSEQUENTIAL DAMAGES (INCLUDING DAMAGES FOR LOSS OF PROFITS, LOSS OF BUSINESS, LOSS OF USE OR DATA, INTERRUPTION OF BUSINESS AND THE LIKE), EVEN IF ASUS HAS BEEN ADVISED OF THE POSSIBILITY OF SUCH DAMAGES ARISING FROM ANY DEFECT OR ERROR IN THIS MANUAL OR PRODUCT.

SPECIFICATIONS AND INFORMATION CONTAINED IN THIS MANUAL ARE FURNISHED FOR INFORMATIONAL USE ONLY, AND ARE SUBJECT TO CHANGE AT ANY TIME WITHOUT NOTICE, AND SHOULD NOT BE CONSTRUED AS A COMMITMENT BY ASUS. ASUS ASSUMES NO RESPONSIBILITY OR LIABILITY FOR ANY ERRORS OR INACCURACIES THAT MAY APPEAR IN THIS MANUAL, INCLUDING THE PRODUCTS AND SOFTWARE DESCRIBED IN IT.

Products and corporate names appearing in this manual may or may not be registered trademarks or copyrights of their respective companies, and are used only for identification or explanation and to the owners' benefit, without intent to infringe.

Contents

Notices	vi
Safety information	vii
About this guide.....	viii
Typography	ix
A8S-X SE specifications summary	x

Chapter 1: Product introduction

1.1	Welcome!	1-2
1.2	Package contents	1-2
1.3	Special features	1-3
1.3.1	Product highlights	1-3
1.3.2	Unique ASUS features.....	1-5
1.4	Before you proceed	1-6
1.5	Motherboard overview	1-7
1.5.1	Motherboard layout	1-7
1.5.2	Placement direction	1-8
1.5.3	Screw holes.....	1-8
1.6	Central Processing Unit (CPU)	1-9
1.6.1	Overview	1-9
1.6.2	Installing the CPU	1-9
1.6.3	Installing the heatsink and fan	1-11
1.7	System memory.....	1-13
1.7.1	DIMM sockets location	1-13
1.7.2	Memory configurations	1-13
1.7.3	Installing a DIMM	1-16
1.8	Expansion slots	1-16
1.8.1	Standard interrupt assignments	1-17
1.8.2	IRQ assignments for this motherboard	1-17
1.8.3	PCI slots	1-18
1.8.4	PCI Express x1 slot	1-18
1.8.5	PCI Express x16 slot	1-18
1.9	Jumpers	1-19
1.10	Connectors	1-21
1.10.1	Rear panel connectors	1-21
1.10.2	Internal connectors.....	1-22

Contents

Chapter 2: BIOS setup

2.1	Managing and updating your BIOS	2-2
2.1.1	Creating a bootable floppy disk	2-2
2.1.2	Using AFUDOS to update the BIOS	2-3
2.1.3	Using AFUDOS to copy BIOS from PC	2-4
2.1.4	Using ASUS EZ Flash to update the BIOS.....	2-5
2.1.5	Recovering the BIOS with CrashFree BIOS 2	2-6
2.2	BIOS Setup program	2-8
2.2.1	BIOS menu screen	2-9
2.2.2	Menu bar	2-9
2.2.3	Navigation keys.....	2-9
2.2.4	Menu items	2-10
2.2.5	Sub-menu items.....	2-10
2.2.6	Configuration fields	2-10
2.2.7	Pop-up window.....	2-10
2.2.8	Scroll bar	2-10
2.3	Main menu.....	2-11
2.3.1	System Time	2-11
2.3.2	System Date	2-11
2.3.3	Legacy Diskette A	2-11
2.3.4	Language	2-11
2.3.5	Primary, Secondary, Third and Fourth IDE Master/Slave	2-12
2.3.6	Onboard PCI S-ATA Controller	2-13
2.3.7	System Information	2-13
2.4	Advanced menu	2-14
2.4.1	JumperFree Configuration.....	2-14
2.4.2	USB Configuration	2-15
2.4.3	CPU Configuration	2-16
2.4.4	Chipset.....	2-17
2.4.5	Onboard Devices Configuration.....	2-20
2.4.6	PCI PnP.....	2-21
2.4.7	AMD Cool 'N Quiet Configuration	2-22

Contents

2.5	Power menu	2-23
2.5.1	Suspend Mode.....	2-23
2.5.2	Repost Video on S3 Resume.....	2-23
2.5.3	ACPI 2.0 Support	2-23
2.5.4	ACPI APIC Support	2-23
2.5.5	APM Configuration	2-24
2.5.6	Hardware Monitor	2-25
2.6	Boot menu	2-26
2.6.1	Boot Device Priority	2-26
2.6.2	Boot Settings Configuration	2-27
2.6.3	Security.....	2-28
2.7	Exit menu.....	2-30

Chapter 3: Software support

3.1	Installing an operating system.....	3-2
3.2	Support CD information.....	3-2
3.2.1	Running the support CD.....	3-2
3.2.2	Drivers menu.....	3-3
3.2.3	Utilities menu	3-3
3.2.4	Make Disk.....	3-5
3.2.5	Manual	3-5
3.2.6	ASUS Contact information	3-6

Notices

Federal Communications Commission Statement

This device complies with Part 15 of the FCC Rules. Operation is subject to the following two conditions:

- This device may not cause harmful interference, and
- This device must accept any interference received including interference that may cause undesired operation.

This equipment has been tested and found to comply with the limits for a Class B digital device, pursuant to Part 15 of the FCC Rules. These limits are designed to provide reasonable protection against harmful interference in a residential installation. This equipment generates, uses and can radiate radio frequency energy and, if not installed and used in accordance with manufacturer's instructions, may cause harmful interference to radio communications. However, there is no guarantee that interference will not occur in a particular installation. If this equipment does cause harmful interference to radio or television reception, which can be determined by turning the equipment off and on, the user is encouraged to try to correct the interference by one or more of the following measures:

- Reorient or relocate the receiving antenna.
- Increase the separation between the equipment and receiver.
- Connect the equipment to an outlet on a circuit different from that to which the receiver is connected.
- Consult the dealer or an experienced radio/TV technician for help.



The use of shielded cables for connection of the monitor to the graphics card is required to assure compliance with FCC regulations. Changes or modifications to this unit not expressly approved by the party responsible for compliance could void the user's authority to operate this equipment.

Canadian Department of Communications Statement

This digital apparatus does not exceed the Class B limits for radio noise emissions from digital apparatus set out in the Radio Interference Regulations of the Canadian Department of Communications.

This class B digital apparatus complies with Canadian ICES-003.

Safety information

Electrical safety

- To prevent electrical shock hazard, disconnect the power cable from the electrical outlet before relocating the system.
- When adding or removing devices to or from the system, ensure that the power cables for the devices are unplugged before the signal cables are connected. If possible, disconnect all power cables from the existing system before you add a device.
- Before connecting or removing signal cables from the motherboard, ensure that all power cables are unplugged.
- Seek professional assistance before using an adapter or extension cord. These devices could interrupt the grounding circuit.
- Make sure that your power supply is set to the correct voltage in your area. If you are not sure about the voltage of the electrical outlet you are using, contact your local power company.
- If the power supply is broken, do not try to fix it by yourself. Contact a qualified service technician or your retailer.

Operation safety

- Before installing the motherboard and adding devices on it, carefully read all the manuals that came with the package.
- Before using the product, make sure all cables are correctly connected and the power cables are not damaged. If you detect any damage, contact your dealer immediately.
- To avoid short circuits, keep paper clips, screws, and staples away from connectors, slots, sockets and circuitry.
- Avoid dust, humidity, and temperature extremes. Do not place the product in any area where it may become wet.
- Place the product on a stable surface.
- If you encounter technical problems with the product, contact a qualified service technician or your retailer.



The symbol of the crossed out wheeled bin indicates that the product (electrical and electronic equipment) should not be placed in municipal waste. Check local regulations for disposal of electronic products.

About this guide

This user guide contains the information you need when installing and configuring the motherboard.

How this guide is organized

This manual contains the following parts:

- **Chapter 1: Product introduction**
This chapter describes the features of the motherboard and the new technology it supports. This chapter also lists the hardware setup procedures that you have to perform when installing system components. It includes description of the jumpers and connectors on the motherboard.
- **Chapter 2: BIOS setup**
This chapter tells how to change system settings through the BIOS Setup menus. Detailed descriptions of the BIOS parameters are also provided.
- **Chapter 3: Software support**
This chapter describes the contents of the support CD that comes with the motherboard package.

Where to find more information

Refer to the following sources for additional information and for product and software updates.

1. ASUS websites

The ASUS website provides updated information on ASUS hardware and software products. Refer to the ASUS contact information.

2. Optional documentation

Your product package may include optional documentation, such as warranty flyers, that may have been added by your dealer. These documents are not part of the standard package.

Conventions used in this guide

To make sure that you perform certain tasks properly, take note of the following symbols used throughout this manual.



DANGER/WARNING: Information to prevent injury to yourself when trying to complete a task.



CAUTION: Information to prevent damage to the components when trying to complete a task.



IMPORTANT: Instructions that you **MUST** follow to complete a task.



NOTE: Tips and additional information to help you complete a task.

Typography

Bold text

Italics

<Key>

Indicates a menu or an item to select

Used to emphasize a word or a phrase

Keys enclosed in the less-than and greater-than sign means that you must press the enclosed key

Example: <Enter> means that you must press the Enter or Return key

<Key1>+<Key2>+<Key3>

If you must press two or more keys simultaneously, the key names are linked with a plus sign (+)

Example: <Ctrl>+<Alt>+<D>

Command

Means that you must type the command exactly as shown, then supply the required item or value enclosed in brackets

Example: At the DOS prompt, type the command line:

```
afudos /i [filename]  
afudos /iA8S-XSE.ROM
```

A8S-X SE specifications summary

CPU	Socket 939 for AMD Athlon™ 64 x2, AMD® Athlon™ 64 FX, Athlon™ 64 and AMD® Sempron processors Support AMD 64 architecture that enables simultaneous 32-bit and 64-bit architecture Supports AMD Cool 'n' Quiet!™ Technology
Chipset	Northbridge: SIS 756 Southbridge: SIS 965L
System Bus	2000/1600 MT/s
Memory	Dual-channel memory architecture 4 x 184-pin DIMM sockets support ECC/non-ECC un-buffered 400/333/266 MHz DDR memory modules Supports up to 4 GB system memory
Expansion slots	1 x PCI Express x16 slot for discrete graphics card 2 x PCI Express x1 slots 3 x PCI slots
Storage	South Bridge supports: - 2 x Ultra DMA 133/100/66/33 - 2 x Serial ATA with RAID0, RAID1, and JBOD
Audio	ADI AD1986A SoundMax 6-channel Audio CODEC Supports S/PDIF out interface
USB 2.0	Supports up to 8 USB 2.0 ports
LAN	Realtek RLC8201 CL 10/100 Mbps LAN PHY
ASUS special features	ASUS AL Overclocking ASUS My logo ASUS EZ Flash ASUS Q-Fan ASUS CrashFree BIOS 2 ASUS C.P.R. SFS from 200MHz up to 300 MHz at 1MHz increment
BIOS features	4 Mb Flash ROM, AMI BIOS, PnP, DMI, WfM2.0, SM BIOS 2.3
Back Panel I/O Ports	1 x Parallel port 1 x Serial port 1 x PS/2 keyboard port 1 x PS/2 mouse port 1 x 5.1-Channel Audio I/O port 1 x RJ45 port 1 x S/PDIF Out (Coaxial) 4 x USB 2.0 ports

(continued on the next page)

A8S-X SE specifications summary

Internal I/O connectors	2 x USB connector supports additional 4 USB ports CPU/Chassis/Power FAN connectors Chassis Intrusion 24-pin ATX Power connector 4-pin ATX 12V Power connector CD/ AUX audio in GAME connector Front panel audio connector
Manageability	Wfm2.0, DMI, WOL by PME, WOR by PME, SM Bus, Chassis Intrusion
Support CD contents	Drivers ASUS PC Probe II ASUS LiveUpdate Utility Anti-Virus software
Form Factor	ATX Form Factor: 12 in x 8.6 in (30.5cm x 21.8cm)

**Specifications are subject to change without notice.*

This chapter describes the motherboard features and the new technologies it supports.

1 Product introduction

1.1 Welcome!

Thank you for buying an ASUS® A8S-X SE motherboard!

The motherboard delivers a host of new features and latest technologies, making it another standout in the long line of ASUS quality motherboards!

Before you start installing the motherboard, and hardware devices on it, check the items in your package with the list below.

1.2 Package contents

Check your motherboard package for the following items.

Motherboard	ASUS A8S-X SE motherboard
Cables	1 x Ultra DMA cable 1 x SATA power cable 1 x SATA signal cable 1 x Floppy disk cable
Accessories	I/O shield
Application CDs	ASUS motherboard support CD
Documentation	User guide



If any of the above items is damaged or missing, contact your retailer.

1.3 Special features

1.3.1 Product Highlights



AMD Dual-Core Architecture

The motherboard supports AMD dual-core processors containing two physical CPU cores with discrete L2 cache structure for each core to meet demands for more powerful computing.



Latest processor technology

The AMD Athlon™ 64FX and Athlon™ 64 desktop processors are based on AMD's 64-bit and 32-bit architecture, which represents the landmark introduction of the industry's first x86-64 technology. These processors provide a dramatic leap forward in compatibility, performance, investment protection, and reduced total cost of ownership and development.

HyperTransport™ Technology



HyperTransport™ Technology is a high-speed, low latency, point-to-point link designed to increase the communication speed between integrated circuits in computers, networking and telecommunications equipment up to 48 times faster than other existing technologies.

Cool 'n' Quiet!™ Technology



The motherboard supports the AMD® Cool 'n' Quiet!™ Technology that dynamically and automatically changes the CPU speed, voltage and amount of power depending on the task the CPU performs.

Serial ATA solution



The motherboard supports two interfaces compliant to the Serial ATA (SATA) specification, an evolutionary replacement of the Parallel ATA storage interface. The Serial ATA specification allows for thinner, more flexible cables with lower pin count, reduced voltage requirement, up to 150 MB/s data transfer rate.

Serial ATA RAID solution



The motherboard provides a high-performance Serial ATA RAID controller that enhance hard disk performance and data backup protection without the cost of additional RAID cards. The onboard SIS 965L RAID controller provides two Serial ATA connectors for RAID 0, RAID 1 and JBOD functions.

S/PDIF out



The motherboard's S/PDIF out function turns your computer into a high-end entertainment system with digital connectivity to powerful speaker systems.

PCI Express™ interface



The motherboard fully supports PCI Express, the latest I/O interconnect technology that speeds up the PCI bus. PCI Express features point-to-point serial interconnections between devices and allows higher clockspeeds by carrying data in packets. This high speed interface is software compatible with existing PCI specifications.

USB 2.0 technology



The motherboard implements the Universal Serial Bus 2.0 (USB 2.0) specification, extending the connection speed from 12 Mbps on USB 1.1 to a fast 480Mbps on USB 2.0.

6-Channel Audio solution



The motherboard uses an onboard audio CODEC that lets you enjoy high-quality 6-channel audio without having to buy advanced sound cards.

1.3.2 Unique ASUS features

CrashFree BIOS 2

This feature allows you to restore the original BIOS data from the ASUS support CD in case when the BIOS codes and data are corrupted. This protection eliminates the need to buy a replacement ROM chip.

C.P.R. (CPU Parameter Recall)

The C.P.R. feature of the motherboard BIOS allows automatic re-setting to the BIOS default settings in case the system hangs due to overclocking. When the system hangs due to overclocking, C.P.R. eliminates the need to open the system chassis and clear the RTC data. Simply shut down and reboot the system, and BIOS automatically restores the CPU previous setting for each parameter.

ASUS MyLogo™

This new feature present in the motherboard allows you to personalize and add style to your system with customizable boot logos.

ASUS EZ Flash BIOS

With the ASUS EZ Flash, you can easily update the system BIOS even before loading the operating system. No need to use a DOS-based utility or boot from a floppy disk.

ASUS Multi-language BIOS

The multi-language BIOS allows you to select the language of your choice from the available options. The localized BIOS menus allow easier and faster configuration. The available languages include English, German, French, Japanese and Traditional Chinese.

1.4 Before you proceed

Take note of the following precautions before you install motherboard components or change any motherboard settings.



- Unplug the power cord from the wall socket before touching any component.
- Use a grounded wrist strap or touch a safely grounded object or to a metal object, such as the power supply case, before handling components to avoid damaging them due to static electricity
- Hold components by the edges to avoid touching the ICs on them.
- Whenever you uninstall any component, place it on a grounded antistatic pad or in the bag that came with the component.
- **Before you install or remove any component, ensure that the ATX power supply is switched off or the power cord is detached from the power supply.** Failure to do so may cause severe damage to the motherboard, peripherals, and/or components.

Onboard LED

The motherboard comes with a green standby power LED that lights up to indicate that the system is ON, in sleep mode, or in soft-off mode. This is a reminder that you should shut down the system and unplug the power cable before removing or plugging in any motherboard component.

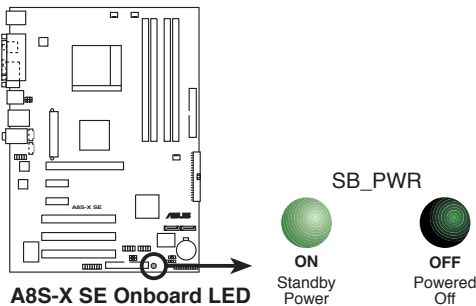

1.5 Motherboard overview

1.5.1 Motherboard layout

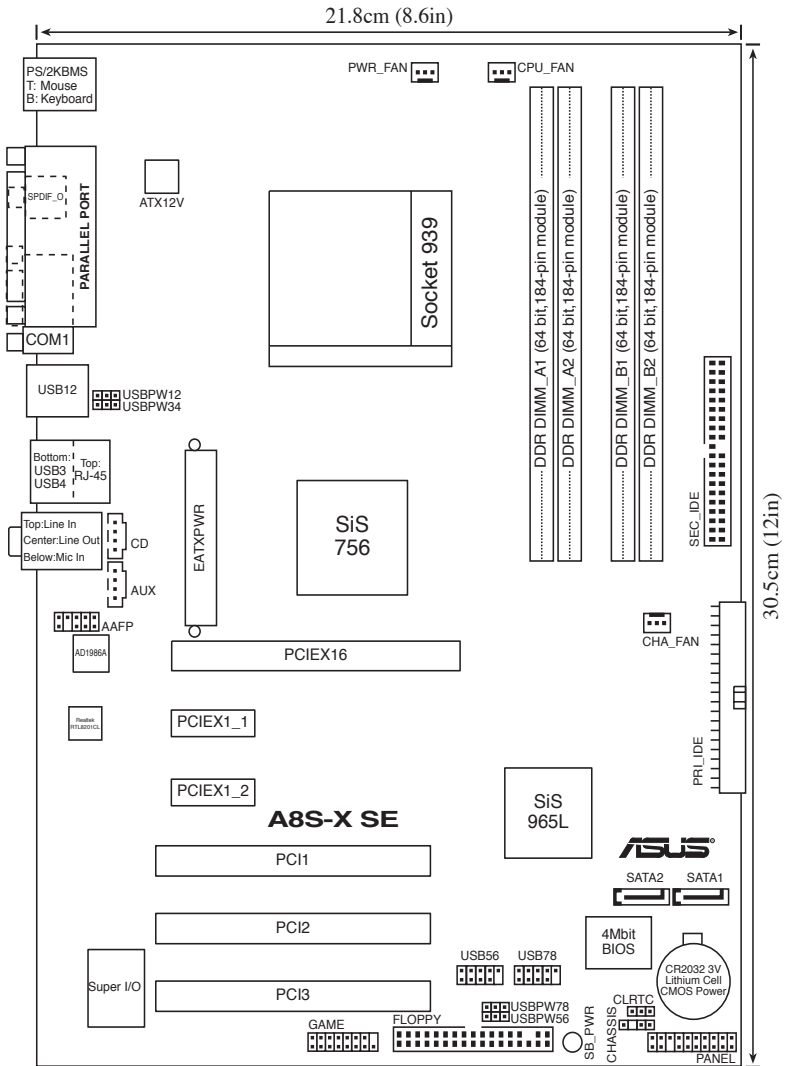

1.5.2 Placement direction

When installing the motherboard, make sure that you place it into the chassis in the correct orientation. The edge with external ports goes to the rear part of the chassis as indicated in the image below.

1.5.3 Screw holes

Place six (6) screws into the holes indicated by circles to secure the motherboard to the chassis.



Do not overtighten the screws! Doing so may damage the motherboard.

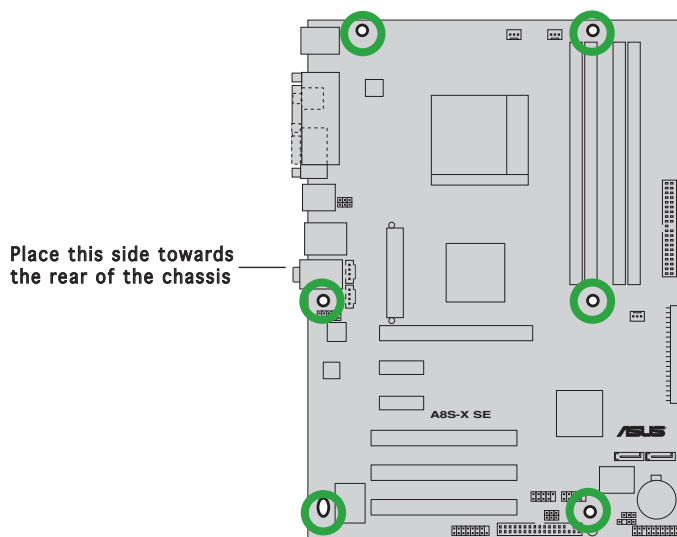

Before you install the motherboard, study the configuration of your chassis to ensure that the motherboard fits into it.



Make sure to unplug the power cord before installing or removing the motherboard. Failure to do so can cause you physical injury and damage motherboard components.

1.6 Central Processing Unit (CPU)

1.6.1 Overview

The motherboard comes with a surface mount 939-pin Zero Insertion Force (ZIF) socket designed for the AMD Athlon™ 64 X2, AMD Athlon™ 64 FX, and AMD Sempron™ Processors.

The 128-bit-wide data paths of these processors can run applications faster than processors with only 32-bit or 64-bit wide data paths.

Take note of the marked corner (with gold triangle) on the CPU. This mark should match a specific corner on the socket to ensure correct installation.

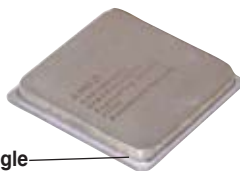

Gold triangle

1.6.2 Installing the CPU

To install a CPU:

1. Locate the CPU socket on the motherboard.

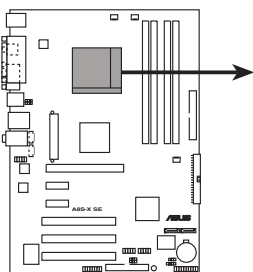

A8S-X SE CPU Socket 939

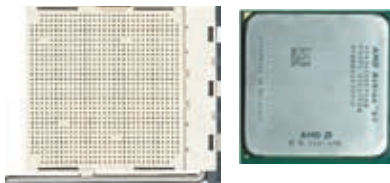

Before installing the CPU, make sure that the socket box is facing towards you and the load lever is on your left.



Incorrect installation of the CPU into the socket may bend the pins and severely damage the CPU!

2. Unlock the socket by pressing the lever sideways, then lift it up to a 90°-100° angle.

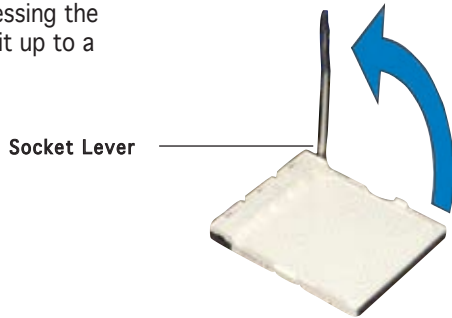

Make sure that the socket lever is lifted up to 90°-100° angle, otherwise the CPU does not fit in completely.

3. Position the CPU above the socket such that the CPU corner with the gold triangle matches the socket corner with a small triangle.
4. Carefully insert the CPU into the socket until it fits in place.

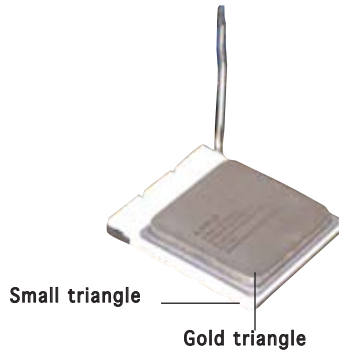

The CPU fits only in one correct orientation. DO NOT force the CPU into the socket to prevent bending the pins and damaging the CPU!

5. When the CPU is in place, push down the socket lever to secure the CPU. The lever clicks on the side tab to indicate that it is locked.
6. Install specifically designed heatsink and fan assembly.

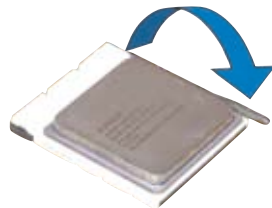

1.6.3 Installing the heatsink and fan

The AMD Athlon™ 64, AMD Athlon™ 64FX, AMD Athlon™ 64 X2, or AMD Sempron processors require a specially designed heatsink and fan assembly to ensure optimum thermal condition and performance.



Make sure that you use only qualified heatsink and fan assembly.

Follow these steps to install the CPU heatsink and fan.

1. Place the heatsink on top of the installed CPU, making sure that the heatsink fits properly on the retention module base.



- The retention module base is already installed on the motherboard upon purchase.
 - You do not have to remove the retention module base when installing the CPU or installing other motherboard components.
 - If you purchased a separate CPU heatsink and fan assembly, make sure that a Thermal Interface Material is properly applied to the CPU heatsink or CPU before you install the heatsink and fan assembly.
-

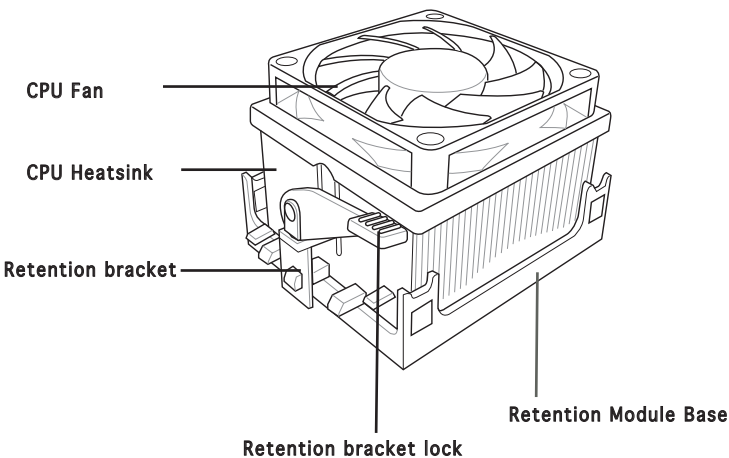

Your boxed CPU heatsink and fan assembly should come with installation instructions for the CPU, heatsink, and the retention mechanism. If the instructions in this section do not match the CPU documentation, follow the latter.

2. Attach one end of the retention bracket to the retention module base.

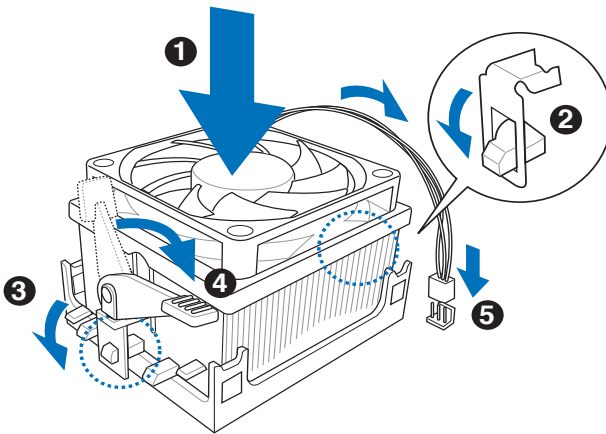

3. Align the other end of the retention bracket (near the retention bracket lock) to the retention module base. A clicking sound denotes that the retention bracket is in place.



Make sure that the fan and heatsink assembly perfectly fits the retention mechanism module base, otherwise you cannot snap the retention bracket in place.

4. Push down the retention bracket lock on the retention mechanism to secure the heatsink and fan to the module base.
5. When the fan and heatsink assembly is in place, connect the CPU fan cable to the connector on the motherboard labeled CPU_FAN.

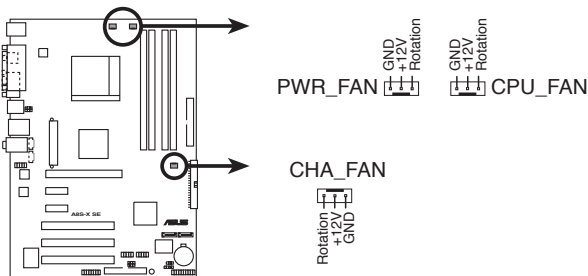

A8S-X SE Fan Connectors



Do not forget to connect the CPU fan connector! Hardware monitoring errors can occur if you fail to plug this connector.

1.7 System memory

1.7.1 DIMM sockets location

The following figure illustrates the location of the DDR DIMM sockets.

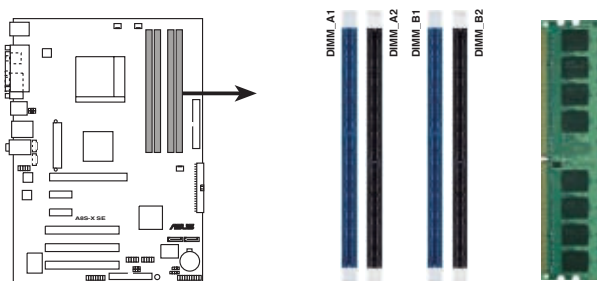

A8S-X SE 184-pin DDR DIMM Sockets



- Make sure to unplug the power supply before adding or removing DIMMs or other system components. Failure to do so may cause severe damage to both the motherboard and the components.
- We recommend to install the memory modules first before installing a PCI Express x16 card.

1.7.2 Memory configurations

You may install 128MB, 256MB, 512MB, and 1GB DDR DIMMs into the DIMM sockets using the memory configurations in this section.



- Always install DIMMs with the same CAS latency. For optimum compatibility, it is recommended that you obtain memory modules from the same vendor. Refer to the DDR400 Qualified Vendors List for details.
- Due to chipset resource allocation, the system may detect less than 4 GB of system memory when you installed four 1 GB DDR memory modules.
- Due to chipset limitation, DIMM modules with 128 Mb memory chips or double-sided x16 memory chips are not supported in this motherboard.
- Due to CPU limitation, install on Channel B slots for a single-channel memory configuration.
- Visit the ASUS website (www.asus.com) for the latest DDR 400 Qualified Vendor List for this motherboard.

DDR400 Qualified Vendors List

Size	Vendor	Model	CL	Brand	Side(s)	Component	DIMM support		
							A	B	C
256MB	KINGSTON	KVR400X72C3A/256	N/A	Mosel	SS	V58C2256804SAT5(ECC)	V	V	V
512MB	KINGSTON	KVR400X72C3A/512	N/A	Mosel	DS	V58C2256804SAT5(ECC)	V	V	V
512MB	KINGSTON	KHX3200A/512	N/A	N/A	DS	N/A	V	V	V
256MB	KINGSTON	KVR400X64C3A/256	N/A	N/A	SS	D3208DL3T-5A	V	V	V
256MB	KINGSTON	KVR400X64C3A/256	N/A	N/A	SS	A2556D30BTP511ALM09	V	V	V
512MB	KINGSTON	KVR400X64C3A/512	N/A	N/A	DS	V58C2256804SAT5	V	V	V
512MB	KINGSTON	KVR400X64C3A/512	N/A	N/A	SS	HY5DU12822BT-D43	V	V	V
256MB	SAMSUNG	M381L3223ETM-CCC	3	SAMSUNG	SS	K4H560838E-TCCC(ECC)	V	V	V
512MB	SAMSUNG	M381L6423ETM-CCC	N/A	SAMSUNG	DS	K4H560838E-TCCC(ECC)	V	V	V
512MB	SAMSUNG	M368L6423FTN-CCC	3	SAMSUNG	DS	K4H560838F-TCCC	V	V	V
256MB	MICRON	MT8VDDT3264AG-40BCB	N/A	MICRON	SS	MT46V32M8TG-5BC	V	V	V
512MB	MICRON	MT16VDDT6464AG-40BCB	N/A	MICRON	DS	MT46V32M8TG-5BC	V	V	V
256MB	Infineon	HYS64D32300HU-5-C	3	Infineon	SS	HYB25D256800CE-5C	V	V	V
512MB	Infineon	HYS64D64320HU-5-C	N/A	Infineon	DS	HYB25D256800CE-5C	V	V	V
256MB	Infineon	HYS64D32301HU-5-C	3	Infineon	SS	HYB25D512160CE-5C	V	V	V
1024MB	Infineon	HYS64D128320HU-5-C	3	Infineon	DS	HYB25D512800CE-5B	V	V	V
256MB	CORSAIR	CMX256A-3200C2PT	2	Winbond	SS	W942508BH-5	V	V	V
512MB	CORSAIR	CMXP512-3200XL	2	Winbond	DS	N/A	V	V	V
256MB	Hynix	HYMD232646D8J-D43	3	Hynix	SS	HY5DU56822DT-D43	V	V	V
512MB	Hynix	HYMD264646D8J-D43	3	Hynix	DS	HY5DU56822DT-D43	V	V	V
256MB	TwinMOS	M2G9108AIATT9F081AADT	2.5	TwinMOS	SS	TMD7608F8E50D	V	V	V
256MB	TwinMOS	M2G9108A8ATT9F081AADT	2.5	TwinMOS	SS	TMD7608F8E50D	V	V	V
512MB	TwinMOS	M2G91J6A8ATT9F081AADT	2.5	TwinMOS	DS	TMD7608F8E50D	V	V	V
256MB	Transcend	TS32MLD64V4F3	3	SAMSUNG	SS	K4H560838F-TCCC	V	V	V
512MB	Transcend	TS64MLD64V4F3	3	SAMSUNG	DS	K4H560838F-TCCC	V	V	V
1024MB	Transcend	TS128MLD64V4J	3	SAMSUNG	DS	K4H510838B-TCCC	V	V	V
256MB	A DATA	MDOSS6F3G31Y0K1EOZ	3	SAMSUNG	SS	K4H560838E-TCCC	V	V	V
512MB	A DATA	MDOSS6F3H41Y0N1EOZ	3	SAMSUNG	DS	K4H560838F-TCCC	V	V	V
256MB	A DATA	MDOHY6F3G31Y0N1EOZ	3	Hynix	SS	HY5DU56822CT-D43	V	V	V
512MB	A DATA	MDOHY6F3H41Y0N1EOZ	3	Hynix	DS	HY5DU56822CT-D43	V	V	V
256MB	A DATA	MDOAD5F3G31Y0D1EO2	2.5	N/A	SS	ADD8608A8A-5B	V	V	V
512MB	A DATA	MDOAD5F3H41Y0D1EO2	2.5	N/A	DS	ADD8608A8A-5B	V	V	V
512MB	Winbond	W9451GCDB-5	N/A	Winbond	DS	W942508CH-5	V	V	V
256MB	PSC	AL5D8B53T-5B1K	2.5	PSC	SS	A2556D30BTP	V	V	V
512MB	PSC	AL6D8B53T-5B1K	2.5	PSC	DS	A2556D30BTP	V	V	V
256MB	KINGMAX	MPXB62D-38KT3R	N/A	N/A	SS	KDL38BP4LA-50	V	V	V
256MB	NANYA	NT256D64S88COG-5T	3	N/A	SS	NT5DS32M8CT-5T	V	V	V
512MB	NANYA	NT512D64S88COG-5T	3	N/A	DS	NT5DS32M8CT-5T	V	V	V
256MB	NANYA	NT256D64SH4B0G-5T	3	N/A	SS	NT5DS32M16BT-5T	V	V	V
512MB	NANYA	NT512D64S88B0G-5T	3	N/A	DS	NT5DS64M8BT-5T	V	V	V
1024MB	NANYA	NT1G064S88B0G-5T	N/A	N/A	DS	NT5DS64M8BT-5T	V	V	V
512MB	CENTURY	DXV258S5CCE3K27E	N/A	SAMSUNG	DS	K4H560838E-TCCC	V	V	V
256MB	CENTURY	DXV658EL5BM3T27C	N/A	N/A	SS	DD2508AMTA	V	V	V
512MB	CENTURY	DXV258EL5BM3T27C	N/A	N/A	DS	DD2508AMTA	V	V	V
256MB	CENTURY	DXV658EL5B	N/A	N/A	SS	DD2508AMTA	V	V	V
256MB	CENTURY	DXV658HXD43B	N/A	N/A	SS	HY5DU56822BT-D43	V	V	V
256MB	CENTURY	DXV658HXD43D	N/A	N/A	SS	HY5DU56822DT-D43	V	V	V
512MB	CENTURY	DXV258EL5B	N/A	N/A	DS	DD2508AMTA	V	V	V
512MB	CENTURY	DXV258HXD43B	N/A	N/A	DS	HY5DU56822BT-D43	V	V	V
512MB	CENTURY	DXV258HXD43D	N/A	N/A	DS	HY5DU56822DT-D43	V	V	V

(continued on the next page)

DDR400 Qualified Vendors List

Size	Vendor	Model	CL	Brand	Side(s)	Component	DIMM support		
							A	B	C
512MB	CENTURY	DXV2S8HXD43D	N/A	N/A	DS	HY5DU568222D-D43	V	V	V
256MB	CENTURY	DXV6S8EL5B/HP	N/A	N/A	SS	DD2508AKTA-5B-E	V	V	V
512MB	CENTURY	DXV2S8EL5B/HP	N/A	N/A	DS	DD2508AKTA-5B-E	V	V	V
256MB	CENTURY	DXV6S8MC5B	N/A	N/A	SS	MT46V32M8TG-5BG	V	V	V
512MB	CENTURY	DXV2S8MC5B	N/A	N/A	DS	MT46V32M8TG-5BG	V	V	V
256MB	elixir	M2U25664DS88C3G-5T	3	elixir	SS	N2DS25680CT-5T	V	V	V
512MB	elixir	M2U51264DS8HC1G-5T	3	elixir	DS	N2DS25680CT-5T	V	V	V
256MB	Kreton	N/A	N/A	VT	SS	VT3225804T-5	V	V	V
512MB	Veritech	VU512FLTM25C	3	VM	DS	VT56DD32M8PC-5	V	V	V
256MB	Pmi	MD44256VIT3208GMHA01	2.5	MOSEL	SS	V58C2256804SAT5B	V	V	V
512MB	Pmi	MD44512VIT3208GATA03	2.5	MOSEL	DS	V58C2256804SAT5B	V	V	V
256MB	ProMOS	V826632K24SCTG-D0	2.5	N/A	SS	V58C2256804SCT5B	V	V	V
512MB	ProMOS	V826664K24SCTG-D0	2.5	N/A	DS	V58C2256804SCT5B	V	V	V
512MB	Deutron	AL6D8C53T-5B1T	2.5	PSC	DS	A2S56D30CTP	V	V	V
256MB	GEIL	GL5123200DC	N/A	N/A	SS	GL3LC32G88TG-35	V	V	V
512MB	GEIL	GL1GB3200DC	N/A	N/A	DS	GL3LC32G88TG-35	V	V	V
256MB	GEIL	GLX2563200UP	N/A	N/A	SS	GL3LC32G88TG-5A	V	V	V
256MB	GEIL	GD3200-512DC	N/A	N/A	SS	WLCSP Package	V	V	V
256MB	crucial	BL3264Z402.8TG	2	Ballistix	SS	N/A	V	V	V
512MB	crucial	BL6464Z402.16TG	2	Ballistix	DS	N/A	V	V	V
256MB	Novax	96M4256S3CE-40TB6	2.5	CEON	SS	C2S56D30TP-5	V	V	V
512MB	Aeneon	AED660UD00-500B98X	N/A	N/A	SS	AED93T500	V	V	V
512MB	Aeneon	AED66UD00-500C88X	N/A	N/A	DS	AED83T500	V	V	V
256MB	V-DATA	MDYVD6F4G2880B1EOH	N/A	N/A	SS	VDD9616A8A-5C	V	V	V
256MB	SmpleTech	SVM-42DR2/256-A	N/A	N/A	SS	838S032T05A	V	V	V
512MB	SmpleTech	SVM-42DR2/512-A	N/A	N/A	DS	838S032T05A	V	V	V

Side(s): SS - Single-Sided

DS - Double-Sided

DIMM Support:

- A - supports one module inserted into either the blue slots, in a Single-channel memory configuration.
- B - supports on pair of modules inserted into either the blue slots or the black slots as one pair of Dual-channel memory configuration.
- C - support for 4 modules inserted into the blue and black slots as two pairs of Dual-channel memory configuration.



Visit the ASUS website (www.asus.com) for the latest DDR 400 Qualified Vendors List.

1.7.3 Installing a DIMM

Follow these steps to install a DIMM.

1. Unlock a DIMM socket by pressing the retaining clips outward.
2. Align a DIMM on the socket such that the notch on the DIMM matches the break on the socket.
3. Firmly insert the DIMM into the socket until the retaining clips snap back in place and the DIMM is properly seated.

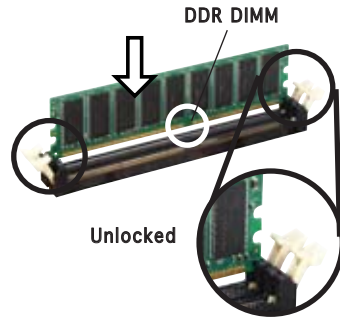

A DDR DIMM is keyed with a notch so that it fits in only one direction. DO NOT force a DIMM into a socket to avoid damaging the DIMM.

1.8 Expansion slots

To install and configure an expansion card:

1. Install an expansion card following the instructions that came with the chassis.
2. Turn on the system and change the necessary BIOS settings, if any. See Chapter 2 for BIOS information.
3. Assign an IRQ to the card. Refer to the tables next page.
4. Install the drivers and/or software applications for the expansion card according to the card documentation.

1.8.1 Standard interrupt assignments

IRQ	Priority	Standard Function
0	1	System Timer
1	2	Keyboard Controller
2	N/A	Programmable Interrupt
3*	11	IRQ holder for PCI steering
4*	12	Communications Port (COM1)
5*	13	IRQ holder for PCI steering
6	14	Floppy Disk Controller
7*	15	Printer Port (LPT1)
8	3	System CMOS/Real Time Clock
9*	4	IRQ holder for PCI steering
10*	5	IRQ holder for PCI steering
11*	6	IRQ holder for PCI steering
12*	7	PS/2 Compatible Mouse Port
13	8	Numeric Data Processor
14*	9	Primary IDE Channel
15*	10	Secondary IDE Channel

1.8.2 IRQ assignments for this motherboard

	A	B	C	D	E	F	G	H
PCI slot 1	shared	—	—	—	—	—	—	—
PCI slot 2	—	shared	—	—	—	—	—	—
PCI slot 3	—	—	shared	—	—	—	—	—
PCIe x1 slot 1	shared	—	—	—	—	—	—	—
PCIe x1 slot 2	shared	—	—	—	—	—	—	—
PCIe x16 slot	shared	—	—	—	—	—	—	—
Onboard USB controller 1	—	—	—	—	used	—	—	—
Onboard USB controller 2	—	—	—	—	—	used	—	—
Onboard USB controller 3	—	—	—	—	—	—	used	—
Onboard USB 2.0 controller	—	—	—	—	—	—	—	used
Onboard LAN	—	—	—	used	—	—	—	—
Onboard Audio	—	—	shared	—	—	—	—	—
Serial ATA	—	shared	—	—	—	—	—	—



When using PCI cards on shared slots, ensure that the drivers support “Share IRQ” or that the cards do not need IRQ assignments. Otherwise, conflicts will arise between the two PCI groups, making the system unstable and the card inoperable.

1.8.3 PCI slots

The PCI slots support PCI cards such as a LAN card, SCSI card, USB card, and other cards that comply with PCI specifications.



1.8.4 PCI Express x1 slot

This motherboard supports PCI Express x1 network cards, SCSI cards and other cards that comply with the PCI Express specifications. The figure shows a network card installed on the PCI Express x1 slot.



1.8.5 PCI Express x16 slot

This motherboard supports PCI Express x16 graphic cards that comply with the PCI Express specifications. The following figure shows a graphics card installed on the PCI Express x16 slot.



1.9 Jumpers

1. Clear RTC RAM (CLRTC)

This jumper allows you to clear the Real Time Clock (RTC) RAM in CMOS. You can clear the CMOS memory of date, time, and system setup parameters by erasing the CMOS RTC RAM data. The RAM data in CMOS, that include system setup information such as system words, is powered by the onboard button cell battery.

To erase the RTC RAM:

1. Turn OFF the computer and unplug the power cord.
2. Move the jumper cap from pins 1-2 (default) to pins 2-3. Keep the cap on pins 2-3 for about 5~10 seconds, then move the cap back to pins 1-2.
3. Plug the power cord and turn ON the computer.
4. Hold down the key during the boot process and enter BIOS setup to re-enter data.



Except when clearing the RTC RAM, never remove the cap on the jumper default position. Removing the cap will cause system boot failure!

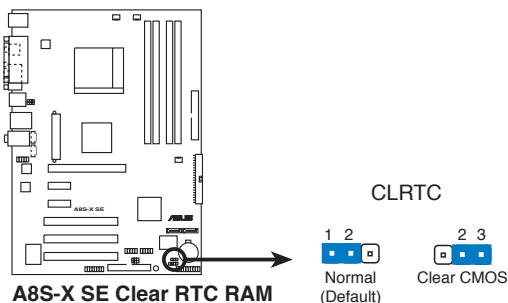

You do not need to clear the RTC when the system hangs due to overclocking. For system failure due to overclocking, use the C.P.R. (CPU Parameter Recall) feature. Shut down and reboot the system so BIOS can automatically reset parameter settings to its previous values.

2. USB device wake-up (3-pin USBPW12, USBPW34, USBPW56, USBPW78)

Set these jumpers to +5V to wake up the computer from S1 sleep mode (CPU stopped, DRAM refreshed, system running in low power mode) using the connected USB devices. Set to +5V_{SB} to wake up from S3 and S4 sleep modes (no power to CPU, DRAM in slow refresh, power supply in reduced power mode).

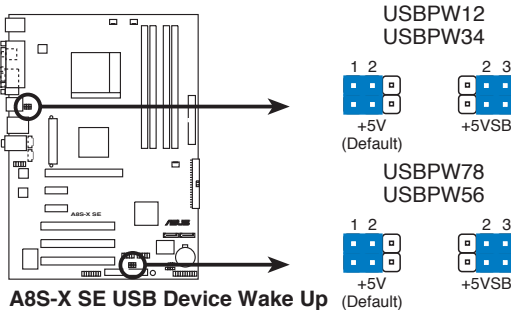

- The USB device wake-up feature requires a power supply that can provide 500mA on the +5V_{SB} lead for each USB port. Otherwise, the system would not power up.
- The total current consumed must NOT exceed the power supply capability (+5V_{SB}) whether under normal condition or in sleep mode.

1.10 Connectors

This section describes and illustrates the motherboard rear panel and internal connectors.

1.10.1 Rear panel connectors

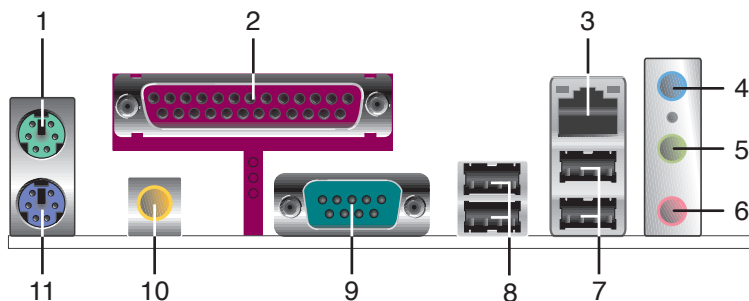

1. **PS/2 mouse port.** This green 6-pin connector is for a PS/2 mouse.
2. **Parallel port.** This 25-pin port connects a parallel printer, a scanner, or other devices.
3. **RJ-45 port.** This port allows connection to a Local Area Network (LAN) through a network hub. Refer to the table below for the LAN port LED indications.

LAN port LED indications

100Mbps ACT/LINK LED		10Mbps ACT/Link LED	
Status	Description	Status	Description
OFF	No link	OFF	No Link
YELLOW	Linked	ORANGE	Linked
BLINKING	Data activity	BLINKING	Data activity

100Mbps
ACT/LINK LED

10Mbps
ACT/LINK LED



LAN port

4. **Line In jack.** This Line In (light blue) jack connects a tape player or other audio sources. In 6-channel mode, the function of this jack becomes Surround Out.
5. **Line Out jack.** This Line Out (lime) jack connects a headphone or a speaker. In 6-channel mode, the function of this jack becomes Front Speaker Out.
6. **Microphone jack.** This Mic (pink) jack connects a microphone. In 6-channel mode, the function of this jack becomes Center/Bass.



The functions of the Line Out, Line In, and Microphone jacks change when you select the 6-channel audio configuration as shown in the following table.

Audio 2, 4 or 6-channel configuration

	Headphone/2-Speaker	4-Speaker	6-Speaker
Light Blue	Line In	Surround Out	Surround Out
Lime	Line Out	Front Speaker Out	Front Speaker Out
Pink	Mic In	Mic	Center/Bass

- USB 2.0 ports 3 and 4.** These two 4-pin Universal Serial Bus (USB) ports are available for connecting USB 2.0 devices.
- USB 2.0 ports 1 and 2.** These two 4-pin Universal Serial Bus (USB) ports are available for connecting USB 2.0 devices.
- Serial connector.** This 9-pin COM1 port is for serial devices.
- Coaxial S/PDIF Out port.** This port connects an external audio output device via a coaxial S/PDIF cable.
- PS/2 keyboard port.** This purple connector is for a PS/2 keyboard.

1.10.2 Internal connectors

1. IDE connectors (40-1 pin PRI_IDE, SEC_IDE)

This connector supports the provided UltraATA133 IDE hard disk ribbon cable. Connect the cable's blue connector to the primary (recommended) or secondary IDE connector, then connect the gray connector to the UltraATA133 slave device (hard disk drive) and the black connector to the UltraATA133 master device.



- Follow the hard disk drive documentation when setting the device in master or slave mode.
- Pin 20 on each IDE connector is removed to match the covered hole on the UltraATA cable connector. This prevents incorrect orientation when you connect the cables.
- The hole near the blue connector on the UltraATA cable is intentional.

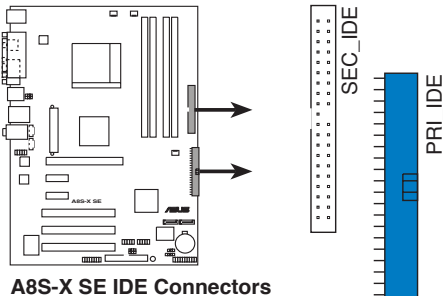

2. Floppy disk drive connector (34-1 pin FLOPPY)

This connector supports the provided floppy drive ribbon cable. After connecting one end to the motherboard, connect the other end to the floppy drive. (Pin 5 is removed to prevent incorrect insertion when using ribbon cables with pin 5 plug).

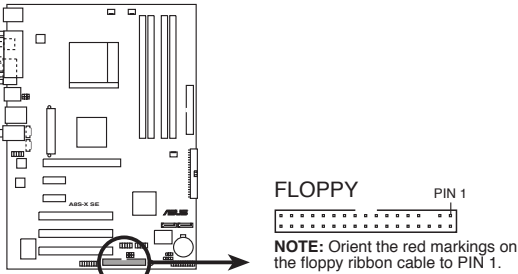

A8S-X SE Floppy Disk Drive Connector

3. Internal audio connectors (4-pin CD, AUX)

These connectors allow you to receive stereo audio input from sound sources such as a CD-ROM, TV tuner, or MPEG card.

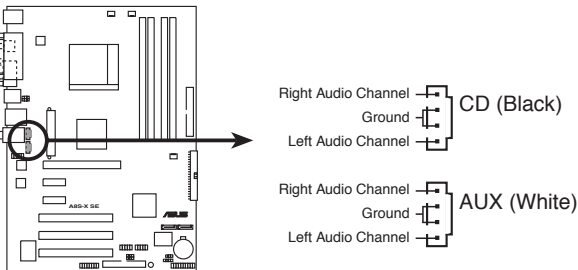

A8S-X SE Internal Audio Connectors

4. ATX power connectors (24-pin EATXPWR, 4-pin ATX12V)

These connectors are for an ATX power supply plugs. The power supply plugs are designed to fit these connectors in only one orientation. Find the proper orientation and push down firmly until the connectors completely fit.



- Use of an ATX 12 V Specification 2.0-compliant power supply unit (PSU) that provides a minimum power of 350 W is recommended for a fully-configured system.
- Do not forget to connect the 4-pin ATX +12 V power plug; otherwise, the system will not boot up.
- Use of a power supply unit (PSU) with a higher power output is recommended when configuring a system with more power-consuming devices. The system may become unstable or may not boot up if the power is inadequate.
- Make sure that your PSU can provide at least the minimum power required by your system.

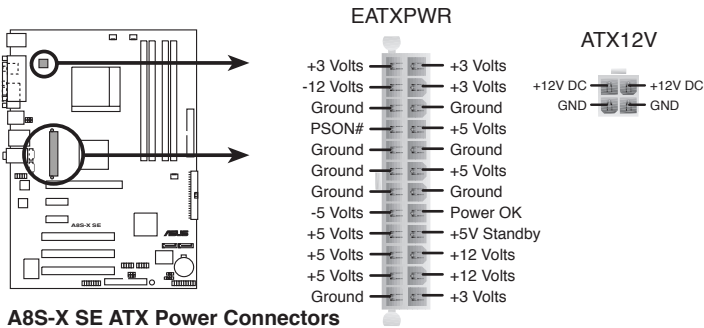

5. CPU and chassis fan connectors (3-pin CPU_FAN, CHA_FAN, PWR_FAN)

The fan connectors support cooling fans of 350mA~740mA (8.88W max.) or a total of 1A~2.22A (26.64W max.) at +12V. Connect the fan cables to the fan connectors on the motherboard, making sure that the black wire of each cable matches the ground pin of the connector.



Do not forget to connect the fan cables to the fan connectors. Lack of sufficient air flow within the system may damage the motherboard components. These are not jumpers! DO NOT place jumper caps on the fan connectors!

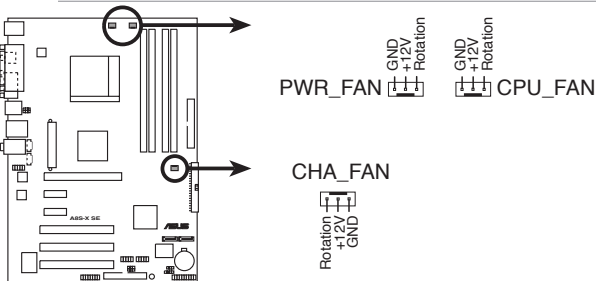

A8S-X SE Fan Connectors

6. USB header (10-1 pin USB56, USB78)

If the USB ports on the rear panel are inadequate, a USB header is available for additional USB ports. Connect the USB cable of the USB 2.0 module to this header. You may install the USB module in the chassis front panel. The module has two USB 2.0 ports for connecting next generation USB peripherals such as high resolution cameras, scanners, and printers.

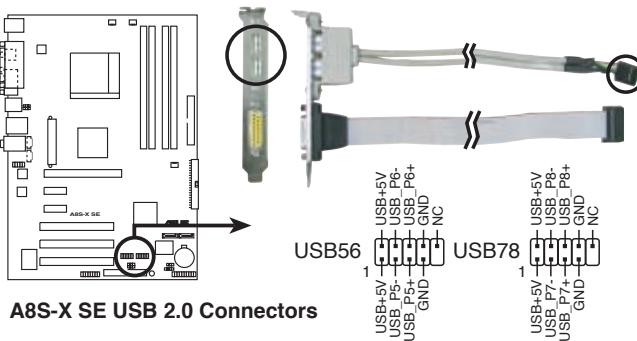

A8S-X SE USB 2.0 Connectors



The USB/GAME module is purchased separately.

7. Chassis intrusion connector (4-1 pin CHASSIS)

This lead is for a chassis designed with intrusion detection feature. This requires an external detection mechanism such as a chassis intrusion sensor or microswitch. When you remove any chassis component, the sensor triggers and sends a high-level signal to this lead to record a chassis intrusion event.

By default, the pins labeled “Chassis Signal” and “Ground” are shorted with a jumper cap. If you wish to use the chassis intrusion detection feature, remove the jumper cap from the pins.

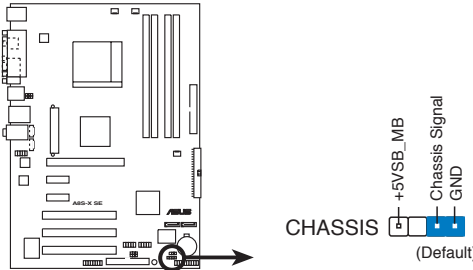

A8S-X SE Chassis Intrusion Connector

8. GAME/MIDI connector (16-1 pin GAME)

This connector supports a GAME/MIDI module. If a GAME/MIDI module is available, connect the GAME/MIDI cable to this connector. The GAME/MIDI port on the module connects a joystick or a game pad for playing games, and MIDI devices for playing or editing audio files.

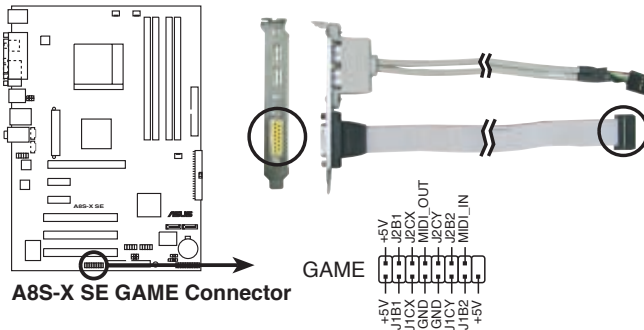

A8S-X SE GAME Connector



The USB/GAME module is purchased separately.

9. Serial ATA connectors (7-pin SATA1, SATA2)

These next generation connectors support the thin Serial ATA cables for primary internal storage devices. The current Serial ATA interface allows up to 150 MB/s data transfer rate, faster than the standard parallel ATA with 133MB/s (Ultra ATA/133).

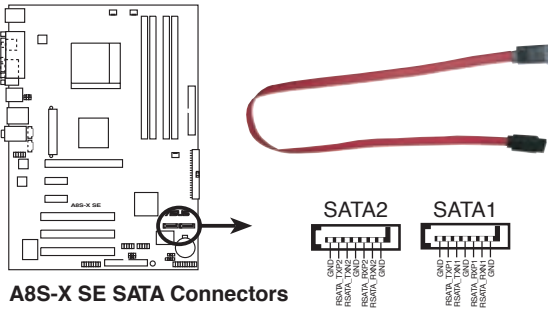

A8S-X SE SATA Connectors

10. Front panel audio connector (10-1 pin AAFP)

This connector is for a chassis-mounted front panel audio I/O module that supports legacy AC '97 audio standard. Connect one end of the front panel audio I/O module cable to this connector.

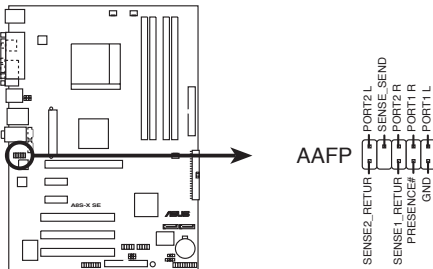

A8S-X SE Analog Front Panel Connector

12. System panel connector (10-1 pin PANEL)

This connector accommodates several system front panel functions.

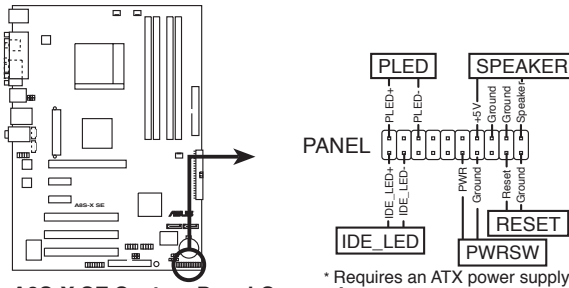

A8S-X SE System Panel Connector

- **System Power LED Lead (Green 3-pin PLED)**
This 3-pin connector connects to the system power LED. The LED lights up when you turn on the system power, and blinks when the system is in sleep mode.
- **System Warning Speaker Lead (Orange 4-pin SPEAKER)**
This 4-pin connector connects to the case-mounted speaker and allows you to hear system beeps and warnings.
- **Reset Switch Lead (Blue 2-pin RESET)**
This 2-pin connector connects to the case-mounted reset switch for rebooting the system without turning off the system power.
- **ATX Power Switch / Soft-Off Switch Lead (Yellow 2-pin PWRSW)**
This connector connects a switch that controls the system power. Pressing the power switch turns the system between ON and SLEEP, or ON and SOFT OFF, depending on the BIOS or OS settings. Pressing the power switch while in the ON mode for more than 4 seconds turns the system OFF.
- **Hard disk activity LED (Red 2-pin IDE_LED)**
This connector supplies power to the hard disk activity LED. Any read or write activity of an IDE device cause this LED to light up.



The System Panel connector is color-coded for easy and foolproof connection. Take note of the specific connector colors as described.

This chapter tells how to change the system settings through the BIOS Setup menus. Detailed descriptions of the BIOS parameters are also provided.

BIOS setup **2**

2.1 Managing and updating your BIOS

The following utilities allow you to manage and update the motherboard Basic Input/Output System (BIOS) setup.

1. **ASUS AFUDOS** - Updates the BIOS using a bootable floppy disk in DOS mode.
2. **ASUS EZ Flash** - Updates the BIOS using a floppy disk during POST.
3. **ASUS CrashFree BIOS 2** - Updates the BIOS using a bootable floppy disk or the motherboard support CD.

Refer to the corresponding sections for details on these utilities.



Save a copy of the original motherboard BIOS file to a bootable floppy disk in case you need to restore the BIOS in the future. Copy the original motherboard BIOS using the ASUS Update or AFUDOS utilities.

2.1.1 Creating a bootable floppy disk

1. Do either one of the following to create a bootable floppy disk.

DOS environment

- a. Insert a 1.44MB floppy disk into the drive.
- b. At the DOS prompt, type format **a: /s** then press <Enter>.

Windows® XP environment

- a. Insert a 1.44 MB floppy disk to the floppy disk drive.
- b. Click **Start** from the Windows® desktop, then select **My Computer**.
- c. Select the 3 1/2 Floppy Drive icon.
- d. Click **File** from the menu, then select **Format. A Format 3 1/2 Floppy Disk** window appears.
- e. Select **Create an MS-DOS startup disk** from the format options field, then click **Start**.

Windows® 2000 environment

To create a set of boot disks for Windows® 2000:

- a. Insert a formatted, high density 1.44 MB floppy disk into the drive.
- b. Insert the Windows® 2000 CD to the optical drive.
- c. Click **Start**, then select **Run**.

- d. From the Open field, type
`D:\bootdisk\makeboot a:`
assuming that D: is your optical drive.
 - e. Press <Enter>, then follow screen instructions to continue.
2. Copy the original or the latest motherboard BIOS file to the bootable floppy disk.

2.1.2 Using AFUDOS to update the BIOS

To update the BIOS using the AFUDOS.EXE utility:

1. Visit the ASUS website (www.asus.com) to download the latest BIOS file for your motherboard. Save the BIOS file to a bootable floppy disk.



Write the BIOS file name on a piece of paper. You need to type the exact BIOS file name at the prompt.

2. Copy the AFUDOS.EXE utility from the support CD to the bootable floppy disk that contains the BIOS file.
3. Boot the system from the floppy disk.
4. At the DOS prompt, type the command line:

```
afudos /i[filename]
```

where **[filename]** means the latest (or original) BIOS file that you copied to the bootable floppy disk.

5. Press <Enter>. The succeeding screen displays the status of the update process.



The BIOS information on the screen is for reference only. What you see on your screen may not be exactly the same as shown.

```
A:\>afudos /iA8S-XSE.ROM
AMI Firmware Update Utility - Version 1.10
Copyright (C) 2002 American Megatrends, Inc. All rights reserved.

Reading file .... done
Erasing flash .... done
Writing flash .... 0x0008CC00 (9%)
```



DO NOT shutdown or reset the system while updating the BIOS! Doing so may cause system boot failure!

When the BIOS update process is complete, the utility returns to the DOS prompt.

```
A:\>afudos /iA8S-XSE.ROM
AMI Firmware Update Utility - Version 1.10
Copyright (C) 2002 American Megatrends, Inc. All rights reserved.

Reading file .... done
Erasing flash ... done
Writing flash ... done
Verifying flash .. done

A:\>
```

5. Reboot the system from the hard disk.

2.1.3 Using AFUDOS to copy BIOS from PC

You can use the AFUDOS.EXE utility to copy the current system BIOS to a floppy or hard disk and use it as a backup in case the system BIOS fails or gets corrupted.

To copy the BIOS from your PC using **AFUDOS.EXE**:

1. At the DOS prompt, type the command line:

```
afudos /o[filename]
```

where [filename] string of not more than eight (8) alpha-numeric characters for the main filename and three (3) alpha-numeric characters for the extension name.

2. Press <Enter>.



The BIOS information on the screen is for reference only. What you see on your screen may not be exactly the same as shown.

Main filename
Extension name

```
A:\>afudos /oMYBIOS03.rom
AMI Firmware Update Utility - Version 1.10
Copyright (C) 2002 American Megatrends, Inc. All rights reserved.

Reading flash .... 0x0008CC00 (9%)
```

3. The utility will copy the current system BIOS by default to the floppy disk. Make sure that the floppy disk has at least 600KB of free disk space and is not write-protected.

```
A:\>afudos /oMYBIOS03.ROM
AMI Firmware Update Utility - Version 1.10
Copyright (C) 2002 American Megatrends, Inc. All rights reserved.

    Reading flash . . . . done

A:\>
```

When the copy process is complete, the utility returns to the DOS prompt.

2.1.4 Using ASUS EZ Flash to update the BIOS

The ASUS EZ Flash feature allows you to easily update the BIOS without having to go through the long process of booting from a diskette and using a DOS-based utility. The EZ Flash is built-in the BIOS firmware so it is accessible by simply pressing <Alt + F2> during the Power-On Self Tests (POST).

To update the BIOS using ASUS EZ Flash:

1. Visit the ASUS website (www.asus.com) to download the latest BIOS file for your motherboard and rename the downloaded file as **A8S-XSE.ROM**. Save the BIOS file to a floppy disk.
2. Reboot the system.
3. To launch EZ Flash, press <Alt+F2> during POST to display the following.

```
User recovery requested. Starting BIOS recovery...

Checking for floppy...
```



- If there is no floppy disk in the drive, the error message “Floppy not found!” appears.
- If the correct BIOS file is not in the floppy disk, the error message “Floppy not found!” is displayed. Make sure to rename the downloaded BIOS file as “**A8S-XSE.ROM**”.

4. Insert the floppy disk that contains the BIOS file. If all the necessary files are found in the floppy disk, EZ Flash performs the BIOS update process and automatically reboots the system when done.



DO NOT shutdown or reset the system while updating the BIOS! Doing so may cause system boot failure!

```
User recovery requested. Starting BIOS recovery...
Checking for floppy...
Floppy found!
Reading file "A8S-XSE.ROM". Completed.
Start flashing...
Flashed successfully. Rebooting.
```

2.1.5 Recovering the BIOS with CrashFree BIOS 2

The CrashFree BIOS 2 auto recovery tool allows you to restore BIOS from the motherboard support CD, or from a floppy disk that contains the BIOS file, in case the current BIOS on the motherboard fails or gets corrupted.



- Prepare the support CD that came with the motherboard or a floppy disk that contains the motherboard BIOS before proceeding with the BIOS update process.
- If you have saved a copy of the original motherboard BIOS to a bootable floppy disk, you may also use this disk to restore the BIOS. See section "2.1.1 Creating a bootable floppy disk."

To recover the BIOS from a floppy disk:

1. Boot the system.
2. When a corrupted BIOS is detected, the following screen message appears.

```
Bad BIOS checksum. Starting BIOS recovery...
Checking for floppy...
```

3. Insert a floppy disk that contains the original or the latest BIOS file for this motherboard. If all the necessary files are found in the floppy disk, the BIOS update process continues.



Make sure that the BIOS file in the floppy disk is renamed as **"A8S-XSE.ROM"**.

```
Bad BIOS checksum. Starting BIOS recovery...
Checking for floppy...

Floppy found!
Reading file "A8S-XSE.ROM". Completed.
Start flashing...
```



DO NOT shut down or reset the system while updating the BIOS! Doing so may cause system boot failure!

2. When the BIOS update process is complete, reboot the system.

To recover the BIOS from the support CD:

1. Boot the system.
2. When a corrupted BIOS is detected, the following screen message appears.

```
Bad BIOS checksum. Starting BIOS recovery...
Checking for floppy...
```



If there is no floppy disk found in the drive, the system automatically checks the CD-ROM.

3. Place the support CD in the CD-ROM. The support CD contains the a working BIOS for this motherboard.

```
Bad BIOS checksum. Starting BIOS recovery...
Checking for floppy...

Floppy not found!
Checking for CD-ROM...
CD-ROM found.
Reading file "A8S-XSE.ROM". Completed.
Start flashing...
```



DO NOT shut down or reset the system while updating the BIOS! Doing so may cause system boot failure!

2. When the BIOS update process is complete, reboot the system.



The recovered BIOS may not be the latest BIOS version for this motherboard. Visit ASUS website (www.asus.com) to download the latest BIOS file.

2.2 BIOS Setup program

This motherboard supports a programmable LPC chip that you can update using the provided utility described in section “2.1 Managing and updating your BIOS.”

Use the BIOS Setup program when you are installing a motherboard, reconfiguring your system, or prompted to “Run Setup”. This section explains how to configure your system using this utility.

Even if you are not prompted to use the Setup program, you may want to change the configuration of your computer in the future. For example, you may want to enable the security password feature or change the power management settings. This requires you to reconfigure your system using the BIOS Setup program so that the computer can recognize these changes and record them in the CMOS RAM of the LPC.

The LPC on the motherboard stores the Setup utility. When you start up the computer, the system provides you with the opportunity to run this program. Press during the Power-On Self Test (POST) to enter the Setup utility. Otherwise, POST continues with its test routines.

If you wish to enter Setup after POST, restart the system by pressing <Ctrl>+<Alt>+, or by pressing the reset button on the system chassis. You can also restart by turning the system off and then back on. Do this last option only if the first two failed.

The Setup program is designed to make it as easy to use as possible. It is a menu-driven program, which means you can scroll through the various sub-menus and make your selections from the available options using the navigation keys.



The default BIOS settings for this motherboard apply for most conditions to ensure optimum performance. If the system becomes unstable after changing any BIOS settings, load the default settings to ensure system compatibility and stability. Select the **Load Default Settings** item under the Exit Menu. See section “2.7 Exit Menu.”



The BIOS setup screens shown in this chapter are for reference purposes only, and may not exactly match what you see on your screen.

Visit the ASUS website (www.asus.com) to download the latest product and BIOS information.

2.2.1 BIOS menu screen

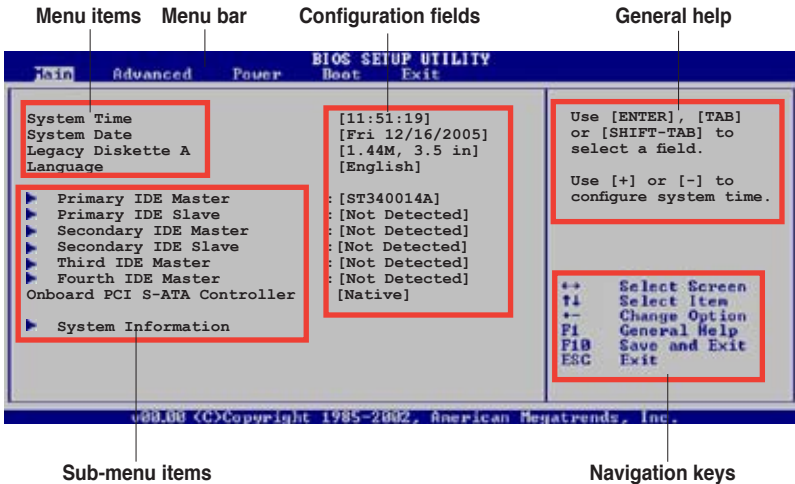

2.2.2 Menu bar

The menu bar on top of the screen has the following main items:

- Main** For changing the basic system configuration
- Advanced** For changing the advanced system settings
- Power** For changing the advanced power management (APM) configuration
- Boot** For changing the system boot configuration
- Exit** For selecting the exit options and loading default settings

To select an item on the menu bar, press the right or left arrow key on the keyboard until the desired item is highlighted.

2.2.3 Navigation keys

At the bottom right corner of a menu screen are the navigation keys for that particular menu. Use the navigation keys to select items in the menu and change the settings.



Some of the navigation keys differ from one screen to another.

2.2.4 Menu items

The highlighted item on the menu bar displays the specific items for that menu. For example, selecting **Main** shows the Main menu items.

The other items (Advanced, Power, Boot, and Exit) on the menu bar have their respective menu items.

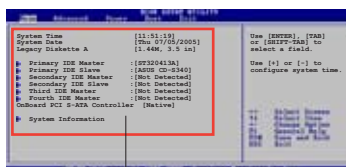

Main menu items

2.2.5 Sub-menu items

An item with a sub-menu on any menu screen is distinguished by a solid triangle before the item. To display the sub-menu, select the item and press <Enter>.

2.2.6 Configuration fields

These fields show the values for the menu items. If an item is user-configurable, you may change the value of the field opposite the item. You can not select an item that is not user-configurable.

A configurable field is enclosed in brackets, and is highlighted when selected. To change the value of a field, select it then press <Enter> to display a list of options. Refer to “2.2.7 Pop-up window.”

2.2.7 Pop-up window

Select a menu item then press Enter to display a pop-up window with the configuration options for that item.

2.2.8 Scroll bar

A scroll bar appears on the right side of a menu screen when there are items that do not fit on the screen. Press **Up/Down arrow keys** or **PageUp/ PageDown keys** to display the other items on the screen.

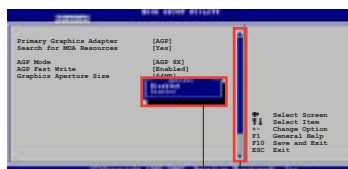

Pop-up window

Scroll bar

2.3 Main menu

When you enter the BIOS Setup program, the Main menu screen appears giving you an overview of the basic system information.



Refer to section “2.2.1 BIOS menu screen” for information on the menu screen items and how to navigate through them.

```
BIOS SETUP UTILITY
Main  Advanced  Power  Boot  Exit

System Time           [11:51:19]
System Date           [Fri 12/16/2005]
Legacy Diskette A     [1.44M, 3.5 in.]
Language              [English]

▶ Primary IDE Master   : [ST340014A]
▶ Primary IDE Slave    : [Not Detected]
▶ Secondary IDE Master : [Not Detected]
▶ Secondary IDE Slave  : [Not Detected]
▶ Third IDE Master     : [Not Detected]
▶ Fourth IDE Master    : [Not Detected]
Onboard PCI S-ATA Controller : [Native]

▶ System Information

Use [ENTER], [TAB]
or [SHIFT-TAB] to
select a field.

Use [+] or [-] to
configure system time.

↔ Select Screen
↑ Select Item
+ Change Option
F1 General Help
F10 Save and Exit
ESC Exit

v09.00 (C)Copyright 1985-2002, American Megatrends, Inc.
```

2.3.1 System Time [xx:xx:xxxx]

Allows you to set the system time.

2.3.2 System Date [Day xx/xx/xxxx]

Allows you to set the system date.

2.3.3 Legacy Diskette A [1.44M, 3.5 in.]

Sets the type of floppy drive installed.

Configuration options: [Disabled] [360K, 5.25 in.] [1.2M, 5.25 in.] [720K, 3.5 in.] [1.44M, 3.5 in.] [2.88M, 3.5 in.]

2.3.4 Language [English]

Allows you to select the BIOS language version.

Configuration options: [Chinese(BIG5)] [Japanese] [Français] [German] [English]

2.3.5 Primary, Secondary, Third and Fourth IDE Master/Slave

While entering Setup, BIOS auto-detects the presence of IDE devices. There is a separate sub-menu for each IDE device. Select a device item then press <Enter> to display the IDE device information.



The values opposite the dimmed items (Device, Vendor, Size, LBA Mode, Block Mode, PIO Mode, Async DMA, Ultra DMA, and SMART monitoring) are auto-detected by BIOS and are not user-configurable. These items show N/A if no IDE device is installed in the system.

Type [Auto]

Selects the type of IDE drive. Setting to Auto allows automatic selection of the appropriate IDE device type. Select CDROM if you are specifically configuring a CD-ROM drive. Select ARMD (ATAPI Removable Media Device) if your device is either a ZIP, LS-120, or MO drive. Configuration options: [Not Installed] [Auto] [CDROM] [ARMD]

LBA/Large Mode [Auto]

Enables or disables the LBA mode. Setting to Auto enables the LBA mode if the device supports this mode, and if the device was not previously formatted with LBA mode disabled. Configuration options: [Disabled] [Auto]

Block (Multi-sector Transfer) [Auto]

Enables or disables data multi-sectors transfers. When set to Auto, the data transfer from and to the device occurs multiple sectors at a time if the device supports multi-sector transfer feature. When set to Disabled, the data transfer from and to the device occurs one sector at a time. Configuration options: [Disabled] [Auto]

PIO Mode [Auto]

Selects the PIO mode. Configuration options: [Auto] [0] [1] [2] [3] [4]

DMA Mode [Auto]

Selects the DMA mode. Configuration options: [Auto] [SWDMA0] [SWDMA1] [SWDMA2] [MWDMA0] [MWDMA1] [MWDMA2] [UDMA0] [UDMA1] [UDMA2] [UDMA3] [UDMA4] [UDMA5]

SMART Monitoring [Auto]

Sets the Smart Monitoring, Analysis, and Reporting Technology. Configuration options: [Auto] [Disabled] [Enabled]

32Bit Data Transfer [Disabled]

Enables or disables 32-bit data transfer. Configuration options: [Disabled] [Enabled]

2.3.6 Onboard PCI S-ATA Controller [Native]

Disables or sets the onboard PCI S-ATA controller mode. Configuration options: [Disabled] [Native] [RAID]

2.3.7 System Information

This menu gives you an overview of the general system specifications. The items in this menu are auto-detected by BIOS.

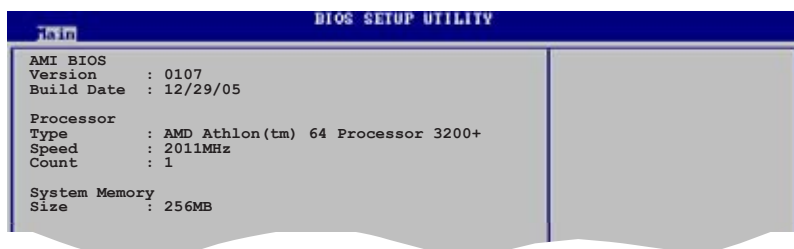

AMI BIOS

Displays the auto-detected BIOS information.

Processor

Displays the auto-detected processor information.

System Memory

Displays the auto-detected system memory.

2.4 Advanced menu

The Advanced menu items allow you to change the settings for the CPU and other system devices.



Take caution when changing the settings of the Advanced menu items. Incorrect field values may cause the system to malfunction.

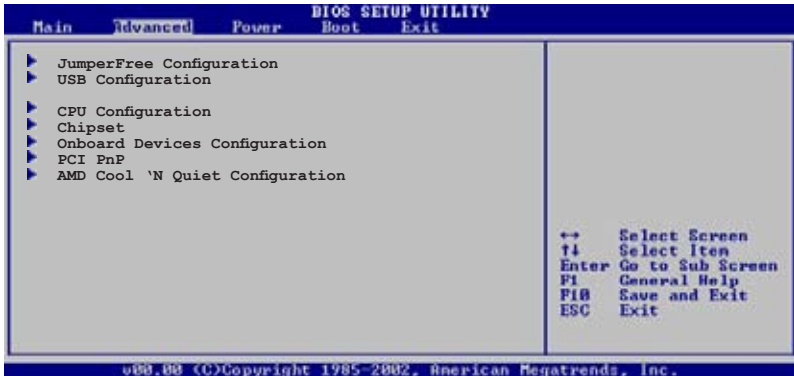

2.4.1 JumperFree Configuration



AI Overclocking [Auto]

Sets the mode for overclocking. Configuration options: [Manual] [Auto] [Overclock Profile]



The following items appear only when the Overclock Option is set to Manual.

CPU Frequency [XXX] (value is auto-detected)

Indicates the frequency sent by the clock generator to the system bus and PCI bus. The bus frequency (external frequency) multiplied by the bus multiple equals the CPU speed. The value of this item is auto-detected by BIOS. The values range from 200 to 300. Use the <+> and <-> keys to adjust the value.

PCI Express Frequency [Auto]

Allows you to set the PCI Express frequency.

Configuration options: [Auto] [90] [91] ~ [104]

PCI Clock Synchronization Mode [To PCI Express]

Sets the PCI Express clock synchronization mode.

Configuration options: [To PCI Express] [33.33MHz] [37.5MHz] [40.0MHz]

DDR Reference Voltage [Auto]

Allows you to automatically detect or select from a list the DDR operating voltage. Configuration options: [2.6V] [2.7V] [2.8V] [2.9V] [Auto]

FID/VID Change [Auto]

Sets the frequency ID and voltage ID.

Configuration options: [Auto] [Manual]

Processor Frequency Multiplier [x10 2000 MHz]

Sets the processor frequency multiplier. The default value varies depending on the processor installed. This item appears only when the FID/VID Change item is set to Manual. Configuration options: [x8 1600 MHz] [x9 1800 MHz] [x10 2000 MHz]

Processor Voltage [1.400 V]

Sets the processor voltage. The configuration options vary depending on the processor installed. This item appears only when the FID/VID Change item is set to Manual.

2.4.2 USB Configuration

The items in this menu allows you to change the USB-related features.

Select an item then press <Enter> to display the configuration options.

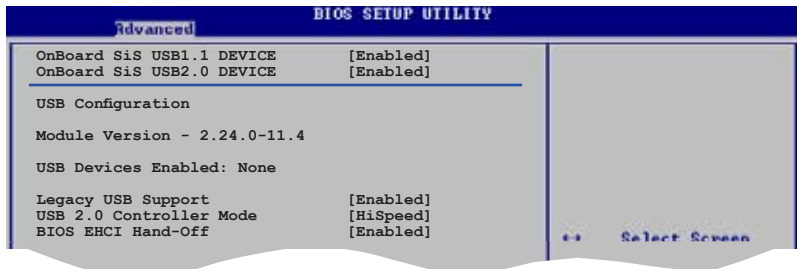

OnBoard SiS USB1.1 DEVICE [Enabled]

Allows you to enable or disable the onboard SiS USB 1.1 port.

Configuration options: [Disabled] [Enabled]

OnBoard SiS USB2.0 DEVICE [Enabled]

Allows you to enable or disable the onboard SiS USB 2.0 port.

Configuration options: [Disabled] [Enabled]



The Module Version and USB Devices Enabled items show the auto-detected values. If no USB device is detected, the item shows None.

Legacy USB Support [Enabled]

Allows you to enable or disable the legacy USB support. When set to Auto, the system disables the legacy USB support if there are no USB devices connected. Configuration options: [Disabled] [Enabled] [Auto]

USB 2.0 Controller Mode [HiSpeed]

Allows you to configure the USB 2.0 controller in HiSpeed (480 Mbps) or Full Speed (12 Mbps). Configuration options: [HiSpeed] [Full Speed]

BIOS EHCI Hand-Off [Enabled]

Allows you to stop the EHCI HC in OHCI handover. Enable this item when installing operating systems that does not support EHCI host controllers. Configuration options: [Disabled] [Enabled]

2.4.3 CPU Configuration

The CPU configuration menu displays the current CPU configuration.

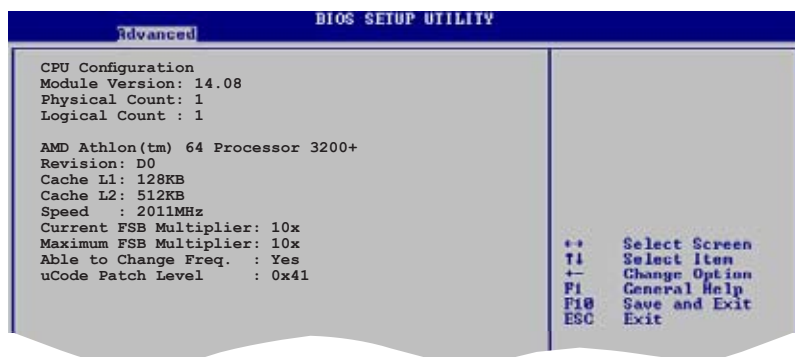

The items in this menu varies depending on the type of processor installed.

2.4.4 Chipset

The Chipset menu items allow you to change the advanced chipset settings. Select an item then press <Enter> to display the sub-menu.

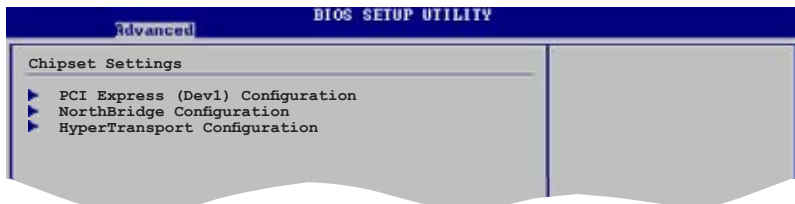

PCI Express (Dev1) Configuration

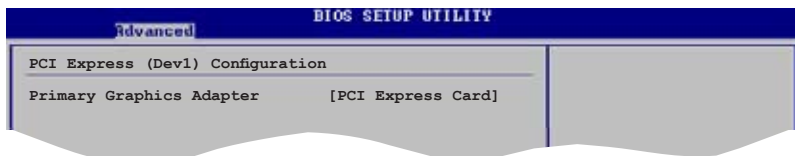

Primary Graphics Adapter [PCI Express Card]

Sets the primary graphics adapter. Configuration options: [PCI Express Card]
[PCI]

NorthBridge Configuration

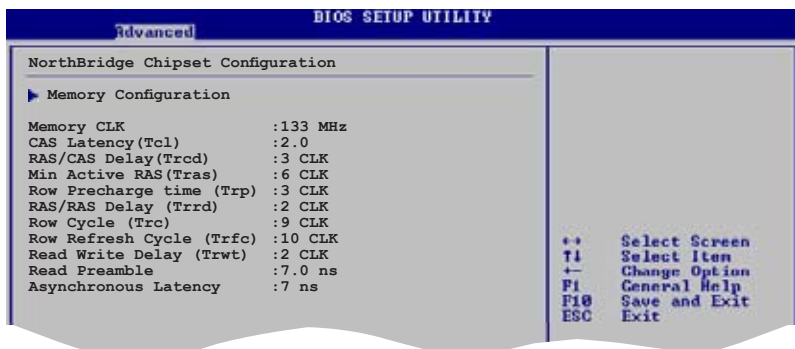

Memory Configuration

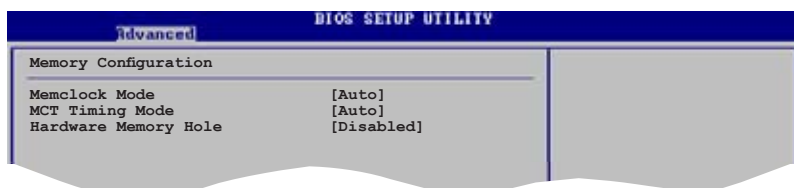

Memclock Mode [Auto]

Allows you to set the memory clock mode. Set by the code using [Auto] or select [Limit] to set using one of the standard values.

Configuration options: [Auto][Limit]



The following items appear only when the Memclock Mode is set to [Limit].

Memclock Value [100MHz]

This item sets the Memclock value.

Configuration options: [100MHz] [133MHz] [166MHz] [200MHz]

MCT Timing Mode [Auto]

Allows you to set the MCT timing mode. Set by the code using [Auto] or select [Manual] to set using one of the standard values.

Configuration options: [Auto] [Manual]



The following items appear only when the MCT Timing Mode is set to [Manual].

CAS Latency (CL) [Auto]

Sets the CAS Latency. Configuration options: [Auto] [2.0] [3.0] [2.5]

TRAS [Auto]

This item sets the TRAS.

Configuration options: [Auto] [5 CLK] [6 CLK] [7 CLK] [8 CLK] [9 CLK] [10 CLK] [11 CLK] [12 CLK] [13 CLK] [14 CLK] [15 CLK]

TRP [Auto]

Sets the TRP.

Configuration options: [Auto] [2 CLK] [3 CLK] [4 CLK] [5 CLK] [6 CLK]

TRCD [Auto]

Sets the TRCD.

Configuration options: [Auto] [2 CLK] [3 CLK] [4 CLK] [5 CLK] [6 CLK]

TRRD [Auto]

Sets the TRRD. Configuration options: [Auto] [2T] [3T] [4T]

TRC [Auto]

Sets the TRC.

Configuration options: [Auto] [7T] [8T] [9T] [10T] [11T] [12T] [13T] [14T] [15T] [16T] [17T] [18T] [19T] [20T] [21T]

TRFC [Auto]

Sets the TRFC.

Configuration options: [Auto] [9T] [10T] [11T] [12T] [13T] [14T] ... [23T]

TRWT [Auto]

Sets the TRWT.

Configuration options: [Auto] [1 CLK] [2 CLK] [3 CLK] [4 CLK] [5 CLK] [6 CLK]

Bank Interleaving[Auto]

Allows you to set the Bank Interleaving. Configuration options: [Auto] [Disable]

Hardware Memory Hole [Disabled]

Enables or disables the software memory remapping around the memory hole. Enable this item to be able to make all installed memory available. The feature is only supported by Rev E0 processors. Configuration options: [Disabled] [Enabled]

HyperTransport Configuration

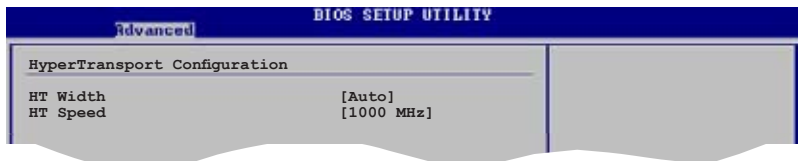

HT Width [Auto]

Allows selection of HyperTransport upstream data width. Configuration options: [8 BIT] [16 BIT] [Auto]

HT Speed [800 MHz]

Sets the HyperTransport frequency from CPU to the NorthBridge. Configuration options: [800 Mhz] [1000 Mhz]

2.4.5 Onboard Devices Configuration

Advanced		BIOS SETUP UTILITY	
Serial Port1 Address	[3F8/IRQ4]		
Serial Port1 Mode	[Normal]		
Parallel Port Address	[378]		
Parallel Port Mode	[Normal]		
Parallel Port IRQ	[IRQ7]		
Onboard Game Port	[Disabled]		
Onboard MIDI Port	[Disabled]		
Onboard SiS190 LAN Device	[Enabled]		
Onboard LAN Boot ROM	[Disabled]		
Onboard AC97 Audio DEVICE	[Enabled]		

Serial Port1 Address [3F8/IRQ4]

Allows you to select the Serial Port1 base address.

Configuration options: [Disabled] [3F8/IRQ4] [2F8/IRQ3] [3E8/IRQ4] [2E8/IRQ3]

Serial Port Mode [Normal]

Allows you to select the Serial Port mode.

Configuration options: [Normal] [IrDA] [ASK IR]

Parallel Port Address [378]

Allows you to select the Parallel Port base addresses.

Configuration options: [Disabled] [378] [278] [3BC]

Parallel Port Mode [Normal]

Allows you to select the Parallel Port mode.

Configuration options: [Normal] [EPP] [ECP] [EPP+ECP]

EPP Version [1.9]

Appears when the Parallel Port Mode is set to [EPP] or [EPP+ECP]. This item allows you to select the Parallel Port EPP version. Configuration options: [1.9] [1.7]

ECP Mode DMA Channel [DMA3]

Appears when the Parallel Port Mode is set to [ECP] or [EPP+ECP]. This item allows you to set the Parallel Port ECP DMA.

Configuration options: [DMA0] [DMA1] [DMA3]

Parallel Port IRQ [IRQ7]

Sets the Parallel Port IRQ. Configuration options: [IRQ5] [IRQ7]

Onboard Game Port [Disabled]

Enables or disables the onboard GAME port.

Configuration options: [Disabled] [Enabled]

OnBoard MIDI Port [Disabled]

Disables or sets the onboard MIDI port.
Configuration options: [Disabled] [300] [330]

OnBoard SiS190 LAN Device [Enabled]

Allows you to enable or disable the onboard LAN controller.
Configuration options: [Disabled] [Enabled]

Onboard LAN Boot ROM [Disabled]

Allows you to enable or disable the onboard LAN boot ROM.
Configuration options: [Disabled] [Enabled]

OnBoard AC'97 Audio DEVICE [Enabled]

Allows the BIOS to detect whether you are using any audio device. If an audio device is detected, the onboard audio controller is enabled; if no audio device is detected, the controller is disabled. Configuration options: [Disabled] [Enabled]

2.4.6 PCI PnP

The PCI PnP menu items allow you to change the advanced settings for PCI/PnP devices. The menu includes setting IRQ and DMA channel resources for either PCI/PnP or legacy ISA devices, and setting the memory size block for legacy ISA devices.



Take caution when changing the settings of the PCI PnP menu items. Incorrect field values may cause the system to malfunction.



Plug and Play O/S [No]

When set to [No], BIOS configures all the devices in the system. When set to [Yes] and if you installed a Plug & Play operating system, the operating system configures the Plug & Play devices not required for boot.
Configuration options: [No] [Yes]

PCI Latency Timer [64]

Allows you to select the value in units of PCI clocks for the PCI device latency timer register. Configuration options: [32] [64] [96] [128] [160] [192] [224] [248]

Allocate IRQ to PCI VGA [Yes]

When set to [Yes], BIOS assigns an IRQ to PCI VGA card if the card requests for an IRQ. When set to [No], BIOS does not assign an IRQ to the PCI VGA card even if requested. Configuration options: [Yes] [No]

Palette Snooping [Disabled]

When set to [Enabled], the palette snooping feature informs the PCI devices that an ISA graphics device is installed in the system so that the latter can function correctly. Setting to [Disabled] deactivates this feature.
Configuration options: [Disabled] [Enabled]

2.4.7 AMD Cool 'N Quiet Configuration

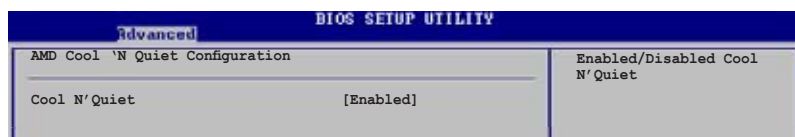

Cool 'N Quiet [Disabled]

Enables or disables the ASUS AMD Cool 'n' Quiet! technology feature.
Configuration options: [Enabled] [Disabled]

2.5 Power menu

The Power menu items allow you to change the settings for the Advanced Power Management (APM) feature. Select an item then press <Enter> to display the configuration options.



2.5.1 Suspend Mode [S1 & S3 (STR)]

Allows you to select the ACPI state to be used for system suspend.
Configuration options: [S1 (POS) Only] [S1 and S3 (STR)] [S3 Only]

2.5.2 Repost Video On S3 Resume [No]

Determines whether to invoke the VGA BIOS post on S3/STR resume.
Configuration options: [No] [Yes]

2.5.3 ACPI 2.0 Support [No]

Allows you to add more tables for ACPI 2.0 specifications.
Configuration options: [No] [Yes]

2.5.4 ACPI APIC Support [Enabled]

Enables or disables the ACPI support in the ASIC. When set to Enabled, the ACPI APIC table pointer is included in the RSDT pointer list.
Configuration options: [Disabled] [Enabled]

2.5.5 APM Configuration

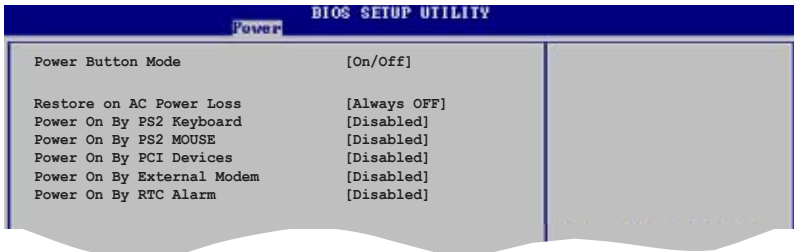

The screenshot shows the BIOS SETUP UTILITY interface with the 'Power' menu selected. The following table represents the configuration options shown in the image:

Option	Value
Power Button Mode	[On/Off]
Restore on AC Power Loss	[Always OFF]
Power On By PS2 Keyboard	[Disabled]
Power On By PS2 MOUSE	[Disabled]
Power On By PCI Devices	[Disabled]
Power On By External Modem	[Disabled]
Power On By RTC Alarm	[Disabled]

Power Button Mode [On/Off]

Allows the system to go into On/Off mode or suspend mode when the power button is pressed. Configuration options: [On/Off] [Suspend]

Restore on AC/Power Loss [Always OFF]

When set to Power Off, the system goes into off state after an AC power loss. When set to Power On, the system goes on after an AC power loss. When set to Last State, the system goes into either off or on state whatever the system state before the AC power loss. Configuration options: [Always OFF] [Always On] [Keep Previous State]

Power On By PS2 Keyboard [Disabled]

Allows you to disable or set the keyboard wake-up feature. This feature requires an ATX power supply that provides at least 1A on the +5VSB lead. Configuration options: [Disabled] [Enabled]

Power On By PS2 Mouse [Disabled]

When set to [Enabled], this parameter allows you to use the PS/2 mouse to resume the system. This feature requires an ATX power supply that provides at least 1A on the +5VSB lead. Configuration options: [Disabled] [Enabled]

Power On By PCI Devices [Disabled]

Allows you to enable or disable the PME to generate a wake event. This feature requires an ATX power supply that provides at least 1A on the +5VSB lead. Configuration options: [Disabled] [Enabled]

Power On By External Modems [Disabled]

Allows either settings of [Enabled] or [Disabled] for powering up the computer when the external modem receives a call while the computer is in Soft-off mode. Configuration options: [Disabled] [Enabled]



The computer cannot receive or transmit data until the computer and applications are fully running. Thus, connection cannot be made on the first try. Turning an external modem off and then back on while the computer is off causes an initialization string that turns the system power on.

Power On By RTC Alarm [Disabled]

Allows you to enable or disable RTC to generate a wake event. When this item is set to Enabled, the items RTC Alarm Date, RTC Alarm Hour, RTC Alarm Minute, and RTC Alarm Second appear with set values.

Configuration options: [Disabled] [Enabled]

2.5.6 Hardware Monitor

The screenshot shows the BIOS Setup Utility interface with the Hardware Monitor section selected. The screen displays various system metrics and navigation options.

Hardware Monitor	
CPU Temperature	[40.5°C/102.5°F]
MB Temperature	[33°C/91°F]
CPU Fan Speed	[3260RPM]
Chassis Fan Speed	[N/A]
Power Fan Speed	[N/A]
VCORE Voltage	[1.504V]
3.3V Voltage	[3.360V]
5V Voltage	[5.160V]
12V Voltage	[11.328V]
Smart Q-FAN Function	[Disabled]

Navigation options on the right side of the screen:

- ← Select Screen
- F1 Select Item
- Change Option
- F1 General Help
- F10 Save and Exit

CPU Temperature [xxx °C/xxx °F]

MB Temperature [xxx °C/xxx °F]

The onboard hardware monitor automatically detects and displays the motherboard and CPU temperatures.

CPU Fan Speed [xxxxRPM] or [N/A]

Chassis Fan Speed [xxxxRPM] or [N/A]

Power Fan Speed [xxxxRPM] or [N/A]

The onboard hardware monitor automatically detects and displays the CPU, chassis, and power fan speeds in rotations per minute (RPM). If any of the fans is not connected to the motherboard, the specific field shows N/A.

VCORE Voltage, +3.3V Voltage, +5V Voltage, +12V Voltage

The onboard hardware monitor automatically detects the voltage output through the onboard voltage regulators.

Smart Q-Fan Function [Disabled]

Enables or disables the ASUS Q-Fan function. Configuration options: [Disabled] [Enabled]

Q-FAN Mode [Standard]

Sets the Q-Fan mode. This item appears only when the Smart Q-Fan Function item is Enabled. Configuration options: [Quiet] [Standard] [Cool]

2.6 Boot menu

The Boot menu items allow you to change the system boot options. Select an item then press <Enter> to display the sub-menu.

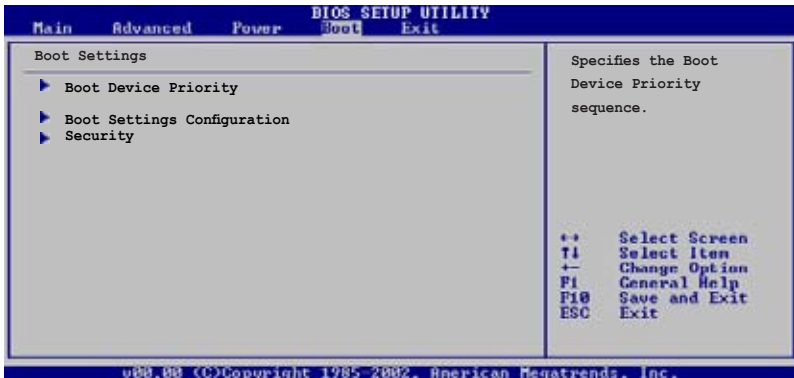

2.6.1 Boot Device Priority

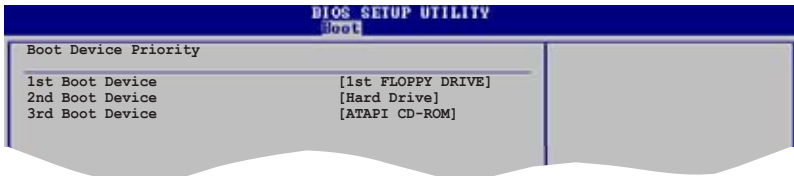

1st ~ xxth Boot Device [1st Floppy Drive]

These items specify the boot device priority sequence from the available devices. The number of device items that appear on the screen depends on the the number of devices installed in the system. Configuration options: [1st FLOPPY DRIVE][Hard Drive][ATAPI CD-ROM][Disabled]

2.6.2 Boot Settings Configuration

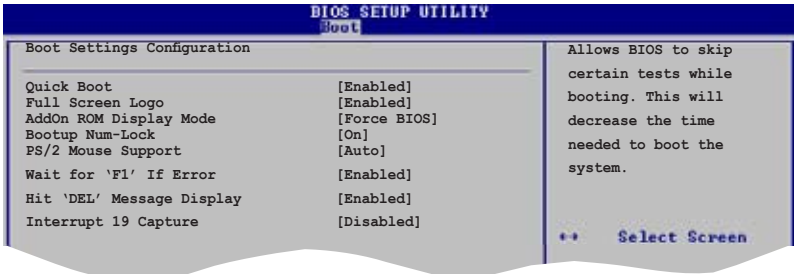

Quick Boot [Enabled]

Enabling this item allows the BIOS to skip some Power On Self Tests (POST) while booting to decrease the time needed to boot the system. When set to [Disabled], BIOS performs all the POST items. Configuration options: [Disabled] [Enabled]

Full Screen Logo [Enabled]

Allows you to enable or disable the full screen logo display feature. Configuration options: [Disabled] [Enabled]



Make sure that the above item is set to [Enabled] if you wish to use the ASUS MyLogo™ feature.

Add On ROM Display Mode [Force BIOS]

Sets the display mode for option ROM. Configuration options: [Force BIOS] [Keep Current]

Bootup Num-Lock [On]

Allows you to select the power-on state for the NumLock. Configuration options: [Off] [On]

PS/2 Mouse Support [Auto]

Allows you to enable or disable support for PS/2 mouse. Configuration options: [Disabled] [Enabled] [Auto]

Wait for 'F1' If Error [Enabled]

When set to Enabled, the system waits for F1 key to be pressed when error occurs. Configuration options: [Disabled] [Enabled]

Hit 'DEL' Message Display [Enabled]

When set to Enabled, the system displays the message "Press DEL to run Setup" during POST. Configuration options: [Disabled] [Enabled]

Interrupt 19 Capture [Disabled]

When set to [Enabled], this function allows the option ROMs to trap Interrupt 19. Configuration options: [Disabled] [Enabled]

2.6.3 Security

The Security menu items allow you to change the system security settings. Select an item then press <Enter> to display the configuration options.

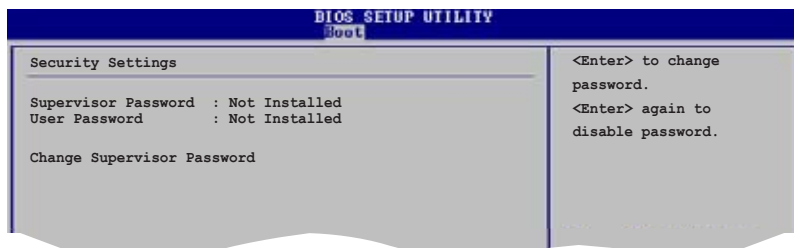

Change Supervisor Password

Select this item to set or change the supervisor password. The Supervisor Password item on top of the screen shows the default Not Installed. After you have set a password, this item shows Installed.

To set a Supervisor Password:

1. Select the Change Supervisor Password item and press <Enter>.
2. From the password box, type a password combination of at least six (6) letters and/or numbers, then press <Enter>.
3. Confirm the password when prompted. The message "Password Installed" appears after you have successfully set your password. The Supervisor Password item now shows Installed.

To change the supervisor password, follow the same steps as in setting a user password.

To clear the supervisor password, select the Change Supervisor Password then press <Enter>. The message "Password Uninstalled" appears.



If you forget your BIOS password, you can clear it by erasing the CMOS Real Time Clock (RTC) RAM. See section "1.9 Jumpers" for information on how to erase the RTC RAM.

After you have set a supervisor password, the other items appear to allow you to change other security settings.

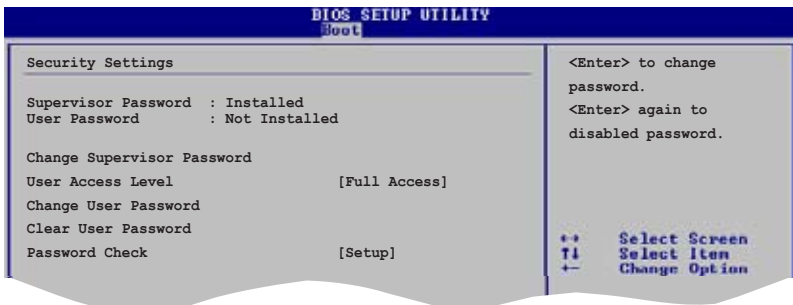

User Access Level (Full Access]

Allows you to select the access restriction to the Setup items.

Configuration options: [No Access] [View Only] [Limited] [Full Access]

No Access prevents user access to the Setup utility.

View Only allows access but does not allow change to any field.

Limited allows change only to selected fields, such as Date and Time.

Full Access allows viewing and changing all the fields in the Setup utility.

Change User Password

Select this item to set or change the user password. The User Password item on top of the screen shows the default Not Installed. After you have set a password, this item shows Installed.

To set a User Password:

1. Select the Change User Password item and press <Enter>.
2. On the password box that appears, type a password combination of at least six (6) letters and/or numbers, then press <Enter>.
3. Confirm the password when prompted. The message "Password Installed" appears after you have successfully set your password. The User Password item now shows Installed.

To change the user password, follow the same steps as in setting a user password.

Clear User Password

Select this item if you wish to clear the user password.

Password Check [Setup]

When set to [Setup], BIOS checks for user password when accessing the Setup utility. When set to [Always], BIOS checks for user password both when accessing Setup and booting the system. Configuration options: [Setup] [Always]

2.7 Exit menu

The Exit menu items allow you to load the optimal or failsafe default values for the BIOS items, and save or discard your changes to the BIOS items.



Pressing <Esc> does not immediately exit this menu. Select one of the options from this menu or <F10> from the legend bar to exit.

Exit & Save Changes

Once you are finished making your selections, choose this option from the Exit menu to ensure that the values you selected are saved to the CMOS RAM. An onboard backup battery sustains the CMOS RAM and stays on even when the PC is turned off. When you select this option, a confirmation window appears. Select **Ok** to save changes and exit.



If you attempt to exit the Setup program without saving your changes, the program prompts you with a message asking if you want to save your changes before exiting. Press <Enter> to save the changes while exiting.

Exit & Discard Changes

Select this option only if you do not want to save the changes that you made to the Setup program. If you made changes to fields other than System Date, System Time, and Password, the BIOS asks for a confirmation before exiting.

Discard Changes

Allows you to discard the selections you made and restore the previously saved values. After selecting this option, a confirmation appears. Select **Ok** to discard any changes and load the previously saved values.

Load Setup Defaults

This option allows you to load the default values for each of the parameters on the Setup menus. When you select this option or if you press <F5>, a confirmation window appears. Select **Ok** to load default values. Select **Exit & Save Changes** or make other changes before saving the values to the non-volatile RAM.

This chapter describes the contents of the support CD that comes with the motherboard package.

3 Software support

3.1 Install an operating system

This motherboard supports Windows® 2000/XP operating system (OS). Always install the latest OS version and corresponding updates to maximize the features of your hardware.



Motherboard settings and hardware options vary, so use the setup procedures presented in this chapter for general reference only. Refer to your OS documentation for more information.

3.2 Support CD information

The support CD that came with the motherboard contains useful software and several utility drivers that enhance the motherboard features.



The contents of the support CD are subject to change at any time without notice. Visit the ASUS website for updates.

3.2.1 Running the support CD

To begin using the support CD, simply insert the CD into your CD-ROM drive. The CD automatically displays the **Drivers** menu if Autorun is enabled in your computer. Click on an item to install.

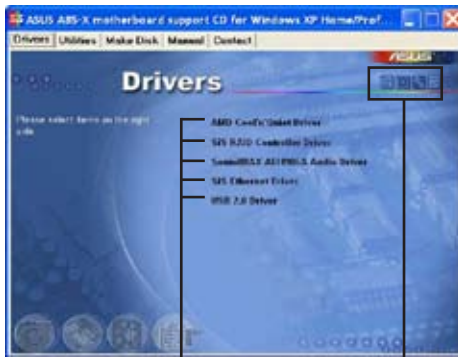

Click an item to install

Click an icon to display more information



If **Autorun** is NOT enabled in your computer, browse the contents of the support CD to locate the file **ASSETUP.EXE** from the **BIN** folder. Double-click the **ASSETUP.EXE** to run the CD.

3.2.2 Drivers menu

The drivers menu shows the available device drivers if the system detects installed devices. Install the necessary drivers to activate the devices.

AMD Cool 'n' Quiet Driver

Installs the AMD Cool 'n' Quiet! technology drivers.

SIS RAID Controller Driver

Install the SIS RAID Controller drivers.

SoundMAX ADI1986A Audio Driver

Installs the SoundMAX ADI1986A audio driver and application.

SiS Ethernet Driver

Installs the SiS Ethernet LAN driver.

USB 2.0 Driver

Installs the USB 2.0 driver to upgrade your USB 1.1 ports to USB 2.0. For Windows® XP users, make sure to install Windows XP SP 1 to support USB 2.0.

3.2.3 Utilities menu

The Utilities menu shows the applications and other software that the motherboard supports.



ASUS PC Probe II

This smart utility monitors the fan speed, CPU temperature, and system voltages, and alerts you on any detected problems. This utility helps you keep your computer at a healthy operating condition.

ASUS Update

This program allows you to download the latest version of the BIOS from the ASUS website. Before using the ASUS Update, make sure that you have an Internet connection so you can connect to the ASUS website. Installing ASUS Update also installs ASUS Mylogo™.

ASUS Screen Saver

Installs the ASUS screen saver.

ASUS Cool'n'Quiet Utility

Installs the ASUS AMD Cool 'n' Quiet utility.

Acrobat Reader

Installs the Adobe Acrobat® Reader V7.0. The Acrobat® Reader software is for viewing files saved in Portable Document Format (PDF).

Microsoft DirectX 9.0 Driver

Installs the Microsoft DirectX™9.0c driver.

Anti-virus utility

The anti-virus application detects and protects your computer from viruses that destroys data.

3.2.4 Make Disk



Make SIS RAID Controller Driver Disk

Creates the SIS RAID controller driver disk.

3.2.5 Manual



SIS965/SIS965L SATA RAID User's Manual

Allows you to open the SIS965/SIS965L Serial ATA RAID user's manual.

3.2.6 ASUS Contact Information

Clicking the ASUS Contact Information tab displays as stated. You may also find this information on the inside front cover of this user guide.



Free Manuals Download Website

<http://myh66.com>

<http://usermanuals.us>

<http://www.somanuals.com>

<http://www.4manuals.cc>

<http://www.manual-lib.com>

<http://www.404manual.com>

<http://www.luxmanual.com>

<http://aubethermostatmanual.com>

Golf course search by state

<http://golfingnear.com>

Email search by domain

<http://emailbydomain.com>

Auto manuals search

<http://auto.somanuals.com>

TV manuals search

<http://tv.somanuals.com>