



**INSTALLATION
AND
OPERATING
INSTRUCTIONS**

ELECTRIC HOT PLATES

**MODELS:
EHP, SEHP**

24 Hour Toll Free



Service Hot Line:
1-800-733-2203

! **WARNING:** Improper installation, adjustment, alteration, service or maintenance can cause property damage, injury or death. Read the installation, operating and maintenance instructions thoroughly before installing or servicing this equipment. **!**

IMPORTANT FOR FUTURE REFERENCE

Please complete this information and retain this manual for the life of the equipment. For Warranty Service and/or Parts, this information is required.

_____	_____	_____
Model Number	Serial Number	Date Purchased

P/N 88362-15 9-05

APW WYOTT Foodservice Equipment Company
P.O. Box 1829
Cheyenne, WY 82003

+1 (307) 634-5801 Phone
+1 (307) 637-8071 Fax

+1 (800) 752-0863 Toll Free
www.apwwyott.com

THIS MANUAL SHOULD BE RETAINED FOR FUTURE REFERENCE



CAUTION: These models are designed, built, and sold for commercial use. If these models are positioned so the general public can use the equipment make sure that cautions, warnings, and operating instructions are clearly posted near each unit so that anyone using the equipment will use it correctly and not injure themselves or harm the equipment.



WARNING: Check the data plate on this unit before installation. Connect the unit only to the voltage and frequency listed on the data plate. Connect only to 1 or 3 phase as listed on the data plate.



WARNING: Improper installation, adjustment, alteration, service or maintenance can cause property damage, injury or death. Read the installation, operating and maintenance instructions thoroughly before installing or servicing this equipment.



WARNING: Electrical and grounding connections must comply with the applicable portions of the national electrical code and/or other local electrical codes.



WARNING: Disconnect device from electrical power supply and place a Tag Out-Lockout on the power plug, indicating that you are working on the circuit.



WARNING: Install per the spacing requirements listed in the installation section of this manual. We strongly recommend having a competent professional install the equipment. A licensed electrician should make the electrical connections and connect power to the unit. Local codes should always be used when connecting these units to electrical power. In the absence of local codes, use the latest version of the National Electrical Code.



Maintenance & repair should be handled by a factory authorized agent. Before doing any maintenance or repair, contact APW Wyott Technical Service Department at (800) 752-0863 or (307) 634-5801.

MAINTENANCE



WARNING: Never clean any electrical unit by immersing it in water. Turn off before cleaning surface.



Once a week, or more often if necessary, clean the unit thoroughly. Turn the unit off and allow it to cool.

STAINLESS STEEL: To remove normal dirt or product residue from stainless steel, use ordinary soap and water (with or without detergent) applied with a sponge or cloth. Dry thoroughly with a clean cloth. Never use vinegar or corrosive cleaner. Do not use chlorine based cleaners.

To remove grease and food splatter or condensed vapors that have baked on the equipment, apply cleaners to a damp cloth or sponge and rub cleanser on the metal in the direction of the polished lines on the metal. Rubbing cleanser as gently as possible in the direction of the polished lines will not mar the finish of the stainless steel. NEVER RUB WITH A CIRCULAR MOTION. Soiled and burned deposits which do not respond to the above procedure can usually be removed by rubbing the surface with SCOTCH-BRITE scouring pads or STAINLESS scouring pads.



CAUTION: Do not use ordinary steel wool as any particles left on the surface will rust.



NEVER USE a wire brush, steel or abrasive scouring pads (except stainless), scraper, file or other steel tools. Surfaces which are marred collect dirt more rapidly and become more difficult to clean. Marring also increases the possibility of corrosive attack.

NEVER use any corrosive cleaner. Use only cleaners approved for stainless steel.

NEVER use cleaning solvents with a hydrocarbon base.



WARNING: SHOCK HAZARD - De-energize all power to equipment before cleaning the equipment.



Congratulations on your purchase of APW Wyott Foodservice cooking or refrigeration equipment. APW Wyott Foodservice takes pride in the design and quality of our products. When used as intended and with proper care and maintenance, you will experience years of reliable operation from this equipment. To ensure best results, it is important that you read and follow the instructions in this manual carefully.

This unit incorporates a 2000-2400 watt heating element for fast and even cooking and heating, the remotely connected control box isolates the temperature controller from the potentially damaging heat from the main unit.

TABLE OF CONTENTS

Maintenance.....	2
Troubleshooting	3
Safety Precautions.....	4
Specifications	5
Installation	5
Operation/Seasoning Instructions.....	5
Parts List & Exploded View	6
Wiring Diagram	7
Warranty	8

LOCATION OF DATA PLATE

The data plate for the electric hot plate is located on the under side of the unit.

IMMEDIATELY INSPECT FOR SHIPPING DAMAGE

All containers should be examined for damage before and during unloading. The freight carrier has assumed responsibility for its safe transit and delivery. If equipment is received damaged, either apparent or concealed, a claim must be made with the delivering carrier.

- A. Apparent damage or loss must be noted on the freight bill at the time of delivery. It must then be signed by the carrier representative (Driver). If this is not done, the carrier may refuse the claim. The carrier can supply the necessary forms.
- B. For concealed damage or loss, if not apparent until after equipment is uncrated, a request for inspection must be made to the carrier within 15 days. The carrier should arrange an inspection. Be certain to hold all contents and packaging material.

Installation and start up should be performed by a qualified installer who thoroughly read, understands and follows these instructions.

If you have any questions concerning the installation, operation, maintenance or service of this product, write Technical Service Department APW Wyott Foodservice Equipment Company, P.O. Box 1829, Cheyenne, WY 82003.

GENERAL TROUBLESHOOTING

If the units fails to operate check the following:

- 1 Is the unit connected to a live power source?
- 2 Check circuit breaker?
- 3 Is power switch on and pilot light glowing?
- 4 Check the data plate. Are you operating the unit on the proper voltage?

If the above checks out and you still have problems, call an APW Wyott authorized service agency.

NOTICE Service work should be preformed only by a qualified technician who is experienced in and knowledgeable with the operation of commercial gas, electric, steam cooking equipment. Contact the Authorized Service Agency for reliable service, dependable advise or other assistance and for genuine factory parts.

Warranty will be void and the manufacturer is relieved of all liability if:



- (A) Service work is performed by other than an APW Wyott Authorized Service Agency or
- (B) Other than Genuine APW Wyott replacement parts are installed.



A current listing of all authorized APW Wyott authorized parts/service distributors is included with this product manual at the time of shipment. In the absence of this list you call the APW Wyott 24 hour Service Hot Line which gives access to the nearest Authorized APW Wyott parts/service distributor. Call 1-800-733-2203.



SAFETY PRECAUTIONS



Before installing and operating this equipment be sure everyone involved in its operation are fully trained and are aware of all precautions. Accidents and problems can result by a failure to follow fundamental rules and precautions.



The following words and symbols, found in this manual, alert you to hazards to the operator, service personnel or the equipment. The words are defined as follows:



 **DANGER:** This symbol warns of imminent hazard which will result in serious injury or death. 



 **WARNING:** This symbol refers to a potential hazard or unsafe practice, which could result in serious injury or death. 



 **CAUTION:** This symbol refers to a potential hazard or unsafe practice, which may result in minor or moderate injury or product or property damage. 



 **NOTICE:** This symbol refers to information that needs special attention or must be fully understood even though not dangerous. 

 **NOTICE:** This product is intended for commercial use only. Not for household use Retain this manual for future reference Unit must be kept clear of combustibles at all times 

 **CAUTION:** These models are designed, built, and sold for commercial use. If these models are positioned so the general public can use the equipment make sure that cautions, warnings, and operating instructions are clearly posted near each unit so that anyone using the equipment will use it correctly and not injure themselves or harm the equipment. 

 **WARNING: SHOCK HAZARD -** Do not open any panels that require the use of tools. 

 **WARNING:** Improper installation, adjustment, alteration, service or maintenance can cause property damage, injury or death. Read the installation, operating and maintenance instructions thoroughly before installing or servicing this equipment. 

 **NOTICE:** The unit when installed, must be electrically grounded and comply with local codes, or in the absence of local codes, with the national electrical code ANSI/NFPA70- latest edition. Canadian installation must comply with CSA-STANDARD C.22.2 Number 0 M1982 General Requirements-Canadian Electrical Code Part II, 109-M1981- Commercial Cooking Appliances. 

SPECIFICATIONS

ELECTRICAL				
MODEL	VOLTS	WATTS	Hz	AMPS
EHP	208	4000	60	19.3
EHP	240	4000	60	16.7
SEPH	208	4800	60	23.1
SEPH	240	4200	60	17.5

DIMENSIONS		
HEIGHT	WIDTH	DEPTH
14	14	24
14	14	24
14	14	24
14	14	24

INSTALLATION



CAUTION: This unit to be installed in a noncombustible location only.



CAUTION: These procedures must be performed by qualified personnel or warranty will be voided.



WARNING: Check the data plate on this unit before installation. Connect the unit only to the voltage and frequency listed on the data plate. Connect only to 1 or 3 phase as listed on the data plate.



1. Unbox the hotplate. Make sure no parts are discarded with crating and packing material.
2. Always clean the equipment thoroughly before the first use. Check rating label for your model designation and electrical rating. For best results, use stainless steel countertops.
3. Attach legs to unit.
4. Set the hotplate in the operating location.

ELECTRICAL CONNECTIONS

Check the data plate to determine what voltage this hotplate is wired for and what voltage service to



WARNING: IMPROPER GROUNDING COULD RESULT IN ELECTRICAL SHOCK. This appliance is equipped with a three-prong (grounded) plug for your protection against shock hazard and should be plugged directly into a properly grounded three-prong receptacle. Do not cut or remove the grounding prong from this plug.



OPERATING/SEASONING INSTRUCTIONS

Operation: Plug hotplate in and turn on the power switch. The unit has been calibrated at the factory. Wait about thirty minutes for the unit to heat up. If the product is too cool or too warm, adjust the infinite switch. The temperature adjustment is located in the control box of the unit. If you are unable to set your hotplate to the desired temperature, contact your factory authorized service agent for adjustment.

1. All food service equipment should be operated by trained personnel.
2. Never hold food below 150° F or above 40° F.



WARNING: This unit is not intended to hold potentially hazardous foods such as uncooked or un-preserved meats and sausages.



REPLACEMENT PARTS LIST & EXPLODED VIEW

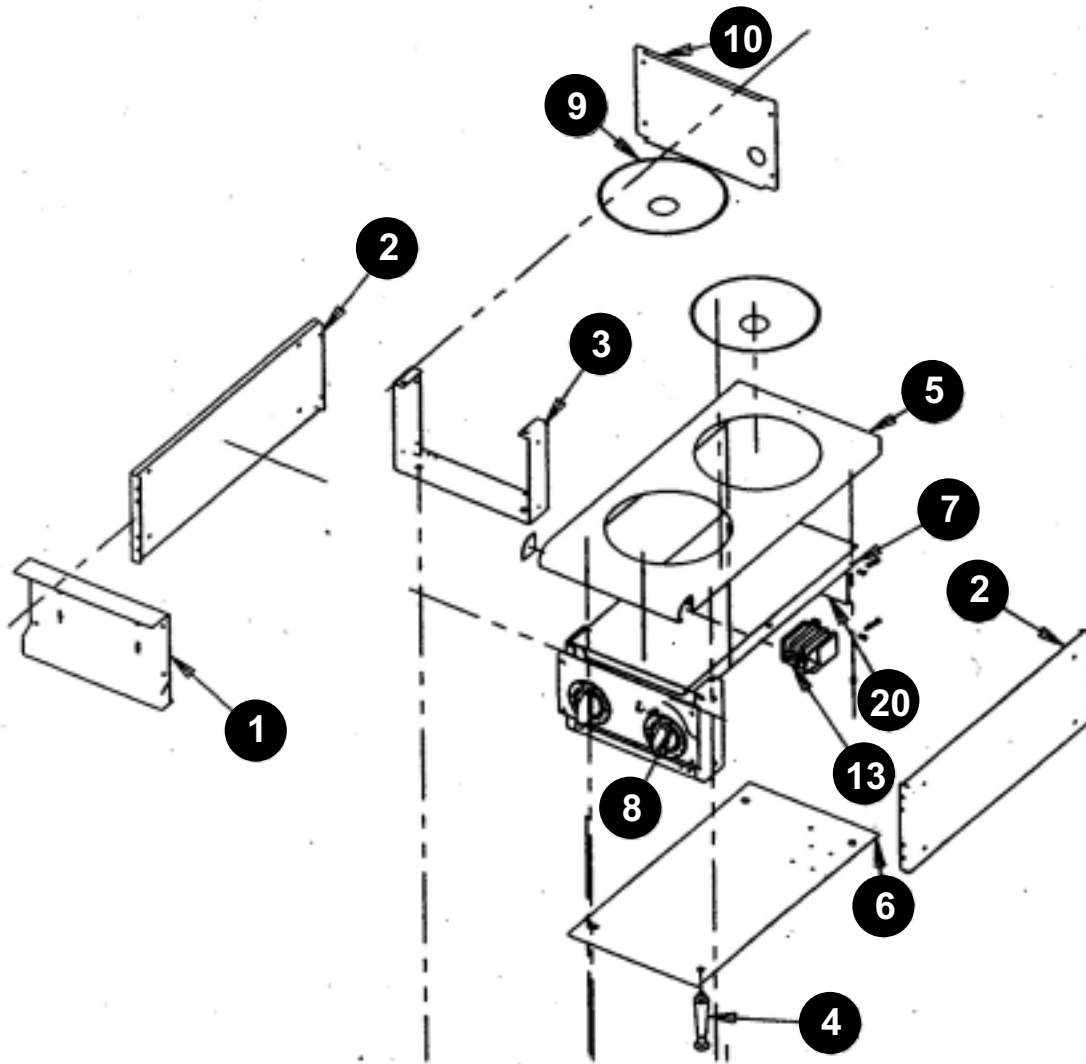

ITEM	PART NUMBER	DESCRIPTION	QUANTITY
1	218159-00	WELDMENT, FRONT PANEL	1
2	218133-13	SIDE PANEL, LEFT & RIGHT	2
3	218155-72	LEG SUPPORT	2
4	86320-00	LEG,4"	4
5	218159-50	EHP, WELDMENT, TOP	1
5	218159-51	SEHP, WELDMENT, TOP	1
5A	14104-10	SEHP, FIXING BRACKET	2
6	218159-13	PAN, OUTSIDE	1
7	218159-12	PAN, INSIDE	1
8	87056-10	KNOB	2
9	14044-07	EHP-208V, ELEMENT, HEATER, 2000W	2
9	14044-08	EHP-240V, ELEMENT, HEATER, 2000W	2
9	14104-00	SEHP-208V, HOT PLATE, EGO, 2400W	2
9	14104-01	SEHP-240V, HOT PLATE, EGO, 2100W	2
10	218155-27	BACK PANEL	1
12	13016-02	INFINITE SWITCH 240V	2
13	11072-03	TERMINAL BLOCK	1
20	218159-00	LUG, SOLDERLESS	1

WIRING DIAGRAM

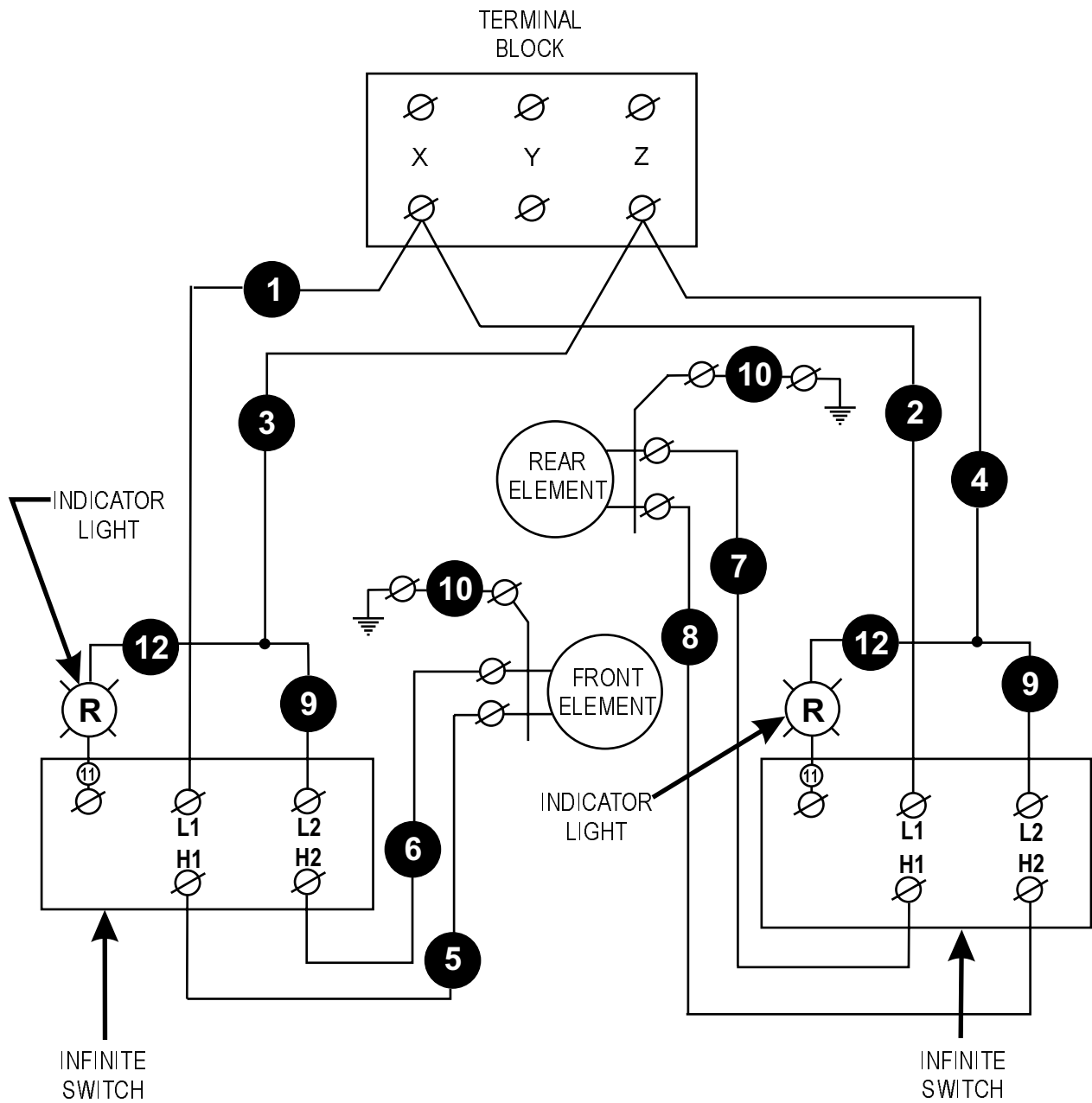

1. Wiring shown is for single phase. For three phase move wires #3 and #2 to the "Y" terminal on the terminal block.
2. On the SEHP units the #10 ground wire is omitted.
3. For power supply use #10 AWG for both single and three phase.

APW WYOTT EQUIPMENT LIMITED WARRANTY

APW Wyott Foodservice Equipment Company warrants its equipment against defects in materials and workmanship, subject to the following conditions:

This warranty applies to the original owner only and is not assignable.

Should any product fail to function in its intended manner under normal use within the limits defined in this warranty, at the option of APW Wyott such product will be repaired or replaced by APW Wyott or its Authorized Service Agency. APW Wyott will only be responsible for charges incurred or service performed by its Authorized Service Agencies. The use of other than APW Wyott Authorized Service Agencies will void this warranty and APW Wyott will not be responsible for such work or any charges associated with same. The closest APW Wyott Authorized Service Agent must be used.

This warranty covers products shipped into the 48 contiguous United States, Hawaii, metropolitan areas of Alaska and Canada. There will be no labor coverage for equipment located on any island not connected by roadway to the mainland.

Warranty coverage on products used outside the 48 contiguous United States, Hawaii, and metropolitan areas of Alaska and Canada may vary. Contact the international APW Wyott distributor, dealer, or service agency for details.

Time Period

One year for parts and one year for labor, effective from the date of purchase by the original owner. The Authorized Service Agency may, at their option, require proof of purchase. Parts replaced under this warranty are warranted for the un-expired portion of the original product warranty only.

Exceptions

- ***Gas/Electric Cookline:** Models GCB, GCRB, GF, GGM, GGT, CHP-H, EF, EG, EHP. Three (3) Year Warranty on all component parts, except switches and thermostats. (2 additional years on parts only. No labor on second or third year.)
- ***Broiler Briquettes, Rock Grates, Cooking Grates, Burner Shields, Fireboxes:** 90 Day Material Only. No Labor.
- ***Heat Strips:** Models FD, FDL, FDD, FDDL. Two (2) Year Warranty on element only. No labor second year.
- ***Glass Windows, Doors, Seals, Rubber Seals, Light Bulbs:** 90 Day Material Only. No Labor.

In all cases, parts covered by extended warranty will be shipped FOB the factory after the first year.

Portable Carry In Products

Equipment weighing over 70 pounds or permanently installed will be serviced on-site as per the terms of this warranty. Equipment weighing 70 pounds or under, and which is not permanently installed, i.e. with cord and plug, is considered portable and is subject to the following warranty handling limitations. If portable equipment fails to operate in its intended manner on the first day of connection, or use, at APW Wyott's option or its Authorized Service Agency, it will be serviced on site or replaced.

From day two through the conclusion of this warranty period, portable units must be taken to or sent prepaid to the APW Wyott Authorized Service Agency for in-warranty repairs. No mileage or travel charges are allowed on portable units after the first day of use. If the customer wants on-site service, they may receive same by paying the travel and mileage charges. Exceptions to this rule: (1) countertop warmers and cookers, which are covered under the Enhanced Warranty Program, and (2) toasters or rollergrills which have in store service.

Exclusions

The following conditions are not covered by warranty:

- *Equipment failure relating to improper installation, improper utility connection or supply and problems due to ventilation.
- *Equipment that has not been properly maintained, calibration of controls, adjustments, damage from improper cleaning and water damage to controls.
- *Equipment that has not been used in an appropriate manner, or has been subject to misuse or misapplication, neglect, abuse, accident, alteration, negligence, damage during transit, delivery or installation, fire, flood, riot or act of god.
- *Equipment that has the model number or serial number removed or altered.

If the equipment has been changed, altered, modified or repaired by other than an Authorized Service Agency during or after the warranty period, then the manufacturer shall not be liable for any damages to any person or to any property, which may result from the use of the equipment thereafter.

This warranty does not cover services performed at overtime or premium labor rates. Should service be required at times which normally involve overtime or premium labor rates, the owner shall be charged for the difference between normal service rates and such premium rates. APW Wyott does not assume any liability for extended delays in replacing or repairing any items beyond its control.

In all cases, the use of other than APW Wyott Authorized OEM Replacement Parts will void this warranty.

This equipment is intended for commercial use only. Warranty is void if equipment is installed in other than commercial application.

Water Quality Requirements

Water supply intended for a unit that has in excess of 3.0 grains of hardness per gallon (GPG) must be treated or softened before being used. Water containing over 3.0 GPG will decrease the efficiency and reduce the operation life of the unit.

Note: Product failure caused by liming or sediment buildup is not covered under warranty.

“THE FOREGOING WARRANTY IS IN LIEU OF ANY AND ALL OTHER WARRANTIES EXPRESSED OR IMPLIED INCLUDING ANY IMPLIED WARRANTY OF MERCHANTABILITY OR FITNESS FOR PARTICULAR PURPOSES AND CONSTITUTES THE ENTIRE LIABILITY OF APW WYOTT. IN NO EVENT DOES THE LIMITED WARRANTY EXTEND BEYOND THE TERMS STATED HEREIN.”

9/05

Free Manuals Download Website

<http://myh66.com>

<http://usermanuals.us>

<http://www.somanuals.com>

<http://www.4manuals.cc>

<http://www.manual-lib.com>

<http://www.404manual.com>

<http://www.luxmanual.com>

<http://aubethermostatmanual.com>

Golf course search by state

<http://golfingnear.com>

Email search by domain

<http://emailbydomain.com>

Auto manuals search

<http://auto.somanuals.com>

TV manuals search

<http://tv.somanuals.com>