

## 80kW InfraStruXure PDU

PD80KF6FK1-M  
PD80KG6FK1-M  
PD80KL6FK1-M

Operation and Configuration  
208/480/600V Input

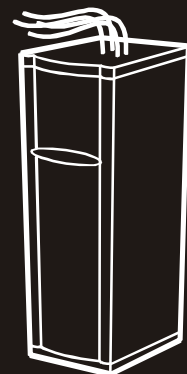



# About This Manual

---

## Audience

This manual is intended for end-users of an 80kW InfraStruXure PDU. It covers the operation, customization, and quick configuration of the InfraStruXure PDU. It also includes basic InfraStruXure system operation.

## Companion manuals

For additional information about the InfraStruXure system, see the following manuals that were included with the PDU:

- *InfraStruXure 80kW Installation and Start-Up* (990-1467B) covers the installation and start-up of InfraStruXure UPS power distribution to the rack and power distribution within the rack.
- *Certified Electrician's Instructions* (990-1469A) provides specific instructions for the electrician connecting utility conductors to the InfraStruXure PDU.

For information about specific components in your InfraStruXure system, see the documentation included with each component. Before installing or operating any component, refer to the safety instructions in the component's manual.

The illustrations of products in this manual may vary slightly from the products in your InfraStruXure system.

## How to find updates to this manual

The content in this manual is based upon the latest available information. You can check for updates to this manual by clicking on the **User Manuals** link on the **Support** page of the APC Web site ([www.apc.com](http://www.apc.com)). In the list of InfraStruXure manuals, look for the latest letter revision (A, B, etc.) of the part number on this manual.



# Contents

---

## Safety ..... 1

### Overview ..... 1

Save these instructions ..... 1

Safety symbols used in this manual ..... 1

Cross-reference symbols used in this manual ..... 1

### Warnings ..... 2

Installation/Maintenance ..... 2

Maintenance performed while the  
PDU is receiving input power ..... 2

Total Power Off ..... 3

DANGER—Risk of Electric Shock! ..... 3

Emergency Power Off (EPO) ..... 3

EMI ..... 4

## Overview ..... 5

### InfraStruXure PDU Components ..... 5

PDU front view (exterior) ..... 6

Front view (interior) ..... 7

Front view (door open) ..... 8

Rear view (interior) ..... 9

PDU monitoring unit ..... 10

User connection plate ..... 11

## PDU Display Interface ..... 13

### Overview ..... 13

Top-level status screens ..... 14

Top-level menu screen ..... 14

Navigating through screens ..... 14

Password-protected screens ..... 15

### Load-Meter Screen ..... 16

### Volt-Meter Screen ..... 17

<b>Contacts Screen</b> .....	<b>18</b>
<b>Breakers Screen</b> .....	<b>21</b>
<b>Alarms Screen</b> .....	<b>22</b>
View Active Alarms .....	22
Alarm/Event Log .....	22
Alarm Setup .....	23
Alarm Beeper .....	23
PDU Alarms .....	24
<b>Panel Screen</b> .....	<b>25</b>
Branch Ckt Loading .....	25
Branch Ckt Limits .....	25
Panel Configuration .....	26
Global Panel Config .....	27
<b>Config Screen</b> .....	<b>28</b>
System/Network .....	28
Electrical Config .....	29
Manufacturer Data .....	30
System ID .....	30
Factory Defaults .....	30
Firmware Updates .....	30
<b>System Operation</b> .....	<b>31</b>
How to Transfer the UPS into Maintenance Bypass Operation .	31
How to Return from Maintenance Bypass Operation .....	34
How to Ensure Total Power Off .....	37
How to Apply Power to the System .....	39
<b>Communication Configuration</b> .....	<b>43</b>
<b>InfraStruXure PDU Management Options</b> .....	<b>43</b>
Overview .....	43
InfraStruXure Manager .....	43
Network management interfaces .....	43
<b>Configuring the InfraStruXure Manager</b> .....	<b>44</b>

<b>Configuring the Network Management Interface . . . . .</b>	<b>45</b>
Connect the InfraStruXure PDU to your network . . . . .	45
Configuration Overview . . . . .	45
TCP/IP configuration methods . . . . .	46
Device IP Configuration Wizard . . . . .	46
BOOTP & DHCP configuration . . . . .	47
Local access to the control console . . . . .	49
Remote access to the control console . . . . .	49
Control console . . . . .	50
<b>How to Access a Network Management Interface on a Configured InfraStruXure PDU . . . . .</b>	<b>51</b>
Web interface . . . . .	51
Telnet and SSH . . . . .	52
SNMP . . . . .	52
FTP and SCP . . . . .	53
<b>How to Recover From a Lost Network Management Interface Password . . . . .</b>	<b>54</b>
<b>Customizing and Updating the PDU . . . . .</b>	<b>55</b>
<b>Important Safety Instructions . . . . .</b>	<b>55</b>
<b>PDU Orderable Part List . . . . .</b>	<b>56</b>
<b>How to Add Circuit Breakers and Power Cables . . . . .</b>	<b>58</b>
Add a circuit breaker on the PDU . . . . .	58
Add a power cable to the PDU or RDP . . . . .	58
<b>How to Test the EPO Switch . . . . .</b>	<b>60</b>
Overview . . . . .	60
Testing the EPO wiring and switches . . . . .	60
Safety warnings . . . . .	61
<b>How to Connect User Input Contacts and Relay Outputs to the PDU User Connection Plate . . . . .</b>	<b>63</b>
<b>How to Download Firmware Updates . . . . .</b>	<b>65</b>
<b>Specifications . . . . .</b>	<b>67</b>
<b>80kW InfraStruXure PDU . . . . .</b>	<b>67</b>

<b>Product Information .....</b>	<b>71</b>
<b>InfraStruXure Standard Warranty .....</b>	<b>71</b>
<b>Life-Support Policy .....</b>	<b>73</b>
<b>How to Obtain Service .....</b>	<b>74</b>
<b>Appendix .....</b>	<b>75</b>
<b>Changes in This Manual .....</b>	<b>75</b>



# Safety

## Overview

---

### Save these instructions

This manual contains important instructions that must be followed during installation, operation, and maintenance of the PDU.

### Safety symbols used in this manual



Indicates an electrical hazard, which, if not avoided, could result in injury or death.



Indicates a hazard, which, if not avoided, could result in personal injury or damage to product or other property.



Indicates a potential hazard which could result in damage to product or other property.



Indicates important information.



Indicates a heavy load that should not be lifted without assistance.



Indicates a standby state. When in standby, the unit is not operating, but it may still contain hazardous voltage. It is not safe to service until the equipment is disconnected from all sources of electrical power.

### Cross-reference symbols used in this manual



Indicates that more information is available on the same subject in a different section of this manual.



See also

Indicates that more information is available on the same subject in a different manual.

# Warnings

---

## Installation/Maintenance

Only a certified electrician can perform these tasks:

- Connect the InfraStruXure PDU to utility power
- Connect the cross tie output breaker to another InfraStruXure PDU
- Connect a switch to the EPO interface on the InfraStruXure PDU

Only a certified electrician or an APC Field Service Engineer can perform these tasks:

- Connect the PDU to the Symmetra PX UPS
- Perform maintenance of the PDU

When you connect the PDU to utility power, you must install a circuit breaker to protect the PDU against over-current. Determine the type of circuit breaker that you need to install:

<b>Input Voltage</b>	<b>Circuit Breaker Size</b>
208 V	350 A
480 V	150 A
600 V	125 A

## Maintenance performed while the PDU is receiving input power

APC does not recommend that you perform maintenance of the PDU while it is receiving input power. However, due to the critical nature of data center loads, this may occur. If you must perform maintenance while the PDU is receiving input power, observe the following precautions to reduce the risk of electric shock:

1. Never work alone.
2. Perform the maintenance only if you are a certified electrician who is trained in the hazards of live electrical installation.
3. Know the procedure for disconnecting electricity to the PDU and the data center in case of an emergency.
4. Wear appropriate personal protective equipment.
5. Use double-insulated tools.
6. Always follow local and site regulations when working on the PDU.

## Total Power Off

1. Set the Symmetra PX UPS **System Enable** switch to Off.
2. Set the **DC Disconnect** breaker of each Battery Enclosure to Off.
3. Set the PDU **Main Input (A)** switch to Off.
4. If applicable, set the PDU **Bypass Input (B)** switch to Off
5. If applicable, set the PDU **Cross Tie Output (X)** breaker to Off.
6. Set the upstream utility power circuit breaker(s) to Off.
7. Disconnect the batteries in the Battery Enclosure by pulling them out to the red disconnect line.

## DANGER—Risk of Electric Shock!



**Hazardous, live parts may exist inside the PDU because of the Symmetra PX UPS inverter even when the AC power is disconnected. Test any electrical parts before touching them.**

## Emergency Power Off (EPO)

Hazardous voltage from the branch circuit must be isolated from the 24VAC, 24VDC, and contact closure. 24VAC and 24VDC are considered Class 2 circuits as defined in Article 725 of the National Electrical Code (NFPA 70) and Section 16 of the Canadian Electrical Code (C22.1).

A Class 2 circuit is a source having limited voltage and energy capacity as follows:

- a. If an Inherently Limited Power Source, voltage and energy are limited to less than 30 VAC, less than 30 VDC, and 8 A.
- b. If not an Inherently Limited Power Source, voltage and energy are limited to less than 30 VAC, less than 60 VDC, 250 VA, and the current is limited to 1000/V max. The fuse is limited to 5 A if less than 20 VAC or 20 VDC, or 100/V maximum if less than 30 VAC or 60 VDC.

If you choose to use a 24VAC, 24VDC, or contact closure connection to the EPO, use one of the following UL-listed wire types:

- CL2 Class 2 cable for general purpose use
- CL2P Plenum cable for use in ducts, plenums, and other space used for environmental air
- CL2R Riser cable for use in a vertical run shaft from floor to floor
- CL2X Limited Use cable for use in dwellings and for use in a raceway
- For installation in Canada, the cable should be CSA Certified, type ELC (extra-low-voltage control cable).

If you do not use a CL2 cable, route the EPO wiring in conduit that does not contain any branch circuit wiring.

## **EMI**

This equipment has been tested and found to comply with the limits for a Class A digital device, pursuant to part 15 of the FCC Rules. These limits are designed to provide reasonable protection against harmful interference when the equipment is operated in a commercial environment. This equipment generates, uses, and can radiate radio frequency energy and, if not installed and used in accordance with this user manual, may cause harmful interference to radio communications. Operation of this equipment in a residential area is likely to cause harmful interference. The user will bear sole responsibility for correcting such interference.

*This Class A digital apparatus complies with Canadian ICES-003.*

*Cet appareil numérique de la class A est conforme a la norme NMB-003 du Canada.*

# Overview

## InfraStruXure PDU Components

The APC 80kW InfraStruXure PDU provides distribution and management of electrical power. The InfraStruXure PDU has the capacity of 80kW, accepts 208, 480, or 600V, 3-phase input, and distributes 208V, 3-phase power to equipment racks and Rack Distribution Panels (RDPs). The RDPs sit in the top 10U of specially-designed NetShelter VX enclosures and distribute power to equipment racks. The InfraStruXure PDU is housed in a specially-designed 23-inch NetShelter VX wide enclosure. Each 80kW InfraStruXure PDU has thirty pole positions available for feeding equipment racks and four, three-pole positions available for feeding RDPs. Each RDP has thirty-nine pole positions available for feeding equipment racks and one, three-pole position that back-feeds the RDP.

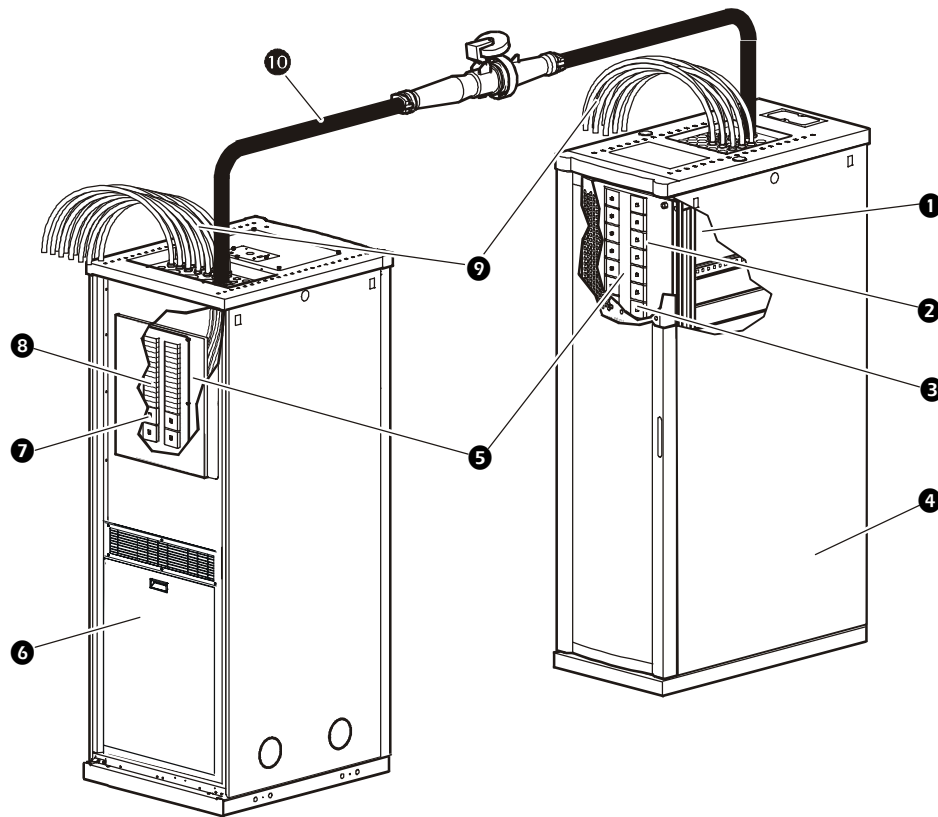

- ① Rack Distribution Panel (RDP)
- ② 39 pole positions available
- ③ One, 3-pole breaker back-feeding the RDP
- ④ NetShelter VX Enclosure
- ⑤ 42-position circuit breaker panel
- ⑥ InfraStruXure PDU
- ⑦ Four circuit breakers sub-feeding the RDPs
- ⑧ 30 pole positions available
- ⑨ Power cables feeding equipment racks
- ⑩ Sub-feed power cable feeding the RDP

## PDU front view (exterior)

- ❶ **PDU wide shielding troughs**—The PDU shielding troughs accommodate the power cables exiting the roof of the PDU.
- ❷ **Power Cables**—These power cables feed equipment racks; they are fed through knockout panels on the top (or bottom) of the PDU. The power cables consist of five wires: three phases, one neutral, and one ground. The number of power cables installed in the PDU depends on your system configuration. Each power cable has a NEMA L21-20 outlet, which accepts a variety of APC InfraStruXure accessories, including Rack PDUs and the Rack ATS.

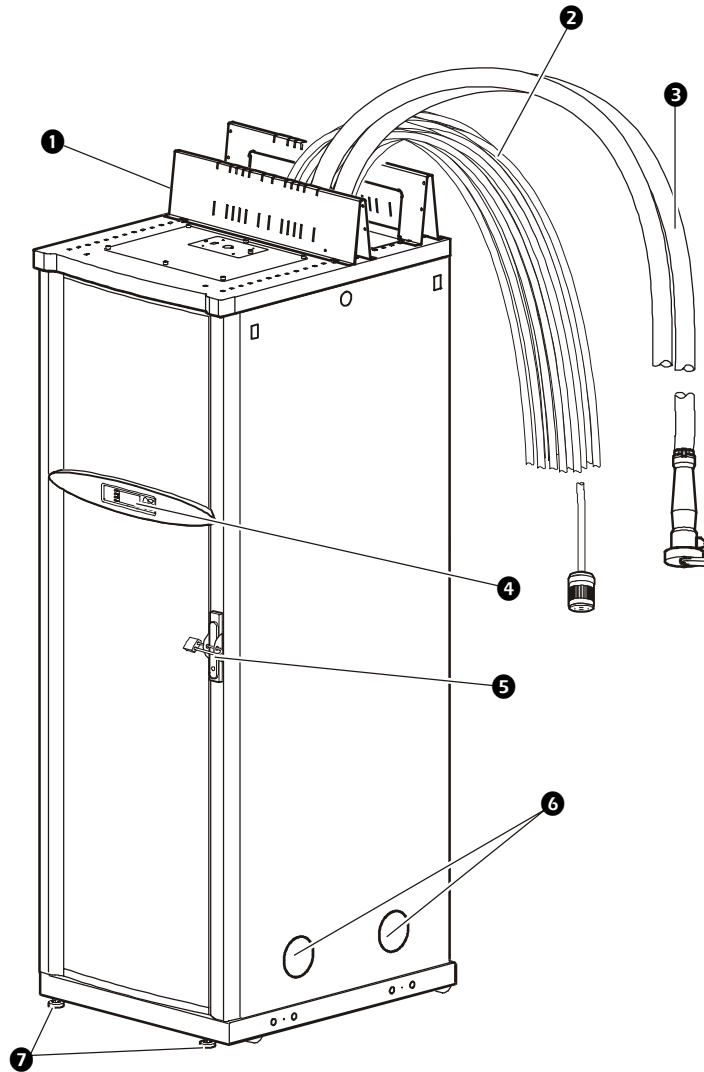

- ❸ **Sub-feed power cables**—These power cables are an option for feeding RDPs; they are fed through knockout panels on the top (or bottom) of the PDU. The power cables consist of five wires: three phases, one neutral, and one ground. You can have up to four sub-feed power cables. If you ordered this option, each power cable has an IEC 309 outlet, which connects to another sub-feed power cable fed from the RDP with an IEC 309 plug.
- ❹ **Display interface**—The display interface is attached to the name plate on the front door of the enclosure. It has an LCD, five-button interface, basic status lights, and a beeper.
- ❺ **Lock-out bracket**—The bracket allows for a padlock to be applied to the door to lock access to the PDU switches and breakers.
- ❻ **Cable access holes**—Both side panels on the PDU have cable access holes for Symmetra PX UPS input and output wiring. During installation, the APC Field Service Engineer exchanges side panels between the PDU and the Symmetra PX UPS so that the adjacent sides of the two units have panels with cable access holes.
- ❼ **Leveling feet**—The feet adjust for leveling the enclosure. All enclosures must be level before installation of the system begins.

## Front view (interior)

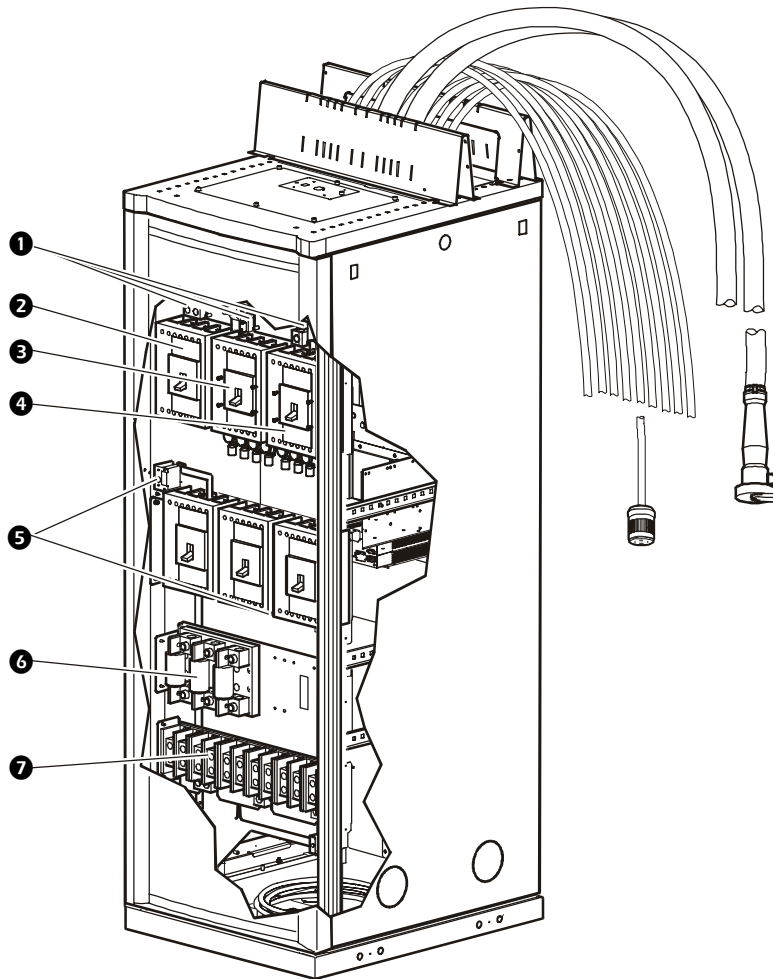

**1 Ground lugs**—Ground lugs are provided for the Main Input switch, Bypass Input switch, and Cross Tie Output breaker. The main input lug has two holes: one for a main ground and one for the GEC. See the instruction sheet, *Certified Electrician's Instructions* for more information.

**2 Main Input switch (A)**—The main power source connects to your system at the Main Input switch. See the instruction sheet, *Certified Electrician's Instructions* for more information.

**3 Optional Bypass Input switch (B)**—If you ordered a PDU that accepts input power from two different sources, your secondary power source connects to your system at the Bypass Input switch (Q10). The switch requires 208 V input and 4-wire input conductors. The secondary source must have its phases in sync with the main input source (A). See the instruction sheet, *Certified Electrician's Instructions* for more information.

**4 Optional Cross Tie Output circuit breaker (X) or MCCB subfeed**—You have the option of selecting either a cross tie or MCCB subfeed breaker. The cross tie is a 4-pole circuit breaker that outputs 208 V, 320 A to a bypass input switch on a different system. The MCCB subfeed outputs 208 V, 150 A or 208 V 225 A to a bypass input switch on a different system. Either circuit breaker allows systems to be cascaded. See “Site Planning” in the *InfraStruXure 80kW Installation and Start-Up* and the instruction sheet, *Certified Electrician's Instructions* for more information.

**5 PDU monitoring unit circuit breakers**—Power supplied to the PDU monitoring unit is controlled through these two circuit breakers.

**6 Fuses**—These fuses protect the silicon-controlled rectifiers in the UPS bypass static switch. The fuses are present only on dual-fed PDUs and single-fed PDUs without a transformer.

**7 Optional bottom feed**—If you ordered main input wiring to be routed under the floor, these terminal blocks are your connection to the Main Input switch, Bypass Input switch, and Cross Tie Output breaker.

**Front view (door open)**

**1 Wraparound maintenance bypass panel**—The maintenance bypass panel has three circuit breakers that allow the UPS to be electrically isolated from the main power source, while maintaining the power panels. The input circuit breaker is labeled Q1, the output circuit breaker is labeled Q2, and the maintenance bypass circuit breaker is labeled Q3. The label on the maintenance bypass panel of the PDU illustrates the power flow, and the H2 and H3 LEDs indicate when it is safe to operate the Q2 and Q3 circuit breakers.

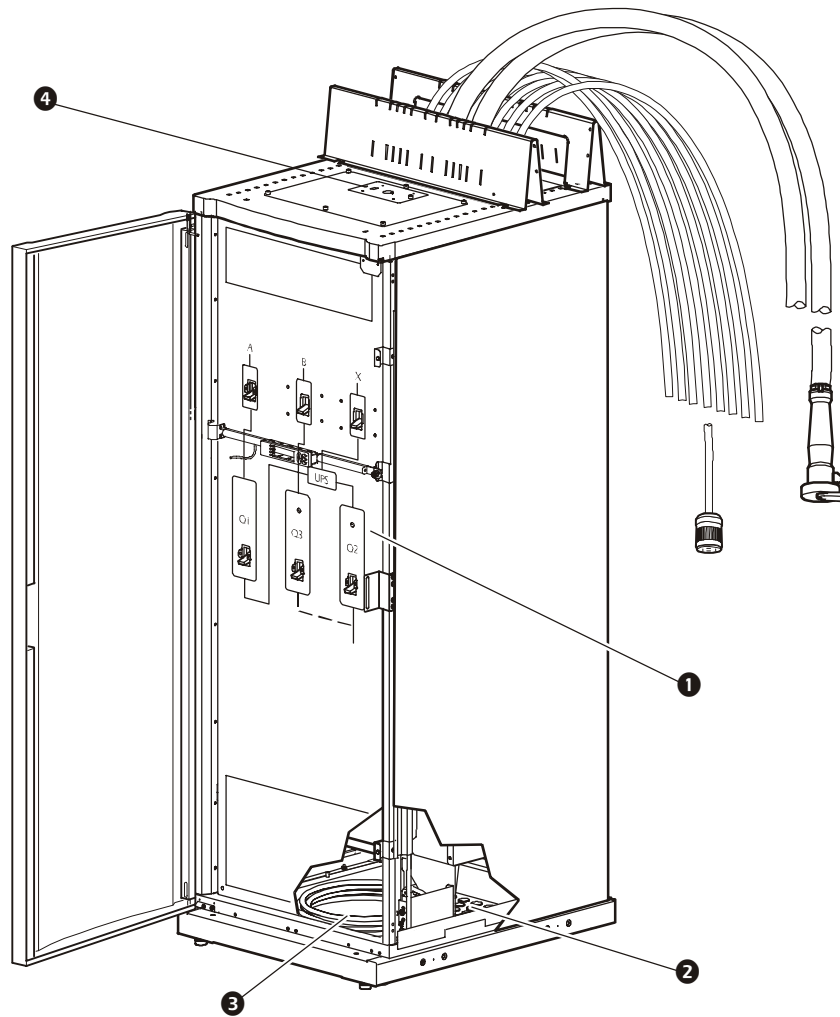

**2 Optional bottom-feed cable access**—These knockouts are for bottom-feed power cables and RDP cables. If you ordered a PDU to accommodate under-floor wiring, your power cables for equipment racks and RDPs will exit the PDU from these cable access holes.

**3 UPS input and output cables**—The cables that connect the PDU to the UPS are shipped coiled on the floor of the PDU. The input cables consist of 5 wires: 3 phases, 1 neutral, and one ground. The output cable consist of 4 wires: 3 phases and 1 neutral. The bypass cables consist of 4-wires: 3 phases and one neutral. Each wire is labeled and corresponds to a lug on the Symmetra PX UPS bus bars. During installation, the Field Service Engineer will connect the PDU to the UPS.

**4 User connection plate**—The user connection plate is connected to the PDU monitoring unit, and provides easy access to the input contacts, relay outputs, network, and EPO connections. Make connections from inside the enclosure, and route wires through the knockout provided on the plate. See “User connection plate” on page 11 for a more detailed description.



## Rear view (interior)

- ❶ **42-position circuit breaker panel**—Each PDU has a circuit breaker panel with 42 pole positions. Each pole provides power at 120 volts L-N or 208 volts L-L. The amperage each position provides depends on the size of the circuit breaker used.
- ❷ **Panel current sensors**—Wires that feed the distribution panel pass through these current sensors, providing data to the PDU monitoring unit.

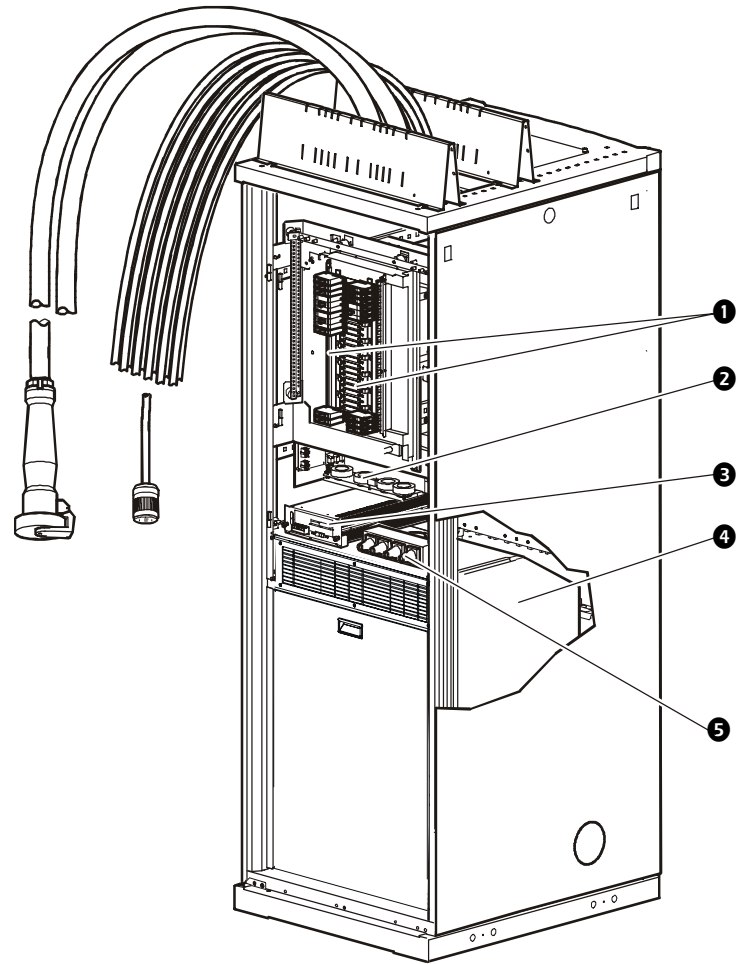

- ❸ **PDU monitoring unit**—The PDU monitoring unit receives signals from several current and voltage monitoring boards that report to a central board assembly located in the PDU monitoring unit. The monitoring unit has one 10Base-T (Cat-5) connection to the Information Controller Hub (or switch), four (4) relay output connections, four (4) input contact connections, and one (1) EPO input connection. Make these connections at the user connection plate located on the roof of the PDU. See “PDU monitoring unit” on page 10 for a more detailed description.
- ❹ **Input transformer**—The delta-wye transformer installed in your PDU is based on your input voltage (208 V, 480 V, or 600 V input). The output of the transformer feeds the input circuit breaker of the maintenance bypass panel. (APC also offers a 208 V PDU without a transformer.)
- ❺ **Load test ports**—The load test ports are an available option on the PDU. The load test bank connector allows a UPS system to be load-tested to ensure that the system will operate according to specifications if a power outage occurs.

## PDU monitoring unit

- 1 This connection provides the **input power** for the PDU monitoring unit. The power is supplied by the monitoring unit circuit breaker on the front of the PDU. If the panel is on, and the monitoring unit circuit breaker is closed, the monitoring unit is powered.
- 2 Connects to sensors monitoring values such as voltage, current, and power.
- 3 Digital input sensing for monitoring such as circuit breaker status, transformer temperature, fans, etc.
- 4 The **Display port** (RJ-45) connects the PDU monitoring unit to the PDU display interface.
- 5 The **Power LED** indicates whether the monitoring unit is receiving power from the AC output of the UPS. If the UPS is powered off, the LED remains lit—the EPO function is still available, however the monitoring unit is not powered.
- 6 Use the **Console port** (DB-9) to connect a laptop computer to the monitoring unit using an appropriate communication cable (APC part number 940-0103). This port is used to configure items relating to servicing the PDU.
- 7 **EPO DIP switches** configure the EPO input for the type of EPO switch that is connected—Normally Open (NO) or Normally Closed (NC).
- 8 When the **EPO Arm/Test rocker** is in the **Test** position, engaging the EPO switch will not cause the load to be powered off. When the rocker is in the **Armed** position, engaging the EPO switch will cause the PDU’s Main Input switch and the Symmetra PX UPS to be switched **OFF**. See “Testing the EPO wiring and switches” on page 60 for more information on testing the EPO switch.
- 9 The **EPO Armed LED** is green when the rocker is in the **Armed** position. The LED is dark when the rocker is in the **Test** position.
- 10 The **EPO Tripped LED** is red when the EPO switch is engaged (the EPO button is pressed), regardless of the state of the **EPO Arm/Test rocker**.
- 11 The **Reset button** resets the network processor; it does not reset the PDU or the PDU monitoring unit.
- 12 Connect to the InfraStruXure Manager through the **network port**.
- 13 The **To UPS** port connects the PDU monitoring unit to the Maintenance Bypass/PCB board and the EPO board inside the Symmetra PX UPS. This port is connected to wire harnesses secured inside the PDU that are connected to the Symmetra PX UPS during installation of the system.
- 14 The optional **User/EPO Contacts** port is connected to wire harnesses that connect to the User Connection Plate in the roof (or floor) of the PDU. The port allows for relay outputs (4), input contacts (4), and an EPO input (1). See “How to connect contacts to the PDU monitoring unit” on page 20 and “Testing the EPO wiring and switches” on page 60 for more information.

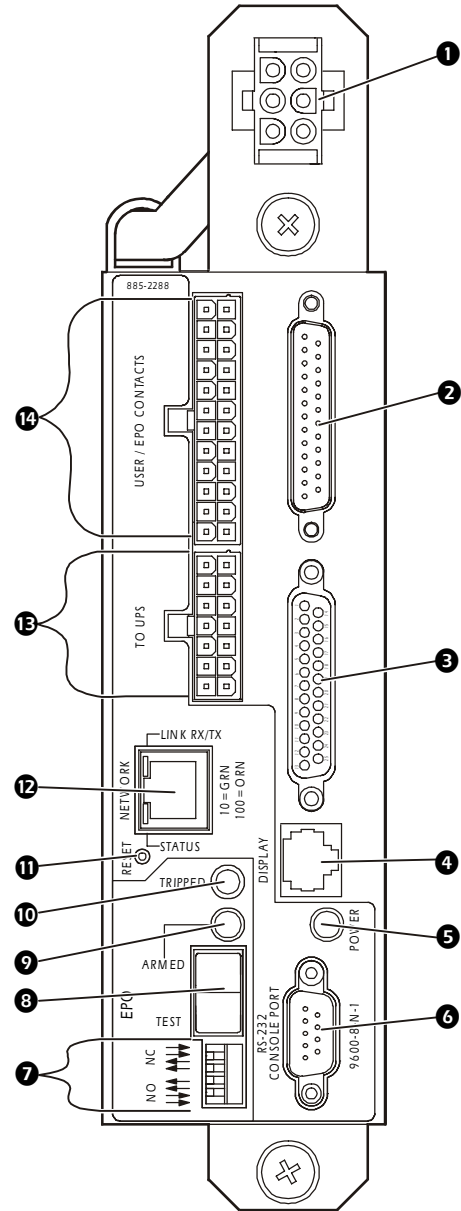

**Note**

The branch current monitoring boards connect to the **Branch Current Monitor** ports (RJ-11). These ports are on the top side of the PDU monitoring unit, and are labeled on the face of the unit. Each port corresponds to a section of circuit breakers on the PDU distribution circuit breaker panel: upper left=[01..41]; upper right=[02..42]; lower left=[43..83]; lower right=[44..84].

## User connection plate

For a description and location of the user connection plate, see (4) on page 8. For clarity, the user connection plate is shown in the following illustration in greater detail.

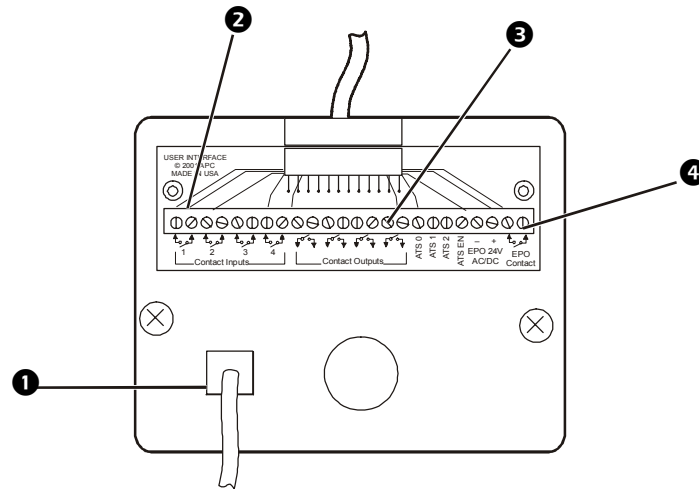

- 1 Connect the InfraStruXure PDU to the network of the InfraStruXure Manager through the **ethernet port**.
- 2 The user connection plate has four **input contact connections** for monitoring Normally Open (NO) or Normally Closed (NC) dry contacts. See page 20 and page 64 for more information.
- 3 The user connection plate has four **relay output connections** for connection of Normally Open (NO) or Normally Closed (NC) dry contacts. See page 20 and page 64 for more information.
- 4 Connect an Emergency Power Off (EPO) switch at one of three choices of **EPO connections** (24VDC, 24VAC, or contact closure). See page 60 for more information.



# PDU Display Interface

## Overview

You can use the display interface to configure settings, set alarm thresholds, and provide audible and visual alarms.

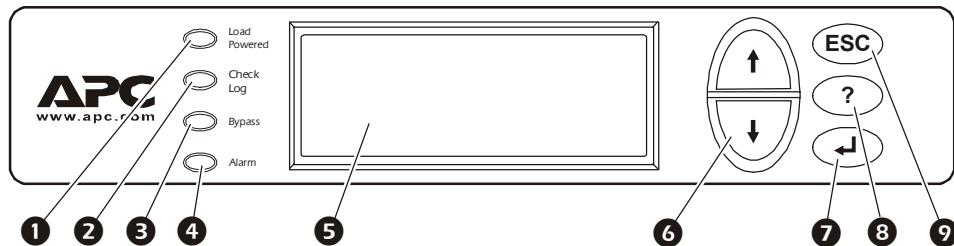

1	<b>Load On LED</b>	When green, all output phases are within the limits specified by the output alarm limit thresholds.
2	<b>Check Log LED</b>	When yellow, at least one new alarm condition has been detected.
3	<b>Bypass LED</b>	When yellow, power to the load is being supplied directly by the utility power source—the UPS has been removed from the circuit for maintenance or replacement. Bypass breakers on the PDU function as input breakers to protect the load equipment.
4	<b>Alarm LED</b>	When red, an alarm condition exists.
5	<b>LCD</b>	View alarms, status data, instructional help, and configuration items.
6	<b>Up and Down navigation keys</b>	Selects menu items and accesses information.
7	<b>ENTER key</b>	Opens menu items and inputs changes to system parameters.
8	<b>HELP key</b>	Launches context-sensitive help. Press the HELP key for information about each item on the screen and for instructions on how to perform certain tasks (i.e. placing the UPS into Maintenance Bypass operation).
9	<b>ESC key</b>	Returns to previous screen displayed.

## Top-level status screens

After system start-up, the display interface displays a brief start-up screen and then scrolls automatically and continuously through four screens of basic status information. Press the Up and Down arrow keys to interrupt the automatic scrolling if you wish to view a specific status screen.

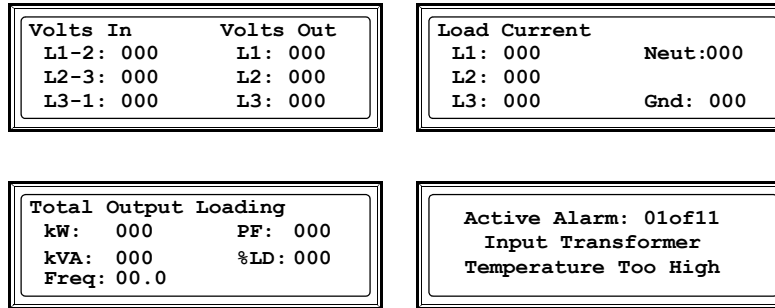

## Top-level menu screen

On any top-level status screen, press the ENTER key to open the top-level menu screen.

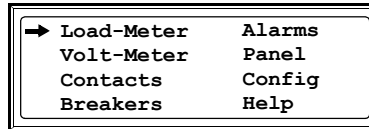

**Note**

If the display interface is inactive for the time specified as the **Time-out** setting, the interface reverts to the initial basic monitoring screens.



For descriptions of the top-level menu choices, see the individual sections starting on page 16.

## Navigating through screens

To open any screen, press the Up and Down arrow keys until the selector arrow (A) rests next to your desired selection. Press the ENTER key to view the selected screen.

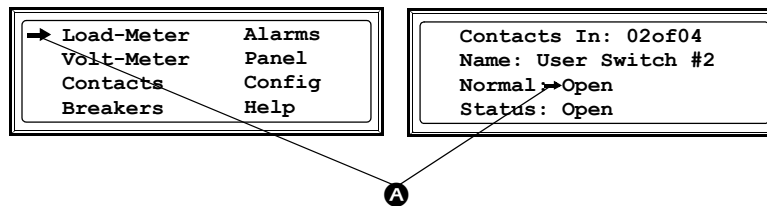

When configuring settings, press the Up and Down arrow keys until the selector arrow (A) rests next to the setting you want to change, and press the ENTER key. If the setting is a list of choices, an input arrow (B) will appear next to the setting. Press the Up and Down arrow keys until your desired change is listed. Press the ENTER key to select the setting.

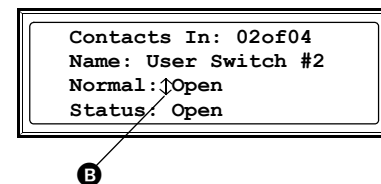

On some screens, continue arrows (Ⓞ) indicate that there are additional screens to view in the category. Press the Up or Down arrow key to view the additional screens.

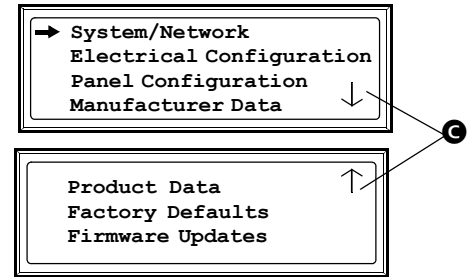

## Password-protected screens

When configuring or changing settings, you will be prompted for your password. To enter your password:

1. Press the Up or Down arrow key until the correct letter is displayed, and then press the ENTER key.



### Note

After you press the ENTER key, the character you entered is displayed as an asterisk and the input arrow moves to the next space for you to select the next password character.

2. Press the ENTER key twice after you enter your password.



See “System Password” on page 28 to change your password.

# Load-Meter Screen

---

From the **Load-Meter** screen, you can select the following items:

**Total Load by Phase** The load supported by each phase in kVA, in RMS current (**I<sub>rms</sub>**), and as a percentage of the maximum allowable load (**%LD**).

**Total Load Summary** For the total load supported:

- **kW**: The power provided, in kilowatts.
- **kVA**: The actual power drawn by the load, in kilovolt-amperes.
- **Freq**: Frequency.
- **PF**: The power factor, which affects the power available to the load.
- **%LD**: The load as a percentage of the maximum allowable load.

**Power Factor** For each phase:

- **kVA**: The actual power drawn by the load, in kilovolt-amperes.
- **kW**: The power, in kilowatts provided by the phase.
- **PF**: The power factor (kW/kVA), which affects the power available to the load.



# Volt-Meter Screen

---

From the **Volt-Meter** screen, you can select the following items:

- Output Voltage** Displays each phase-to-phase output voltage (e.g., **L1-2** for phase L1 to phase L2) and each phase-to-neutral output voltage (e.g., **L1** for phase L1 to neutral).
- Input Voltage** Displays each phase-to-phase input voltage (e.g., **L1-2** for phase L1 to L2), or, if your service transformer is a Wye transformer, each phase-to-neutral input voltage (e.g., **L1** for phase L1 to neutral).
- Bypass Voltage** Displays each phase-to-phase bypass (dual-feed input) voltage (e.g., **L1-2** for phase L1 to phase L2) and each phase-to-neutral bypass voltage (e.g., **L1** for phase L1 to neutral). Appears only on PDUs that have a bypass input switch.

# Contacts Screen

---

## Overview

The PDU can monitor external contact closure events. Possible applications include the following:

- Magnetic contact switches
- Window foil
- Tamper switches
- Heat detectors
- Water sensors
- Pressure sensors
- Building smoke and fire detection systems

You can set input contacts to cause alarm conditions based on their current state and a user-defined normal state. Relay outputs can map internal alarms and events to outside devices. Use the **Contacts** screen to display and configure information about input contacts and relay outputs.

### Input Contacts

Scroll through the list to display information about each of the installed input contacts. For example **02of04** displays information about the second of four installed input contacts.

- **Name**—The name of this input contact (*Maximum:* 14 alphanumeric characters).
- **Normal**—The normal position of this input contact, either **Open** or **Closed**.
- **Status**—The position of this input contact. If the position is not the normal position, an alarm condition occurs.

### Relay Outputs

Scroll through the list to display information about each of the installed relay outputs. For example **04of04** displays information about the fourth of four available relay outputs.

- **Name**—The name of this relay output (*Maximum:* 14 alphanumeric characters).
- **Normal**—The normal position of this relay output, either **Open** or **Closed**.
- **Status**—The position of this relay output.



See “Relay Outputs” on page 68 for relay output specifications.

## Alarm Relay Map

Configure the relay outputs, using the Alarm Relay Map. Each Alarm Map corresponds to an output relay. For

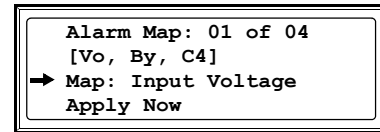

example, Alarm Map **01of04** corresponds to the first of four relay outputs. The second line, in brackets [ ], lists the items that you have selected to map to the selected relay. The third line allows you to select the alarms to which you want to map the relay:

- **Any Load (L)**—Maps to over- or under-current alarms for circuit breaker panels and branch circuits.
- **Overload (O)**—Maps to over-current alarms for circuit breaker panels, branch circuits, and SYSGND.
- **Input Voltage (Vi)**—Maps to any input voltage alarm.
- **Output Voltage (Vo)**—Maps to any output voltage alarm.
- **PDU in Bypass (By)**—Mapping this option will cause the output relay to actuate when the Q3 breaker is closed.
- **Any Breaker (Br)**—Mapping this option will cause the output relay to actuate when the input, bypass input (Q10), or cross-tie output breaker is not in its normal state.
- **Contacts 1–4 (C1, C2, C3, C4)**—Maps to the input contact alarms.

Before exiting the screen, to save your changes, select the **Apply Now** option on the bottom line of the screen.

## How to connect contacts to the PDU monitoring unit

1. Choose one or more contact number on the **User/EPO contacts** port on the user connection plate to which you will connect the contacts. The user connection plate is connected to the PDU monitoring unit.
2. From the PDU display interface:
  - a. Press the ESC or ENTER key to go to the top-level menu screen.
  - b. Select **Contacts** on the top-level menu screen, and press the ENTER key.

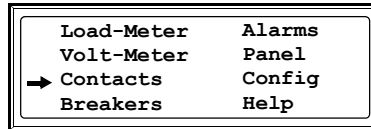

- c. Select **Contact Inputs** (or Relay Outputs) and press ENTER to display the contact inputs (or relay outputs) screen.

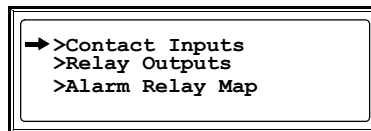

- d. Select **Contact In** and press the ENTER key to select the number of the contact you are connecting. The continue arrow ⇕ will appear next to the contact number.

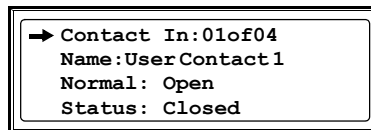

- e. Press the Up or Down arrow key to select the appropriate contact number, and press the ENTER key.
      - f. Press the Down arrow key to enter a unique **Name** for the contact and to configure the Normal state of the contact (Open or Closed). The default **Normal** state is Open. Press the ENTER key to select the item to configure.



**Note**

You will be prompted for your password to configure these items.

3. Connect contact wires (300V-rated cabling required) to the User Contacts terminal block on the user connection plate. You will need a 2.5-mm standard screwdriver.
4. Run the wires from the terminal block out the roof or under the floor of the PDU to your contact's location.



**Warning**

**Ensure that wires are properly retained and away from high voltage lines and breakers.**

# Breakers Screen

---

Use the Breakers screen to view the status of the system and PDU circuit breakers.

<b>UPS &amp; System Bypass</b>	Reports the operation mode of the UPS and the state of the Q1, Q2, and Q3 circuit breakers on the PDU.
<b>Main Input</b>	Reports status of PDU Main Input Circuit Breaker ( <b>Open</b> or <b>Closed</b> ). Under normal operation, this circuit breaker is <b>Closed</b> .
<b>Bypass Input</b>	Reports status of the PDU Bypass Input switch ( <b>Open</b> or <b>Closed</b> ). Under normal operation, this circuit breaker is <b>Closed</b> .
<b>Cross Tie</b>	Reports status of the Cross Tie Output circuit breaker ( <b>Open</b> or <b>Closed</b> ). Under normal operation, this circuit breaker is <b>Closed</b> .

# Alarms Screen

---

## View Active Alarms

Use this option of the **Alarms** screen to display active alarms (alarms that have not been resolved). Scroll through the list to view each active alarm.

## Alarm/Event Log

Use this selection of the **Alarms** screen to access the following options:

- |                         |   |
|-------------------------|---|
| <b>New Logged Items</b> | <p>Display a description and the date and time of each alarm that occurred since the last time this option was used. The date/time format is <i>mm/dd/yyyy hh:mm:ss</i>.</p> <ul style="list-style-type: none"><li>• The most recent alarm is displayed initially.</li><li>• If the log contains no alarms, the screen displays Alarm Log Empty.</li></ul>  |
| <b>Entire Log</b>       | <p>Display a description and the date and time of each alarm in the alarm log. The date/time format is <i>mm/dd/yyyy hh:mm:ss</i>.</p> <ul style="list-style-type: none"><li>• The most recent alarm is displayed initially. To move to the previous alarm press the Down arrow key. To move to the next more recent alarm, press the Up arrow key.</li><li>• If the log contains no alarms, the screen displays Alarm Log Empty.</li></ul> |
| <b>Clear Log</b>        | <p>Delete the contents of the alarm log. You will be asked to confirm this deletion.</p>  |

## Alarm Setup

Use this option of the **Alarms** screen to access the following options:

- |                            |  |
|----------------------------|--|
| <b>Loading Limits</b>      | <p>Configure the following in amps and as a percentage of full load:</p> <ul style="list-style-type: none"> <li>• <b>Out High:</b> The upper limit for output current</li> <li>• <b>Out Low:</b> The lower limit for output current</li> <li>• <b>Out Neut:</b> The upper limit for current on the neutral wire for the output phases</li> </ul>   |
| <b>Voltage Limits</b>      | <p>Configure the following as a percentage under or over the rated voltage:</p> <ul style="list-style-type: none"> <li>• <b>Input:</b> The allowed range for input voltage</li> <li>• <b>Output:</b> The allowed range for output voltage</li> <li>• <b>Bypass:</b> The allowed range for bypass input voltage (only on PDUs with dual-fed input)</li> </ul>   |
| <b>Other Limits</b>        | <p>Configure these limits:</p> <ul style="list-style-type: none"> <li>• <b>Frequency:</b> The frequency variation, in hertz, that is acceptable for the output current.</li> </ul>   |
| <b>Global Alarm Config</b> | <p>Set all the loading limits or all the voltage limits simultaneously as a percentage of full load:</p> <ul style="list-style-type: none"> <li>• <b>Load Limits:</b> Set the same percentage for the upper limit for output current, the lower limit for output current, and the upper limit for current on the neutral wire for the output phases. (Use the <b>Loading Limits</b> option to set these thresholds individually).</li> <li>• <b>Volt Limits:</b> Set the same percentage for the high and low thresholds for input and output voltage. (Use the <b>Voltage Limits</b> option to set these thresholds individually).</li> </ul> <p>Select <b>Apply Now</b> and then <b>YES</b> to implement your changes.</p> |

## Alarm Beeper

Use this option of the **Alarms** screen to turn the alarm beeper ON or OFF.

## PDU Alarms

This table lists all alarms that can be generated by the InfraStruXure PDU, as displayed by the **All Possible Alarms** option, with numeric variables between the < > characters. Logged alarms will display specific numbers instead.

Alarm Condition	Explanation	Message When Condition Cleared.
Input V <Ln-N>=<Value> Voltage Under Limit	Input voltage of the phase indicated has dropped below the configured lower limit.	Input Voltage V <Ln-N> Back In Range
Input V <Ln-N>=<Value> Voltage Over Limit	Input voltage of the phase indicated exceeded the configured upper limit.	
Output V <Ln-N>=<Value> Voltage Under Limit	Phase-to-neutral output voltage for phase <L-N> dropped below the configured limit.	Output Voltage V <L-N> Back In Range
Output V <Ln-N>=<Value> Voltage Over Limit	Phase-to-neutral output voltage for phase <L-N> exceeded the configured limit.	
Output I L<n>=<Value> Current Over Limit	Current of output phase <n> exceeded the configured limit.	Output Phase <N> Current Within Limit
Output I L<n>=<Value> Current Under Limit	Current of output phase <n> dropped below the configured limit.	
Output Neut=<Value> Current Over Limit	Current on the neutral wire for the output phases exceeded the configured limit.	Output Neutral Current Within Limit
Output FDev=<Value> Freq Out of Range	Frequency of the output current is above or below the range that is configured as acceptable.	Output Frequency Back In Range
Input Transformer Temperature Too High	The temperature of the PDU transformer exceeded the normal limit, <i>if applicable</i> .	Input Transformer Temp. Back to Normal
Main Breaker Open Alarm Active	The Main input switch is Off.	Main Circuit Breaker Has Been Closed
<User Contact Name> Alarm Active	A user-configured contact connected to the PDU monitoring unit is reporting an alarm condition.	Alarm Cleared
No UPS Input Breaker Q1 Open	The Q1 circuit breaker is open, and the PDU is not receiving power from the UPS.	None
No Panel Feed Breakers Q2&Q3 Open	The Q2 & Q3 circuit breakers are open, and the PDU is not supporting connected equipment.	None
Atypical Bypass Mode Alarm Active	The system state as set by the Q1, Q2, & Q3 breakers is in a bypass mode.	None
Branch Ckt Pos: <nn> Current Over Limit	Current on one of the poles of branch circuit breaker <i>nn</i> exceeded the configured limit.	Branch Ckt Pos: <nn> Current Within Limit
Branch Ckt Pos: <nn> Current Under Limit	Current on one of the poles of branch circuit breaker <i>nn</i> dropped below the configured limit.	
Fan Rotation Failure Alarm <Active	There is a failure in one of the fans. The fan needs to be replaced.	None



# Panel Screen

---

## Branch Ckt Loading

You can display **Branch Ckt Loading** (Branch Circuit Loading) status if the option to measure current at the distribution breakers is installed.

You can view data for each individual panel position on the distribution panel. To view status of a panel position, select the range that includes the position:

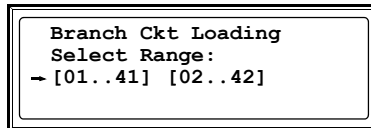

The panel position numbers on the screen correspond to the numbers on the distribution panel. (Odd numbers are on the left; even numbers are on the right.)

After you have selected the correct range, press the Up and Down arrow keys to scroll through the list of breakers in the selected range. Poles that are tied together will be shown on the same screen.

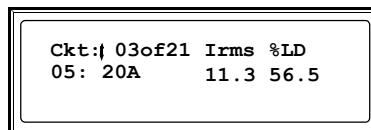

In the example above, the screen shows the third breaker of 21 breakers in the selected range. This is a single-pole breaker, occupying panel position 05. The breaker is rated at 20 amps. The following data are displayed for each pole:

- **Irms**: Measured root mean square (RMS) current of the pole position.
- **%LD**: Present load as a percentage of rated load of the panel position.

## Branch Ckt Limits

Available only if the option to measure individual currents is installed, **Branch Ckt Limits** (Branch Circuit Limits) accesses a scrollable list of the breakers in the panel. For each breaker, the screen displays, in the **Loading** column, the current on each panel position as a percentage of the rated current. In the **Load Alarm** column, you can configure the high and low thresholds for the breaker as a percentage of its rated current. For example, if you set 80% as the high threshold for a single-pole 20-amp breaker, an alarm condition occurs if the current reaches 16 amps.

## Panel Configuration

Configure the branch metering settings for each breaker on the distribution panel. The panel position numbers on the screen correspond to the numbers on the distribution panel. (Odd numbers are on the left; even numbers are on the right.) Once you have selected the correct range, configure the settings for each breaker in the range:

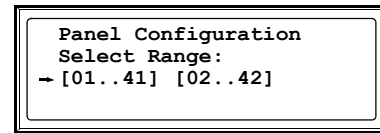

**Pos:** The panel positions in the selected range.

**Breaker:** Two configurable items:

- The breaker rating, in amps.
- The breaker tie indicator—define the number of panel positions tied (i.e., associated). You can associate positions with breakers, which enables you to view status about each breaker and receive alarm notification when any of a breaker’s poles are above or below the configured branch circuit limit. You can also tie together panel positions that are logically associated. For example, you can tie together panel positions for three separate breakers that are connected to the same PDU power cord and that feed power to the same equipment enclosure.

To configure the values on this screen:

1. From the first column, use the arrow keys to scroll up or down to the pole position you want to configure.
2. Press the ENTER key to move to the item you want to configure in the third column (the breaker rating or the breaker tie indicator).
3. Scroll again to select the value you want for the breaker rating or the breaker tie indicator. To associate one panel position with the next position in the list, choose the + character as the tie indicator immediately following the breaker rating. To indicate that the position is not tied to (associated with) the next panel position in the list, choose the ] character as the tie indicator immediately following the breaker rating. When you change the + or ] character that follows the breaker rating in one row, the + or [ character before the breaker rating in the next row also changes to indicate the changed association between the panel positions.

For example, this screen shows three, single-pole, 20A, tied breakers occupying positions 08, 10, and 12 on the top right distribution panel.

Pos	Breaker
-08	[ 20A +
10	+ 20A +
12	+ 20A ]



Circuit breakers with ratings above 60 A are considered sub-feeds. To configure a subfeed circuit breaker, select a value above 60A. The interface will display “SUB” after the rating you have selected. Only the bottom 12 positions on the distribution panel can be configured as sub-feeds.

## **Global Panel Config**

Configures the same number of poles or breaker ratings for all circuit breakers simultaneously. For example, if your system uses only 3-pole, 20-amp breakers, choose this option, scroll to the value 3 for **Poles** and 020 for **Amp Rating**, and then select **Apply Now** and **YES** to implement your changes.

# Config Screen

---

## System/Network

Use this option of the **Config** screen to access these options:

### System Password

- **Password:** Change the system password required to access protected screens and fields in the display interface. Enter a string of up to eight alphanumeric characters, followed by the underline character (   ) to indicate the end of the string. The default password is APC.
- **Time-out:** Set the time that the display interface waits for user input before it reverts to the initial scrolling of status screens. Select 1, 2, 5, 10 (the default), or 30 minutes; or 1, 2, or 4 hours, or Forever.
- **Invalidate NOW:** Re-enter the system password for viewing password-protected screens.

### Date/Time

- **Date:** Set in the following format: *dd-mmm yyyy*.
- **Time:** Set in the following format: *hh:mm:ss*.

### Local Interface

- **Contrast:** Set the screen contrast for the LCD. Select from **1** (high contrast) to **8** (low contrast).
- **Key Click:** Choose **On** for an audible click whenever you press a navigation key. Choose **Off** to disable the key click.
- **Beeper:** Select **High**, **Medium**, **Low**, or **Off** to adjust the loudness of the audible beeper and the key click.

### Network Address

The following values are set by the InfraStruXure Manager during initial configuration:

- **IP:** The System IP address, which the domain name server translates into a domain name.
- **Mask:** The subnet mask, which identifies the subnetwork on which the InfraStruXure PDU operates.
- **GW:** The Gateway address. This is the physical address of the InfraStruXure PDU, expressed as a 48-bit hexadecimal number.

## Electrical Config

This option of the **Config** screen displays information about the electrical service that provides input to the InfraStruXure PDU. All of the values displayed on this screen are set at the factory. Use this information when viewing and setting alarms.

### Input Config

Configure the following items:

- **Main Input:** The voltage from the building's electrical service coming into the PDU Main Input switch.
  - 3W: 3-phase Delta, measured line-to-line
  - 4W: 3-phase wye, measured line-to-neutral
- **Transformer:** Indicates whether the InfraStruXure PDU has a transformer.
- **Bypass Input:** Indicates whether the PDU has a Bypass Input switch (B).
- **Fuse:** Indicates whether the PDU has fuses protecting the SCRs in the UPS. The fuses are present only on dual-fed PDUs and single-fed PDUs without a transformer.

### Output Config

Configure the following items:

- **Panel Voltage:** The nominal voltage of the distribution panel supplying power to the load equipment. (This is measured line-to-neutral.)
- **Panel Breaker:** The rating, in amps, of the breaker feeding the distribution panel.
- **Load Test Port:** Indicates whether the InfraStruXure PDU has a Load Test Port.
- **Frequency:** The frequency, in hertz, of the output.
- **Cross Tie Out:** Indicates whether the PDU has a Cross Tie Output breaker.

### Other Config Items

Configure the following items:

- **Load Test Port:** Indicates whether the PDU has a load test port installed.
- **Max Power:** Maximum power of your InfraStruXure PDU (40kW or 80kW).
- **Subfeed Port:** Indicates the port at which the subfeed resides (port 3).

## Manufacturer Data

Use this option of the **Config** screen to display a scrollable list containing information about the InfraStruXure PDU. This information is useful when requesting service or product updates. The following information is displayed:

- Manufacturer Name
- Date of Manufacture
- Date of Calibration
- Hardware Revision
- Firmware Revision (for PDU monitoring and metering)
- Serial Number
- Model Number

## System ID

Use this option of the **Config** screen to identify your InfraStruXure PDU. The following fields can be configured:

- |                         |  |
|-------------------------|--|
| <b>Device Name</b>      | Set a unique name for your InfraStruXure PDU.  |
| <b>Product Location</b> | Name the physical location of the product in your data center.                             |
| <b>Product Contact</b>  | Identify the person to notify concerning questions or problems with regard to the product. |

## Factory Defaults

Use this option of the **Config** screen to reset all InfraStruXure PDU settings to their factory default values.

## Firmware Updates

Use this option of the **Config** screen to download updated firmware to the InfraStruXure PDU.

# System Operation

## How to Transfer the UPS into Maintenance Bypass Operation



Note

Select **Help** from the top-level menu screen of the PDU display interface and select the first help topic, **Putting the PDU into Maintenance Bypass**, or follow the procedure below.

When servicing the UPS, transfer the UPS into maintenance bypass operation. When the UPS is operating in maintenance bypass, input power flows directly to the PDU and out to the load equipment.

1. Command the UPS into static bypass operation through the UPS display interface:

- a. Press the ESC key at the top-level status screen to open the top-level menu.
- b. Select **Control** on the top-level menu, and press the ENTER key.

### Top-Level Menu

→ Control	Logging
Status	Display
Setup	Diags
Accessories	Help

- c. Select **UPS Into Bypass** on the **Control** menu and, press the ENTER key.

### Control Menu

→ UPS Into Bypass
Do Self Test
Simulate Power Fail
Graceful Reboot

Graceful Turn Off
Start Runtime Cal
Turn Load On

- d. Confirm the selection on the next screen: select **Yes, UPS into Bypass** and press the ENTER key.

### Confirmation Screen

Confirm
→ Yes, UPS into Bypass
No, Abort

The UPS Bypass LED illuminates and the following screens appear:

UPS has been commanded to go into Bypass...
---

UPS load is in Bypass
Press any key...



The **H3** LED above the **Q3** circuit breaker illuminates, indicating that it is safe to operate the **Q3** circuit breaker.

2. Close (turn ON) the **Q3** circuit breaker on the PDU.

If you have a dual-fed system, check to ensure that power is available before operating the **Q3** circuit breaker.

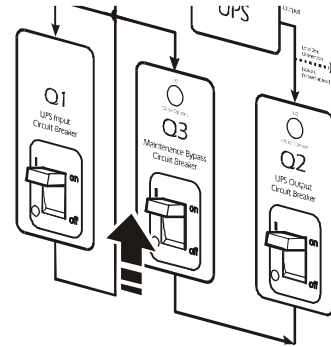

The **H2** LED above the **Q2** circuit breaker illuminates, indicating that it is safe to operate the **Q2** circuit breaker.

3. Open (turn OFF) the **Q2** circuit breaker on the PDU.

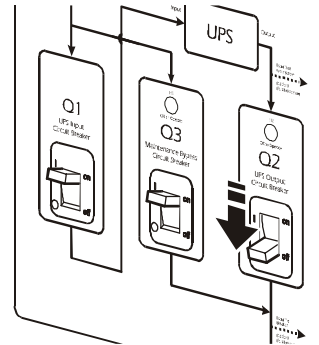

4. Open (turn OFF) the UPS **System Enable** switch.

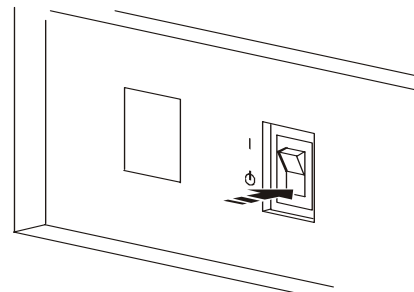



- Open (turn OFF) the XR Battery Enclosure **DC Disconnect** circuit breaker.

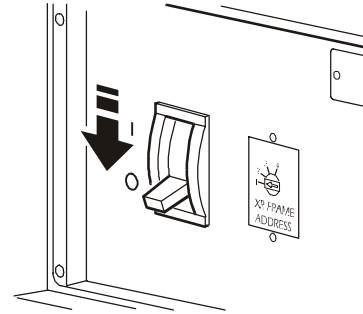

- Open (turn OFF) the **Q1** circuit breaker on the PDU.

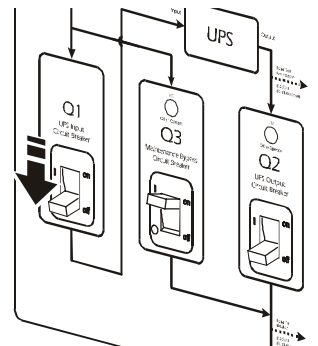

- If applicable, open (turn OFF) the PDU Q10 **Bypass Input (B)** switch.

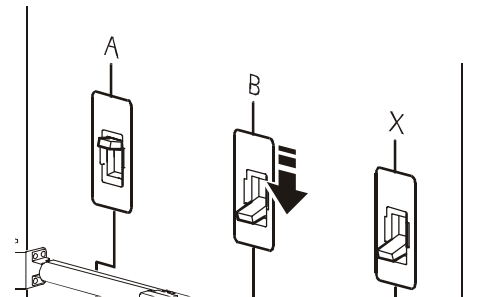

The UPS is now in maintenance bypass operation.

# How to Return from Maintenance Bypass Operation



Note

Select **Help** from the top-level menu screen on the PDU display interface and select the second help topic, **Returning from PDU Maintenance Bypass**, or follow the procedure below:

1. Close (turn ON) the **Q1** circuit breaker on the PDU.

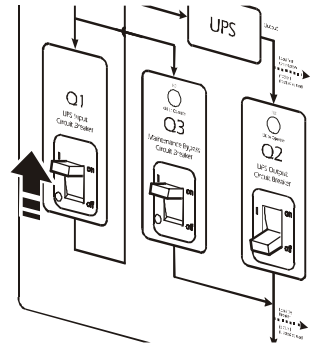

2. If applicable, close (turn ON) the PDU Q10 **Bypass Input (B)** switch.

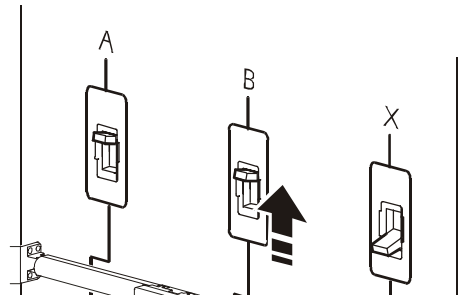

3. Close (turn ON) the XR Battery Enclosure **DC Disconnect** circuit breaker.

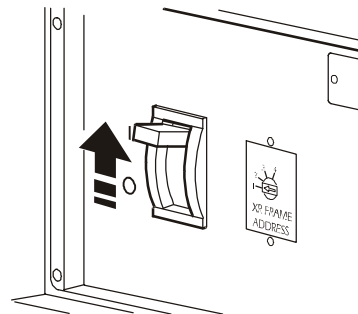

4. Close (turn ON) the UPS **System Enable** switch.

The UPS will show a **Forced Bypass** message on the display interface, and the Fault LED will be red.

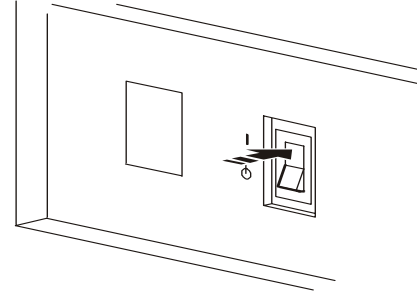

5. Command the UPS to apply power to the load:

- a. Press the ESC key at the top-level status screen to open the top-level menu and have access to eight submenus.
- b. Select **Control**, and press the ENTER key.

**Top-Level Menu**

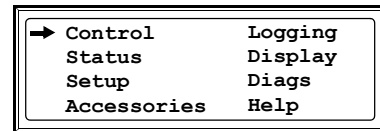

- c. Select **Turn Load On** from the **Control** menu, and press the ENTER key.

**Control Menu**

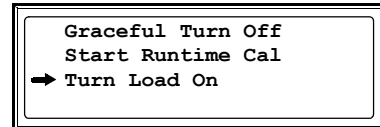
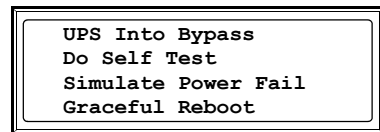

- d. On the next screen: select **Yes, UPS Load ON**, and press the ENTER key.

**Confirmation Screen**

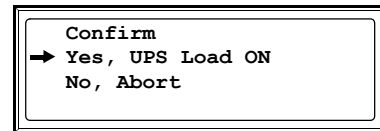

The **Load On** LED illuminates and the interface displays the following two screens:

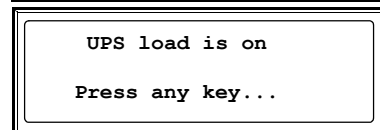
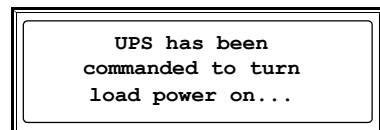

6. Command the UPS into static bypass operation through the UPS display interface:

- a. Press the ESC key at the top-level status screen to open the top-level menu.
- b. Select **Control** on the top-level menu, and press the ENTER key.

**Top-Level Menu**

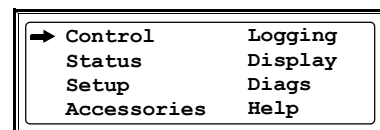

- c. Select **UPS Into Bypass** on the **Control** menu, and press the ENTER key.

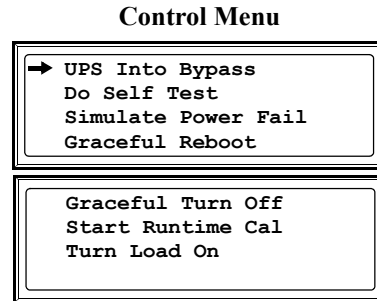

- d. Confirm the selection on the next screen: select **Yes**, **UPS into Bypass**, and press the ENTER key.

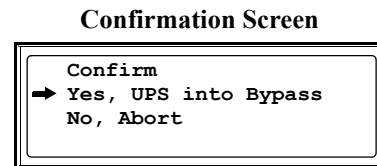

The **H2** LED above the **Q2** circuit breaker illuminates, indicating that it is safe to operate the **Q2** circuit breaker.

7. Close (turn ON) the **Q2** circuit breaker on the PDU.

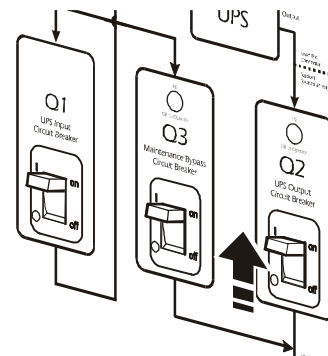

The **H3** LED above the **Q3** circuit breaker illuminates, indicating that it is safe to operate the **Q3** circuit breaker.

8. Open (turn OFF) the **Q3** circuit breaker on the PDU.

The UPS automatically comes out of Static Bypass operation.

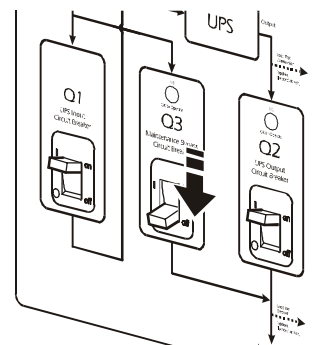

# How to Ensure Total Power Off

1. Command the UPS to turn off power to the load:

a. Press the ESC key at the top-level status screen to open the top-level menu and have access to eight submenus.

## Top-Level Menu

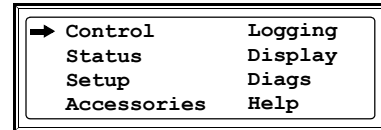

b. Select **Control**, and press the ENTER key.

## Control Menu

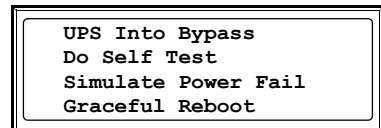

c. Select **Turn Load Off** from the **Control** menu, and press the ENTER key.

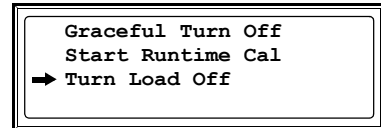

d. On the next screen: select **Yes, UPS Load OFF**, and press the ENTER key.

## Confirmation Screen

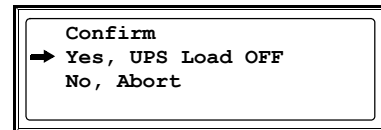

The Load On LED turns off and the interface displays the following two screens:

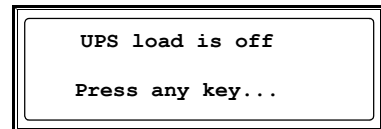
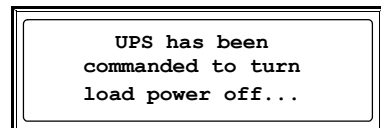

2. Set the UPS **System Enable** switch to the OFF position.

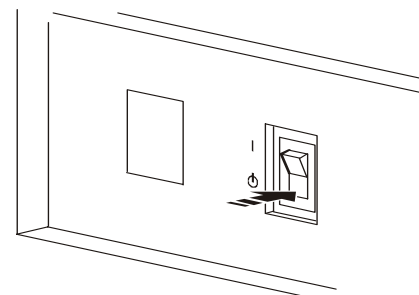

- Set the XR Battery Enclosure **DC Disconnect** circuit breaker to the OFF position.

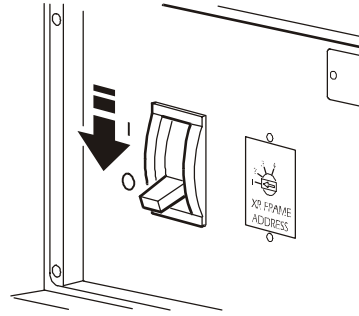

- Pull out all battery units in the XR Battery Enclosures to the red battery disconnect line.

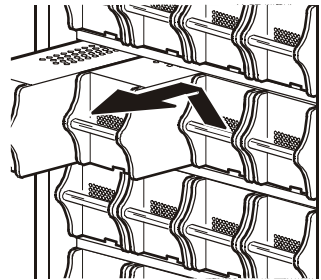

- Set the **Main Input** switch (A), and, if applicable, the Q10 **Bypass Input** switch (B), and **Cross Tie Output** or **MCCB Subfeed** circuit breaker (X) on the PDU to the OFF position.

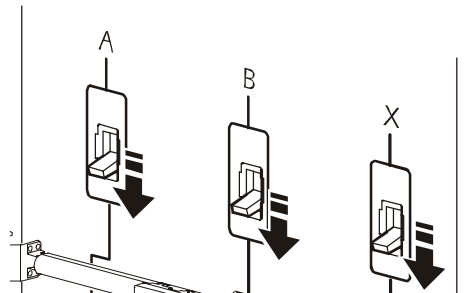

- Set the **Q1**, **Q2**, and **Q3** circuit breakers on the PDU to the OFF position.

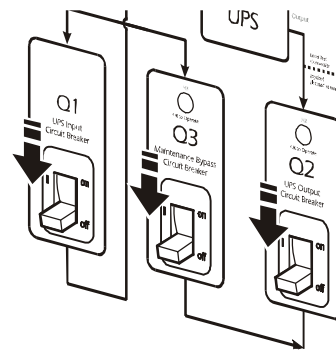

- Set the upstream main input, and, if applicable, the bypass input and utility circuit breaker to the OFF or Locked Out position.

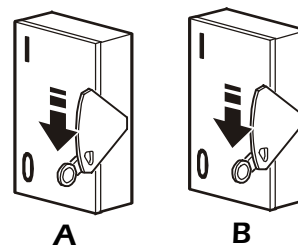

# How to Apply Power to the System

This procedure instructs on how to apply power to a system that has already been installed. For initial start-up instructions, see the *InfraStruXure 80kW Installation and Start-Up* manual.

1. Set the upstream utility, and, if applicable, the bypass input and utility circuit breaker to ON.

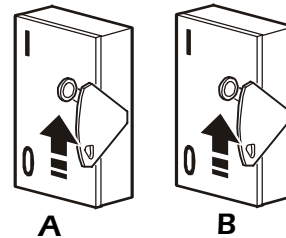

1. Set the **Main Input (A)** switch on the PDU to ON.

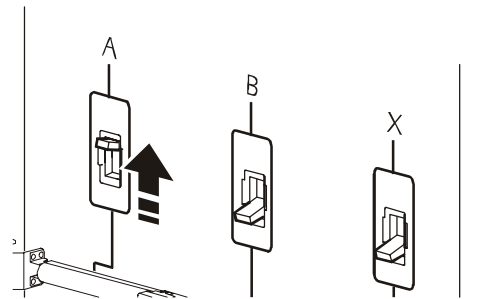

2. Set the **Q1** circuit breaker on the PDU to ON to apply power to the UPS.

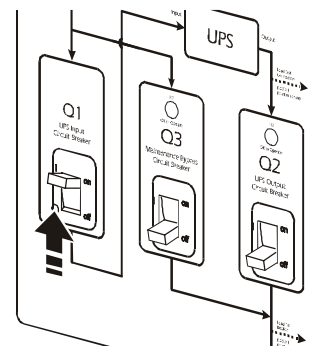

3. If applicable, set the Q10 **Bypass Input (B)** switch on the PDU to ON.

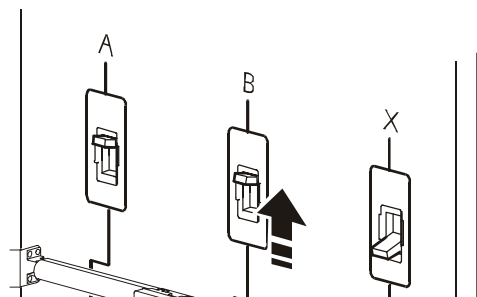

4. Ensure that all battery units are pushed all the way into the XR Battery Enclosures and locked into position.

5. Set the XR Battery Enclosure **DC Disconnect** circuit breaker to ON.

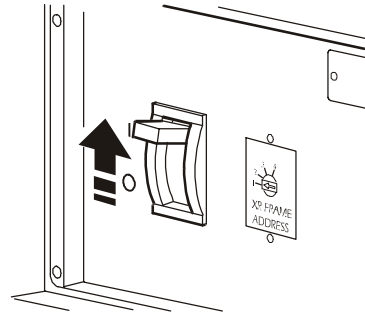

6. Set the UPS **System Enable** switch to ON

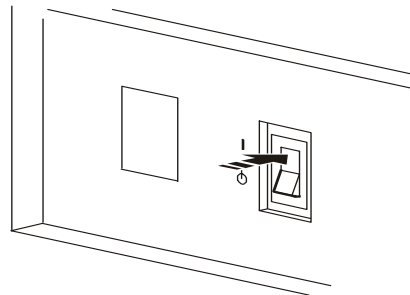

When the **System Enable** switch is placed in the ON position, the Startup screen appears on the display interface of the Symmetra PX UPS.

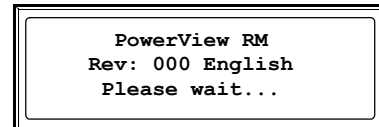

The top-level status screen appears on the display interface. This may take up to 30 seconds.

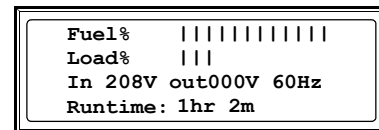



7. Read the messages displayed on the UPS display interface:

- a. Note any alarms, and verify that they are appropriate for start-up conditions.
- b. Verify that the UPS accepts the input.

**Top-Level Status Screen**

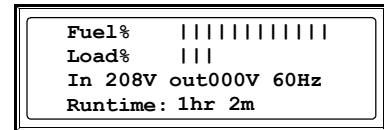

8. Command the UPS to apply power to the load:

- a. Press the ESC key at the top-level status screen to open the top-level menu and have access to eight submenus.
- b. Select **Control**, and press the ENTER key.

**Top-Level Menu**

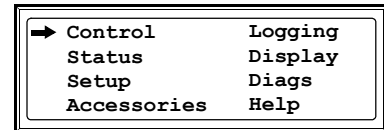

- c. Select **Turn Load On** from the **Control** menu, and press the ENTER key.

**Control Menu**

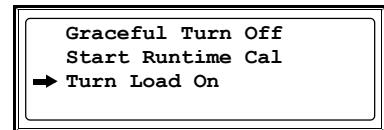
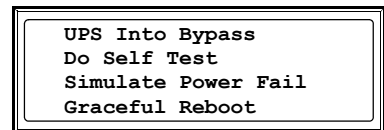

- d. On the next screen: select **Yes, UPS Load ON**, and press the ENTER key.

**Confirmation Screen**

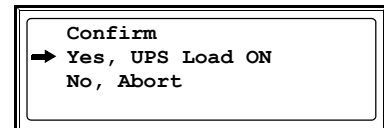

The Load On LED illuminates, and the interface displays the following two screens:

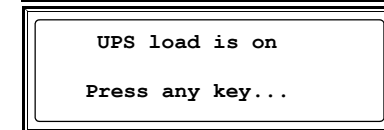
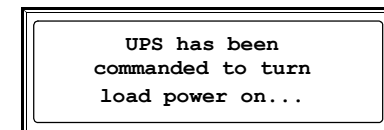

9. To apply power to the PDU distribution panel, close (turn ON) the **Q2** circuit breaker on the PDU.

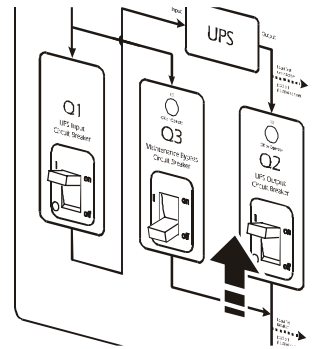

10. To apply power to the PDU power cords and connected equipment, close (turn ON) the distribution panel breakers.

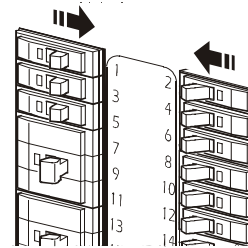

11. If applicable, close (turn ON) the **Cross Tie Output** or **MCCB Subfeed (X)** circuit breaker.

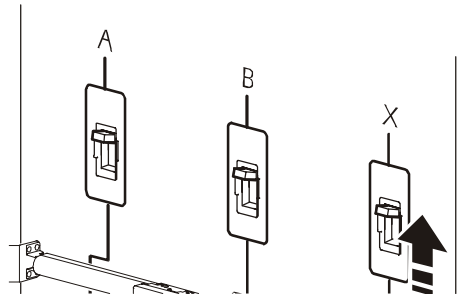

# Communication Configuration

## InfraStruXure PDU Management Options

---

### Overview

You have two management options for the InfraStruXure PDU. You can manage the InfraStruXure PDU along with the rest of your InfraStruXure equipment through the InfraStruXure Manager (APC LAN), or you can manage your InfraStruXure PDU through APC's network management interfaces (User LAN).

### InfraStruXure Manager

The InfraStruXure Manager is a rack-mount management device that coordinates the management functions of APC InfraStruXure-Certified devices installed in your data center. It provides one single interface to view and configure all APC InfraStruXure-Certified devices. See “Configuring the InfraStruXure Manager” on page 44 for configuration instructions.



See also

For more information about the InfraStruXure Manager, see the *Installation and Configuration* manual included with the InfraStruXure Manager.

### Network management interfaces

The control console and Web interfaces provide menus with options that allow you to manage the UPS. See “Configuring the Network Management Interface” on page 45 for configuration instructions.



See also

For more information about the internal user interfaces, see the InfraStruXure PDU online *Network Management User's Guide*.

The SNMP interface allows you to use an SNMP browser with the PowerNet<sup>®</sup> Management Information Base (MIB) to manage the UPS. See “Configuring the Network Management Interface” on page 45 for configuration instructions.



See also

To use the PowerNet MIB with an SNMP browser, see the *PowerNet<sup>®</sup> SNMP Management Information Base (MIB) Reference Guide*, which is provided on the InfraStruXure PDU *Utility CD*.

# Configuring the InfraStruXure Manager

---

## Connect the InfraStruXure PDU to the InfraStruXure Manager

1. Connect a Cat-5 network cable to the surge-protected ethernet port on the PDU user connection plate.

You can make connections from inside the enclosure, or you can remove the user connection plate and make your connections.

Remove the plate using a Phillips or standard screwdriver to loosen the two captive screws. Use the knockout in the plate to route cables to and from the user connections on the plate. If you remove the plate, make sure that you do not disturb the existing connections.

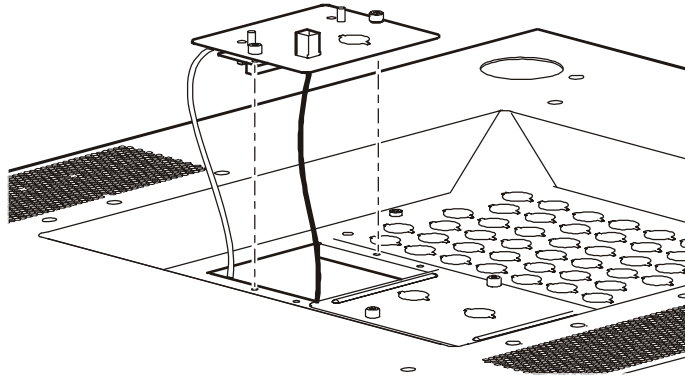

2. Run the connected Cat-5 network cable through the knockout in the user connection plate to the InfraStruXure Manager Hub.
3. Once all APC InfraStruXure-Certified equipment is installed, the network cables are connected to the InfraStruXure Manager Hub, and start-up of the system is complete, configure the InfraStruXure Manager.



See also

For detailed configuration instructions, see the *InfraStruXure Manager Installation and Quick-Start* manual included with your InfraStruXure Manager.

# Configuring the Network Management Interface

---

## Connect the InfraStruXure PDU to your network

1. Connect a Cat-5 network cable to the surge-protected ethernet port on the PDU user connection plate.

You can make connections from inside the enclosure, or you can remove the user connection plate and make your connections.

Remove the plate using a Phillips or standard screwdriver to loosen the two captive screws. Use the knockout in the plate to route cables to and from the user connections on the plate. If you

remove the plate, make sure that you do not disturb the existing connections.

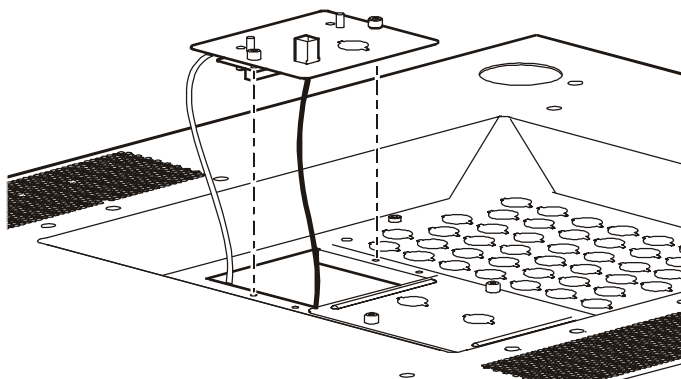

2. Run the connected Cat-5 network cable through the knockout in the user connection plate to your network connection.
3. Configure the TCP/IP settings of the InfraStruXure PDU. See “Configuration Overview” on this page for further instructions.

## Configuration Overview

You must configure the following TCP/IP settings before the InfraStruXure PDU can operate on a network:

- IP address of the InfraStruXure PDU
- Subnet mask
- Default gateway



**Note**

If a default gateway is unavailable, use the IP address of a computer that is located on the same subnet as the InfraStruXure PDU and that is usually running. The InfraStruXure PDU uses the default gateway to test the network when traffic is very light. See “Watchdog Features” in the “Introduction” of the InfraStruXure Power Distribution Unit’s online *Network Management User’s Guide* for more information about the watchdog role of the default gateway.

## TCP/IP configuration methods

Use one of the following methods to define the TCP/IP settings needed by the InfraStruXure PDU:

- Device IP Configuration Wizard (See “Device IP Configuration Wizard” on this page.)
- BOOTP or DHCP server (See “BOOTP & DHCP configuration” on page 47.)
- Local computer (See “Local access to the control console” on page 49.)
- Networked computer (See “Remote access to the control console” on page 49.)

## Device IP Configuration Wizard

You can use the Device IP Configuration Wizard on a Windows NT<sup>®</sup> 4.0, Windows 2000, or Windows XP computer to discover unconfigured InfraStruXure PDUs and configure their basic TCP/IP settings.



See also

To configure one or more InfraStruXure PDUs by exporting configuration settings from a configured PDU, see “How to Export Configuration Settings” in the online *Network Management User’s Guide* on the *Utility CD*.

1. Insert the InfraStruXure PDU *Utility CD* into a computer on your network.
2. Launch the Wizard, when prompted, or, if prompted to restart the computer, access the Wizard from the **Start** menu after the computer has restarted.
3. Wait for the Wizard to discover the first unconfigured InfraStruXure PDU, then follow the on-screen instructions.



Note

If you leave the **Start a Web browser when finished** option enabled, you can use **apc** for both the **User Name** and **Password** to access the InfraStruXure PDU through your browser.

## BOOTP & DHCP configuration

The **Boot Mode** Setting, a TCP/IP option in the InfraStruXure PDU's **Network** menu, identifies how the TCP/IP settings will be defined. The possible settings are **Manual**, **DHCP only**, **BOOTP only**, and **DHCP & BOOTP** (the default setting).



**Note**

The **DHCP & BOOTP** setting assumes that a properly configured DHCP or BOOTP server is available to provide TCP/IP settings to InfraStruXure PDUs. If these servers are unavailable, see “Device IP Configuration Wizard” on page 46, “Local access to the control console” on page 49, or “Remote access to the control console” on page 49 to configure the needed TCP/IP settings.

With **Boot Mode** set to **DHCP & BOOTP**, the InfraStruXure PDU attempts to discover a properly configured server. It first searches for a BOOTP server, then a DHCP server, and repeats this pattern until it discovers a BOOTP or DHCP server.



**Note**

For more information, see “BOOTP” on this page or “DHCP” on page 48.

**BOOTP.** You can use an RFC951-compliant BOOTP server to configure the TCP/IP settings for the InfraStruXure PDU.



**Note**

The BOOTP setting assumes that a properly configured BOOTP server is available to provide TCP/IP settings to APC InfraStruXure PDUs. If a BOOTP server is unavailable, see “Device IP Configuration Wizard” on page 46, “Local access to the control console” on page 49, or “Remote access to the control console” on page 49 to configure the TCP/IP settings.

1. Make sure that the **BOOTP** setting, a **TCP/IP** option in the InfraStruXure PDU's **Network** menu, is enabled.
2. Enter the InfraStruXure PDU's MAC and IP addresses, the subnet mask and default gateway settings, and an optional Bootup file name in the BOOTPTAB file of the BOOTP server.



**See also**

For the MAC address, look on the Quality Assurance slip included with the InfraStruXure PDU.

3. When the InfraStruXure PDU reboots, the BOOTP server provides it with the TCP/IP settings.
  - If you specified a bootup file name, the InfraStruXure PDU attempts to transfer that file from the BOOTP server using TFTP or FTP. The InfraStruXure PDU assumes all settings specified in the bootup file.
  - If you did not specify a bootup file name, the InfraStruXure PDU can be configured remotely by using Telnet or by using the Web interface: **User Name** and **Password** are both **apc**, by default.



See also

To create the bootup file, see your BOOTP server documentation.

**DHCP.** You can use a RFC2131/RFC2132-compliant DHCP server to configure the TCP/IP settings for the InfraStruXure PDU.



See also

This section briefly summarizes the InfraStruXure PDU communication with a DHCP server. For more detail about how a DHCP server is used to configure the network settings for a InfraStruXure PDU, see “DHCP Configuration” in the InfraStruXure PDU’s online *Network Management User’s Guide*.

1. A InfraStruXure PDU sends out a DHCP request that uses the following to identify itself:
  - A Vendor Class Identifier (APC by default)
  - A Client Identifier (by default, the InfraStruXure PDU’s MAC address value)
  - A User Class Identifier (by default, the identification of the InfraStruXure PDU’s application firmware)
2. A properly configured DHCP server responds with a DHCP offer that includes all of the settings that the InfraStruXure PDU needs for network communication. The DHCP offer also includes the Vendor Specific Information option (DHCP option 43). By default, the InfraStruXure PDU will ignore DHCP offers that do not encapsulate the APC cookie in the Vendor Specific Information option using the following hexadecimal format:

```
Option 43 = 01 04 31 41 50 43
```

where

- the first byte (01) is the code
- the second byte (04) is the length
- the remaining bytes (31 41 50 43) are the APC cookies



See your DHCP server documentation to add code to the Vendor Specific Information option. To disable the APC cookie requirement, see “Local access to the control console” on page 49.



To change the control console’s **DHCP Cookie Is** setting, use the **Advanced** option in the TCP/IP menu. See “Remote access to the control console” on page 49.



## Local access to the control console

You can use a local computer that connects to the InfraStruXure PDU through the console port on the InfraStruXure PDU monitoring unit to access the control console.

1. Select a serial port at the local computer, and disable any service that uses that port.
2. Use the configuration cable (APC part number 940-0103) to connect the selected port to the console port on the InfraStruXure PDU monitoring unit.
3. Run a terminal program (such as HyperTerminal<sup>®</sup>) on your computer and configure the selected port for 9600 bps, 8 data bits, no parity, 1 stop bit, and no flow control, and save the changes.
4. Press ENTER to display the **User Name** prompt.
5. Use **apc** for the **User Name** and **Password**.
6. See “Control console” on page 50 to finish the configuration.

## Remote access to the control console

From any computer on the same subnet as the InfraStruXure PDU, you can use ARP and Ping to assign an IP address to an InfraStruXure PDU, and then use Telnet to access that InfraStruXure PDU's control console and configure the needed TCP/IP settings.



**Note**

After an InfraStruXure PDU has its IP address configured, you can use Telnet, without first using ARP and Ping, to access that InfraStruXure PDU.

1. Use ARP to define an IP address for the InfraStruXure PDU, and use the InfraStruXure PDU's MAC address in the ARP command. For example, to define an IP address of 156.205.14.141 for an InfraStruXure PDU that has a MAC address of 00 c0 b7 63 9f 67, use one of the following commands:

– Windows command format:

```
arp -s 156.205.14.141 00-c0-b7-63-9f-67
```

– LINUX command format:

```
arp -s 156.205.14.141 00:c0:b7:63:9f:67
```



**See also**

For the MAC address, look on the Quality Assurance slip included with the InfraStruXure PDU.

2. Use Ping with a size of 113 bytes to assign the IP address defined by the ARP command. For the IP address defined in step 1, use one of the following Ping commands:

– Windows command format:

```
ping 156.205.14.141 -l 113
```

– LINUX command format:

```
ping 156.205.14.141 -s 113
```

3. Use Telnet to access the InfraStruXure PDU at its newly assigned IP address. For example:

```
telnet 156.205.14.141
```

4. Use **apc** for both **User Name** and **Password**.
5. See “Control console” on this page to finish the configuration.

## Control console

After you log on at the control console, as described in “Local access to the control console” on page 49 or “Remote access to the control console” on page 49:

1. Choose **Network** from the **Control Console** menu.
2. Choose **TCP/IP** from the **Network** menu.
3. If you are not using a **BOOTP** or **DHCP** server to configure the **TCP/IP** settings, select the **Boot Mode** menu. Select **Manual boot mode**, and then press ESC to return to the **TCP/IP** menu. (Changes will take effect when you log out.)
4. Set the **System IP**, **Subnet Mask**, and **Default Gateway** address values.
5. Press CTRL-C to exit to the **Control Console** menu.
6. Log out (option 4 in the **Control Console** menu).



**Note**

If you disconnected a cable during the procedure described in “Local access to the control console” on page 49, reconnect that cable and restart the associated service.

# How to Access a Network Management Interface on a Configured InfraStruXure PDU

---



Note

Disregard the procedures in this section if you have the APC InfraStruXure Manager as part of your system. See the *InfraStruXure Manager's Installation and Quick-Start* manual for access information.

## Web interface

As your browser, you can use Microsoft® Internet Explorer 5.0 (and higher) or Netscape® 4.0.8 (and higher, except Netscape 6.x) to access the InfraStruXure PDU through its Web interface. Other commonly available browsers also may work but have not been fully tested by APC.

To use the Web browser to configure InfraStruXure PDU options or to view the event log, you can use either of the following:

- The HTTP protocol (enabled by default), which provides authentication by user name and password but no encryption.
- The more secure HTTPS protocol, which provides extra security through Secure Socket Layer (SSL) and encrypts user names, passwords, and data being transmitted. It also provides authentication of Network Management Cards by means of digital certificates.

To access the Web interface and configure the security of your device on the network:

1. Address the InfraStruXure PDU by its IP address or DNS name (if configured).
2. Enter the user name and password (by default, **apc** and **apc** for an Administrator, or **device** and **apc** for a Device Manager).
3. Select and configure the type of security you want. (This option is available only for Administrators.)



See also

See the chapter entitled “Security” in the InfraStruXure PDU’s online *Network Management User’s Guide* for information on choosing and setting up your network security. Use the **Web/SSL** option of the **Network** menu to enable or disable the HTTP or HTTPS protocols.

## Telnet and SSH

You can access the control console through Telnet or Secure SHell (SSH), depending on which is enabled. (An Administrator can enable these access methods through the **Telnet/SSH** option of the **Network** menu.) By default, Telnet is enabled. Enabling SSH automatically disables Telnet.

**Telnet for basic access.** Telnet provides the basic security of authentication by user name and password, but not the high-security benefits of encryption. To use Telnet to access an InfraStruXure PDU's control console from any computer on the same subnet:

1. At a command prompt, use the following command line, and press ENTER:

```
telnet address
```

As *address*, use the InfraStruXure PDU's IP address or DNS name (if configured).

2. Enter the user name and password (by default, **apc** and **apc** for an Administrator, or **device** and **apc** for a Device Manager).

**SSH for high-security access.** If you use the high security of SSL for the Web interface, use Secure SHell (SSH) for access to the control console. SSH encrypts user names, passwords, and transmitted data.

The interface, user accounts, and user access rights are the same whether you access the control console through SSH or Telnet, but to use SSH, you must first configure SSH and have an SSH client program installed on your computer.



See also

See the InfraStruXure PDU's online *Network Management User's Guide* for more information on configuring and using SSH.

## SNMP

After you add the PowerNet MIB to a standard SNMP MIB browser, you can use that browser for SNMP access to the InfraStruXure PDU. The default read community name is **public**; the default read/write community name is **private**.



Note

If you enable SSL and SSH for their high-security authentication and encryption, disable SNMP. Allowing SNMP access to the InfraStruXure PDU compromises the high security you implement by choosing SSL and SSH. To disable SNMP, you must be an Administrator; use the **SNMP** option of the **Network** menu.

## FTP and SCP

You can use FTP (enabled by default) or Secure CoPy (SCP) to transfer new firmware to the InfraStruXure PDU, or to access a copy of the InfraStruXure PDU's event logs. SCP provides the higher security of encrypted data transmission and is enabled automatically when you enable SSH.



**Note**

If you enable SSL and SSH for their high-security authentication and encryption, disable FTP. Allowing file transfer to the InfraStruXure PDU through FTP compromises the high security you implement by choosing SSL and SSH. To disable FTP, you must be an Administrator; use the **FTP Server** option of the **Network** menu.

To access the InfraStruXure PDU through FTP or SCP, the default user name and password are **apc** and **apc** for an Administrator, or **device** and **apc** for a Device Manager. In the command line, use the IP address of the unit.



**See also**

See the InfraStruXure PDU's online *Network Management User's Guide* to use FTP or SCP to retrieve log files from the InfraStruXure PDU or to transfer firmware files to the InfraStruXure PDU.

# How to Recover From a Lost Network Management Interface Password

---



Note

Disregard the procedures in this section if you have the APC InfraStruXure Manager as part of your system. See the *InfraStruXure Manager's Installation and Quick-Start* manual for information on recovering from a lost password.

1. Select a serial port at the local computer, and disable any service that uses that port.
2. Connect the serial cable (APC part number 940-0103) to the selected port on the computer and to the console port on the InfraStruXure PDU monitoring unit.
3. Run a terminal program (such as HyperTerminal<sup>®</sup>) on your computer and configure the selected port as follows:
  - 9600 bps
  - 8 data bits
  - no parity
  - 1 stop bit
  - no flow control
4. Press ENTER, repeatedly if necessary, to display the **User Name** prompt. If you are unable to display the **User Name** prompt, verify the following:
  - The serial port is not in use by another application.
  - The terminal settings are correct as specified in step 3.
  - The correct cable is being used as specified in step 2.
5. Press the **Reset** button on the InfraStruXure PDU monitoring unit. The Status LED will flash alternately orange and green. Press the **Reset** button on the InfraStruXure PDU monitoring unit a second time immediately while the LED is flashing to reset the user name and password to their defaults temporarily.
6. Press ENTER as many times as necessary to redisplay the **User Name** prompt, then use the default, **apc**, for the user name and password. (If you take longer than 30 seconds to log on after the **User Name** prompt is redisplayed, you must repeat step 5 and log on again.)
7. From the **Control Console** menu, select **System**, then **User Manager**.
8. Select **Administrator**, and change the **User Name** and **Password** settings, both of which are now defined as **apc**.
9. Press CTRL-C, log off, reconnect any serial cable you disconnected, and restart any service you disabled.

# Customizing and Updating the PDU

## Important Safety Instructions

---



APC does not recommend that you perform maintenance of the PDU while it is receiving input power. However, due to the critical nature of data center loads, this may occur. If you must perform maintenance while the PDU is receiving input power, observe the following precautions to reduce the risk of electric shock:

1. Never work alone.
2. Perform the maintenance only if you are a certified electrician who is trained in the hazards of live electrical installation.
3. Know the procedure for disconnecting electricity to the PDU and the data center in case of an emergency.
4. Wear appropriate personal protective equipment.
5. Use double-insulated tools.
6. Always follow local and site regulations when working on the PDU.

# PDU Orderable Part List

## Circuit Breakers

PD1P20ABBSD	single-pole, 20-amp breaker	PD3P20ABBSD	three-pole, 20-amp breaker
PD1P50ABBSD	single-pole, 50-amp breaker	PD3P80ABBSD	three-pole, 80-amp breaker
PD2P20ABBSD	two-pole, 20-amp breaker	PD3P100ABBSD	three-pole, 100-amp breaker
PD2P30ABBSD	two-pole, 30-amp breaker	PD3P150ABBSD	three-pole, 15-amp breaker

## Power Cables

### 20 A, 3-wire power cables

PDW5L21-20R	5-foot power cable	PDW35L21-20R	35-foot power cable
PDW7L21-20R	7-foot power cable	PDW37L21-20R	37-foot power cable
PDW9L21-20R	9-foot power cable	PDW39L21-20R	39-foot power cable
PDW11L21-20R	11-foot power cable	PDW41L21-20R	41-foot power cable
PDW13L21-20R	13-foot power cable	PDW43L21-20R	43-foot power cable
PDW15L21-20R	15-foot power cable	PDW45L21-20R	45-foot power cable
PDW17L21-20R	17-foot power cable	PDW47L21-20R	47-foot power cable
PDW19L21-20R	19-foot power cable	PDW49L21-20R	49-foot power cable
PDW21L21-20R	21-foot power cable	PDW51L21-20R	51-foot power cable
PDW23L21-20R	23-foot power cable	PDW53L21-20R	53-foot power cable
PDW25L21-20R	25-foot power cable	PDW55L21-20R	55-foot power cable
PDW27L21-20R	27-foot power cable	PDW57L21-20R	57-foot power cable
PDW29L21-20R	29-foot power cable	PDW59L21-20R	59-foot power cable
PDW31L21-20R	31-foot power cable	PDW61L21-20R	61-foot power cable
PDW33L21-20R	33-foot power cable	PDW63L21-20R	63-foot power cable



**Power Cables**

<b>30 A, 3-wire power cables</b>			
PDW7L6-30C	7-foot power cable	PDW43L6-30C	43-foot power cable
PDW9L6-30C	9-foot power cable	PDW45L6-30C	45-foot power cable
PDW11L6-30C	11-foot power cable	PDW47L6-30C	47-foot power cable
PDW13L6-30C	13-foot power cable	PDW49L6-30C	49-foot power cable
PDW15L6-30C	15-foot power cable	PDW51L6-30C	51-foot power cable
PDW17L6-30C	17-foot power cable	PDW53L6-30C	53-foot power cable
PDW19L6-30C	19-foot power cable	PDW55L6-30C	55-foot power cable
PDW21L6-30C	21-foot power cable	PDW57L6-30C	57-foot power cable
PDW23L6-30C	23-foot power cable	PDW59L6-30C	59-foot power cable
PDW25L6-30C	25-foot power cable	PDW61L6-30C	61-foot power cable
PDW27L6-30C	27-foot power cable	PDW63L6-30C	63-foot power cable
PDW29L6-30C	29-foot power cable	PDW65L6-30C	65-foot power cable
PDW31L6-30C	31-foot power cable	PDW67L6-30C	67-foot power cable
PDW33L6-30C	33-foot power cable	PDW69L6-30C	69-foot power cable
PDW35L6-30C	35-foot power cable	PDW71L6-30C	71-foot power cable
PDW37L6-30C	37-foot power cable	PDW73L-30C	73-foot power cable
PDW39L6-30C	39-foot power cable	PDW75L6-30C	75-foot power cable
PDW41L6-30C	41-foot power cable		

# How to Add Circuit Breakers and Power Cables

## Add a circuit breaker on the PDU

1. Snap and bolt the new circuit breaker into a position on the panel.
2. Remove the corresponding plastic blanking plate on the front panel of the PDU.

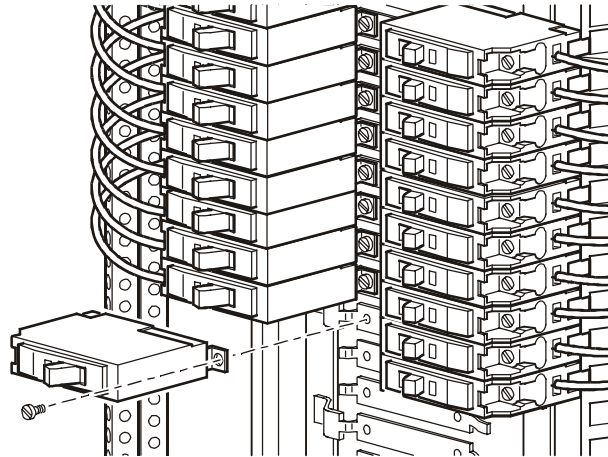

## Add a power cable to the PDU or RDP

Before adding a power cable, add a circuit breaker.

1. Install a strain-relief connector in any available knockout on the roof of the PDU.
2. Slide enough of the power cable through the strain-relief connector to reach the new circuit breaker.
3. Tighten the strain-relief connector.

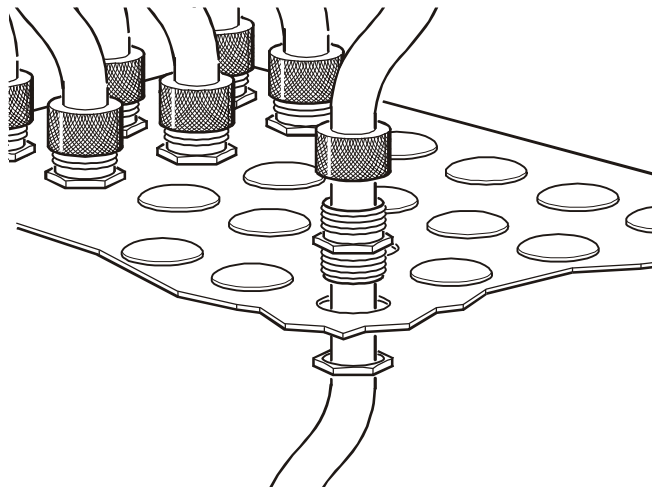

**Note**

If you are installing 20A or 30A power cables in a knockout designed for 50A power cables, you must use reducing washers (provided) to adjust the size of the knockout.

4. At the front of the PDU, connect the power cord's individual wires:
  - a. If you have branch current monitoring installed, route the phase conductor through a current sensor. If it is a three-phase cable, route the L1, L2, and L3 wires through a current sensor.
  - b. Connect the L1, L2, and L3 wires to the circuit breaker(s). The illustration below shows single pole circuit breakers; however, you can also connect three-pole breakers.
  - c. Connect the **neutral wire** to the closest open termination point on the **Neutral Bar (N)**.
  - d. Connect the **ground wire** to the closest open termination point on the **Ground Bar (G)**.

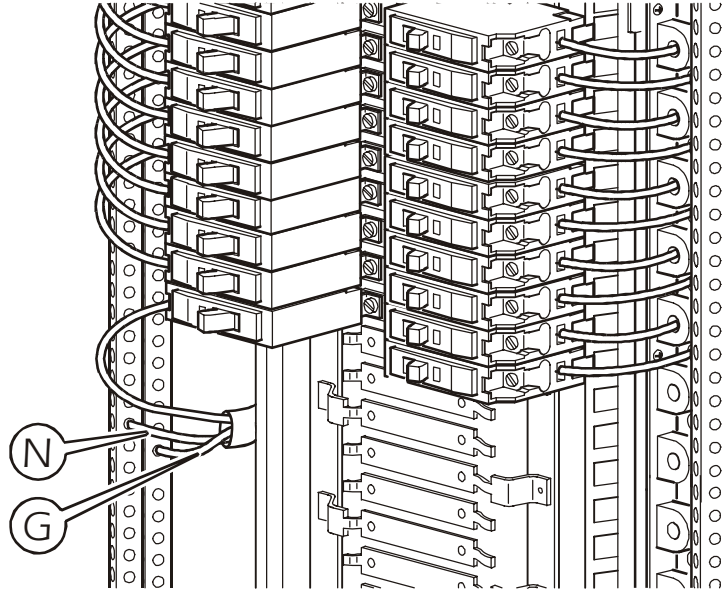

# How to Test the EPO Switch

## Overview



APC offers an optional InfraStruXure EPO System (EPW9). Contact your APC sales representative, or visit the APC Web site ([www.apc.com](http://www.apc.com)) for more information.

After a certified electrician has connected an EPO switch to the PDU monitoring unit by way of the user connection plate, you can easily test the switch to make sure it is wired and working properly. The illustration below shows the EPO functions on the PDU monitoring unit.

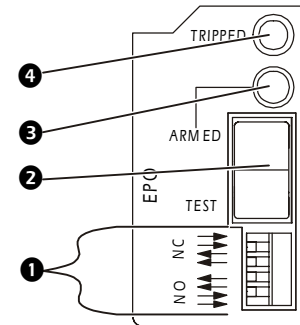

1. **EPO DIP switches** configure the EPO input for the type of EPO switch that is connected—Normally Open (NO) or Normally Closed (NC).
2. When the **EPO Arm/Test rocker** is in the **Test** position, engaging the EPO switch will not cause the load to be powered off. When the rocker is in the **Armed** position, engaging the EPO switch will cause the PDU's main input switch and the Symmetra PX UPS to be switched **OFF**.
3. The EPO **Armed LED** is green when the rocker is in the **Armed** position. The led is dark when the rocker is in the **Test** position.
4. The EPO **Tripped LED** is red when the EPO switch is engaged (the EPO button is pressed), regardless of the state of the **EPO Arm/Test rocker**.

## Testing the EPO wiring and switches

1. Place the **Arm/Test rocker** switch in the **Test** position. The EPO state LEDs will be dark and the PDU display interface will show the following alarm (in addition to any other active alarms):

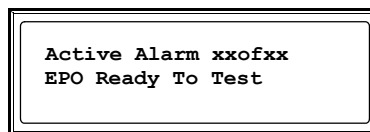

2. Engage the EPO switch. (If your switch is momentary, engage it with one person watching the EPO state LEDs, and another at the EPO switch.)
3. Observe the EPO LEDs. If the switch is wired and working properly, when the switch is engaged, both of the EPO state LEDs are red.

4. If the test was successful, place the **Arm/Test rocker** switch back to the **Arm** position. The PDU display interface will clear the EPO test mode alarm. If the test was not successful, see the troubleshooting chart:

Problem	Action
Neither state LED was red when the EPO switch was engaged	<ul style="list-style-type: none"> <li>• Check the wiring to your EPO switch</li> <li>• Check to make sure the EPO DIP switch configuration is correct for your switch (NO or NC).</li> </ul>
Only one of the state LEDs was red when the EPO switch was engaged	<ul style="list-style-type: none"> <li>• Check to make sure the EPO DIP switch configuration is correct for your switch (NO or NC) and test again.</li> <li>• If the switch is configured correctly and both LEDs are not red after testing again, contact customer support at a number on the back cover of this manual.</li> </ul>

5. Repeat this test for each EPO switch installed.
6. Ensure that the **Arm/Test** rocker switch is in the **Arm** position on the monitoring unit.

### Safety warnings

Hazardous voltage from the branch circuit must be isolated from the 24VAC, 24VDC, and contact closure. 24VAC and 24VDC are considered Class 2 circuits as defined in Article 725 of the National Electrical Code (NFPA 70) and Section 16 of the Canadian Electrical Code (C22.1).

A Class 2 circuit is a source having limited voltage and energy capacity as follows:

- a. If an Inherently Limited Power Source, voltage and energy are limited to less than 30VAC, less than 30VDC, and 8A.
- b. If not an Inherently Limited Power Source, voltage and energy are limited to less than 30VAC, less than 60VDC, 250VA, and the current is limited to 1000/Vmax. The fuse is limited to 5A if less than 20VAC or 20VDC, or 100/V maximum if less than 30VAC or 60VDC.

If you choose to use a 24VAC, 24VDC, or contact closure connection to the EPO, use one of the following UL-listed wire types:

- CL2 Class 2 cable for general purpose use
- CL2P Plenum cable for use in ducts, plenums, and other space used for environmental air
- CL2R Riser cable for use in a vertical run shaft from floor to floor
- CL2X Limited Use cable for use in dwellings and for use in a raceway
- For installation in Canada, the cable should be CSA certified, type ELC (extra-low-voltage control cable).

If you do not use a CL2 cable, route the EPO wiring in conduit that does not contain any branch circuit wiring.

# How to Connect User Input Contacts and Relay Outputs to the PDU User Connection Plate

## Overview

Make contact closure connections (NO or NC) at the user connection plate to monitor dry contacts. You can make eight connections—four input contacts and four relay outputs.

The figure at the right shows the location of the user connection plate on the roof of the PDU enclosure.

You can make connections from inside the enclosure, or you can remove the user connection plate and make your connections.

Remove the plate using a Phillips or standard screwdriver to loosen the two captive screws. Use the knockout in the plate to route cables to and from the user connection plate. If you remove the plate, make sure that you do not disturb the existing connections.

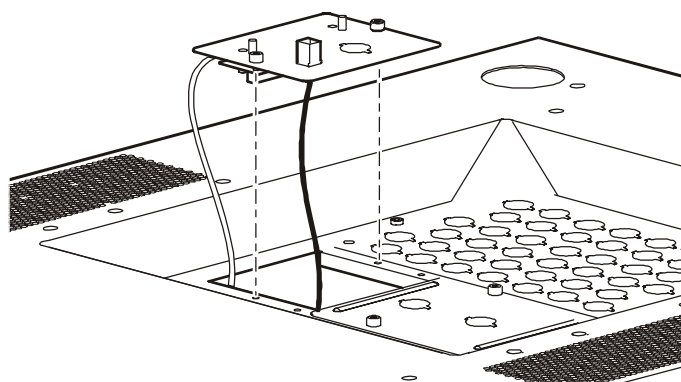
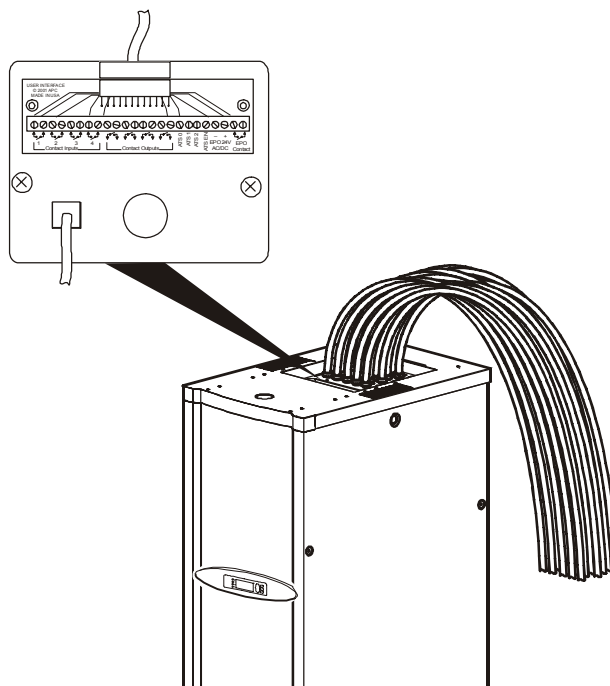

### How to connect contacts to the PDU monitoring unit.

1. Choose one or more contact numbers on the **User/EPO contacts** port on the user connection plate to which you will connect the contacts. The user connection plate connects to the PDU monitoring unit.
2. From the PDU display interface:
  - a. Press the ESC or ENTER key to go to the top-level menu screen.
  - b. Select **Contacts** on the top-level menu screen, and press the ENTER key.

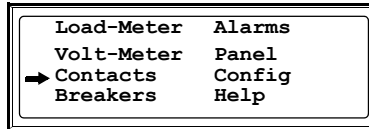

- c. Select **Contact Inputs** (or Relay Outputs) and press ENTER to display the contact inputs (or relay outputs) screen.

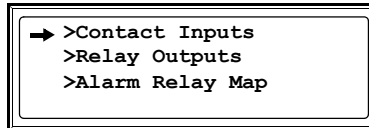

- d. Select Contact In and press the ENTER key to select the number of the contacts you are connecting. The continue arrow  $\updownarrow$  will appear next to the contact number.

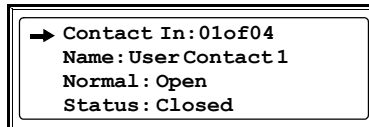

- e. Press the Up or Down arrow key to select the appropriate contact number, and press the ENTER key.
- f. Press the Down arrow key to enter a unique **Name** for the contact and to configure the Normal state of the contact (Open or Closed). The default **Normal** state is Open. Press the ENTER key to select the item to configure.



**Note**

You will be prompted for your password to configure these items.

3. Connect contact wires (300V-rated cabling required) to the User Contacts terminal block on the user connection plate. You will need a 2.5-millimeter standard screwdriver.
4. Run the wires from the user connection plate to your contact's location.



**Ensure that wires are properly retained and away from high voltage lines and breakers.**



# How to Download Firmware Upgrades

---

## Upgrading the PDU monitor processor

You can download available PDU monitor processor upgrades through the PDU display interface. The most obvious indication that a firmware upgrade is necessary occurs when the Network Management Card and the monitor processor stop communicating. This lack of communication causes the PDU's data to no longer be accessible through the display interface and a **SysData Mismatch** alarm to occur. When this alarm occurs, perform the following steps to upgrade the PDU monitor processor firmware:

1. Upgrade the PDU Network Management Card.



**See also**

For instructions on how to upgrade the PDU's Network Management Card, refer to the online *Network Management User's Guide* on the *Utility CD* provided with your InfraStruXure PDU.

2. At the PDU display interface, select **Config**, and then **Firmware Updates**. You will receive the following screen:

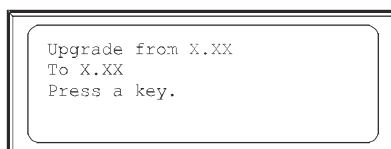

Press any key to download the upgrade.



**Note**

If you do not receive the **SysData Mismatch** alarm, but want to check for available firmware upgrades, you can do so by performing step 2 in the procedure above.

## Download g firmware upgrades from a local computer



**See also**

To download a firmware upgrade and transfer it to your PDU, see "File Transfers" in the InfraStruXure PDU's online *Network Management User's Guide* on the *Utility CD*.

1. Select a serial port at the local computer, and disable any service that uses that port.
2. Use the configuration cable to connect the selected port to the console port on the PDU monitoring unit.
3. Run a terminal program (such as HyperTerminal<sup>®</sup>) and configure the selected port for 9600 bps, 8 data bits, no parity, 1 stop bit, and no flow control. Save the changes.
4. Press ENTER twice to display the **User Name** prompt.

5. Enter your **User Name** and **Password** (both **apc**, for administrators only) and press the **ENTER** key.
6. From the **Control Console** menu, select **System**, then **Tools**, then **File Transfer**, then **XMODEM**.
7. The system will then prompt you with `Perform transfer with XMODEM -CRC? Type Yes` and press **ENTER**.
8. The system will then prompt you to choose a transfer rate and to change your terminal settings to match the transfer rate. Press **ENTER** to set the PDU to accept the download.
9. In the terminal program, send the file using XMODEM protocol. Upon completion of the transfer, the console will prompt you to restore the baud rate to normal.



Do not interrupt the download.

**Caution**

The PDU network management interface will reboot when the download is complete.

# Specifications

## 80kW InfraStruXure PDU

### Performance

Transformer Efficiency (if installed)	97%
System Full Load Output Rating	80kW
System Monitoring	
Of Current	Distribution branch monitoring (optional), subfeed
Of Voltage	AC main input, bypass input, output at distribution panels, output of fuses
Of Bypass	Bypass breaker positions, bypass lamp cue/feedback
Switches/ Breakers Status	Bypass breaker positions, input switch positions, cross tie output switch position
Transformer Temperature Sensor	180°C (triggers a warning through the PDU monitoring unit)
Branch Current Monitoring	
Parameters	Maximum current (RMS): 95 A Maximum current (peak): 135 A Maximum crest factor: 3 Minimum current: 0.5 A Measurement accuracy: $\pm 0.5$ A or 5% of reading (whichever is greater) Maximum wire size: 0.35 in (8.89mm)

Electrical	PD80F6FK1-M	PD80G6FK1-M	PD80L6FK1-M
------------	-------------	-------------	-------------

<b>Input</b>			
Nominal Voltage	208V Delta	480V Delta	600 V Delta
Nominal Bypass Voltage	208V WYE		
Nominal Current	251A	109A	87A
Max. Current	350A	150A	125A
<b>Output</b>			
Nominal Voltage	208:120V WYE		
Frequency	57–63 Hz		
Max. Continuous Nominal Current	277.5A		
Nominal Current	222A		
<b>Wiring</b>			
PDU to UPS	4W + G (AC mains input) 4W (Bypass input)		
UPS to PDU	4W	4W	4W
PDU to Distribution Panels	4W + G	4W + G	4W + G

<b>Electrical</b>	<b>PD80F6FK1-M</b>	<b>PD80G6FK1-M</b>	<b>PD80L6FK1-M</b>
Power Cables to Enclosures/ Rack PDUs	4W + G	4W + G	4W + G
Power Cable Connections	L21-20	L21-20	L21-20
Power Cable Lengths	Various	Various	Various
Power Cable Wiring (Top Exit)	Accommodates 10 + cables		
Power Cable Wiring (Bottom Exit)	Accommodates 10 + cables		
<b>Subfeed</b>			
Subfeed Wiring (3 -phase)	4W + G	4W + G	4W + G
Subfeed Connector System	100A, pin and sleeve		
Subfeed Voltage	208:120V	208:120V	208:120V
Subfeed Current	80A	80A	80A
<b>Panels</b>			
Panel Style	3-phase	3-phase	3-phase
Number of Panels (per PDU)	1 maximum	1 maximum	1 maximum
Positions per Panel	42	42	42
3-phase Breakers per Panel	10 (with 4 subfeeds)		
3-phase Subfeeds per Panel	4 maximum	4 maximum	4 maximum
1-phase Breakers per Panel	30 (with 4 subfeeds)		
Panel Rating	240V/400A per phase		
Panel Board Accessibility	Through rear of unit		

### **Relay Outputs**

Nominal Switching Capacity	1 A at 30VDC
Maximum Switching Power	30W
Maximum Switching Voltage	60VDC
Maximum Switching Current	2ADC
Maximum Carrying Current	2ADC
Surge Ratings	2kV per Bellcore TA-NWT-001089 1.5kV per FCC part 68

<b>Physical</b>	<b>PD80F6FK1-M</b>	<b>PD80G6FK1-M</b>	<b>PD80L6FK1-M</b>
<b>Dimensions (H × W × D)</b>			
PDU	81 × 29 × 36 in (2057 × 737 × 914 mm)		
AC Power Trough	7.5 × 4.0 × 29.0 in (190 × 100 × 740 mm)		
Ramp (L × W)	45 × 6 in (1143 × 150 mm)		
<b>Weight</b>			
PDU with a Transformer	2100 lb (953 kg)		
PDU without a Transformer	1284 lb (583 kg)		

<b>Physical</b>	<b>PD80F6FK1-M</b>	<b>PD80G6FK1-M</b>	<b>PD80L6FK1-M</b>
Shipping with a Transformer	2200 lb (1000 kg)		
Shipping without a Transformer	1384 lb (628 kg)		
<b>Service</b>			
Access	Front and rear		
Clearance	208 V: Greater than or equal to 36 in (914mm) 480 V: Greater than or equal to 42 in (1067mm)		
<b>Transformer (if installed)</b>			
Type	Isolation	Isolation/Step-Down	
Configuration	Delta to WYE		
Maximum Power Rating	112.5 kVA		
Maximum Current Rating	312A	135A	108A
Construction	Cu. windings, open core		
Temperature Rating	180°C (Class H)		
Maximum Temperature Rise	302°F (150°C)		
Main AC Power Feeds	Top or bottom feed, lugs sized for 600 mcm		
<b>Environmental</b>			
Operating Environment	Indoor use only; protect from water and conductive contaminants		
<b>Temperature</b>			
Operating	32 to 104° F (0 to 40°C)		
Storage	5 to 113° F (-15 to 45°C)		
<b>Humidity</b>			
Operating	0–95%, non-condensing		
Storage	0–95%, non-condensing		
Acoustic Noise Emission	Less than or equal to 50 dBA		
<b>Compliance</b>			
Approvals	UL, cUL		



# Product Information

## InfraStruXure Standard Warranty

---

APC warrants that all components of the InfraStruXure system will be free from defect in material and workmanship for a period of two years from the date of start up when start up has been performed by APC authorized service personnel\*. If assembly services are included in the original purchase and are also performed by APC authorized service personnel, APC offers an additional year of parts warranty and the first year of on site Next Business Day coverage at no additional charge. In the event that the system fails to meet the foregoing warranty, APC shall repair or replace, at its sole discretion, any such defective parts. Under this warranty, APC will ship all parts to your site at no cost to be available for you the next business day after APC is notified of this requirement. If you choose to upgrade the system to include an on site contract, APC offers modular service packages to match your needs.

Each point product incorporated into the system has a separate factory warranty that is applied when sold as a standalone unit. When incorporated into an InfraStruXure solution, the unit will be covered by the InfraStruXure warranty. In cases where one warranty favors the customer over the other, the stronger of the two warranties will take precedence. The InfraStruXure factory warranty covers only those parts appearing on the bill of materials for that solution. Megawatt UPS systems are not covered under the InfraStruXure factory warranty.

Battery functionality is typically impacted by age and environmental conditions, and therefore certain requirements must be met by the end-user. Failure to adhere to these requirements may put the battery warranty at risk. APC-supplied batteries must always be kept (whether stored or installed) in a climate-controlled environment, and should be re-charged at a minimum of every three (3) months. The battery environment must be free of excessive moisture, construction dirt, corrosive elements, or other contaminants. The temperature range must be maintained at 41 to 95° F (5 to 35° C).

\*All warranties are null and void unless startup is performed by authorized an APC Global Services service center.

APC SHALL NOT BE LIABLE UNDER THIS WARRANTY IF ITS TESTING AND EXAMINATION DISCLOSE THAT THE ALLEGED DEFECT IN THE PRODUCT DOES NOT EXIST OR WAS CAUSED BY PURCHASER'S OR ANY THIRD PERSON'S MISUSE, NEGLIGENCE, IMPROPER INSTALLATION OR TESTING, UNAUTHORIZED ATTEMPTS TO REPAIR OR MODIFY, OR ANY OTHER CAUSE BEYOND THE RANGE OF THE INTENDED USE, OR BY ACCIDENT, FIRE, LIGHTNING OR OTHER HAZARD.

THERE ARE NO WARRANTIES, EXPRESS OR IMPLIED, BY OPERATION OF LAW OR OTHERWISE, OF PRODUCTS SOLD, SERVICED OR FURNISHED UNDER THIS AGREEMENT OR IN CONNECTION HEREWITH. APC DISCLAIMS ALL IMPLIED WARRANTIES OF MERCHANTABILITY, SATISFACTION AND FITNESS FOR A PARTICULAR PURPOSE. APC'S EXPRESS WARRANTIES WILL NOT BE ENLARGED, DIMINISHED, OR AFFECTED BY AND NO OBLIGATION OR LIABILITY WILL ARISE OUT OF, APC'S RENDERING OF TECHNICAL OR OTHER ADVICE OR SERVICE IN CONNECTION WITH THE PRODUCTS. THE FOREGOING WARRANTIES AND REMEDIES ARE EXCLUSIVE AND IN LIEU OF ALL OTHER WARRANTIES AND REMEDIES. THE WARRANTIES SET FORTH ABOVE. CONSTITUTE APC'S SOLE LIABILITY AND PURCHASER' EXCLUSIVE REMEDY FOR ANY BREACH OF SUCH WARRANTIES. APC'S WARRANTIES RUN ONLY TO PURCHASER AND ARE NOT EXTENDED TO ANY THIRD PARTIES.

IN NO EVENT SHALL APC, ITS OFFICERS, DIRECTORS, AFFILIATES OR EMPLOYEES BE LIABLE FOR ANY FORM OF INDIRECT, SPECIAL, CONSEQUENTIAL OR PUNITIVE DAMAGES, ARISING OUT OF THE USE, SERVICE OR INSTALLATION, OF THE PRODUCTS, WHETHER SUCH DAMAGES ARISE IN CONTRACT OR TORT, IRRESPECTIVE OF FAULT, NEGLIGENCE OR STRICT LIABILITY OR WHETHER APC HAS BEEN ADVISED IN ADVANCE OF THE POSSIBILITY OF SUCH DAMAGES.



# Life-Support Policy

---

## APC Three-Phase Systems

As a general policy, American Power Conversion Corporation and its affiliates and subsidiaries worldwide (APC) do not recommend the use of any of its products in life support applications where failure or malfunction of the APC product can be reasonably expected to cause failure of the life support device or to significantly affect its safety or effectiveness. APC does not recommend the use of any of its products in direct patient care. APC will not knowingly sell its products for use in such applications.

Examples of devices considered to be life support devices are neonatal oxygen analysers, nerve stimulators (whether used for anesthesia, pain relief, or other purposes), autotransfusion devices, blood pumps, defibrillators, arrhythmia detectors and alarms, pacemakers, hemodialysis systems, peritoneal dialysis systems, neonatal ventilator incubators, ventilators for both adults and infants, anesthesia ventilators, infusion pumps, and any other device designated as “critical” by the U.S.F.D.A.

# How to Obtain Service

---



**Note**

If you ordered on-site service, see your entitlement certificate and terms and conditions of the service before following the procedure described below. An on-site service contract entitles you to an on-site visit by an APC technician to assess the issue, determine the problem, and replace parts, if needed. (Response time varies per contract).

## How to contact APC

Customer support for this or any other APC product is available at no charge in any of the following ways:

- Visit the APC Web site to access documents in the APC Knowledge Base and to submit any customer support requests.

- [www.apc.com](http://www.apc.com) (Corporate Headquarters)

Connect to localized APC Web sites for specific countries, each of which provides customer support information.

- [www.apc.com/support/](http://www.apc.com/support/)

Global support searching APC Knowledge Base and using e-support.

- Contact an APC Customer Support center by telephone or e-mail.

- Regional centers:

Direct InfraStruXure Customer Support Line	(1) (877) 537-0607 (toll-free)
APC Headquarters U.S., Canada	(1) (800) 800-4272
Latin America	(1) (401) 789-5735 (USA)
Europe, Middle East, Africa	(353) (91) 702000 (Ireland)
Japan	(0) 35434-2021
Australia, New Zealand, South Pacific area	(61) (2) 9955 9366 (Australia)

- Local, country-specific centers: go to [www.apc.com/support/contact](http://www.apc.com/support/contact) for contact information.

Contact the APC representative or other distributor from whom you purchased your APC product for information on how to obtain local customer support.

# Appendix

## Changes in This Manual

---

### Overview

The following list references the specific changes made to this manual since its last release (990-1468B).

### General Changes

Updated manual to reflect the InfraStruXure PDU's network management capabilities.

### Changes by page number

Page 11	Added section detailing the user connection plate.
Page 20	Updated instructions for connecting contacts to the PDU monitoring unit.
Pages 43–54	Added instructions for the PDU communication configuration.
Pages 60–61	Updated instructions for testing the Emergency Power Off switch.
Pages 63–63	Added instructions for connecting input contacts and relay outputs to the user connection plate.
Page 65	Added instructions for downloading firmware updates.
Page 68	Added relay output specifications.
Page 74	Updated instructions for obtaining service from APC.



# Index

---

## A

- Access
  - to the control console, 49
  - to the PDU through FTP, 53
  - to the PDU through SCP, 53
  - to the PDU through SNMP, 52
- Access holes, for cables, 6
- Active alarms, 22
- Add circuit breakers and power cables, how to, 58–59
- Agency approvals, 69
- Alarm beeper, 23
- Alarm LED, 13
- Alarm relay map, 19
- Alarm/event log, 22
- Alarms
  - on the PDU, 24
  - viewing active, 22
- Alarms screen, 22–24
- Arm/test rocker switch, 10

## B

- BOOTP & DHCP configuration, 47
- Branch Ckt
  - limits, 25
  - loading, 25
- Branch current monitor ports, 10
- Breakers screen, 21
- Breakers. See circuit breaker.
- Bypass input switch, 7
- Bypass LED, 13
- Bypass operation
  - how to return from, 34
  - how to transfer the UPS into, 31

## C

- Cable access holes, 6
- Cables, how to add, 58
- Check log LED, 13

- Circuit breaker
  - 42-position panel, 9
  - adding to the PDU, 58
  - cross tie output, 7
  - determining size, 2
  - for monitoring unit, 7
  - MCCB subfeed, 7
  - panel configuration, 26
  - viewing status of a, 21
- Communication configuration, 43
- Companion manuals, i
- Compliance, 69
- Components, InfraStruXure PDU, 5
- Config screen, 28–30
- Configuration
  - alarm limits, 23
  - BOOTP, 47
  - BOOTP & DHCP, 47
  - circuit breaker panel, 26
  - date/time, 28
  - DHCP, 47–48
  - electrical, 29
  - global panel, 27
  - input, 29
  - load test port, 29
  - local interface, 28
  - max power, 29
  - network address, 28
  - of communication devices, 43–54
  - output, 29
  - overview, 45
  - panel, 26
  - subfeed port, 29
  - system password, 28
  - TCP/IP, 46
- Console port, on monitoring unit, 10
- Contacts screen, 18–20
- Control console, 50
  - for PDU management, 43
  - local and remote access to, 49–50

- Cross tie output circuit breaker, 7
- Cross-reference symbols used in this manual, 1
- Customizing the PDU, 55–65

## D

- Date/time configuration, 28
- Defaults, restoring factory, 30
- Device IP configuration wizard, 46
- Device name, setting the, 30
- DHCP configuration, 47–48
- Dimensions, 68
- DIP switches, EPO, 10, 60
- Display interface, 13–30
  - location, 6
  - screens, 14–30
    - alarms screen, 22–24
    - breakers screen, 21
    - config screen, 28–30
    - contacts screen, 18–20
    - load-meter screen, 16
    - panel screen, 25–27
    - password protected, 15
    - volt-meter screen, 17
- Display port, on monitoring unit, 10
- Download firmware updates, how to, 65

## E

- Electric shock warnings, 3
- Electrical
  - configuration, 29
  - specifications, 67
- Emergency Power Off
  - connection point, 11
  - safety warnings, 61
  - testing the switch, 60–61
  - warnings, 3
- EMI warnings, 4
- EPO. See Emergency Power Off.
- Ethernet port, on user connection plate, 11

## F

- Factory defaults, resetting the, 30
- Firmware updates, how to download, 65
- Front view
  - door open, 8
  - exterior, 6
  - interior, 7
- FTP access to the PDU, 53
- Fuses, 7

## G

- Global Panel Config, 27
- Ground bar, location of, 59
- Ground lugs, 7
- Ground wire, location of, 59

## I

- InfraStruXure Manager
  - as a PDU management option, 43
  - configuration, 44
  - connect the InfraStruXure PDU to the, 44
- InfraStruXure Standard Warranty, 71
- Input cables, for UPS, 8
- Input contacts
  - connecting, 63–64
  - connection location, 11
  - information about, 18
- Input power, maintenance performed while the PDU is receiving, 2
- Input transformer, 9
- Installation warnings, 2

## K

- Keys, for navigation, 13

## L

- LCD, 13
- LEDs
  - EPO specific, 60
  - on display interface, 13
  - on monitoring unit, 10
- Leveling feet, 6
- Life-support policy, 73
- Load meter screen, 16
- Load on LED, 13

- Load test ports, 9
- Local access to the control console, 49
- Lock-out bracket, 6

## M

- Main input switch, 7
- Maintenance bypass operation
  - returning from, 34–36
  - UPS, transferring into, 31–33
- Maintenance bypass panel, 8
- Maintenance performed while the PDU is receiving input power, 2
- Maintenance warnings, 2
- Management options, 43–54
  - InfraStruXure Manager, 43
  - Network management interfaces, 43
- Manufacturer data, 30
- MCCB subfeed circuit breaker, 7
- Monitoring unit
  - circuit breakers, 7
  - connecting contacts to, 20, 64
  - detailed description, 10
  - location, 9

## N

- Navigation
  - keys, 13
  - through screens, 14
- NetShelter VX enclosure, 5
- Network address configuration, 28
- Network management interface
  - accessing on a configured PDU, 51
  - configuration, 45–54
  - recovering from a lost password, 54
- Network port, on monitoring unit, 10
- Neutral bar, location of, 59
- Neutral wire, location of, 59

## O

- Operation, 31–42
  - maintenance bypass, returning from, 34–36
  - maintenance bypass, transferring the UPS into, 31–33

- system, applying power to, 39–42
- total power off, ensuring, 37–38
- Orderable part list, 56
- Output cables, for UPS, 8

## P

- Panel Configuration, 26
- Panel screen, 25–27
- Part List, 56
- Password
  - configure, 28
  - protected-screens, 15
  - recovering from a lost, 54
- Performance specifications, 67
- Ports
  - branch current monitor, 10
  - load test, 9
- Power cables
  - adding to the PDU, 58–59
  - bottom-feed access, 7–8
  - location, 6
  - sub-feed, 6
  - UPS input and output, 8

## R

- Rack distribution panel, 5
- Rear view, interior, 9
- Relay outputs
  - connecting, 63–64
  - connection location, 11
  - information about, 18
  - specifications, 68
- Remote access to the control console, 49
- Reset button, on monitoring unit, 10
- Rocker switch, arm/test, 60

## S

- Safety, 1–4
  - symbols used in this manual, 1
  - warnings, 2–4
- SCP access to the PDU, 53
- Screens. See display interface or individual screen name.
- Service, obtaining, 74
- Shielding troughs, 6
- SNMP access to the PDU, 52

- Specifications, 67–69
  - electrical, 67
  - performance, 67
  - voltage, 67
  - wiring, 68
- SSH, for accessing a network management interface, 52
- Switches
  - arm/test rocker, 10
  - bypass input, 7
  - EPO DIP, 10
  - main input, 7
- System ID, 30
- Warranty, 71–72
- Web interface, 51
  - accessing a Network management interface through, 51
  - for PDU management, 43
- Wiring specifications, 68
- Wraparound maintenance bypass panel, 8

## T

- TCP/IP configuration methods, 46
- Telnet, for accessing a network management interface, 52
- Top-level status and menu screens, 14
- Total power off procedure, 3, 37–38
- Transformer, location, 9

## U

- Updates
  - in this manual, 75
  - to firmware, 65
  - to this manual, i
- UPS
  - maintenance bypass, returning from, 34–36
  - total power off, ensuring, 37–38
  - transferring into maintenance bypass operation, 31–33
- User connection plate
  - detailed description, 11
  - how to connect input contacts and relay outputs, 63–64
  - location, 8

## V

- Viewing active alarms, 22
- Voltage specifications, 67
- Volt-meter screen, 17

## W

- Warnings, 2–4











## APC Worldwide Customer Support

Customer support for this or any other APC product is available at no charge in any of the following ways:

- Visit the APC Web site to access documents in the APC Knowledge Base and to submit customer support requests.
  - **www.apc.com** (Corporate Headquarters)  
Connect to localized APC Web sites for specific countries, each of which provides customer support information.
  - **www.apc.com/support/**  
Global support searching APC Knowledge Base and using e-support.
- Contact an APC Customer Support center by telephone or e-mail.
  - Regional centers:

Direct InfraStruXure Customer Support Line	(1)(877)537-0607 (toll free)
APC headquarters U.S., Canada	(1)(800)800-4272 (toll free)
Latin America	(1)(401)789-5735 (USA)
Europe, Middle East, Africa	(353)(91)702000 (Ireland)
Japan	(0)35434-2021
Australia, New Zealand, South Pacific area	(61)(2)99559366 (Australia)

- Local, country-specific centers: go to **www.apc.com/support/contact** for contact information.

Contact the APC representative or other distributor from whom you purchased your APC product for information on how to obtain local customer support.

Entire contents © 2005 American Power Conversion. All rights reserved. Reproduction in whole or in part without permission is prohibited. APC, the APC logo, NetShelter, InfaStruXure, and Symmetra are trademarks of American Power Conversion Corporation and may be registered in some jurisdictions. All other trademarks, product names, and corporate names are the property of their respective owners and are used for informational purposes only.



## Free Manuals Download Website

<http://myh66.com>

<http://usermanuals.us>

<http://www.somanuals.com>

<http://www.4manuals.cc>

<http://www.manual-lib.com>

<http://www.404manual.com>

<http://www.luxmanual.com>

<http://aubethermostatmanual.com>

Golf course search by state

<http://golfingnear.com>

Email search by domain

<http://emailbydomain.com>

Auto manuals search

<http://auto.somanuals.com>

TV manuals search

<http://tv.somanuals.com>