

Reference Manual

ALESIS

This page intentionally left blank



Table Of Contents

Introduction	5
Important Safety Instructions	7
Chapter 1: Connections.....	11
Chapter 2: First Session.....	13
Playing the Demos	13
Playing Programs.....	13
Finding Programs	13
Playing Split and Layered Programs (Mixes).....	14
Changing the Programs in a Mix	14
Selecting Banks	15
Using the Performance Controls	15
Transposing the Keyboard.....	15
Storing and Copying	16
Chapter 3: Overview	17
The Front Panel Controls	17
The Edit Modes.....	19
Global and Store Modes.....	20
Special Editing Features	20
Compare.....	20
Resetting Parameter Values	20
Chapter 4: Expansion Cards.....	21
PCMCIA Expansion Cards	21
Playing Card Sounds	21
Playing Card Sequences.....	21
Saving a Bank to an SRAM Card (Formatting)	22
Saving a Program or Mix to an SRAM Card.....	22
Loading Banks from a Card.....	22
Loading a Program or Mix from a Card.....	23
Transferring Mix Banks	23
Chapter 5: MIDI	25
MIDI Connections.....	25
Using Your QS With a MIDI Sequencer.....	27
Changing the MIDI Channel.....	27
Saving Programs and Mixes Via MIDI.....	27
Chapter 6: Global Parameters.....	29
Setting the Master Pitch.....	29
Fine Tuning	29
Picking the Keyboard Velocity Curve	29
Setting the Keyboard Velocity Scaling	30
Transposing the Keyboard.....	30
Setting the Keyboard MIDI Mode	30
Turning on General MIDI.....	31
Setting the A-D Controller MIDI Numbers.....	31
Setting the Pedal 1 MIDI Controller Number.....	31
Setting the Pedal 2 MIDI Controller Number.....	31
Selecting the MIDI Program Change Behavior	31

Table Of Contents

Setting the Behavior of the MIDI Out Port.....	32
Resetting the A-D Controllers.....	32
Setting the A-D Controller MIDI Mode	32
Chapter 7: Editing Programs.....	33
QS Composite Synthesis™.....	33
Selecting a Sound to Edit [00-30 SOUND]	35
The Voice Function [40 VOICE]	36
The Level Function [50 LEVEL]	38
The Pitch Function [60 PITCH].....	39
The Filter Function [70 FILTER].....	41
The Amp/Range Function [80 AMP/RANGE]	43
The Pitch Envelope Function [90 PITCH ENVELOPE]	44
The Filter Envelope Function [100 FILTER ENVELOPE]	44
The Amplitude Envelope Function [110 AMP ENVELOPE]	45
Naming the Program [120 NAME].....	47
Copying Sound Layers [STORE].....	48
Auditioning Programs Before Storing	48
Chapter 8: Modulations.....	49
Selecting a Mod Route [0-5 MOD]	50
The Pitch LFO Function [6 PITCH LFO].....	52
The Filter LFO Function [7 FILTER LFO].....	52
The Amplitude LFO Function [8 AMP LFO]	52
Scaling Modulation Sources [9 TRACK GEN].....	54
Chapter 9: Editing Drum Kits	57
Selecting a Drum to Edit [0-9 DRUM].....	57
Selecting the Drum Sample [40 VOICE]	57
The Level Function [50 LEVEL]	59
The Pitch Function [60 PITCH].....	60
Setting the Velocity Filter Curve [70 FILTER].....	60
The Amp/Range Function [80 AMP/RANGE]	60
The Amp/Env Function [AMP ENV 110]	61
Chapter 10: Editing Mixes	63
Changing the Programs Within a Mix.....	63
Getting Into Mix Edit Mode	63
The Level Function [60 LEVEL]	64
The Pitch Function [70 PITCH].....	65
The Effect Function [80 EFFECT]	65
The Keyboard/MIDI Function [90 KEYBOARD/MIDI].....	66
The Controller Function [100 CONTROLLERS]	67
The Range Function [110 RANGE]	67
Naming the Mix [120 NAME].....	68
The Mix Edit Buffers.....	68
Chapter 11: Editing Effects.....	69
Setting the Send Levels.....	69
Getting Into Effects Edit Mode	69
Storing Effects Settings	70
Copying Effects	70
The Configuration Function [40 CONFIGURATION].....	71
Configuration 1: 1 REVERB.....	72

Configuration 2: 2 REVERBS.....	73
Configuration 3: LEZLIE+REVERB.....	74
Configuration 4: 1 REVERB+EQ.....	75
Configuration 5: OVERDRIVE+LEZLIE.....	75
Selecting a Send to Edit [00-30 SEND].....	76
The EQ Function [50 EQ].....	76
The Mod Function [60 MOD].....	77
The Lezlie Function [70 LEZLIE].....	78
The Pitch Function [80 PITCH].....	79
The Delay Function [90 DELAY].....	82
The Reverb Function [100 REVERB].....	83
The Overdrive Function [110 OVERDRIVE].....	87
Setting the Effects Output Levels [120 MIX].....	88
Appendix A: Frequently Asked Questions ...	89
How do I split the keyboard?.....	89
How do I layer two sounds on the keyboard?.....	89
What is a MIDI Sequence?.....	89
Where can I get MIDI sequences for the QS?.....	89
How do I play General MIDI sequences?.....	89
How do I load sequences into my QS?.....	89
How do I load samples into the QS?.....	90
Where can I get Q Cards?.....	90
Where can I get SRAM cards and Flash cards?.....	90
Where can I get more Banks?.....	90
Are QS6.2/QS8.2 Programs compatible with older QS programs?.....	90
How do I change what the sliders do?.....	90
Appendix B: Sound Bridge.....	91
Appendix C: MIDI Supplement.....	93
Appendix D: Troubleshooting.....	97
Recovering from a Crash.....	98
Re-Initializing.....	98
Checking the Software Version.....	98
Cleaning Your QS.....	98
Specifications.....	99
Index.....	101
Warranty/Contact Alesis.....	103

Introduction

Welcome!

Congratulations on your purchase of an Alesis QS6.2/QS8.2 64-Voice Expandable Synthesizer! It's a powerful instrument and we're sure you will find it exciting to use!

Those of you who are familiar with the enormously-popular QS-line of synthesizers may be wondering, "What has changed in the new QS6.2 and QS8.2?".

Well, we've kept the same great sound engine but totally redesigned the output section. We replaced the 18-bit D/A (digital-to-analog) converters with vastly superior Alesis 24-bit audio converters, resulting in a tremendous improvement in sound quality (much higher signal-to-noise ratio, and much lower distortion). You can hear the difference in the crystal-clear sounds. Go ahead - turn up the volume... We also refined the look of the keyboards and rearranged the front panel controls to make them more intuitive and improve ergonomics.

In addition, we improved the little, but important, things. The User Bank Programs have been completely updated. The rear-panel jacks have been moved to make the QS6.2 fit on certain kinds of stands better. We even re-wrote the manual and added a FAQ with the questions we've received the most over the years.

And don't forget, like their predecessors, the QS6.2 and QS8.2 are expandable. With an Alesis Q-Card ROM expansion, you get 8MB of additional professional-quality samples to add to your palette, in whatever genre of music you're into. Ask your music dealer about Alesis Q-Cards.

Be sure to register your QS synthesizer on the Alesis website, www.alesis.com. Here, you will find some cool items to go with your QS synthesizer, like additional sound Banks and Sound Bridge software.

We hope your investment will bring you many years of creative enjoyment and help you achieve your goals.

Sincerely,
The people of Alesis

Unpacking and Inspection

The shipping carton for your QS should contain the following items:

- QS synthesizer
- Sustain pedal
- AC power cable
- This instruction manual

Please log on to the Alesis website at www.alesis.com to register your new QS synthesizer. This will help us give you the best support we possibly can.

How to Use This Manual

We're sure you'd like to jump in and start using your QS synthesizer quickly. To help you do this, refer to Chapter 1 for hook-up instructions, then follow the "First Session" tutorial in Chapter 2. This will get you playing in no time. If you have any questions, refer to the FAQ in Chapter 12.

For more information on other features of your QS (such as how to use it with expansion cards and MIDI), refer to Chapters 3 through 6.

True synthesists who want to create their own sounds should refer to Chapters 7 through 11.

Near the end of the manual are troubleshooting tips, specifications, and an Index to help you find what you're looking for.

New terms are shown in **bold**. All buttons, knobs, and switches on the QS are referred to in bracketed capital letters that match the instrument's actual markings. Here are some examples:

[PROGRAM] refers to the button to the right of the display that says "PROGRAM" on it.

[CONTROLLER D] is the slider with "D" printed underneath.

[00] refers to one of numbered buttons to the right of the display.

[PITCH] is the control wheel at the left side of the instrument.

[SUS PEDAL] is the rear panel jack you'd plug the sustain pedal into.

Helpful tips and advice are highlighted in a shaded box like this

 *When something important appears in the manual, an exclamation mark (like the one shown at left) will appear with some explanatory text.*

Important Safety Instructions

Important Safety Instructions (English)

Safety symbols used in this product



This symbol alerts the user that there are important operating and maintenance instructions in the literature accompanying this unit.



This symbol warns the user of uninsulated voltage within the unit that can cause dangerous electric shocks.



This symbol warns the user that output connectors contain voltages that can cause dangerous electrical shock.

Please follow these precautions when using this product:



1. Read these instructions.
2. Keep these instructions.
3. Heed all warnings.
4. Follow all instructions.
5. Do not use this apparatus near water.
6. Clean only with a damp cloth. Do not spray any liquid cleaner onto the faceplate, as this may damage the front panel controls or cause a dangerous condition.
7. Install in accordance with the manufacturer's instructions.
8. Do not install near any heat sources such as radiators, heat registers, stoves, or other apparatus (including amplifiers) that produce heat.
9. Do not defeat the safety purpose of the polarized or grounding-type plug. A polarized plug has two blades with one wider than the other. A grounding-type plug has two blades and a third grounding prong. The wide blade or the third prong are provided for your safety. When the provided plug does not fit into your outlet, consult an electrician for replacement of the obsolete outlet.
10. Protect the power cord from being walked on or pinched, particularly at plugs, convenience receptacles, and the point where they exit from the apparatus.
11. Use only attachments or accessories specified by the manufacturer.
12. Use only with a cart, stand, bracket, or table designed for use with professional audio or music equipment. In any installation, make sure that injury or damage will not result from cables pulling on the apparatus and its mounting. If a cart is used, use caution when moving the cart/apparatus combination to avoid injury from tip-over.
13. Unplug this apparatus during lightning storms or when unused for long periods of time.
14. Refer all servicing to qualified service personnel. Servicing is required when the apparatus has been damaged in any way, such as when the power-supply cord or plug is damaged, liquid has been spilled or objects have fallen into the apparatus, the apparatus has been exposed to rain or moisture, does not operate normally, or has been dropped.
15. This unit produces heat when operated normally. Operate in a well-ventilated area with at least six inches of clearance from peripheral equipment.
16. This product, in combination with an amplifier and headphones or speakers, may be capable of producing sound levels that could cause permanent hearing loss. Do not operate for a long period of time at a high volume level or at a level that is uncomfortable. If you experience any hearing loss or ringing in the ears, you should consult an audiologist.
17. Do not expose the apparatus to dripping or splashing. Do not place objects filled with liquids (flower vases, soft drink cans, coffee cups) on the apparatus.
18. **WARNING:** To reduce the risk of fire or electric shock, do not expose this apparatus to rain or moisture.



Instructions de Sécurité Importantes (French)

Symboles utilisés dans ce produit



Ce symbole alerte l'utilisateur qu'il existe des instructions de fonctionnement et de maintenance dans la documentation jointe avec ce produit.



Ce symbole avertit l'utilisateur de la présence d'une tension non isolée à l'intérieur de l'appareil pouvant engendrer des chocs électriques.



Ce symbole prévient l'utilisateur de la présence de tensions sur les raccords de sorties, représentant un risque d'électrocution.

Veillez suivre ces précautions lors de l'utilisation de l'appareil:



1. Lisez ces instructions.
2. Gardez ces instructions.
3. Tenez compte de tous les avertissements.
4. Suivez toutes les instructions.
5. N'utilisez pas cet appareil à proximité de l'eau.
6. Ne nettoyez qu'avec un chiffon humide. Il est potentiellement dangereux d'utiliser des pulvérisateurs ou nettoyeurs liquides sur cet appareil.
7. Installez selon les recommandations du constructeur.
8. Ne pas installer à proximité de sources de chaleur comme radiateurs, cuisinière ou autres appareils (dont les amplificateurs) produisant de la chaleur.
9. Ne pas enlever la prise de terre du cordon secteur. Une prise murale avec terre deux broches et une troisième reliée à la terre. Cette dernière est présente pour votre sécurité. Si le cordon secteur ne rentre pas dans la prise de courant, demandez à un électricien qualifié de remplacer la prise.
10. Évitez de marcher sur le cordon secteur ou de le pincer, en particulier au niveau de la prise, et aux endroits où il sort de l'appareil.
11. N'utilisez que des accessoires spécifiés par le constructeur.
12. N'utilisez qu'avec un stand, ou table conçus pour l'utilisation d'audio professionnel ou instruments de musique. Dans toute installation, veillez de ne rien endommager à cause de câbles qui tirent sur des appareils et leur support.
13. Débranchez l'appareil lors d'un orage ou lorsqu'il n'est pas utilisé pendant longtemps.
14. Faites réparer par un personnel qualifié. Une réparation est nécessaire lorsque l'appareil a été endommagé de quelque sorte que ce soit, par exemple lorsque le cordon secteur ou la prise sont endommagés, si du liquide a coulé ou des objets se sont introduits dans l'appareil, si celui-ci a été exposé à la pluie ou à l'humidité, ne fonctionne pas normalement ou est tombé.
15. Puisque son fonctionnement normal génère de la chaleur, placez cet appareil au moins 15cm. des équipements périphériques et assurez que l'emplacement permet la circulation de l'air.
16. Ce produit, utilisé avec un amplificateur et un casque ou des enceintes, est capable de produire des niveaux sonores pouvant engendrer une perte permanente de l'ouïe. Ne l'utilisez pas pendant longtemps à un niveau sonore élevé ou à un niveau non confortable. Si vous remarquez une perte de l'ouïe ou un bourdonnement dans les oreilles, consultez un spécialiste.
17. N'exposez pas l'appareil à l'égoutture ou à l'éclaboussure. Ne placez pas les objets remplis de liquides (vases à fleur, boîtes de boisson non alcoolique, tasses de café) sur l'appareil.
18. **AVERTISSEMENT:** Pour réduire le risque du feu ou de décharge électrique, n'exposez pas cet appareil à la pluie ou à l'humidité.



Lesen Sie bitte die folgende Sicherheitshinweise (German)

Sicherheit Symbole verwendet in diesem Produkt



Dieses Symbol alarmiert den Benutzer, daß es wichtige Funktionieren und Wartung Anweisungen in der Literatur gibt, die diese Maßeinheit begleitet.



Dieses Symbol warnt den Benutzer der nicht isolierten Spannung innerhalb der Maßeinheit, die gefährliche elektrische Schläge verursachen kann.



Dieses Symbol warnt den Benutzer, dem Ausgabestecker Spannungen enthalten, die gefährlichen elektrischen Schlag verursachen können.

Folgen Sie bitte diesen Vorkehrungen, wenn dieses Produkt verwendet wird:



1. Lesen Sie die Hinweise.
2. Halten Sie sich an die Anleitung.
3. Beachten Sie alle Warnungen.
4. Beachten Sie alle Hinweise.
5. Bringen Sie das Gerät nie mit Wasser in Berührung.
6. Verwenden Sie zur Reinigung nur ein weiches Tuch. Verwenden Sie keine flüssigen Reinigungsmittel. Dies kann gefährliche Folgen haben.
7. Halten Sie sich beim Aufbau des Gerätes an die Angaben des Herstellers.
8. Stellen Sie das Gerät nicht in der Nähe von Heizkörpern, Heizungsklappen oder anderen Wärmequellen (einschließlich Verstärkern) auf.
9. Verfehlen Sie nicht den Zweck des grounding Terminals auf dem Netzstecker. Dieses Terminal wird für Ihre Sicherheit zur Verfügung gestellt.
10. Verlegen Sie das Netzkabel des Gerätes niemals so, daß man darüber stolpern kann oder daß es gequetscht wird.
11. Benutzen Sie nur das vom Hersteller empfohlene Zubehör.
12. Verwenden Sie ausschließlich Wagen, Ständer, oder Tische, die speziell für professionelle Audio- und Musikinstrumente geeignet sind. Achten Sie immer darauf, daß die jeweiligen Geräte sicher installiert sind, um Schäden und Verletzungen zu vermeiden. Wenn Sie einen Rollwagen benutzen, achten Sie darauf, das dieser nicht umkippt, um Verletzungen auszuschließen.
13. Ziehen Sie während eines Gewitters oder wenn Sie das Gerät über einen längeren Zeitraum nicht benutzen den Netzstecker aus der Steckdose.
14. Die Wartung sollte nur durch qualifiziertes Fachpersonal erfolgen. Die Wartung wird notwendig, wenn das Gerät beschädigt wurde oder aber das Stromkabel oder der Stecker, Gegenstände oder Flüssigkeit in das Gerät gelangt sind, das Gerät dem Regen oder Feuchtigkeit ausgesetzt war und deshalb nicht mehr normal arbeitet oder heruntergefallen ist.
15. Dieses Gerät produziert auch im normalen Betrieb Wärme. Achten Sie deshalb auf ausreichende Lüftung mit mindestens 15 cm Abstand von anderen Geräten.
16. Dieses Produkt kann in Verbindung mit einem Verstärker und Kopfhörern oder Lautsprechern Lautstärkepegel erzeugen, die anhaltende Gehörschäden verursachen. Betreiben Sie es nicht über längere Zeit mit hoher Lautstärke oder einem Pegel, der Ihnen unangenehm ist. Wenn Sie ein Nachlassen des Gehörs oder ein Klingeln in den Ohren feststellen, sollten Sie einen Ohrenarzt aufsuchen.
17. Setzen Sie den Apparat nicht Bratenfett oder dem Spritzen aus. Plazieren Sie die Nachrichten, die mit Flüssigkeiten (gefüllt werden Blumenvases, Getränkdosen, Kaffeetassen) nicht auf den Apparat.
18. **WARNING:** um die Gefahr des Feuers oder des elektrischen Schlages zu verringern, setzen Sie diesen Apparat nicht Regen oder Feuchtigkeit aus.



Important Safety Instructions

CE Declaration Of Conformity

See our website at:

<http://www.alesis.com>

FCC Compliance Statement

This device complies with Part 15 of the FCC rules. Operation is subject to the following two conditions: (1) This device may not cause harmful interference and (2) this device must accept any interference received, including interference that may cause undesired operation.

NOTE: This equipment has been tested and found to comply with the limits for a Class B digital device, pursuant to Part 15 of the FCC Rules. These limits are designed to provide reasonable protection against harmful interference in a residential installation. This equipment generates, uses and can radiate radio frequency energy and, if not installed and used in accordance with the instructions, may cause harmful interference to radio communications. However, there is no guarantee that interference will not occur in a particular installation. If this equipment does cause harmful interference to radio or television reception, which can be determined by turning the equipment off and on, the user is encouraged to try to correct the interference by one or more of the following measures:

- Reorient or relocate the receiving antenna.
- Increase the separation between the equipment and receiver.
- Connect the equipment into an outlet on a circuit different from that to which the receiver is connected.
- Consult the dealer or an experienced radio/TV technician for help.

Connecting AC Power

Before making any power connections, make sure the QS's power switch is turned off.

1. Plug the female end of the power cable into the QS's power socket.
2. Plug the male (plug) end into a properly grounded power outlet.

WARNING: Make sure the outlet is properly grounded. Plugging the QS into an ungrounded outlet can be hazardous.

Making Audio Connections

There are several ways to hook up your QS synthesizer audio outputs:

- **Mono.** Connect a cable from either of the QS's [MAIN] outputs to an amp or mixer input. The QS will automatically route both left and right channels to that output.
- **Stereo.** Connect two cables from the QS's [LEFT] and [RIGHT] outputs to two inputs of an amp or mixer.
- **Headphones.** Plug a set of headphones into the [HEADPHONES] jack on the rear panel.

WARNING: When connecting audio cables or turning power on and off, make sure that the amplifiers in your system are turned off or the volume controls are turned down. If you don't do this, you can create loud bursts of sound that might damage your speakers.

Connecting the Foot Pedals

The QS has two pedal jacks marked [SUS PEDAL] and [PEDAL 1]. Plug the included sustain pedal into the jack marked [SUS PEDAL].

[SUS PEDAL] is designed to work with any standard momentary footswitch. It doesn't matter whether the footswitch is normally open or closed, as long as you plug it in before powering up your QS; the instrument will calibrate itself.

[PEDAL 1] is designed to work with a Roland EV-5 pedal or equivalent.

NOTE: If your sustain pedal responds backwards (i.e., notes sustain when your foot is off the pedal), turn off your QS and make sure the footswitch plug is fully inserted into the [SUS PEDAL] jack. Then, turn the QS back on while keeping your foot off the footswitch.



Connection Diagram

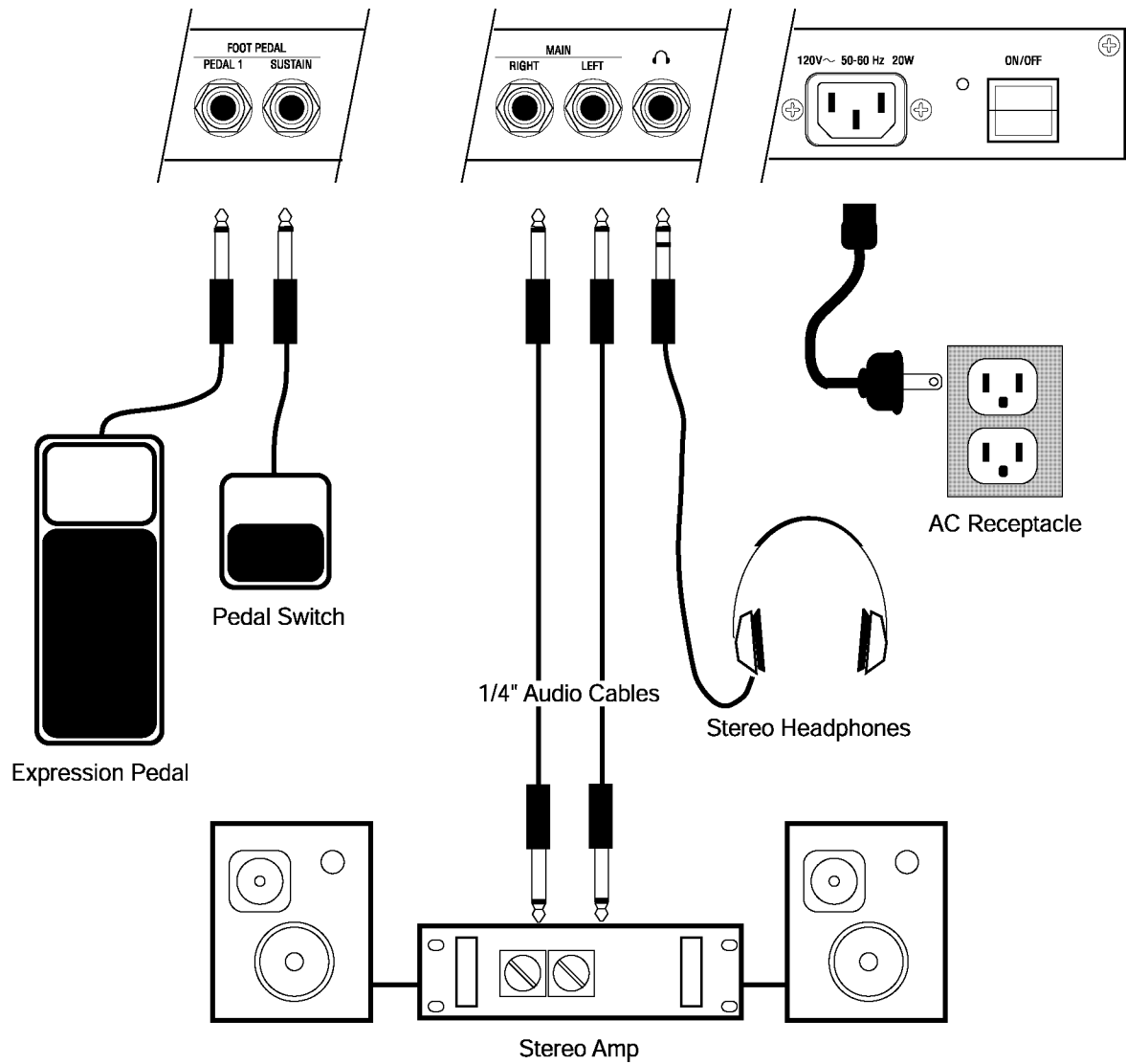

Playing the Demos

The QS has five built-in demo sequences. To play a demo, hold down [MIX] and press a number button from [0] through [4]. Playback will start with the specified demo and continue through the remaining demos.

To stop the demo, press [MIX].

Demos:

0. "Jinx" by James Reynolds
1. "Bang!" by Taiho Yamada
2. "Dreamcurrents" by Erik Norlander
3. "Iron Man" by Keith Emerson
4. "Camera Obscura" by David Bryce

Playing Programs

The sounds in your QS are called **Programs**. Programs contain all of the parameters that are needed to define a sound. For example, "True Stereo" is a grand piano Program.

To select a Program, press the [PROGRAM] button. The display should look something like this:

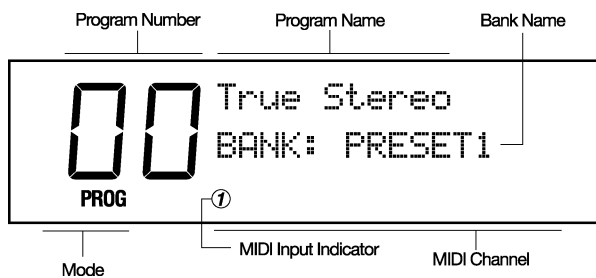

Press the [BANK] buttons to choose a Program Bank. Available choices are USER, PRESET1, PRESET2, PRESET3, and GenMIDI. More Banks are available if you have an expansion card.

To call up an individual Program, press the numbered buttons for the Program you want to recall.

For example, if you want to hear a grand piano Program, press the [BANK >] button until you are in the PRESET1 Bank, then press the [00 PIANO] button and then the [0] button. This will select Program 00, "True Stereo".

You can also use the [VALUE UP] and [VALUE DOWN] buttons step through the Programs.

Finding Programs

To make Programs easier to find, we've organized them into eleven categories marked on the "tens" buttons:

00-09 Pianos	10-19: Chromatic	20-29: Organ
30-39 Guitar	40-49 Bass	50-59: Strings
60-69: Brass	70-79 Winds	80-109 Synth
110-119: Rhythm/FX	120-127: Drums/Percussion	

For example, Programs 20 through 29 are all Organ sounds.

NOTE: The General MIDI (GenMIDI) Bank doesn't follow this convention; it is organized to match the General MIDI standard, which puts Programs in a different order.



Playing Split and Layered Programs (Mixes)

A **Mix** is a combination of up to 16 Programs, allowing you to play more than one sound at the same time. The Programs may be split or layered across the keyboard, or distributed among MIDI channels for multitimbral sequencing.

Press the [MIX] button. The display should look something like this:

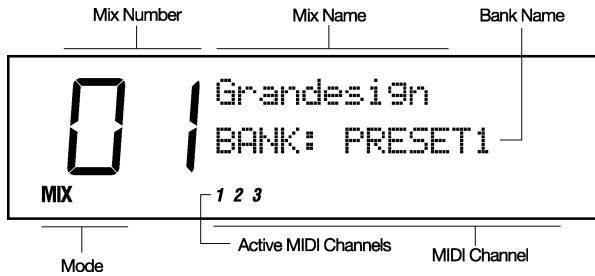

Use the [BANK], [VALUE] or the numbered buttons to call up the Mix of your choice (the same way you select Programs).

The numbers at the bottom of the display show which Mix Channels are enabled in this Mix. Each Mix Channel contains a Program.

To see what Programs the Mix uses, use the [PAGE >] button to step through the Mix Channels. The selected Mix Channel will blink at the bottom of the screen and the name of the Program on that channel will be displayed.

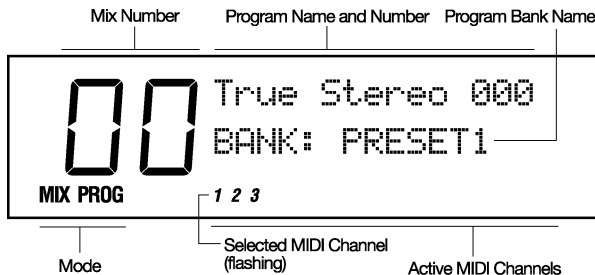

Changing the Programs in a Mix

Suppose you're playing a Mix that has two Programs split across the keyboard: a bass sound on the lower half, and a piano on the upper half. Now suppose you want to choose a different bass Program for the lower half. To do this, you need to change the Program in that Mix Channel. Here's how:

- 1) Get into Mix Mode by pressing the [MIX] button.
- 2) Press the [PAGE >] button to select the Mix Channel containing the Program you want to change. The selected Mix Channel should be flashing at the bottom of the display.
- 3) Use the [VALUE], [BANK] or numbered buttons to select a different Program.

To return to normal operation, press [MIX] or [PROGRAM].

NOTE: Your QS will let you change Programs on all 16 Mix Channels, even ones that aren't yet enabled in this Mix. You won't hear the changes you make to a channel that isn't yet enabled.

Selecting Banks

A **Bank** is a collection of 128 Programs and 100 Mixes. There are five internal Banks available in the QS, and more can be accessed if you put a card into the [PCMCIA EXPANSION CARD] slot.

The internal Banks are:

USER PRESET1 PRESET2 PRESET3 GenMIDI

To explore different Banks, use the [< BANK] and [BANK >] buttons.

NOTE: You can overwrite the Programs and Mixes in the User Bank. The other Banks are permanent.

Using the Performance Controls

The QS provides various ways to control the sound as you are playing:

- Keyboard **Velocity** lets you control the sound by how hard you hit the keys. Depending on how hard you play, the volume and tonal quality of the sound will change.
- Keyboard **Aftertouch** (QS6.2 only) lets you change the sound by pressing down hard on the keys after you've played them. While holding key down, you can press harder on it to change the character of the sound.
- The **Sustain Pedal** is used to hold notes after you let go of the keys.
- **Pedal 1** is most often used to control the volume, but it can be used to control other parameters.
- The **Pitch Bend Wheel** allows you to alter the pitch of the notes as you play.
- The **Modulation Wheel** allows you to add a modulation effect (such as vibrato or tremolo) to the sound.
- The **Controller A-D Sliders** allow you to affect various parameters of the sound. In most of the presets, slider [A] controls a filter or filter-sweep effect, [B] a delay effect, [C] an envelope time, and [D] a reverb effect. As you move the sliders, the LCD gives you visual feedback in the form of small vertical bar graphs.

NOTE: If you don't see a bar graph in the display when you move a slider, it means the slider has no function in that particular Program.

Transposing the Keyboard

- 1) Hold down the [TRANSCOPE] button.
- 2) Tap the key that represents the interval you'd like to shift by relative to Middle C. For example, if you want to shift up a semitone, tap the C-sharp key.
- 3) Let go of the [TRANSCOPE] button. An up or down arrow will appear in the [TRN] area of the LCD depending on which direction you've transposed.

When you want to return things to normal, hold down [TRANSCOPE] again and tap on Middle C (marked by a small triangle on the front panel).

TIP: Using this method, you can transpose up or down by as much as one octave. To transpose by a greater interval, use the Global transpose page.

Storing and Copying

It is easy to store and copy Programs and Mixes. To do this:

- 1) Press [STORE]. The display will look something like this:

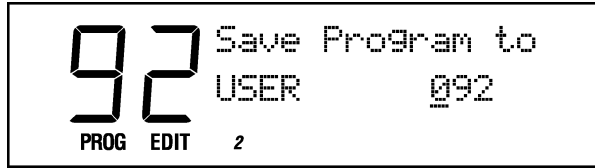

- 2) Pick a USER Bank destination using the numbered buttons, the [VALUE] buttons or the [CONTROLLER D] slider.
- 3) If you want the Program or Mix to be stored on an SRAM card in the [PCMCIA EXPANSION SLOT], use the [BANK] buttons to select a card bank.
- 4) Press [STORE] again.

TIP: The factory User Bank Mixes and Programs are available on the Alesis website.

NOTE: The PRESET and GenMIDI banks reside in ROM, so they can't be overwritten with new Programs and Mixes.

The Front Panel Controls

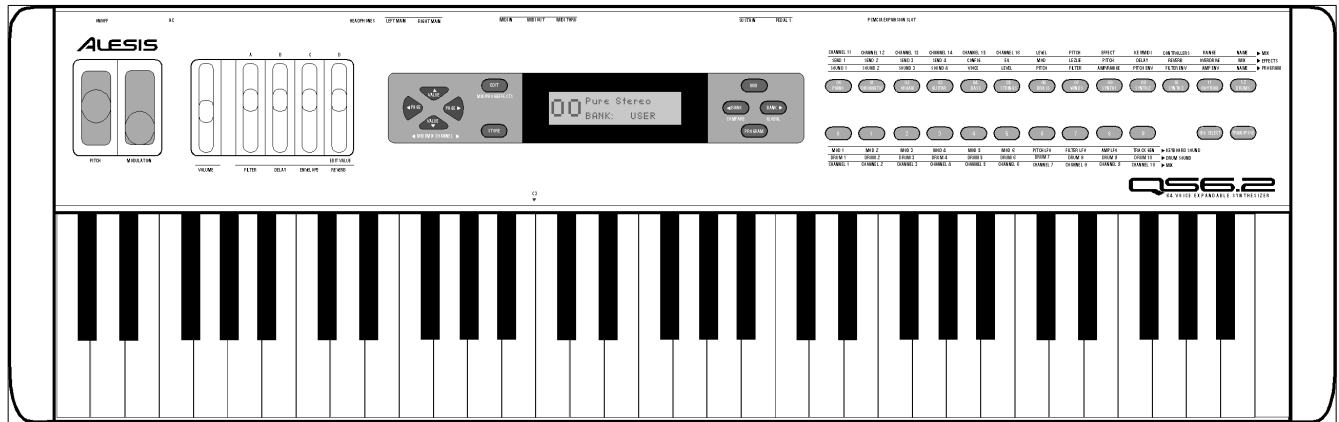

From left to right, we have:

[PITCH] Bend Wheel – for bending pitch during performance.

[MODULATION] Wheel – for adding vibrato and tremolo during performance.

[VOLUME] Slider – sets the output level.

[CONTROLLER A-D]/[EDIT VALUE] Sliders – for adjusting parameters during performance or Edit mode.

[PAGE] Buttons – sets the MIDI or Mix channel; in the Edit Modes, these are used to navigate through display pages.

[VALUE] Buttons – increase or decrease the currently selected value any Edit Mode.

[EDIT] Button – for entering one of the Edit Modes (Mix, Program, Effects).

[STORE] Button – for storing or copying to the User Bank, an expansion card, or external MIDI devices.

[<BANK]/[COMPARE] Button – selects a Bank; in an Edit Mode, compares the current version to the original version.

[BANK>]/[GLOBAL] Button – selects a Bank; in an Edit Mode, access the Global parameters.

[MIX] Button – for entering Mix Mode.

[PROGRAM] Button – for entering Program Mode.

[00]-[120] Numbered Buttons – selects Program and Mix categories; in an Edit Mode, these select Edit functions.

[0]-[9] Buttons – selects individual Programs or Mixes; in Edit Mode, these select edit functions.

[SEQ SELECT] Button – triggers a sequence stored on the Expansion Card.

[TRANPOSE] Button – transposes the keyboard. Hold this button and touch a key.



The Play Modes

We've already introduced you to these modes in the last chapter. This is where you'll normally be when you're playing your QS.

Program Mode

In this mode, you can play the QS's various Programs one at a time. You'll probably be in this mode most of the time. The QS contains 512 Preset and 128 User Programs. To get into Program Mode, press the [PROGRAM] button.

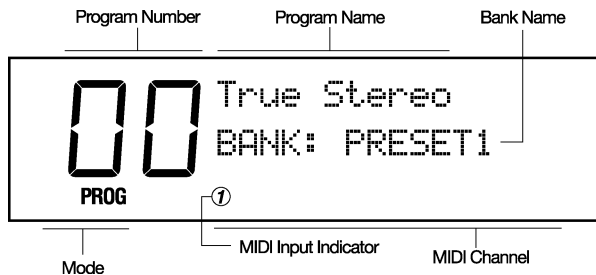

Mix Mode

In this mode, you can play up to 16 Programs at the same time. You can use this mode to create keyboard splits or keyboard layers, or for multitimbral sequencing. The QS contains 400 Preset Mixes and 100 User Mixes. To get into Mix Mode, press the [MIX] button.

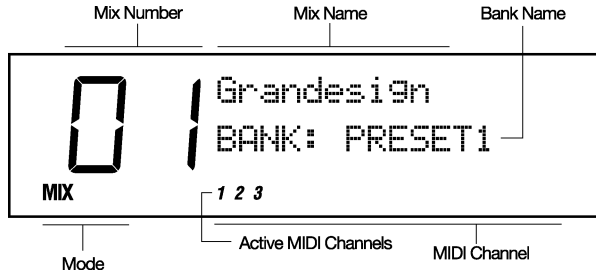

What the Other Buttons Do

When in Mix or Program Mode, the buttons have the following functions:

- The numbered buttons select different Programs and Mixes.
- The [VALUE] buttons step through the Programs and Mixes.
- The [PAGE] buttons change the MIDI channel.
- The [BANK] buttons step through the Banks.

The Edit Modes

The Edit Modes are used to change the QS's sounds and various parameters. Many people are perfectly happy using their QS without ever editing a sound. However, if you like to tweak and create your own sounds, you'll be using these modes.

Program Edit Mode

In this mode, you can change the settings that make up a Program or create an entirely new Program from scratch. To get into Program Edit Mode, press the [EDIT] button from Program Mode.

Mix Edit Mode

In this mode, you can change the settings that make up a Mix or create an entirely new Mix from scratch. To get into Mix Edit Mode, press the [EDIT] button from Mix Mode.

Effects Edit Mode

In this mode, you can change the settings of the QS's internal digital effects processor. To get into Effects Edit Mode, press the [EDIT] button twice from Program mode or three times from Mix Mode.

Navigating and Entering Data

When in one of the Edit modes, the buttons have the following functions:

- The numbered buttons select an Edit function.
- The [< PAGE] and [PAGE >] buttons cycle through the pages of the function. You can always tell what page you are on by looking at the indicator in the upper right corner of the display. (For example, "P1" for Page One).
- The [VALUE UP] and [VALUE DOWN] buttons increment or decrement parameter values.
- [CONTROLLER D] can also be used for setting parameter values.
- The [< BANK] button (Compare) lets you compare the edited sound to the original sound.
- The [BANK >] button gets you into Global Mode (see below)

Global and Store Modes

Global Mode

In this mode, you can set various aspects of the QS that don't change whenever a new Program or Mix is selected (for example, the keyboard sensitivity). Press the [EDIT] button, then the [BANK >] button (with [GLOBAL] written under it) to get into this mode.

Store Mode

This mode is for storing, copying and transmitting data. You can store or copy whole Banks, individual Mixes, individual Programs, and Effects settings, among other things. Press the [STORE] button to get into this mode.

Navigating and Entering Data

This works the same as in the Edit modes, except that the [BANK] buttons don't do anything.

Special Editing Features

Compare

In any Edit mode, the [< BANK] button performs the [COMPARE] function (see the label under the button).

If you press [COMPARE] from any Edit mode, the original Program or Mix will be temporarily recalled and "EDIT" will flash in the display. Pressing [COMPARE] again switches to your edited version.

Resetting Parameter Values

While editing, you can quickly reset parameters back to their default values by pressing both of the [VALUE] buttons at the same time. Pressing both of the [PAGE] buttons at the same time will jump to the first page.

In Program or Mix Modes, pressing the [PAGE] buttons at the same time will set the QS to MIDI channel 1. Pressing the [BANK] buttons at the same time will jump to the User Bank.

NOTE: This is also known as the "Double Button Press Trick"

PCMCIA Expansion Cards

If you want more Sounds (samples), Programs, Mixes, or Sequences, all you have to do is insert the appropriate card into the QS's [PCMCIA EXPANSION SLOT].

There are three kinds of expansion cards that you can use:

- **QCards** are a series of excellent ROM (read-only memory) cards developed by Alesis. Each contains 8MB of professional uncompressed PCM samples plus Programs and Mixes designed to take full advantage of them. The cards available are Classical, Sanctuary, Vintage Keyboards, Vintage Synthesizers, HipHop, EuroDance, Latin, Stereo Classical Piano, and Stereo Jazz Piano. You can get these at your Alesis dealer.
- **SRAM cards** provide additional storage for Programs and Mixes. A 512K SRAM card can hold eight Banks of Programs and Mixes. You can edit these as you wish. Many different SRAM cards from 256K to 8 Megabytes are supported; just make sure they are 5-volt read/write only, and have an access time of 120 nanoseconds or faster.
- **Flash cards** provide additional sample memory that you can fill with your own sounds using a computer! The QS can accommodate 2MB, 4MB, and 8MB flash cards (larger cards will work, but only the first 8MB will be utilized by the QS). Using Alesis' Sound Bridge software on your PC or Mac, you can download samples into the Flash card through MIDI. Flash cards must be Type 1 PC cards (PCMCIA), and must be AMD-C series or -D series FLASH or compatible, with an access time of 120ns or faster.

TIP: If you own a Q-Card, you can get additional sound banks to go with that Q-Card on the Alesis website.

Playing Card Sounds

To play the sounds on an expansion card, enter Mix or Program mode and use the [BANK] buttons to select the Card Bank. Up to 8 Card Banks can be recognized.

Playing Card Sequences

Several of the Alesis QCards come with their own demonstration sequences. In addition, you can store your own MIDI sequences to RAM or FLASH cards using a computer and Alesis' free Sound Bridge software.



To play back a card sequence:

- 1) Insert the card containing sequence data into the [PCMCIA EXPANSION SLOT].
- 2) Press the [SEQ SELECT] button. The display will look like this:



- 3) Use the [00] through [40] buttons to pick the tens digit of the sequence number.
- 4) Finally, use the [0] through [9] buttons to play a specific sequence.

To stop a sequence while it's playing, you can press the [SEQUENCE], [PROGRAM] or [MIX] button.

Saving a Bank to an SRAM Card (Formatting)

Before you can use a blank SRAM card for the first time, you must format it by storing the User Bank to each of its banks. Depending on the amount of SRAM a particular card has, up to 8 complete Banks can be stored onto it.

- 1) Insert an SRAM card into the [PCMCIA EXPANSION SLOT].
- 2) Press [STORE].
- 3) Press [< PAGE] three times. This selects the "SAVE TO CARD" option.
- 4) Use the [CONTROLLER D] slider or the [VALUE] buttons to select a bank location on the card to store to.
- 5) Press [STORE] to transfer the User Bank data from the QS onto the card.

Saving a Program or Mix to an SRAM Card

This is done just like storing to the User Bank, except that you use the [BANK] buttons to select a card bank.

Note that the SRAM card must be formatted first (see above).

NOTE: If the display reads "CARD IS WRITE PROTECTED." switch the write-protect switch on the card to off and repeat the procedure.

Loading Banks from a Card

The QS can access Program and Mix data directly from a card by using the [BANK] buttons. However, there may be an instance where you want to load a full bank from a card into the User Bank. Warning: this will erase the current Programs and Mixes in your User Bank.

To overwrite the User Bank with a Card bank:

- 1) Insert the card into the card slot on the back panel.
- 2) Press [STORE].
- 3) Press [< PAGE] twice. This selects the "LOAD FROM CARD" option.

- 4) Use the [CONTROLLER D] slider or the [VALUE] buttons to select the bank on the card you wish to load (A1–A4, etc.).
- 5) Press [STORE] to transfer the data from the card into the QS.

Loading a Program or Mix from a Card

To load a single Mix or Program from a card into the User Bank, first select the Mix or Program, then use the Store Function to store it in the User Bank.

Note that when storing a Mix from a Card into the User Bank, the individual Programs used by the Mix will not be moved into the User Bank.

If the Mix or Program you wish to transfer uses samples that reside on a ROM card, you must have the ROM card in the slot after the transfer in order for that portion of the Program or Mix to sound the same (or at all).

Transferring Mix Banks

Whenever you transfer an internal Bank to an SRAM card, all Mixes in the transferred Bank are automatically modified so that they access the Programs on the card Bank instead of the internal Bank. And, when a card Bank is transferred to the User Bank, the opposite happens – all Programs within a Mix which had previously accessed the card Bank point to the User Bank.

When an individual Mix is transferred, it is not modified in any way. The modification only occurs when an entire bank is transferred.

Generally, it's a good idea to make banks self-contained. That is, all Mixes in a bank should access only Programs that are in the same bank. You don't have to do this, but it makes things easier when copying banks.

What is MIDI?

MIDI stands for Music Instrument Digital Interface. It allows music instruments to communicate with each other. You can use MIDI to:

- Record what you play on your QS synthesizer into a sequencer or computer.
- Play back sequences from a sequencer or computer on your QS.
- Store and recall Programs and Mixes on a computer.
- Use a computer to edit your QS's sounds.
- Use your QS to control another synthesizer or sound module.
- Use another keyboard to play your QS's sounds.

Some examples of MIDI devices besides your QS synthesizer include keyboard controllers, sound modules, drum machines, sequencers, and computers with MIDI interfaces.

MIDI Connections

The QS has three MIDI connectors:

- [MIDI IN] is for receiving MIDI information from another MIDI device.
- [MIDI OUT] is for sending MIDI information to another device. Depending on your settings, the data from this port can originate from the QS itself or simply be echoed from the [MIDI IN] port.
- [MIDI THRU] echoes whatever is received on the [MIDI IN] port.

Here are four typical MIDI setups for your QS, and the appropriate connections for each of them:

- **Controller.** With this setup, you can use your QS to “play” another MIDI instrument (synthesizer, sound module, drum machine etc.). Connect a MIDI cable from the QS's [MIDI OUT] jack to the MIDI IN of the device you want to control.

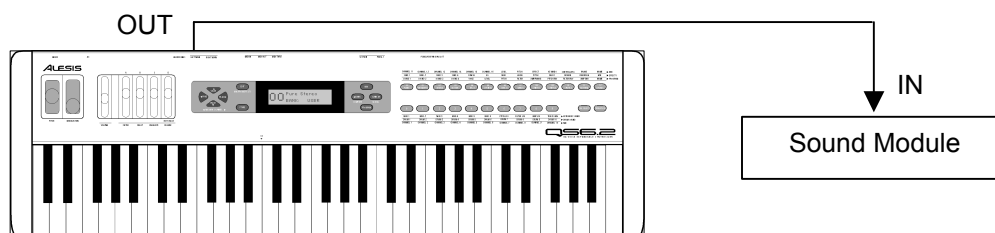

- **Slave.** With this setup, you can use another keyboard to play the sounds on your QS. Connect a MIDI cable from the controller's MIDI OUT jack to the QS's [MIDI IN] jack.

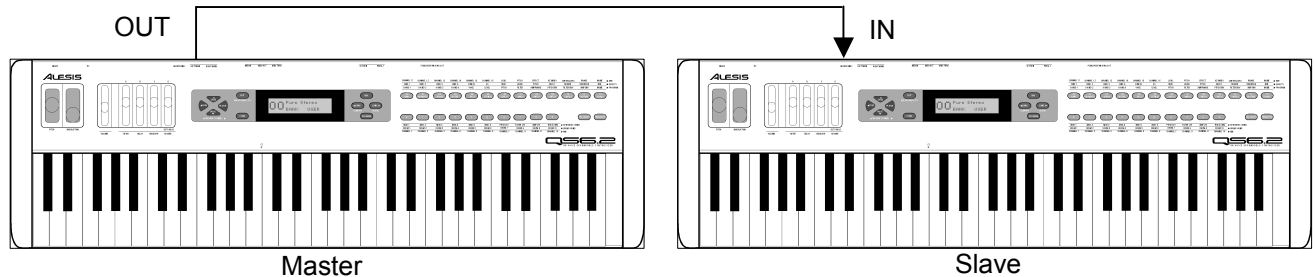

- **Slave with pass-through.** This setup allows MIDI signals to pass through the QS so they may reach multiple units. This allows one MIDI device to control several. Attach a cable from the MIDI OUT of the first device to the [MIDI IN] jack of the QS; and then attach another cable from the QS's [MIDI THRU] jack to the MIDI IN of the third device.

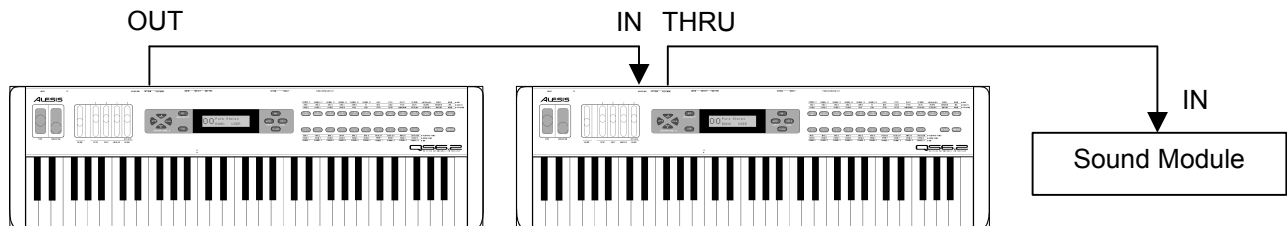

- **Sequencing.** This setup allows you to use your QS with a MIDI sequencer or a computer with a MIDI interface. Attach one MIDI cable from the MIDI OUT of the sequencer or computer to the [MIDI IN] jack of the QS. Attach another cable from the QS's [MIDI OUT] jack to the MIDI IN of the sequencer or computer.

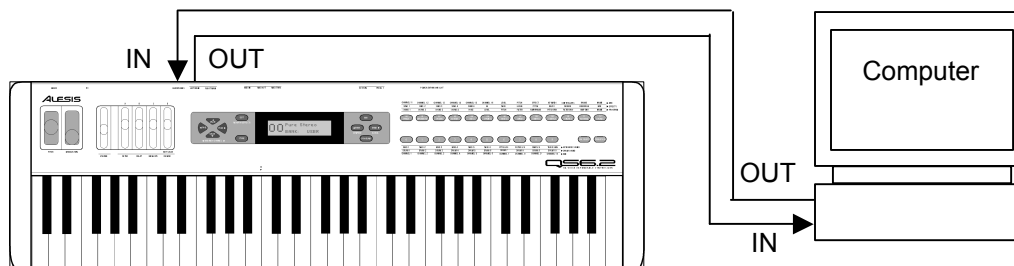

Using Your QS With a MIDI Sequencer

A **sequencer** is a device that records and plays back note messages. A sequencer can take the form of a stand-alone hardware device, or a computer with a MIDI interface and sequencing software.

Using a MIDI sequencer, you can record what you play on your QS, and then play it back later. You can also obtain sequences written by other people and play them back on your QS synthesizer. There are a large number of General MIDI sequences available for just this purpose.

Since the QS is a multitimbral instrument, it is a perfect companion to a sequencer. In Mix Mode, the QS can play up to 16 different programs simultaneously. This means that if you play a multi-channel sequence into your QS, it can sound like a whole band, ensemble, or even an orchestra!

Changing the MIDI Channel

In order for MIDI to work, the MIDI Channel must be set properly. For example, if you want one device to control another via MIDI, they must be set to the same MIDI channel. There are 16 MIDI channels.

In Program Mode, the MIDI channel is indicated by a small number at the bottom of the display. To change the MIDI channel, press either of the [PAGE] buttons.

When there is MIDI activity (either from the MIDI port or the QS's keyboard) a small circle around the number will flash.

In Mix Mode, the MIDI channel will depend on how the Keyboard Mode is set. The Keyboard Mode parameter is found on Page 6 of the Global Pages. Please look at the "Global Parameters" section of this manual to see how to set it.

Saving Programs and Mixes Via MIDI

The QS lets you transmit your entire User Bank (Programs and Mixes) to an external device (such as a computer, sequencer, storage device, or another QS synthesizer) via MIDI.

NOTE: the QS sends and receives Bank, Program and Mix data in MIDI sysex format.

To send the entire User Bank (Programs and Mixes) via MIDI:

- 1) Connect a MIDI cable from the QS's [MIDI OUT] jack to the MIDI In of a device capable of receiving the data (a computer, sequencer, another QS, etc.).
- 2) Press [STORE].
- 3) Press [PAGE >] six times to select the proper page of the Store function. The display will look like this:

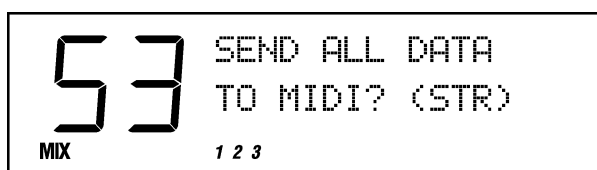

- 4) Set up your receiving device to accept a MIDI sysex dump.
- 5) Press [STORE] to transmit the data from the QS. While transmitting the data, the display will read “SENDING OUT MIDI DATA.....”.

To send a single Program via MIDI:

- 1) Follow steps 1 and 2 in the instructions above.
- 2) Press [PAGE >] seven times to select the proper page of the Store function. The display will look like this:

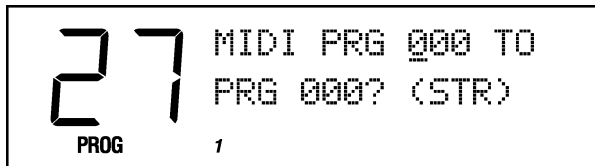

- 3) Use the [CONTROLLER D] slider and the [VALUE] buttons to select a Program to transmit. You may select any Program in the User Bank (000 to 127) or the Program Edit buffer (EDIT) or any of the 16 Mix Edit buffers (Em01 to Em16).

As this value is changed, the second parameter (destination) will change also. If you hit [PAGE >] one more time, you can change the destination number separately.

- 4) Press [STORE] to transmit the data out the [MIDI OUT] connector.

To send a single Mix via MIDI:

The procedure for sending a single Mix is very similar to that of sending a Program (see above). Hit [STORE], then [PAGE >] nine times to get to the MIDI Mix Store page.

Loading Programs and Mixes Via MIDI

The QS doesn't need to be in a special mode to receive MIDI sysex information. Simply connect a MIDI cable from the MIDI out jack of your MIDI player to the [MIDI IN] port of your QS and start the sysex dump on your MIDI storage device or computer. If everything is working properly, the QS display will read “RECEIVING MIDI DATA...” and the Bank, Program, or Mix will be loaded into the User Bank.

NOTE: Just because you're storing a Mix to MIDI doesn't mean that all of the Programs used by that Mix are being taken with it. If you want that Mix to sound the same in someone else's QS, you're going to need to send along the Programs out of which it was constructed.

NOTE: Some computers are not fast enough to transmit MIDI sysex data properly. If you are experiencing problems, try adjusting the settings in your MIDI software. Some programs allow you to slow down the transmit rate so the computer hardware can keep up with the software.

What are the Global Parameters?

Certain basic parameters affect your entire QS. Because they affect everything, they are called the **Global Parameters**.

Entering Global Mode

- 1) Press [EDIT].
- 2) Press the [BANK >] button (with [GLOBAL] written beneath it). The display will look like this:

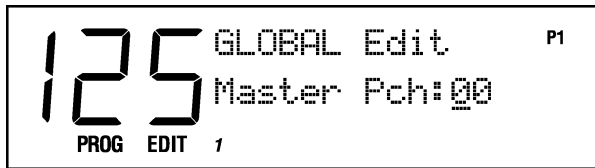

To exit Global Mode, press [MIX] or [PROGRAM].

NOTE: The "P1" in the upper right corner of the display stands for Page One, and it tells you where you are among the Global pages.

NOTE: Any changes you make in Global Mode will be saved immediately without having to press any additional buttons.

The Global Pages

Setting the Master Pitch

Button: [EDIT] [GLOBAL]
Page: 1
Parameter: Master Pch (-12 to +12 semitones)

This parameter globally shifts the pitch of all sounds coming out of the QS, whether triggered from the keyboard or from incoming MIDI information. This parameter has no effect on MIDI Out note data.

NOTE: Changing MASTER PITCH can alter QS drumkits in unpredictable ways, because it shifts the key assignments of multi-sampled drumkits in Keyboard Mode but doesn't shift Drum Mode sounds. Most Preset drumkits are constructed using a combination of the two.

Fine Tuning

Button: [EDIT] [GLOBAL]
Page: 2
Parameter: Master Tun (-99 to 99 cents)

This setting is like Master Pitch, but on a much finer scale. Its main use will be to tune your QS to match other instruments. -99 to 99 cents is equivalent to down or up one half-step (in hundredths of a semitone).

NOTE: This parameter does not have any effect on Drum Mode sounds. However, it will work to tune drums that are part of multisampled Keyboard Mode drumkits. They tune down or up as far as they can go and then switch to the next keygroup, which will probably be a different sample.

Picking the Keyboard Velocity Curve

Button: [EDIT] [GLOBAL]
Page: 3
Parameter: KbdCurv (WEIGHT, PLASTC, MAXMUM)

This parameter alters the QS keyboard's velocity response.



WEIGHT gives the keyboard the widest possible dynamic velocity range for weighted keyboards (like the QS8.2's).

PLASTC has a narrower dynamic velocity range associated with synth keyboards (like the QS6.2's). Notes played gently will be louder than they would be if you had selected **WEIGHT**.

MAXMUM means that every note played on the keyboard is given the maximum MIDI velocity, which is 127. In this mode, your QS's keyboard is no longer velocity-sensitive.

Setting the Keyboard Velocity Scaling

Button: [EDIT] [GLOBAL]
Page: 4
Parameter: Kbd Scaling (00 to 99)

This parameter adjusts the velocity sensitivity of the keyboard. At **00** the keyboard is least sensitive. At **99**, the keyboard will be very sensitive to velocity. The default setting is **65**.

Transposing the Keyboard

Button: [EDIT] [GLOBAL]
Page: 5
Parameter: Transpose (-31 to 31 in QS6.2, -19 to 19 in QS8.2)

This is the same type of Transpose that happens when you press the [TRANPOSE] button. It changes the MIDI Note Numbers assigned to the keyboard, thus changing the note data sent out from your QS when you play. On this page however, you enter the transpose amount by using the standard [EDIT VALUE] slider and [VALUE] buttons, not by pressing keys on the keyboard.

Setting the Keyboard MIDI Mode

Button: [EDIT] [GLOBAL]
Page: 6
Parameter: Kbd Mode (Norm, Solo, Out01-Out16)

This setting determines how the QS's keyboard will work with respect to MIDI and the internal QS engine.

Norm is the default setting. In Program Mode, the QS will receive and transmit over the selected MIDI channel. In Mix Mode, MIDI is received over all active MIDI channels, and sent over all active channels that have MIDI OUT enabled.

Ch Solo is the same as NORMAL in Program Mode. In Mix Mode, it only allows you to play the selected Mix channel from the keyboard and only transmits on that MIDI channel. This is used to individually check out the Programs that are in a Mix, or for multitimbral sequencing.

In this mode, you'll only hear one Program at a time. If the keyboard is split or layered in Mix Mode, you'll only hear the Program on the current Mix channel.

Out01 through **Out16** select a single MIDI channel to transmit on, while simultaneously shutting off local keyboard control. Use this mode if you'll be using your QS with an external sequencer controlling several

NOTE: This mode is automatically selected by the QS when the General MIDI function is set to ON.

NOTE: With this mode selected you will not hear the QS unless your sequencer echoes the MIDI data back to the QS's MIDI IN port. This is equivalent to the LOCAL OFF setting in some synthesizers.

MIDI devices. You'll need to set your sequencer to echo back the MIDI data that is being recorded.

Turning on General MIDI

Button: [EDIT] [GLOBAL]
Page: 7
Parameter: Genrl MIDI (ON, OFF)

This setting allows your QS to play any of the thousands of General MIDI ("GM" for short) sequences that are available from the Internet and other sources. Turning this **ON** will immediately put the QS into Mix Mode and call up the GM Multi Mix.

Setting the A-D Controller MIDI Numbers

Button: [EDIT] [GLOBAL]
Pages: 8 through 11
Parameter: ControlrA-D (0 to 120)

These parameters let you select the MIDI Controller Numbers that will be assigned to the A-D [CONTROLLER] sliders. This is useful both for controlling external MIDI devices and for giving you sequencer-recordable control over Program and Effect parameters. The default values are 012, 013, 091 and 093 for Controllers A-D respectively.

Setting the Pedal 1 MIDI Controller Number

Button: [EDIT] [GLOBAL]
Page: 12
Parameter: Ped1 Ctrl# (0 to 120)

Just like MIDI Controllers A–D, your QS's [PEDAL 1] jack can be assigned to a MIDI controller. The default is Controller 007 (Main Volume). When set to this value, a pedal plugged into the back panel's Pedal 1 jack will automatically control volume.

Setting the Pedal 2 MIDI Controller Number

Button: [EDIT] [GLOBAL]
Page: 13
Parameter: Ped2 Ctrl# (0 to 120)

This setting works exactly like Pedal 1, just above. Even though the QS does not have a Pedal 2 input, you can use this function to modulate QS parameters through MIDI. The default for this setting is 004 (Foot Controller).

Selecting the MIDI Program Change Behavior

Button: [EDIT] [GLOBAL]
Page: 14
Parameter: MIDI Prgsl (OFF, ON, CH1-16)

This parameter determines how your QS deals with MIDI Program Change Commands.

When **OFF**, your QS will not send or respond to Program Change messages.

NOTE: The General MIDI spec reserves MIDI Channel 10 for drumkits. Because of this, when the General MIDI setting is ON, your QS won't be able to call up anything but drumkits on Channel 10.

NOTE: Turning General MIDI ON automatically sets your Keyboard Mode to CH SOLO. Turning General MIDI off will put the Keyboard Mode back the way it was.

NOTE: Some General MIDI sequences will have a SysEx message at the beginning which tells the receiving device to go into General MIDI mode. The QS will respond to such a message. If one comes in, then your instrument will immediately jump from wherever it is to the GM Multi Mix.

ON makes the QS send and respond to MIDI Program Changes. In Program Mode it will send and receive Program Changes over the currently selected MIDI channel. In Mix Mode, Program Changes are received over all active MIDI channels, but sent only from those displayed channels that have had MIDI OUT enabled. With this setting, incoming Program Changes will only affect the Programs, not the entire Mix.

NOTE: When you turn General MIDI Mode ON, the MIDI Program Change setting will be turned ON as well.

CH1 through **CH16** are identical to **ON** as far as Program Mode is concerned. In Mix mode, these settings allow you to change Mixes in response to Program Change commands on the specified MIDI channel. Program Changes coming in over other MIDI channels would continue to work as before, changing any Programs associated with those channels within the Mix.

Setting the Behavior of the MIDI Out Port

Button: [EDIT] [GLOBAL]
Page: 15
Parameter: MIDI Out (OUT, THRU)

This determines the behavior of the [MIDI OUT] port.

When set to **OUT**, MIDI data from the QS will be sent to the [MIDI OUT] port. This is the default setting.

When set to **THRU**, a copy of what is received from the [MIDI IN] port will be echoed to the [MIDI OUT] port (with no MIDI data from the QS mixed in). In other words, the [MIDI OUT] port will act as a MIDI THRU.

Resetting the A-D Controllers

Button: [EDIT] [GLOBAL]
Page: 16
Parameter: RESET A-D (ON, OFF)

This parameter determines whether the values for Controllers A–D will reset to zero or stay the same whenever a new Program or Mix is chosen.

The default is **ON**, which resets the A-D Controllers to zero whenever you change Programs or Mixes.

TIP: If you are using [CONTROLLER] sliders to affect the volumes of external MIDI sound modules, you probably want to set this parameter to OFF. That way you won't reset all the different modules to zero volume every time you changed Programs. Otherwise, you will probably want to leave this ON.

Setting the A-D Controller MIDI Mode

Button: [EDIT] [GLOBAL]
Page: 17
Parameter: A-D MODE (LOCAL, MIDI, BOTH)

This parameter determines how the A-D [CONTROLLER] sliders will work.

LOCAL makes the sliders control the QS without sending MIDI data.

MIDI makes the sliders send out MIDI data, but have no effect on the QS.

BOTH makes the sliders control your QS and send MIDI data. This is the default setting.

QS Composite Synthesis™

The QS generates sound through the use of QS Composite Synthesis™. The basis of this technology is the playback and processing of audio **samples**. A sample is a digital recording of a sound. The sound could be a sine wave, a grand piano, or even a full orchestra.

The QS processes these samples by applying filters, envelopes and modulations, and then mixing them with other processed samples. In this way, the QS can create a universe of sounds.

The Voice

The part of the QS that plays back a sample is called a **Voice**. The QS has 64 Voices, so it can play 64 sounds at the same time.

Lowpass Filter

The output of the Voice feeds into a **lowpass filter**, which dampens high frequencies and allows low frequencies to pass through. The frequency at which the dampening begins is called the **filter frequency**. The lower the filter frequency, the more muted the sound.

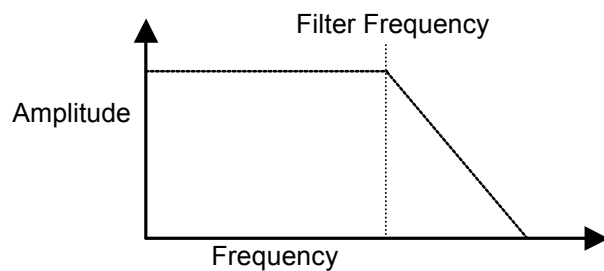

Amplifier

Each voice/filter combination is followed by an **amplifier** whose level can be controlled by a variety of sources. This allows for creating sounds with either percussive or slow attacks, or particular types of decays, or tremolo, etc.

The Four Sound Layers of a Program

Each voice/filter/amplifier group is called a **Sound**. Up to four Sounds can be used in a Program. You can overlap Sounds, split them across the keyboard, or any combination of these.

The number of Sounds being used by a Program has a direct effect on the QS's polyphony. If the current Program uses only one Sound, you'll be able to play 64 simultaneous notes. A Program using two Sounds will be limited to 32 simultaneous notes, and so on.



The following diagram shows the signal flow for each Sound:

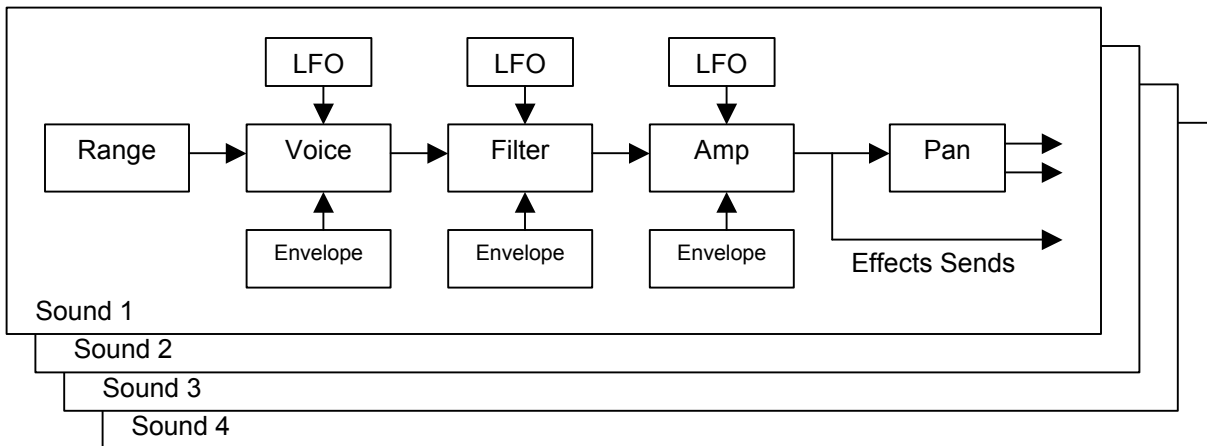

Modulation

In synthesizer programming, **modulation** refers to modifying some aspect of a sound over time. Modulation is the key to making rich and expressive sounds. The vibrato of a flute, the expression pedal of an organ, and the wah pedal on a guitar are all examples of modulation. Modulation can be used to control basic characteristics of a voice, including pitch, filter frequency, volume, and envelope.

With some parameters, the modulation amount can be positive or negative. With positive modulation for example, keyboard velocity can be used to make a Sound brighter the harder you play. This is how many acoustic instruments behave. With negative modulation, you also have the ability to make the Sound more muted the harder you play. Setting modulation to 00 turns off the modulation source.

NOTE: Modulation cannot force a parameter beyond its maximum or minimum value. For example, if the Amp is set to its minimum value, applying negative modulation will not affect it.

LFO (Low Frequency Oscillator)

The term **LFO** stands for “Low Frequency Oscillator”. The LFO creates a cyclic waveform that varies over time with a specified shape and speed. This waveform can be used as a modulation source. The pitch, filter, and amp modules each have a dedicated LFO.

Envelopes

An **envelope** is a modulation source that varies over time, starting from when you strike a key. There are three independent envelope generators (for pitch, filter, and amplitude) in each Sound layer.

Each envelope generator has the standard attack, decay, sustain, and release parameters found on most synthesizers, along with delay, sustain decay, and different triggering options. More on this later.

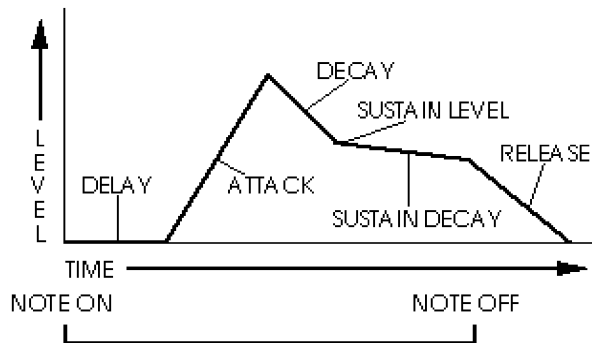

The Effects Section

The QS features a complete digital effects section with four input buses, simultaneous multiple effects, and flexible signal routing. The effects include Chorus, Flange, Detune, Delay, Reverb and EQ.

Effects parameters are edited separately from either the Program or the Mix, using Effects Edit Mode. In Program Edit Mode, each of the four Sounds in the Program has its own Effect Level control and can be assigned to any one of the four effect buses.

Editing a Program

From Program Mode, press the [EDIT] button once.

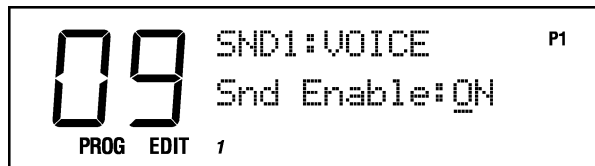

NOTE: As soon as you change a value, the word "EDIT" will change to "EDITED" in the lower left part of the display.

Program Edit Functions

In Program Edit Mode, the numbered buttons select the Sound to edit or the edit function. The function of the buttons is printed on the front panel directly above or below the buttons.

Selecting a Sound to Edit [00-30 SOUND]

In Program Edit Mode, the [00]-[03] buttons select which Sound Layer (1-4) you are editing. Remember, each Sound has its own sample, amplifier, filter and envelope sections. You can change Sounds from any Edit page by pressing a [00]-[03] button. Notice that the Sound number changes in the upper left part of the display as you press these buttons.

The Voice Function [40 VOICE]

Hit the [40] button to choose the sample that forms the basis of your Sound. Use the [PAGE] buttons to select parameters within this function to edit.

Turning Sounds On and Off

Button: [EDIT] [40 VOICE]
Page: 1
Parameter: Snd Enable (ON or OFF)

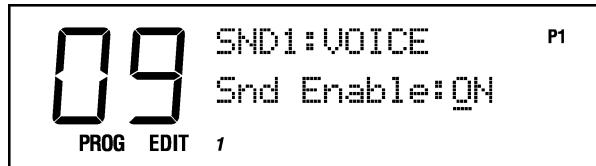

This enables or disables the selected sound. When a Sound is disabled, “snd” will appear in lowercase in the display. When enabled, “SND” will appear uppercase.

To avoid using up polyphony unnecessarily, turn off any Sounds that you’re not using. Turning Sounds off is also a convenient way to isolate a particular sound you are editing.

TIP: A quick way to turn a Sound on and off from anywhere within Program Edit Mode is to hold the corresponding Sound button [00]–[30] and press [VALUE DOWN] to disable or [VALUE UP] to enable.

Selecting Keyboard or Drum Mode

Button: [EDIT] [40 VOICE]
Page: 2
Parameter: Snd Type (KYBD or DRUM)

This determines whether the Sound is in Keyboard Mode or Drum Mode. This chapter describes the Keyboard Mode functions. See the Drum Mode section of this manual for more information.

Selecting a Sample Category

Button: [EDIT] [40 VOICE]
Page: 3
Parameter: Group (see chart)

This selects the sample category (or group) for the Sound (for example, Pianos, Organs, Guitars, etc.)

Selecting a Sample

Button: [EDIT] [40 VOICE]
Page: 4
Parameter: Snd (see chart)

This selects the actual sample that will be the basis of the Sound. Here’s a chart listing the various samples in their respective groups.

Group	Sample
Piano	GrndPianoL, GrndPianoR, DarkPno1 L, DarkPno1 R, DarkPno2 L, DarkPno2 R, DarkPno3 L, DarkPno3 R, BritePno1L, BritePno1R, BritePno2L, BritePno2R, BritePno3L, BritePno3R, 4::VibesWave, NoHammer R, SoftPianoL, SoftPianoR, VeloPianoL, VeloPianoR, TapPiano L, TapPiano R, E Spinnet 1, E Spinnet 2, Toy Pno L, Toy Pno R, KeyTrack1, KeyTrack2, Stretch L, Stretch R, PianoWaveL, PianoWaveR, BriteRoads, Dark Roads, Soft Roads, VeloRoads1, VeloRoads2, VeloRoads3, Wurly, VeloWurly1, VeloWurly2, FM Piano, FM Tines, Soft Tines, VelAtkTine, Vel FM Pno, BrtRdsWave, DrkRdsWave, SftRdsWave, Wurly Wave
Chromatic	Clavinet, VelAtkClav, ClavntWave, Harpsicord, VAtkHarpsi, HarpsiWave, Glock, Xylophone, Marimba Hd, Marimba Sf, MarimbaVel, Vibraphone, VibesWave, Ice Block, Brake Drum, TubulrWave, TubWv/Null, FMTblrBell, FMTublRft, FMTublRVel, FMTub/Null
Organ	Rock Organ, Perc Organ, FullDrwbr1, FullDrwbr2, 3 Drawbars, 4 Drawbars, UpprDrwbrs, 16'Drawbar, 5 1/3' bar, 8' Drawbar, 4' Drawbar, 2 2/3' bar, 2' Drawbar, 1 3/5' bar, 1 1/3' bar, 1' Drawbar, Percus 2nd, Percus 3rd, Percus Wav, HollowWave, 60's Combo, RotarySpkr, ChurchOrgn, Principale, Positive
Guitar	SteelStrng, NylonGuitr, Nylon/Harm, Nylon/Harp, JazzGuitar, SingleCoil, Sngle/Mute, DoubleCoil, DCoil/Harm, DCoil/Jazz, D/S Coil, MicroGuitr, PwrH/MGtr1, PwrH/MGtr2, MuteGuitar, Mute Velo, Metal Mute, MGtr/MtlMt, MtlMut/Hrm, Fuzz Wave, ClsHarmncs, ElecHarmnc, Pwr Harm 1, Pwr Harm 2, Pwr Harm 3, PwrHrmVel1, PwrHrmVel2, PwrHrmVel3
Bass	StudioBass, Studio&Hrm, Studio/Hrm, Slp/Studio, Slap Bass, Slap&Harm, Slap/Harm, Slap/Pop, Pop/Slap, Bass Pop, Pop/Harm, Harm/Pop, JazzFingrd, Fingr&Harm, JazzPicked, Pickd&Harm, Jazz Velo, Muted Bass, Stik Bass, Stik&Harm, Stik/Harm, Harm/Stik, Fretless, Frtls&Harm, AcousBass1, AcoBs1&Hrm, AcousBass2, AcoBs2&Hrm, VelAcoBass, 3-VelBass1, 3-VelBass2, 3-VelBass3, 3-VelBass4, BassHarmnc
String	StringEnsm, TapeStrngs, SoloString, SoloViolin, Solo Viola, Solo Cello, Contrabass, Pizz Sectn, Pizz Split, Pizz/Strng, Strng/Pizz, StringAttk, Harp, Hi Bow, Low Bow
Brass	Pop Brass, ClasclBras, AttakBrass, Trumpet, HarmonMute, Trombone, FrenchHorn, Bari Horn, Tuba
Wdwind	Bassoon, Oboe, EnglishHrn, Clarinet, Bari Sax, BrthyTenor, Alto Sax, SopranoSax, Velo Sax, Flute, Flute Wave, Shakuhachi, PanPipe Hd, PanPipe Md, PanPipe Sf, PanPipeVel, Pan Wave, BottleBlow, BottleWave
Synth	J Pad, M Pad, X Pad, Velo Pad 1, Velo Pad 2, Velo Pad 3, AcidSweep1, AcidSweep2, AcidSweep3, AcidSweep4, AcidSweep5, VeloAcid 1, VeloAcid 2, VeloAcid 3, VeloAcid 4, Chirp Rez1, Chirp Rez2, Chirp RezV, Quack Rez1, Quack Rez2, Quack Rez3, Quack Rez4, QuackRezV1, QuackRezV2, QuackRezV3, Uni Rez 1, Uni Rez 2, Uni Rez 3, Uni Rez V, AnalogSqr1, AnalogSqr2, AnalogSqrV, SyncLead 1, SyncLead 2, SyncLead V, Seq Bass, Seq BassV1, Seq BassV2, FatSynBass, TranceBas1, TranceBas2, VeloTrance, FunkSynBs1, FunkSynBs2, FunkSynBs3, FunkSynBsV, FilterBass, FM Bass, FM/FiltVel, Soft Chirp, Soft Rez
Wave	Pure Sine, 10% Pulse, 20% Pulse, 50% Pulse, Velo Pulse, Mini Saw, Saw Fltr 1, Saw Fltr 2, Saw Fltr 3, Saw Fltr 4, Saw Fltr 5, Saw Fltr 6, Saw Fltr 7, RezSaw UK, RezSaw USA, Acid Saw, Velo Saw 1, Velo Saw 2, Velo Saw 3, Velo Saw 4, Velo Saw 5, Velo Saw 6, AcidRezSqr, VelAcidWav, MiniSquare, Sqr Fltr 1, Sqr Fltr 2, VeloSquare, Mini Tri, Tri Filter, Velo Tri, Rectanglar, Hard Sync, HSync/Rect, BrightSync, Rez Sync, Ring Mod, RingMod V1, RingMod V2, OctaveLock, Diet Saw, Band Saw, Notch Saw, HiPassSaw1, HiPassSaw2, HiPassSaw3, HiPassSaw4, HiPassVel1, HiPassVel2, HiPassVel3, HiPassVel4, HiPassVel5, HiPassVel6, Cognitive, Additive 1, Additive 2, VeloAdditv, Digital 1, Digital 2, Digital 3, Digital 4, Science 1, Science 2, Science 3, Science 4, VelScience, Metal Wave, Inharmonc1, Inharmonc2
Noise	WhiteNoise, Spectral, Crickets, Rain Noise, FiltrNoise, ShapeNoise, VeloNoise1, VeloNoise2, VeloNoise3, NoiseLoop1, NoiseLoop2, NoiseLoop3, NoiseLoop4, NoiseLoop5
Voice	VocalAhhs, Soft Ahhs, Ahhs Wave, VocalOohs, Soft Oohs, Oohs/Ahhs, Ahhs/Oohs, Whistle, Phonic
Ethnic	Sitar, Sitar Wave, Shamisen, Koto, DulcimerHd, DulcimerMd, DulcimerSf, DulcimrVel, DulcmrWave, MandlnTrem, Accordion, Harmonica, Banjo, Kalimba, Steel Drum, Tuned Pipe
Drums	Stndrd Kit, Rock Kit 1, Rock Kit 2, Dance Kit, Brush Kit, ElectricKit, Tek Kit, Rap Kit, Street Kit, MetalliKit, HvyMtlKit, VeloMtlKit, Trip Kit 1, Trip Kit 2, Trip Kit 3, Wild Kit, Octave Kit, OrchstraKt, Raga Kit, FloppyKick, PillowKick, MasterKick, Metal Kick, Smoke Kick, GrooveKik1, GrooveKik2, Sharp Kick, Tek Kick, AnalogKick, Rap Kick, FatWoodSnr, HR Snare, Master Snr, PiccoloSnr, Electrncl, Electrncl2, Rap Snare1, Rap Snare2, Tek Snare, Brush Snr, Crosstick, Hi Tom, Mid Tom, Low Tom, Cannon Tom, Hex Tom, Rap Tom, Closed Hat, HalfOpnHat, Open Hat, Foot Hat, TekHatClsd, TekHatOpen, RapHatClsd, RapHatOpen, CricketCHH, CricketTIK, CricketsOHH, FltrNoisCH, FltrNoisOH, Ride Cym, Ride Bell, Crash Cym, Null/Crash, Splash Cym, China Cym, Rap Cymbal, RapCymWave, StndrdKtDM, RockKit1DM, RockKit2DM, DanceKitDM, BrushKitDM, ElctrcKtDM, Tek Kit DM, Rap Kit DM, StreetKtDM, TripKit1DM, TripKit2DM, TripKit3DM, OctavKitDM, OrchstraDM

Percus	Agogo, Bongo, Cabasa, Castanet, Chimes 1, Chimes 2, Chimes 3, Clap Rap, Clap Tek, Clave 1, Clave 2, Conga Hit1, Conga Hit2, CongaSlap1, CongaSlap2, Rap Conga, Rap Rim, Cowbell, RapCowbell, Cuica, Djembe Hi, Djembe Low, Drumstix, FingerSnap, GuiroLong1, GuiroLong2, GuiroShort, Maracas, SmbaWhstl1, SmbaWhstl2, ShortWhstl, Shaker Hi, Shaker Low, Sleighbel1, Sleighbel2, Tabla Ga, Tabla Ka, Tabla Ka 2, Tabla Na, Tabla Te, Tabla Te 2, Tabla Tin, Taiko Drum, Taiko Rim, Talk Down, Talk Up, Tambourine, Timbale, Timpani, Null/Timp, Triangle 1, Triangle 2, TrianglSf1, TrianglSf2, Udu Hi, Udu Mid, Udu Low, Udu Slap, Vibrasmak1, Vibrasmak2, Wood Block
SndFX	Rain 1, Rain 2, Bird Tweet, Bird Loop, Telephone, Jungle 1, Jungle 2, Jungle 3, Jungle 4, GoatsNails, ScrтчPul1, ScrтчPul2, ScrтчPsh1, ScrтчPsh2, ScratchLp1, ScratchLp2, ScrтчPLp1, ScrтчPLp2, ScrтчPLp3, ScrтчPLp4, Orch Hit, Null/Orch, Dance Hit, Null/Dance, Rez Zip, RezAttack1, RezAttack2, RezAttkVel, Zap Attk 1, Zap Attk 2, Zap Attk 3, Fret Noise, Sci Loop 1, Sci Loop 2, Sci Loop 3, Bit Field1, Bit Field2, Bit Field3, Bit Field4, Bit Field5, Bit Field6, WavLoop1.0, WavLoop1.1, WavLoop1.2, WavLoop1.3, WavLoop1.4, WavLoop1.5, WavLoop1.6, WavLoop1.7, WavLoop1.8, WavLoop2.0, WavLoop2.1, WavLoop2.2, WavLoop2.3, WavLoop2.4, WavLoop2.5, WavLoop2.6, WavLoop2.7, WavLoop2.8, WavLoop3.0, WavLoop3.1, WavLoop3.2, WavLoop3.3, WavLoop3.4, WavLoop3.5, WavLoop4.0, WavLoop4.1, WavLoop4.2, WavLoop4.3, WavLoop4.4, WavLoop4.5, D-Scrape, D-ScrapeLp
Rhythm	Psi Beat 1, Psi Beat 2, Psi Beat 3, Psi Beat 4, Psi Beat 5, Psi Beat 6, Psi Beat 7, Psi Beat 8, Psi Beat 9, Psi Beat10, Psi Beat11, Psi Beat12, Kick Loop1, Kick Loop2, Kick Loop3, Kick Loop4, Kick Loop5, Kick Loop6, Kick Loop7, Kick Loop8, Kick Loop9, KickLoop10, KickLoop11, Snare Lp 1, Snare Lp 2, Snare Lp 3, Snare Lp 4, Snare Lp 5, Snare Lp 6, Snare Lp 7, Snare Lp 8, Snare Lp 9, SnareBeat1, SnareBeat2, SnareBeat3, SnareBeat4, SnareBeat5, Back Beat1, Back Beat2, Back Beat3, Back Beat4, Hat1 Clsd1, Hat1 Clsd2, Hat1 Foot, Hat1 Open1, Hat1 Open2, Hat2 Clsd1, Hat2 Clsd2, Hat2 Foot, Hat2 Open1, Hat2 Open2, Hat3 Clsd1, Hat3 Clsd2, Hat3 Open1, Hat3 Open2, Hat Beat 1, Hat Beat 2, Hat Beat 3, Hat Beat 4, Hat Beat 5, Hat Beat 6, Hat Beat 7, Hat Beat 8, Hat Beat 9, Hat Beat10, Agogo Loop, Bongo Loop, CabasaLoop, CastanetLp, CongaLoop1, Shaker Lp1, Shaker Lp2, SleighLoop, Tabla Ga Lp, Tabla Ka Lp, Tabla Na Lp, Tabla Te Lp, TablaTin Lp, Taiko Loop, PercBeat1, PercBeat2, PercBeat3, PercBeat4, VoiceLoop1, VoiceLoop2, PhonicLoop, SpinalLoop, Tr Loop 1, Tri Loop 2, Orch Loop

The Level Function [50 LEVEL]

The Level function (button [50]) allows you to control the volume, pan position, output assignment and effects send level for each Sound.

Setting the Sound Volume

Button: [EDIT] [50 LEVEL]
Page: 1
Parameter: Snd Volume (00 to 99)

This sets the volume for the current Sound.

NOTE: If the Volume setting is "maxed out" and you still can't hear anything, make sure the Filter Frequency setting (described later in this chapter) is greater than zero.

Adjusting the Panning

Button: [EDIT] [50 LEVEL]
Page: 2
Parameter: Snd Panning (<3 to 3>)

This sets the panning over the stereo field, from far left (<3) to far right (3>).

Routing Sounds to the Outputs

Button: [EDIT] [50 LEVEL]
Page: 3
Parameter: Snd Output (see below)

In the QS6.2, selecting **ON** routes the Sound to the main outputs; **OFF** shuts off the path.

In the QS8.2, selecting **MAIN** routes the Sound to the main outputs; **OFF** shuts off the path. A setting of **AUX** will also shut off the path. (This is provided for backward compatibility with older QS8 models).

TIP: Regardless of the setting, the Sound may still feed an Effects Send.

Setting the FX Send Level

Button: [EDIT] [50 LEVEL]
Page: 4
Parameter: FX Level (00 to 99)

This determines how much the Sound feeds the chosen effects Send. (See the “Editing Effects” section of this manual for more information).

Selecting the FX Send

Button: [EDIT] [50 LEVEL]
Page: 5
Parameter: FX Bus (1 to 4)

This selects which effects Bus or “Send” the Sound will feed. For example, Send 1 may be a Chorus/Delay/Reverb, Send 2 may be Reverb only, etc. (See the “Editing Effects” section of this manual for more information).

The Pitch Function [60 PITCH]

The Pitch function (button [60]) lets you control the pitch aspects of each Sound layer.

Setting the Pitch

Button: [EDIT] [60 PITCH]
Page: 1
Parameter: Semitone (-24 to +24 semitones)

This sets the oscillator pitch in semitones.

TIP: Remember, you can reset any parameter back to its default value by pressing the [VALUE UP] and [VALUE DOWN] buttons at the same time.

Fine Tuning the Pitch

Button: [EDIT] [60 PITCH]
Page: 2
Parameter: Detune (-99 to +99 cents)

This sets the oscillator pitch in cents, from -99 (down 99/100 of a semitone) to +99 (up 99/100 of a semitone).

Selecting the Detune Type

Button: [EDIT] [60 PITCH]
Page: 3
Parameter: DetuneType (NOR, EQU)

With **NOR** selected, the percentage of detuning remains the same over the entire range of the keyboard, so the effects of detuning sound the same no matter which key you play.

With **EQU** selected, the absolute amount of detuning remains the same over the entire keyboard, so any detuning seems less pronounced as you play higher up on the keyboard.

Setting the Pitch Wheel Bend Amount

Button: [EDIT] [60 PITCH]
Page: 4
Parameter: PWHL>PITCH (0 to 12 semitones)

This sets the amount of pitch bend when the [PITCH] wheel is full forward.

Setting the Aftertouch Pitch Bend Amount

Button: [EDIT] [60 PITCH]
Page: 5
Parameter: AFTCH>PITCH (-99 to +99)

This sets how much Aftertouch affects pitch. At **+99**, applying aftertouch raises the pitch 5 semitones. At **-99**, it lowers the pitch 5 semitones.

NOTE: Aftertouch is not present on the QS8.2 keyboard, but you can still have the aftertouch effect when you control the QS8.2 via MIDI.

Setting the Pitch LFO Amount

Button: [EDIT] [60 PITCH]
Page: 6
Parameter: PLFO>PITCH (-99 to +99)

This sets how much the Pitch LFO affects pitch. Higher values increase the amount of Pitch LFO modulation. Negative values flip the LFO phase. Pitch LFO parameters (such as speed and wave shape) are programmed within the Pitch LFO Function.

NOTE: Hearing a change when you edit this parameter depends on whether the LFO has received input from a modulator (such as the Mod wheel). If you hear no change, try moving the Mod wheel up.

Setting the Pitch Envelope Amount

Button: [EDIT] [60 PITCH]
Page: 7
Parameter: PENV>PITCH (-99 to +99)

This sets how much the Pitch Envelope affects Pitch. Higher values increase the effect of the Pitch Envelope. Negative values turn the envelope upside-down.

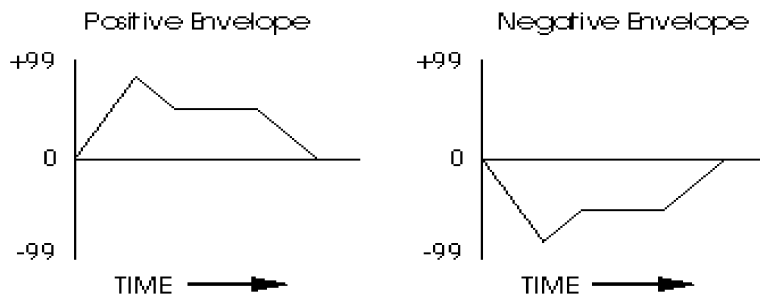

NOTE: Pitch Envelope parameters (such as attack and decay time) are programmed within the Pitch Envelope Function on button [90].

Setting the Portamento Mode

Button: [EDIT] [60 PITCH]
Page: 8
Parameter: Portamento (EXPON, LNEAR, 1-SPD)

Portamento provides a glide in pitch from one note to the next. An example of this is a steel guitar, where a note slides from one pitch to another. This parameter determines the sweep's curve.

With **EXPON** selected, the pitch change happens more rapidly at first, then slows down as it approaches the destination pitch.

With **LNEAR** selected, the portamento glide time is constant. The pitch takes the same time to reach its destination, regardless of the size of the interval.

With **1-SPD** selected, the portamento glide rate is constant, regardless of the pitch difference between notes, so the pitch takes a longer time to reach its destination for longer intervals.

Setting the Portamento Glide Time

Button: [EDIT] [60 PITCH]
Page: 9
Parameter: Porta Rate (00 to 99)

This sets the portamento glide time. Higher numbers give longer glide times.

Setting Monophonic or Polyphonic Mode

Button: [EDIT] [60 PITCH]
Page: 10
Parameter: KeyMde (MONO, POLY, 1-PITCH or 1-PMONO)

In **MONO** mode, you can play only one note at a time. Portamento behavior is most predictable in this mode.

POLY mode allows you to play multiple notes at the same time.

In **1-PITCH** mode, the program Sound layer will play a single pitch (the sample used for note C3) throughout the entire keyboard range.

1-PMONO is simply a monophonic version of 1-PITCH.

The Filter Function [70 FILTER]

The Filter function (button [70]) lets you control the tone of each Sound layer.

Setting the Filter Frequency

Button: [EDIT] [70 FILTER]
Page: 1
Parameter: Frequency (00 to 99)

This sets the filter frequency. Lower values give a duller sound; higher values give a brighter sound. At **00**, no sound will pass through the filter (unless it is being positively modulated by another source). At **99**,

NOTE: If a Sound layer's Keyboard Mode is set to MONO, the envelopes will only re-trigger when playing legato if the Trigger Mode is set to Reset or Reset-Freerun. For more information on this, see the Envelope Trigger functions.

TIP: With a feedback guitar patch that uses one Sound for the guitar and another for the feedback, set the feedback Sound to Mono to insure that the feedback "whistle" will be monophonic, which more accurately mimics what happens in reality.

TIP: This is often used for layering in a non-pitched noise or drum sound, for example, to fatten up a bass guitar sound with a hint of kick drum.

TIP: Since the waveforms in the QS ROM are recorded at the brightest possible setting, filtering is often required to making a program sound natural.

NOTE: This parameter interacts with several others. If you hear no change when you raise the Filter Frequency amount, try lowering the F-ENV>FILT parameter.

positive modulation won't have any affect, since the filter is already "maxed-out".

Turning On Filter Keyboard Tracking

Button: [EDIT] [70 FILTER]
Page: 2
Parameter: Kbd Track (ON or OFF)

This sets how the filter frequency tracks across the keyboard.

When **OFF**, the filter frequency remains constant across the keyboard. Higher notes will be more filtered than lower notes, since they have higher frequency components.

When **ON**, the filter frequency will track the keyboard pitch. When you play a higher note, the filter cutoff frequency will automatically be raised to compensate for the higher note.

Setting Velocity Filter Tracking

Button: [EDIT] [70 FILTER]
Page: 3
Parameter: VELO>FILT (-99 to +99)

This sets how much keyboard velocity affects the filter frequency. At positive values, playing harder raises the filter frequency, resulting in a brighter sound. At negative values, playing harder lowers the filter frequency, resulting in a darker sound.

TIP: Many acoustic instruments, such as acoustic guitars, sound brighter when you play them more forcefully. Adding a little positive velocity control over the filter frequency can more accurately simulate these instruments.

NOTE: If you don't hear any change when you edit this and other filter parameters, make sure the Filter Frequency is not already "maxed-out", i.e., it has room to move in the direction you specified.

Setting the Mod Wheel Filter Depth

Button: [EDIT] [70 FILTER]
Page: 4
Parameter: MODWH>FILT (-99 to +99)

This sets how much the modulation wheel affects filter frequency. At positive settings, moving the modulation wheel up raises the filter frequency. At negative settings, moving the wheel up lowers the filter frequency.

Setting the Aftertouch Filter Depth

Button: [EDIT] [70 FILTER]
Page: 5
Parameter: AFTCH>FILT (-99 to +99)

This sets how much aftertouch affects the filter frequency. At positive values, applying aftertouch raises the filter frequency. At negative values, applying aftertouch lowers the frequency.

Setting the Filter LFO Amount

Button: [EDIT] [70 FILTER]
Page: 6
Parameter: F-LFO>FILT (-99 to +99)

This sets how much the Filter LFO affects filter frequency. Higher values increase the amount of filter LFO modulation. Negative values flip the LFO phase.

TIP: Filter LFO is good for giving wah-wah effects at slower LFO speeds, and for adding "shimmering" at higher speeds.

NOTE: If you hear no change when you alter this parameter, experiment with the Filter LFO Functions on button [7]. You may get a more pronounced effect if you use a negative setting for Filter LFO Depth.

Setting the Filter Envelope Amount

Button: [EDIT] [70 FILTER]
Page: 7
Parameter: F-ENV>FILT (-99 to +99)

This sets how much the Filter Envelope affects the filter frequency. Higher values increase the effect of the Filter Envelope. Negative values turn the envelope upside-down.

The Amp/Range Function [80 AMP/RANGE]

The Amp/Range function (button[80]) lets you control the velocity and keyboard range of each Sound layer.

Selecting the Velocity Curve

Button: [EDIT] [80 AMP/RANGE]
Page: 1
Parameter: VelCrv (see chart)

This sets how the Level will respond to keyboard velocity.

LINEAR is the standard velocity curve, where playing harder results in a louder sound. **INVERTD** is the opposite, where playing harder results in a softer sound.

1OF2XFD and **2OF2XFD** stand for “1 Of 2 Crossfade” and “2 Of 2 Crossfade”. These are designed to be used in conjunction with each other on two Sounds in the same Program, producing a “velocity-switching” effect (i.e., a different Sound will play depending on how hard you hit the keys). **1OF2XFD** is for the Sound that will be heard when playing at lower velocities, while **2OF2XFD** is for the Sound that will be heard when playing at higher velocities. The curves are designed to cross fade into each other to create a smooth transition between the two sounds.

1OF3XFD, **2OF3XFD**, and **3OF3XFD** are designed to be used together when you want to switch between three Sounds using velocity, going from lower velocity to higher velocity.

1OF4XFD, **2OF4XFD**, **3OF4XFD** and **4OF4XFD** are designed to be used together when you want to switch between four Sounds using velocity.

With a setting of **MAXIMUM**, the Sound will respond as if you are playing at the maximum velocity at all times. With a setting of **MINIMUM**, the Sound will respond as if you are playing at the minimum velocity at all times.

Setting the Aftertouch Volume Depth

Button: [EDIT] [80 AMP/RANGE]
Page: 2
Parameter: AFTCH>AMP (-99 to +99)

This sets how much aftertouch affects the Sound level, or amplitude. At positive values, applying aftertouch makes the sound louder. At negative values, it makes the sound softer.

TIP: Some of the Velocity Curves are designed to be used in sets to allow a different Sound to play depending on how hard the keyboard is played.

TIP: Most Sounds use the LINEAR velocity curve.

TIP: Many of the internal samples are already "velocity-switching", meaning that there is actually more than one sample per note. These samples usually have "V" or "Velo" in their names.

NOTE: Notes played at maximum velocity might not have enough "headroom" available for a positive aftertouch amplitude swell. Try playing softly while experimenting with this parameter.

Setting the Amplitude LFO Amount

Button: [EDIT] [80 AMP/RANGE]
Page: 3
Parameter: A-LFO>AMP (-99 to +99)

This sets how much the Amplitude LFO affects the level. Higher values increase the amount of amplitude LFO modulation. Negative values flip the LFO phase.

NOTE: If you hear no change when you alter this parameter, experiment with the Amp LFO Functions on button [8]. You may get a more pronounced effect if you use a negative setting for Amp LFO Depth.

Setting the Lower Keyboard Limit

Button: [EDIT] [80 AMP/RANGE]
Page: 4
Parameter: LoLim (C2 000 to G8 127)

This specifies the lowest note of the Sound's keyboard range. Each Sound can be restricted to a specific range of the keyboard. This allows you to create splits and layers across the keyboard.

TIP: You can set the upper or lower limit when you're on these pages by holding [80] and tapping a key on the keyboard.

Setting the Upper Keyboard Limit

Button: [EDIT] [80 AMP/RANGE]
Page: 5
Parameter: HiLim (C2 000 to G8 127)

This specifies the highest note of the Sound's keyboard range.

TIP: By setting the lower limit above the high limit, you can create a "hole in the middle" effect. This makes the Sound appear to have two zones. All notes from the bottom of the keyboard to the high limit note will play, and all notes from the lower limit note to the top of the keyboard will play.

Setting the Sound Overlap Amount

Button: [EDIT] [80 AMP/RANGE]
Page: 6
Parameter: Snd Overlap (00 to 99)

This determines how much notes of the same pitch are allowed to overlap. This occurs if you hold the sustain pedal down and play the same note over and over. When the value is set to **99**, each voices is allowed to play through to its entire release stage. At **00**, the release stage is shortened, cutting off previous notes.

NOTE: If you have Sound Overlap set to 99 and play the same note while holding the sustain pedal, you will run through all 64 voices in no time. By adjusting the Sound Overlap to a lower value, you ensure there are voices available to play other sounds.

The Pitch Envelope Function [90 PITCH ENVELOPE]

The Pitch Envelope (button [90]) changes the pitch of a note over time. It is typically used in special-effect synthesizer programs, but it may also be used to simulate the characteristic of some instruments to go sharp on the initial attack, when played hard. See below for the envelope parameters.

NOTE: The Pitch Envelope parameters will have an effect only if the PITCH ENVELOPE DEPTH (on Page 7 of the PITCH function) is set to a value other than 0, or if Pitch Envelope is a source in the MOD function.

The Filter Envelope Function [100 FILTER ENVELOPE]

The Filter Envelope (button [100]) changes the tonal quality of a note over time by controlling the filter frequency. For example, you can use it to make the initial attack of a note bright and the sustaining part dark. See below for the envelope parameters.

NOTE: The Filter Envelope parameters will have effect only if the FILTER ENVELOPE DEPTH (on Page 7 of the FILTER function) is set to a value other than 0, or Filter Envelope is a source in the MOD function.

NOTE: The Filter Envelope may have no effect if some other modulation source, or the basic setting of the filter, has already pushed the filter cutoff frequency to its maximum

TIP: For the most effective Filter Envelope sweeps, leave the Amplitude Envelope Sustain level at maximum (99) and control the shape of the Sound entirely with the Filter envelope..

The Amplitude Envelope Function [110 AMP ENVELOPE]

The Amplitude Envelope (button [110]) determines the volume of the note over time. For example, it determines whether the note fades in slowly or starts abruptly. Unlike the Pitch and Filter Envelopes, the Amp Envelope is always fully active. See below for the envelope parameters.

TIP: Some Programs may leave the Amp Envelope fully open, and provide attack and decay using the Filter Envelope.

Setting Envelope Parameters

The following parameters apply to the Pitch, Filter and Amplitude Envelopes.

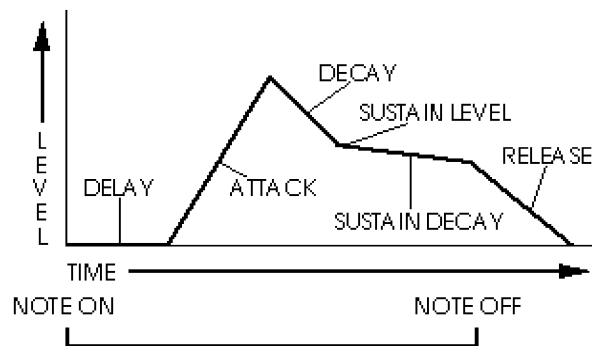

Setting the Envelope Attack Time

Buttons: [EDIT] [90]-[110]
Page: 1
Parameter: Attack (00 to 99)

This sets the amount of time the envelope will take to reach its maximum level. The higher the value, the slower the attack.

Setting the Envelope Decay Time

Buttons: [EDIT] [90]-[110]
Page: 2
Parameter: Decay (00 to 99)

This sets the amount of time the envelope takes from the end of the Attack stage to reach the Sustain level. The higher the value, the longer it will take.

Setting the Envelope Sustain Level

Buttons: [EDIT] [90]-[110]
Page: 3
Parameter: Sustain (00 to 99)

This sets the level that the envelope will reach after the Decay time.

Setting the Envelope Release Time

Buttons: [EDIT] [90]-[110]
Page: 4
Parameter: Release (00 to 99, HOLD - Pitch Envelope only)

This sets the amount of time the envelope will take to get from its current level to zero after the note is released. The higher the value, the longer it will take.

When set to **HOLD**, the Pitch Envelope will remain where it is after the note is released.

Setting the Envelope Delay Time

Buttons: [EDIT] [90]-[110]
Page: 5
Parameter: Delay (00 to 99, HOLD)

This is the amount of time the envelope will wait before doing anything. When the delay is set to zero, the envelope begins its attack right away.

When set to **HOLD**, the Delay stage of the envelope will wait until the key is released before running through the remaining envelope stages. In addition, the Envelope's Trigger behavior will be automatically set to FREERUN (see below). The displayed value of that parameter is not changed; only its behavior is.

Setting the Envelope Sustain Decay Time

Buttons: [EDIT] [90]-[110]
Page: 6
Parameter: Sus Decay (00 to 99)

This sets the amount of time the envelope will take during the sustain stage to go down to zero. If this is set to **99**, the envelope will remain at the Sustain level until the note is released. When set to **00**, the envelope's level will immediately jump to 0 upon reaching the sustain stage.

Setting the Envelope Trigger Type

Buttons: [EDIT] [90]-[110]
Page: 7
Parameter: Trig (NORMAL, FREERUN, RESET, RES-FRE)

This determines how the envelope will start and stop based on how the keys are held and released.

When set to **NORMAL**, the envelope will play from the attack stage through to the sustain stage as long as the note is held. When the note is released, the envelope will jump to its release stage.

When set to **FREERUN**, the envelope will complete its entire cycle, even if the note is released before the envelope has completed its cycle.

When set to **RESET**, the envelope will start at the beginning whenever a new note is played.

When set to **RESET-FREERUN**, the envelope will start at the beginning whenever a new note is played and it will complete its entire cycle, even if the note is released in the middle.

NOTE: In NORMAL and FREERUN modes, when a voice is stolen by a new note, the envelope will not start from the beginning, but will continue from its current level.

TIP: If you don't want the envelope to re-trigger when playing legato, set the Keyboard Mode to MONO and the envelope trigger mode to NORMAL.

TIP: To get the most natural-sounding Sustain Pedal reaction, the best setting for the Filter Envelope Trigger Mode is usually either the FREERUN or the RESET-FREERUN mode. This allows the Filter to keep following its envelope shape even after the keys are lifted up.

Activating Envelope Key Tracking

Buttons: [EDIT] [90]-[110]
Page: 8
Parameter: Time Track (ON or OFF)

This determines whether keyboard position affects the speed of the envelope. When **ON**, playing toward the higher end of the keyboard will result in a faster envelope cycle.

This only affects the decay, sustain decay and release segments of the envelope. The envelope's timing doubles or halves over a range of two octaves.

Activating the Sustain Pedal

Buttons: [EDIT] [90]-[110]
Page: 9
Parameter: SustainPed (ON or OFF)

This determines whether the Sustain Pedal will affect the envelope.

Setting the Envelope Level

Buttons: [EDIT] [90]-[110]
Page: 10
Parameter: Env Level (00 to 99)

This sets the level of the envelope. At **99** the envelope will have a maximum effect on whatever it is being routed to.

NOTE: If the Env Level is already at 99, a positive value for VEL>Level will have no effect because it is already "maxed-out". To hear the full effect, the sum of the Env Level and VEL>Level values should not exceed 99.

Setting Velocity Modulation of the Envelope

Buttons: [EDIT] [90]-[100]
Page: 11
Parameter: VEL>Level (00 to 99)

It determines how keyboard velocity will affect the Pitch or Filter envelope level. When set to **99**, notes played hard will deliver a higher envelope output than notes played soft.

NOTE: This setting is not available on the Amplitude Envelope because there is a more specific velocity curve setting in the AMP/RANGE function.

Naming the Program [120 NAME]

The Name function (button [120]) allows you to change the Program's name. Use the [PAGE] buttons to position the cursor. Here is a chart of available characters:

	!	"	#	\$	%	&	'	()	*	+	,	-	.	/	0	1	2	3
4	5	6	7	8	9	:	;	<	=	>	?	@	A	B	C	D	E	F	G
H	I	J	K	L	M	N	O	P	Q	R	S	T	U	V	W	X	Y	Z	[
¥]	^	_	`	a	b	c	d	e	f	g	h	i	j	k	l	m	n	o
p	q	r	s	t	u	v	w	x	y	z	{		}	>	<				

Copying Sound Layers [STORE]

While editing a Program, it is helpful to be able to copy a Sound layer to another Sound in either the same Program or a different Program, especially if you are building a split or layered Program. Here's how:

- 1) From Program Edit mode, press [STORE].
- 2) Press [PAGE >] once to select the Copy Sound function.
- 3) Use the [VALUE] buttons to select the source for the copy. You can choose either a Sound in the current Program, or different Program. (If you choose a different Program, the Sound layer to be copied will be determined by your destination choice).
- 4) Press [PAGE >] again to advance the cursor to the lower line of the display.
- 5) Use the [VALUE] buttons to choose a destination. Depending on the choice you made in step 3, you will be able to choose either a Sound layer, or a Program number.

If you selected a Program number in the top line, you'll only be able to select Sounds 1-4 as the destination Sound. Keep in mind that your choice here will also determine which Sound will be copied from the Program number you chose in the top line.

If you selected one of the current Program's four Sounds in the top line, you'll be able to select any of the other three Sounds in the current Program or one of the Programs in the User Bank (000-127). The Sound number in the top line determines the target Sound within the User Program you chose.

- 6) Press [STORE] to copy the Sound.

Auditioning Programs Before Storing

When it's time to store your Program, you may need to "look around" to find a Program that you don't need anymore so you can overwrite it.

To do this, you can take advantage of the fact that you can move between Program Mode and Mix Mode without losing your changes. So, to find a new location to store your edited Program, jump into Mix Mode, search for a Program you can overwrite there, then jump back into Program Mode and store the Program.

NOTE: The way to tell the difference between a program edited in Program Mode and one edited from Mix Mode is by looking at the display: in Program Edit Mode, "PROG EDIT" appears in the lower-left corner of the display, while in Mix Program Edit Mode, "MIXPROG EDIT" appears.

The Mod Routes

As we mentioned in the previous chapter, **modulation** refers to modifying some aspect of a sound. For example, sound volume is shaped (or modulated) by the Amplitude Envelope. A **Mod Route** refers to a modulation source and the destination that it is modulating.

In the previous chapter, we've already covered some of the "hard wired" mod routes. One example is the Pitch LFO, which can always be used to modulate pitch. In addition however, there are six general-purpose mod routes that have many more possible mod sources and destinations.

Using these, you can:

- Use a slider to control brightness, effect level, LFO speed, etc.
- Use velocity to increase the attack speed of an envelope, so playing softly makes the sound fade in, while playing hard causes an immediate attack.
- Use release velocity to decrease the release time of an envelope, so quick releases of the keys cut off the end of the sound, while slow key releases allow the sound to fade away gradually.

Hard Wired Mod Routes

One way to extend the power of your Mod section is to be sure you're not routing something with a Mod that could be handled elsewhere in the QS's functions. Here's a list of routings that are "hard wired" into the QS:

Source	Destination	Button	Page
Aftertouch	Amplitude	[80 AMP/RANGE]	2
	Amplitude LFO Depth	[8 AMP LFO]	7
	Filter Frequency	[70 FILTER]	5
	Filter LFO Depth	[7 FILTER LFO]	7
	Pitch	[60 PITCH]	5
	Pitch LFO Depth	[6 PITCH LFO]	7
Amplitude LFO	Amplitude	[8 AMP LFO]	5
Filter Envelope	Filter Frequency	[100 FILTER ENV]	10
Filter LFO	Filter Frequency	[7 FILTER FREQ]	5
Mod Wheel	Amplitude LFO Depth	[8 AMP LFO]	6
	Filter Frequency	[70 FILTER]	4
	Filter LFO Depth	[7 FILTER LFO]	6
	Pitch LFO Depth	[6 PITCH LFO]	6
Note Number	Envelope Time Tracking	[90-110 P/F/AENV]	8
	Filter Frequency	[70 FILTER]	2
Pitch Envelope	Pitch	[90 PITCH ENV]	10
Pitch LFO	Pitch	[6 PITCH LFO]	5
Pitch Wheel	Pitch	[60 PITCH]	4
Velocity	Filter Envelope Level	[100 FILTER ENV]	11
	Filter Frequency	[70 FILTER]	3
	Pitch Envelope Level	[90 PITCH ENV]	11



Editing the Mod Routes

The Mod Routes are part of each Program, just like any other program parameter (like Filter Frequency for example). Hit [EDIT] from Program mode to begin editing.

Selecting a Mod Route [0-5 MOD]

In Program Edit Mode, use the [0] - [5] buttons to select one of the six mod routes to edit. All modulators work in the same way, so only the pages of one will be described here.

When you're in one of the Mod pages, the top line of the display will show whether that Mod is active. If the Mod is disabled (Level set to 00), "mod" will be in small letters. If the Mod is enabled, "MOD" will be capitalized.

Choosing the Mod Source

Buttons: [EDIT] [0-5 MOD]
Page: 1
Parameter: Src (see below)

Here, you can select one of the following modulation sources:

- **NOTE #** provides a modulation signal that corresponds to the note played on the keyboard (higher keys give higher values).
- **VELOCITY** refers to how hard you hit the keys.
- **REL VEL** (Release Velocity) refers to how fast you let go of the keys.
- **AFT TCH** (Aftertouch) Pressing on the keys after they're down generates this control signal. This represents an average of all keys being pressed. The harder you press on the keys, the greater the degree of modulation. (Note, the QS8.2's keyboard does not generate aftertouch, but the synthesizer can still respond to MIDI aftertouch messages).
- **POLYPRES** (Polyphonic Pressure) is similar to aftertouch, but each key can respond to individual pressure messages. Although the QS's keyboard does not generate poly pressure, its sound generators can respond to MIDI poly pressure messages.
- **MOD WHL** (Modulation Wheel) is traditionally assigned to LFO level so that rotating the wheel away from you introduces vibrato. However it is also well-suited for controlling timbre, vibrato speed, and other parameters.
- **PITCH WH** (Pitch Wheel) usually controls the oscillator pitch but can control other parameters.
- **MIDI VOL** corresponds to MIDI controller #7. Example: Assign the filter cutoff as the destination, and you can have the signal become less bright as it becomes lower in volume.
- **SUST PED** (Sustain Pedal) The sustain pedal plugged into the sustain pedal jack provides this modulation signal.
- **PEDAL 1:** A controller pedal plugged into the [PEDAL 1] jack provides this modulation source. The default setting assigns Pedal 1 to MIDI Controller 7 to act as a volume pedal. But it can also be assigned to any other incoming MIDI controller number in Global page 12.

- **PEDAL 2:** Although there is no Pedal 2 jack on the QS, it is available as a modulation source via MIDI controller messages. The Pedal 2 modulation source defaults to MIDI Controller #4 (Standard Foot Controller). It is possible to assign it to a different controller number if you wish on Global Mode, page 13.
- **PLFO/FLFO/ALFO:** You can select the Pitch, Filter and Amplitude LFOs as modulation sources, even if they aren't being used to affect the Sound in their usual ways.
- **PENV/FENV/AENV:** The Pitch, Filter and Amplitude envelopes can also be selected as modulation sources. Try routing them to LFO speeds or the Effect Send Level of a Sound.
- **RANDOM:** This provides a different modulation value every time you hit a key. Example: With vintage analog synth patches, use pitch as the destination and apply a very slight amount of random modulation. Each note will have a slightly different pitch, which simulates the natural tuning instability of analog circuits.
- **TRIGATE:** This is the Trigger Rate Follower, which monitors how fast notes are being played on the keyboard. For example, if routed to the Effect send of a Program, you could automatically have more effect when playing quickly, and less effect when playing slowly.
- **CNTRL (A, B, C, D):** These are the four [CONTROLLER] sliders on the front panel. Since these sliders also have MIDI controller numbers assigned to them, they can be remotely controlled via MIDI. The MIDI controller numbers are assigned in Global page 8-11.
- **TRACKGEN:** This is the output of a signal processed by the Tracking Generator module.
- **STEPTRAK:** This is the output of a signal processed by the Tracking Generator module in stepped mode.

Choosing the Mod Destination

Buttons: [EDIT] [0-5 MOD]
Page: 2
Parameter: Dst (see below)

Here, you can select from the following modulation destinations. You can find out more about these parameters and how they affect the sound in their respective sections:

- Pitch
- Filter Frequency
- Amplitude
- Effect Send
- Pitch LFO Speed
- Pitch LFO Amp
- Pitch LFO Delay
- Pitch Envelope Delay
- Pitch Envelope Attack
- Pitch Envelope Decay
- Pitch Envelope Sus. Decay
- Pitch Envelope Release
- Pitch Envelope Amp
- Filter LFO Speed
- Filter LFO Amp
- Filter LFO Delay
- Filter Envelope Delay
- Filter Envelope Attack
- Filter Envelope Decay
- Filter Envelope Sus. Decay
- Filter Envelope Release
- Filter Envelope Amp
- Amp LFO Speed
- Amp LFO Amp
- Amp LFO Delay
- Amp Envelope Delay
- Amp Envelope Attack
- Amp Envelope Decay
- Amp Envelope Sus. Decay
- Amp Envelope Release
- Amp Envelope Amp
- Portamento Rate

TIP: If you want to modulate the pitch or filter Envelope Level positively, set the Envelope Level to zero so you have room to modulate. For the amplitude envelope, set the level to 01. Similarly, if you want to modulate any Envelope Level negatively, set the Envelope Level to 99.

NOTE: When negatively modulating the amplitude envelope, make sure the negative modulation amount is not greater than the Aenv Level setting. For example: If your Aenv Level is at 59 and you have Controller A routed to AENV AMP with a mod amount of -60, any note held down when Controller A reaches its maximum throw will be considered "off" and will be unable to be pulled back up by Controller A. You'll have to re-trigger the note.

NOTE: When Portamento Rate is chosen as a destination, you will hear no change in that parameter unless it is at least set to 01.

Setting the Mod Level

Buttons: [EDIT] [0-5 MOD]
Page: 3
Parameter: Level (-99 to +99)

This sets the modulation level. At zero, the modulation source has no effect on the destination (it is disabled). Higher positive values increase the amount of modulation in the positive direction. Negative values increase the amount of modulation in the negative direction.

In other words, if you choose Controller A as your source and Pitch as your destination, a value here of **+99** will cause the pitch to rise as slider A moves up. A value of **-99** will lower the pitch as slider A moves up.

NOTE: When modulating Pitch, a Mod level of +72 or -72 will give exactly one octave of modulation at maximum input.

Turning On the Mod Gate

Buttons: [EDIT] [0-5 MOD]
Page: 4 (Mods 1-3 only)
Parameter: Gated (ON or OFF)

This determines whether the modulator will be active after keys are released. When the gate is **ON**, the Modulator will only be active while notes are being held. The effect of the Modulator will stop when you are not playing any notes. This function is available only in mod routes 1 through 3.

TIP: This can be used on sounds with long release times, where an effect (like tremolo) is intended to be active while holding notes down, but deactivated as the sound is fading away after being released. Or if you're using the Sustain pedal, you can have vibrato present until the keys are released.

Turning On Quantization

Buttons: [EDIT] [0-5 MOD]
Page: 4 (Mods 4-6 only)
Parameter: Quant (ON or OFF)

This determines whether the modulator will modulate in a smooth fashion, or a stepped (quantized) fashion. When it is **ON**, the modulation effect will be stepped. When **OFF**, the effect will be smooth. This function is only available in mod routes 4 through 6.

TIP: If the Modulation Wheel is routed to Pitch with an amplitude of +99, moving the Mod Wheel with the Quantize parameter ON will cause the pitch to rise in half-step increments.

The Pitch LFO Function [6 PITCH LFO]

The Pitch LFO function is most often used to apply vibrato to a Sound. See below for the LFO parameters.

NOTE: The Pitch LFO parameters will make a difference in the sound only if the PITCH LFO DEPTH (on Page 6 of the PITCH function) is set to a value other than 0, or, if the Pitch LFO is a source in the MOD function.

The Filter LFO Function [7 FILTER LFO]

The Filter LFO function is most often used to apply tremolo-like or "wah-wah" effects to a sound. See below for the LFO parameters.

NOTE: The Filter LFO parameters will affect the sound only if the FILTER LFO DEPTH (on Page 6 of the FILTER function) is set to a value other than 0, or, if Filter LFO is a source in the MOD function.

The Amplitude LFO Function [8 AMP LFO]

The Amp LFO function is usually used to add tremolo to a sound. See below for the LFO parameters.

NOTE: The Amp LFO parameters will have an effect only if the AMP LFO DEPTH (on page 3 of the AMP/RANGE function) is set to a value other than 0, or if Amp LFO is a source in the MOD function.

Setting LFO Parameters

The following parameters apply to the Pitch, Filter and Amplitude LFOs described above.

Selecting the LFO Waveform

Buttons: [EDIT] [6-8]
Page: 1
Parameter: Wave (8 choices)

The waveform determines the shape of the LFO. Note that the two Sawtooth waves, the Square and the Random+ waves are unipolar (positive-going only) and the rest are bipolar (positive and negative going):

TIP: The "unipolar" (positive-going) waveshapes tend to have a more noticeable impact on Filter and Amplitude if they are routed negatively.

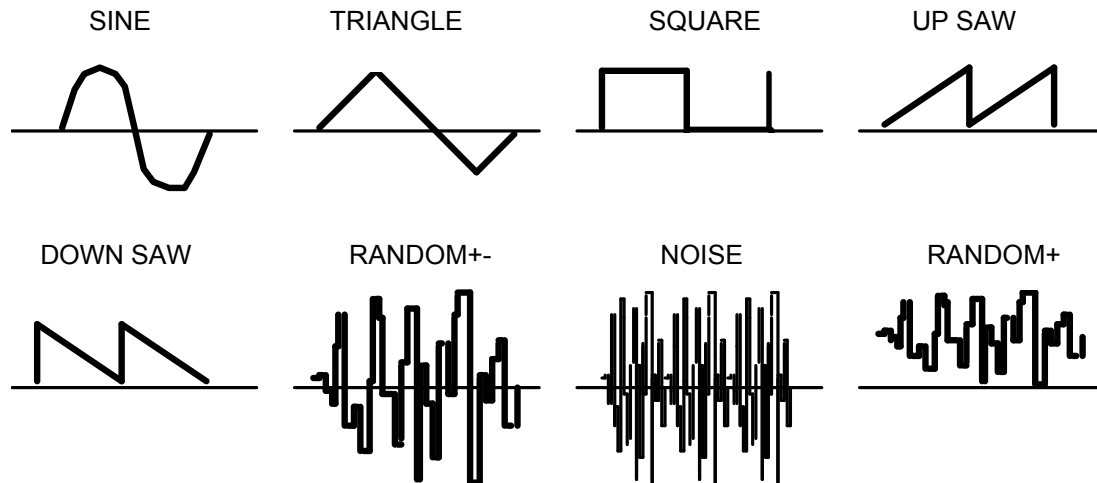

Setting the LFO Speed

Buttons: [EDIT] [6-8]
Page: 2
Parameter: Speed (00 to 99)

This controls the speed of the LFO. The higher the value, the faster the waveform.

Setting the LFO Delay

Buttons: [EDIT] [6-8]
Page: 3
Parameter: Delay (00 to 99)

This sets the amount of time it takes the LFO to fade in from no modulation to maximum modulation. The higher the value, the more slowly the LFO fades in.

Setting the Trigger Type

Buttons: [EDIT] [6-8]
Page: 4
Parameter: Trigger
Range: MONO, POLY, KEYMONO, or KEYPOLY

This determines how each voice's LFO should be started. When playing multiple voices in a single Sound, each voice has its own LFO. The Trigger parameter determines whether or not they should be in sync, and whether or not they can be re-triggered independently from one another.

NOTE: Some modulation sources are by their very nature polyphonic (for example, velocity or envelope). You will be allowed to set up such Mod routings when the Trigger mode is set to MONO, but you won't hear any modulation of the LFO speed

MONO. All voices' LFOs will be in sync with each other.

POLY. Each voice's LFO is independent. If you hold a chord, some voices' LFOs will be moving in one direction while others move in the other direction. If the LFO Speed is being modulated (by one of the envelopes, for example), the LFOs of each voice may be running at different speeds.

KEYMONO. This is identical to MONO, but whenever a new note is played, the LFO is re-triggered, instead of continuing from wherever it may be in its cycle.

KEYPOLY. This is identical to POLY, but whenever a new note is played, the LFO is re-triggered, instead of continuing from wherever it may be in its cycle.

Setting the LFO Level

Buttons: [EDIT] [6-8]
Page: 5
Parameter: Level (00 to 99)

This is the base output level of the LFO. If you want to have a constant value of vibrato, even without using the Mod Wheel or Aftertouch, set LEVEL above 00. The Mod Wheel and Aftertouch can add to or subtract from this base level.

NOTE: For example, if Level is set to 10 and the Mod Wheel parameter (see the next parameter) is set to 10, there will always be some vibrato, and raising the Mod Wheel will add more vibrato. On the other hand, if the Mod Wheel parameter is set to -10, raising the Mod Wheel to the top will cancel out all vibrato.

Mod Wheel LFO Depth

Buttons: [EDIT] [6-8]
Page: 6
Parameter: MODWH>LFO (-99 to +99)

This sets how much the Mod Wheel will increase or decrease the LFO's Level. A positive value raises the level when the Mod Wheel is moved up. Negative values will lower the level of the LFO as the Mod Wheel is raised.

NOTE: Since the output level of the LFO cannot be less than zero, a negative setting of the Mod Wheel parameter will have no effect unless there is LFO already occurring.

Aftertouch LFO Depth

Buttons: [EDIT] [6-8]
Page: 7
Parameter: AFTCH>LFO (-99 to +99)

This parameter sets how much the Aftertouch will increase or decrease the LFO's Level. A positive value raises the level as more Aftertouch is applied. A negative value lowers the level as more Aftertouch is applied.

Scaling Modulation Sources [9 TRACK GEN]

The **Tracking Generator** (TG) is used to scale a modulation source. For example, normally you could modulate the volume of a sound using velocity; the harder you play, the louder the sound gets. The amount of change in volume is equal to the change in velocity; this is called linear control. If instead, however, you set the Tracking Generator's input to "velocity", and then routed the Tracking Generator to the Amp (using the Mod function), you can make your own customized velocity curve!

It might be helpful to think of the Tracking Generator as a fifth page available to the Mod function. When you choose it as your source on the first page of a Mod (let's say button [0], or Mod 1), you then need to go select the TG's input on button [9], page 1. In effect, the TG's input is its "Mod source", and the TG itself becomes a sort of "Mod destination". Modulation input is basically filtered through the TG before it reaches the actual Mod destination on page 2 of Mod 1.

The Tracking Generator divides the range of the input into 11 points (0-10), each of which can be set between 0 and 100. If you boost the value of one of the lower points, you make the input more sensitive in its lower register. By creating a non-linear curve using the velocity example above, you can scale the velocity's control over the sound's volume just the way you want.

When selecting the Tracking Generator as a modulation source in the Mod Function, two choices will be available (TRACKGEN and STEPTRAK). When TRACKGEN is selected as the modulation source, the Tracking Generator functions normally, scaling its input as determined by its parameter settings.

When STEPTRAK is selected as a modulation source, the Tracking Generator's output will be stepped, or interpolated. This means that instead of scaling the input in a linear fashion from point to point, the input is kept at each point's value setting until it goes beyond the following point's value setting, at which point it jumps to that setting. This feature is very useful in creating "mini-sequences" if the modulation destination is set to PITCH and the Tracking Generator's input is an LFO using an "Up Sawtooth" as its waveform. The HipHop and EuroDance QCards contain many examples of this extremely cool usage of the Tracking Generator.

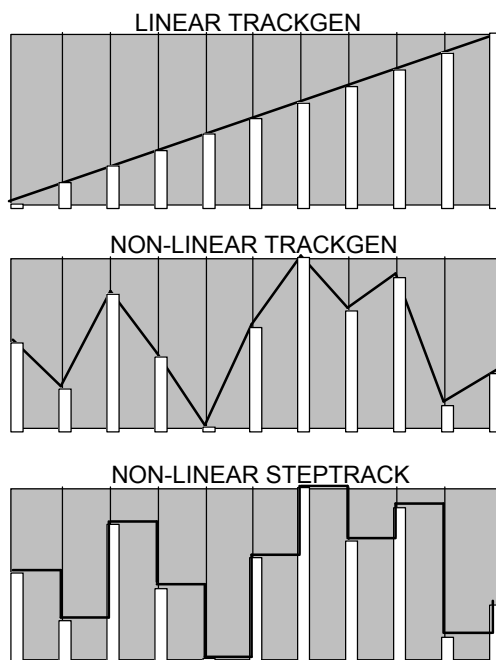

TIP: The Tracking Generator can be used to turn a variable control, such as the Mod Wheel or velocity, into a switch by setting all of the points to 0 except for point 10. Only near the maximum input will anything other than 0 come out of the Tracking generator.

Selecting the Tracking Generator Input

Button: [EDIT] [9 TRACK GEN]
Page: 1
Parameter: Input (see below)

Select the input of the Tracking Generator from the following sources:

- Note Number
- Velocity
- Release Velocity
- Aftertouch
- Poly Pressure
- Mod Wheel
- Pitch Wheel
- MIDI Volume
- Sustain Pedal
- Pedal 1
- Pedal 2
- Pitch LFO
- Filter LFO
- Amp LFO
- Pitch Envelope
- Filter Envelope
- Amp Envelope
- Random
- Trig Rate
- Controllers A–D

For detailed descriptions of each of these sources, see the section “Modulation Source” in the Mod section.

Setting a Tracking Point

Button: [EDIT] [9 TRACK GEN]
Pages: 2-12 (for points 0-10)
Parameter: Input (00 to 100)

The remaining pages of the TRACK GEN function control the levels of the tracking points 0-10. Select the various Points with the [PAGE] buttons, and change the values in the usual ways. A higher number increases the impact that Point will have on whatever the Mod destination is.

TIP: You can create your own custom velocity curves using the Tracking Generator and the Mod section. It's easier to do this if you start with the MINIMUM velocity curve (under the [AMP/RANGE] function). Then select an available Mod (say Mod 1), and on page 1 select TRACKGEN as your source. On page 2 select Amplitude as your destination, and then set the level to +99 on page 3. On button [9], page 1, select Velocity as your Input and then experiment with the ways different numbers affect the velocity response as you input values for Points 0-10.

Drum Mode

Drum Mode allows you to construct your own drum kits within a Program. Any one or all of the four Sound layers in a Program can be put into Drum Mode.

In Drum Mode, you can select 10 drum samples per Sound and individually control their pitch, level, panning, effects routings, and placement on the keyboard. You can choose from a collection of 343 samples: 21 kicks, 26 snares, 33 toms, 43 cymbals, 75 percussion instruments, 82 sound effects and 63 synth waves. Plus, there are 90 rhythm beats to choose from (pre-sequenced drum loops). If all four Sounds in a Program were placed in Drum Mode, you could assemble up to 40 tailor-made drum sounds in your kit. To round things out, individual drums can be stretched to occupy up to four consecutive keys without transposing (for more realistic flams).

Editing in Drum Mode

To edit a sound in Drum Mode, start from Program mode and hit [EDIT]. Select a Sound layer by pressing one of the [00] through [30] buttons.

Next, hit [40 VOICE] and page over to the Snd Type parameter (page 2). Use the [VALUE] buttons to select DRUM for the sound type.

Notice that the “SND1” text in the upper left corner changes to “S1D1”, indicating that you’re editing Sound layer 1, Drum 1 in Drum Mode (or whichever Sound layer you selected).

NOTE: When Drum Mode is enabled, the Sound will have fewer parameters for editing. Consequently, not all Function buttons will respond when pressed as they do when the Sound is in Keyboard mode. Specifically, the LFOs and all Envelopes (with the exception of the Amp Envelope) are unavailable. In addition, the parameters in most other functions will differ.

Selecting a Drum to Edit [0-9 DRUM]

The [0] - [9] buttons are used to select a Drum (1-10) to edit. You can select which Drum you are editing at any time, from any display page in Drum Edit Mode.

TIP: Here’s a quick way to select the Drum you’d like to edit: If it is on Sound 1, hold down the [00] button and hit the key the Drum is on. If the Drum is on Sound 3, use the [20] button and hit the key.

Selecting the Drum Sample [40 VOICE]

The Voice function (button [40]) is where you choose the particular sample for the selected Drum (1-10). Similar to the normal Assign Voice function, sounds are divided into groups. After selecting the group (on display page 3), you then select the sample within the group (on page 4).



Here is a chart listing the various drum samples in their respective groups.

Group	Voice
Kick	FloppyKik1, FloppyKik2, FloppyKikV, MasterKik1, MasterKik2, MasterKikV, MetalKick1, MetalKick2, MetalKickV, GrooveKik1, GrooveKik2, GrooveKikV, Sharp Kick, Tek Kick 1, Tek Kick 2, Tek Kick V, AnalogKik1, AnalogKik2, AnalogKik3, AnalogKikV, Rap Kick
Snare	Fat Wood 1, Fat Wood 2, Fat Wood V, HR Snare 1, HR Snare 2, HR Snare V, MasterSnr1, MasterSnr2, MasterSnrV, Piccolo 1, Piccolo 2, Piccolo V, Electronc1, Electronc2, ElectroncV, Rap Snare1, Rap Snare2, Tek Snare1, Tek Snare2, Tek SnareV, Brush Hit1, Brush Hit2, Brush HitV, Crosstick1, Crosstick2, CrosstickV
Toms	HiRackTom1, HiRackTom2, HiRackTomV, MdRackTom1, MdRackTom2, MdRackTomV, LoRackTom1, LoRackTom2, LoRackTomV, HiFlrTom 1, HiFlrTom 2, HiFlrTom V, MidFlrTom 1, MidFlrTom 2, MidFlrTom V, LowFlrTom1, LowFlrTom2, LowFlrTomV, CanonTomH1, CanonTomH2, CanonTomHV, CanonTomM1, CanonTomM2, CanonTomMV, CanonTomL1, CanonTomL2, CanonTomLV, Hex Tom Hi, Hex Tom Md, Hex Tom Lo, RapTomHi, RapTomMid, RapTomLow
Cymbal	ClosedHat1, ClosedHat2, ClosedHatV, Tight Hat, Loose Hat, Slosh Hat, Foot Hat 1, Foot Hat 2, Velo Hat 1, Velo Hat 2, Velo Hat 3, TekHatClsd, TekHatOpen, RapHatClsd, RapHatHalf, RapHatOpen, CricktHat1, CricktHat2, FilterHat1, FilterHat2, FilterHat3, Ride Cym, Ride Cym 2, RideCym V1, RideCym V2, RideBell 1, RideBell 2, RideBell V, Crash Cym1, Crash Cym2, SplashCym1, SplashCym2, SplashCym3, China Cym1, China Cym2, RapCymbal1, RapCymbal2, RapCymWave, Open Hat 1, Open Hat 2, Open Hat 3, Open Hat V, RideCym V3
Percus	Agogo Hi, Agogo Low, Bongo Hi, Bongo Low, Brake Drum, Cabasa, Castanet, Chimes 1, Chimes 2, Clap Rap, Clap Tek, Clave, Conga Hi, Conga Low, Conga Slap, RapCongaHi, RapCongaMd, RapCongaLo, Rap Rim, Rap Tone, Cowbell, RapCowbell, Cuica, Djembe Hi, Djembe Low, Drumstix, FingerSnap, Guiro Long, Guiro Med, GuiroShort, Ice Block, Kalimba Hi, KalimbaLow, Maracas, SambaWhstl, SambaShort, Shaker1 Hi, Shaker1Low, Shaker2 Hi, Shaker2Low, Sleighb1 1, Sleighb1 2, SteelDrmHi, SteelDrmLo, TablaGa Hi, TablaGaLow, Tabla Ka, TablaNa Hi, TablaNaLow, Tabla Te, TablaTinHi, TablaTinLo, Taiko Hi, Taiko Low, Taiko Rim, Talk Up Hi, Talk Up Lo, TalkDownHi, TalkDownLo, Tambourin1, Tambourin2, Timbale Hi, TimbaleLow, Timpani Hi, TimpaniMid, TimpaniLow, Triangle, TriangleSf, Udu Hi, Udu Mid, Udu Low, Udu Slap, Vibrasmack, WoodBlokHi, WoodBlokLo
Snd FX	Bird Tweet, Bird Chirp, Bird Loop, Fret Noise, Fret Wipe, Orch Hit, Dance Hit, Jungle 1, Jungle 2, Applause, GoatsNails, Brook, Hi Bow, Low Bow, ShapeNzHi, ShapeNzMid, ShapeNzLow, ScrtchPull, ScrtchPush, ScrtchLoop, ScrtchPILp, ScrtcPshLp, RezAttkHi, RezAttkMid, RezAttkLow, RezZipHi, RezZipMid, RezZipLow, Zap 1 Hi, Zap 1 Mid, Zap 1 Low, Zap 2 Hi, Zap 2 Mid, Zap 2 Low, Zap 3 Hi, Zap 3 Mid, Zap 3 Low, FltrNzLoop, Romscape, Rain, Telephone, Sci Loop 1, Sci Loop 2, Sci Loop 3, Bit Field1, Bit Field2, Bit Field3, Bit Field4, Bit Field5, Bit Field6, WavLoop1.0, WavLoop1.1, WavLoop1.2, WavLoop1.3, WavLoop1.4, WavLoop1.5, WavLoop1.6, WavLoop1.7, WavLoop1.8, WavLoop2.0, WavLoop2.1, WavLoop2.2, WavLoop2.3, WavLoop2.4, WavLoop2.5, WavLoop2.6, WavLoop2.7, WavLoop2.8, WavLoop3.0, WavLoop3.1, WavLoop3.2, WavLoop3.3, WavLoop3.4, WavLoop3.5, WavLoop4.0, WavLoop4.1, WavLoop4.2, WavLoop4.3, WavLoop4.4, WavLoop4.5, D-Scrape, D-ScrapeLp
Wave	High Sine, Mid Sine, Low Sine, HiWhitNoiz, MidWhitNoiz, LowWhitNoiz, HiSpectral, LoSpectral, HiCrickets, LoCrickets, Inharm 1, Inharm 2, High Saw, Low Saw, High Pulse, Low Pulse, Hi AcidRez, LowAcidRez, Metal Wave, HiMetlMute, LoMetlMute, Hi DistGtr, LowDistGtr, Hi PwrHarm, LowPwrHarm, Hi FunkGtr, LowFunkGtr, Hi MuteGtr, LowMuteGtr, HiElecHarm, LoElecHarm, ClslcHarm, HiBassHarm, MidBassHrm, LowBassHrm, HiSlpBass, LoSlpBass, Hi BassPop, LowBassPop, Muted Bass, Stik Bass, StudioBass, JazzFingrd, JazzPic, Fretless, AcousBass, 60's Combo, Hi Piano, Mid Piano, Low Piano, High Sync, Low Sync, Hi Synth, LowSynth, Ahhs High, Ahhs Mid, Ahhs Low, Oohs High, Oohs Mid, Oohs Low, TunePipeHi, TunePipeMd, TunePipeLo
Rhythm	Psi Beat 1, Psi Beat 2, Psi Beat 3, Psi Beat 4, Psi Beat 5, Psi Beat 6, Psi Beat 7, Psi Beat 8, Psi Beat 9, Psi Beat10, Psi Beat11, Psi Beat12, Kick Loop1, Kick Loop2, Kick Loop3, Kick Loop4, Kick Loop5, Kick Loop6, Kick Loop7, Kick Loop8, Kick Loop9, KickLoop10, KickLoop11, Snare Lp 1, Snare Lp 2, Snare Lp 3, Snare Lp 4, Snare Lp 5, Snare Lp 6, Snare Lp 7, Snare Lp 8, Snare Lp 9, SnareBeat1, SnareBeat2, SnareBeat3, SnareBeat4, SnareBeat5, Back Beat1, Back Beat2, Back Beat3, Back Beat4, Hat1 Clsd1, Hat1 Clsd2, Hat1 Foot, Hat1 Open1, Hat1 Open2, Hat2 Clsd1, Hat2 Clsd2, Hat2 Foot, Hat2 Open1, Hat2 Open2, Hat3 Clsd1, Hat3 Clsd2, Hat3 Open1, Hat3 Open2, Hat Beat 1, Hat Beat 2, Hat Beat 3, Hat Beat 4, Hat Beat 5, Hat Beat 6, Hat Beat 7, Hat Beat 8, Hat Beat 9, Hat Beat10, Agogo, Bongo Loop, CabasaLoop, CastanetLp, CongaLoop1, Shaker Lp1, Shaker Lp2, SleighLoop, Tabla Ga Lp, Tabla Ka Lp, Tabla Na Lp, Tabla Te Lp, TablaTin Lp, Taiko Loop, PercBeat1, PercBeat2, PercBeat3, PercBeat4, VoiceLoop1, VoiceLoop2, Phonic Loop, SpinalLoop, Tri Loop, Tri Loop 2, Orch Loop

The Level Function [50 LEVEL]

Each Sound layer lets you create 10 Drums in Drum Mode. The Level function (button [50]) allows you to control the volume, pan position, output assignment and effects send level for each Drum.

Setting the Drum Volume

Button: [EDIT] [50 LEVEL]
Page: 1
Parameter: Volume (00 to 99)

This sets the volume for the selected Drum.

Setting the Drum Panning

Button: [EDIT] [50 LEVEL]
Page: 2
Parameter: Panning (<3 to 3>)

This sets the panning, from far left (<3) to far right (3>).

Routing Drums to the Outputs

Button: [EDIT] [50 LEVEL]
Page: 3
Parameter: Output (see below)

In the QS6.2, selecting **ON** routes the Sound to the outputs; **OFF** shuts off the path.

In the QS8.2, selecting **MAIN** routes the Sound to the outputs; **OFF** shuts off the path. A setting of **AUX** will also shut off the path. (This is provided for backward compatibility with older QS8 models).

TIP: Regardless of the setting, the Sound may still feed an Effects Send.

Setting the Drum Effects Send Level

Button: [EDIT] [50 LEVEL]
Page: 4
Parameter: FX Level (00 to 99)

This determines how much the drum sound feeds the selected effects Send. See the “Editing Effects” section of this manual for more information.

Selecting the Effects Send

Button: [EDIT] [50 LEVEL]
Page: 5
Parameter: FX Bus (1 to 4)

This selects which effects Bus, or “Send”, the drum sound will feed. See the “Editing Effects” section of this manual for more information.

The Pitch Function [60 PITCH]

The Pitch (button [60]) function lets you transpose the selected Drum up or down one octave, and lets you modulate the Drum's pitch with velocity.

Tuning the Drum Sound

Button: [EDIT] [60 PITCH]
Page: 1
Parameter: Tune (-12.00 to +12.00 semitones)

This sets the tuning of the selected Drum in 25-cent increments.

Setting Pitch Velocity Sensitivity

Button: [EDIT] [60 PITCH]
Page: 2
Parameter: VEL>PITCH (0 to 7)

This determines how much the selected Drum's tuning will be affected by velocity. The higher the value, the higher the pitch will be as you play harder.

Setting the Velocity Filter Curve [70 FILTER]

Button: [EDIT] [70 FILTER]
Page: 1
Parameter: VEL>FILTER (0 to 3)

The Filter function lets you control the brightness of the selected Drum with keyboard velocity. As this value is increased, keyboard velocity will have a greater effect on the filter frequency. Playing softly will result in a duller sound, while playing harder will result in a brighter sound.

The Amp/Range Function [80 AMP/RANGE]

The Amp/Range Function (button [80]) is where you choose the velocity curve and keyboard range for the drum sound.

Choosing the Velocity Curve

Button: [EDIT] [80 AMP/RANGE]
Page: 1
Parameter: VelCrv (see choices in "Editing Programs" chapter)

This determines how the Drum will respond to an increase in velocity values from the keyboard or MIDI. A **LINEAR** curve is the norm, where the volume increases as you play harder. The velocity curves are the same as those for Keyboard Mode, described under the AMP/RANGE function in the "Editing Programs" chapter.

Choosing the Base Note for the Drum Sound

Button: [EDIT] [80 AMP/RANGE]
Page: 2
Parameter: Note (C2 000 to G8 127)

This sets which note will trigger the Drum sound when played. You can also set the note assignment by holding [80] and tapping a key on the keyboard (while in this page).

Setting the Note Range for the Drum Sound

Button: [EDIT] [80 AMP/RANGE]
Page: 3
Parameter: Note Range (0 to +3)

This sets the range of notes above the root note that will trigger the Drum sound. A setting of +3 assigns the Drum to a total of 4 consecutive keys.

NOTE: Only one Drum can be assigned to a single note within a single Program Sound.

NOTE: If more than one Drum in a Sound is assigned to the same note, only the higher-numbered Drum will sound.

TIP: If you want to layer two Drum mode Drums on top of each other, you will have to use two separate Sound layers

The Amp/Env Function [AMP ENV 110]

The Amp/Env Function (button [110]) is where you can set the drum's decay time and assign it to a mute group, if desired.

Setting the Drum's Decay Time

Button: [EDIT] [110 AMP ENV]
Page: 1
Parameter: Decay (0 to 99, Gat00 to Gat99)

This lets you adjust the amplitude envelope Decay time of the selected Drum. If this is set to 0, only the very beginning of the drum sample will be played. Setting this to 99 will cause the entire drum sample to play.

Settings of Gat00 to Gat99 ("gate") will cause the Drum sound to continue to be played as long as the key is held or the end of the sample is reached. The number after the word "Gat" means that after you let up the key, the drum will decay at that rate.

TIP: This is useful for longer sounds, like cymbals, when you wish to hear a short crash by playing a short note but can still hear a longer crash by keeping the note held down.

Assigning the Drum to a Mute Group

Button: [EDIT] [110 AMP ENV]
Page: 2
Parameter: Mute Group (OFF, 1, 2, or 3)

Mute Groups force multiple Drums to share a single voice. This is most often used with Hi Hats.

For example, if you have assigned a Closed Hat and an Open Hat to two different notes, playing either note should cut off the other. This creates a more realistic sound, since an actual hi hat is only capable of making one kind of sound at a time.

There are three Mute Groups. In the example above, both hi hat drums would be assigned to Mute Group 1.

What is a Mix?

Mix Mode allows you to play up to 16 different Programs at once from the keyboard or an external sequencer. With Mix Mode, you can do the following:

- Layer different Programs so they can be played simultaneously from the keyboard. For example, you can stack a piano on top of a string sound.
- Split the keyboard into different zones--for example, the classic bass guitar on the left-hand side of the keyboard, and synth or piano on the right.
- Use the QS as a master MIDI keyboard. It can transmit on as many as 16 different MIDI channels simultaneously.
- Receive up to 16 MIDI channels from an external sequencer, with each channel representing a different instrument.
- Set the level, panning, transpositions and effect send of each MIDI channel.

Mix Editing

Changing the Programs Within a Mix

The first level of Mix editing is changing the Programs in the Mix. Here's how to do it:

- 1) Get into Mix Mode by pressing the [MIX] button.
- 2) Press the [PAGE >] button to select the Mix channel containing the Program you want to change. The selected Mix channel should be flashing at the bottom of the display.
- 3) Use the [VALUE], [BANK] or numbered buttons to select a different Program.

To return to normal operation, press [MIX] or [PROGRAM].

Getting Into Mix Edit Mode

You may control many other aspects of a Mix by accessing Mix Edit Mode. This is done by pressing the [EDIT] button while in Mix Mode.

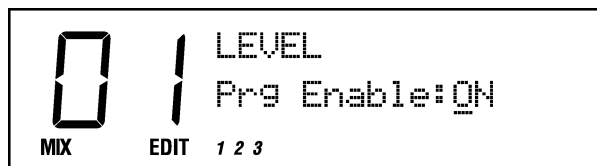

NOTE: The MIDI channel is always corresponds to the Mix channel in Mix Mode.

NOTE: As soon as you change a value, the word "EDIT" will change to "EDITED" in the lower left part of the display.



Once in Mix Edit Mode, use the [0] - [9] and [00] - [50] buttons to select a Mix channel to edit. Use the [60] - [120] buttons to select an Edit Function (Level, Pitch, Effect, etc.)

The Mix Edit functions and channels are written in blue above or below each numbered button, on the line labeled [MIX].

If a Function Group has more than one parameter, use the [PAGE] buttons to navigate.

The Mix Edit Pages

The Level Function [60 LEVEL]

The Level function (button [60]) is used to control parameters that deal with the output of the selected channel.

TIP: Remember, you can reset any parameter back to its default value by pressing the [VALUE UP] and [VALUE DOWN] buttons at the same time.

Enabling a Mix Channel

Button: [EDIT] [60 LEVEL]
Page: 1
Parameter: Prg enable (ON or OFF)

Each channel of a Mix may be enabled or disabled, without changing any of its parameter settings. When a channel is disabled, its channel number will not appear in the lowest line of the display.

Setting the Mix Channel Volume

Button: [EDIT] [60 LEVEL]
Page: 2
Parameter: Prg Volume (00 to 99)

This sets the volume for the Mix channel.

Setting the Mix Channel Panning

Button: [EDIT] [60 LEVEL]
Page: 3
Parameter: Prg Pan (<3 to 3>, or PROG)

This determines the pan position of the selected channel. When set to **PROG**, the Pan setting will defer to the Program's Pan settings.

Routing the Mix Channel to the Outputs

Button: [EDIT] [60 LEVEL]
Page: 4
Parameter: Output (see below)

In the QS6.2, selecting **ON** routes all four Sounds to the main outputs; **OFF** shuts off the paths to the outputs.

In the QS8.2, selecting **MAIN** routes the Sound to the main outputs; **OFF** shuts off the paths. A setting of **AUX** will also shut off the paths. (This is provided for backward compatibility with older QS8 models).

TIP: Regardless of the setting, the Sound may still feed an Effects Send.

When set to **PROG**, the channel will use the Program's output assignments.

Setting the Mix Channel Effects Send Level

Button: [EDIT] [60 LEVEL]
Page: 5
Parameter: FX Level (00 to 99, or PROG)

This determines the amount of signal from the selected channel that will be sent to the effects. When set to **PROG**, the effect level will defer to the Program's Effect Level settings.

Selecting the Mix Channel Effects Send

Button: [EDIT] [60 LEVEL]
Page: 6
Parameter: FX Bus (1 to 4, or PROG)

This determines which effect Bus or "Send" the selected channel will be routed to. When set to **PROG**, the effect Send assignment will defer to the Program's settings.

The Pitch Function [70 PITCH]

The Pitch Function (button [70]) is where you can transpose the Mix channel's Program. Both the pitch and MIDI note number are transposed in this operation.

Shifting the Mix Channel Pitch by Octaves

Button: [EDIT] [70 PITCH]
Page: 1
Parameter: Tune Octave (-2 to +2 octaves)

This transposes the Program's pitch and MIDI note number in octaves.

Shifting the Mix Channel Pitch by Semitones

Button: [EDIT] [70 PITCH]
Page: 2
Parameter: Semitone (-12 to +12 semitones)

This transposes the Program's pitch and MIDI note number in semitones.

The Effect Function [80 EFFECT]

The Effect function is where you select which Program's effects will be used by the Mix.

Setting How Effects Respond to Program Changes

Button: [EDIT] [80 EFFECT]
Page: 1
Parameter: Prg Change (ON or OFF)

This parameter determines how the Mix Effects will respond to MIDI Program Change commands.

When set to **ON**, any Program Change message coming in over the MIDI channel selected for Effects will select a new Program and its associated Effect.

When set to **OFF**, Program Change messages will select new Programs but not change the current Effect setting. This is the default setting.

Setting Which Program's Effects Will be Used

Button: [EDIT] [80 EFFECT]
Page: 2
Parameter: MIDI Chan (1 to 16)

This determines which Program's effect settings will be used by the entire Mix. Only one Program's effects settings can be used at a time in a Mix. Select the Mix channel (which is the same as the MIDI channel) containing the Program you want to use.

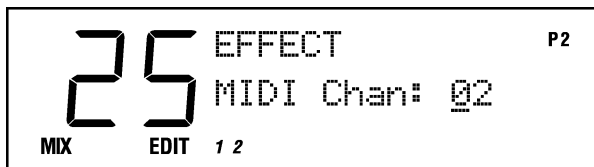

MIDI controller data for the Effect's Modulators will be accepted over this channel.

The Keyboard/MIDI Function [90 KEYBOARD/MIDI]

The Keyboard/MIDI Function (button [90]) allows you to turn on and off the MIDI and keyboard settings for the selected Mix channel.

Enabling MIDI Input for the Mix Channel

Button: [EDIT] [90 KEYBOARD/MIDI]
Page: 1
Parameter: MIDI Input (ON or OFF)

This determines whether the selected Mix channel will respond to incoming MIDI messages.

Enabling MIDI Output for the Mix Channel

Button: [EDIT] [90 KEYBOARD/MIDI]
Page: 2
Parameter: MIDI Outpt (ON or OFF)

This determines whether the selected Mix channel will transmit MIDI messages.

Enabling the Keyboard for the Mix Channel

Button: [EDIT] [90 KEYBOARD/MIDI]
Page: 3
Parameter: Keyboard (ON or OFF)

This determines whether the selected Mix channel will be playable locally from the QS keyboard.

The Controller Function [100 CONTROLLERS]

The Controller function (button [100]) lets you turn on and off the various controllers that can affect the selected MIDI channel. Note that these are dependent on how each Channel has its KEYBOARD/MIDI parameters set (see the previous section).

Enabling MIDI for the Wheels

Button: [EDIT] [100 CONTROLLERS]
Page: 1
Parameter: Wheels (ON or OFF)

This determines whether the selected channel will transmit and receive pitch-bend and modulation (controller 1) MIDI information.

Enabling MIDI Aftertouch

Button: [EDIT] [100 CONTROLLERS]
Page: 2
Parameter: Aftertouch (ON or OFF)

This determines whether the selected channel will transmit and receive aftertouch MIDI information.

Enabling MIDI for the Sustain Pedal

Button: [EDIT] [100 CONTROLLERS]
Page: 3
Parameter: Sustn Pedl (ON or OFF)

This determines whether the selected channel will transmit and receive sustain pedal (controller 64) MIDI information.

Enabling MIDI for the Sliders

Button: [EDIT] [100 CONTROLLERS]
Page: 4
Parameter: Controllrs (ON or OFF)

This determines whether the selected channel will allow Controllers A–D and Pedals 1 & 2 to transmit and receive MIDI controller information. You can assign which MIDI controller numbers they are linked to in Global Mode.

The Range Function [110 RANGE]

The Range function (button [110]) allows you to specify the range of keys to which each Mix Channel will respond. This is ideal for creating keyboard splits and layers.

Setting the Lower Keyboard Limit (Split Point)

Button: [EDIT] [110 RANGE]
 Page: 1
 Parameter: LoLim (000 C2 to 127 G8)

Sets the lowest note of the Mix Channel's keyboard range.

TIP: This is how you create keyboard splits and layers

Setting the Upper Keyboard Limit (Split Point)

Button: [EDIT] [110 RANGE]
 Page: 2
 Parameter: HiLim (000 C2 to 127 G8)

Sets the highest note of the Mix Channel's keyboard range.

TIP: In both of these functions, you can set the note by holding the [110] button and tapping one of the keys.

Naming the Mix [120 NAME]

Button: [EDIT] [120 NAME]
 Page: 1
 Parameter: Name (see chart)

This allows you to change the name of the Mix. Use the [PAGE] buttons to position the cursor, and then use the [CONTROLLER D] slider or [VALUE] buttons to select from the available characters:

	!	"	#	\$	%	&	'	()	*	+	,	-	.	/	0	1	2	3
4	5	6	7	8	9	:	;	<	=	>	?	@	A	B	C	D	E	F	G
H	I	J	K	L	M	N	O	P	Q	R	S	T	U	V	W	X	Y	Z	[
¥]	^	_	`	a	b	c	d	e	f	g	h	i	j	k	l	m	n	o
p	q	r	s	t	u	v	w	x	y	z	{		}	>	<				

The Mix Edit Buffers

In Mix mode, there are 16 edit buffers for the Programs inside the Mix, plus another buffer for the Mix parameters, and yet another buffer for the Effects Processor.

You can edit a Program within a Mix by pressing [EDIT] a second time (each time you press [EDIT] in Mix Mode, the display cycles between Mix Edit, Program Edit and Effects Edit Modes). When editing a Program in Mix Mode, the words "MIX PROG EDIT" will appear in the lower left corner of the display, and the channel number that is being edited will flash:

TIP: These edit buffers are preserved when going between Mix and Program Modes. So, if you want to audition other Programs while in Mix Mode, you can go into Program Mode and your Mix Mode edits will not be lost.

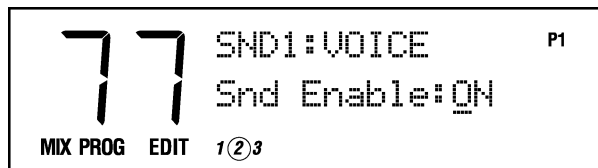

!
NOTE: Be sure to store each edited Program, or your changes will be lost.

QS Parallel Matrix Effects™

The QS synthesizer has a powerful built-in digital signal processor capable of generating a variety of effects, including reverb, delay, chorus, flanging and overdrive.

The effects processor has four paths called effect Sends. Each Send has its own group of effects arranged in a particular way. The four Sends are arranged in parallel and can be active simultaneously.

In a Program, each Sound can be assigned to one of the four effect Sends. The send levels are set in Program Edit Mode and Mix Edit Mode.

In Mix Mode, only one Program's effects are active, and they apply to all Programs in the Mix. The Mix Channel containing the Program whose effects are active is called the Effects Channel. The Effects Channel is set within Mix Mode.

Editing Effects

Setting the Send Levels

To hear any effects, you must route sounds to the effects processor. In Program Edit mode, you do this by pressing the Level function button [50] and setting the FX Level and FX Bus (i.e., Send). In Mix Edit mode, press the Level function button [60] for these settings.

Getting Into Effects Edit Mode

Effects Edit Mode allows you to choose how your effects are arranged and to set the parameters for those effects. To enter Effects Edit Mode from Program Mode, press the [EDIT] button twice.

The display will look something like this:

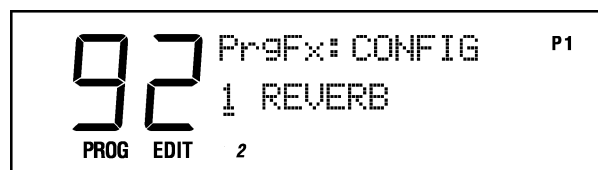

To enter Effects Edit Mode from Mix Mode, press the [EDIT] button three times. You will automatically jump to the Mix Channel whose effects are being used by the Mix.



The display will look like this:

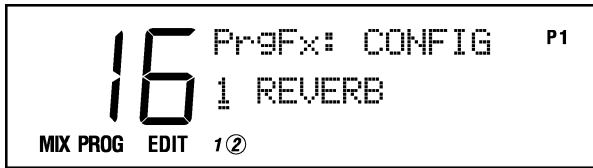

What the Numbered Buttons Do

The [00] – [30] buttons choose among the four Effect Sends, as indicated by the blue middle row of labels above them. You can change which Effect Send you are editing from any Effects Edit function.

The [40] – [120] buttons select Effects Edit functions. If you look at the middle row of labels above these buttons, you'll see the list: Configuration, EQ, Mod, Lezlie, Pitch, Delay, Reverb, Overdrive, and Mix .

Storing Effects Settings

To store your Effects edits, press [STORE] twice from Effects Edit Mode. In Program Mode, this stores the current Program. In Mix Mode, this stores the Effects Channel Program.

NOTE: A particular Program's Effects might be used in one or more Mixes. So if you change the Effects settings in that Program, the change will ripple through and be heard in every Mix which uses that Program's Effects.

Copying Effects

You can copy one Program's Effects settings into another by using the Copy Effect function within Store Mode. Here's how it's done:

- 1) Select the Program that contains the Effect you wish to copy.
- 2) Press [STORE].
- 3) Press the [PAGE >] key three times and you will see the following display:

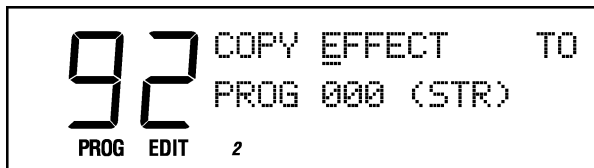

- 4) Press the [PAGE >] key one more time so the cursor is under the "P" in "PROG".
- 5) Use the [EDIT VALUE] slider or the [VALUE] buttons to select the User Program number that you would like to copy the current Effect to.
- 6) Press [STORE].

NOTE: You can only copy Effects to the User bank. The only way to copy a Effects settings onto an SRAM card is to copy the SRAM card program to the User bank, perform the Effects copy, then move the Program back to the card bank.

You can also copy another Program's effects into the Edit buffer by adjusting the first parameter (the source) on this page.

Hearing the Effects Only

Normally, the final output of an Effect is mixed back in with the original Program or Mix, so that what you hear is a combination of the two. In some cases, however, you may want to hear only the Effected sound. Here's how to do that:

- 1) Go into Program Edit mode.
- 2) Assign the Output parameter of the Sound/Program to OFF.
- 3) Assign the Effect Bus of that Sound/Program to one of the four Effect Sends.
- 4) Adjust the Effect Level as you wish.

If the Effects Inputs Clip (“!”)

If the input to the Effect becomes overloaded while you are playing, then a “!” symbol will flash in the Mix or Program display. You want to avoid this situation because clipping creates unnecessary noise and distortion, and can even cause the signal to drop out for a second.

There are two easy fixes:

- Go into Effect Edit mode and reduce the Input levels for each effect function in the current configuration.
- Reduce the Effect level settings in the Program or Mix that is giving you the problem.

The Effects Edit Pages

The Configuration Function [40 CONFIGURATION]

The starting point of every Effect is its **Configuration**, which defines all routing and parameters. Each is a unique arrangement of effect blocks distributed across two to four effect Sends. The Configuration determines where each block's input comes from and where each block's output goes. The five Effect Configurations are:

1. **1 REVERB**
2. **2 REVERBS**
3. **LEZLIE+REVERB**
4. **1 REVERB + EQ**
5. **OVERDRIVE+LZLY**

To pick a Configuration, enter Effects Edit Mode and then press [40], the button that has CONFIGURATION printed above it. The display will look like this:

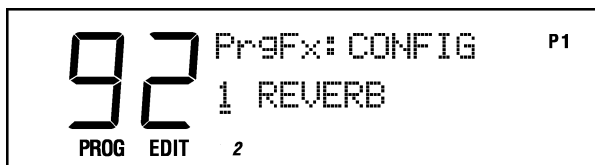

Use the [VALUE] buttons or the [EDIT VALUE] slider to select one of the five Configurations.

NOTE: Every time you select a new Configuration, many of the parameters will be reset to their default values. So always pick your Configuration first, before doing any other Effects editing.

Configuration 1: 1 REVERB

1 REVERB is a general-purpose configuration with four Sends, each with a variety of effects which all feed into a single Reverb.

Sends 1 and 2 have a Pitch effect followed by a stereo Delay. Send 3 has a mono Pitch effect followed by a mono Delay. Send 4 has a mono Delay.

The output of all of these paths are mixed and sent into a single Reverb. The Reverb parameters are in Send 1.

NOTE: Each Pitch, Delay and Reverb module has its own independent mix output level which controls how much signal is routed directly to the main outputs.

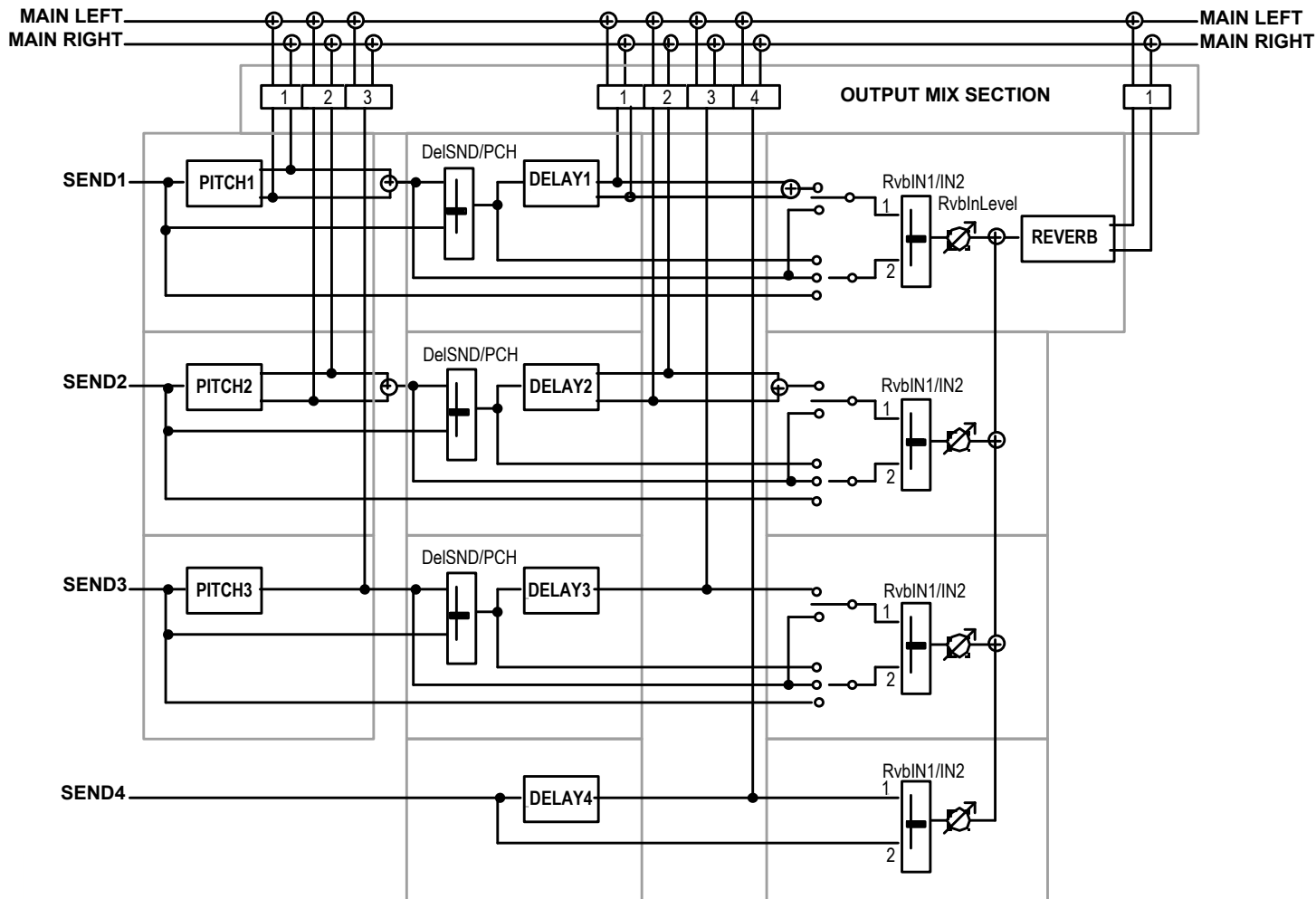

Configuration 2: 2 REVERBS

This Configuration should be used when two different reverbs are needed. For example, you might need a gated reverb for drums and a regular reverb for everything else.

Send 1 is routed through a mono Delay, then a Chorus, then to the first Reverb. Send 2 is routed directly to the first Reverb.

Send 3 is routed through a mono Chorus, then to the second Reverb.
Send 4 is routed directly to the second Reverb.

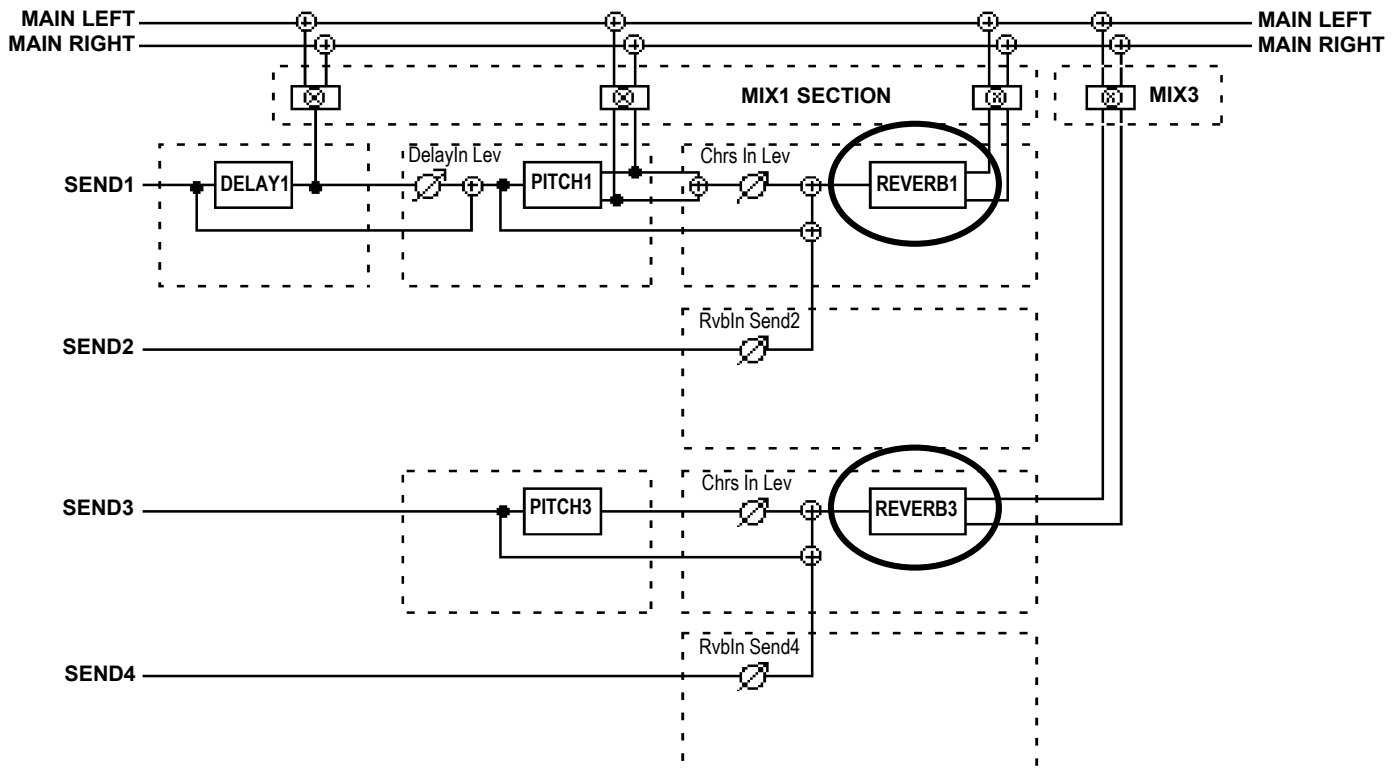

Configuration 3: LEZLIE+REVERB

This Configuration is structurally similar to Configuration 1 (1 REVERB). The difference here is that the Pitch effect on Send 1 is a custom-designed stereo “rotating speaker” effect, and it is followed by a mono Delay. This is useful for organ sounds.

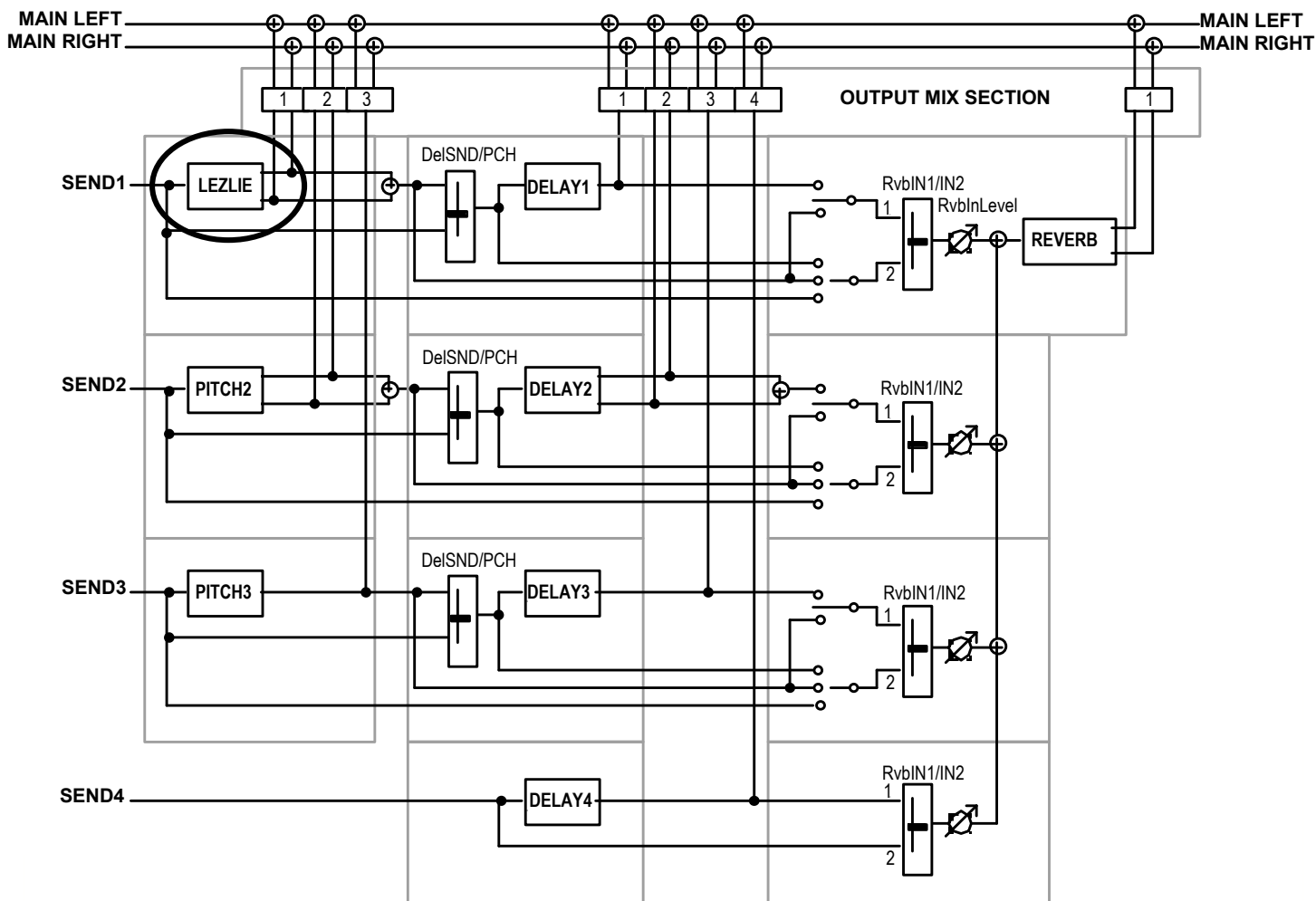

Configuration 4: 1 REVERB+EQ

This is another general-purpose Configuration with the bonus of having a shelving EQ at the output.

This Configuration is similar to Configuration 1 (1 REVERB), except that sends 3 and 4 have been removed, and there is a shelving EQ at the main outputs. This EQ affects all sounds coming out of the QS outputs, not just the effects output.

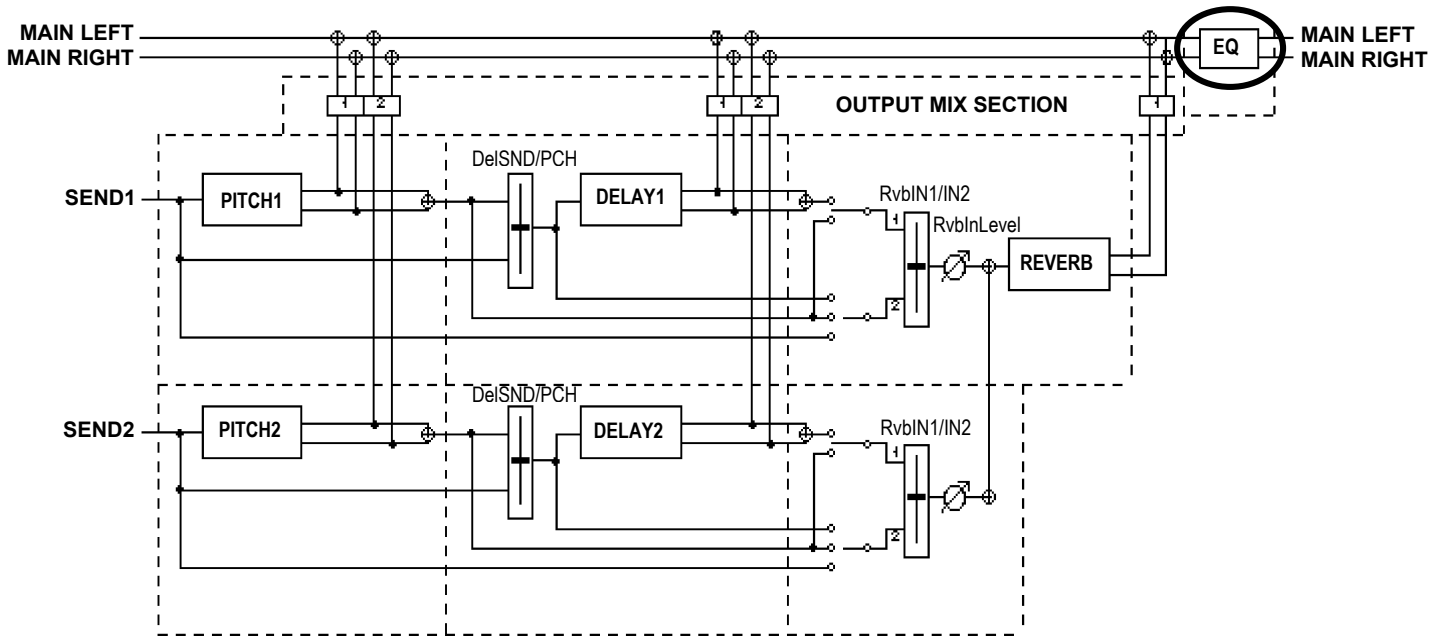

Configuration 5: OVERDRIVE+LEZLIE

This Configuration has a classic Overdrive distortion with Lezlie, useful for guitar and organ sounds.

Send 1 has the Overdrive distortion, followed by a mono Pitch effect, a Delay, a Reverb, then a Lezlie. This is summed with the main outputs and sent through a shelving EQ.

Sends 2 through 4 have no effects of their own, but can feed the effects of Send 1 at various points.

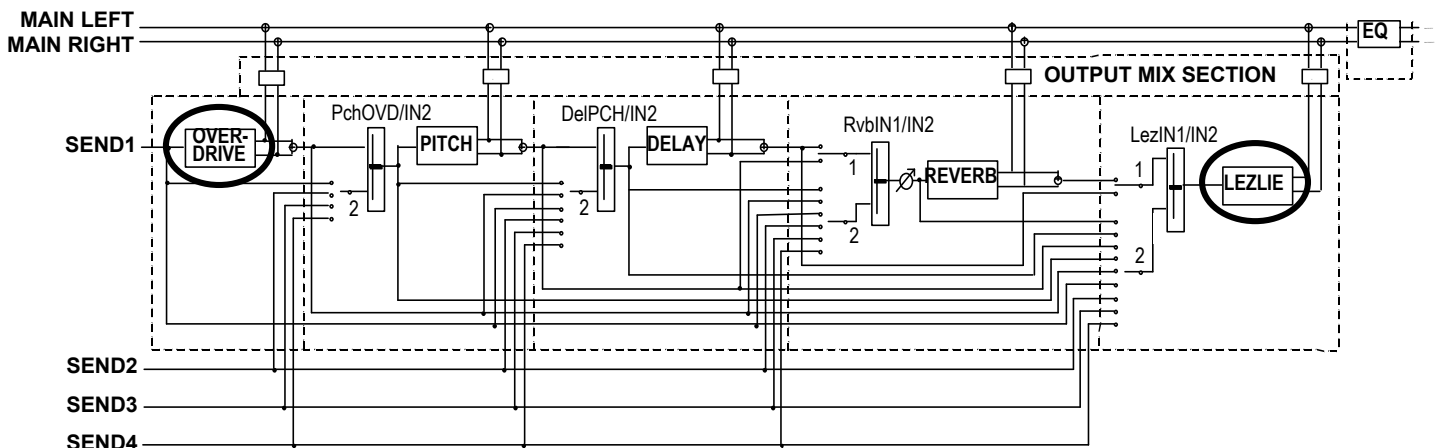

Selecting a Send to Edit [00-30 SEND]

After you choose a Configuration, the next step in editing is to pick one of the four Sends to work on. The [00]-[30] buttons select which effects Send (1-4) you are editing.

You can change what Send you are editing any time from most of the Effects Edit pages by pressing these buttons. Notice how the Send number changes in the upper left part of the display.

Not all effects are available in each Configuration or Send. If you try to select an effect that doesn't exist in the Configuration or Send, you'll see the message:

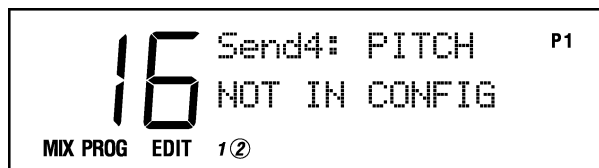

The EQ Function [50 EQ]

The stereo shelving EQ provides bass and treble boost to the entire output of the QS — not just the Effect Sends — and is only available in Configuration 4 (REVERB+EQ) and Configuration 5 (OVERDRIVE+LZLY). There are four EQ parameters.

Setting the EQ Low Shelf Frequency

Button: [EDIT] [EDIT] [50 EQ]
Page: 1
Parameter: Lo EQ (30Hz to 180Hz)

This sets the cutoff frequency of the low shelving EQ. All frequencies below this will be boosted by the Lo EQ Gain amount (below).

Setting the EQ Low Shelf Boost

Button: [EDIT] [EDIT] [50 EQ]
Page: 2
Parameter: Lo EQ Gn (0dB to +12dB)

This controls the amount of boost that will be applied to the low shelving EQ.

TIP: You can reset any parameter back to its default value by pressing the [VALUE UP] and [VALUE DOWN] buttons at the same time.

Setting the EQ High Shelf Frequency

Button: [EDIT] [EDIT] [50 EQ]
Page: 3
Parameter: Hi EQ (3kHz to 10kHz)

This sets the cutoff frequency of the high shelving EQ. All frequencies above this will be boosted by the Hi EQ Gain amount (below)

Setting the EQ High Shelf Boost

Button: [EDIT] [EDIT] [50 EQ]
Page: 4
Parameter: Hi EQ Gn (0dB to +9dB)

This determines how much boost will be applied to the high shelving EQ.

The Mod Function [60 MOD]

The Mod Function (button [60]) provides two modulation paths, allowing you to modulate two effects parameters at a time, either via MIDI or from your QS.

If a Mod is disabled (the Level is set to zero), then every parameter within that Mod will be displayed in small letters. Otherwise, the first letter of each parameter will be capitalized.

Choosing the Mod Source

Button: [EDIT] [EDIT] [60 MOD]
Pages: 1, 4
Parameter: Src1, Src2 (see below)

This parameter selects the control source for the modulation path. The choices are:

- Aftertouch
- Mod Wheel
- Pitch Wheel
- MIDI Volume
- Sustain Pedal
- Pedal 1
- Pedal 2
- Controllers A-D

Choosing the Mod Destination

Button: [EDIT] [EDIT] [60 MOD]
Pages: 2, 5
Parameter: Dst1, Dst2 (see below)

This is where you select what Effect parameter your modulation source is going to modulate. Not all of these are available in all configurations, but the possible destinations are:

- Pitch Speed
- Pitch Depth
- Pitch Level
- Pitch Balance
- Delay Balance
- Delay Time
- Delay Feedback
- Delay Level
- Reverb Balance
- Reverb Input
- Reverb Decay
- Reverb Low Decay
- Reverb High Decay
- Reverb Diffusion
- Reverb Level
- Overdrive Threshold
- Overdrive Bright
- Overdrive Balance
- Overdrive Level
- Lezlie Balance
- Lezlie Level
- Lezlie Speed
- Lezlie Motor

If the selected Configuration has a particular effect on more than one Send, certain Mod Destination parameters will be listed more than once. For example: D1 TIME, D2 TIME, D3 TIME, etc.

NOTE: Don't confuse this Effect Mod function with the Mod settings within the Programs. They are not the same thing, since they have entirely independent destinations. (They can tap some of the same sources, though.)

TIP: If you want to use a MIDI controller that isn't listed, select one of the [A-D CONTROLLER] sliders (or one of the pedals) and then go to display pages 8 through 13 of Global Mode to link that mod source to the MIDI Controller number of your choice.

NOTE: If you modulate an Effect parameter while audio is passing through it, it is possible that you will generate some degree of distortion in the audio (sometimes known as "zipper noise".) This is normal. One exception to this is Chorus Speed, which modulates more smoothly.

NOTE: If the Resonator or Detune effects are chosen, you won't see their parameters listed as Mod destinations, but they're still available. For example, if you've chosen Resonator on Send 1 and you want to be able to modulate its first parameter (Resonator Tune), choose P1 Speed as your destination (that's the first parameter you can modulate in a Chorus). The Resonator Decay parameter is its second parameter, so to modulate it you would choose P1 Depth (the second P1 parameter) as the destination.

NOTE: When you're in Configuration 3 and you want to modulate the Lezlie speed, you'll find there's no parameter for a Mod destination labeled "Lezlie". But you can still control it by selecting "P1 Speed" as the destination. Configuration 5 does have Lezlie parameters at the top of the Mod destination list, however, so be careful! If you modulate P1 Speed in Configuration 5 you'll be changing the Chorus/Flange speed instead.

Setting the Mod Level

Button: [EDIT] [EDIT] [60 MOD]
Pages: 3, 6
Parameter: Mod1 Level, Mod2 Level (-99 to 99)

This determines the degree to which the Mod Destination will be modulated by the Source.

The Lezlie Function [70 LEZLIE]

This “rotating speaker” simulation is available in Configurations 3 and 5 only. In Configuration 3 it takes its input from Send 1. In Configuration 5 it can have up to two inputs, and those can come from a greater variety of sources.

TIP: The Lezlie effect is most commonly used on guitar and organ sounds.

Selecting the Lezlie Input 1 Source (Config 5)

Button: [EDIT] [EDIT] [70 LEZLIE]
Page: 1 (Config 5 only)
Parameter: In1 (REVERB or DELAY)

This selects the first input to the Lezlie in Configuration 5 (OVERDRIVE+LEZLIE). The input can be the output of the Reverb or Delay.

Selecting the Lezlie Input 2 Source (Config 5)

Button: [EDIT] [EDIT] [70 LEZLIE]
Page: 2 (Config 5 only)
Parameter: In2 (see below)

This selects the second input to the Lezlie in Configuration 5 (OVERDRIVE+LEZLIE). The choices are:

- Sends 1 – 4
- Overdrive Output
- Pitch Input
- Pitch Output
- Delay Input
- Reverb Input

Setting the Balance Between the Lezlie Inputs (Config 5 Only)

Button: [EDIT] [EDIT] [70 LEZLIE]
Page: 3 (Config 5 only)
Parameter: ->Lez (IN1<99 to 99>IN2)

This controls the balance between Input 1 and Input 2 going into the Lezlie. When set to **IN1<99**, only Input 1 is being routed to the Lezlie. When set to **99>IN2**, only Input 2 is routed. When set to **<0>**, an even mix of both signals is passed on.

Turning On the Lezlie Motor

Button: [EDIT] [EDIT] [70 LEZLIE]
Page: 1 or 4
Parameter: Motor (ON or OFF)

This determines whether the Lezlie is operating or not. When turned **ON**, the rotating speaker effect starts up slowly, just like the real thing. When turned **OFF**, the effect dies down slowly until it reaches a complete stop.

Setting the Lezlie Speed

Button: [EDIT] [EDIT] [70 LEZLIE]
Page: 2 or 5
Parameter: Lezl Spd (SLOW or FAST)

This determines how fast the rotating effect “spins”. When you switch between the two speeds, the effect will ramp up and down just like the real deal.

Setting the Lezlie Horn Level

Button: [EDIT] [EDIT] [70 LEZLIE]
Page: 3 or 6
Parameter: Horn Lvl (-6 to +6 dB)

This parameter provides a way to cut or boost the high frequencies in the Lezlie effect, allowing you to “darken” or “brighten” the tone in 1dB increments.

TIP: Here’s how to control the Motor ON/OFF setting from a footswitch: Select the Sustain Pedal as the Mod source and Lezlie Motor as your destination (or “P1 Motor”, depending on the configuration). If the Motor is OFF, set the Mod Level to +99 so the footswitch turns the Lezlie on when pressed. If the Motor is ON, route the footswitch negatively in the Mod function.

NOTE: If you want to be able to control the Lezlie speed when set to FAST, you’ll have to route the modulation negatively in the Effects Mod function.

The Pitch Function [80 PITCH]

Pitch effects are achieved by splitting a signal into two parts, delaying and/or changing the pitch of one of the parts, and then mixing the two back together. This final mixing step is essential, since the overall sound of the effect is created in the way the changed and unchanged signals interact.

Selecting the Pitch Effect

Button: [EDIT] [EDIT] [80 PITCH]
Page: 1
Parameter: Type (see below)

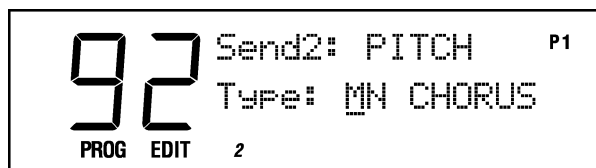

NOTE: The page numbers may vary in different Configurations. Not all pages are available in all Configurations

There are six different pitch-altering effects. They are:

MONO CHORUS. The **Chorus** effect is used to “thicken up” the sound of an instrument, making one instrument sound like two or more played together. In extreme cases, it can add a “watery” quality to a sound.

The Chorus effect is achieved by mixing a signal with a slightly delayed and detuned version of itself. This detuning is modulated by an LFO (Low Frequency Oscillator).

STEREO CHORUS. In a **Stereo Chorus**, the signal is split into three parts: a dry signal and separate left and right detunings. When the left channel is detuned sharp, the right channel is automatically detuned flat, and vice versa. This causes the effect to become more dramatic while keeping it “in tune” to the ear.

MONO FLANGE. **Flanging** is achieved by mixing a signal with a variable time-delayed version of itself. This is similar to Chorusing, except here we use the LFO to modulate delay time instead of pitch. The delayed signal is then mixed back with the original sound to produce that well-known “swooshing” or “jet plane” sound.

The speed and depth of the LFO can be varied, and part of the signal can be fed back into itself to make the effect stronger. This feedback setting can be either “Normal” or “Inverted”. Try using “Inverted” for a more dramatic flange.

STEREO FLANGE. In a **Stereo Flange**, the signal is split into three parts: a dry signal and separate left and right signals, each with its own delay. While one channel flanges up the other channel automatically flanges down, making the effect more pronounced.

PITCH DETUNE. This effect takes a signal and detunes it either sharp or flat. When mixed back with the original signal, the popular “12 string guitar” effect can be produced, thickening the sound.

RESONATOR. The **Resonator** is a very fast delay that causes a comb-filtering effect. This results in a pitched “buzzy” sound when applied to percussive sounds like drums.

NOTE: The Resonator is considered to be a Pitch effect, so when you want to control the Resonator’s output level, adjust the Pitch effect level for that Send in the Mix function [120].

TIP: The resonator effect is most often used in electronic music.

Adjusting the Pitch Effect Input Level in 2 REVERBS

Button: [EDIT] [EDIT] [80 PITCH]
Page: 2 (Config 2 only)
Parameter: DelayIn Lev (<99 to 99>)

This adjusts the level of the signal going from the Delay output to the Pitch Input. This parameter is only available on Send 1 in Configuration 2 (2 REVERBS).

Setting the Chorus LFO Wave Shape

Button: [EDIT] [EDIT] [80 PITCH]
Page: 2 (Chorus only)
Parameter: Chr Shp (SINE or SQUARE)

This determines the LFO’s waveform shape for the Chorus effect.

Setting the Flanger Feedback Type

Button: [EDIT] [EDIT] [80 PITCH]
Page: 2 (Flanger only)
Parameter: FlngShp (NORMAL or INVERT)

This determines the phase of the Flanger feedback signal. A setting of **INVERT** will result in a more dramatic effect.

TIP: The inverted-feedback Flange effect can be used to simulate resonance. To simulate a sweep, run the waveform through the effect and modulate the flange depth. Although you cannot use an envelope as a mod source, you can access any of the other real time controllers. The flanger may introduce artifacts (depending on the frequency content of the waveform).

Setting the Chorus/Flanger LFO Speed

Button: [EDIT] [EDIT] [80 PITCH]
Page: 3 (Chorus and Flanger only)
Parameter: Chors/Flang Speed (00 to 99)

This parameter adjusts the LFO Speed for the Chorus and Flanger.

Setting the Chorus/Flanger LFO Depth

Button: [EDIT] [EDIT] [80 PITCH]
Page: 4 (Chorus and Flanger only)
Parameter: Chors/Flang Depth (00 to 99)

This parameter adjusts the LFO Depth for the Chorus and Flanger. This controls the amount of pitch alteration.

Setting the Chorus/Flanger Feedback

Button: [EDIT] [EDIT] [80 PITCH]
Page: 5 (Chorus and Flanger only)
Parameter: Chrs/Flng Feedbk (00 to 99)

This parameter adjusts the Feedback for the Chorus and Flanger. A portion of the output of the Pitch section can be “fed back” into the input in order to make the effect more pronounced.

Setting the Pitch Detune Amount

Button: [EDIT] [EDIT] [80 PITCH]
Page: 2 (Pitch Detune only)
Parameter: Pch Detune (-99 to 99)

This adjusts the amount of detuning. At +99, the sound is tuned up 50 cents. At -99, the sound is tuned down 50 cents.

Setting the Resonator Tuning

Button: [EDIT] [EDIT] [80 PITCH]
Page: 1, 2 or 4 (Resonator only)
Parameter: Resntr Tune (00 to 60)

This adjusts the Resonator tuning frequency. Lower values result in a “buzzer” sound. Higher values result in a “flanged” sound.

Setting the Resonator Decay Time

Button: [EDIT] [EDIT] [80 PITCH]
Page: 2, 3 or 5 (Resonator only)
Parameter: Resntr Decy (00 to 99)

This adjusts the Resonator Decay time. **00** is a fast decay and **99** is a longer decay.

Selecting the Pitch Effect Input 2 Source in OVERDRIVE+LEZLIE

Button: [EDIT] [EDIT] [80 PITCH]
Page: 2 (Config 5 only)
Parameter: In2 (SEND1-SEND4)

This selects the second input to the Pitch effect in Configuration 5 (OVERDRIVE+LEZLIE).

Setting the Pitch Effect Input Balance in OVERDRIVE+LEZLIE

Button: [EDIT] [EDIT] [80 PITCH]
Page: 3 (Config 5 only)
Parameter: ->PCH (OVD<99 to 99>IN2)

This sets the Resonator input balance between Overdrive and Input 2 in Configuration 5 (OVERDRIVE+LEZLIE). When set to **OVD<99**, only the Overdrive is being routed to the Resonator. When set to **99>IN2**, all that goes through is Input 2. When set to **<0>**, an even mix of both signals is passed on.

The Delay Function [90 DELAY]

This effect delays the signal to create one or more “echoes” of the original sound. The QS’s effects processor has three different delay types available.

NOTE: The page numbers may vary slightly in different Configurations. Not all pages are available in all Configurations.

Choosing the Delay Type

Button: [EDIT] [EDIT] [90 DELAY]
Page: 1
Parameter: Typ (see below)

PING-PONG. In this delay, the output bounces from left to right in the stereo field. The maximum delay time is 399 milliseconds.

STEREO DELAY. This is actually two separate delays, which can be individually varied. The maximum delay time for each delay is 399 ms.

MONO DELAY. This delay has the advantage of twice the available delay time, or 799 ms in Configuration 1, 1199 ms in Configuration 2 (2 REVERBS).

Selecting the Delay Input 2 Source in OVERDRIVE+LEZLIE

Button: [EDIT] [EDIT] [90 DELAY]
Page: 2 (Config 5 only)
Parameter: In2 (SEND1-SEND4, OVERDRIV, PITCH IN)

This selects the second input to the Delay effect in Configuration 5, (OVERDRIVE+LEZLIE).

Setting the Delay Input Balance

Button: [EDIT] [EDIT] [90 DELAY]
Page: 2 or 3
Parameter: ->DEL (PCH<99 to 99>IN2)

This sets the balance between the two Delay effect inputs. The first input comes from a Pitch effect, the second input is dry.

Setting the Delay Time

Button: [EDIT] [EDIT] [90 DELAY]
Pages: 3 and 4 (and 6 and 7 for Stereo Delay)
Parameter: Delay Tm, Delay, or R/L Delay
 0 to 799ms (Mono Delay)
 0 to 1199ms (Mono Delay in Config 2)
 0 to 399ms (Ping Pong and Stereo Delay)

This is the actual delay time, which determines when the “echoes” will occur. You can adjust the delay time in 10ms and 1ms increments.

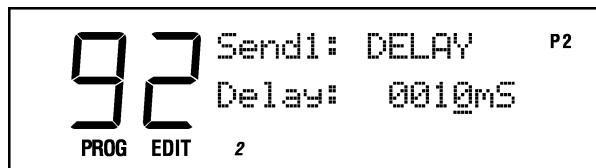

TIP: The Stereo Delay allows you to have different Delay Time settings for the right and left channels.

Setting the Delay Feedback Amount

Button: [EDIT] [EDIT] [90 DELAY]
Pages: 5 (and 8 in Stereo Delay)
Parameter: Delay Fdbk (00 to 99)

This adjusts the delay feedback, which is a portion of the delay signal output being “fed back” into the input. This results in the delay repeating itself. The higher the feedback value, the more repeats you’ll get.

NOTE: When using the Stereo Delay, page 5 lets you adjust the feedback level of the left channel, while page 8 lets you adjust the same for the right channel.

The Reverb Function [100 REVERB]

Reverb consists of a great number of audio reflections that occur so fast that our ear hears them blurred together as one. The source can come directly from the Effect bus, the output of other effects in the chain before it, or a mix of several of them.

NOTE: The page numbers will vary in different Configurations. Not all page types are available in all Configurations.

Selecting the Reverb Input 1 Source

Button: [EDIT] [EDIT] [100 REVERB]
 Page: 1
 Parameter: In1 (PITCHout or DELAYout)

This selects the first input of the Reverb, the output from either the pitch or delay effect. This parameter is not available in Config 2 (2 REVERBS).

Selecting the Reverb Input 2 Source

Button: [EDIT] [EDIT] [100 REVERB]
 Page: 2
 Parameter: In2 (SEND IN, PITCHout or DELAY IN)

This selects the second input of the Reverb. You can choose between the output of a Pitch effect, the input of the Delay effect, or a dry signal (SEND IN). Note that at the input of the Delay effect, the signal is a blend between the Pitch output and the dry signal. This parameter is not available in Config 2 (2 REVERBS).

Setting the Reverb Input Balance

Button: [EDIT] [EDIT] [100 REVERB]
 Page: 3
 Parameter: ->Rvb (<99 to 99>)

This controls the balance between Inputs 1 and 2 (see above). This parameter is not available in Config 2 (2 REVERBS).

Setting the Reverb Input Level

Button: [EDIT] [EDIT] [100 REVERB]
 Page: 2 or 4
 Parameter: RvbIn Level (00 to 99)

This controls the overall Input Level going into the Reverb in Send 1.

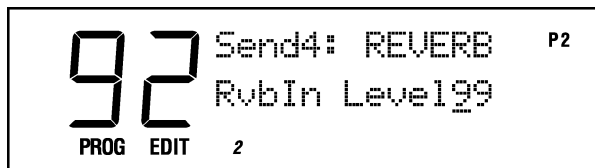

Setting the Send 2 Reverb Input Level (2 REVERBS Only)

Button: [EDIT] [EDIT] [100 REVERB]
 Page: 1 (Config 2, Send 2 only)
 Parameter: RvbIn Send2 (00 to 99)

This sets the level of the signal going from Send 2 directly into Reverb 1. This setting is only available in Configuration 2 (2 REVERBS), Send 2.

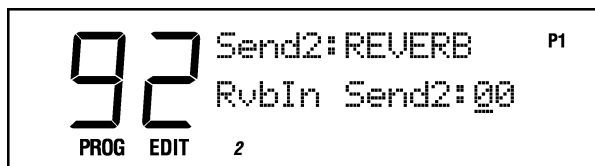

Setting the Send 4 Reverb Input Level (2 REVERBS Only)

Button: [EDIT] [EDIT] [100 REVERB]
 Page: 1 (Config 2, Send 4 only)
 Parameter: RvbIn Send4 (00 to 99)

This sets the level of the signal from Send 4 into the Reverb in Send 3. This setting is only available in Configuration 2 (2 REVERBS).

Setting the Pitch Effect Output into the Reverb (2 REVERBS Only)

Button: [EDIT] [EDIT] [100 REVERB]
 Page: 1 (Config 2, Sends 1 and 3 only)
 Parameter: Chrs In Lev (00 to 99)

This adjusts the level of the signal coming from the Pitch effect output to the Reverb; otherwise the signal comes purely from the Pitch effect input. This parameter is only available in Configuration 2 (2 REVERBS).

Reverb Parameters

These pages determine the characteristics of the reverb itself. Here are the parameters you will find on these pages.

Selecting the Reverb Type

Button: [EDIT] [EDIT] [100 REVERB]
 Page: 2 or 5
 Parameter: Type (see below)

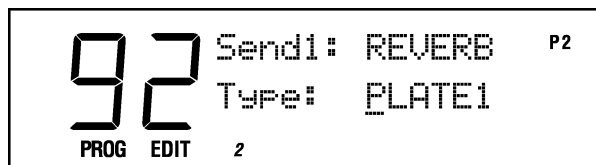

The QS has seven different reverb types, all stereo, each of which simulates a different space or produces a different ambient effect. The different reverb types are:

PLATE 1 & 2. These are recreations of vintage plate reverbs, especially useful on vocal and drum sounds.

ROOM. This reverb type simulates rooms of different sizes and surface materials. A room with soft surfaces such as carpet will produce a reverberant sound with much less high end (treble) than a room with hard surfaces.

HALL. Halls are characterized by their high ceilings, irregular shapes, and generally uniform density of reflections.

LARGE. This reverb simulates the large ambient spaces found in amphitheaters, gymnasiums, etc.

GATE. In this reverb, the reverb sound is abruptly cut off (or “gated”) as it decays. When applied to drums, it sounds like a large volume of

***NOTE:** You must have the correct Effect send selected in order to get to the Reverb parameters. In Config. 1 (1 REVERB), they are found on Send 1; in Config. 2 (2 REVERBS), they are found on Sends 1 and 3 (since there are two separate Reverbs).*

***TIP:** A Plate is a device used in the early days of recording to simulate reverb. The sound of a Plate reverb is still popular today.*

***TIP:** Gated reverbs were popularly used on drums in the 1980's.*

“air” is being moved when the drum is hit. This effect works great for drums, percussion, and any transient source.

REVERSE. The Reverse Reverb type is an inverted reverb in which the signal begins softly and grows louder until it is cut off, rather than loud to soft as normal.

Setting the Reverb Predelay Time

Button: [EDIT] [EDIT] [100 REVERB]
Page: 6 and 7 (3 and 4 in Config 2, Send 3)
Parameter: Predelay (0 to 299ms)

With this parameter, you can add a slight delay before the reverb effect starts. This can make instruments such as snare drums sound bigger. You can adjust the time in 10ms and 1ms increments.

NOTE: This Pre-Delay is applied to the Reverb itself; don't confuse it with the separate Delay modules available under the Delay function.

Setting the Reverb Predelay Mix

Button: [EDIT] [EDIT] [100 REVERB]
Page: 8 (5 in Config 2, Send 3)
Parameter: PreMx (IN<99 to 99>DEL)

This controls the balance between the pre-delayed reverb and the straight reverb. When set to **IN<99**, you get the reverb with no pre-delay. At **99>DEL** you get pure pre-delayed reverb.

Setting the Reverb Input Filter Frequency

Button: [EDIT] [EDIT] [100 REVERB]
Page: 9 (6 in Config 2, Send 3)
Parameter: Inpt Filter (00 to 99)

This adjusts the frequency of the low-pass filter at the Reverb input. Lower values make the reverb sound darker.

Setting the Reverb Decay Time

Button: [EDIT] [EDIT] [100 REVERB]
Page: 10 (7 in Config 2, Send 3)
Parameter: Decay (00 to 99)

This determines how long the reverb will sound before it dies away. When using the Reverse Reverb type, Reverb Decay controls the Reverse Time.

Setting the Reverb Hi/Low Decay Time

Button: [EDIT] [EDIT] [100 REVERB]
Page: 11 & 12 (8 & 9 in Config 2, Send 3)
Parameter: Low Decay/High Decay (00 to -99)

These two parameters set the Decay Time separately for the low and high frequencies of the reverb. This means that you can make the high frequencies die faster if the effect is too bright, and being able to make the lows die faster if it's too boomy.

NOTE: If the selected Reverb type is Gate or Reverse, the Low Decay parameter is unavailable.

Setting the Reverb Hi/Low Decay Time

Button: [EDIT] [EDIT] [100 REVERB]
Page: 10 or 13 (12 if Gated or Reverse type)
Parameter: Density (00 to 99)

This controls how the reflections of the reverb will sound. When set to 00, the individual reflections will be very distinct. When set to 99, the reflections will be “smeared”, making the reverb sound more dense.

Setting the Reverb Diffusion

Button: [EDIT] [EDIT] [100 REVERB]
Page: 11 or 14 (13 if Gated or Reverse type)
Parameter: Diffusion (00 to 99)

This sets the number of reflections in the reverb’s decay. The higher the setting, the more reflections there will be.

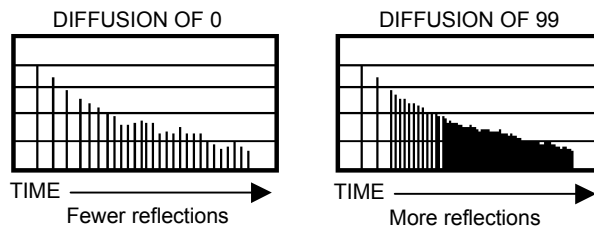

TIP: Greater diffusion works better with percussive sounds, whereas less diffusion work well with vocals and other sustained sounds.

The Overdrive Function [110 OVERDRIVE]

The Overdrive (button [110]) provides a classic distortion effect and is present in Configuration 5 only.

Selecting the Overdrive Type

Button: [EDIT] [EDIT] [110 OVERDRIVE]
Page: 1
Parameter: Ovrdrv (HARD or SOFT)

The **SOFT** Overdrive has less gain and distortion than the **HARD** Overdrive. In addition, the **HARD** Overdrive will only provide distortion when the signal feeding the effect is above the Overdrive Threshold level (see below).

Setting the Hard Overdrive Threshold

Button: [EDIT] [EDIT] [110 OVERDRIVE]
Page: 2
Parameter: Ovrdr Thresh (00 to 99)

This parameter sets the level which the signal must reach before the Overdrive effect will begin distorting. But it works differently than you might expect: A higher value means a lower Threshold. So with a high number, it doesn’t take much input before the Overdrive effect will start to distort. When set to a low number, the distortion will not occur until the signal becomes louder than the Threshold setting.

Setting the Overdrive Brightness

Button: [EDIT] [EDIT] [110 OVERDRIVE]
Page: 3
Parameter: Ovrdr Bright (00 to 99)

This parameter sets the tone of the Overdrive effect. Higher numbers result in a brighter sounding overdrive.

Setting the Overdrive Mix

Button: [EDIT] [EDIT] [110 OVERDRIVE]
Page: 4
Parameter: Mix (CLN<99 to 99>OVDR)

This controls the output mix of the Overdrive effect. When set to **CLN<99**, the Overdrive effect cannot be heard at all. When set to **<0>**, you have an even mix between the original signal and the overdriven signal. When set to **99>OVDR**, only the overdriven effect is heard.

Setting the Effects Output Levels [120 MIX]

The Effect's Mix function (button [120]) is where you can mix the various effects into the output of the QS. Each Effect Send has a separate Mix page for any effect module that feeds the main outputs.

Note that the Mix page doesn't control how much the individual effect modules feed to each other; only how much they feed to the main outputs.

Setting the Effects Mix into the Main Outputs

Button: [EDIT] [EDIT] [120 MIX]
Page: 1 to 5
Parameter: Pitch Outpt, Delay Outpt, Rvb Output, Ovrdrv Out, Lezlie Out (00 to 99)

These pages set the Effect Mix into the main outputs. Depending on the Configuration, you can set the output mix of the Pitch Effect, Delay, Reverb, Overdrive and Lezlie.

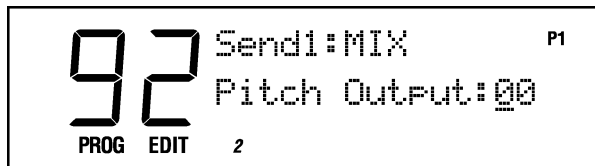

Consult the Configuration charts in the beginning of this chapter to see exactly where the effects are tapped to be mixed into the main outputs. The dotted box labeled "Mix" near the top of each Configuration shows the Mix paths.

NOTE: The page numbers will vary in different Configurations depending on the availability of the effects.

NOTE: If you want to pull down the Reverb level for Send 1 without affecting the other sends, adjust the RvbIn Level parameter (page 4 in most Configurations).

NOTE: Since all of the effects tend to feed into the Reverb, when you pull this parameter down you will be taking down the reverb for all of the sends at once (except for Configuration 2 (2 REVERBS), which contains two separate Reverb effects).

TIP: Even when an effect's output Mix level is set to zero, it can still feed the effects block after it.

How do I split the keyboard?

1. Press the [MIX] button to get into Mix Mode.
2. Select a Mix that has a split, for example, Preset 1 #022 “PercNPed”.
3. Press [PAGE >] to select the first Mix channel.
4. Select the Program for the lower half of the split using the numbered buttons.
5. Press [PAGE >] to select the second Mix channel.
6. Select the Program for the upper half of the split.
7. If you want to store this Mix, hit the [STORE] button, select a User Mix destination, and hit [STORE] again.

NOTE: If only one of the sounds seems to work, make sure the Keyboard Mode (Global Page 6) is set to “NORMAL”. The parameter that sets the split point is the keyboard Range function. Press [MIX] then [EDIT] then [110 RANGE] to set the low and high limits of the Program.

How do I layer two sounds on the keyboard?

1. Press the [MIX] button to get into Mix Mode.
2. Select a Mix that has a layer, for example, Preset1 #000, “Zen Piano”.
3. Press [PAGE >] to select the first Mix channel.
4. Select one of the Programs in the layer using the numbered buttons.
5. Press [PAGE >] to select the second Mix channel.
6. Select the other Program in the layer using the numbered buttons.
7. If you want to store this Mix, hit the [STORE] button, select a User Mix destination, and hit [STORE] again.

NOTE: If only one of the sounds seems to work, make sure the Keyboard Mode (Global Page 6) is set to “NORMAL”.

What is a MIDI Sequence?

A MIDI sequence is a data file containing note data that can be played on a MIDI synthesizer like the QS. A General MIDI sequence is a sequence that will play on any General-MIDI compatible synthesizer (like the QS) with the correct sounds, regardless of the brand of synthesizer.

Where can I get MIDI sequences for the QS?

Since the QS is General MIDI compatible, it can play back any of the thousands of General MIDI sequences that are widely available. For example, there are many General MIDI sequences available on the Internet (go to a search engine and enter for the artist name + “General MIDI”). General MIDI sequences are available for almost every genre of music.

How do I play General MIDI sequences?

Once you find a General MIDI sequence you want to play, you will need either an external sequencer or a computer with a MIDI interface and sequencing software to play it back. For information on how to set up your MIDI connections, see the MIDI chapter of this manual.

You will also need to turn General MIDI mode ON in your QS. This is done on Global display page 7. Hit [EDIT], then [BANK >] to get into Global Mode. Then, hit the [PAGE >] button until you get to display page 7, then turn General MIDI ON.

How do I load sequences into my QS?

To load a sequence, you will need either an SRAM card or a Flash card plugged into the QS’s PCMCIA Expansion Slot, a computer with a MIDI port, and Sound Bridge software (available free on the Alesis Website). Connect your computer’s MIDI port to the QS as described in

the MIDI portion of this manual and consult the Sound Bridge online manual on how to burn a sequence into your card. Once you do this, you can play sequences by pressing the [SEQ SELECT] button and selecting a sequence number.

How do I load samples into the QS?

To load samples, you will need a Flash card plugged in the QS's PCMCIA Expansion Slot, a computer with a MIDI port, and Sound Bridge software (available free on the Alesis Website). Connect your computer's MIDI port to the QS as described in the MIDI portion of this manual and consult the Sound Bridge online manual on how to burn samples into your card.

Where can I get Q Cards?

You can find Q Cards at your local Alesis dealer (where you purchased your QS, for example). In addition, they are available from several nationwide mail-order and internet music equipment dealers.

Where can I get SRAM cards and Flash cards?

SRAM and Flash cards are available from computer stores, mail-order houses, and on the Internet. Check the Alesis website for more information.

Where can I get more Banks?

Additional Program/Mix Banks are available on the Alesis website free of charge.

Are QS6.2/QS8.2 Programs compatible with older QS programs?

Absolutely! You can use QS7, QS8, QS6.1, QS7.1, and QS8.1 programs in your QS6.2 or QS8.2.

How do I change what the sliders do?

To change what the sliders do for a particular Program, go into Edit mode by pressing the [EDIT] button. Select one of the active sounds by pressing one of the [00] – [04] buttons. Next, find which Mod route is currently assigned to the slider by pressing the [0] – [5] buttons. Once you have found the slider (for example, [CNTRL A]), use the [PAGE] buttons to get to the destination and level pages. There, you can modify what the slider is modulating and how much. If you can't find the slider, then it's not modulating anything in that Sound. In this case, you can re-assign one of the Mod routes to the slider.

Where can I get more information on the QS?

There are QS users groups on the Internet with more information. In addition, you can check out the Hal-Leonard book, "Alesis QS Made Easy" by David Crawford.

Using Sound Bridge™ to Create Your Own Sound Cards

The Alesis website (www.alesis.com) contains a free program called Sound Bridge™ for the Mac and PC. Sound Bridge allows you to download your own sequences, Program Banks, and samples into a Flash card plugged into the QS. All you need is a Flash card and a computer with a MIDI interface.

Sound Bridge will also work with SRAM cards, but Flash cards are cheaper for storing large amounts of sample data.

Sound Bridge accepts sound files in .AIF, .AIFF, .SD, and .WAV formats. Many commercially available samples are available in these formats. Or, you can use your computer to create your own samples!

You can also use Sound Bridge to download sequences into your Flash card. Sound Bridge accepts standard MIDI file sequences in .MID, .MIDI, and .SMF formats. You can use your own sequences, or use commercially available General MIDI files from the internet and other sources.

The Alesis website contains the Sound Bridge application, and an electronic manual which will give you all the information you need to know to run Sound Bridge.

NOTE: On some computers, Sound Bridge may appear to "max out" your CPU meter. Don't worry – it will give up CPU bandwidth for other programs. In reality, Sound Bridge only uses a small percentage of your CPU bandwidth.

Sending Sequence Data to External Devices

There is an option box in Sound Bridge which allows you to set up the sequences on a given card so they will be transmitted from the QS's MIDI Output jack.

A setting of OUT causes Card sequence data to play QS Programs only, while allowing the MIDI Out jack to function relatively normally (so you can play your MIDI gear from the keyboard while the sequence is playing).

A setting of THRU passes sequence data on to external MIDI devices from the MIDI Output jack of your QS, allowing both QS Programs and sounds from other MIDI devices to be played from a Card sequence. You will be able to play QS Programs from its keyboard, but you will not be able to play external MIDI devices while the sequence is running.

NOTE: It is highly inadvisable to enter Global Mode and toggle between these two settings while a sequence is running. If this happens, the QS could inadvertently send large bursts of data to your external MIDI devices.

Sound Bridge Instrument Format

Sound Bridge creates a QS Voice (multi-sample) by loading Digidesign Sample Cell I or Sample Cell™ II format Instrument files. Using this format, Sound Bridge is able to determine key group and velocity group split points, root notes, sample playback rates, tunings, start points, loop points, and loop tunings. Sound Bridge can also create QS Voices without Sample Cell Instruments by loading single sound files in a variety of formats.

If you are interested in creating and/or editing your own custom Sample Cell Instruments, you will need Digidesign's Sample Cell™ hardware and software. This is for advanced users who want to create their own multi-sampled instruments.

Sending and Receiving Bank Select Messages

The QS will send and respond to MIDI Bank Select messages in the form of MIDI Controller 0. The value of Controller 0 determines which bank is to be recalled (User, Preset 1–3, GenMIDI, Card). The way the QS handles Bank Select messages depends on the MIDI Program Select mode (set in Global Mode):

MIDI PrgSl: OFF

The QS will neither transmit nor receive Bank Select messages or Program change commands with this setting.

MIDI PrgSl: ON

Reception: Program Mode. If a Bank Select (controller 0) message with a value of 0 is received, it will cause the User Bank to be recalled. If a Bank Select message of 1 is received, Preset Bank 1 will be recalled. Additionally, if a Sound Card is inserted, the Card Banks can be selected using Controller 0 values between 5 and 15.

Reception: Mix Mode. Same as above, except the Mix itself will not change Banks. The word “EDITED” will appear in Mix Play mode screen, because the Mix has been altered to point to another bank on one of its MIDI channels. But you have to look inside the Mix to see that the Bank change occurred.

Transmission: Program Mode. If a new Bank is selected using the [BANK] buttons, a Bank Change message will be transmitted. See Reception: Program Mode for a description of which values will be sent for each Bank as it is selected.

Transmission: Mix Mode. If a new Bank is selected and any of the channels within the Mix have their MIDI Out parameters set to ON (Mix Edit Mode, Keyboard/MIDI function, Page 2), a Bank Select message (followed by a Program change) will be transmitted for each of those MIDI channels.

In **Mix Program Select Mode** (where you choose the Programs within the Mix), any channel which has its MIDI Out set to ON will transmit Bank and Program changes from within the Mix, just like in Program Mode.

MIDI MixSl: CH 1-16

Reception: Program Mode. Same as with MIDI PrgSl: ON (see above).

Reception: Mix Mode. In this mode, when a Bank select message is received on the channel specified by this parameter, the Mix itself will change Banks. Any Program change command on this same channel will call up an entire Mix as if it were a Program. All other channels within the Mix will behave the same way they do when MIDI PrgSl: ON is selected (i.e., they receive Bank and Program changes normally).

Transmission: Program Mode. Same as with MIDI PrgSl: ON (see above).

Transmission: Mix Mode. If a new Bank is selected, the Bank number of the Mix itself will be transmitted on the channel specified by this

NOTE: Bank change messages will be ignored if General MIDI Mode is enabled, so that only Programs within the General MIDI Bank (GenMIDI) can be recalled via MIDI Program changes. The MIDI Program Select parameter will automatically be set to MIDI Prg: ON.

parameter. Selection of another Mix in the same bank will send a Program change command which matches the Mix number.

In **Mix Program Select Mode** (where you choose the Programs within the Mix), changing the Bank of any Program within the Mix will not send a Bank Select command. Selecting a new Program within the Mix will not send a Program change command.

Transmitting MIDI Volume and Panning

Each channel in a Mix can transmit its volume and panning settings via MIDI. For each channel on which you wish to transmit this data, MIDI Out must be set to ON and MIDI Input and Keyboard must be set to OFF. Also, the Keyboard mode must be NORMAL and the MIDI Program Select parameter must be set to ON (Global Mode, pages 6 and 14).

If a channel is set up this way:

- Whenever a Mix is recalled (via the front panel or via MIDI), volume and panning information will be transmitted for that channel;
- Whenever that Channel's "Level" parameter is edited, volume information will be transmitted as Controller #7 on that channel;
- Whenever that Channel's "Pan" parameter is edited, panning information will be transmitted as Controller #10 on that channel. However, panning information will not be sent if the channel's "Pan" parameter is set to PROG.

The seven pan positions in a Mix send the following controller #10 values:

Mix Pan value	CC#10 value
3>	127
2>	107
1>	85
< >	64
<1	43
<2	21
<3	0

Conversely, if you want to change the panning of a QS Program via MIDI, here is what you'll get if you transmit a given Controller #10 value:

CC#10 value	Mix Pan value	Placement
0-20	<3	hard left
21-42	<2	mid left
43-63	<1	soft left
64-84	< >	center
85-106	1>	soft right
107-126	2>	mid right
127	3>	hard right

MIDI Controller Numbers

Each type of controller has its own MIDI controller number. Not all controller numbers have been standardized for specific functions, but the following indicates the current list of assigned controllers. Numbers in parentheses indicate the controller range.

#	Function
0	Bank Select (0-127)
1	Modulation Wheel (0-127)
2	Breath Controller (0-127)
3	Early DX7 Aftertouch (0-127)
4	Foot Controller (0-127)
5	Portamento Time (0-127)
6	Data Slider (0-127)
7	Main Volume (0-127)
8	Balance (0-127)
10	Pan (0-127)
11	Expression (0-127)
16	General Purpose #1 (0-127)
17	General Purpose #2 (0-127)
18	General Purpose #3 (0-127)
19	General Purpose #4 (0-127)
32-63	Least Significant Bits (LSB), Controllers 0-31 (0-127)
64	Sustain Pedal (0 or 127)
65	Portamento On/Off (0 or 127)
66	Sostenuto Pedal (0 or 127)
67	Soft Pedal (0 or 127)
69	Hold 2 (0 or 127)
80	General Purpose #5 (0 or 127)
81	General Purpose #6 (0 or 127)
82	General Purpose #7 (0 or 127)
83	General Purpose #8 (0 or 127)
91	Reverb Depth (0-127)
92	Tremolo Depth (0-127)
93	Chorus Depth (0-127)
94	Celeste Depth (0-127)
95	Phase Depth (0-127)
96	Data Increment (0 or 127)
97	Data Decrement (0 or 127)
98	Non-Registered Parameter MSB (0-127)
99	Non-Registered Parameter LSB (0-127)
100	Registered Parameter MSB (0-127)
101	Registered Parameter LSB (0-127)
121	Reset All Controllers (0)
122	Local Control On/Off (0 or 127)
123	All Notes Off (0)
124	Omni Off (0)
125	Omni On (0)
126	Mono On (0-16; 0=Omni Off)
127	Poly On (0)

MIDI Implementation Chart

Function		Transmitted	Recognized	Remarks
Basic Channel	Default	1 — 16	1 — 16	Memorized
	Changed	1 — 16 each	1 — 16 each	
Mode	Default	Mode 3	Mode 3	
	Messages	X	X	
	Altered	* * * * *		
Note Number		0 — 127	0 — 127	
	True Voice	* * * * *	0 — 127	
Velocity	Note On	O	O	
	Note Off	O	O	
After Touch	Keys	X	O	
	Ch's	O	O	
Pitch Bender		O	O	
Control Change		0 — 120	O	
Prog Change		O ¹ 0 — 127	O ¹ 0 — 127	
	True #	* * * * *	0 — 127	
System Exclusive		O	O	
System Common	Song Pos	X	X	
	Song Sel	X	X	
	Tune	X	X	
System Realtime	Clock	X	X	
	Commands	X	X	
Aux Messages	Local On/Off	X	O ²	
	All Notes Off	X	O	
	Active Sense	X	X	
	Reset	X	O ²	
	GM On	X	O	
Notes		¹ O, X is selectable ² Recognized as ALL NOTES OFF		

Mode 1: OMNI ON, POLY Mode 3: OMNI OFF, POLY O : Yes
 Mode 1: OMNI ON, MONO Mode 4: OMNI OFF, MONO X : No

General MIDI

There are three MIDI registered parameter numbers (RPNs) which the QS will recognize in Mix Mode when General MIDI is enabled. These are:

- **MIDI Registered Parameter 0** (Pitch Bend Sensitivity): This will affect the Pitch Wheel Range parameter of all four Sounds of the Program on the received MIDI Channel of the Mix.
- **MIDI Registered Parameter 1** (Fine Tune): This will affect the Pitch Detune parameter of all four Sounds of the Program on the received MIDI Channel of the Mix. Also, when this RPN is received, the QS will automatically make sure that all four Sounds of the Program have their Detune Type parameter set to “Normal” (Program Edit Mode, Pitch Function, Page 3).
- **MIDI Registered Parameter 2** (Coarse Tune): This will affect the Pitch Semitone parameter of all four Sounds of the Program on the received MIDI Channel of the Mix.

If you experience problems while operating your QS, please use the following table to check for possible causes and solutions *before* contacting Alesis customer service for assistance.

Symptoms	Cause	Solution
The display does not light up when the ON/OFF switch is turned on.	No power.	Check that the power cable is plugged in properly.
No sound.	Bad Connections.	Check your audio cables; if necessary, swap cables.
	Volume is turned down.	Raise the [VOLUME] slider or Pedal 1.
	Keyboard Mode is set incorrectly.	Set the Keyboard Mode to NORMAL. (Global Parameter page 6)
	External MIDI device sent Volume (CC#7) or Expression (CC#11) commands with a value approaching 0.	Switch QS from Mix Mode to Program Mode or vice versa to reset the MIDI Volume. Re-transmit higher values from MIDI device.
MIDI input in Mix mode isn't working (i.e., you can't control your unit via MIDI from a sequencer or some other controller).	Trying to record onto a track higher than the current Song allows. INPUT SELECT is set to 2, 4, 8, or 12-input mode. EDIT PREVIEW plays back only tracks selected for editing.	Copy all tracks, and paste into a new song defined as having more tracks. Reset INPUT SELECT for 24-input mode. To hear all tracks, deselect any tracks selected for editing using TRACK EDIT.
Notes sustain continuously.	Sustain pedal was plugged in after power was turned on. Stuck notes due to incomplete MIDI data.	Turn the unit's power off, wait a moment, and then turn it on again. Switch QS from Mix Mode to Program Mode or vice versa.
Notes played from QS have a "doubled" or "flanged" sound	MIDI echo/Thru enabled on external MIDI device or computer	Disable MIDI echo/Thru on external MIDI device Put QS into Out 01 mode (Global Mode, page 6)
Mod Wheel not working well (or at all)	Unit was re-initialized with Mod Wheel up	Put Mod Wheel all the way down and re-initialize
LCD shows "ADDRESS ERROR"	Bad Sys-ex data sent to QS via MIDI input	Re-initialize. If it persists, load in known good bank.

Recovering from a Crash

If your QS behaves erratically or “freezes” on you, the first thing to try is to switch between Mix and Program modes once. If that doesn’t do anything, turn it off, wait for a moment, and then turn it on again. Make sure you turn off any amplification first!

If your instrument still isn’t working after that, then disconnect the [MIDI IN] cable and repeat the power on/off trick. This ought to work if your problem is being caused by strange MIDI data coming from an external MIDI device.

If neither of these work, you will have to re-initialize the instrument.

Re-Initializing

Re-initializing will reset all Global parameters to their factory default settings and empty out the edit buffers. The Programs and Mixes in the User Bank will be preserved, though. Here’s how to do it:

- 1) Turn down the volume on your QS, your mixer, and your amplifier.
- 2) Turn off your QS.
- 3) Make sure the [MODULATION] wheel is all the way down.
- 4) Turn on your QS while holding down buttons [0] and [3]. You’ll know you were successful if there is no name in the LCD display on the top line.
- 5) Remember to go back into Global Mode and set up things the way you had them (things like the Keyboard Mode, Transposition, the A-D MIDI controller number assignments, etc.).

Checking the Software Version

To find out what version of the operating system software is currently installed in your QS, hold down [PROGRAM] and [0] at the same time and look in the display.

Cleaning Your QS

Before doing cleaning of any kind, always disconnect the AC cord.

For simple dusting and removal of minor dirt, wipe the instrument down with a slightly damp cloth.

For heavy dirt, use a non-abrasive household cleaner such as Formula 409 or Fantastik. Spray the cleanser onto a cloth, then use the cloth to clean the unit.



NEVER spray any cleaner directly onto the QS — this can destroy the lubricants used in the switches and controls!

Specifications

Sound Generation Method:

QS Composite Synthesis™ 16 Bit Linear 48kHz Sample ROM with lowpass filter

Polyphonic Voices:

64, each with sweepable lowpass filter, 3 envelope generators, 3 LFOs, programmable effects send and QS Modulation Matrix, dynamic voice allocation; 16-part multitimbral

Audio Section:

Alesis 24-bit Stereo DAC with 128x oversampling delta-sigma converter

Keyboard:

QS6.2: 61 synth-action keys (velocity, release velocity, aftertouch)
QS8.2: 88 hammer-action weighted keys (velocity, release velocity)

Waveform Memory:

16MB, expandable to 24 MB via PCMCIA Expansion Card

Program Memory:

Program Mode (512 Preset, 128 User)
Mix Mode (400 Preset, 100 User)

Effects:

QS Parallel Matrix Effects™ (4 independent stereo multieffect processing busses)

Multitimbral Mode:

QS Mix Mode™ (64-part multitimbral across 16 MIDI channels)

Controllers:

4 control sliders, programmable pitch and modulation wheels, foot pedals, aftertouch (in QS6.2 only)

Expansion Slot:

Type I PCMCIA (PC Card) slot, compatible with QCards, SRAM and Flash cards (up to 8MB) with 120ns access time or faster.

Pedal Jacks:

Assignable Aux pedal, Sustain pedal

MIDI Connections:

MIDI In, Out, Thru

Audio Outputs:

Main L/R (1/4"), Headphone (1/4" TRS)

Power:

Internal Transformer

Dimensions (WxHxD):

QS6.2: 36.0" x 3.5" x 11.25" (915mm x 89mm x 286mm)
QS8.2: 50.5" x 4.3" x 13.5" (1283mm x 110mm x 343mm)

Weight:

QS6.2: 18.5 lbs. (8.4 kg)
QS8.2: 48.0 lbs. (21.8 kg)

Index

- 1 Pitch keyboard mode, 41
- 1 Reverb configuration, 72
- 2 Reverbs configuration, 73
- aftertouch, 15
 - filter depth, 42
 - LFO depth, 54
 - pitch bend amount, 40
 - volume increase, 43
- amp LFO function, 52
- amp/env function, 61
- amp/range function, 43
- amplifier, 33
- amplitude
 - LFO amount, 44
 - velocity curve, drum, 60
- amplitude envelope function, 45
- auditioning Programs, 48
- Banks, 15
- bass boost, 76
- card
 - playing sequences, 21
 - playing sounds, 21
- chorus effect, 80
- cleaning, 98
- Compare button, 20
- Configuration, 71
- connections, 11
- controllers function, 67
- copying, 16
 - Sound layers, 48
- crash, 98
- delay effect, 82
 - time, 83
- demo sequences, 13
- detune effect, 80, 81
- double-button press trick, 20
- Drum Mode, 36, 57
 - amplitude, 60
 - base note, 61
 - decay time, 61
 - editing, 57
 - effects send, 59
 - mute groups, 61
 - note range, 61
 - pitch, 60
 - selecting a drum Sound, 57
 - volume, 59
- Edit, 19
 - buttons, 19
 - Mix, 63
 - Program, 35
- effects, 35, 69
 - chorus, 80
 - clipping, 71
 - configuration, 71
 - copying, 70
 - delay, 82
 - detune, 81
 - editing, 69
 - EQ, 76
 - flanger, 81
 - gated reverb, 85
 - Lezlie, 78
 - Mix, 65
 - modulating, 77
 - output mix, 88
 - overdrive, 87
 - pitch effects, 79
 - resonator, 81
 - reverb, 83
 - selecting a Send to edit, 76
 - send levels, 69
 - storing, 70
- envelope, 34
 - parameters, 45
 - trigger type, 46
- EQ, 76
- filter
 - envelope amount, 43
 - frequency, 41
 - function, 41
 - LFO amount, 42
 - velocity curve, drum, 60
 - velocity tracking, 42
- filter envelope function, 44
- filter LFO function, 52
- fine tune, 29
- flanger, 80
- flash card, 21, 90
- foot pedals, 11
- freerun envelope mode, 46
- FX send
 - Mix, 65
 - Program, 39
- General MIDI, 31, 89
 - registered parameters, 96
- Global, 29
- grounding, 7
- key tracking, 46, 47
- keyboard
 - mode, 30
 - splits, 44
- keyboard/MIDI function, 66
- Keymono, 54
- Keypoly, 54
- layering sounds, 89
- level function, 38
 - Mix, 64
- Lezlie, 78
- Lezlie+Reverb configuration, 74
- LFO, 34
 - delay, 53
 - level, 54
 - speed, 53
 - waveforms, 53
- lowpass filter, 33
- master pitch, 29
- MIDI, 25
 - bank select messages, 93
 - changing channels, 27
 - connections, 25
 - controller numbers, 31, 95

Index

- out port behavior, 32
- pass-through, 26
- sequencing, 26
- slave, 26
- storing via, 27, 28
- volume and panning, 94
- mix function, 88
- Mixes, 14, 63
 - changing Programs in, 14, 63
 - controllers, 67
 - edit buffers, 68
 - edit mode, 63
 - effects, 65
 - effects selection, 66
 - enabling a channel, 64
 - level, 64
 - naming, 68
 - playing, 18
 - setting channel volume, 64
 - split point, 68
- mod function
 - effects, 77
- mod routes
 - destinations, 51
 - editing, 50
 - effects, 77
 - gate, 52
 - hard-wired, 49
 - level, 52
 - sources, 50
- mod wheel, 15
 - filter depth, 42
 - LFO depth, 54
- modulation, 34, 49
- monophonic, 41
- mute groups, 61
- name
 - Mix, 68
 - Program, 47
- overdrive effect, 87
- Overdrive+Lezlie configuration, 75
- Page buttons, 18
- pan
 - drum, 59
 - Mix, 64
 - Program, 38
- PCMCIA expansion cards, 21
- pitch
 - detune, 39
 - drum, 60
 - effects, 79
 - function, 39
 - Mixes, 65
 - Program, 39
- pitch envelope
 - amount, 40
 - function, 44
- pitch LFO function, 52
- pitch wheel, 15
 - bend amount, 40
- plate reverb, 85
- polyphonic, 41
- polyphony, 33
- portamento
 - mode, 41
- power cable, 7
- power connections, 11
- Programs
 - playing, 13, 18
- Q Cards, 21, 90
- quantization
 - mod route, 52
- range function, 67
- re-initializing, 98
- resetting parameter values, 20
- resonator effect, 80, 81
- reverb, 83
 - decay time, 86
 - diffusion, 87
 - plate, 85
 - predelay, 86
 - types, 85
- Reverb+EQ configuration, 75
- safety, 7
- samples, 33
 - loading your own, 90
 - selection, 36
- sequence, 89
- sequencer, 27
- sliders, 15, 90
- software version, 98
- Sound, 33, 35
 - enabling, 36
 - volume, 38
- Sound Bridge, 91
- sound overlap, 44
- specifications, 99
- splitting the keyboard, 68, 89
- SRAM cards, 21
 - formatting, 22
 - loading from, 22
 - saving, 22
- storing, 16
- sustain pedal, 11, 47
- Tracking Generator, 54
- transposing, 15, 30
 - Mixes, 65
- troubleshooting, 97
- Value buttons, 18
- velocity, 15
 - curve, 29, 43
 - scaling, 30
- voice, 33
- Voice function, 36
- website, 10

Warranty / Contact Alesis

Alesis Limited Warranty

ALESIS CORPORATION ("ALESIS") warrants this product to be free of defects in material and workmanship for a period of one (1) year for parts and for a period of one (1) year for labor from the date of original retail purchase. This warranty is enforceable only by the original retail purchaser and cannot be transferred or assigned.

The purchaser should complete and return the enclosed warranty card within 14 days of purchase. During the warranty period ALESIS shall, at its sole and absolute option, either repair or replace free of charge any product that proves to be defective on inspection by ALESIS or its authorized service representative. In all cases disputes concerning this warranty shall be resolved as prescribed by law.

To obtain warranty service, the purchaser must first call or write ALESIS at the address and telephone number printed below to obtain a Return Authorization Number and instructions concerning where to return the unit for service. All inquiries must be accompanied by a description of the problem. All authorized returns must be sent to ALESIS or an authorized ALESIS repair facility postage prepaid, insured and properly packaged. Proof of purchase must be presented in the form of a bill of sale, canceled check or some other positive proof that the product is within the warranty period. ALESIS reserves the right to update any unit returned for repair. ALESIS reserves the right to change or improve design of the product at any time without prior notice.

This warranty does not cover claims for damage due to abuse, neglect, alteration or attempted repair by unauthorized personnel, and is limited to failures arising during normal use that are due to defects in material or workmanship in the product.

THE ABOVE WARRANTIES ARE IN LIEU OF ANY OTHER WARRANTIES OR REPRESENTATIONS WHETHER EXPRESS OR IMPLIED OR OTHERWISE, WITH RESPECT TO THE PRODUCT, AND SPECIFICALLY EXCLUDE ANY IMPLIED WARRANTIES OF FITNESS FOR A PARTICULAR PURPOSE OR MERCHANTABILITY OR OTHER IMPLIED WARRANTIES. Some states do not allow limitations on how long an implied warranty lasts, so the above limitation may not apply to you.

IN NO EVENT WILL ALESIS BE LIABLE FOR INCIDENTAL, CONSEQUENTIAL, INDIRECT OR OTHER DAMAGES RESULTING FROM THE BREACH OF ANY EXPRESS OR IMPLIED WARRANTY, INCLUDING, AMONG OTHER THINGS, DAMAGE TO PROPERTY, DAMAGE BASED ON INCONVENIENCE OR ON LOSS OF USE OF THE PRODUCT, AND, TO THE EXTENT PERMITTED BY LAW, DAMAGES FOR PERSONAL INJURY. Some states do not allow the exclusion or limitation of incidental or consequential damages, so the above limitation or exclusion may not apply to you. THIS CONTRACT SHALL BE GOVERNED BY THE INTERNAL LAWS OF THE STATE OF CALIFORNIA WITHOUT REFERENCE TO CONFLICTS OF LAWS. This warranty gives you specific legal rights, and you may also have other rights required by law which vary from state to state.

This warranty only applies to products sold to purchasers in the United States of America or Canada. The terms of this warranty and any obligations of Alesis under this warranty shall apply only within the country of sale. Without limiting the foregoing, repairs under this warranty shall be made only by a duly authorized Alesis service representative in the country of sale. For warranty information in all other countries please refer to your local distributor.

For more effective service and product update notices, please register your QS online at:

<http://www.alesis.com/support/warranty.htm>

Alesis Contact Information

Alesis Distribution, LLC
Los Angeles, USA

E-mail: support@alesis.com
Website: <http://www.alesis.com>

Alesis QS6.2/QS8.2 Reference Manual
Revision 1.0 by Brian Shim, with help from Taiho Yamada

Copyright 2002, Alesis Distribution, LLC. All rights reserved
Reproduction in whole or in part is prohibited. "QS6.2" and "QS8.2" are trademarks of Alesis Distribution, LLC. Specifications subject to change without notice.

7-51-0103A
5/23/2002

Free Manuals Download Website

<http://myh66.com>

<http://usermanuals.us>

<http://www.somanuals.com>

<http://www.4manuals.cc>

<http://www.manual-lib.com>

<http://www.404manual.com>

<http://www.luxmanual.com>

<http://aubethermostatmanual.com>

Golf course search by state

<http://golfingnear.com>

Email search by domain

<http://emailbydomain.com>

Auto manuals search

<http://auto.somanuals.com>

TV manuals search

<http://tv.somanuals.com>