

User Manual

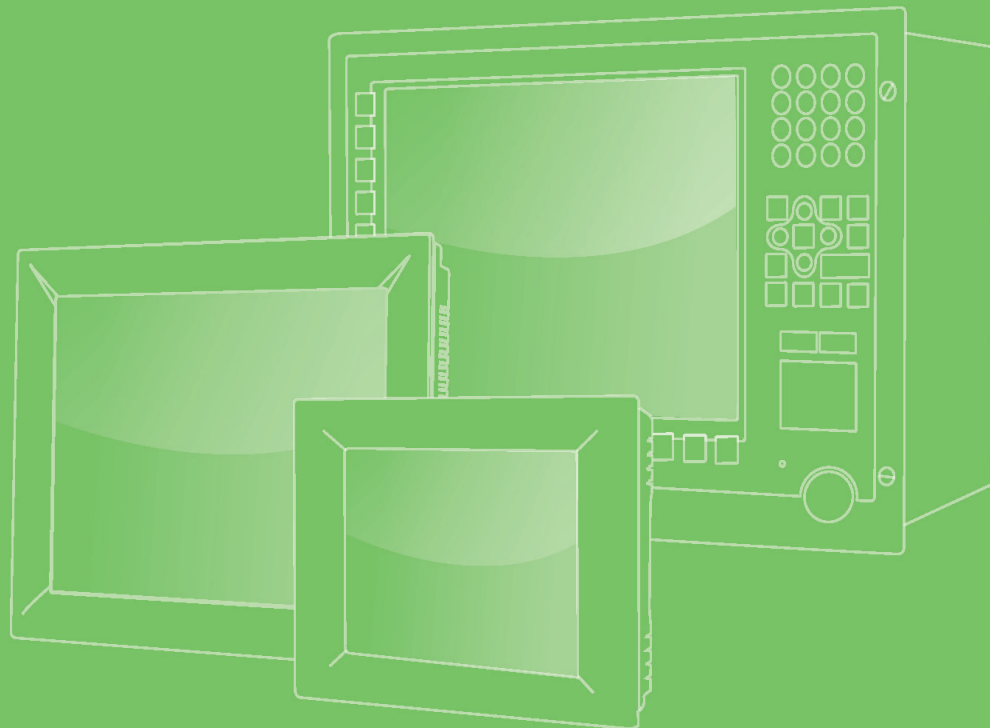

FPM-8192V/8232V

19"/23" Marine Grade Monitors

ADVANTECH
eAutomation

Copyright

The documentation and the software included with this product are copyrighted 2008 by Advantech Co., Ltd. All rights are reserved. Advantech Co., Ltd. reserves the right to make improvements in the products described in this manual at any time without notice. No part of this manual may be reproduced, copied, translated or transmitted in any form or by any means without the prior written permission of Advantech Co., Ltd. Information provided in this manual is intended to be accurate and reliable. However, Advantech Co., Ltd. assumes no responsibility for its use, nor for any infringements of the rights of third parties, which may result from its use.

Acknowledgements

Intel and Pentium are trademarks of Intel Corporation.

Microsoft Windows and MS-DOS are registered trademarks of Microsoft Corp.

All other product names or trademarks are properties of their respective owners.

Product Warranty (2 years)

Advantech warrants to you, the original purchaser, that each of its products will be free from defects in materials and workmanship for two years from the date of purchase.

This warranty does not apply to any products which have been repaired or altered by persons other than repair personnel authorized by Advantech, or which have been subject to misuse, abuse, accident or improper installation. Advantech assumes no liability under the terms of this warranty as a consequence of such events.

Because of Advantech's high quality-control standards and rigorous testing, most of our customers never need to use our repair service. If an Advantech product is defective, it will be repaired or replaced at no charge during the warranty period. For out-of-warranty repairs, you will be billed according to the cost of replacement materials, service time and freight. Please consult your dealer for more details.

If you think you have a defective product, follow these steps:

1. Collect all the information about the problem encountered. (For example, CPU speed, Advantech products used, other hardware and software used, etc.) Note anything abnormal and list any onscreen messages you get when the problem occurs.
2. Call your dealer and describe the problem. Please have your manual, product, and any helpful information readily available.
3. If your product is diagnosed as defective, obtain an RMA (return merchandise authorization) number from your dealer. This allows us to process your return more quickly.
4. Carefully pack the defective product, a fully-completed Repair and Replacement Order Card and a photocopy proof of purchase date (such as your sales receipt) in a shippable container. A product returned without proof of the purchase date is not eligible for warranty service.
5. Write the RMA number visibly on the outside of the package and ship it prepaid to your dealer.

Part No.2003819200

Printed in Taiwan

Edition 1

December 2008

Declaration of Conformity

CE

This product has passed the CE test for environmental specifications when shielded cables are used for external wiring. We recommend the use of shielded cables. This kind of cable is available from Advantech. Please contact your local supplier for ordering information.

CE

This product has passed the CE test for environmental specifications. Test conditions for passing included the equipment being operated within an industrial enclosure. In order to protect the product from being damaged by ESD (Electrostatic Discharge) and EMI leakage, we strongly recommend the use of CE-compliant industrial enclosure products.

FCC Class A

Note: This equipment has been tested and found to comply with the limits for a Class A digital device, pursuant to part 15 of the FCC Rules. These limits are designed to provide reasonable protection against harmful interference when the equipment is operated in a commercial environment. This equipment generates, uses, and can radiate radio frequency energy and, if not installed and used in accordance with the instruction manual, may cause harmful interference to radio communications. Operation of this equipment in a residential area is likely to cause harmful interference in which case the user will be required to correct the interference at his own expense.

FCC Class B

Note: This equipment has been tested and found to comply with the limits for a Class B digital device, pursuant to part 15 of the FCC Rules. These limits are designed to provide reasonable protection against harmful interference in a residential installation. This equipment generates, uses and can radiate radio frequency energy and, if not installed and used in accordance with the instructions, may cause harmful interference to radio communications. However, there is no guarantee that interference will not occur in a particular installation. If this equipment does cause harmful interference to radio or television reception, which can be determined by turning the equipment off and on, the user is encouraged to try to correct the interference by one or more of the following measures:

- Reorient or relocate the receiving antenna.
- Increase the separation between the equipment and receiver.
- Connect the equipment into an outlet on a circuit different from that to which the receiver is connected.
- Consult the dealer or an experienced radio/TV technician for help.

FM

This equipment has passed the FM certification. According to the National Fire Protection Association, work sites are classified into different classes, divisions and groups, based on hazard considerations. This equipment is compliant with the specifications of Class I, Division 2, Groups A, B, C and D indoor hazards.

Technical Support and Assistance

1. Visit the Advantech web site at www.advantech.com/support where you can find the latest information about the product.
2. Contact your distributor, sales representative, or Advantech's customer service center for technical support if you need additional assistance. Please have the following information ready before you call:
 - Product name and serial number
 - Description of your peripheral attachments
 - Description of your software (operating system, version, application software, etc.)
 - A complete description of the problem
 - The exact wording of any error messages

Warnings, Cautions and Notes

Safety Precaution - Static Electricity

Warning! *Warnings indicate conditions, which if not observed, can cause personal injury!*



Caution! *Cautions are included to help you avoid damaging hardware or losing data. e.g.*



There is a danger of a new battery exploding if it is incorrectly installed. Do not attempt to recharge, force open, or heat the battery. Replace the battery only with the same or equivalent type recommended by the manufacturer. Discard used batteries according to the manufacturer's instructions.

Note! *Notes provide optional additional information.*



Follow these simple precautions to protect yourself from harm and the products from damage.

- To avoid electrical shock, always disconnect the power from your PC chassis before you work on it. Don't touch any components on the CPU card or other cards while the PC is on.

Disconnect power before making any configuration changes. The sudden rush of power as you connect a jumper or install a card may damage sensitive electronic components.

Safety Instructions

1. Read these safety instructions carefully.
2. Keep this User Manual for later reference.
3. Disconnect this equipment from any AC outlet before cleaning. Use a damp cloth. Do not use liquid or spray detergents for cleaning.
4. For plug-in equipment, the power outlet socket must be located near the equipment and must be easily accessible.
5. Keep this equipment away from humidity.
6. Put this equipment on a reliable surface during installation. Dropping it or letting it fall may cause damage.
7. The openings on the enclosure are for air convection. Protect the equipment from overheating. **DO NOT COVER THE OPENINGS.**
8. Make sure the voltage of the power source is correct before connecting the equipment to the power outlet.
9. Position the power cord so that people cannot step on it. Do not place anything over the power cord.
10. All cautions and warnings on the equipment should be noted.
11. If the equipment is not used for a long time, disconnect it from the power source to avoid damage by transient overvoltage.
12. Never pour any liquid into an opening. This may cause fire or electrical shock.
13. Never open the equipment. For safety reasons, the equipment should be opened only by qualified service personnel.
14. If one of the following situations arises, get the equipment checked by service personnel:
 15. The power cord or plug is damaged.
 16. Liquid has penetrated into the equipment.
 17. The equipment has been exposed to moisture.
 18. The equipment does not work well, or you cannot get it to work according to the user's manual.
 19. The equipment has been dropped and damaged.
 20. The equipment has obvious signs of breakage.
21. **DO NOT LEAVE THIS EQUIPMENT IN AN ENVIRONMENT WHERE THE STORAGE TEMPERATURE MAY GO BELOW -20° C (-4° F) OR ABOVE 60° C (140° F). THIS COULD DAMAGE THE EQUIPMENT. THE EQUIPMENT SHOULD BE IN A CONTROLLED ENVIRONMENT.**
22. **CAUTION: DANGER OF EXPLOSION IF BATTERY IS INCORRECTLY REPLACED. REPLACE ONLY WITH THE SAME OR EQUIVALENT TYPE RECOMMENDED BY THE MANUFACTURER, DISCARD USED BATTERIES ACCORDING TO THE MANUFACTURER'S INSTRUCTIONS.**
23. The sound pressure level at the operator's position according to IEC 704-1:1982 is no more than 70 dB (A).

DISCLAIMER: This set of instructions is given according to IEC 704-1. Advantech disclaims all responsibility for the accuracy of any statements contained herein.

Chapter 1	General Information	1
1.1	Introduction	2
1.1.1	Features	2
1.1.2	Basic Construction of Marine Bridge System Display	3
	Figure 1.1 Basic Construction.....	3
1.2	Touchscreen Solution (Optional).....	4
1.2.1	Five-Wire Resistive Touchscreen (Optional 1)	4
1.2.2	SecureTouch Surface Wave Touchscreen (Optional 2)	5
Chapter 2	Installation.....	7
2.1	General Installation	8
2.2	Installation Notice.....	11
2.2.1	Brightness Control Knob Precaution.....	11
2.2.2	Cable Connection Precaution	11
Chapter 3	Operating the LCD Display	13
3.1	OSD User Controls	14
	Figure 3.1 OSD User Controls.....	14
3.2	PIP (Picture in Picture) Function	15
3.3	Auto Adjustment Function	15
3.4	Source Function	15
3.5	OSD Menu Function.....	15
	Figure 3.2 OSD Menu.....	16
3.6	Display Item Menu	17
	Figure 3.3 Display Item Menu.....	17
3.7	Image Item Menu	18
	Figure 3.4 Image Item Menu (VGA).....	18
	Figure 3.5 Image Item Menu (DVI)	18
	Figure 3.6 Image Item Menu (Composite, S-Video)	19
3.7.1	Position Item Menu	20
	Figure 3.7 Position Item Menu (VGA).....	20
	Figure 3.8 Position Item Menu (DVI, Composite, S-Video)	20
3.7.2	Color Item Menu	21
	Figure 3.9 Color Item Menu (VGA).....	21
	Figure 3.10Color Item Menu (DVI, Composite, S-Video).....	22
3.7.3	PIP Control Item Menu.....	23
	Figure 3.11PIP Control Item Menu	23
3.7.4	Main Display Item Menu	24
	Figure 3.12Main Display Item Menu	24
3.7.5	PIP Display Item Menu	24
	Figure 3.13PIP Display Item Menu	24
3.7.6	Audio Item Menu (Optional).....	25
	Figure 3.14Audio Item Menu	25
3.7.7	Reset Item Menu.....	26
	Figure 3.15Reset Item Menu	26
Appendix A	Cleaning the Monitor	27
A.1	Cleaning the Monitor	28
Appendix B	Troubleshooting	29
B.1	Disclaimer	30

B.2	Troubleshooting	30
Appendix C	Supported Modes.....	31
C.1	Graphics.....	32
C.2	Video.....	32
Appendix D	RS-232 Command Code (Optional) .	33
D.1	RS-232 Command Code.....	34
Appendix E	Transflective Display (Optional)	35
E.1	Transflective Display	36
E.2	Features.....	36
E.3	Transflective Brightness Testing.....	37
	E.3.1 Dark Room Testing Instructions	37
	E.3.2 Environment: Outdoor Readability Measure.....	38
E.4	Caution on Handling Transflective LCD	38
	E.4.1 Operation & Storage Temperature Caution	38
	E.4.2 Contrast Ratio to Ambient Light Caution	38
	E.4.3 Protection Glass Selection.....	38
E.5	Touchscreen Selection	39

Chapter 1

General Information

1.1 Introduction

The Marine Bridge System Displays are an extraordinary display design with sunlight readable high quality panel, dimming brightness, ease of use OSD front panel control, IP65 proof, multi-scan video function, high quality touchscreen, wide voltage range power input acceptable, and anti-corrosion protection. Born to the demands of maritime applications such as navigation, ship automation and surveillance.

All product designs follow IEC-60945 Maritime Navigation and Radio-communication Equipment and Systems requirements.

1.1.1 Features



Full-range durable displays

The Marine Bridge System Displays use high quality branding TFT LCD displays with high resolution and wide temperature range panels. From 8.4 inch to 23.1 inch, we offer a wide range choice fulfilling any demand in Marine market.

Hyper Dimming

Our displays use hyper dimming technology that can control backlight brightness linearly from nearly 0% to 100% by a dimming knob. In the night vision it's very suitable for marine applications.

Sunlight Readable (Optional)

Our extraordinary transfective film technology enhances visibility for Marine outdoor or bright ambience environment. (Outdoor readability please take reference to Appendix E)

Anti-corrosion IP Proof (Optional)

The Marine displays design with panel (flush) mount IP65 aluminum housing with powder coating design (IP54 rear) achieve the anti-corrosion proof in harsh conditions.

Touchscreen / Anti-reflection Protection Glass

We develop highly compatible mechanical design for each type. Customers can choose high quality SAW touchscreen, 5 wire resistive touchscreen, or even anti-reflection protection glass for option.

Multi-scan Function

The display can accept multi-video inputs as DVI, VGA, S-Video or Composite for example. From 10.4 inch to 23.1 inch displays, our outstanding scaling board design also support PIP (picture in picture) function for special marine applications.

IP65 OSD Front Panel Design

With IP65 water-dust front bezel proof, the Marine Bridge System Displays use easy to use front panel OSD control. It's very convenience and intelligent design for all maritime users.

Anti-Shock and Vibration

Base on our well-experience modulized competence, we can do very flexible and tailor-made design fulfilling any of customer's solution. For different panel characteristics, mechanical design, and electronic component, we can make it for you.

Approved Marine Displays

Advantech's Marine Bridge System Display design are all followed **IEC-60945 Maritime Navigation and Radio-communication Equipment and Systems requirements**.

The Marine Bridge System Display series consists wide range sizes from 8.4 inches to 23.1 inches. By testing for usability in a ship's wheelhouse during different ambient light conditions. All these models can fulfill most of the demands in maritime applications especially for navigation, ship automation and maritime surveillance.

1.1.2 Basic Construction of Marine Bridge System Display

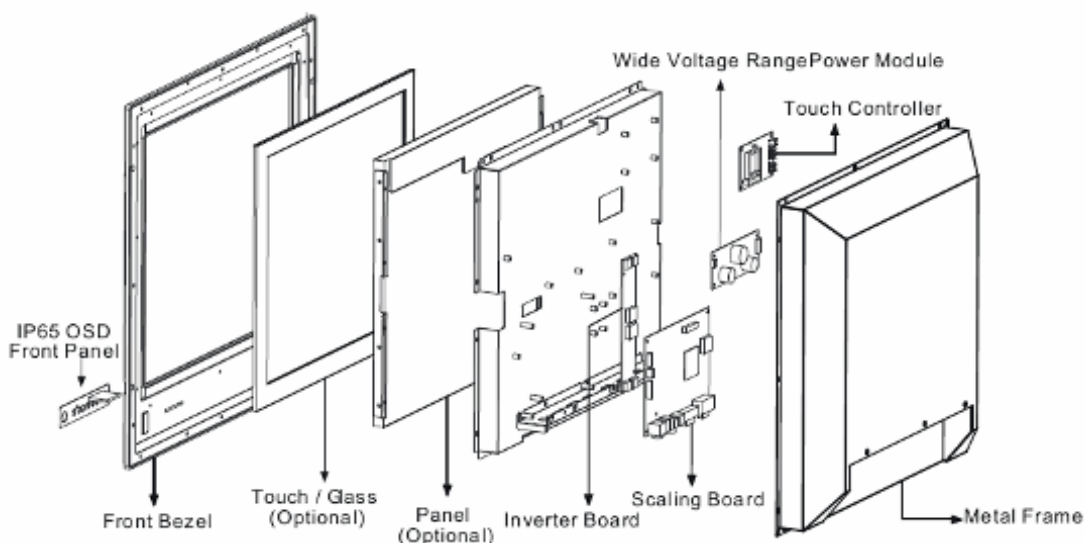

Figure 1.1 Basic Construction

1.2 Touchscreen Solution (Optional)

1.2.1 Five-Wire Resistive Touchscreen (Optional 1)

Introduction to Five-Wire Resistive Touchscreen

The five-wire resistive touchscreens use a glass panel with a uniform resistive coating. A thick polyester coversheet is tightly suspended over the top of the glass, separated by small, transparent insulating dots. The coversheet has a hard, durable coating on the outer side and a conductive coating on the inner side.



When the screen is touched, the conductive coating makes electrical contact with the coating on the glass. The voltages produced are the analog representation of the position touched. The controller digitizes these voltages and transmits them to the computer for processing. The five-wire technology utilizes the bottom substrate for both X and Y-axis measurements. The flexible coversheet acts only as a voltage-measuring probe. This means the touchscreen will continue working properly even with non-uniformity in the cover sheet's conductive coating. The result is an accurate, durable and reliable touchscreen that offers drift free operation. The touchscreens are sealed against contamination and moisture. The coversheet is sealed to the glass substrate with an industrial grade caulk. This prevents wicking of fluid between the coversheet and glass. Also, the touchscreens are not air vented, thereby preventing fluid ingress through an air vent.

Brief Specifications

Subject	Details
Input Method	Finger, gloved hand, or stylus activation
Positional Accuracy	Standard deviation error is less than 0.080 (2 mm)
Resolution	Touchpoint density is based on controller resolution of 4096 x 4096
Touch Activation Force	Typically less than 4 ounces (113 grams)
Light Transmission	HL products: 80% +/-5% at 550 nm wavelength Enhanced products: 60% +/-5% at 550 nm wavelength

1.2.2 SecureTouch Surface Wave Touchscreen (Optional 2)

Introduction to SAW Touchscreen

The surface wave is the optical standard of touch. Its pure glass construction provides superior optical performance and makes it the most scratch-resistant technology available. It's nearly impossible to physically "wear out" this touchscreen.

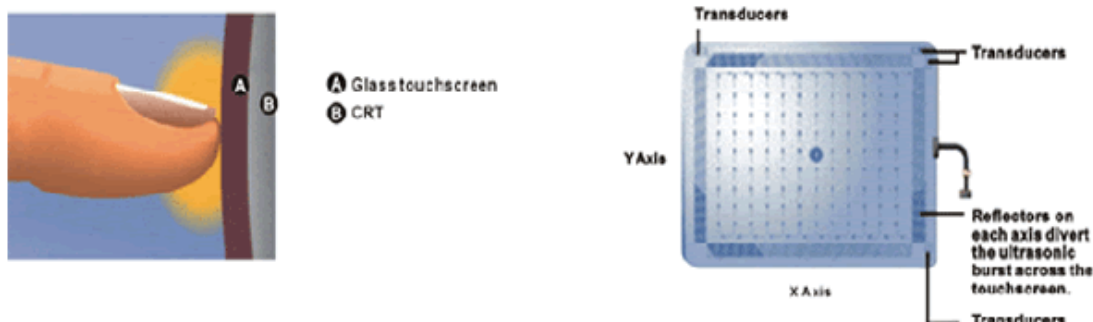

The touch have a glass overlay with transmitting and receiving piezoelectric transducers for both the X and Y axes. The touchscreen controller sends a five-megahertz electrical signal to the transmitting transducer, which converts the signal into ultrasonic waves within the glass. These waves are directed across the front surface of the touchscreen by an array of reflectors. Reflectors on the opposite side gather and direct the waves to the receiving transducer, which reconverts them into an electrical signal—a digital map of the touchscreen surface.

When you touch the screen, you absorb a portion of the wave traveling across it. The received signal is then compared to the stored digital map, the change recognized, and a coordinate calculated. This process happens independently for both the X and Y axes. By measuring the amount of the signal that is absorbed, a Z-axis is also determined. The digitized coordinates are transmitted to the computer for processing.

Brief Specifications

Subject	Details
Input Method	Finger or gloved hand (cloth, leather, or rubber) activation
Positional Accuracy	Standard deviation of error is less than 0.080 in. (2 mm)
Resolution	Touchpoint density is based on controller resolution of 4096 x 4096, plus 255 levels corresponding to touch pressure
Touch Activation Force	Typically 2 to 3 ounces (55 to 85 grams)
Light Transmission	Up to 90% per ASTM D1003-92

Chapter 2

Installation

2.1 General Installation

The Marine Bridge System Display can be applied for several different installation methods. Including panel (flush) mounting, bracket mounting, ceiling / wall mounting...etc. For panel (flush) mounting is normally for a ship's wheelhouse use, it's easy to follow few steps to fix the display product in customer's fixture.

Check the mechanical and mounting concept as below first. The fixture cut-out dimension and mounting holes based on drawing.

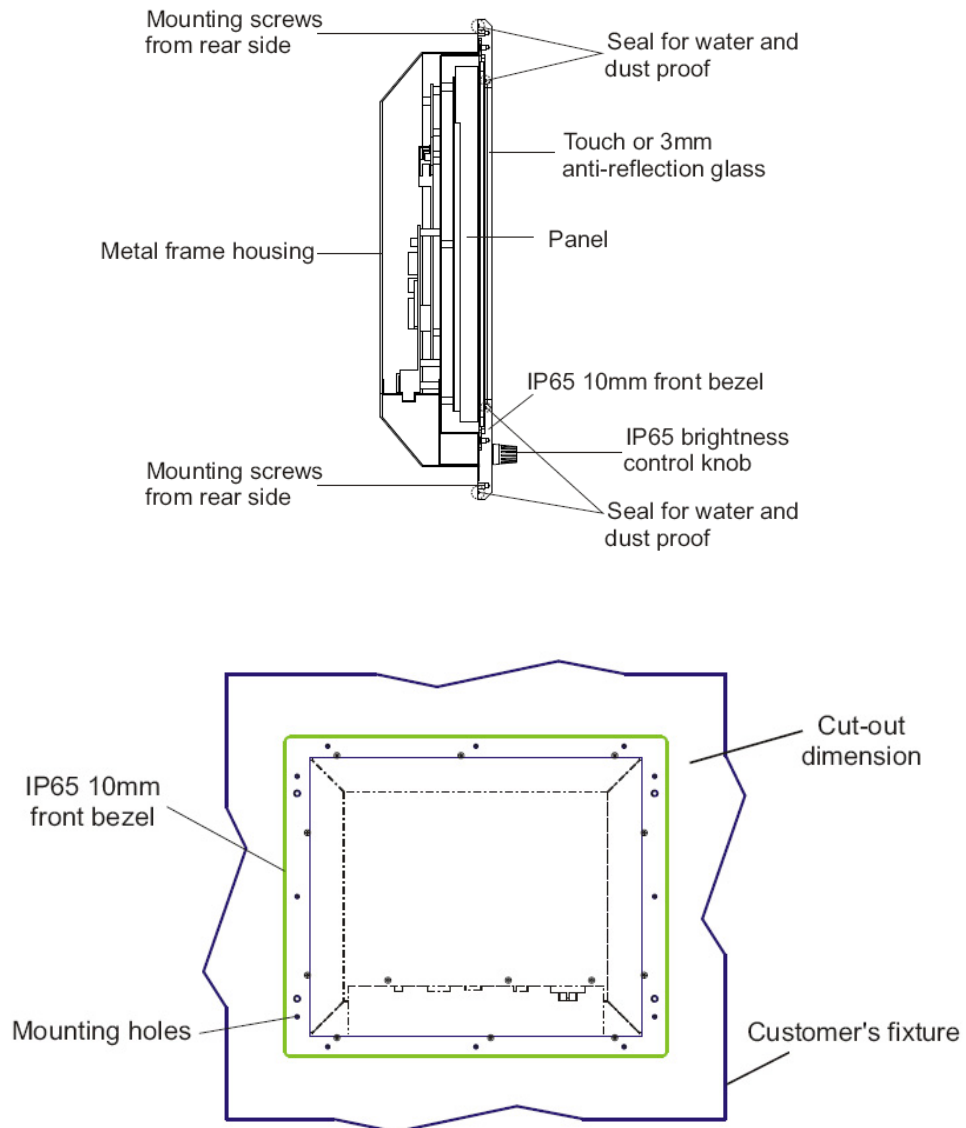

1. Put the marine product on the fixture (console) from the front, and screw by four M6 x 30 mm black bolts with nuts.

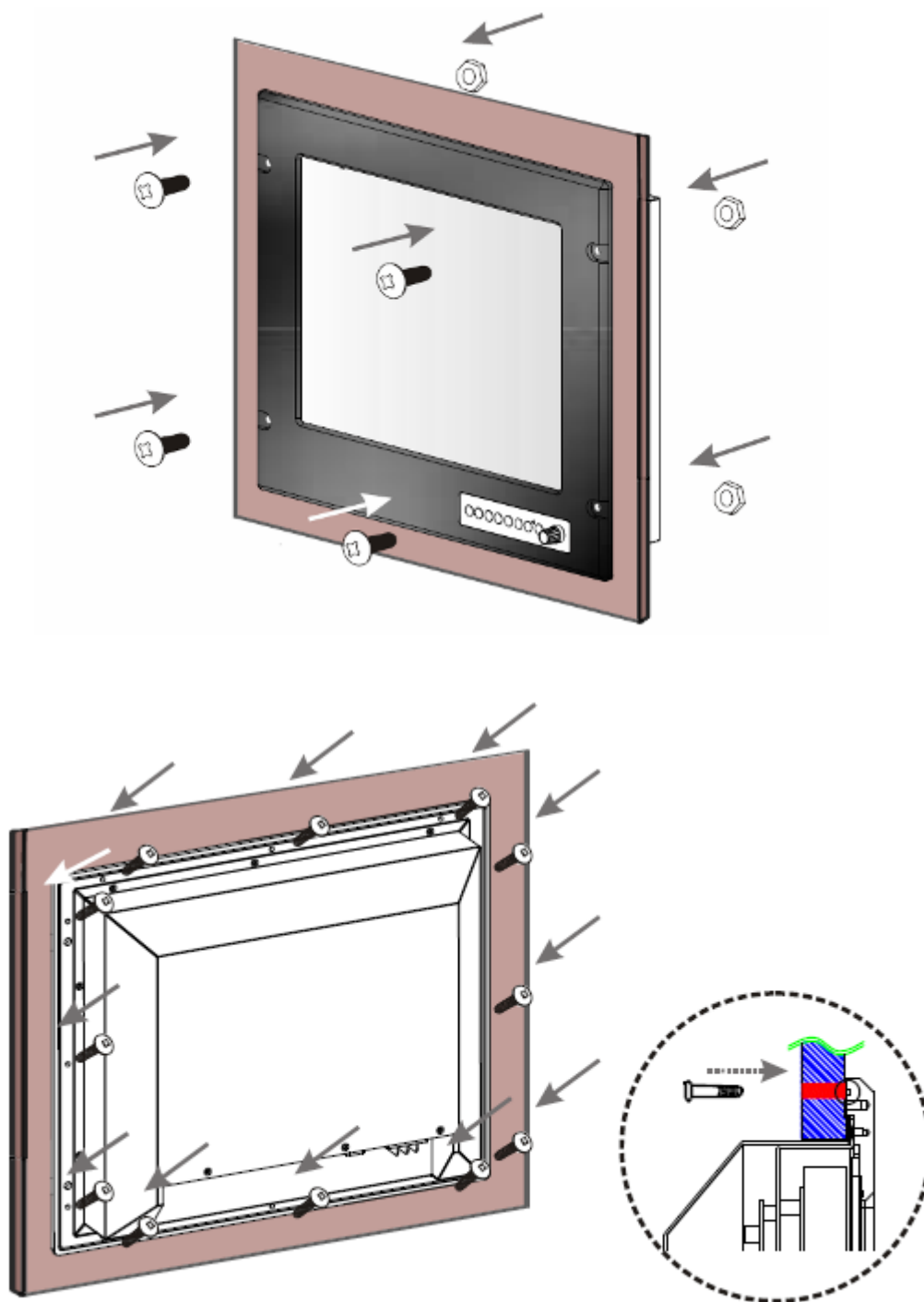

2. Use M4x 15mm bolts to drill through the fixture into the mounting holes on the rear side of IP65 front bezel.(The quantity of mounting screws based on drawing)
3. Check the finished mounting concept.

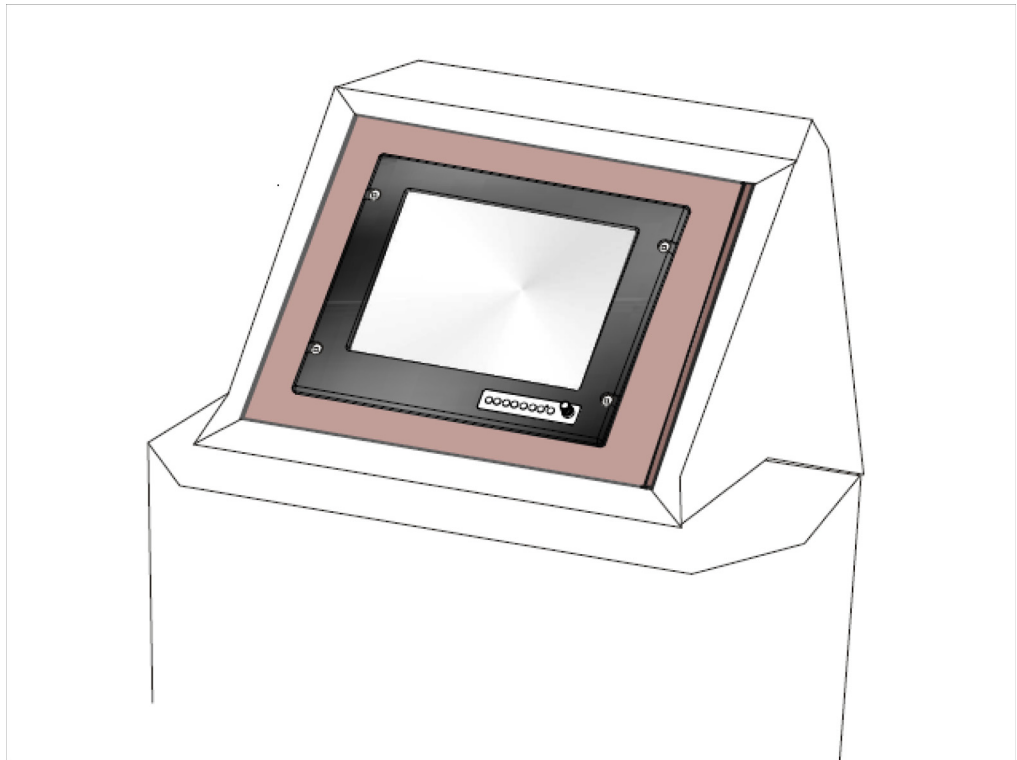

Note! VESA and wall mount with mounting kit by special request.

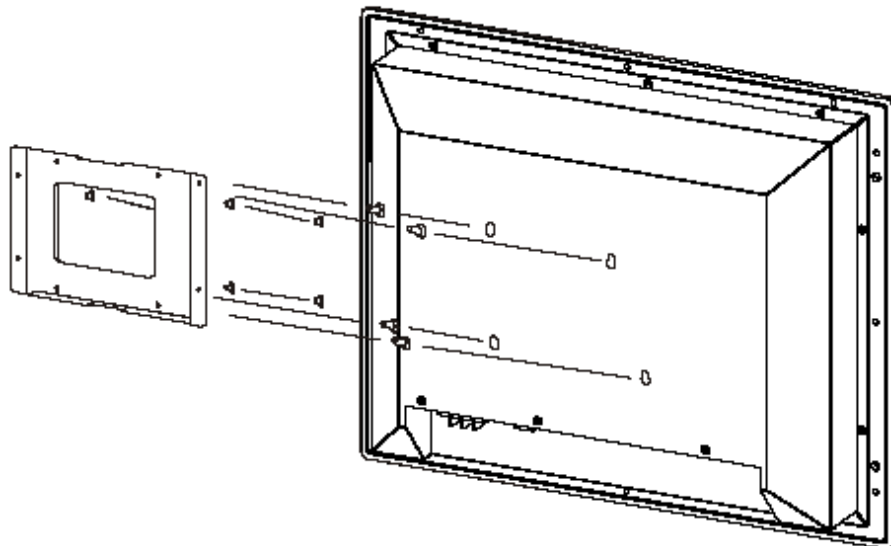

2.2 Installation Notice

2.2.1 Brightness Control Knob Precaution

The dimming brightness control knob may be damaged by wrong placement. Please make sure the right way to protect the knob.

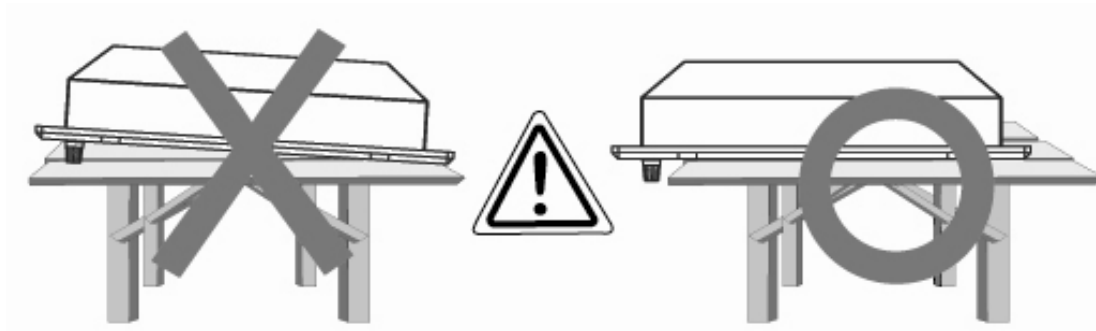

2.2.2 Cable Connection Precaution

Make sure to use qualified shielded signal cable to connect to Marine products. These cables including RGB, DVI, RS232, LAN, and USB cable should be connected inside the area as marked below. For DC power connection, please make sure the power cable is tightly connected by two screws of the terminal block.

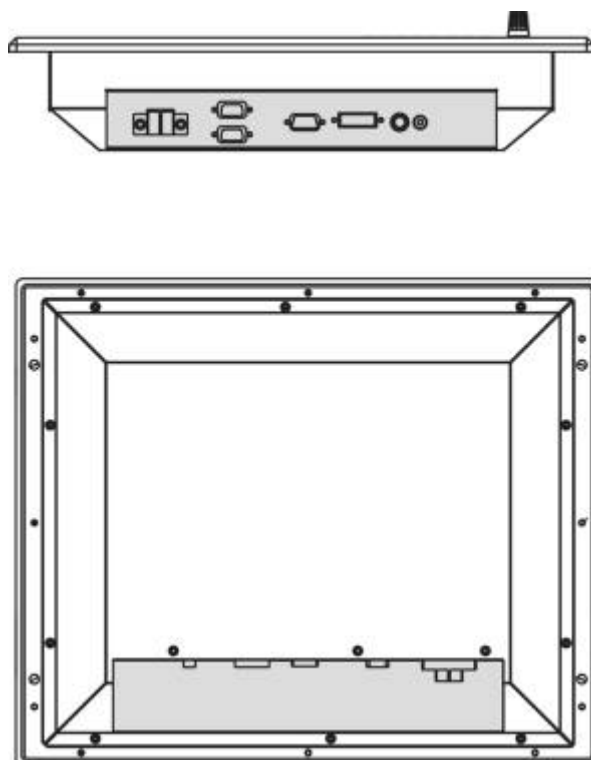

Chapter 3

Operating the LCD Display

3.1 OSD User Controls

The compact OSD in front control is a user-friendly interface both to remote the display function and dimming VR knob. The on screen display (OSD) contains several functions that will let the user to adjust or set up the display to their preferred setting. It also supplies special Hot Keys of clicking two keys together for easy flipping image and auto adjusting color balance



Figure 3.1 OSD User Controls

The Dimming Knob

The TFT LCD display support hyper dimming function to adjust brightness from nearly 0% to 100% via a easy to use VR knob.

Power On/ Off

Press the Power On/Off button to switch the TFT LCD display power.

Display Status LED indicator

When the TFT LCD display are normally operated, the LED indicator turns to green light. And the LED turns to red light when the TFT LCD display going to sleep.

Refer to the OSD Single Key Function as below and understand how to use the display functions step by step.

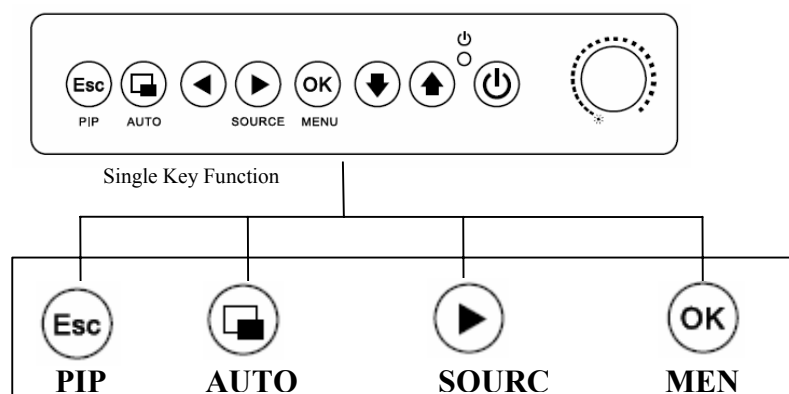

3.2 PIP (Picture in Picture) Function

When OSD Menu is disabled, it cycles through the available PIP display modes. Repeated keystrokes will change the size of the PIP display to side-by-side (PAP) display, and then back to normal display.

When OSD Menu is enabled, press “” returns to the previous menu level or closes the OSD if pressed at the Menu level.

3.3 Auto Adjustment Function

When OSD Menu and PIP is disabled, press “” will perform the screen Auto Adjustment.

When PIP is enabled, it switches the image in the Main Display to the PIP Display and vice versa by pressing again. When image side-by-side (PAP mode) is active,

the SWAP key () exchanges the left and right displays.

3.4 Source Function

When OSD Menu is disabled, press “” will cycle through the available input sources for the Main Display.

When OSD Menu is enabled, it moves right when navigating the Menu and Sub Menu and increments a slider bar.

3.5 OSD Menu Function

After the power on, press “” to enter OSD Menu.

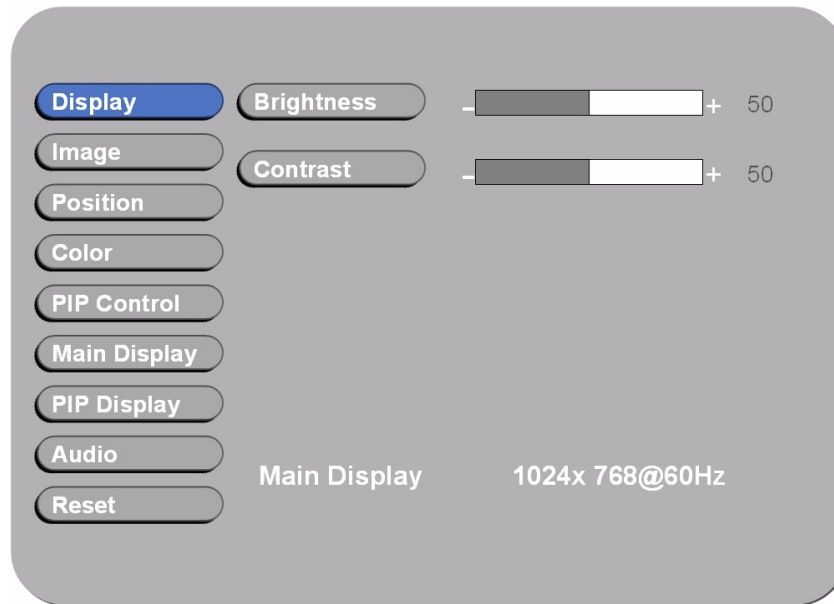









Figure 3.2 OSD Menu

There are 9 functions for in the OSD Menu for selection. For each function, it is very easy to select by the other navigation keys to adjust. Following the direction as below:

1. Press “” (Up) and “” (Down) to select each function.
2. Press “” to enter the sub menu, and press “” to exit.
3. Press “” (Up) and “” (Down) to select the sub-function.
4. When enter to each sub-function, press “” (Left) and “” (Right) to decrease / increase the bar value.

3.6 Display Item Menu

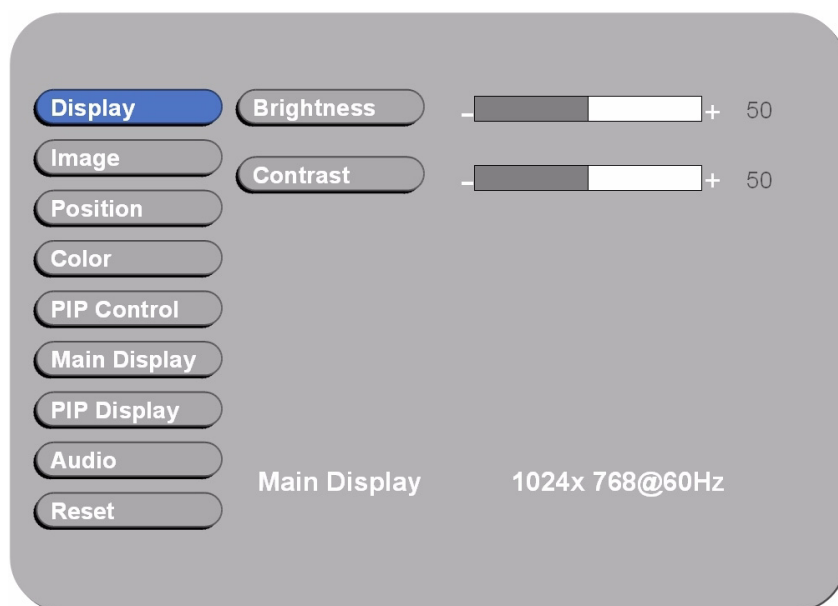

Figure 3.3 Display Item Menu

Display Item Menu		
Menu	Input Source	Description and Usage
Brightness	VGA DVI Composite S-Video	Adjust brightness only used in brightness knob. Adjustment is no response here.
Contrast		Press “◀” / “▶” to adjust contrast.

Note! The Brightness control from OSD is removed for dimming knob tuning.



3.7 Image Item Menu

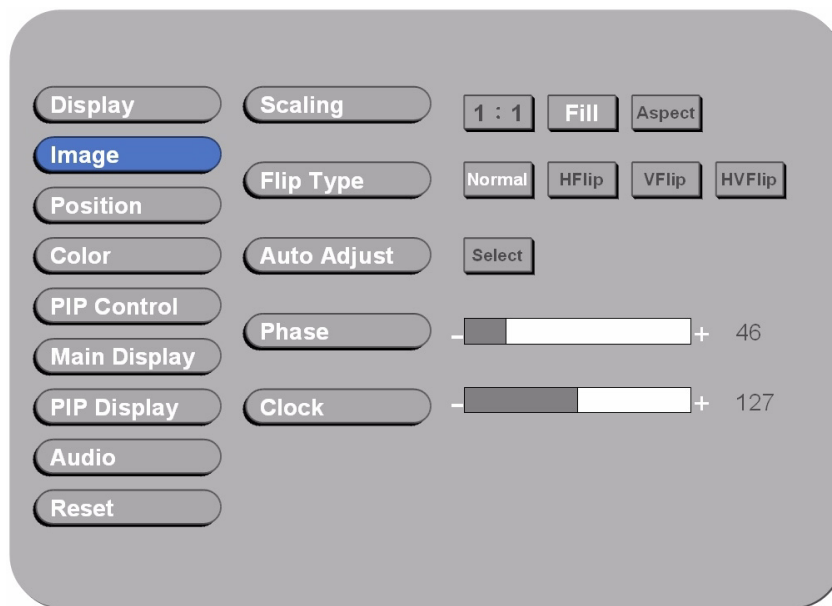

Figure 3.4 Image Item Menu (VGA)

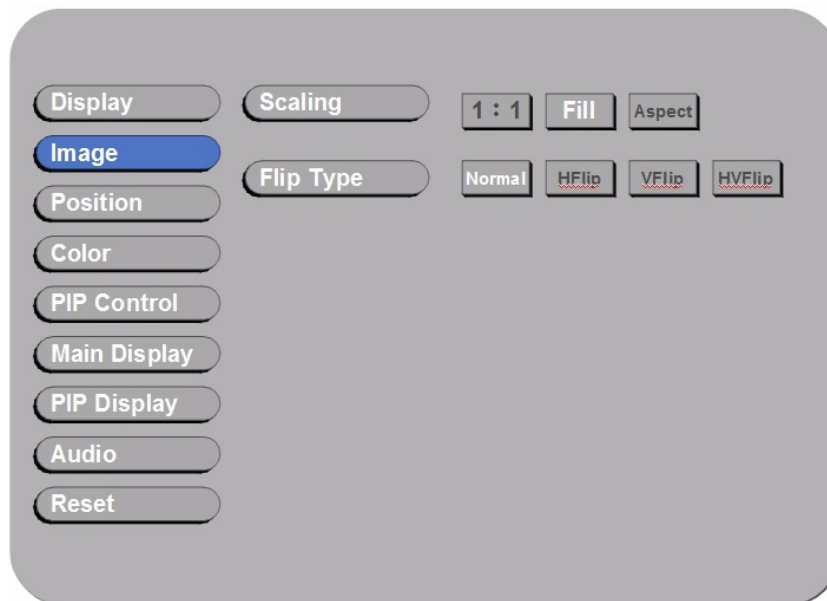

Figure 3.5 Image Item Menu (DVI)

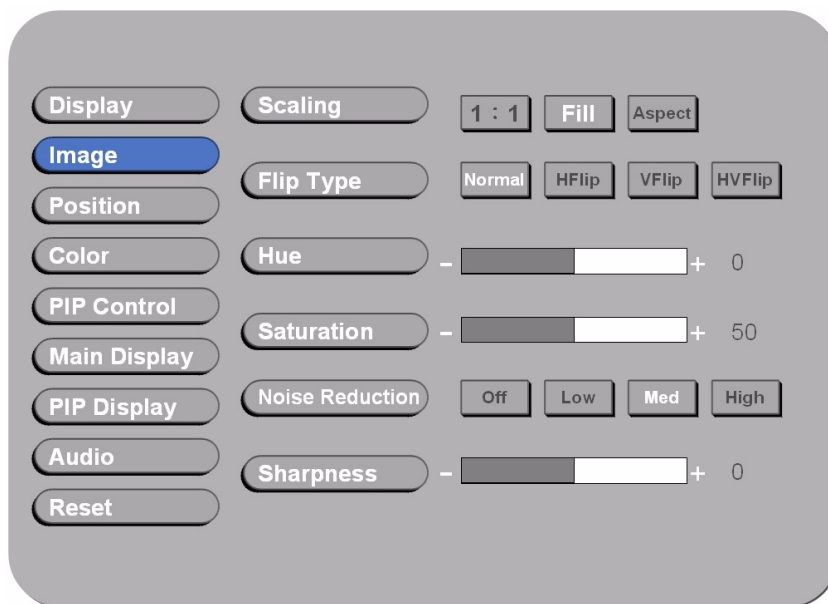

Figure 3.6 Image Item Menu (Composite, S-Video)

Image Item Menu		
Menu	Input Source	Description and Usage
Scaling**	VGA DVI Composite S-Video	Change the scaling mode by using the “◀” / “▶” buttons to select 1:1, Fill or aspect . Press “OK” to activate the selected Scaling mode.
Flip Type		Using “◀” / “▶” and “OK” to select the display flip for Normal, HFlip, VFlip, or HVFlip mode.
Auto-Adjust**	VGA Only	Initiate this to have the monitor logic to choose the best settings for the current input signal.
Phase		Adjust Phase to optimize the display quality by using “◀” / “▶” to change the value.
Clock		Select Clock to adjust the horizontal screen size by using “◀” / “▶” to change the value.
Hue	Composite and S-Video Only	Press “◀” / “▶” to select Hue to obtain the desired color settings.
Saturation		Press “◀” / “▶” to select Saturation to adjust the optimal color degree level.
Noise Reduction		Using “◀” / “▶” and “OK” to select the Noise Reduction for Off, Low, Mid, and High mode.
Sharpness		The Sharpness of the image may be optimized by using “◀” / “▶” to change the value of the slider bar.

Note! For Scaling:



1. In 1:1 mode, the input image is centered on the screen. In Fill mode, the input image is stretched / compressed to fill the available display area.

2. In Aspect mode, the input image is stretched / compressed by the same horizontal and vertical factor.

Note! For Auto-Adjust:



The only button available is "SELECT". Note this may change the values of Phase and Clock, and there is no 'undo' feature.

3.7.1 Position Item Menu

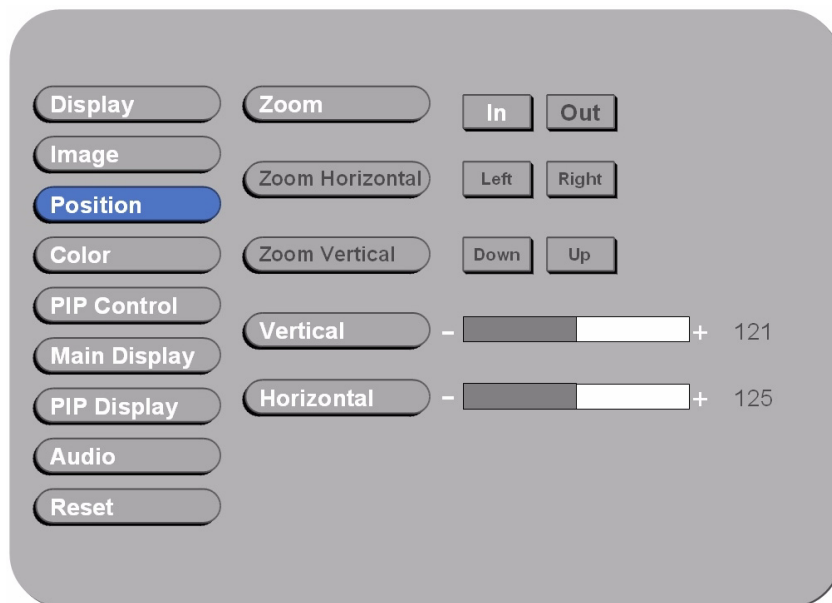

Figure 3.7 Position Item Menu (VGA)

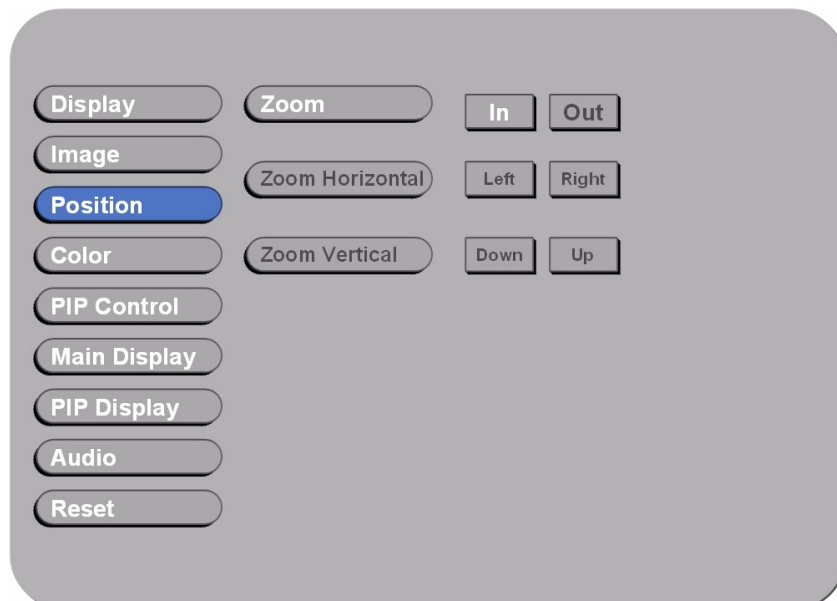

Figure 3.8 Position Item Menu (DVI, Composite, S-Video)

Position Item Menu		
Menu	Input Source	Description and Usage
Zoom	VGA DVI Composite S-Video	Change the current Zoom setting only to the Main Display, using “◀” / “▶” to select either In or Out . Zoom is at a temporary setting and will be lost at power down.
Zoom Horizontal		Zoom Horizontal is unavailable until the user performs a Zoom In action. Using “◀” / “▶” to select either Left or Right to change the current Horizontal Pan setting. Pan settings will be lost at power down.
Zoom Vertical		Zoom Vertical is unavailable until the user performs a Zoom In action. Using “◀” / “▶” to select either Up or Down to change the current Vertical Pan setting and. Pan settings will be lost at power down.
Vertical	VGA	Move the screen up or down by using “◀” / “▶” to change the vertical position value.
Horizontal		Move the screen left or right by using “◀” / “▶” to change the horizontal position value.

3.7.2 Color Item Menu

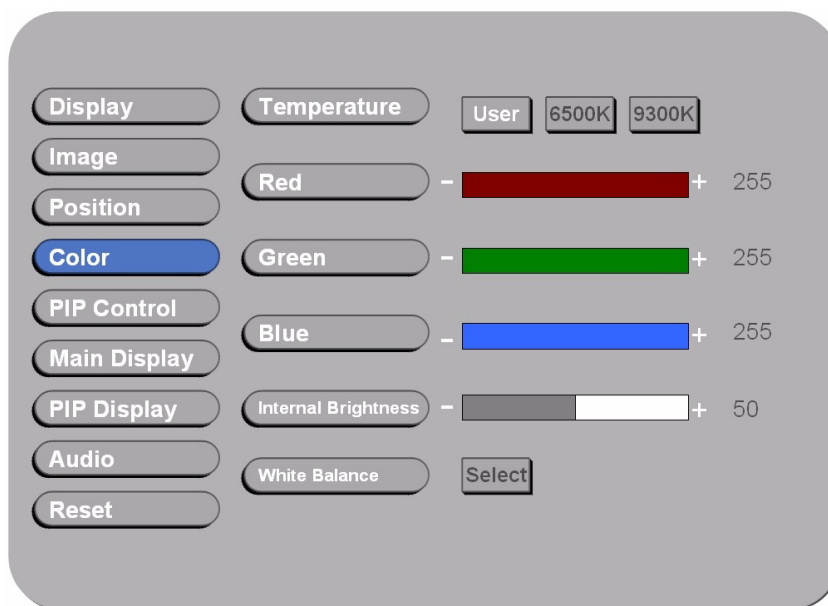

Figure 3.9 Color Item Menu (VGA)

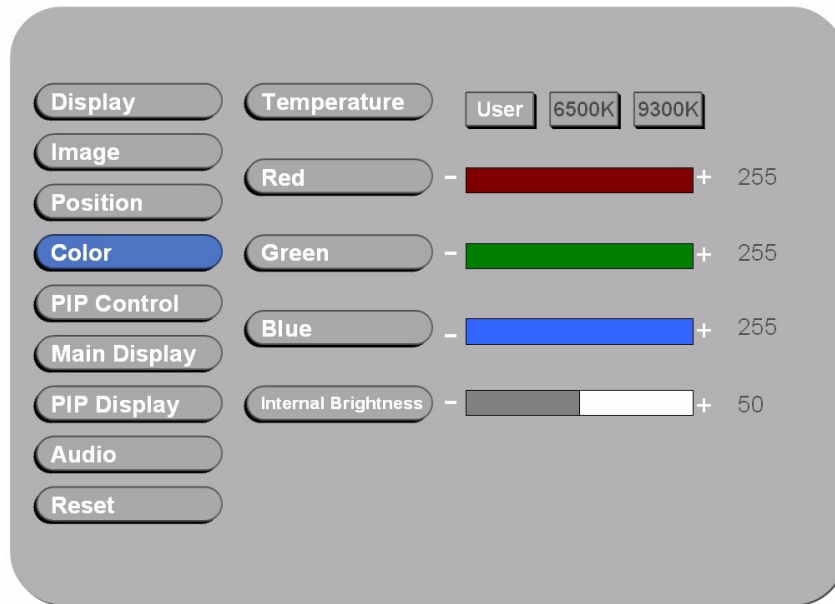

Figure 3.10 Color Item Menu (DVI, Composite, S-Video)

Color Item Menu		
Menu	Input Source	Description and Usage
Temperature	VGA DVI Composite S-Video	To configure color temperature, use “◀” / “▶” to change the value to User Preset , 6500K , or 9300 K to set a color temperature to suit your own preference. When User Preset is selected, the values of the Red, Green, and Blue sliders below are used to determine color settings.
R		Press “◀” / “▶” to adjust the Red color to obtain the desired color settings.
G		Press “◀” / “▶” to adjust the Green color to obtain the desired color settings.
B		Press “◀” / “▶” to adjust the Blue color to obtain the desired color settings.
Internal Brightness		Press “◀” / “▶” to adjust the Red color to obtain the desired color settings.
White Balance	VGA Only	When in “VGA” mode, press “Select” to adjust White Balance for the display setting.

3.7.3 PIP Control Item Menu

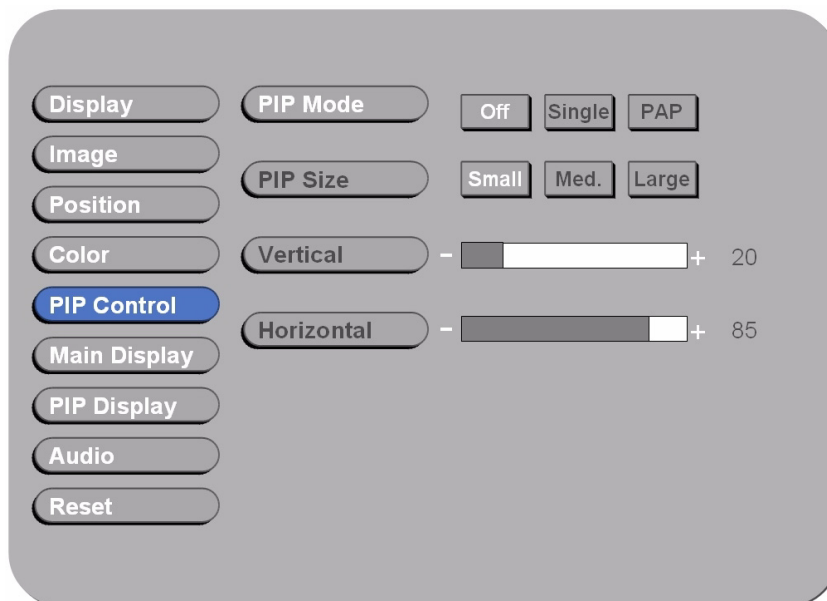

Figure 3.11 PIP Control Item Menu

PIP Control Item Menu		
Menu	Input Source	Description and Usage
Mode	VGA DVI Composite S-Video	Use “◀” / “▶” to change the Mode value to be Off , Single , or PAP** . In Off mode, the Main display fills the entire screen. In Single mode, a PIP display floats over the screen. In PAP mode, the screen is divided into two side-by-side display areas.
Size		PIP Size can be altered only when Single PIP mode is selected. To configure the PIP display size, use “◀” / “▶” to change the value to Small , Medium or Large .
Vertical**		Both vertical and horizontal PIP position can be altered only when Single PIP mode is selected. Configure the PIP Vertical and Horizontal Position, by using “◀” / “▶” to change the value using the slider bar.
Horizontal		

Note! For PAP mode:



When selecting “PAP” mode, the display area is now divided into two parts. The left window displays the Main output, while the right window displays the PIP output. Each window is half size of the total display area. Each input is scaled down to fit the window.

Note! For PIP mode:



Note that the PIP screen can have any position on the screen. This can be achieved by adjusting both Horizontal and Vertical positions.

3.7.4 Main Display Item Menu

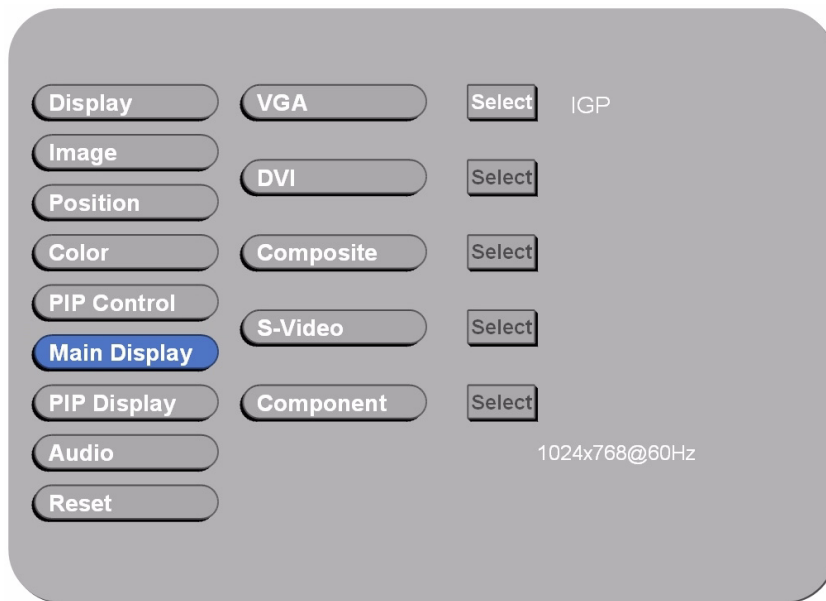



Figure 3.12 Main Display Item Menu

Press “” and “” to select the Main Display main source, including VGA, DVI, Composite, and S-Video mode.

Press “” to choose “Select”.

3.7.5 PIP Display Item Menu

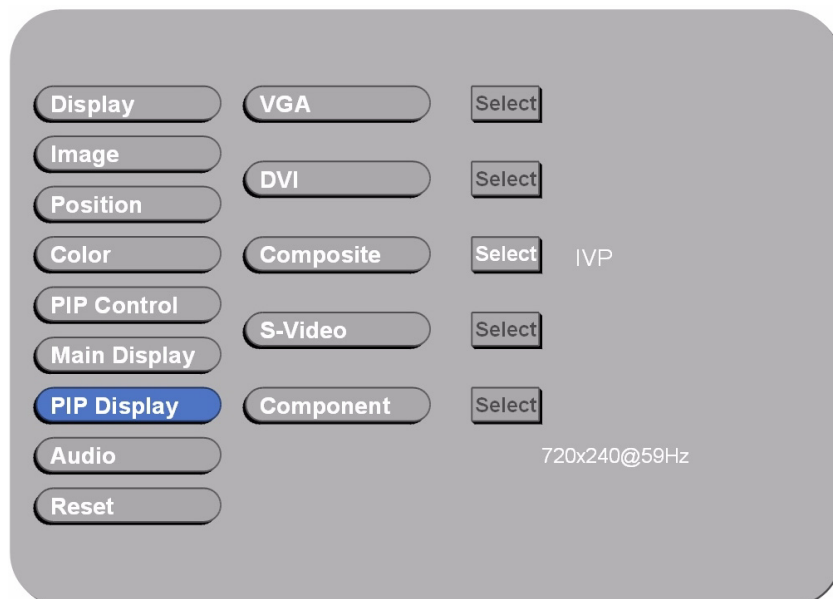



Figure 3.13 PIP Display Item Menu

Press “” and “” to select the PIP Display main source, including VGA, DVI, Composite, and S-Video mode.

Press “” to choose “Select”.

3.7.6 Audio Item Menu (Optional)

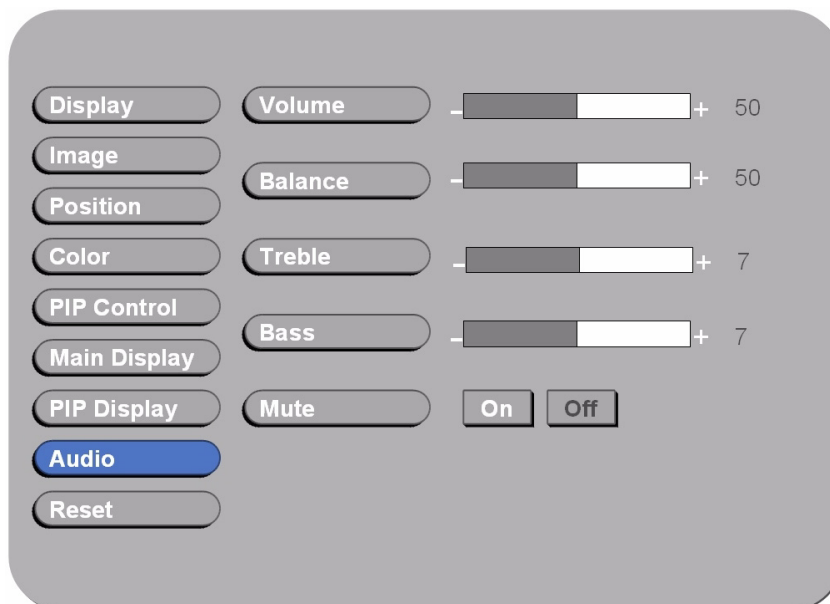









Figure 3.14 Audio Item Menu

Audio Item Menu		
Menu	Input Source	Description and Usage
Volume	VGA DVI Composite S- Video	To adjust the volume, use “  ” / “  ” to change the value of the slider bar to increase or decrease the volume.
Balance		To configure the audio balance, either left or right, use “  ” / “  ” to change the value of the slider bar to change the value.
Treble		Increase or decrease the audio treble by using “  ” / “  ” to change the value.
Bass		To configure the bass, use “  ” / “  ” to change the bass value.
Mute		To turn mute off/on, select either On/Off for Mute. By default, mute is set to No, or turned off.

3.7.7 Reset Item Menu

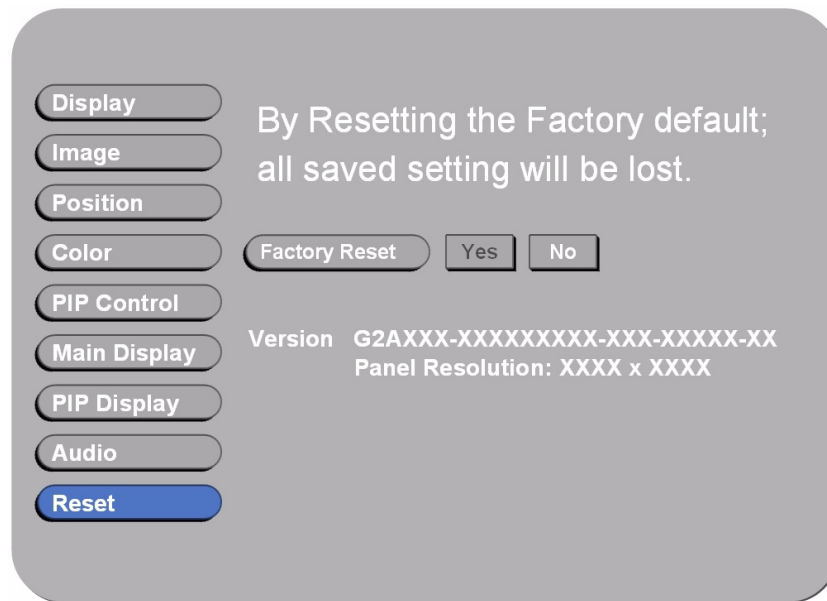

Figure 3.15 Reset Item Menu

Factory Reset Item Menu		
Menu	Input Source	Description and Usage
Factory Reset	VGA DVI Composite S-Video	To reset all settings to factory defaults, open the Factory Reset Item. Use “◀” / “▶” to select the “ Yes ” option, and press “OK”. WARNING: All user adjustments will be lost. Press “EXIT” (Esc) to return to the Main Menu without making changes.

Appendix **A**

Cleaning the Monitor

A.1 Cleaning the Monitor

1. Make sure the monitor is turned off.
2. Never spray or pour any liquid directly on the screen or case.
3. Wipe the screen with a clean, soft, lint-free cloth. This removes dust and other particles.
4. The display area is highly prone to scratching. Do not use ketone type material (ex. Acetone), Ethyl alcohol, toluene, ethyl acid or Methyl chloride to clear the panel. It may permanently damage the panel and void the warranty.
5. If it is still not clean enough, apply a small amount of non-ammonia, non-alcohol based glass cleaner onto a clean, soft, lint-free cloth, and wipe the screen.
6. Don't use water or oil directly on the monitor. If droplets are allowed to drop on the monitor permanent staining or discoloration may occur.

Appendix **B**

Troubleshooting

B.1 Disclaimer

We do not recommend using any ammonia or alcohol-based cleaners on the monitor screen or case. Some chemical cleaners have been reported to damage the screen and/or case of the monitor. Seller will not be liable for damage resulting from the use of any ammonia or alcohol-based cleaner.

B.2 Troubleshooting

If your monitor fails to operate correctly, consult the following chart for possible solution before calling for repairs:

Condition	Check Point
The picture does not appear	Check if the signal cable is firmly seated in the socket. Check if the Power is ON at the computer Check if the brightness control is at the appropriate position, not at the minimum.
The screen is not synchronized	Check if the signal cable is firmly seated in the socket. Check if the output level matches the input level of your computer. Make sure the signal timings of the computer system are within the specification of the monitor. If your computer was working with a CRT monitor, you should check the current signal timing and turn off your computer before you connect the VGA Cable to this monitor.
The position of the screen is not in the center	Adjust the H-position, and V-position, or Perform the Auto adjustment.
The screen is too bright (too dark).	Check if the brightness or contrast control is at the appropriate position, not at the Maximum (Minimum).
The screen is shaking or waving	Perform the Auto adjustment.. Moving all objects which emit a magnetic field such as motor or transformer, away from the monitor. Check if the specific voltage is applied. Check if the signal timing of the computer system is within the specification of monitor.

If you are unable to correct the fault by using this chart, stop using your monitor and contact your distributor or dealer for further assistance.

Appendix **C**

Supported Modes

C.1 Graphics

No.	Resolution	Frequency (Hz)	Note
1	640x350	70	IBM
2	640x400	70	IBM
3	640x480	60	VESA
4	640x480	72	VESA
5	640x480	75	VESA
6	720x400	70	IBM
7	800x600	56	VESA
8	800x600	60	VESA
9	800x600	72	VESA
10	800x600	75	VESA
11	1024x768	60	VESA
12	1024x768	70	VESA
13	1024x768	75	VESA
14	1280x768	60	
15	1152x864	75	
16	1280x960	60	VESA
17	1280x1024	60	VESA
18	1280x1024	60	HP
19	1280x1024	70	NCD
20	1280x1024	72	HP
21	1280x1024	75	VESA
22	1600x1200	60	VESA
23	1920x1200	60	VESA
24	1360x768	60	

C.2 Video

No.		
1	NTSC / 480I / 525I	720 x 240 x 60I
2	PAL / 576I /625I	720 x 288 x 50I
3	480P	720 x 480 x 60P
4	(HDTV) 720P	1280 x 720 x 50P
5	(HDTV) 720P	1280 x 720 x 60P
6	(HDTV) 1080I	1920 x 1080 x 50I
7	(HDTV) 1080P	1920 x 1080 x 60I

Not all modes will be supported, due to different panel brands

Appendix **D**

RS-232 Command Code (Optional)

D.1 RS-232 Command Code

01	DOWN	0x04, 0x12, 0x02, 0xE8, 0x00
02	UP	0x04, 0x12, 0x03, 0xE7, 0x00
03	LEFT	0x04, 0x12, 0x05, 0xE5, 0x00
04	RIGHT	0x04, 0x12, 0x06, 0xE4, 0x00
05	ENTER	0x04, 0x12, 0x07, 0xE3, 0x00
06	EXIT	0x04, 0x12, 0x08, 0xE2, 0x00
07	SWAP	0x04, 0x12, 0x0A, 0xE0, 0x00
08	SOURCE	0x04, 0x12, 0x0E, 0xDC, 0x00
09	POWER	0x04, 0x12, 0x0F, 0xDB, 0x00
10	AUTO ADJUST	0x04, 0x12, 0x11, 0xD9, 0x00
11	ASPECT	0x04, 0x12, 0x14, 0xD6, 0x00
12	MENU	0x04, 0x12, 0x15, 0xD5, 0x00
13	PIP	0x04, 0x12, 0x16, 0xD4, 0x00
14	VolDown	0x04, 0x12, 0x19, 0xD1, 0x00
15	VolUp	0x04, 0x12, 0x1A, 0xD0, 0x00
16	RESET	0x04, 0x12, 0x23, 0xC7, 0x00
17	AUTO COLOR	0x04, 0x12, 0x29, 0xC1, 0x00
18	FLIP	0x04, 0x12, 0x2C, 0xBE, 0x00
19	MUTE	0x04, 0x12, 0x2D, 0xBD, 0x00
20	ACK	0x03, 0x0C, 0xF1

Description: ex. DOWN 0x04, 0x12, 0x02, 0xE8,

Function par1, par2, par3, par4

Function: DOWN → down key

Par1: 0x04 → length (cannot be modified by user)

Par2: 0x12 → inquiry code (cannot be modified by user)

Par3: 0x02 → command code (can be modified by user)

Par4: 0xE8 → check sum (cannot be modified by user)

Appendix **E**

Transflective Display (Optional)

E.1 Transflective Display

Transflective LCD technology can be applied to certain selected regular TFT LCD to introduce the LCD with a reflective function. With the imposed reflective function, the modified LCD can reflect the ambient light passing the LCD cell and utilize the reflected light beams as its illumination. The stronger the ambient light is, the brighter the LCD will appear. As a result, the modified LCD is viewable under lighting conditions including direct sunlight.

E.2 Features

1. Readable under all lighting conditions including direct sunlight.
2. Enhanced contrast ratio for both indoor and outdoor conditions.
3. Ultimate indoor color saturation, brightness, and viewing angle.
4. Full mechanical and electrical are compliant with the existent system.
5. Power saving and backlight life preserving in outdoor applications.

No extra heat generation even it is viewed at higher brightness.

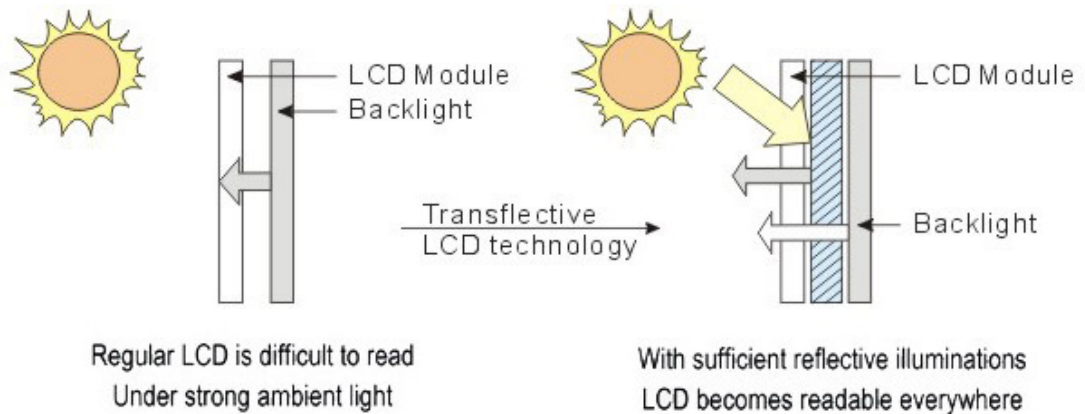

The following table shows the outdoor readability for the Marine Bridge System Display models.

Outdoor Readability

Model Number	R08T200-MRT1TR	R10L100-MRM2TR	R15T600-MRA1TR	R17L500-MRA2TR	R19L300-MRA1TR	R20L100-MRA2TR
Ambient light(nit)	10,000	10,000	10,000	10,000	10,000	10,000
	30,000	30,000	30,000	30,000	30,000	30,000
	80,000	80,000	80,000	80,000	80,000	80,000
Brightness gain (nit)	432.7	437.5	680	490	500	312.5
	620	670	870	630	630	456
	1,180	1,150	1,320	900	830	680
Reflectance(net)(%)	1.20%	1.20%	1%	0.83%	0.50%	0.70%
	1.15%	1.15%	0.98%	0.70%	0.65%	0.68%
	1.16%	1.10%	0.90%	0.45%	0.40%	0.45%

E.3 Transflective Brightness Testing

E.3.1 Dark Room Testing Instructions

1. Put the panel on table and plug the inverter, adjust the screen to white color background.
2. Open the brightness testing equipment and make the zero value on the Equipment.
3. Put the brightness detection sensor on the front of the LCD panel to measure the value.
4. Make sure that brightness on the OSD is adjusted to the maximum value.
5. After each time measure the brightness lamp level change, it is necessary to wait for 30 minutes at least to ensure the brightness in the labs room in homogeneous or consistent.
6. All testing are applied to naked LCD without any glass or sensor on the front side.

Brightness Inspection:

The brightness inspection is based on **Picture 2** to measure sample:

Sample Panel	Original Brightness(nits)	Finished Brightness(nit)	Increase Proportion (%)	Reflection Rate (%)	Ambient Light
Panel A	221	317	43.4	---	20,000nit
Panel B	210	315	50	0.67(test nits:20,000)	20,000 nit

**Our Labs ambient light is just for 10,000 nits, 20,000nit, 30,000nit, 40,000 nit or more ambient light value can be calculated by formula to estimate the brightness level of LCD panel

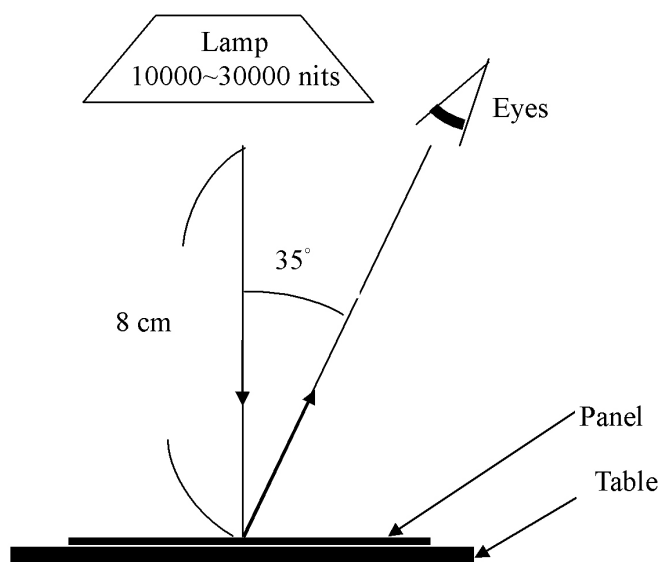

E.3.2 Environment: Outdoor Readability Measure

The following tables are our samples for outdoor readability measure.

8.4" R08T200-T1TR, 800x600@60Hz, 75Hz

Ambient light	View degree	10,000 nit	30,000nit	80,000nit
Brightness gain(BL ON)	35°	437.5 nit	620 nit	1180 nit
Reflectance(net)		1.2%	1.15%	1.16%

10.4" R10L600-P1TR, 800x600@60Hz, 75Hz

Ambient light	View degree	10,000 nit	30,000nit	80,000nit
Brightness gain(BL ON)	35°	437.5 nit	670 nit	1150 nit
Reflectance(net)		1.2%	1.15%	1.1%

15" R15T600-A1TR, 1024x768@60Hz, 75Hz

Ambient light	View degree	10,000 nit	30,000nit	80,000nit
Brightness gain(BL ON)	35°	680 nit	870 nit	1100 nit
Reflectance(net)		1%	0.98%	0.8%

E.4 Caution on Handling Transflective LCD

E.4.1 Operation & Storage Temperature Caution

Although transflective LCD is mainly used in outdoor environment and can increase the effective lights under sunlight, it is suggested that you should keep the LCD in appropriate temperature for operation and storage. To ensure the transflective LCD work stably, 0~50°C (32-121°F) operation and storage temperature is suitable.

Suggestion: Temperature 0~50°C (32-121°F) is appropriate for operation and storage on transflective LCD.

E.4.2 Contrast Ratio to Ambient Light Caution

Contrast ratio is a factor that can influence the readability. It is possible that we get pretty high brightness measurement but the panel is not sunlight readable. For example, the LCD is in 80,000 nits outside ambient light level, even we have very high brightness but the contrast to the ambient light is too low, we might not be able to see the clear LCD screen image. In order to be sunlight readable, both brightness and contrast ratio to the ambient light are needed to be in proper range.

Suggestion: It should make the proper contrast ratio to the ambient light condition to ensure that LCD screen image is clear.

E.4.3 Protection Glass Selection

If you demand for built-in protection glass, it is needed to use the material whose reflectance rate is less than 1%. It should be careful when using protection glass. Generally, the reflectance rate of protection glass can be as high as 4~6%, but we can provide the reflectance ration glass which is less 0.6%, so that the sunlight readability performance can work very well.

Suggestion: Select an appropriate glass if you need to built-in protection glass. In addition, please feel free to inquire us for any protection glass information.

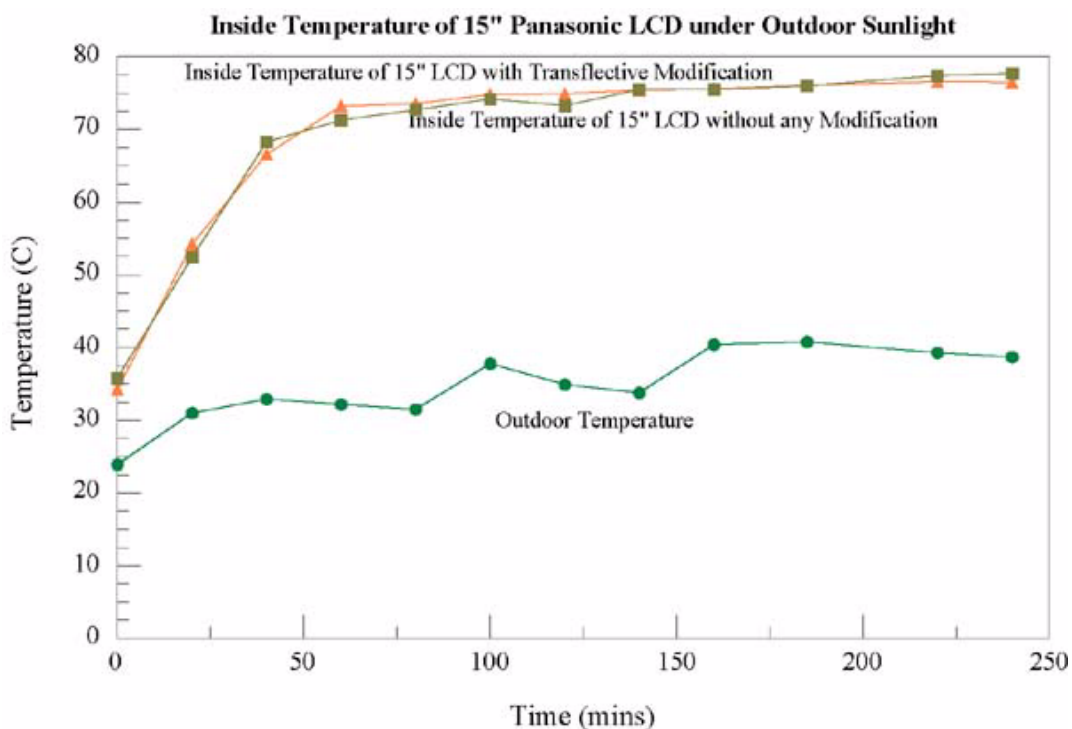

E.5 Touchscreen Selection

Due to using pure glass instead of the coating, ELO SAW and IR touch are ideal selection for touch solution on transflective LCD, they have lower reflectance rate than traditional resistive and capacitive touchscreen that have coating on them. Since our technology is based on transflective principle, the glass or sensor will reduce the sunlight reflect out. It would have problem to use high reflectance sensor or glass on transflective LCD.

Suggestion: ELO SAW and IR touch are recommended for touch screen solution on transflective LCD.

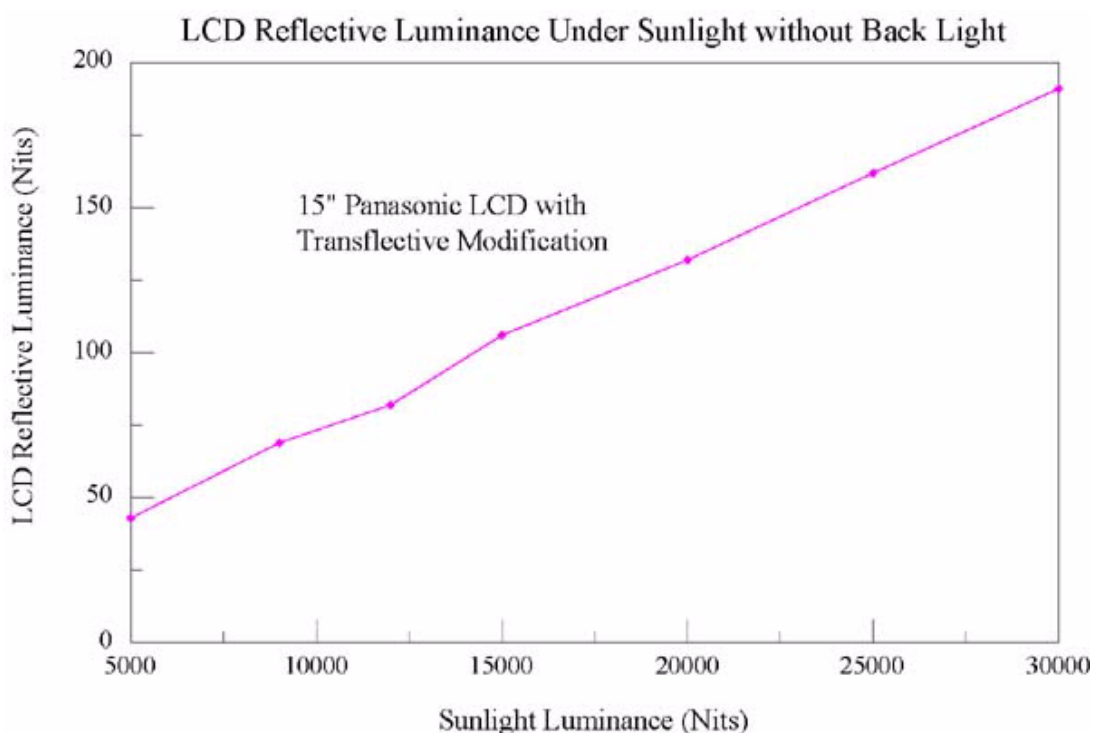

ADVANTECH

eAutomation

www.advantech.com

Please verify specifications before quoting. This guide is intended for reference purposes only.

All product specifications are subject to change without notice.

No part of this publication may be reproduced in any form or by any means, electronic, photocopying, recording or otherwise, without prior written permission of the publisher.

All brand and product names are trademarks or registered trademarks of their respective companies.

© Advantech Co., Ltd. 2007

Free Manuals Download Website

<http://myh66.com>

<http://usermanuals.us>

<http://www.somanuals.com>

<http://www.4manuals.cc>

<http://www.manual-lib.com>

<http://www.404manual.com>

<http://www.luxmanual.com>

<http://aubethermostatmanual.com>

Golf course search by state

<http://golfingnear.com>

Email search by domain

<http://emailbydomain.com>

Auto manuals search

<http://auto.somanuals.com>

TV manuals search

<http://tv.somanuals.com>