

USB-4718

**8-Channel Thermocouple
Input Module**

User Manual

Copyright

The documentation and the software included with this product are copyrighted 2005 by Advantech Co., Ltd. All rights are reserved. Advantech Co., Ltd. reserves the right to make improvements in the products described in this manual at any time without notice. No part of this manual may be reproduced, copied, translated or transmitted in any form or by any means without the prior written permission of Advantech Co., Ltd. Information provided in this manual is intended to be accurate and reliable. However, Advantech Co., Ltd. assumes no responsibility for its use, nor for any infringements of the rights of third parties, which may result from its use.

Acknowledgements

Intel and Pentium are trademarks of Intel Corporation.

Microsoft Windows and MS-DOS are registered trademarks of Microsoft Corp.

All other product names or trademarks are properties of their respective owners.

Part No. 2003471800

1st Edition

Printed in Taiwan

January 2006

Product Warranty (2 years)

Advantech warrants to you, the original purchaser, that each of its products will be free from defects in materials and workmanship for two years from the date of purchase.

This warranty does not apply to any products which have been repaired or altered by persons other than repair personnel authorized by Advantech, or which have been subject to misuse, abuse, accident or improper installation. Advantech assumes no liability under the terms of this warranty as a consequence of such events.

Because of Advantech's high quality-control standards and rigorous testing, most of our customers never need to use our repair service. If an Advantech product is defective, it will be repaired or replaced at no charge during the warranty period. For out-of-warranty repairs, you will be billed according to the cost of replacement materials, service time and freight. Please consult your dealer for more details.

If you think you have a defective product, follow these steps:

1. Collect all the information about the problem encountered. (For example, CPU speed, Advantech products used, other hardware and software used, etc.) Note anything abnormal and list any onscreen messages you get when the problem occurs.
2. Call your dealer and describe the problem. Please have your manual, product, and any helpful information readily available.
3. If your product is diagnosed as defective, obtain an RMA (return merchandize authorization) number from your dealer. This allows us to process your return more quickly.
4. Carefully pack the defective product, a fully-completed Repair and Replacement Order Card and a photocopy proof of purchase date (such as your sales receipt) in a shippable container. A product returned without proof of the purchase date is not eligible for warranty service.
5. Write the RMA number visibly on the outside of the package and ship it prepaid to your dealer.

CE

This product has passed the CE test for environmental specifications when shielded cables are used for external wiring. We recommend the use of shielded cables. This kind of cable is available from Advantech. Please contact your local supplier for ordering information.

Technical Support and Assistance

Step 1. Visit the Advantech web site at **www.advantech.com/support** where you can find the latest information about the product.

Step 2. Contact your distributor, sales representative, or Advantech's customer service center for technical support if you need additional assistance. Please have the following information ready before you call:

- Product name and serial number
- Description of your peripheral attachments
- Description of your software (operating system, version, application software, etc.)
- A complete description of the problem
- The exact wording of any error messages

Document Feedback

To assist us in making improvements to this manual, we would welcome comments and constructive criticism. Please send all such - in writing to: support@advantech.com

Safety Precaution - Static Electricity

Follow these simple precautions to protect yourself from harm and the products from damage.

1. To avoid electrical shock, always disconnect the power from your PC chassis before you work on it. Don't touch any components on the CPU card or other cards while the PC is on.
2. Disconnect power before making any configuration changes. The sudden rush of power as you connect a jumper or install a card may damage sensitive electronic components.

Contents

Chapter 1	Introduction	2
1.1	Features	2
1.2	Applications	3
1.3	Installation Guide	3
	Figure 1.1:Installation Flow Chart	4
1.4	Software Overview.....	5
1.4.1	Programming Choices for DA&C Module:	5
1.4.2	Device Drivers	5
1.5	Device Driver Programming Roadmap.....	6
1.5.1	Programming Tools	6
1.5.2	Programming with Device Drivers Function Library	7
1.5.3	Troubleshooting Device Drivers Error	7
Chapter 2	Installation	10
2.1	Unpacking	10
2.2	Driver Installation	10
	Figure 2.1:Automation Software Setup Screen	11
2.3	Hardware Installation	12
	Figure 2.2:Device Manager Screen	13
	Figure 2.3:USB-4718 Device Speed	14
2.4	Device Setup & Configuration.....	14
2.4.1	Setting Up the Device	15
	Figure 2.4:Device Manager Dialog Box	15
2.4.2	Configuring the Device	15
	Figure 2.5:The Device Setting Dialog Box	16
2.5	Device Testing.....	16
2.5.1	Testing Analog Input Function	17
	Figure 2.6:Analog Input Tab/Device Test Dialog	17
2.5.2	Testing Analog Output Function	17
	Figure 2.7:Analog Output Function Not Supported	17
2.5.3	Testing Digital Input Function	18
	Figure 2.8:Digital Input Tab/Device Test Dialog	18
2.5.4	Testing Digital Output Function	18
	Figure 2.9:Digital Output Tab/Device Test Dialog	18
2.5.5	Testing Counter Function	19
	Figure 2.10:Counter Tab Testing Unsupported	19
2.6	Hardware Uninstallation	19
	Figure 2.11:Unplug or Eject Hardware Dialog	20
	Figure 2.12:Stop a Hardware device dialog box	20
Chapter 3	Signal Connections	22
3.1	Overview	22
3.2	I/O Connectors	22
3.2.1	Pin Assignment	22

	Figure 3.1:I/O Connector Pin Assignment	23
3.2.2	I/O Connector Signal Description	24
	Table 3.1:I/O Connector Signal Description	24
3.2.3	LED Indicator Status Description	24
	Table 3.2:LED Indicator Status Description	24
3.3	Analog Input Connections.....	25
	Figure 3.2:Single-Ended Input Channel Connection ...	25
3.4	Isolated Digital Input Connections.....	25
	Figure 3.3:Analog Output Channel Connections	26
3.5	Isolated Digital Output Connections.....	26
3.5.1	External Trigger Source Connection	26
3.6	Field Wiring Considerations	27
Appendix A	Specifications	30
A.1	Analog Input.....	30
	Table A.1:Analog Input	30
A.2	Accuracy for Thermocouple:	31
	Table A.2:Accuracy for Thermocouple	31
A.3	Isolated Digital Input.....	31
	Table A.3:Isolated Digital Input	31
A.4	Isolated Digital Output	32
	Table A.4:Isolated Digital Output	32
A.5	General	32
	Table A.5:General	32
Appendix B	Function Block.....	34
Appendix C	Firmware Download Utility	36
	Figure C.1:Install Firmware Download Utility Screen	36
	Figure C.2:USB Download Utility	37
	Figure C.3:Firmware Selection	37
	Figure C.4:Firmware Download Completed.	38
Appendix D	Analog Input Calibration	43
D.1	Voltage Input Calibration.....	44
	Figure D.1:USB-4718 Device Setting window	45
	Figure D.2:USB-4718 Calibration Wizard	46
	Figure D.3:Zero range calibration complete.	46
	Figure D.4:Full range calibration	47
	Figure D.5: Calibration Complete	47
D.2	Voltage Input Calibration.....	48
	Figure D.6:Select the current input range setting	48

Introduction

This chapter will provide information on the features of the DAS module, a quick start guide for installation, and some brief information on software and accessories for the USB-4718 Module.

Sections include:

- Features
- Applications
- Installation Guide
- Software Overview
- Device Driver
- Programming Roadmap

Chapter 1 Introduction

USB-4718 offers 8 thermocouple inputs with 16-bit resolution, up to 0.1% input range accuracy, or 4~20 mA inputs. Reliable and rugged enough for industrial applications, yet inexpensive enough for home projects, USB-4718 is the perfect way to add measurement and control capability to any USB capable computer. The USB-4718 is fully USB plug and play and easy to use. It obtains all required power from the USB port, so no external power connection is ever required.

1.1 Features

USB-4718 has the most requested measurement & control functions:

- 8 differential thermocouple input channels
- 16 bits resolution
- Software configurable for thermocouple, low level voltage or current inputs.
- Wiring burned-out detectable function (Thermo mode)
- 2,500 Vdc isolation
- Watchdog Timer
- Supports 0~20 & 4~20mA current inputs.
- Bus-powered
- Device status LED indicator
- Removable on-module wiring terminal
- USB 2.0 Support
- Hot swappable

Note: For detailed specifications of USB-4718, please refer to Appendix A, Specifications.

1.2 Applications

- Temperature measurement
- Industrial ON/OFF control
- Industrial and Lab. automation

1.3 Installation Guide

Before you install your USB-4718 module, please make sure you have the following necessary components:

- USB-4718 DAS Module
- USB-4718 User Manual
- Shielded USB 2.0 cable (1.8 m)
- Driver software Advantech DLL drivers (included in the companion CD-ROM)
- Personal computer or workstation with a USB port (running Windows 2000, or XP)

Some application software is also available for enhanced operation. USB-4718 works with ActiveDAQ, ActiveDAQ Pro, and other third-party software packages.

After you have the necessary components and maybe some accessories for enhanced operation of your USB DAS module, you can then begin the installation procedure. Figure 1.1 on the next page provides a concise flow chart to give a broad picture of the software and hardware installation procedures.

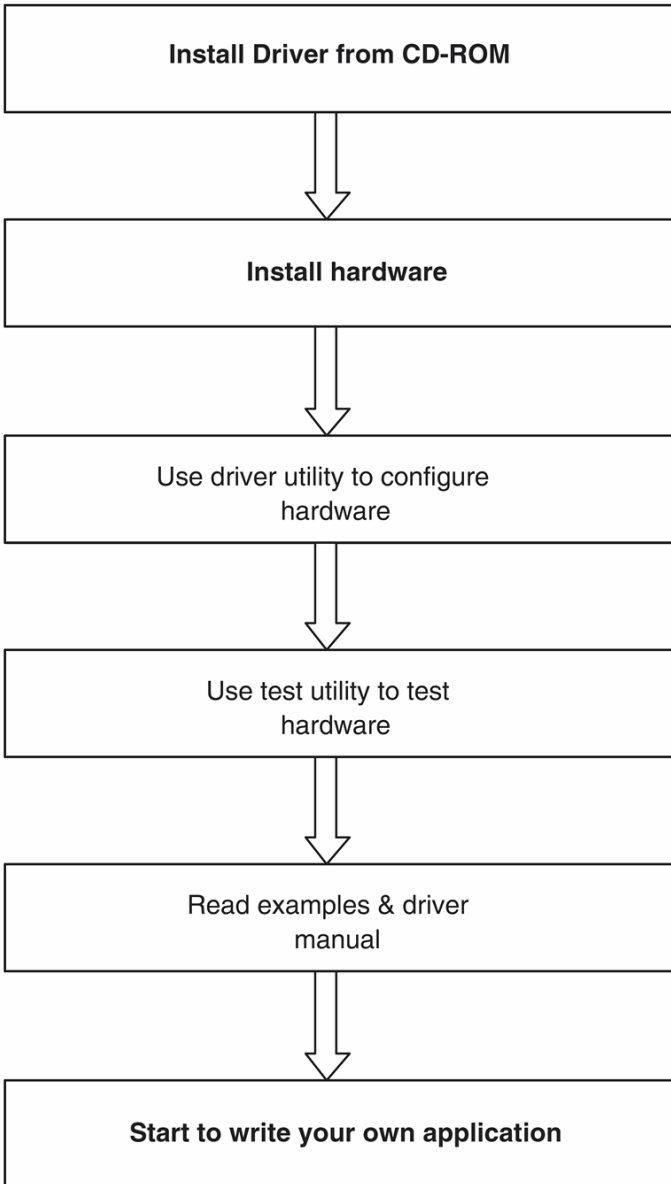

Figure 1.1: Installation Flow Chart

1.4 Software Overview

Advantech offers a rich set of DLL drivers, third-party driver support and application software to help fully exploit the functions of your USB-4718 module:

- Device Drivers (on the companion CD-ROM)
- LabVIEW driver
- Advantech ActiveDAQ

1.4.1 Programming Choices for DA&C Module:

You may use Advantech application software like Advantech Device Drivers. On the other hand, advanced users are allowed to use register-level programming as another option, although this is not recommended due to its laborious and time-consuming nature.

1.4.2 Device Drivers

The Advantech Device Drivers software is included on the companion CD-ROM. Advantech's Device Drivers features a complete I/O function library to help boost your application performance. The Advantech Device Drivers for Windows 2000/XP works seamlessly with development tools such as Visual C++, Visual Basic, Inprise C++ Builder, and Inprise Delphi.

1.5 Device Driver Programming Roadmap

This section will provide a roadmap to demonstrate how to build an application from scratch using Advantech Device Drivers with your favorite development tools such as Visual C++, Visual Basic, Delphi, or C++ Builder. The step-by-step instructions on how to build your own applications using each development tool will be given in the Device Drivers Manual. Moreover, a rich set of example source code is also given for your reference.

1.5.1 Programming Tools

Programmers can develop application programs with the following development tools:

- Visual C++
- Visual Basic
- Delphi
- C++ Builder

For instructions on how to begin programming in each development tool, Advantech offers a Tutorial Chapter in the Device Drivers Manual for your reference. Please refer to the corresponding sections in this chapter on the Device Drivers Manual to begin your programming efforts. You can also look at the example source code provided for each programming tool, since they can get you very well oriented.

The Device Drivers Manual can be found on the companion CD-ROM. Alternatively, if you have already installed the Device Drivers on your system, The Device Drivers Manual can be readily accessed through the Start button:

Start/Programs/Advantech Automation/Advantech Device Manager /Device Driver's Manual

The example source code can be found under the corresponding installation folder such as the default installation path:

\\Program Files\\Advantech\\ADSAPI\\Examples

For information about using other function groups or other development tools, please refer to *Creating Windows 2000/XP Applications with Device Drivers* chapter and the *Function Overview* chapter in the Device Drivers Manual.

1.5.2 Programming with Device Drivers Function Library

Advantech Device Drivers offer a rich function library that can be utilized in various application programs. This function library consists of numerous APIs that support many development tools, such as Visual C++, Visual Basic, Delphi and C++ Builder.

1.5.3 Troubleshooting Device Drivers Error

Driver functions will return a status code when they are called to perform a certain task for the application. When a function returns a code that is not zero, it means the function has failed to perform its designated function. To troubleshoot the Device Drivers error, you can pass the error code to `DRV_GetErrorMessage` function to return the error message.

Alternatively, you can refer to the Device Drivers Error Codes Appendix in the Device Drivers Manual for a detailed listing of Error Codes, Error IDs and the Error Messages.

Installation

This chapter has a package item checklist, proper instructions about unpacking and step-by-step procedures for both driver and USB installation..

Sections include:

- Unpacking
- Driver Installation
- Hardware Installation
- Device Setup & Configuration
- Device Testing
- Hardware Uninstallation

Chapter 2 Installation

2.1 Unpacking

After receiving your USB-4718 package, please inspect its contents first. The package should contain the following items:

- USB-4718 Module
- Shielded USB 2.0 Cable (1.8 m)
- Companion CD-ROM (DLL driver included)
- User Manual

The USB-4718 Module harbors certain electronic components vulnerable to *electrostatic discharge* (ESD). ESD could easily damage the integrated circuits and certain components if preventive measures are not carefully paid attention to. ***Before removing the module from the antistatic plastic bag, you should take following precautions to ward off possible ESD damage:***

- Touch the metal part of your computer chassis with your hand to discharge static electricity accumulated on your body. One can also use a grounding strap.
- Make contact between the antistatic bag and ground before opening the bag.

After taking out the module, you should first:

Inspect the module for any possible signs of external damage (loose or damaged components, etc.). If the module is visibly damaged, please notify our service department or our local sales representative immediately. Avoid using a damaged module with your system.

- Avoid physical contact with materials that could hold static electricity such as plastic, vinyl and Styrofoam.

2.2 Driver Installation

We recommend you install the software driver before you install the USB-4718 module into your system, since this will guarantee a smooth installation process.

The 32-bit DLL driver Setup program for the USB-4718 module is included on the companion CD-ROM that is shipped with your module package. Please follow the steps below to install the driver software:

Step 1: Insert the companion CD-ROM into your CD-ROM drive.

Step 2: The Setup program will be launched automatically if you have the auto-play function enabled on your system. When the Setup Program is launched, you'll see the following Setup Screen.

Note: *If the auto-play function is not enabled on your computer, use Windows Explorer or Windows Run command to execute Setup.exe on the companion CD-ROM.*



Figure 2.1: Automation Software Setup Screen

Step3: Click *Continue*, and select the *Installation* option

Step4: Select the specific device and then just follow the installation instructions step by step to complete your device driver installation and setup.

For further information on driver-related issues, an online version of the Device Drivers Manual is available by accessing the following path:

Start\Programs\Advantech Automation

\Advantech Device Manager\Device Driver's Manual

2.3 Hardware Installation

Note: Make sure you have installed the software driver before you install the module (please refer to Section 2.2 Driver Installation)

After the DLL driver installation is completed, you can now go on to install the USB-4718 module in any USB port that supports the USB 2.0 standard, on your computer. It is suggested that you refer to the computer's user manual or related documentation if you have any doubts. Please follow the steps below to install the module on your system.

Step 1: Touch the metal part on the surface of your computer to neutralize the static electricity that might be in your body.

Step 2: Plug your USB module into the selected USB port. Hold the module only by its edges Plug the module firmly into place. Use of excessive force must be avoided; otherwise the module might get damaged.

Note: In case you installed the module without installing the DLL driver first, Windows 2000/XP will recognize your module as an "unknown device" after reboot, and will prompt you to provide necessary driver. You should ignore the prompting messages (just click the Cancel button) and set up the driver according to the steps described in Section 2.2 Driver Installation.

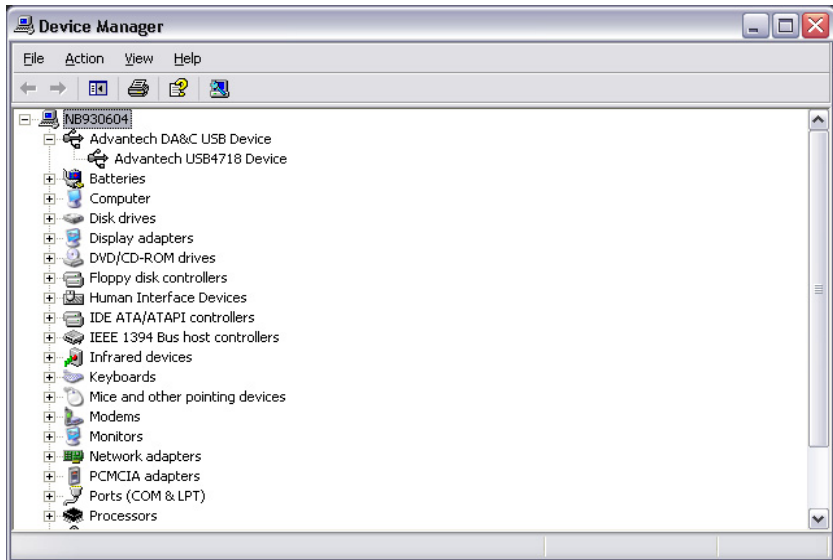

Figure 2.2: Device Manager Screen

Note: *If your module is properly installed, you should see the device name of your module listed on the Device Manager tab. If you see your device name listed, but marked with an exclamation sign “!” (Fig. 2-4), it means your module has not been correctly installed. In this case, remove the module from Device Manager by selecting its device name and press the **Remove** button. Then go through the driver installation process again.*

You can check the Device Properties to see if your device is running under "Full Speed" mode (USB 1.1) or "High Speed" mode (USB 2.0). See figure 2.3 on the next page.

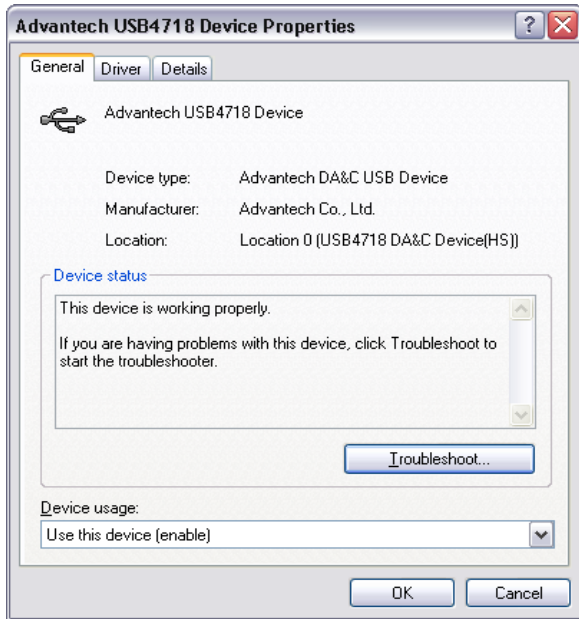

Figure 2.3: USB-4718 Device Speed

After your module is properly installed with your system, you can now configure your device using the *Advantech Device Manager* that has itself already been installed on your system during driver setup. A complete device installation procedure should include *device setup*, *configuration* and *testing*. The following sections will guide you through the Setup, Configuration and Testing of your device.

2.4 Device Setup & Configuration

Advantech Device Manager is a utility that allows you to set up, configure and test your devices, and later stores your settings in the system registry. These settings will be used when you call the APIs of Advantech 32-bit DLL drivers.

2.4.1 Setting Up the Device

Step 1: To complete the device setup and configuration procedures, you must first install the device along with its driver. (Please refer to the previous section of Chapter 2 for detailed installation instructions).

Step2: You can view the device(s) already installed on your system (if any) in the Installed Devices list box. If you haven't installed any devices, you might see a blank list.

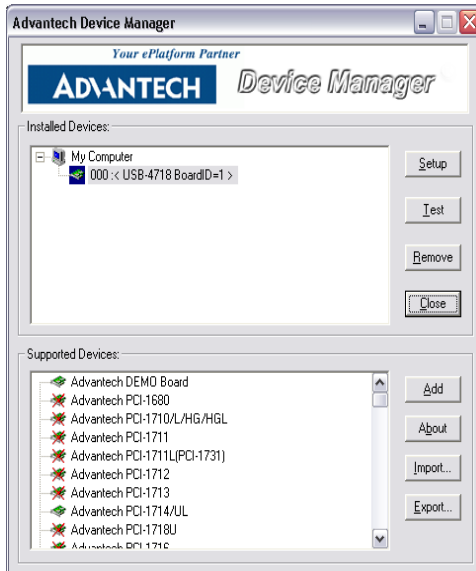

Figure 2.4: Device Manager Dialog Box

Note: *If you have properly installed the device driver but still can't find it in Advantech Device Manager, please close the Advantech Device Manager and restart it.*

2.4.2 Configuring the Device

Step 3: Click “**Setup**” button and you will see the “*Device Setting*” dialog box as follow. On the *Device Setting* dialog box, you can specify the BoardID of the device and perform the AI calibration function for the AI channels. "Locate" will blink the on-module LED till you release the bottom so you can easily identify the device you are operating.

"Restore" will reset device configurations to the factory settings.

Note: Please refer to Appendix C for a detailed calibration procedure.

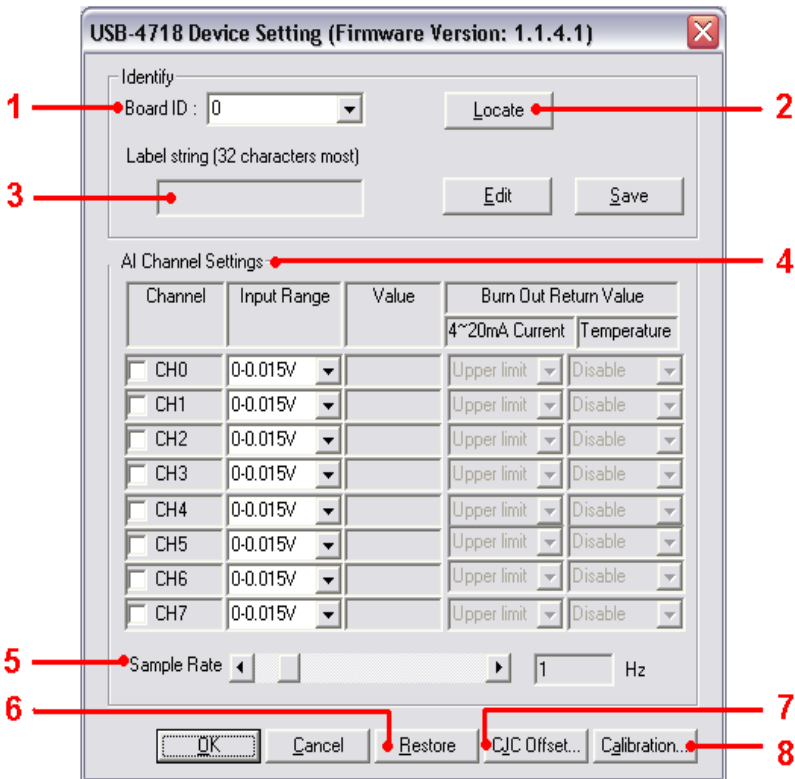

Figure 2.5: The Device Setting Dialog Box

- 1.Board ID:** Set the Board ID for easy identification.
- 2.Locate:** The on-module LED indicator blinks when you continually press “*Locate*” button.
- 3.Label string:** Edit the string label for identification purpose.

4. **AI Channel setting:** Set the thermocouple type/ analog input range for each AI channel.

5. **Sample Rate adjustment:** Drag the slide bar to adjust the sampling rate of your device.

6. **Restore:** Restore the AI Calibration setting or the CJC offset setting to default.



(Restore Setting. Tif)

7. **CJC Offset:** Adjust CJC offset setting.

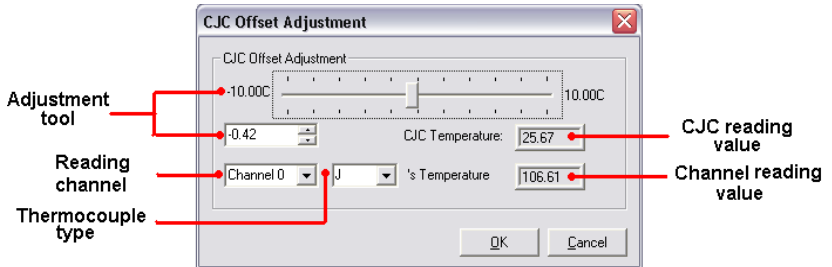

(CJC Offset Adjustment. Tif)

8. **AI Calibration:** Analog input channel calibration function. Please refer to Appendix D for detailed operating guide.

2.4.3 Gain Code Setting

Configure the AI (analog input) channel's input voltage/current range by setting the corresponding *GainCode* of the device. The configuration for voltage and current is differentiated by the value of *GainCode*. The value of current *GainCode* is greater than 0x8000. Please refer to USB-4718's software manual for more detail information.

Table 2.1: Gain Code

Gain Code (Hex)	Type	Range
0x08	Voltage	0-15mV
0x0A	Voltage	0-50mV
0x0B	Voltage	0-100mV
0x0D	Voltage	0-500mV
0x0E	Voltage	0-1.0V
0x0F	Voltage	0-2.5V
0x8000	Current	0-20mA
0x8001	Current	4-20mA

2.5 Device Testing

Following the *Setup* and *Configuration* procedures to the last step described in the previous section, you can now proceed to test the device by clicking the **Test** Button in the *I/O Device Installation* dialog window. In the *Device Test* dialog window, you are free to test various functions of USB-4718 on the *Analog input*, *Analog output*, *Digital input*, *Digital output* or *Counter* tabs.

2.5.1 Testing Analog Input Function

Click the *Analog Input* tab to bring it up to front of the screen. Select the input range for each channel in the *Input range* drop-down boxes. Configure the sampling rate on the scroll bar. Switch the channels by using the up/down arrow.

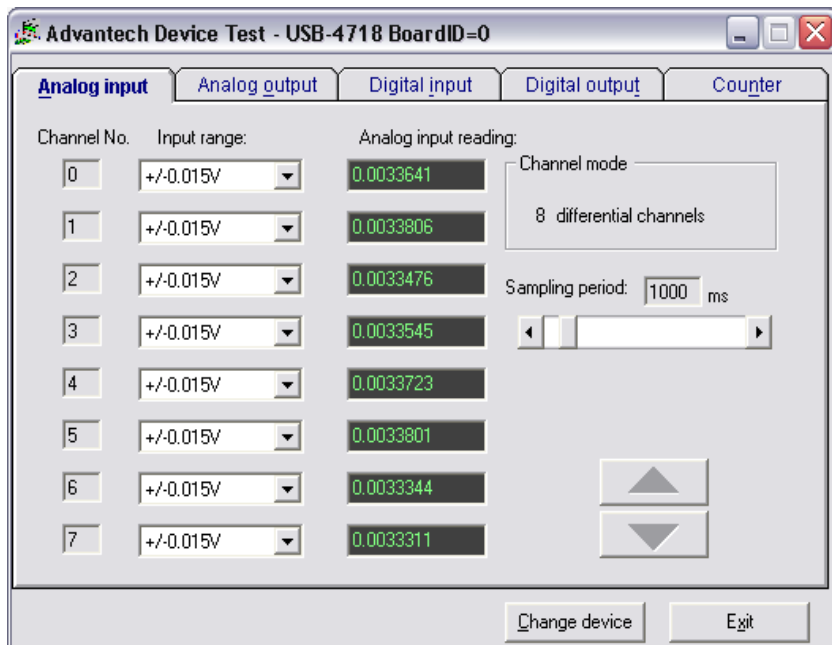

Figure 2.6: Analog Input Tab/Device Test Dialog

2.5.2 Testing Analog Output Function

Unsupported on this module.

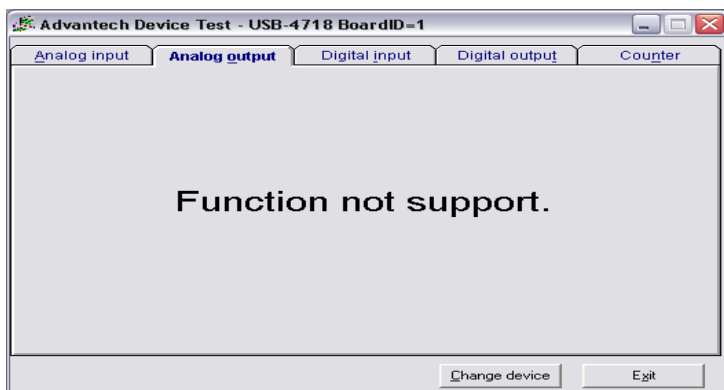

Figure 2.7: Analog Output Function Not Supported

2.5.3 Testing Digital Input Function

Click the *Digital Input* tab to show the *Digital Input* test panel as seen below. By the color of the LEDs, you can easily discern whether the status of each digital input channel is high or low.

Red lamp: High **Green lamp:** Low

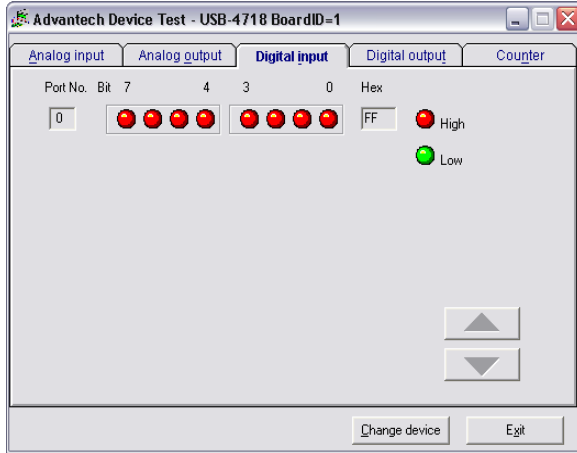

Figure 2.8: Digital Input Tab/Device Test Dialog

2.5.4 Testing Digital Output Function

Click the *Digital Output* tab to bring up the *Digital Output* test panel as shown below. By pressing the buttons on each tab, you can easily set each digital output channel as *high* or *low* for the corresponding port.

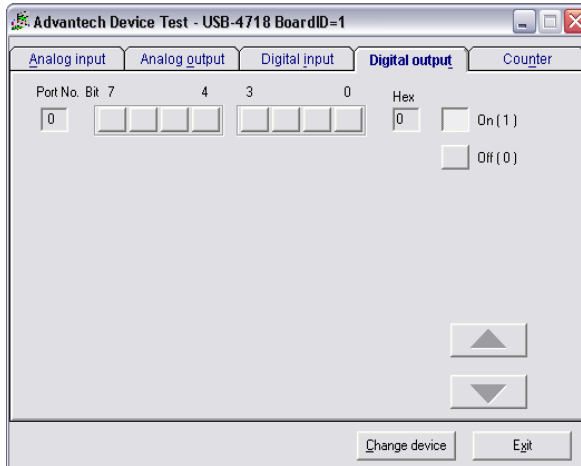

Figure 2.9: Digital Output Tab/Device Test Dialog

2.5.5 Testing Counter Function

Unsupported on this module.

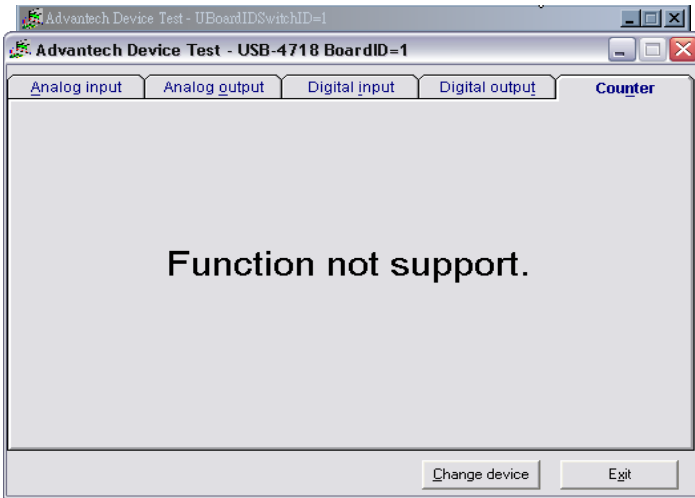

Figure 2.10: Counter Tab Testing Unsupported

Only after your module device is properly set up, configured and tested, can the device installation procedure be considered complete. After the device installation procedure is completed, you can safely proceed to the next chapter, *Signal Connections*.

2.6 Hardware Uninstallation

Though the Advantech USB modules are hot swappable, we still recommend you to follow the hardware un-installation procedure to avoid any unpredictable damages to your device or your system.

Step1: Close the applications of the USB module (ex. Advantech Device Manager).

Step2: Right click the “Unplug or Eject Hardware” icon on your task bar.

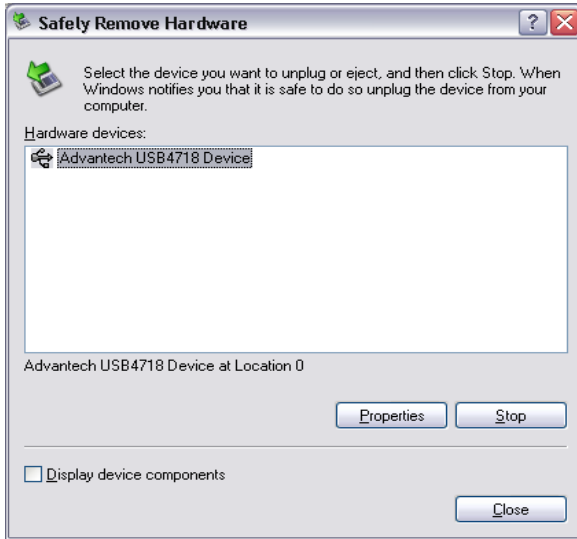

Figure 2.11: Unplug or Eject Hardware Dialog

Step3: Select “Advantech USB4718 Device” and press “Stop” Button.



Figure 2.12: Stop a Hardware device dialog box

Step4: Unplug your USB device from the USB port.

Note: *Please make sure that you have closed the application programs before unplugging the USB device, otherwise some unexpected system errors or damages may happen.*

Signal Connections

This chapter provides useful information on how to connect input and output signals to the USB-4718 via the I/O connectors..

Sections include:

- Overview
- I/O Connectors
- Analog Input Connections
- Analog Output Connections
- Trigger Source Connections
- Field Wiring Considerations

Chapter 3 Signal Connections

3.1 Overview

Maintaining good signal connections is one of the most important factors in ensuring that your application system is sending and receiving data correctly. A good signal connection can avoid unnecessary and costly damage to your PC and other hardware devices.

3.2 I/O Connectors

USB-4718 is equipped with plug-in screw-terminal connectors that facilitate connection to the module without terminal boards or cables.

3.2.1 Pin Assignment

Figure 3.1 on next page shows the pin assignments for the five 10-pin I/O connectors on USB-4718.

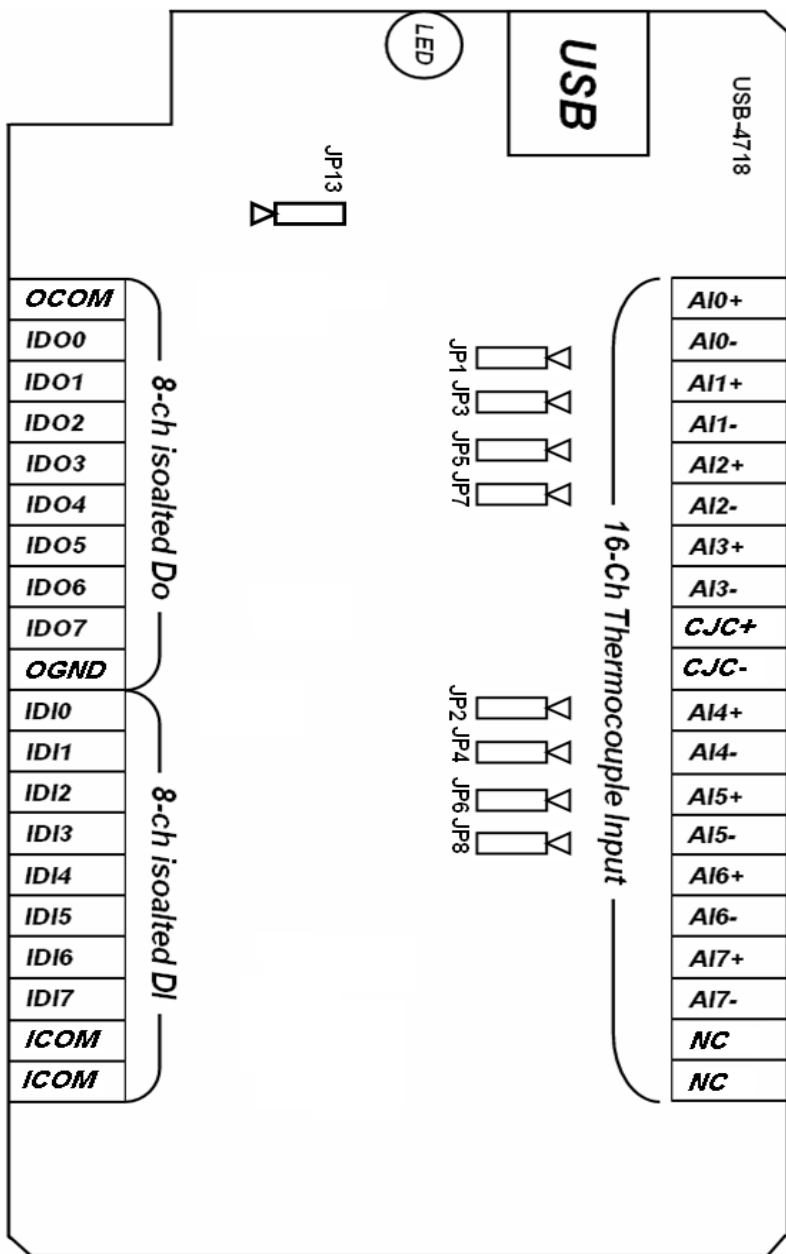

Figure 3.1: I/O Connector Pin Assignment

3.2.2 I/O Connector Signal Description

Table 3.1: I/O Connector Signal Description

Signal Name	Reference	Direction	Description
IDI<0~7>	ICOM	Input	Isolated Digital Input Channels
ICOM	--	--	Common Port of IDI Channels
IDO<0~7>	OCOM	Output	Isolated Digital Output Channels
OGND	--	--	Isolated Digital Output Ground
OCOM	--	--	Positive External Power Supply
AI<0~7>	--	Input	Analog Input Channels
CJC+/CJC-	--	--	Cold Junction Compensation
NC	--	--	No connected

3.2.3 LED Indicator Status Description

The USB Module is equipped with a LED indicator to show the current status of the device. When you plug the USB device into the USB port, the LED indicator will blink five times and then stay lit to indicate that it is on. Please refer to the following table for detailed LED indicator status information.

Table 3.2: LED Indicator Status Description

LED Status	Description
ON	Device ready for work
Off	Device not ready to work
Slow Blinking (5 times)	Device Initialization
Fast Blinking (Depends on data transfer speed).	Device working

3.2.4 3.2.4 Jumper Setting Description

Table 3.3: Jumper Setting Description

Jumper	Description	Jumper	Description
JP1	Input mode setting for analog input ch0	JP6	Input mode setting for analog input ch6
JP2	Input mode setting for analog input ch4	JP7	Input mode setting for analog input ch3
JP3	Input mode setting for analog input ch1	JP8	Input mode setting for analog input ch7
JP4	Input mode setting for analog input ch5	JP13	Watchdog timer setting
JP5	Input mode setting for analog input ch2		

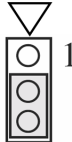

JP1~JP8: Input Mode Setting for Analog Input Channels

The analog input mode of every AI channel on USB-4718 can be set by JP1~JP8 separately to measure the voltage sources or the current sources. Inappropriate setting of the jumpers can cause unpredictable errors or malfunction of USB-4718.

Jumper Setting		
Description	Set the channel to voltage input mode (Default setting)	Set the channel to current input mode

JP13: Watchdog Timer Setting

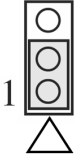
The watchdog timer supervisory function will automatically reset USB-4718 in the event of system failure. JP13 on USB-4718 can enable/disable watchdog timer function or reset module manually.

Jumper Setting		
Description	Enable watchdog timer function (Default setting)	Disable watchdog timer function

How to Reset USB-4718 Manually

Plug the jumper to JP13 pin2-3 and then remove it, USB-4718 will reset.

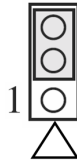

NOTE: Users may restart the application programs after USB-4718 is reset.

3.3 Analog Input Connections

The differential input channels operate with two signal wires for each channel, and the voltage difference between both signal wires is measured. There are 8 analog input channels available on USB-4718

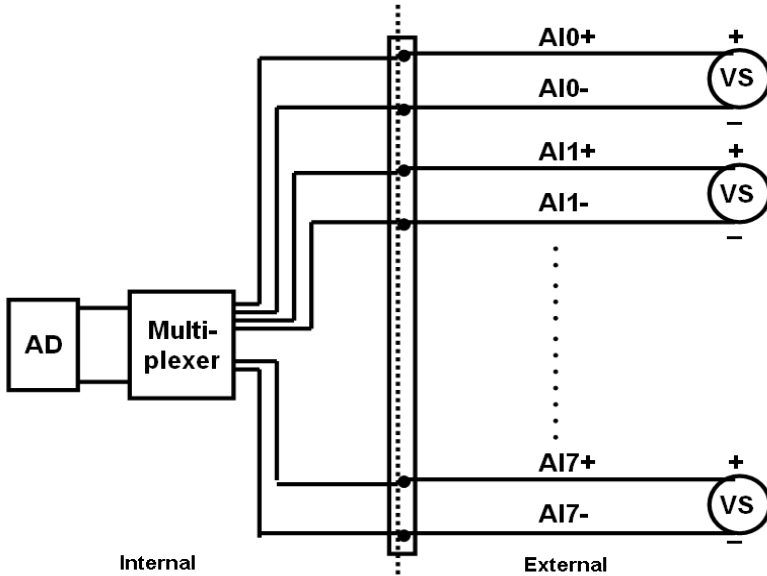

Figure 3.2: Differential Input Channel Connection

3.4 Isolated Digital Input Connections

USB-4718 has 8 isolated digital input channels designated IDI0~IDI7. Each of isolated digital input channel accepts 5~30 VDC voltage inputs, and accept bi-directional input. It means that you can apply positive or negative voltage to an isolated input pin (IDI). All 8 input channels share one common pin. Figure 3-3 shows how to connect an external input source to one of the module's isolated input channels

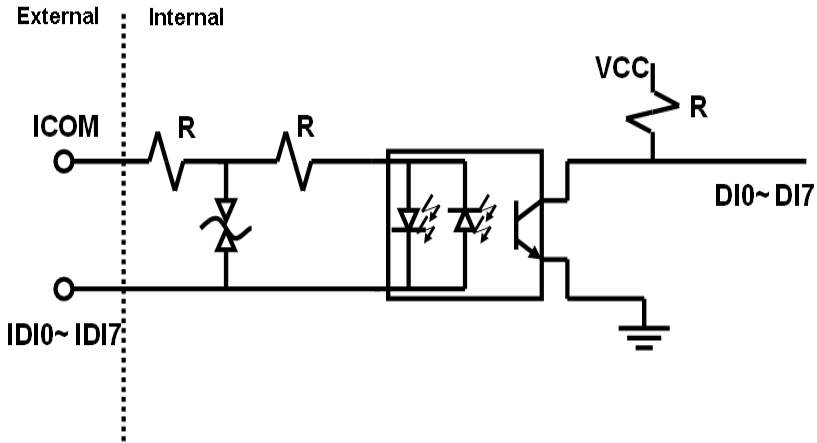

Figure 3.3: Digital Input Channel Connections

3.5 Isolated Digital Output Connections

USB-4718 has 8 isolated digital output channels designated IDO0~IDO7. Each of isolated output channels comes equipped with a Darlington transistor. All 8 output channels share common collectors and integral suppression diodes for inductive loads. Figure 3-4 shows how to connect an external output load to the module's isolated outputs.

Note:

If an external voltage (5 ~ 30 VDC) is applied to an isolated output channel while it is being used as an output channel, the current will flow from the external voltage source to the card. Please take care that the current through each IDO pin not exceed 200 mA.

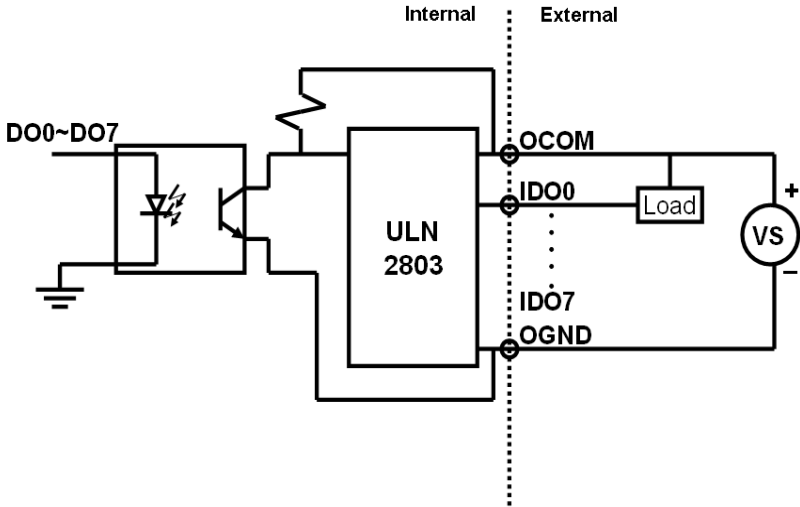

Figure 3.4: Isolated Digital Input Channel Connections

3.6 Field Wiring Considerations

- When you use USB-4718 to acquire data from outside, noises in the environment might significantly affect the accuracy of your measurements if due cautions are not taken. The following measures will be helpful to reduce possible interference running signal wires between signal sources and the USB-4718.
- The signal cables must be kept away from strong electromagnetic sources such as power lines, large electric motors, circuit breakers or welding machines, since they may cause strong electromagnetic interference. Keep the analog signal cables away from any video monitor, since it can significantly affect a data acquisition system.
- If the cable travels through an area with significant electromagnetic interference, you should adopt individually shielded, twisted-pair wires as the analog input cable. This type of cable has its signal wires twisted together and shielded with a metal mesh. The metal mesh should only be connected to one point at the signal source ground.
- Avoid running the signal cables through any conduit that might have power lines in it.

- If you have to place your signal cable parallel to a power line that has a high voltage or high current running through it, try to keep a safe distance between them. Or place the signal cable in a right angle to the power line to minimize the undesirable effect.

APPENDIX

A

Specifications

Appendix A Specifications

A.1 Analog Input

Channels	8 differential
Input type	mV, V, and mA
Input range	J, K, T, E, R, S and B Thermocouple Uni-polar 0~15mV, 0~50mV, 0~100mV, 0~500mV, 0~1V, 0~2.5V, 0~20mA, 4~20mA
Sampling rate	10 samples/s(total)
Accuracy	±0.1% or better (voltage and current input)
Zero drift	±0.3 uV / °C
Span drift	±25 ppm / °C
CMR @ 50/60 Hz	92 dB
Input impedance	1.8 M

A.2 Accuracy for Thermocouple:

Input Range	Typical Accuracy	Maximum Error
J thermocouple 0 to 760 °C	±1.0 °C	±1.5 °C
K thermocouple 0 to 1370 °C	±1.0 °C	±1.5 °C
T thermocouple -100 to 400 °C	±1.0 °C	±1.5 °C
E thermocouple 0 to 1000 °C	±1.0 °C	±1.5 °C
R thermocouple 500 to 1750 °C	±1.2 °C	±2.5 °C
S thermocouple 500 to 1750 °C	±1.2 °C	±2.5 °C
B thermocouple 500 to 1800 °C	±2.0 °C	±3.0 °C

NOTE: Due to the location of the CJC sensor, the measurement will have a 1°C max. difference in channels.

A.3 Isolated Digital Input

Channels	8	
Interrupt Inputs	N/A	
Optical Isolation	2500 VDC	
Opto-isolator response time	25 μ s	
ESD	2,000 VDC	
Input Voltage	VIH (max.)	30 VDC
	VIH (min.)	5 VDC
	VIL (max.)	3 VDC
Input Current	10 VDC	2.9 mA (typical)
	12 VDC	3.5 mA (typical)
	24 VDC	7.2 mA (typical)
	30 VDC	9.1 mA (typical)

A.4 Isolated Digital Output

Channels	8
Optical Isolation	2500 VDC
Opto-isolator response time	25 μ s
Supply Voltage	5 ~ 30 VDC
Sink Current	200 mA max./ch, 1.1A/total

A.5 General

I/O Connector Type	Removable 10-pin screw terminal x 4	
Dimensions (LxWxH)	132 x 80 x 32 mm (5.2" x 3.2" x 1.3")	
Watchdog timer	Yes	
Power requirements	USB bus-powered	
Power Consumption	100mA @5V max.	
Temperature	Operation	0~60° C (32~140° F) (refer to IEC 68-2-1, 2)
	Storage	-20~70° C (-4~158° F)
Relative Humidity	5~ 95 % RH non-condensing (refer to IEC 68-2-1, 2)	

APPENDIX **B**

Function Block

Appendix B Function Block

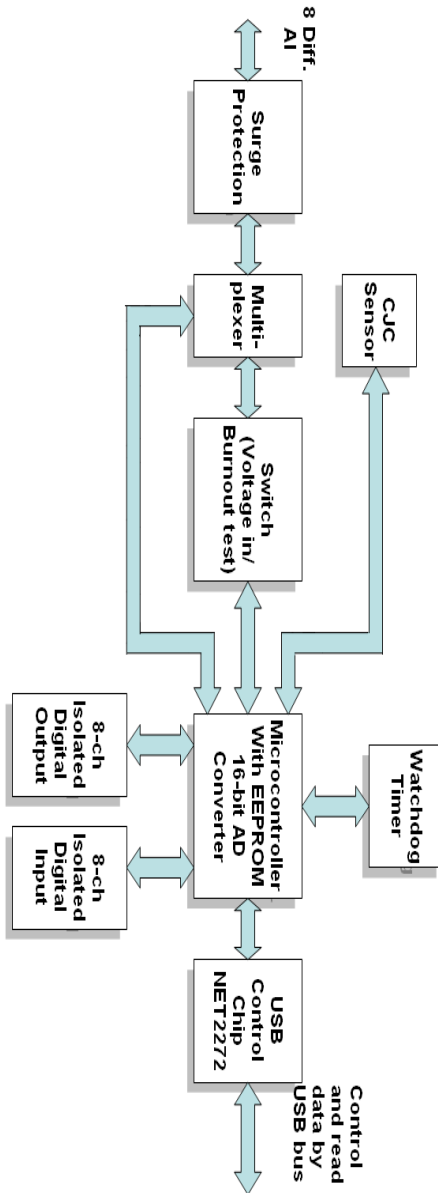

APPENDIX

C

Firmware Download Utility

Appendix C Firmware Download Utility

The firmware download utility can help you update your device's firmware to the newest version to get the latest bug fixes and function improvements.

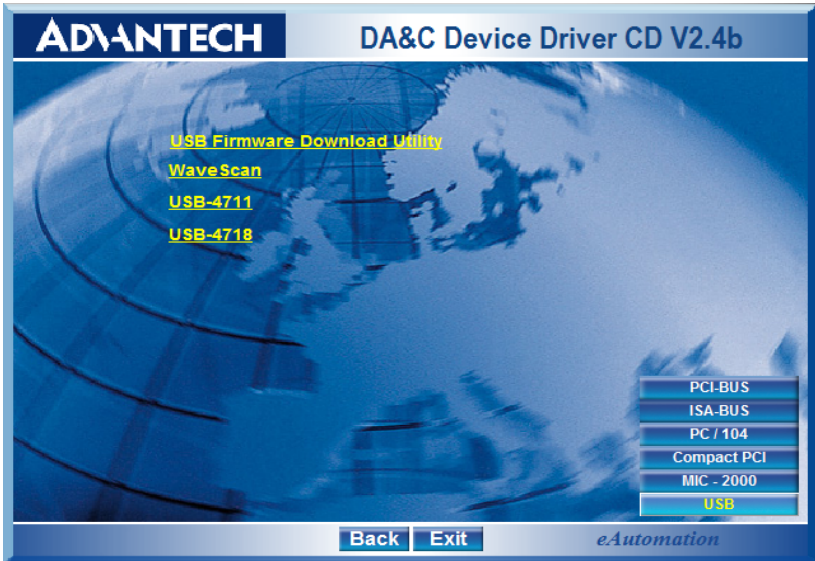

Figure C.1: Install Firmware Download Utility Screen

Note: After installation, the USB firmware download utility is located at C:\Program Files\Advantech\ADSAPI\Utilities by default.

Note: You can get the newest firmware from Advantech's website: www.advantech.com

The steps on the following pages will guide you through the USB-4718 firmware update.

Step1 - Select Device: Launch the firmware download utility and press “Select...” button to choice the target device. You can check the working firmware version at the “Firmware Version” item.

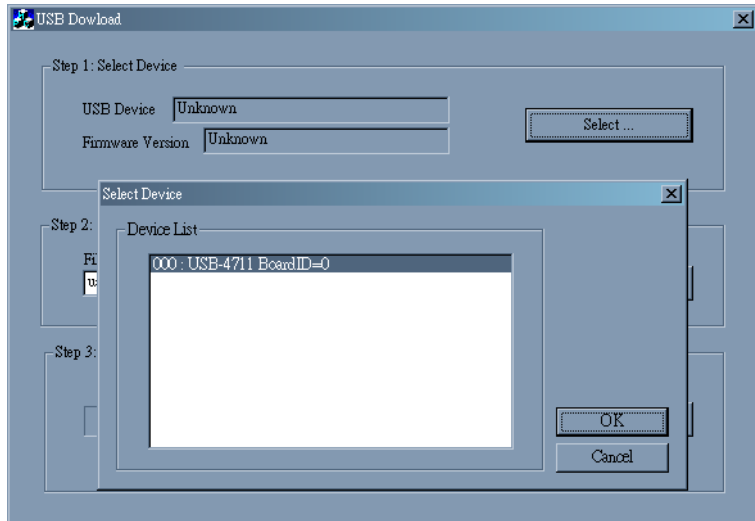

Figure C.2: USB Download Utility

Step2 - Select Firmware File: Press “Load...” button to select the firmware.

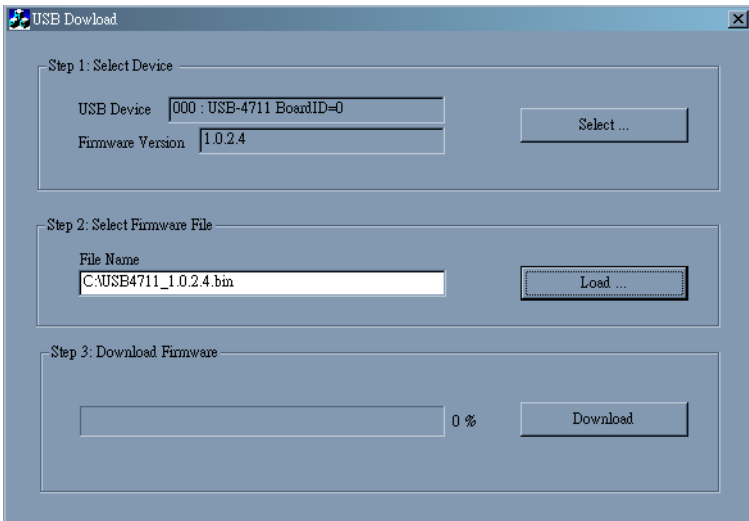

Figure C.3: Firmware Selection

Step3 - Download Firmware: Press “**Download**” to start downloading the firmware to your target device. Then press “**OK**”, unplug your device and reinstall it to bring the new settings effective.

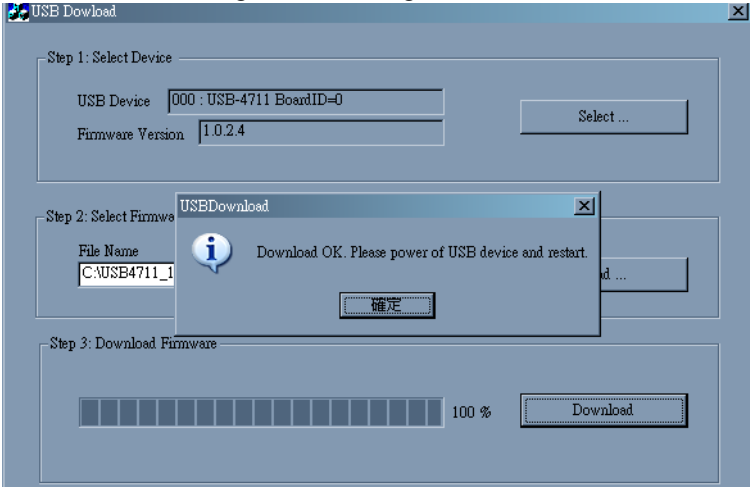

Figure C.4: Firmware Download Completed.

Appendix

D

Analog Input Calibration

Appendix D Analog Input Calibration

The following steps will guide you through the USB-4718 analog input channel software calibration. Please perform BOTH voltage and current input calibrating procedures to complete the calibration of USB-4718's analog input channels.

D.1 Voltage Input Calibration

You need to calibrate only one channel (AIO). The other channels of USB-4718 will be calibrated automatically.

NOTE: Please make sure that the JP1 on USB-4718 is set to voltage input mode before you start voltage input calibrating.

Step 1: Click the “**Setup**” button in the Advantech Device Manager window to launch the USB-4718 Device Setting window. Then click “**Calibration**” to start the calibration process. The Calibration Wizard window will pop up.

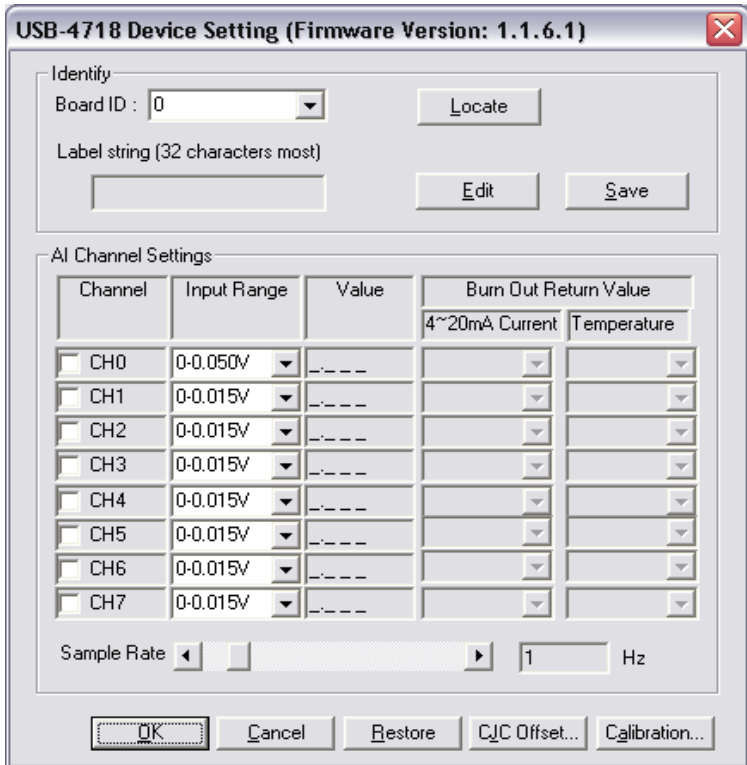

Figure D.1: USB-4718 Device Setting window

Step 2: Select “0–0.015V” voltage input range (or any) and connect the 0V voltage source to **A10** of USB-4718, then click “**Calibrate**”. The information box will show up after the **zero range calibration** is completed. Then click “**OK**”.



Figure D.2: USB-4718 Calibration Wizard

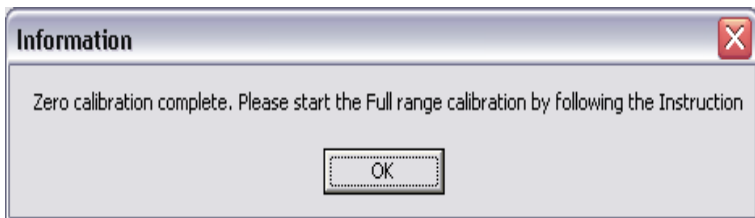

Figure D.3: Zero range calibration complete

Step 3: Please start the **full range calibration** by connecting to the full range voltage source and click “**Calibrate**”. You will see a dialog box and click “**OK**” to finish the calibration process

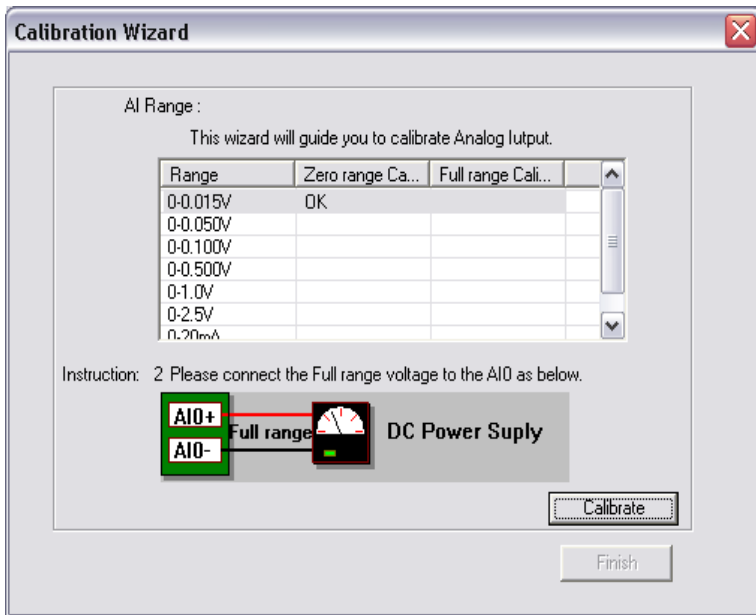

Figure D.4: Full range calibration



Figure D.5: Calibration Complete

Step 4: Please repeat the procedures above to complete the other input ranges (0~0.050V/0~0.100V/0~0.500V/0~1.0V/0~2.5V) calibration.

D.2 Current Input Calibration

You need to calibrate only one channel (AIO). The other channels of USB-4718 will be calibrated automatically.

NOTE: Please make sure that the JP1 on USB-4718 is set to current input mode before you start voltage input calibrating.

Step 1: Please follow the procedures of voltage input calibration but select the current input range setting in Calibration Wizard.

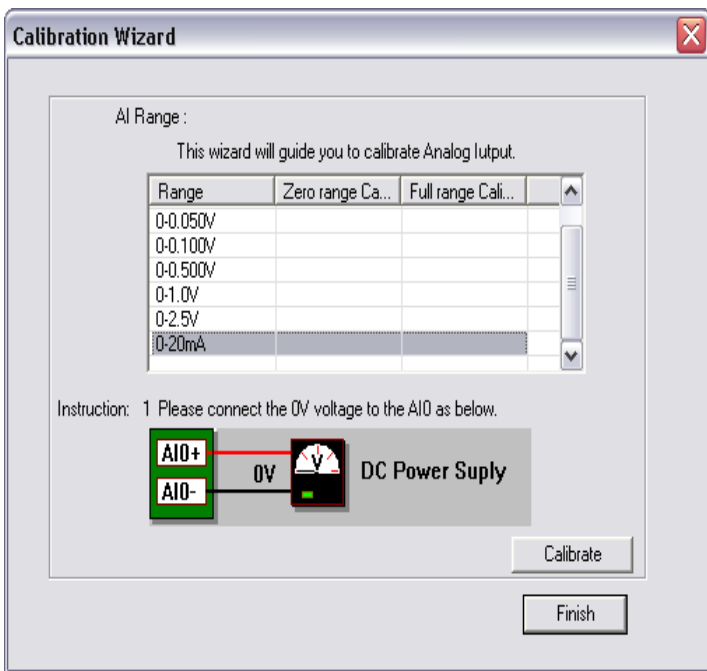

Figure D.6: Select the current input range setting

Step 2: Please perform the **zero range calibration** (connect to a 0mA current source) and the **full range calibration** (connect to a 20mA current source) as well.

Free Manuals Download Website

<http://myh66.com>

<http://usermanuals.us>

<http://www.somanuals.com>

<http://www.4manuals.cc>

<http://www.manual-lib.com>

<http://www.404manual.com>

<http://www.luxmanual.com>

<http://aubethermostatmanual.com>

Golf course search by state

<http://golfingnear.com>

Email search by domain

<http://emailbydomain.com>

Auto manuals search

<http://auto.somanuals.com>

TV manuals search

<http://tv.somanuals.com>