

FOR PERFECT RESULTS

Thank you for choosing this AEG product. We have created it to give you impeccable performance for many years, with innovative technologies that help make life simpler – features you might not find on ordinary appliances. Please spend a few minutes reading to get the very best from it.

ACCESSORIES AND CONSUMABLES

In the AEG webshop, you'll find everything you need to keep all your AEG appliances looking spotless and working perfectly. Along with a wide range of accessories designed and built to the high quality standards you would expect, from specialist cookware to cutlery baskets, from bottle holders to delicate laundry bags...



Visit the webshop at:
www.aeg.com/shop

CONTENTS

- 4 Safety information
- 7 Product description
- 8 Before first use
- 9 Daily use
- 11 Clock functions
- 13 Using the accessories
- 14 Additional functions
- 16 Helpful hints and tips
- 26 Care and cleaning
- 29 What to do if...
- 30 Installation
- 32 Environment concerns
- 33 GREAT BRITAIN & IRELAND -
Guarantee/Customer Service

The following symbols are used in this user manual:



Important information concerning your personal safety and information on how to avoid damaging the appliance.



General information and tips



Environmental information

Subject to change without notice



SAFETY INFORMATION

Before the installation and use, read this manual carefully:

- For your personal safety and the safety of your property
- For the respect of the environment
- For the correct operation of the appliance.

Always keep these instructions with the appliance also if you move or sell it.

The manufacturer is not responsible if incorrect installation or use results in damage.

Children and vulnerable people safety

- This appliance can be used by children aged from 8 years and above and persons with reduced physical, sensory or mental capabilities or lack of experience and knowledge if they have been given supervision or instruction concerning use of the appliance in safe way and understand the hazards involved. Children shall not play with the appliance.
- Keep all packaging away from children. There is the risk of suffocation or physical injury.
- **WARNING:** Keep children and animals away from the appliance when the door is open or the appliance is in the operation, because it becomes hot. There is the risk of injury or other permanent disability.
- If the appliance has Child Lock or Key Lock (Control Lock) function, use it. It prevents children and animals from accidental operation of the appliance.

General safety

- Do not change the specifications of this appliance. There is the risk of injury and damage to the appliance.
- Do not let the appliance stay unattended during operation.
- Switch off the appliance after each use.

Installation

- Only an approved electrician can install and connect the appliance. Contact an approved service centre. This is to prevent the risks of structural damage or physical injury.
- Make sure that the appliance is not damaged because of transport. Do not connect a damaged appliance. If necessary, contact the supplier.
- Remove all packaging, stickers and layers from the appliance before first use. Do not remove the rating plate. It can invalidate the guarantee.
- Make sure that the appliance is disconnected from the power supply during the installation.
- Be careful when you move the appliance. The appliance is heavy. Always use safety gloves. Do not lift the appliance by the handle.
- The electrical installation must have an isolation device which lets you disconnect the appliance from the mains at all poles. The isolation device must have a contact opening width of minimum 3 mm.
- You must have correct isolation devices: line protecting cut-outs, fuses (screw type fuses removed from the holder), earth leakage trips and contactors.

- Before the installation, make sure that the kitchen cabinet has the recess dimensions applicable.
- Make sure that the appliance is installed below and adjacent safe structures.
- Keep the minimum distances to the other appliances and units.
- The appliance cannot be positioned on a base.
- Built in ovens and built in cooking surfaces are attached with special connection system. To prevent damage to the appliance, only use an appliance with the appliances from the same manufacturer.

Electrical connection

- The appliance must be earthed.
- Make sure that the electrical data on the rating plate agree with your domestic power supply.
- Information on the voltage is on the rating plate.
- Always use a correctly installed shockproof socket.
- Do not use multi-way plugs, connectors and extension cables. There is the risk of fire.
- Do not replace or change the mains cable. Contact the service centre.
- Make sure not to squash or cause damage to the mains plug (if applicable) and cable behind the appliance.
- Do not pull the mains cable to disconnect the appliance. Always pull the mains plug – if applicable.

Use

- The appliance is only for domestic use. Do not use the appliance for commercial and industrial use.
- Only use the appliance for domestic cooking tasks. This is to prevent physical injury to persons or prevent damage to property.
- Do not use the appliance as a work surface or storage surface.
- The interior of the appliance becomes hot during use. There is the risk of burns. Do not touch the heating elements in the appliance. Use gloves when you insert or remove the accessories or pots.
- Be careful when you remove or install the accessories to prevent damage to the oven enamel.
- Always stay away from the appliance when you open the door while the appliance is in operation. Hot steam can release. There is the risk of skin burns.
- To prevent damage or discoloration to the enamel:
 - do not put any objects directly on the appliance floor and do not cover it with aluminium foil;
 - do not put hot water directly into the appliance;
 - do not keep moist dishes and food in the appliance after you finish the cooking.
- Discoloration of the enamel has no effect on the performance of the appliance so it is not a defect in the sense of the warranty law.
- Do not apply pressure on the open door.

- Always close the appliance door when you cook, even while grilling.

Care and cleaning

- Before maintenance, switch off the appliance and disconnect the appliance from the power supply.
- Before maintenance, make sure that the appliance is cold. There is the risk of burns. There is the risk that the glass panels can break.
- Keep the appliance clean at all times. A build-up of fats or other foodstuff can result in a fire.
- Regular cleaning prevents the surface material from deteriorating
- Use a deep baking tray for very moist cakes to prevent that fruit juices cause stains that can be permanent.
- For your personal safety and the safety of your property, only clean the appliance with water and a soap. Do not use flammable products or products that can cause corrosion.
- Do not clean the appliance with steam cleaners, high-pressure cleaners, sharp objects, abrasive cleaning agents, abrasive sponges and stain removers
- If you use an oven spray, follow the instructions from the manufacturer.
- Do not clean the glass door with abrasive cleaning agents or metal scraper. Heat resistant surface of the inner glass can break and shatter.
- When the door glass panels are damaged they become weak and can break. You must replace them. Contact the service centre.
- Be careful when you remove the door from the appliance. The door is heavy!
- Do not clean catalytic enamel (if applicable).

Risk of fire

- Open the door carefully. The use of ingredients with alcohol can cause a mixture of alcohol and air. There is the risk of fire.
- Do not let sparks or open flames come near the appliance when you open the door.
- Do not put flammable products or items that are wet with flammable products, and/or fusible objects (made of plastic or aluminium) in, near or on the appliance.

Pyrolytic cleaning

- Do not leave the appliance unattended during Pyrolytic cleaning.
- Do not try to open the door and do not cut the power supply during Pyrolytic cleaning.
- Keep children away during pyrolytic cleaning. The appliance becomes very hot. There is the risk of burns.
- During pyrolytic cleaning, stubborn dirt can cause discoloration to the enamel. Discoloration to the enamel has no effect on the performance of the appliance

Oven lamp

- Bulb lamps used in this appliance are special lamps selected for household appliances use only. They cannot be used for the full or partial illumination of a household room.
- If it becomes necessary to replace the lamp use one of the same power and specifically designed for household appliances only.

- Disconnect the appliance from the power supply before the replacement of the oven lamp. There is the risk of electrical shock.

Service centre

- Only an approved engineer can repair or work on the appliance. Contact an approved service centre.
- Use only original spare parts.

Disposal of the appliance

- To prevent the risk of physical injury or damage
 - Disconnect the appliance from the power supply.
 - Cut off the mains cable and discard it.
 - Discard the door catch. This prevents children or small animals from being closed inside of the appliance. There is the risk of suffocation.

PRODUCT DESCRIPTION

General overview

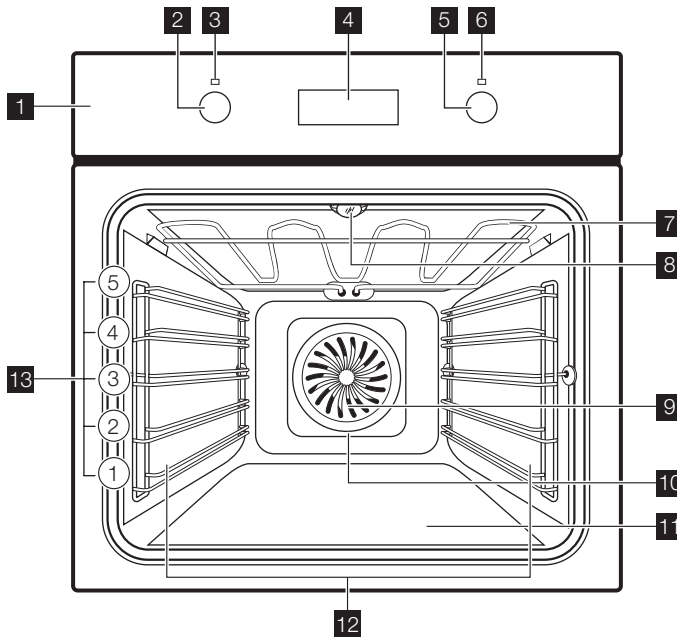

- 1** Control panel
- 2** Control knob for oven functions
- 3** Power lamp/symbol
- 4** Electronic programmer

- 5 Control knob for temperature
- 6 Power lamp
- 7 Heating element
- 8 Oven lamp
- 9 Fan
- 10 Rear wall heating element
- 11 Bottom heat
- 12 Shelf support, removable
- 13 Shelf positions

Accessories

- Nonstick wire shelf
For cookware, cake tins, roasts.

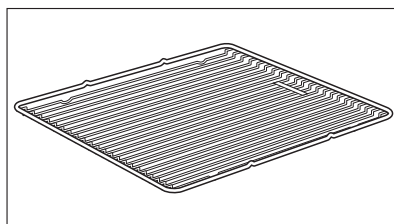

- Trivet
For roasting and grilling.



Use the trivet only with the grill/roasting pan.

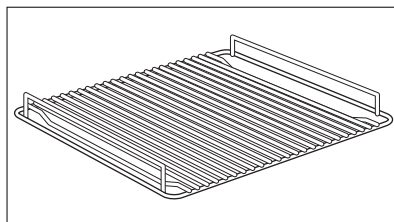

- Grill / roasting pan
To bake and roast or as pan to collect fat.

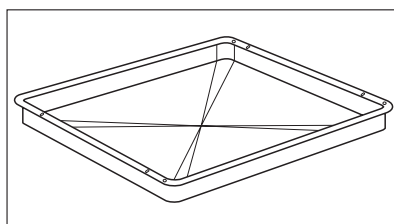

BEFORE FIRST USE



WARNING!

Refer to "Safety information" chapter.

Initial Cleaning

- Remove all parts from the appliance.
- Clean the appliance before first use.



Refer to chapter "Care and Cleaning".

First connection to the mains

After first connection to the mains all symbols in the display are on for some seconds. For the subsequent few seconds the display shows software version.

Setting the time of day

After the software version goes off, the display shows **hr** and "12:00". "12" flashes.

1. Press **+** or **-** to set current hour.
2. Press  to confirm (necessary only for the first setting, later new time will be saved automatically after 5 seconds).



The display shows **min** and set hour. "00" flashes.

3. Press **+** or **-** to set current minutes.
4. Press  to confirm (necessary only for the first setting, later new time will be saved automatically after 5 seconds).

The Temperature/Time display shows new time.

Changing the time of day

You can change the time of day only if the oven is off.

Press . The set time and symbol  flash in the display. To set new time use the procedure "Setting the time of day".

DAILY USE



WARNING!

Refer to "Safety information" chapter.

To use the appliance, press the control knob. The control knob comes out.

Activating and deactivating the appliance











1. Turn the oven functions control knob to select an oven function.
2. Turn the temperature control knob **+** / **-** to set a temperature.
3. To deactivate the appliance turn the oven functions control knob to off position ("0").



Knob symbol, indicator or lamp (depends on the model - refer to the appliance overview):

- The indicator comes on when the oven heats up.
- The lamp comes on when the appliance operates.
- The symbol shows whether the knob controls one of the cooking zones, the oven functions or the temperature.

Oven Functions

Oven function	Application
 Fast Heat Up	To decrease the heat-up time.
 True Fan Cooking	To bake maximum on three oven levels at the same time. Decrease the oven temperatures (20-40 °C) compared with Conventional. And to dry food.
 Pizza Setting	To bake on one oven level food with a more intensive browning and a crispy base. Decrease the oven temperatures (20-40 °C) compared with Conventional
 Conventional Cooking	To bake and roast on one oven level.
 Bottom Heat	To bake cakes with crispy or crusty bases and to preserve food
 Defrost	To defrost frozen food.
 Grilling	To grill flat food in the middle of the grill and to toast.
 Fast Grilling	To grill flat food in large quantities and to toast.
 Turbo Grilling	To roast larger joints of meat or poultry on one level. Also to gratinate and brown.
 Pyro Cleaning	For automatic pyrolytic cleaning of the oven. It burns off residual dirt in the oven. The oven heats up to approximately 500°C.

Fast heat up function

The fast heat up function decreases the heat up time.

1. Set the fast heat up function. Refer to Oven function table.
2. Turn the temperature control knob $+$ / $-$ to set a temperature.
3. An acoustic signal sounds when the appliance is at the set temperature.



The fast heat up function does not deactivate after the acoustic signal. You must deactivate the function manually.

4. Set an oven function.

Display

- 1** Timer
- 2** Heating Up / Residual heat indicator
- 3** Water tank (selected models only)
- 4** Core temperature sensor (selected models only)
- 5** Door lock (selected models only)
- 6** hr / min
- 7** Clock functions

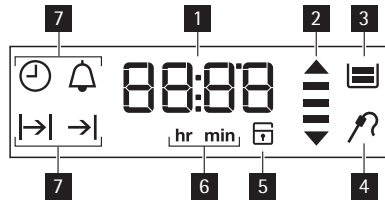

Buttons

Button	Function	Description
	CLOCK	To set the clock function.
	MINUS, PLUS	To set a value for time
	MINUTE MINDER	To set the minute minder. To switch ON/OFF light in oven cavity, hold button more than 3 seconds
	TEMPERATURE	To check temperature inside the oven cavity. To check the Core Temperature Sensor temperature, when is connected (if applicable). Use only when the oven function is set.

Heat-up / Residual heat indicator

If you activate an oven function, the bars in the display come on one by one. The bars show that the oven temperature increases or decrease.



CLOCK FUNCTIONS

SYMBOL	FUNCTION	DESCRIPTION
	MINUTE MINDER	Use to set a countdown time. This function has no effect on the operation of the oven.
	TIME OF DAY	To set, change or control the time of day. Refer to 'Setting the time of day'.
	DURATION	Use only when the oven function is set to set how long the oven operates.
	END	Use only when the oven function is set to set when the oven stops. You can use Duration and End at the same time (Time delay), if the appliance is to be activate and deactivate automatically later.

Press again and again to switch between the clock functions.

- i** To confirm settings of the clock functions use  or wait 5 seconds for an automatic confirmation.

Setting the DURATION or END



1. Press  again and again until the display shows $\rightarrow|$ or $\rightarrow|$.
 $\rightarrow|$ or $\rightarrow|$ flashes in the display.
2. Press $+$ or $-$ to set minutes.
3. Press .
4. Press $+$ or $-$ to set the necessary hour.
5. Press  to confirm.
A sound operates after the time ends for 2 minutes. $\rightarrow|$ or $\rightarrow|$ symbol and time setting flash in the display. The oven stops.
6. Press any button or open the oven door to stop the sound.

- i** If you press  button during setting hours for DURATION $\rightarrow|$, the appliance goes to setting of the END $\rightarrow|$ function.

Setting the MINUTE MINDER

Use to set a countdown (maximum 23 h 59 min) This function has no effect on the operation of the oven

Set the function when the appliance is off:

1. Press .
 and "00" flash in the display.
2. Press $+$ or $-$ to set the seconds.
3. Use the same procedure to set minutes and hours.
When you set hours, minutes replaced seconds on the display and hours replaced minutes. Symbol **hr** comes on the display.
4. MINUTE MINDER starts to operate automatically after 5 seconds.

- i** After 90% of set cooking time an acoustic signal sounds.

5. When set time ends, an acoustic signal sounds for 2 minutes and "00:00" and  flash in the display.

- i** You can set the MINUTE MINDER any time, even if the oven is off.

- i** If you set the MINUTE MINDER when DURATION or END is running, the symbol  goes on the display.

Count Up Timer

Use the Count Up Timer to monitor how long the oven operates. It is on immediately when the oven starts to heat.

Reset the Count Up Timer: press and hold $-$ and $+$ then the timer start to count up again.

i You can not use Count Up Timer when Duration or End is set.

USING THE ACCESSORIES

! **WARNING!**
Refer to "Safety information" chapter.

Installing the Oven Accessories

i The deep pan and the wire shelf have side edges. These edges and the shape of the guide-bars causes the anti-tilt safety for the oven accessories.

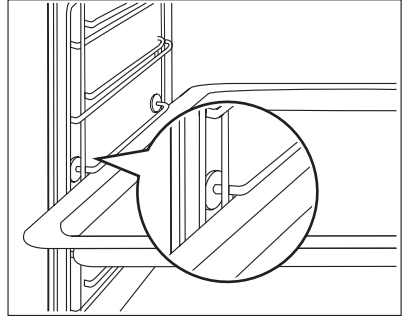

Installing the wire shelf and the deep pan together

Put the wire shelf on the deep pan. Push the deep pan between the guide-bars of one of the oven levels.

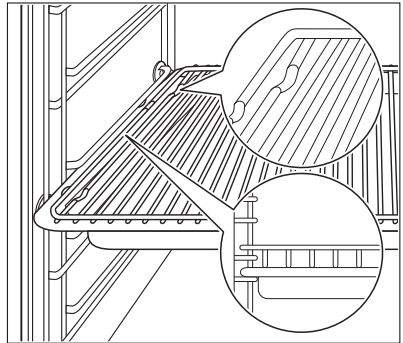

Trivet and grill/roasting pan

! **WARNING!**
Risk of burns when removing the accessories from a hot oven.

You can use the trivet to roast larger pieces of meat or poultry on one level:

- Put the trivet inside the deep pan so that the supports of the oven shelf point up.
- Put the deep pan in the oven at the necessary level.

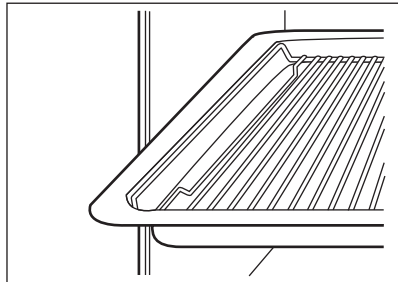

You can use the trivet to grill flat dishes in large quantities and to toast:

- Put the trivet inside the deep pan so that the supports of the oven shelf point downwards.
- Put the deep pan in the oven at the necessary level.

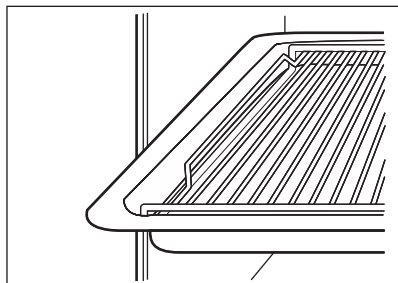



ADDITIONAL FUNCTIONS

Child Lock

The Child Lock prevents an accidental operation of the appliance.

Activating and deactivating the Child Lock function:

1. Do not set an oven function.
2. Press and hold  and  at the same time for 2 seconds.
3. An acoustic signal sounds. SAFE comes on/goes out in the display (when you activate or deactivate the Child Lock).



If the oven has Pyro Cleaning function, the door is locked. SAFE comes on in the display when you turn a knob or press a button.

Control Lock





Applicable to models with Pyro Cleaning function.

The Control Lock prevents an accidental change of the oven function. You can activate the Control Lock function only when the appliance operates.

Activating and deactivating the Control Lock function:

1. Activate the appliance.

2. Activate an oven function or setting.
3. Press and hold  and  at the same time for 2 seconds.
4. An acoustic signal sounds. Loc comes on/goes out in the display (when you activate or deactivate the Control Lock).



If the oven has Pyro Cleaning function, the door is locked.

You can deactivate the appliance when the Control lock is on. When you deactivate the appliance, the control lock deactivates.

Loc comes on in the display when you turn a knob or press a button.

Residual heat indicator

Display shows the residual heat indicator  after end of every cooking sessions when the temperature inside oven cavity is more then 40°C. Use Temperature knob to show the oven temperature on the display.



Cooling fan

When the appliance operates, the cooling fan activates automatically to keep the surfaces of the appliance cool. If you deactivate the appliance, the cooling fan can continue to operate until the appliance cools down.

Switching the display off



You can switch off the display only if the appliance is off.

To switch the display off or on press and hold  and  at the same time until the display switches off or on.

Automatic switch-off

For safety reasons the appliance deactivates itself after some time:

- if an oven function is running.
- if you do not change the oven temperature.

Oven temperature	Switch-off time
30 °C - 120 °C	12.5 h.
120 °C - 200 °C	8.5 h.
200 °C - 250 °C	5.5 h.
250 °C - maximum °C	3.0 h.

After an automatic switch-off, press a any button to operate the appliance again.



The Automatic switch-off works with all oven functions, except Light, Low temperature cooking, Core Temperature Sensor, Duration, End, Time delay.

HELPFUL HINTS AND TIPS

Inner side of door

In some models on the inner side of the door you can find:

- the numbers of the shelf positions (selected models)
- information about the heating functions, recommended shelf positions and temperatures for typical dishes (selected models).



The temperature and baking times in the tables are guidelines only. They depend on the recipes, quality and quantity of the ingredients used.

Baking

General instructions

- Your new oven may bake or roast differently to the appliance you had before. Adapt your usual settings (temperature, cooking times) and shelf positions to the values in the tables.
- With longer baking times, the oven can be switched off about 10 minutes before the end of baking time, to use the residual heat.

When you use frozen food, the trays in the oven can twist during baking. When the trays get cold again, the distortion will be gone.

How to use the Baking Tables

- We recommend to use the lower temperature the first time.
- If you cannot find the settings for a special recipe, look for the one that is almost the same.
- Baking time can be extended by 10-15 minutes, if you bake cakes on more than one level.
- Cakes and pastries at different heights do not always brown equally at first. If this occurs, do not change the temperature setting. The differences equalize during the baking procedure.

Baking on one level:

Baking in tins

Type of baking	Oven function	Shelf position	Temperature °C	Time in min.
Ring cake or brioche	True Fan Cooking	1	150 - 160	50 - 70
Madeira cake/ fruit cakes	True Fan Cooking	1	140 - 160	70 - 90
Sponge cake	True Fan Cooking	2	140 - 150	35 - 50
Sponge cake	Conventional Cooking	2	160	35 - 50
Flan base - short pastry	True Fan Cooking	2	170-180 ¹⁾	10 - 25

Type of baking	Oven function	Shelf position	Temperature °C	Time in min.
Flan base - sponge mixture	True Fan Cooking	2	150 - 170	20 - 25
Apple pie (2tins Ø20cm, diagonally off set)	True Fan Cooking	2	160	60 - 90
Apple pie (2tins Ø20cm, diagonally off set)	Conventional Cooking	1	180	70 - 90
Cheesecake	Conventional Cooking	1	170 - 190	60 - 90

1) Pre-heat the oven

Cakes/pastries/breads on baking trays

Type of baking	Oven function	Shelf position	Temperature °C	Time in min.
Plaited bread/ bread crown	Conventional Cooking	3	170 - 190	30 - 40
Christmas stollen	Conventional Cooking	2	160 - 180 ¹⁾	50 - 70
Bread (rye bread): 1. First part of baking process. 2. Second part of baking process.	Conventional Cooking	1	1. 230 ¹⁾ 2. 160 - 180	1. 20 2. 30 - 60
Cream puffs/ eclairs	Conventional Cooking	3	190 - 210 ¹⁾	20 - 35
Swiss roll	Conventional Cooking	3	180 - 200 ¹⁾	10 - 20
Cake with crumble topping (dry)	True Fan Cooking	3	150 - 160	20 - 40
Buttered almond cake/sugar cakes	Conventional Cooking	3	190 - 210 ¹⁾	20 - 30
Fruit flans (made with yeast dough/ sponge mixture) ²⁾	True Fan Cooking	3	150	35 - 55
Fruit flans (made with yeast dough/ sponge mixture) ²⁾	Conventional Cooking	3	170	35 - 55
Fruit flans made with short pastry	True Fan Cooking	3	160 - 170	40 - 80

Type of baking	Oven function	Shelf position	Temperature °C	Time in min.
Yeast cakes with delicate toppings (e. g, quark, cream, custard)	Conventional Cooking	3	160 - 180 ¹⁾	40 - 80

1) Pre-heat the oven

2) Use deep pan

Biscuits

Type of baking	Oven function	Shelf position	Temperature °C	Time in min.
Short pastry biscuits	True Fan Cooking	3	150 - 160	10 - 20
Short bread/ Pastry Stripes	True Fan Cooking	3	140	20 - 35
Short bread/ Pastry Stripes	Conventional Cooking	3	160 ¹⁾	20 - 30
Biscuits made with sponge mixture	True Fan Cooking	3	150 - 160	15 - 20
Pastries made with egg white, merungues	True Fan Cooking	3	80 - 100	120 - 150
Macaroons	True Fan Cooking	3	100 - 120	30 - 50
Biscuits made with yeast dough	True Fan Cooking	3	150 - 160	20 - 40
Puff pastries	True Fan Cooking	3	170 - 180 ¹⁾	20 - 30
Rolls	True Fan Cooking	3	160 ¹⁾	10 - 25
Rolls	Conventional Cooking	3	190 - 210 ¹⁾	10 - 25
Small cakes (20per tray)	True Fan Cooking	3	150 ¹⁾	20 - 35
Small cakes (20per tray)	Conventional Cooking	3	170 ¹⁾	20 - 30

1) Pre-heat the oven

Multileveled Baking

Cakes/pastries/breads on baking trays

Type of baking	True Fan Cooking		Temperature in °C	Time in min.
	Shelf position			
	2 levels	3 levels		
Cream puffs/ Eclairs	1/4	-	160 - 180 ¹⁾	25 - 45

Type of baking	True Fan Cooking		Temperature in °C	Time in min.
	Shelf position			
	2 levels	3 levels		
Dry streusel cake	1/4	-	150 - 160	30 - 45

1) Pre-heat the oven

Biscuits/small cakes/pastries/rolls

Type of baking	True Fan Cooking		Temperature in °C	Time in min.
	Shelf position			
	2 levels	3 levels		
Short pastry biscuits	1/4	1/3/5	150 - 160	20 - 40
Short bread/ Pastry Stripes	1/4	1/3/5	140	25 - 50
Biscuits made with sponge mixture	1/4	-	160 - 170	25 - 40
Biscuits made with egg white, meringues	1/4	-	80 - 100	130 - 170
Macaroons	1/4	-	100 - 120	40 - 80
Biscuits made with yeast dough	1/4	-	160 - 170	30 - 60
Puff pastries	1/4	-	170 - 180 ¹⁾	30 - 50
Rolls	1/4	-	180	30 - 55
Small cakes (20per tray)	1/4	-	150 ¹⁾	25 - 40

1) Pre-heat the oven

Tips on baking

Baking results	Possible cause	Remedy
The cake is not browned enough underneath	Wrong shelf position	Place cake lower
The cake sinks (becomes soggy, lumpy, streaky)	Oven temperature too high	Use a slightly lower setting
The cake sinks (becomes soggy, lumpy, streaky)	Baking time too short	Set a longer baking time. Baking times cannot be reduced by setting higher temperatures
The cake sinks (becomes soggy, lumpy, streaky)	Too much liquid in the mixture	Use less liquid. Pay attention to mixing times, especially if using mixing machines

Baking results	Possible cause	Remedy
Cake is too dry	Oven temperature too low	Set oven temperature higher
Cake is too dry	Baking time too long	Set a shorter baking time
Cake browns unevenly	Oven temperature too high and baking time too short	Set a lower oven temperature and a longer baking time
Cake browns unevenly	Mixture is unevenly distributed	Spread the mixture evenly on the baking tray
Cake does not cook in the baking time given	Temperature too low	Use a slightly higher oven setting

Bakes and gratins

Dish	Oven function	Shelf position	Temperature °C	Time in min.
Pasta bake	Conventional Cooking	1	180 - 200	45 - 60
Lasagne	Conventional Cooking	1	180 - 200	25 - 40
Vegetables au gratin ¹⁾	Turbo Grilling or True Fan Cooking	1	160 - 170	15 - 30
Baguettes topped with melted cheese	Turbo Grilling or True Fan Cooking	1	160 - 170	15 - 30
Sweet bakes	Conventional Cooking	1	180 - 200	40 - 60
Fish bakes	Conventional Cooking	1	180 - 200	30 - 60
Stuffed vegetables	Turbo Grilling or True Fan Cooking	1	160 - 170	30 - 60

1) Pre-heat the oven

Roasting

Roasting dishes

- Use heat-resistant ovenware to roast (please read the instructions of the manufacturer).
- Large roasting joints can be roasted directly in the deep pan (if present) or on the wire shelf above the deep pan.
- Roast lean meats in a roasting tin with a lid. This will keep the meat more succulent.
- All types of meat, that can be browned or have crackling, can be roasted in the roasting tin without the lid.

Roasting with Turbo Grilling

Beef

Type of meat	Quantity	Oven function	Shelf position	Temperature °C	Time min.
Pot roast	1-1.5 kg	Conventional Cooking	1	230	120 - 150
Roast beef or fillet: rare	per cm. of thickness	Turbo Grilling	1	190 - 200 ¹⁾	5 - 6
Roast beef or fillet: medium	per cm. of thickness	Turbo Grilling	1	180 - 190 ¹⁾	6 - 8
Roast beef or fillet: well done	per cm. of thickness	Turbo Grilling	1	170 - 180 ¹⁾	8 - 10

1) Pre-heat the oven

Pork

Type of meat	Quantity	Oven function	Shelf position	Temperature °C	Time min.
Shoulder, neck, ham joint	1-1.5 kg	Turbo Grilling	1	160 - 180	90 - 120
Chop, spare rib	1-1.5 kg	Turbo Grilling	1	170 - 180	60 - 90
Meat loaf	750 g-1 kg	Turbo Grilling	1	160 - 170	50 - 60
Porkknuckle (pre-cooked)	750 g-1 kg	Turbo Grilling	1	150 - 170	90 - 120

Veal

Type of meat	Quantity	Oven function	Shelf position	Temperature °C	Time min.
Roast veal	1 kg	Turbo Grilling	1	160 - 180	90 - 120
Knuckle of veal	1.5-2 kg	Turbo Grilling	1	160 - 180	120 - 150

Lamb

Type of meat	Quantity	Oven function	Shelf position	Temperature °C	Time min.
Leg of lamb, roast lamb	1-1.5 kg	Turbo Grilling	1	150 - 170	100 - 120
Saddle of lamb	1-1.5 kg	Turbo Grilling	1	160 - 180	40 - 60

Game

Type of meat	Quantity	Oven function	Shelf position	Temperature °C	Time min.
Saddle of hare, leg of hare	up to 1 kg	Conventional Cooking	1	230 ¹⁾	30 - 40
Saddle of venison	1.5-2 kg	Conventional Cooking	1	210 - 220	35 - 40
Haunch of venison	1.5-2 kg	Conventional Cooking	1	180 - 200	60 - 90

1) Pre-heat the oven

Poultry

Type of meat	Quantity	Oven function	Shelf position	Temperature °C	Time min.
Poultry portions	200-250g each	Turbo Grilling	1	200 - 220	30 - 50
Half chicken	400-500g each	Turbo Grilling	1	190 - 210	35 - 50
Chicken, pou-lard	1-1.5 kg	Turbo Grilling	1	190 - 210	50 - 70
Duck	1.5-2 kg	Turbo Grilling	1	180 - 200	80 - 100
Goose	3.5-5 kg	Turbo Grilling	1	160 - 180	120 - 180
Turkey	2.5-3.5 kg	Turbo Grilling	1	160 - 180	120 - 150
Turkey	4-6 kg	Turbo Grilling	1	140 - 160	150 - 240

Fish (steamed)

Type of meat	Quantity	Oven function	Shelf position	Temperature °C	Time min.
Whole fish	1-1.5 kg	Conventional Cooking	1	210 - 220	40 - 60

Grilling

Always grill with the maximum temperature setting.

**CAUTION!**

Always grill with the oven door closed.



Always pre-heat the empty oven with the grill functions for 5 minutes.

- Set the shelf in the shelf position as recommended in the grilling table.
- Always set the pan to collect the fat into the first shelf position.
- Grill only flat pieces of meat or fish.

Grilling

Food to be grilled	Shelf position	Temperature	Time in min.	
			1st side	2nd side
Roast beef	2	210 - 230	30 - 40	30 - 40
Filet of beef	3	230	20 - 30	20 - 30
Back of pork	2	210 - 230	30 - 40	30 - 40
Back of veal	2	210 - 230	30 - 40	30 - 40
Back of lamb	3	210 - 230	25 - 35	20 - 25
Whole Fish, 500-1000g	3/4	210 - 230	15 - 30	15 - 30

Fast Grilling

Food to be grilled	Shelf position	Time in min.	
		1st side	2nd side
Burgers	4	8 - 10	6 - 8
Pork fillet	4	10 - 12	6 - 10
Sausages	4	10 - 12	6 - 8
Fillet steaks, veal steaks	4	7 - 10	6 - 8
Toast ¹⁾	5	1 - 3	1 - 3
Toast with topping	4	6 - 8	-

1) Pre-heat the oven

Pizza Setting

Type of baking	Shelf position	Temperature °C	Time Min.
Pizza (thin crust)	2	200 - 230 ¹⁾²⁾	15 - 20
Pizza (with a lot of topping)	2	180 - 200	20 - 30
Tarts	1	180 - 200	40 - 55
Spinach flan	1	160 - 180	45 - 60
Quiche Lorraine	1	170 - 190	45 - 55
Swiss Flan	1	170 - 190	45 - 55
Apple cake, covered	1	150 - 170	50 - 60
Vegetable pie	1	160 - 180	50 - 60
Unleavened bread	2	230 - 250 ¹⁾	10 - 20
Puff pastry flan	2	160 - 180 ¹⁾	45 - 55
Flammekuchen (Pizza-like dish from Alsace)	2	230 - 250 ¹⁾	12 - 20

Type of baking	Shelf position	Temperature °C	Time Min.
Piroggen (Russian version of calzone)	2	180 - 200 ¹⁾	15 - 25

1) Pre-heat the oven

2) Use deep pan

Defrosting

Remove the food packaging. Put the food on a plate.

Do not cover it with a bowl or a plate. This can extend the defrost time.

Use the first oven shelf position. The one on the bottom.

Dish	Defrosting time in min.	Further defrosting time in min.	Comment
Chicken, 1000 g	100 - 140	20 - 30	Place the chicken on an up-turned saucer placed on a large plate Turn halfway through
Meat, 1000 g	100 - 140	20 - 30	Turn halfway through
Meat, 500 g	90 - 120	20 - 30	Turn halfway through
Trout, 150 g	25 - 35	10 - 15	-
Strawberries, 300 g	30 - 40	10 - 20	-
Butter, 250 g	30 - 40	10 - 15	-
Cream, 2 x 200 g	80 - 100	10 - 15	Cream can also be whipped when still slightly frozen in places
Gateau, 1400 g	60	60	-

Preserving

Things to note:

- Use only preserve jars of the same dimensions available on the market.
- Do not use jars with twist-off and bayonet type lids, or metal tins.
- Use the first shelf from the bottom for this function.
- Put no more than six one-litre preserve jars on the baking tray.
- Fill the jars up to the same level and close with a clamp.
- The jars cannot touch each other.
- Put approximately 1/2 litre of water into the baking tray to give sufficient moisture in the oven.
- When the liquid in the jars starts to simmer (after approx. 35-60 minutes with one-litre jars), stop the oven or decrease the temperature to 100°C (see the table).

Soft fruit

Preserve	Temperature in °C	Cooking time until simmering in min.	Continue to cook at 100°C in min.
Strawberries, blueberries, raspberries, ripe gooseberries	160 - 170	35 - 45	-

Stone fruit

Preserve	Temperature in °C	Cooking time until simmering in min.	Continue to cook at 100°C in min.
Pears, guinces, plums	160 - 170	35 - 45	10 - 15

Vegetables

Preserve	Temperature in °C	Cooking time until simmering in min.	Continue to cook at 100°C in min.
Carrots ¹⁾	160 - 170	50 - 60	5 - 10
Cucumbers	160 - 170	50 - 60	-
Mixed pickles	160 - 170	50 - 60	5 - 10
Kohlrabi, peas, asparagus	160 - 170	50 - 60	15 - 20

1) Leave standing in oven when switched off

Drying – True Fan Cooking

Cover the oven shelves with baking parchment.

For best results: deactivate the appliance after half the time required. Open the appliance door and let the appliance cool down. After that finish the drying process.

Vegetables

Food to be dried	Shelf position		Temperature in °C	Time in hours (Guideline)
	1 level	2 levels		
Beans	3	1/4	60 - 70	6 - 8
Peppers	3	1/4	60 - 70	5 - 6
Vegetables for sour	3	1/4	60 - 70	5 - 6
Mushrooms	3	1/4	50 - 60	6 - 8
Herbs	3	1/4	40 - 50	2 - 3

Fruit

Food to be dried	Shelf position		Temperature in °C	Time in hours (Guideline)
	1 level	2 levels		
Plums	3	1/4	60 - 70	8 - 10
Apricots	3	1/4	60 - 70	8 - 10
Apple slices	3	1/4	60 - 70	6 - 8

Food to be dried	Shelf position		Temperature in °C	Time in hours (Guideline)
	1 level	2 levels		
Pears	3	1/4	60 - 70	6 - 9

Information on acrylamides

Important! According to the newest scientific knowledge, if you brown food (specially the one which contains starch), acrylamides can pose a health risk. Thus, we recommend that you cook at the lowest temperatures and do not brown food too much.

CARE AND CLEANING



WARNING!

Refer to "Safety information" chapter.

Notes on cleaning:

- Clean the front of the appliance with a soft cloth with warm water and cleaning agent.
- To clean metal surfaces use a usual cleaning agent.
- Clean the appliance interior after each use. Then you can remove dirt more easily and it does not burn on.
- Clean stubborn dirt with a special oven cleaner.
- Clean all accessories (with a soft cloth with warm water and cleaning agent) after each use and let them dry.
- If you have nonstick accessories, do not clean them using an aggressive agents, sharp edged objects or dishwasher. It can cause a damage to the nonstick coating.

Pyrolytic cleaning



Remove all parts from the oven.



Do not start the pyrolytic cleaning if:

- If you do not remove the shelf support or telescopic shelf runners (if supplied) - the display shows 'C1' on some models.
 - if you do not close the oven door correctly- the display shows 'C3' on some models.
1. Remove the worst of the residual dirt manually.
 2. Set the Pyrolytic cleaning function (refer to section "Oven functions").
 3. When |→| flashes, press + or - to set the necessary procedure:
 - P1 1:30 for a low degree of dirt,
 - P2 2:30 for a usual degree of dirt,
 After 2 seconds procedure starts.

i To change length of selected procedure (P1 or P2), press to set , then press **+** or **-** to set length for the pyrolytic procedure.
You can use the End function to delay start of the cleaning process.
When the oven reaches pre-set temperature, the door locks. The symbol and the bars of the heat indicator come up, until the door unlocks again.

i During pyrolytic cleaning the lamp is off.

Cleaning reminder

To remind you that the pyrolytic cleaning is necessary the cleaning reminder symbol flashes in the display PYR after every activating and deactivating the appliance for the next 10 seconds.

i The cleaning reminder goes off the display:

- after end of the pyrolytic cleaning function;
- if you use **+** or **-** , when is flashing;

Shelf support

You can remove the shelf support to clean the side walls.

Removing the shelf support

1. Pull the front of the shelf support away from the side wall.

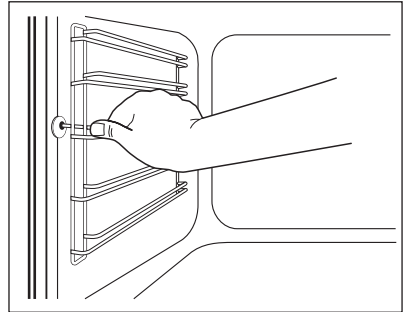

2. Pull the shelf support from the back of the side wall to remove it.

i To install the shelf support follow the procedure in reverse.

! Valid with telescopic runners:
The retaining pins on the telescopic shelf runners must point to the front!

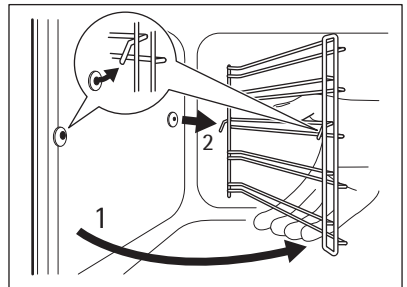

Oven lamp

! **WARNING!**
There is a risk of electrical shock.
The oven lamp and the lamp glass cover can be hot.

Before you change the oven lamp:

- Deactivate the appliance.
- Remove the fuses from the fuse box or deactivate the circuit breaker.



CAUTION!

Put a cloth on the bottom of the interior of the appliance. It prevents damage to the lamp glass cover and the cavity.

Replacing the oven lamp:

1. You can find the lamp glass cover at the cavity ceiling.
Turn the lamp glass cover counterclockwise to remove it.
2. Clean the glass cover.
3. If necessary, replace the oven lamp with applicable 300°C heat-resistant oven lamp.



Use the same oven lamp type.

4. Install the glass cover.

Door and glass panels

To clean the door, remove it.



CAUTION!

Be careful when you remove the door from the appliance. The door is heavy!

Removing the door

1. Open the door as far as it goes.
2. Fully press clamping levers (A) on the two door hinges.
3. Close the door until the first position (angle approximately 70°).
4. Hold of the door with one hand on each side and pull it away from the at an up angle.

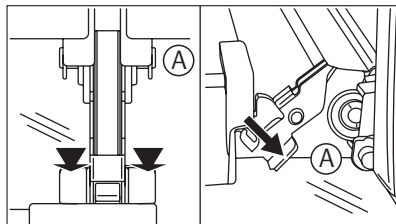

To install the door follow the procedure in reverse.



The number of glass panels if different for the different models.



CAUTION!

Put the door with the outer side down on a soft and level surface to prevent scratches.

Removing and cleaning the door glass panels

1. Remove the door.

2. Hold the door trim (B) on the top edge of the door at the two sides and push inwards to release the clip seal.
3. Pull the door trim to the front to remove it.

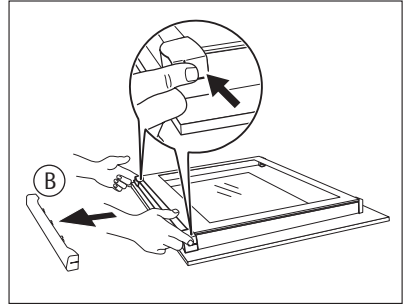

4. Hold the door glass panels on their top edge one by one and pull them up out of the guide
5. Clean the door glass panels.

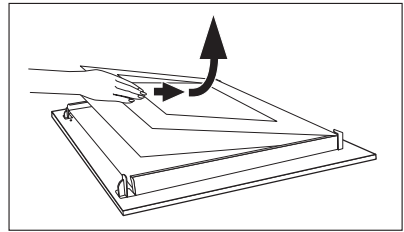

To install panels follow the procedure in reverse. Install the smaller panel first, then the larger.

WHAT TO DO IF...



WARNING!

Refer to "Safety information" chapter.

Problem	Possible cause	Solution
The oven does not heat up	The appliance is switched off	Switch on the appliance
The oven does not heat up	The clock is not set	Set the clock. Refer to "Setting the clock"
The oven does not heat up	The necessary settings are not set	Make sure, the settings are correct
The oven does not heat up	The automatic cut-out is switched on	Refer to „Automatic cut-out“
The oven does not heat up	The fuse is released	Make sure, if the fuse is the cause for the malfunction. If the fuse releases again and again, refer to an authorized electrician
The oven lamp does not operate	The oven lamp is defective	Replace the oven lamp.
The pyrolytic cleaning does not operate (the clock display shows „C1“)	The shelf support/telescopic runners are not removed	Remove support/telescopic runners

Problem	Possible cause	Solution
The pyrolytic cleaning does not operate (the time display shows „C3“)	The door is not correctly closed or door lock is defective	Close the door correctly
The display shows F102	<ul style="list-style-type: none"> • The door is not closed correctly • The door lock is defect 	<ul style="list-style-type: none"> • Close the door correctly • Switch off the appliance with the house fuse or the safety switch in the fuse box and switch it on again • If the display shows F102 again, refer to the Customer Care Department
The display shows an error code that is not in this list	There is an electronic fault	<ul style="list-style-type: none"> • Switch off the appliance with the house fuse or the safety switch in the fuse box and switch it on again • If the display shows the error code again, refer to the Customer Care Department

If you cannot find a solution to the problem yourself, contact your dealer or the service centre.

The necessary data for the service centre is on the rating plate. The rating plate is on the front frame of the appliance cavity.

We recommend that you write the data here:

Model (MOD.)

Product number (PNC)

Serial number (S.N.)

INSTALLATION



WARNING!

Refer to "Safety information" chapter.



The built-in unit must meet the stability requirements of DIN 68930.

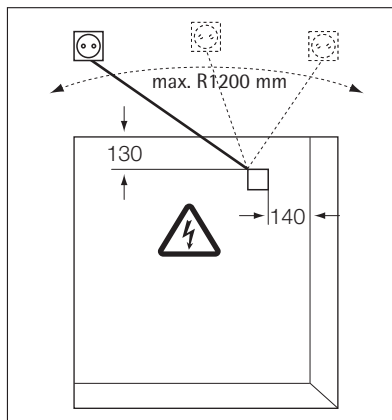
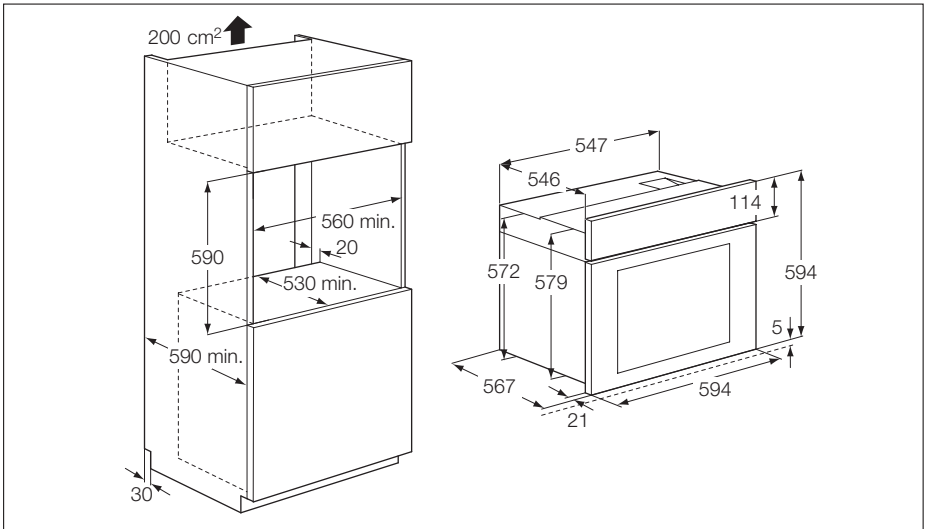
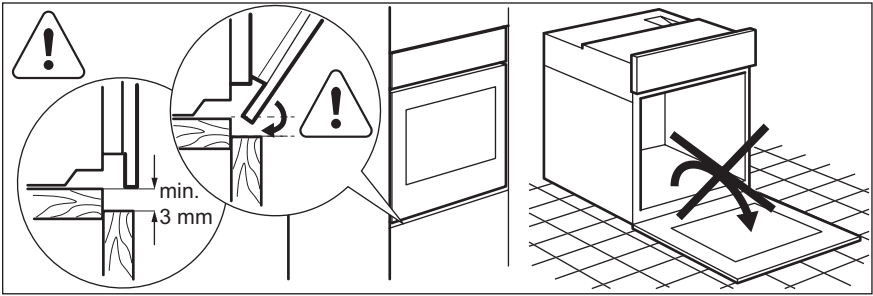

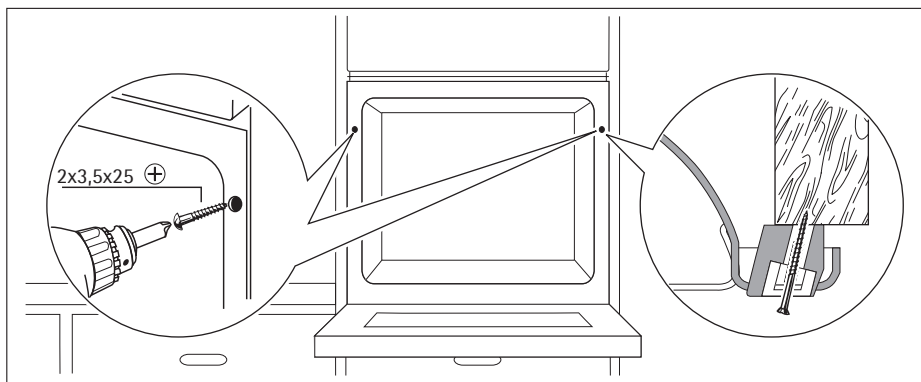
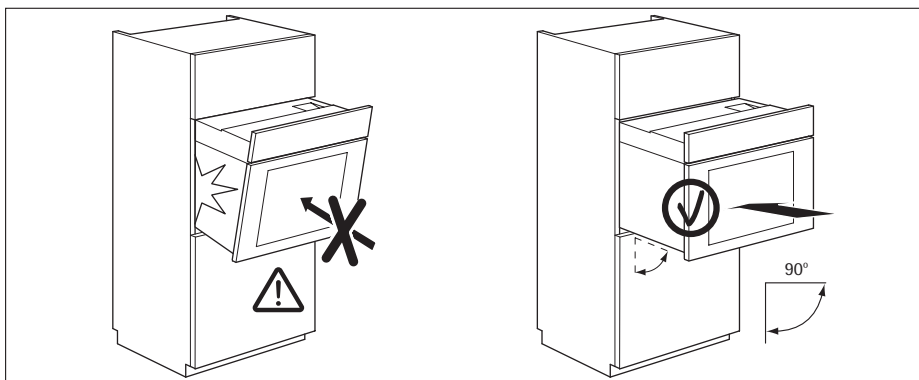
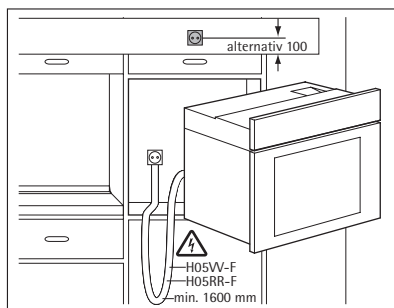

ENVIRONMENT CONCERNS

The symbol  on the product or on its packaging indicates that this product may not be treated as household waste. Instead it should be taken to the appropriate collection point for the recycling of electrical and electronic equipment. By ensuring this product is disposed of correctly, you will help prevent potential negative consequences for the environment and human health, which could otherwise be caused by inappropriate waste handling of this product. For more detailed information about recycling of this product,

please contact your local council, your household waste disposal service or the shop where you purchased the product.



Packaging material

The packaging material is environmentally-friendly and recyclable. Plastic parts are marked with international abbreviations such as PE, PS, etc. Dispose of the packaging material in the containers provided for this purpose at your local waste management facility.

GB IE GREAT BRITAIN & IRELAND - GUARANTEE/CUSTOMER SERVICE

Standard guarantee conditions: We, Electrolux, undertake that if within 12 months of the date of the purchase this Electrolux appliance or any part thereof is proved to be defective by reason only of faulty workmanship or materials, we will, at our option repair or replace the same FREE OF CHARGE for labour, materials or carriage on condition that:

- Appliance has been correctly installed and used only on the electricity supply stated on the rating plate.
- Appliance has been used for normal domestic purposes only, in accordance with manufacturer's instructions.
- Appliance hasn't been serviced, maintained, repaired, taken apart or tampered with by person not authorised by us.
- Electrolux Service Force Centre must undertake all service work under this guarantee
- Any appliance or defective part replaced shall become the Company's property.
- This guarantee is in addition to your statutory and other legal rights.

Exclusions

- Damage, calls resulting from transport, improper use, neglect, light bulbs, removable parts of glass, plastic.
- Costs for calls to put right appliance which is improperly installed, calls to appliances outside United Kingdom.
- Appliances found to be in use within a commercial environment, plus those which are subject to rental agreements.
- Products of Electrolux manufacturer that are not marketed by Electrolux

Service and Spare Parts. Please contact your local Service Force Centre: **08445 616 616** (Call will be routed to Service Force Centre covering your postcode area). For address of local Service Force Centre and further information, please visit: www.serviceforce.co.uk Before calling out an engineer, please ensure you have read the details under the heading "What to do if...". When you contact the Service Force Centre you will need to give the following details: Your name, address and postcode, your telephone number, clear concise details of the fault, model and serial number of the appliance (found on the rating plate), the purchase date. Please note a valid purchase receipt or guarantee documentation is required for in guarantee service calls.

Customer Care. Please contact our Customer Care Department: Electrolux Major Appliances, Addington Way, Luton, Bedfordshire, LU4 9QQ or visit our website at www.electrolux.co.uk

Customer Care Department,	Tel: (Calls may be recorded for training purposes)
Electrolux	08445 613 613
AEG-Electrolux	08445 611 611
Zanussi-Electrolux	08445 612 612

For Customer Service in The Republic of Ireland please contact us at the address below:

Electrolux Group (Irl) Ltd, Long Mile Road, Dublin 12, Republic of Ireland



Tel: +353 (0)1 4090751, Email: service.eid@electrolux.ie



GB **European Guarantee:** This appliance is guaranteed by Electrolux in each of the countries listed at the back of this user manual, for the period specified in the appliance guarantee or otherwise by law. If you move from one of these countries to another of the countries listed, the appliance guarantee will move with you subject to the following qualifications:-

- The appliance guarantee starts from the date you first purchased the appliance which will be evidenced by production of a valid purchase document issued by the seller of the appliance.
- The appliance guarantee is for the same period and to the same extent for labour and parts as exists in your new country of residence for this particular model or range of appliances.
- The appliance guarantee is personal to the original purchaser of the appliance and cannot be transferred to another user.
- The appliance is installed and used in accordance with instructions issued by Electrolux and is only used within the home, i.e. is not used for commercial purposes.
- The appliance is installed in accordance with all relevant regulations in force within your new country of residence.

The provisions of this European Guarantee do not affect any of the rights granted to you by law.

WWW.ELECTROLUX.COM

		
Albania	+35 5 4 261 450	Rr. Pjeter Bogdani Nr. 7 Tirane
Belgique/België/Belgien	+32-2-7162444	Raketstraat 40, 1130 Brussel/Bruxelles
Česká republika	+420 261 302 261	Budějovická 3, Praha 4, 140 21
Danmark	+45 70 11 74 00	Strevelinsvej 38-40, 7000 Fredericia
Deutschland	+49 180 32 26 622	Fürther Str. 246, 90429 Nürnberg
Eesti	+37 2 66 50 030	Pärnu mnt. 153, 11624 Tallinn
España	+34 902 11 63 88	Carretera M-300, Km. 29,900 Alcalá de Henares Madrid

		
France	08 44 62 26 53	www.electrolux.fr
Great Britain	+44 8445 616 616	Addington Way, Luton, Bedfordshire LU4 90Q
Hellas	+30 23 10 56 19 70	4, Limnou Str., 54627 Thessaloniki
Hrvatska	+385 1 63 23 338	Slavonska avenija 3, 10000 Zagreb
Ireland	+353 1 40 90 753	Long Mile Road Dublin 12
Italia	+39 (0) 434 558500	C.so Lino Zanussi, 26 - 33080 Porcia (PN)
Latvija	+371 67313626	Kr. Barona iela 130/2, LV-1012, Riga
Lietuva	+370 5 278 06 03	Ozo 10a, LT-08200 Vilnius
Luxembourg	+352 42 431 301	Rue de Bitbourg, 7, L-1273 Hamm
Magyarország	+36 1 252 1773	H-1142 Budapest XIV, Erzsébet királyné útja 87
Nederland	+31 17 24 68 300	Vennootsweg 1, 2404 CG - Alphen aan den Rijn
Norge	+47 81 5 30 222	Risløkkvn. 2 , 0508 Oslo
Österreich	+43 18 66 400	Herziggasse 9, 1230 Wien
Polska	+48 22 43 47 300	ul. Kolejowa 5/7, Warszawa
Portugal	+35 12 14 40 39 39	Quinta da Fonte - Edificio Gonçalves Zarco - Q.35 -2774-518 Paço de Arcos
Romania	+40 21 451 20 30	Str. Garii Progresului 2, S4, 040671 RO
Schweiz - Suisse - Svizzera	+41 62 88 99 111	Industriestrasse 10, CH-5506 Mägenwil
Slovenija	+38 61 24 25 731	Gerbičeva ulica 110, 1000 Ljubljana
Slovensko	+421 2 32 14 13 34-5	Electrolux Slovakia s.r.o., Electrolux Domáce spotrebiče SK, Galvaniho 17/B, 821 04 Bratislava
Suomi	www.electrolux.fi	
Sverige	+46 (0)771 76 76 76	Electrolux Service, S:t Göransgatan 143, S-105 45 Stockholm
Türkiye	+90 21 22 93 10 25	Tarlabası caddesi no : 35 Taksim İstanbul
Россия	8-800-200-3589	129090 Москва, Олимпийский проспект, 16, БЦ "Олимпик"
Україна	+380 44 586 20 60	04074 Київ, вул.Автозаводська, 2а, БЦ "Алкон"



Free Manuals Download Website

<http://myh66.com>

<http://usermanuals.us>

<http://www.somanuals.com>

<http://www.4manuals.cc>

<http://www.manual-lib.com>

<http://www.404manual.com>

<http://www.luxmanual.com>

<http://aubethermostatmanual.com>

Golf course search by state

<http://golfingnear.com>

Email search by domain

<http://emailbydomain.com>

Auto manuals search

<http://auto.somanuals.com>

TV manuals search

<http://tv.somanuals.com>