

ADCOM

OWNER'S MANUAL

GTP-860



Digital Processing Tuner/Preamplifier

WELCOME

Dear fellow ADCOM product owner,

Welcome to the ADCOM family! For more than twenty years, ADCOM products have delivered excellent performance and value for customers around the world. Our products are designed by our experienced and demanding engineering team, built to the highest standards in our factory, and sold and serviced through dealers, custom installers, and other retailers whose primary goal is your complete satisfaction.

We know you are anxious to hear your new preamplifier in action, but please take a few minutes to read this owner's manual before connecting the preamplifier to your system. It is particularly important that you connect your preamplifier to your amplifier and speakers while the amplifier and preamplifier is unplugged and your other equipment is turned off. This will protect your equipment from potential short circuits that may occur during installation. In addition, it is important that you allow for adequate ventilation around your preamplifier and other equipment, since excessive heat buildup can shorten the life of any electronic product, including the preamplifier. Once you have correctly connected your amplifier and speakers to your new preamplifier, you should be able to enjoy many trouble-free years of performance.

We conduct a thorough quality and performance test on each and every preamplifier we build in our factory prior to shipment. In the rare case of a defect that may occur after shipment, we stand behind our preamplifiers with a five-year parts and labor warranty. To register for this warranty, please complete and mail the enclosed warranty card back to ADCOM. Also, please keep a copy of your sales receipt with the owner's manual so you may provide proof of eligibility for the warranty should the need arise.

We know you will be very happy with the sound and performance of your new preamplifier. We hope you will also consider other ADCOM products, such as our line of preamplifiers and DVD and CD players. In addition, we design and manufacture complementary products such as line conditioners/surge suppressors and speaker selectors. Please visit our web site, www.adcom.com, to learn more about our complete line of stereo, home theater, and distributed audio/video products.

On behalf of all of us at ADCOM, I want to thank you for selecting our product for your home or business entertainment system.

Sincerely,



Douglas Klein
President
ADCOM

TABLE OF CONTENTS

WELCOME	2
SAFETY INFORMATION	4
INTRODUCTION & UNPACKING	5
WARRANTY INFORMATION	5
DESCRIPTION OF UNIT	
FRONT PANEL DRAWING	6
1.1 INTERFACE OVERVIEW	7-10
REAR PANEL DRAWING	11
1.2 INPUTS & OUTPUTS SYSTEM CONNECTIONS	12-15
REMOTE CONTROL DRAWING	16
2.1 OVERVIEW OF THE GRC-800	17-19
2.2 REMOTE FUNCTION TABLE	20-21
2.3 PROGRAMMING YOUR REMOTE CONTROL	22-23
2.4 PROGRAMMING MACRO BUTTONS	24
2.5 DISCRETE CUSTOM CODES FOR INSTALLERS	25
PLACEMENT OF THE GTP-860	25
OPERATION & SETUP	
3.1 ONSCREEN DISPLAY	26
3.2 CHANNEL BALANCE	26
3.3 CHANNEL DELAYS	27-28
3.4 SPEAKER SETTINGS	28-29
3.5 SURROUND SPEAKER PLACEMENT	30
3.6 INPUT SETTINGS	31
TROUBLESHOOTING	
RESOLVING PROBLEMS	32
TROUBLE SHOOTING	33
CARING FOR YOUR GTP-860	34
SERVICE INFORMATION	34
GTP-860 SPECIFICATIONS	35

THE FOLLOWING PRECAUTIONS AND SAFETY INSTRUCTIONS ARE REQUIREMENTS OF UL AND CSA SAFETY REGULATIONS

Warning: To reduce the risk of fire or electric shock, do not expose this unit to rain or moisture.

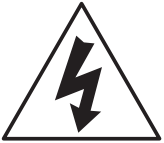
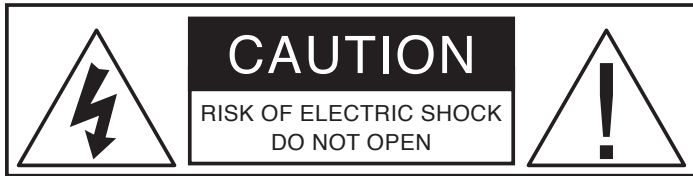

The graphic symbol of a lightning flash with an arrow point within a triangle signifies that there is dangerous voltage within the unit and it poses a hazard to anyone removing the cover to gain access to the interior of the unit. Only qualified service personnel should make any such attempt.



The graphic symbol of an exclamation point within an equilateral triangle warns a user of the device that it is necessary to refer to the instruction manual and its warnings for proper operation of the unit.

Do not place this unit on an unstable cart, stand, tripod, bracket, or table. The unit may fall, causing serious injury to a child or adult, and serious damage to the unit. Use only with a cart, stand, tripod, bracket, or table recommended by the manufacturer or sold with the unit. Any mounting of the device should follow the manufacturer's instructions, and should use a mounting accessory recommended by the manufacturer.

Read all the safety and operating instructions before connecting or using this unit.

Retain this notice and the owner's manual for future reference.

All warnings on the unit and in its operating instructions should be adhered to.

All operating and use instructions should be followed.

Do not use this unit near water. For example, near a bathtub, washbowl, kitchen sink, laundry tub, in a wet basement, or near a swimming pool.

The unit should be installed so that its location or position does not interfere with its proper ventilation. For example, it should not be situated on a bed, sofa, rug, or similar surface that may block the ventilation openings; or placed in a built-in installation, such as bookcase or cabinet, that may impede the flow of air through its ventilation openings.

The unit should be situated away from heat sources such as radiators, heat registers, stoves, or other devices (including amplifiers) that produce heat.

The unit should be connected to a power supply outlet only of the voltage and frequency marked on its rear panel.

The power supply cord should be routed so that it is not likely to be walked on or pinched, especially near the plug, convenience receptacles, or where the cord exits from the unit.

Clean unit only as recommended in its instruction manual.

The power supply cord of the unit should be unplugged from the wall outlet when it is to be unused for a long period of time.

Care should be taken so that objects do not fall, and liquids are not spilled, into the enclosure through any openings.

This unit should be serviced by qualified service personnel when:

- A. The power cord or the plug has been damaged; or
- B. Objects have fallen, or liquid has been spilled, into the unit; or
- C. The unit has been exposed to rain, or liquids of any kind; or
- D. The unit does not appear to operate normally, or exhibits a marked change in performance; or
- E. The device has been dropped, or the enclosure damaged.

**DO NOT ATTEMPT SERVICING OF THIS UNIT YOURSELF.
REFER SERVICING TO QUALIFIED SERVICE PERSONNEL.**

Download from www.Sonmanuals.com. All Manuals Search And Download.

ATTENTION

POUR PREVENIR LES CHOCS ELECTRIQUES NE PAS UTILISER CETTE FICHE POLARISEE AVEC UN PROLONGATEUR, UNE PRISE CE COURANT OU UNE AUTRE SORTIE CE COURANT, SAUF SI LES LAMES PEUVENT ETRE INSEREES A FOND SANS EN LAISSER AUCUNE PARTIE A DECOUVERT.

CAUTION

TO PREVENT ELECTRIC SHOCK DO NOT USE THIS POLARIZED PLUG WITH AN EXTENSION CORD, RECEPTACLE OR OTHER OUTLET UNLESS THE BLADES CAN BE FULLY INSERTED TO PREVENT BLADE EXPOSURE.

CAUTION POWER LINES

Any outdoor antenna must be located away from all power lines.

OUTDOOR ANTENNA GROUNDING

If an outside antenna is connected to your tuner or tuner/preamplifier, be sure the antenna system is grounded so as to provide some protection against voltage surges and built-up static charges. Section 810 of the National Electrical Code, ANSI/NFPA No. 701984, provides information with respect to proper grounding of the mast and supporting structure, grounding of the lead-in wire to an antenna discharge unit, size of grounding conductors, location of antenna discharge unit, connection to grounding electrodes, and requirements for the grounding electrode.

- a. Use No.10 AWG (5.3 mm²) copper, No.8 AWG (8.4 mm²) aluminum, No.17 AWG (1.0 mm²) copper clad steel or bronze wire, or larger, as a ground wire.
- b. Secure antenna lead-in and ground wires to house with stand-off insulators spaced from 46 feet (1.221.83 m) apart.
- c. Mount antenna discharge unit as close as possible to where lead-in enters house.
- d. Use jumper wire not smaller than No.6 AWG (13.3 mm²) copper, or the equivalent, when a separate antenna grounding electrode is used. See NEC Section 810-21 (j).

EXAMPLE OF ANTENNA GROUNDING AS PER NATIONAL ELECTRICAL CODE INSTRUCTIONS CONTAINED IN ARTICLE 810. RADIO AND TELEVISION EQUIPMENT.

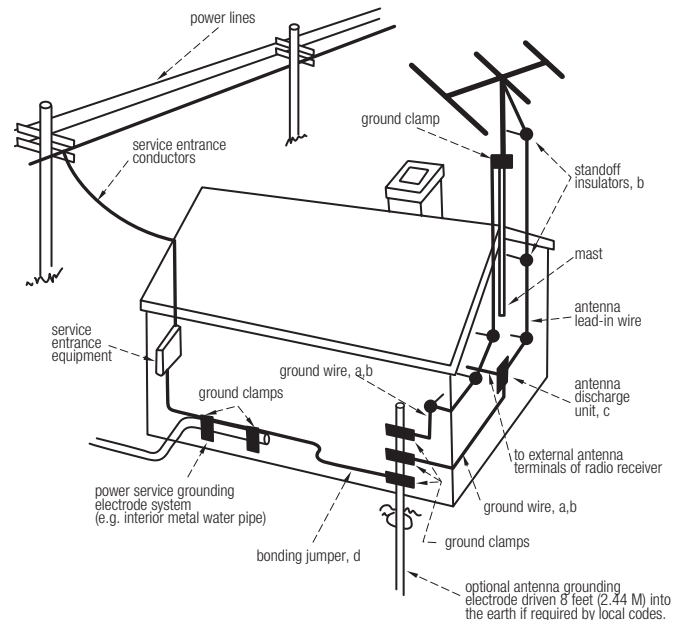

NOTE TO CATV SYSTEM INSTALLER

This reminder is provided to call the CATV system installer's attention to Article 82022 of the National Electrical Code that provides guidelines for proper grounding and, in particular, specifies that the cable ground shall be connected to the grounding system of the building, as close to the point of cable entry as practical.

INTRODUCTION

Congratulations on your decision to purchase the ADCOM GTP-860 tuner-preamplifier. The GTP-860 provides Dolby Digital and DTS decoding with 7.1 output channels, as well as a 5.1 analog bypass and the RDS radio data system. These features and ADCOM's legendary quality provide the heart of your cutting-edge home theater. You have made a wise choice that will reward you for years to come with exceptionally accurate and musical sound reproduction. To realize the full potential of your new preamplifier, and before making any connections to it, please read these operating and installation instructions thoroughly.

UNPACKING THE GTP-860

Before your new ADCOM tuner-preamplifier left our factory, it was carefully inspected for physical imperfections and tested for all electrical parameters as a routine part of ADCOM's systematic quality control. This, along with full operational and mechanical testing, should ensure a product flawless in both appearance and performance. After you have unpacked the GTP-860, inspect it for physical damage. Save the shipping carton and all packing material as they are intended to reduce the possibility of transportation damage should the preamplifier ever need to be shipped again. In the unlikely event damage has occurred, notify your dealer immediately and request the name of the carrier so a written claim to cover shipping damages can be initiated. **THE RIGHT TO A CLAIM AGAINST A PUBLIC CARRIER CAN BE FORFEITED IF THE CARRIER IS NOT NOTIFIED PROMPTLY IN WRITING AND IF THE SHIPPING CARTON AND PACKING MATERIALS ARE NOT AVAILABLE FOR INSPECTION BY THE CARRIER. SAVE ALL PACKING MATERIALS UNTIL THE CLAIM HAS BEEN SETTLED.**



GTP-860 Tuner/Preamp



GRC-800 Remote Control with Batteries



GTP-860 Owners Manual and Warranty



ADCOM Power Cord



Video 5 input cover



FM Antenna/Balun Adapter

ADCOM PROTECTION PLAN (USA Only)

ADCOM offers the enclosed valuable Limited Warranty. Please read the details on the Warranty Card carefully to understand the extent of the protection offered by the Warranty, its reasonable limitations, and what you should do in order to obtain its benefits. Be sure to verify that the serial number printed on the rear panel matches the serial number on the outer carton. If any number is altered or missing, or if the ADCOM Warranty Card is not included in the carton, you should notify us immediately in order to ensure that you have received a genuine ADCOM product which has not been opened, mishandled, or tampered with in any way. **Always retain your original sales receipt as a proof of purchase.**

This unit is manufactured under license from Dolby Laboratories Licensing Corporation. It is additionally licensed under one or more of the following patents: U.S. number 3,959,950, Canadian numbers 1,004,603 and 1,037,877. Dolby® Pro Logic®, and Dolby Digital® are registered trademarks of Dolby Laboratories Licensing Corporation.

Manufactured under license from Digital Theater Systems, Inc. US Patent Number 5,451,942 and other worldwide patents issued and pending. "DTS," "dts," "DTS Digital Surround," are trademarks of Digital Theater Systems, Inc. Copyright 1996 Digital Theater Systems, Inc. All Rights Reserve

DESCRIPTION OF UNIT FRONT PANEL

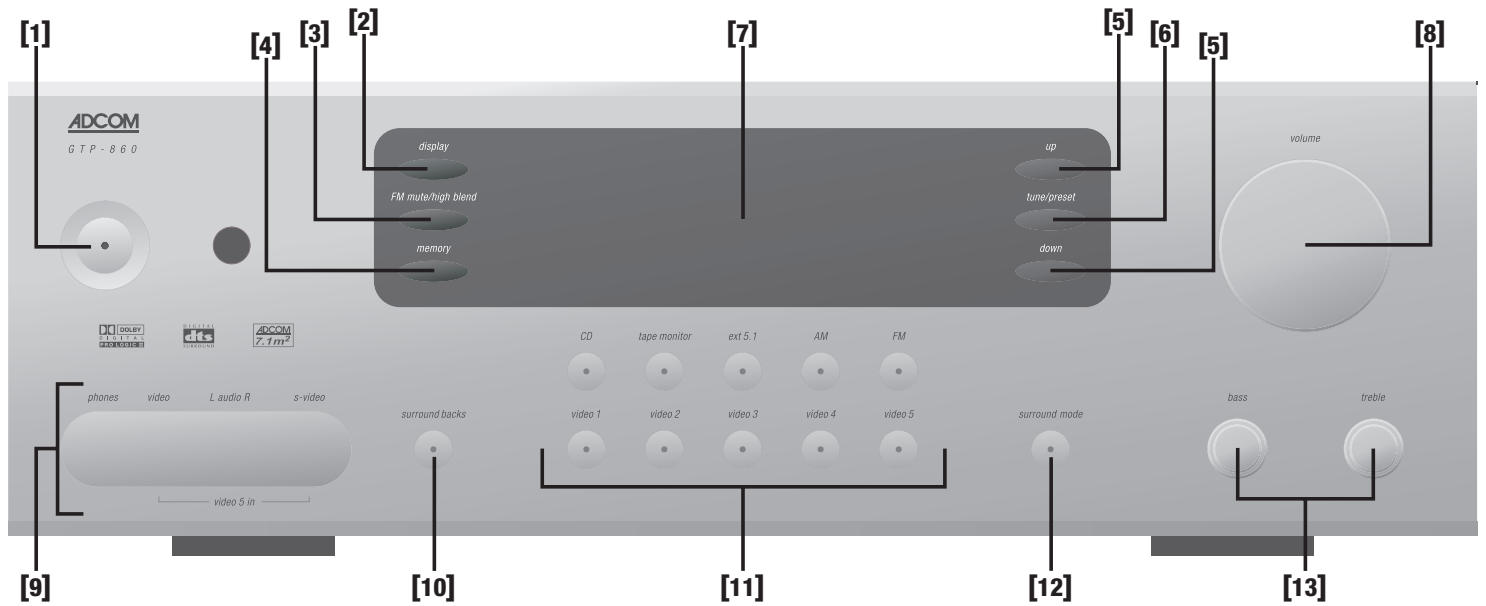

[1] Power Button

[2] Display Button

[3] FM Mute/High Blend Button

[4] Memory Button

[5] Tuner Up/Down Buttons

[6] Tune/Preset Button

[7] Display Window

[8] Volume Knob

[9] Headphone Output
& Video 5 Input

[10] Surround Backs Button

[11] Input Selector Buttons

[12] Surround Mode Button

[13] Bass/Treble Controls

1.1 Interface Overview

The GTP-860's front panel is designed for ease of operation. All controls are logically grouped for easy, intuitive operation. Familiarize yourself with the preceding diagram and read the short explanations of each feature below. When you finish, you will be well on your way to enjoying the GTP-860's convenience and sound quality.

[1] Power Button

Depress the Power button to switch the preamplifier to its 'Stand-By' mode. The amber LED in the power button will light up. On the front panel, press any of the input selector buttons [11] to switch the preamplifier on. From the remote control, press the power button [30] to switch the unit on (see remote diagram, page 20). The display will light up indicating which input was selected and the power button LED will turn red.

Pressing the Power switch again will turn the unit OFF completely. The GTP-860 preamplifier uses a memory back-up system to store surround sound trim settings and preset station information for the tuner section. This information is retained for several weeks, even if the unit is switched off completely or unplugged.

Press the Remote Control Power button [30] to switch the unit from Operating to Stand-By mode. Press this button again to switch to Unit On from Stand-By; the last selected source will be indicated in the display.

The Power Button LED will light up amber when the preamplifier is switched On, but in Stand-By mode.

NOTE: In Stand-By mode the GTP-860 uses very little power. However, it is recommended that you switch the unit completely off if it is not going to be used for more than a couple of days. Switch off completely by pressing the Power button on the front panel. All lights will extinguish. When the GTP-860 is plugged into the wall current may still be flowing into the transformer. Only when the GTP-860 is unplugged is all current into the device stopped.

[2] Display Button

The GTP-860 supports RDS PS and RDS RT. With stations carrying RDS information, "RDS" will light up in the

display panel, and the station's RDS name is automatically displayed (RDS PS).

Some radio stations, which support RDS, also transmit additional information, known as Radio Text (RDS RT). To view this information, use the Display button.

With stations carrying RDS information, the Display button scrolls between three different display modes, each successive push of the button engages the next one of the three modes:

- a) In the default mode, the station's RDS name is displayed, Program Service (PS; normally the station's calling letters, WXYZ, for instance).
- b) From the default mode, press the button once to view Radio Text (RT). This can be additional information such as the presenter's or program's name; what song is playing, etc. This text scrolls continuously over the 8 alphanumeric display segments. It takes a few seconds for the tuner to gather the RT information, so immediately after tuning to a station and selecting to view RT the display will indicate "NO TEXT" and default to the station name. If no RT information is available, the display will also show "NO TEXT" for three seconds before reverting to the default mode.
- c) Press the Display button from the RT mode to display the station frequency. Press again to return to the default mode (a).

When the Display button is pressed when tuned to a non-RDS station, the display will show "NO NAME" for three seconds before reverting to the default display.

The Display button also has a secondary function: When pressed and held for three seconds, the front panel display will dim. Press and hold the button again to turn the display off, and again to set the display back to its original brightness.

[3] FM Mute/High Blend Button

This button combines two functions; it switches the tuner from Stereo to Mono and disengages the muting circuitry at the same time. The muting circuit will mute the tuner in between radio stations when searching or tuning to avoid tuning noise.

However, very weak radio station signals may be suppressed by the muting circuit. If such a very weak station is in stereo it will have a high level of background hiss. Switching to Mono Mode and disengaging the muting circuit by depressing the FM Mute/High Blend button will allow the station to be heard and will cancel most or all of this background noise.

In normal operation the mute circuit is engaged, and the display indicates "FM MUTE." Press the FM Mute/High Blend button to disengage the muting circuit and switch from stereo to mono reception. "FM MUTE" will extinguish in the display. Also, "STEREO" will extinguish if a stereo broadcast was received. Press the FM Mute/High Blend switch again to return to Auto Stereo FM operation. In combination with the Memory button [4] a preset number can be emptied.

[4] Memory Button

The Memory button is used to store stations into the Preset Memory (1-30 Presets on FM, 1-10 Presets on AM), used in conjunction with the Down/Up [5] buttons on the front panel. When Memory is active, the Preset number flashes and the red "MEMORY" indicator is shown in the Display Panel. If no other button is pressed within 10 seconds "MEMORY" will stop flashing and the preamplifier will default to its previous state.

To Store a Preset:

Tune to the radio station you wish to enter into a Preset. If the station is transmitting RDS information, the RDS indicator will light up and station initials will be shown in the Display Panel. If a non-RDS station is found, then just the frequency will be shown.

To store that station as a Preset, press Memory [4]. "MEMORY" and the preset section in the display panel will start to flash. If no other button is pressed within 10 seconds, "MEMORY" will stop flashing and the preamplifier will default to its previous state. Press the Down/Up [5] buttons to select which Preset number you wish to assign to the station (from 1 to 30 on FM and 1 to 10 on AM), shown as a flashing number in the Display Panel, and then press Memory [4] again. The Memory light in the Display Panel will go out and the station is now stored in your GTP-860's memory.

To exit the Memory mode without storing a station, leave all the tuner controls untouched; the Memory mode will automatically cancel itself after 10 seconds. The Memory Presets have a memory back-up, so they will remain stored for several weeks even if the Preamplifier is switched off or unplugged from the main supply.

NOTE: You can enter a new station into an unused Preset or overwrite an existing programmed Memory Preset. By doing this you will replace the radio station previously held on that Preset number.

Deleting a stored Preset:

You can empty a Preset by deleting the stored information:

- Press Memory button [4]
- Select the Preset to be emptied by pressing the Up/Down buttons [5].

Press FM Mute/High Blend button [3]. The Preset will then be deleted and '—' appears as the Preset number.

[5] Tuner Up/Down Buttons

The function of these buttons depends on the tuning mode selected with the Tune/Preset button [6]. The Tune/Preset button toggles between the two operation modes:

a) Preset mode (indicated in the display area): Press the Down button to scroll to a lower number Preset; press the "Up" button to scroll to a higher Preset number. This is a "wrap-around" function, so that going from the highest number Preset, the tuner will go to the lowest Preset number or vice-versa when tuning either up or down.

b) Tune mode: Press the "Up" or "Down" button for more than 1/2 second to engage automatic tuning respectively up or down the frequency band. The tuner will search automatically for the first reasonably strong radio station, where it will stop. Press the Down/Up button again for 1/2 second to start searching again.

NOTE: Automatic tuning is available on both FM and AM.

By briefly tapping the Down or Up buttons you can engage manual tuning respectively down or up the frequency band for precise tuning to a specific frequency. With each successive tap of the keys, the tuner will take 0.05 MHz steps on FM so you can accurately tune into the desired frequency. For AM the tuning steps are factory set at 10 kHz.

This tuning mode can also be useful when trying to receive a radio station which is too weak for the auto

search mode. When tuned accurately to a station, "TUNED" will light up in the display.

[6] Tune/Preset Button

The Tune/Preset button toggles between the Preset and Tune mode. When Preset mode is selected, "PRESET" lights up in the display area. Refer to the Tuner Up/Down button [5] description for more information.

[7] Display Window

The display area shows all vital information when the unit is operational.

[8] Volume Knob

The Volume control adjusts the overall loudness of the signals being fed to the preamplifier outputs. Unlike conventional controls, the GTP-860's volume control doesn't have a start or end position. Volume can also be adjusted from the remote control using the Master Volume Up or Down buttons [34]. The Volume control does not affect recordings made using the Tape, Video 3 and Video 4 outputs but will affect the signal going to the Preamp Outputs. The volume level is indicated in the display panel when it is being adjusted, and after three seconds the display defaults to its previous status. Volume setting can range from -61dB to +18dB.

On the remote control, press the Mute button [32] to temporarily switch off the sound to the Preamp outputs and headphones. Mute mode is indicated by "MUTING" flashing in red in the display area. Press Mute again to restore sound. Mute does not affect recordings made using the Tape, Video 3 and Video 4 outputs but does affect the signal going to the Preamp Outputs.

[9] Headphone Output/Video 5 Input

A 1/4" stereo jack socket is provided for headphone listening and will work with conventional headphones of any impedance. The volume and tone controls are operative for headphone listening. Use a suitable adapter to connect headphones with other types of connectors such as 3.5mm stereo 'personal stereo' jack plugs. Inserting a headphone will automatically turn off the signals from the Preamp Outputs, and set the listening mode to Stereo.

NOTE: Head phones are only LF RF output. If listening to 5.1 material center channel should be turned off.

REMEMBER: Listening at high levels can damage your hearing. The video five input is located on the front panel to simplify connection of a camcorder or a video game console. To select video five, push the corresponding front panel button in the input selector section.

[10] Surround Backs Button

Pressing this button engages ADCOM's proprietary 7.1m²™ decoding algorithm. The 7.1m²™ decoding process mixes the signals from the left surround and right surround channels to derive two unique signals sent to each back output. The benefit of our 7.1m²™ decoding process is enhance imaging between the surround speakers and the creation of a more diffuse ambient sound field. The 7.1m²™ process has the same benefits when compared to other matrix decoding as stereo signals have over mono signals. The 7.1m²™ process can also be used to drive your surround back speakers when you are listening to an externally decoded DVD audio or SACD multi-channel disc. Due to the varying nature of film soundtracks and music, you may prefer to activate or deactivate the surround back channels. For example, Dolby Digital 5.1 and DTS soundtracks benefit greatly from the addition of the 7.1m²™ processing. Prologic soundtracks on the other hand provide a mono surround signal track, which yields a less satisfying experience when using the surround back channels.

The level of the Surround Back channels can be adjusted in the same manner as the other channels, either through the On-Screen-Display (OSD) or with the Bal. or Test functions from the remote control. Be sure to experiment to find the balance that best suits your taste.

[11] Input Selector Buttons

These buttons select the active video and audio input for the GTP-860. The source that is currently selected will be shown in the front panel display and the LED in the source button will be red. The currently selected source signal is sent to the main preamp outputs after processing and the video 3, video 4, aux and tape outputs. If an input has both digital and analog input capabilities the GTP-860 will give priority to an existing digital signal, and in the absence of a digital signal will default to the analog connection. Video signals associated with an input give priority to s-video sources over composite video signals. The video one and video two inputs also have component video switching capabilities. This component video

switching is independent of the composite/S video signal and does not support on-screen display messages.

ext 5.1: Selects the multi-channel output signal from a DVD player or external decoder source (such as DVD-Audio) connected to the ext 5.1 input as the active input.

NOTE: No ext 5.1 audio signal is available from the headphones socket, or the Tape, Video 3 or Video 4 outputs.

Tape Monitor: Selects the output from a tape recorder when playing back tapes or monitoring recordings being made through the Tape sockets. Press the Tape Monitor button once to select it and again to return to the normal input selection.

The Tape Monitor function does not override the current input selection that is sent to the tape outputs. When the Tape Monitor is selected, you are listening to the signal that is coming back into the Tape Input jacks. The currently selected source is still being sent to the Tape Out where it can be recorded. This function enables you to check on a recording that you are making without affecting the recording process. When Tape Monitor is selected, the button will remain lit until Tape Monitor is disengaged again.

[12] Surround Mode Button

With the Surround Mode button the available surround sound modes can be selected. The selected surround mode is permanently indicated in the display area and is also shown for 3 seconds in the large text section of the display. The Surround Mode button scrolls through the available surround sound modes when pressed repeatedly.

The surround modes are:

Stereo: The Stereo mode provides straight two channel listening. With an analog source, it bypasses all processing. With a digital input, only the bass-management filtering is applied.

Hall: In the Hall Surround mode, a realistic level of ambiance is added to a normal stereo source such as a CD or FM radio.

Pro Logic II: Dolby Pro Logic II is the new advanced version of Prologic, Dolby's original surround matrix with center channel output. Prologic II has enhanced imaging and wider bandwidth surround signals than original Pro Logic.

Dolby Pro logic II is intended for use with most movies and television programs that are designed to be listened to using Prologic decoding. In addition to the standard Dolby Prologic II, the GTP-860 supports three enhanced versions of Prologic II processing, which were designed for specific types of programs. **"Prologic II Music"** mode was designed for use with regular old stereo recordings and it can utilize all your speakers in your system when listening to a CD. **"Prologic II Movie"** is an enhanced version of Prologic II decoding with settings optimized for movies and television. **"Prologic II Panorama"** is a version of Prologic II that is intended for use with Movie playback that spreads the images from the front left and right speakers around to the surround speakers. **"Prologic II Matrix"** creates a surround sound signal from mono sources.

5 ch Stereo: This mode is designed for use with stereo program material. It is designed to get maximum output from all your speakers. The rear speakers are driven with the same signal as the front left and right, while the center speaker is a monophonic summation of the front speakers.

With any of the Digital Inputs, the GTP-860 automatically recognizes if the selected source carries a Dolby Digital™ or DTS™ signal. Dolby Digital and DTS have six independent channels available in total: Left, Center, Right, Surround Left, Surround Right and an "Effects Channel" (Subwoofer). With either Dolby Digital 5.1 or DTS digital input, the Stereo, Dolby Pro Logic and Hall surround modes cannot be selected.

The Dolby Digital signal allows for several channel configurations. Most two-channel Dolby Digital recordings will allow the Pro Logic listening mode to be applied.

[13] Bass/Treble Controls

The GTP-860 is fitted with Bass and Treble tone controls to adjust the overall tonality of your system. The 12 o'clock position is 'flat' with no boost or cut and a detent indicates this position.

Rotate the control clockwise to increase the amount of Bass or Treble. Rotate the control counter-clockwise to decrease the amount of Bass or Treble. These controls affect the Left and Right Front channels. The Tone controls do not affect recordings made using the Tape or Video line outputs.

DESCRIPTION OF UNIT: REAR PANEL

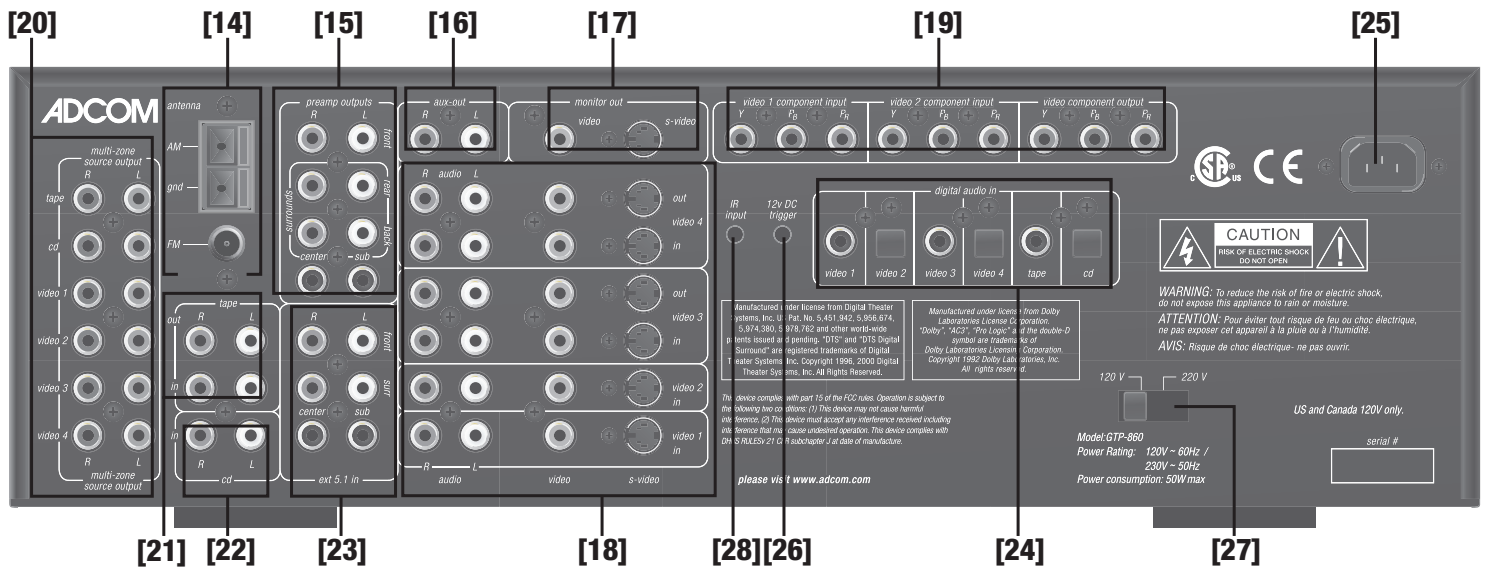

[14] Antenna Connections

[15] Preamp Outputs

[16] Auxiliary Outputs

[17] Monitor Outputs

[18] Video/Analog Audio
Inputs & Outputs

[19] Component Video
Inputs & Output

[20] Multi-Zone Source Outputs

[21] Tape Inputs and Outputs

[22] CD Analog Inputs

[23] External 5.1 Analog Inputs

[24] Digital Audio Inputs

[25] AC Power Cord

[26] 12V DC Trigger

[27] Voltage Switch

[28] IR Input

1.2 Inputs & Outputs System Connections

Like the front panel, the GTP-860's rear panel is carefully arranged to make hookup, configuration, and use as simple as possible. However, the GTP-860's capabilities take some study to use most effectively. We strongly suggest that you read this section of the manual before beginning to hook up your system. You will save yourself much time and effort if you carefully think out what you expect from your system: consider the components you will use, where they'll be placed, and how you will want them to work together. The diagrams and notes in this section will probably answer most of your questions about interfacing the GTP-860 with other components in your system.

Note that the GTP-860's RCA-style jacks have color-coded centers to make connections easier. Use this key to help route cables properly:

- RED** centers = **RIGHT CHANNEL ANALOG AUDIO** inputs or outputs
- WHITE** centers = **LEFT CHANNEL ANALOG AUDIO** inputs or outputs
- YELLOW** centers = **VIDEO** inputs (composite)
- BLACK** centers = **DIGITAL AUDIO** inputs and **CENTER CHANNEL** and **SUBWOOFER** inputs and outputs

[14] Antenna Connections

AM Antenna: An AM loop antenna is supplied with the GTP-860 and is required for AM reception. Open the clip terminal lever and insert the wire from the antenna. Closing the lever will lock the wire in place. Test various positions for the antenna, but always ensure the loop is placed vertically for best reception. Placing the antenna close to large metal items such as metal shelves or radiators may interfere with reception.

NOTE: When reception is not satisfactory using the supplied AM loop antenna alone, connection of an external antenna is recommended. The antenna cable to the loop antenna must not exceed three meters.

FM Antenna: A ribbon wire FM antenna is included and should be connected to the FM connector at the rear of the unit using the 'balun' adapter supplied. The ribbon aerial should be mounted on a vertical surface and placed so that it forms a 'T'.

Experiment with placement of the antenna to find the position that gives the best signal strength and lowest background noise. An inadequate FM signal normally results in high levels of hiss, especially in stereo, and interference from external electrical sources. In areas of poor FM reception, the tuner section's performance can be improved by using an externally mounted FM antenna. A qualified aerial installer will be able to advise and fit a recommended aerial for your reception conditions.

[15] Preamp Outputs

Before making any connections, check that the GTP-860 and the power amplifiers it will be connected to are switched off. Connect the RCA-to-RCA leads from the Front Left and Right, Center, Surround Rear Left and Right, and Surround Back Left and Right Preamp Outputs to your external amplifiers. The subwoofer preamp output allows for connection to a sub-bass speaker system with its own external or integrated power amplifier ("active" or "powered" subwoofers).

With volume turned down to a low level, switch power on only after all connections have been made.

[16] Auxiliary Outputs

The auxiliary outputs allow a line level connection to various devices, such as an audio system in another room. The output is the selected source.

[17] Monitor Outputs

Composite Video and S-Video outputs are for connecting a TV or Video Monitor to view video sources connected to Video 1 through Video 5. Using a Video RCA-to-RCA lead or S-Video, connect the 'Video Line In' on the TV or monitor to the MONITOR OUT.

Note that an S-video input signal will also be available as a composite video signal on the Monitor out if the corresponding source is selected. Composite video input signals will also be available as S-Video signals on the Monitor output.

The video signal available on the S-Video and Video Composite outputs is dependent on the selected video input (Video 1, Video 2, Video 3, Video 4, Video 5). However, when one of the audio-only sources is selected (FM, AM, CD, Tape Monitor or ext 5.1) the last selected video signal from one of the video inputs will be present on these outputs. This way you can watch a DVD player or video while using the 5.1 analog audio inputs from a DVD player, as you might do when listening to a DVD-A or SACD disc.

[18] Video/Analog Audio Inputs & Outputs

Apart from the audio signal, these inputs will also accept a video signal which will be routed to the Monitor Out sockets [17] for a television or video projector. Composite connection (using the yellow RCA socket) or an S-Video connection (using the Mini-Din connector) is available.

The S-Video standard allows for higher quality video signal transfer when compared to the Video Composite standard. If your video components have an S-Video connector use dedicated S-Video leads to connect them to the GTP-860 in the same way as described with the Video Composite equivalents.

A video signal fed to an S-Video input socket will be available on both the S-Video Monitor Out and Video Composite Monitor Out.

Video 1 & Video 2: Inputs for the audio playback and video signal from a video device such as a stereo TV, DVD player, satellite cable TV receiver or a Laser Disc. Using twin RCA-to-RCA leads, connect to the left and right 'Audio Out' of the video device to these inputs. Using a single RCA-to-RCA lead (Video Composite) or S-Video lead, also connect the video output of the video device. Video 1 & Video 2 can be used for video playback only. Use Video 3 or Video 4 if you want to connect a VCR for recording and playback through the GTP-860.

Video 3 & Video 4: Connections for the audio recording and playback to a VCR or other video recorder. Using twin RCA-to-RCA leads, connect to the left and right 'Audio Out' of the VCR to the Video 3 or Video 4 IN connectors for playback. Connect the left and right 'Audio In' of the VCR to the Video 3 or Video 4 OUT connectors for recording. Using a single RCA-to-RCA (Video Composite) lead or S-Video lead, also connect the video output of the VCR to Video In for Video playback. Connect the Video Input

of the VCR to Video Out of the GTP-860 preamplifier for recording of video signals.

[19] Component Video Inputs & Output

The GTP 860 can switch between two sources with component video output. The "video 1" and "video 2" sources have the capabilities to accept component video signals. Each component video signal uses three RCA type connections (Y-green plug, P_B - blue plug, and P_R - red plug), all three connections should be made for optimum video performance. Be sure to use high quality video specific cables for connection. The Component video connection is independent from the S-Video/Composite video jacks. In order to maximize signal quality, no On-screen text will appear on the component outputs. The "video component output" jacks should be connected to component video input on your TV.

[20] Multi-Zone Source Outputs

These output jacks provide a duplicate of the analog audio signal that are connected to Video 1-4, CD and Tape inputs. They are designed to allow the user to interface the sources connected to the GTP-860 with an external stereo receiver or tuner/preamplifier to facilitate multi-zone operation. When using the GTP-860 in conjunction with the GTP-506/GFA-5006 (a three room stereo tuner-preamplifier and amplifier combination) the user can deliver sound to three additional rooms using the same source components hooked up to the GTP-860. See drawing on next page (page 14) for details.

[21] Tape inputs and Outputs

Connections for analog recording and playback to an audio tape recorder of any type, such as a cassette, reel-reel, DAT, MD or CD-R. Using twin RCA-to-RCA leads, connect to the left and right 'Audio Output' of the tape machine to the TAPE IN connectors for playback. Connect the left and right 'Audio Input' of the tape machine to the TAPE OUT connectors for recording.

[22] CD Analog Inputs

Input for CD player (analog audio signal) or other line-level signal source. Use a twin RCA-to-RCA lead to connect the CD player's left and right 'Audio Outputs' to this input.

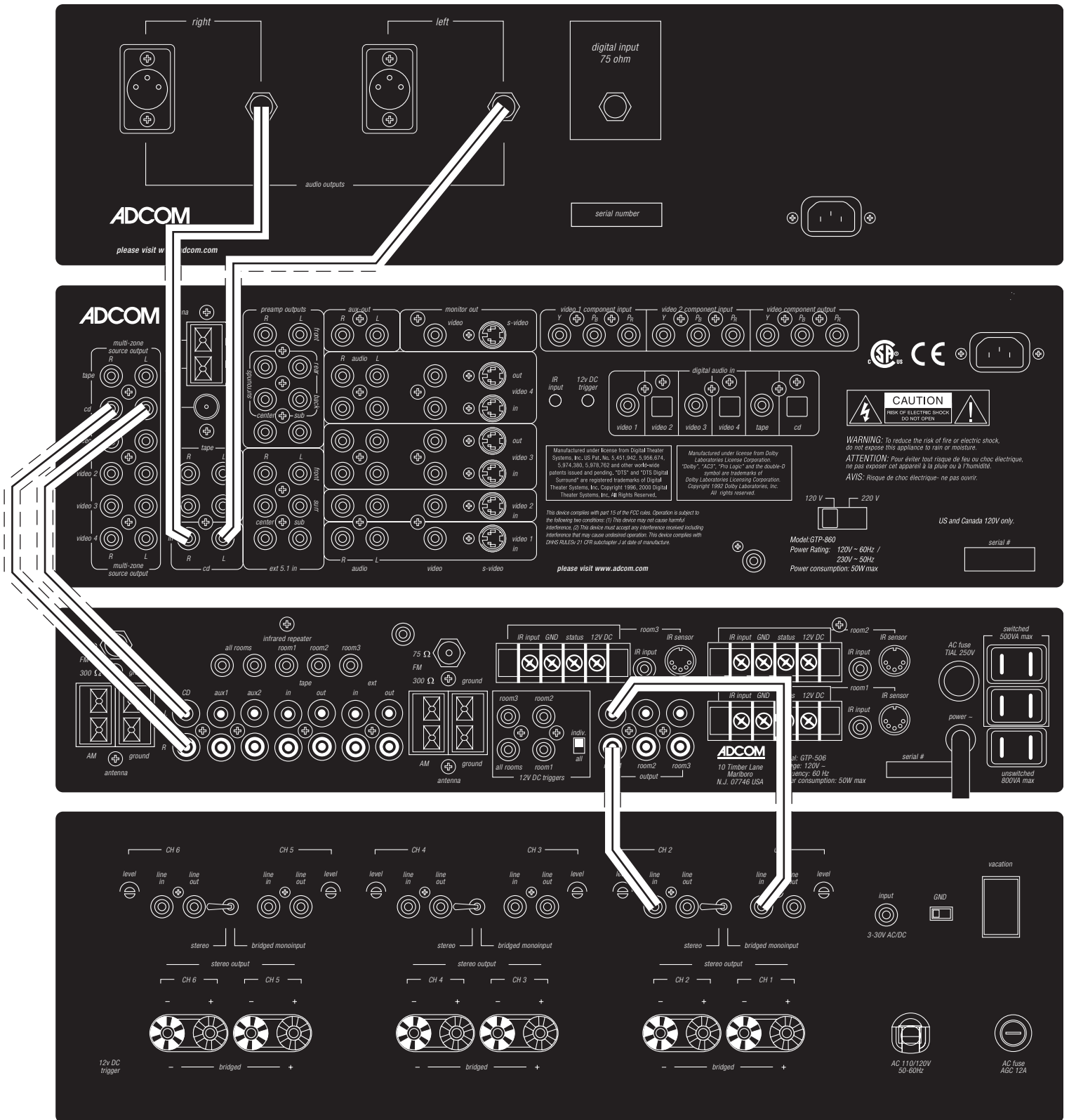

Multi-Zone Source Outputs

The drawing above illustrates the proper hook-up to provide audio to multiple zones using a signal source with the GTP-860. As illustrated above we use a

GTP-506 and GFA-5006 to distribute the audio source, an ADCOM GCD-750 CD player. Referenced from page 13, [20].

[23] External 5.1 Analog Inputs

Inputs for the multi-channel audio signals from an external decoder, such as an SACD or DVD-Audio player with integrated decoder. Use two twin RCA-to-RCA leads to connect the decoder's front left and right 'Audio Outputs' to the Front left and right inputs, and the decoder's Surround left and right outputs to the Surround left and right inputs. Use a third twin RCA-to-RCA lead to connect the decoder's subwoofer output to the Subwoofer input and the decoder's Center channel output to the Center channel input. Make sure to follow color coding of the plugs to ensure that both Center and Subwoofer are connected correctly; for instance, use the red plugs at either end to connect the center channel and the white plugs for the subwoofer channel.

[24] Digital Audio Inputs

The GTP-860 has six digital audio inputs to allow for connection of DVD, CD or other digital sources. Three inputs are optical and three are coaxial.

Use a cable with the proper impedance specifically designed for the transfer of digital signals.

[25] AC Power Cord

After you have completed all connections to the amplifier, plug the AC line cord into a "live" wall socket.

[26] 12V DC Trigger

To facilitate remote turn-on and turn-off of other components (power amplifiers, for example), this 3.5mm mini-jack provides a constant signal (12 volts DC) whenever the GTP-860 is fully powered. When the GTP-860 is turned off (via the front panel switch) or placed in standby mode (via the "power" button on the remote control), the jack has no output.

[27] Voltage Switch

The GTP-860 can be configured for either 120V or 230V operation using this switch. Extreme caution must be used when changing the voltage of the unit, as an incorrect voltage selection will cause severe damage to the unit. See your dealer or contact ADCOM for more details regarding the operation of this switch.

International Setup Procedure

Changing the video output between NTSC and PAL:

- Press to momentarily hold 'MEMORY' + 'VIDEO 1' keys at the same time.
- The VFD display will indicate the current video system for three to four seconds and then return to normal display function.

Changing the AM stepping frequency between USA 10KHz and Europe 9KHz:

- Press to momentarily hold 'EXT5.1' + 'VIDEO 3' keys at the same time.
- The VFD display will indicate the current AM stepping frequency for three to four seconds and then return to normal display function.

NOTE: We strongly recommend the use of our surge suppresser/line conditioners, the ADCOM ACE family of products, for systems with substantial amplifiers and many source components. The ACE products relieve the GTP-860 from handling large current surges, while they protect your entire system by filtering and conditioning the AC current. In addition to the numerous heavy duty AC outlets of the ACE-315, the ACE-615 includes sequential power-up and power-down modes to minimize "thumps" whenever you turn your system on or off.

[28] IR Input

The IR input allows hook up of an external IR sensor that sends IR information to the microprocessor in the GTP 860. This feature can be very useful if the GTP 860 is placed behind a non transparent door or is used with an after market remote control system.

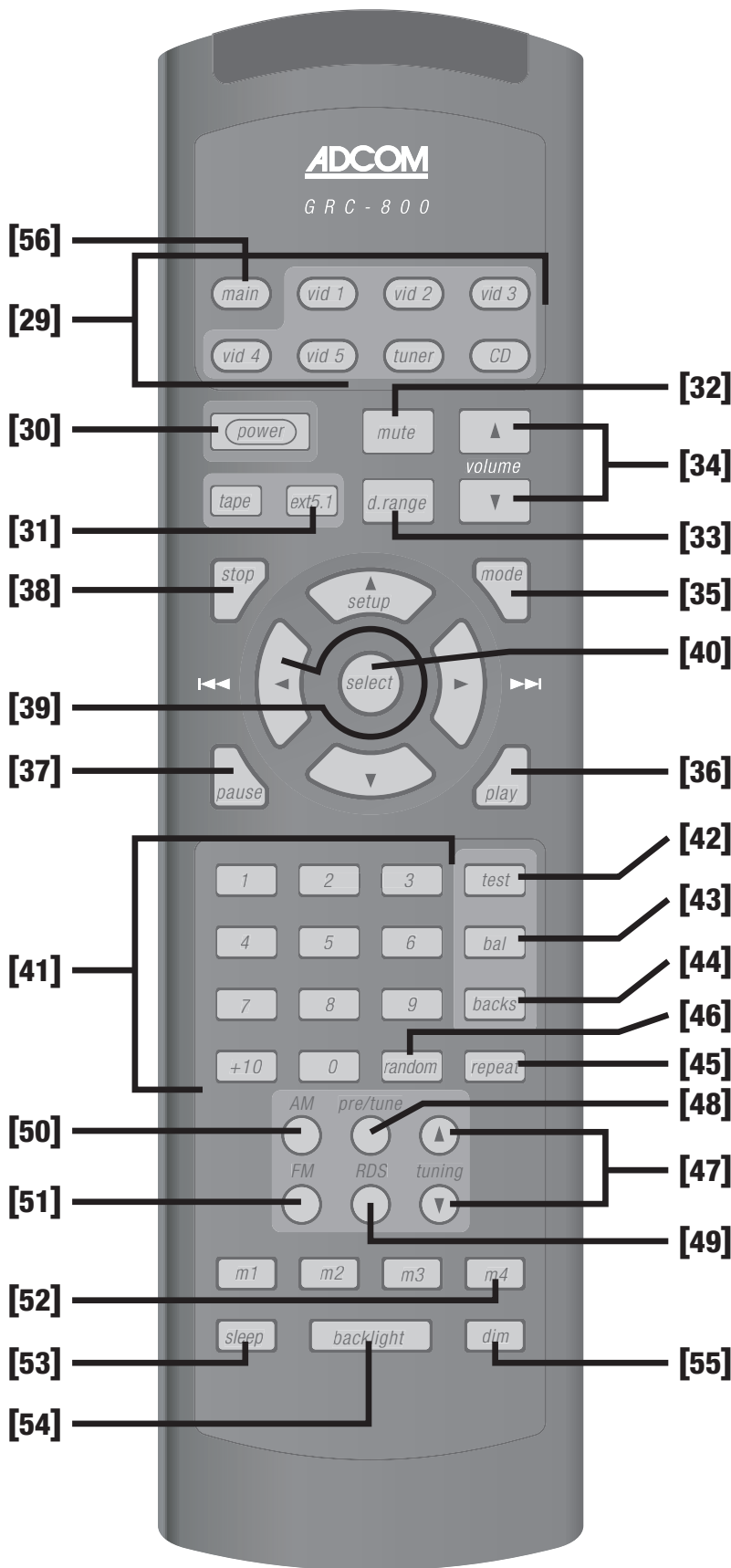

- [29] Source selectors
- [30] Power button
- [31] Input selectors
- [32] Mute button
- [33] d. range [dynamic range] button
- [34] Volume Up/Down buttons
- [35] Mode button
- [36] Play button
- [37] Pause button
- [38] Stop button
- [39] Arrow buttons
- [40] Select button
- [41] Direct Access Keypad
- [42] Test button
- [43] Bal (balance check) button
- [44] Backs button
- [45] Repeat button
- [46] Random button
- [47] Tuning Up/Down buttons
- [48] Pre/Tune button
- [49] RDS button
- [50] AM button
- [51] FM button
- [52] M1, M2, M3, M4 [Macro Keys]
- [53] Sleep button
- [54] Backlight button
- [55] Dim button
- [56] Main button

REMOTE CONTROL

2.1 Overview of the GRC-800

The GRC-800 remote control is a learning remote control that is capable of saving commands for all remote controls in your home theater system. In this way, you may eliminate the confusion of using multiple remotes. Although such power comes with some added complexity, the complexity is minimal and with some repetition will become second nature.

Eight Source Select Buttons

The single most important aspect to master about the GRC-800 remote control is the function of the eight source select buttons at the top of the remote. These are the buttons labeled [56] and [29] in the figure on the opposite page. Each of these buttons cause two things to happen when used. First, they select the corresponding input on the GTP-860. Second, THESE KEYS REMAP ALL OF THE OTHER BUTTONS ON THE REMOTE CONTROL. You can think of each of these buttons as having a page of commands associated with it. Some buttons, such as volume up and down, are preprogrammed to operate the GTP-860 for each source. These buttons can be "written over" if you like, but default to GTP-860 operations for your convenience.

Most of the GTP-860 remote commands are saved under the main remote page. Whenever you desire to control the GTP-860 via remote, you must first ensure the main page is active. As an example, press [56] main on the remote control. Now, press the dim button. If your GTP-860 is on, the brightness of the front panel display changes. Notice also that the main button on your remote illuminates. This serves as a reminder that the main remote page is currently active. Now press the CD button and then the play button. Notice now that the CD source button lights. The CD remote page is now active. If you have an ADCOM CD player, this command will cause an idle CD to play. Now, press the dim button again. You should note that CD button does not light. The dim command is not preprogrammed in the CD remote page. If your GTP-860 is on you will also notice the display does not respond to this command. Press the [56] main button again to reenter the main remote page. The dim button will now again change the GTP-860 display.

The button description that follows distinguishes the function of each button dependent on the page the remote is in. The remote is shipped from the factory with ADCOM commands saved under the main, tuner, and CD pages, and with important GTP-860 functions such as volume saved under each page.

The ADCOM universal remote controller is preset to operate all GTP-860 functions (MAIN and TUNER device mode) and most GCD-700/750 CD functions (CD device mode).

Alkaline batteries are recommended for maximum operating life. Four AAA (R 03) batteries should be fitted in the battery compartment at the rear of the remote control. When replacing batteries, check that they have been put in correctly, as indicated on the base of the battery compartment.

Remote Features

[29] Source Selectors (vid 1, vid 2, vid 3, vid 4, vid 5, tuner, CD):

These buttons serve two functions.

- First, they switch inputs on the GTP-860 so you can hear the source you've just selected.
- Second (and even more important), they can change the functions of all the other buttons on the remote controller. In other words, if you first push the CD device selector, the remote's play button generates a command code for your DVD player. If you then press the vid 5 device selector, the same play button would send a different command code that might, for example, start your mini-disc player. (Of course, this all depends on how you programmed the remote in the first place. This will be covered shortly.)

[30] Power Button

In all modes, this is preprogrammed to turn the GTP-860 on and off.

[31] Input Selector (tape, ext 5.1)

In main mode, these are similar to the source selectors described above but they switch only GTP-860 inputs. They DO NOT automatically change the functions of other remote buttons.

[32] Mute Button

In all modes, this button is preprogrammed to mute outputs of device. Mute does not affect recordings made using the Tape outputs but will affect the signal going to the Preamp Outputs. When the unit is in mute mode, any adjustment of the Volume Control on the front panel [8] will release the muting, i.e. the original volume level will be resumed.

[33] Dynamic Range Button

In main mode, this button is preprogrammed to adjust dynamic range of Dolby Digital encoded sources.

The d. range button, which can be used only in combination with a Dolby Digital source, incrementally reduces the audio track's dynamic range in four steps (100%, 75%, 50% and 25%) to allow for comfortable listening under a variety of conditions. The normal or default position is 100%. To adjust the dynamic range, each consecutive press of the d. range button will reduce the value in 25% increments, as shown in the alpha-numeric display section.

Although we usually prefer to reproduce a source's full dynamic range (the difference between very loud and very soft sounds), it may occasionally be desirable to reduce the dynamic range. For example, when playing a movie late at night, loud explosions might wake sleeping family members. Simply turning the volume control down would probably make a whisper in the next scene inaudible. The d. range button solves this dilemma by progressively lowering the volume of loud peaks while increasing the level of softer sounds.

[34] Volume Up/Down Buttons

In all modes, these buttons change the master volume setting of the GTP-860. In all modes except main, they can be reprogrammed with new commands. The Volume control does not affect recordings made using the Tape and Video, or Tape, Video 3 and Video 4 outputs but will affect the signal going to the Preamp output.

[35] Mode Button

In main mode, this is preprogrammed to cycle through the surround modes of the GTP-860. Pressing repeatedly will cycle through Pro Logic, Hall, and Stereo, when available. Refer to the Surround Mode description [12] for more information.

[36] Play Button

In CD mode, it is preprogrammed for play with an ADCOM CD player.

[37] Pause Button

In CD mode, it is preprogrammed to pause an ADCOM CD player.

[38] Stop Button

In CD mode, it is preprogrammed to stop an ADCOM CD player.

[39] Arrow Buttons

The arrow buttons allow navigation throughout the GTP-860 OSD (On Screen Display) menus (as well as the menus of other devices, once the commands are learned). Please refer to section 3.1 for further explanations on the OSD.

Left arrow: In main mode, this is preprogrammed to step through the various choices you might wish to select while a menu item is highlighted.

In CD mode, it is preprogrammed for audible reverse scan with an ADCOM CD player.

Up arrow/Setup: In main mode, this is preprogrammed to enter the OSD menu system, as well as scroll up to the next choice on a menu screen.

Right arrow: In main mode, this is preprogrammed to step through the various choices you might wish to select while a menu item is highlighted.

In CD mode, it is preprogrammed for audible forward scan with an ADCOM CD player

Down arrow: In main mode, this is preprogrammed to scroll down to the next choice on a menu screen.

[40] Select Button

In main mode, this is preprogrammed to enter a selection chosen via the menu system.

[41] Direct Access Keypad

(buttons "1" through "10," and "+10"):

In CD mode, buttons are preprogrammed as track access commands for the ADCOM CD player.

[42] Test Button

Pressing the test button engages the test signal generator to allow for adjustment of all speaker levels, so that each channel can be adjusted for equal loudness at your listening position. The test signal cycles automatically with 3-second intervals from Front Left, Center, Front Right, Rear Right, Back Right, Back Left, Rear Left, to Subwoofer in continuous cycles. If an adjustment in setting is made for one of the channels, cycling will pause for 3 seconds after the adjustment was made. Both display panel and OSD show which speaker is being fed with the test signal. Use the cursor down and up buttons to respectively decrease or increase the level for the current speaker. Press the test button again to leave or cancel the test mode, any changes will be memorized automatically.

[43] Balance (balance check) Button

In main mode, button is preprogrammed to initiate balance check procedure. Even when the GTP-860 is correctly set-up, it may sometimes be desirable to make minor adjustments to suit the material you are listening to. Pressing the bal button allows for direct adjustment of Center, Surround, and Subwoofer levels. Press the bal button to scroll to the next speaker. Both display panel and OSD show which channel can be adjusted. Use the Down and Up arrow buttons to respectively decrease or increase the level for the current channel.

[44] Backs Button

In all modes, this button is preprogrammed to toggle on and off the Surround Back speakers.

[45] Repeat Button

In CD mode, this button is preprogrammed as "repeat" command for ADCOM CD player.

[46] Random Button

In CD mode, this button is preprogrammed as "random" command for ADCOM CD player.

[47] Tuning Up/Down Buttons

In tuner mode, these buttons are preprogrammed to scan up or down the GTP-860's AM or FM band.

[48] Pre/Tune Button

In main and tuner modes, this button toggles between manual tuning and preset station functions for the tuning up and down buttons [47].

[49] RDS Button

In main and tuner modes, cycles through the RDS functions of the tuner. Refer to the Display button description [2] for more information about RDS.

[50] AM Button

In main and tuner mode, buttons are preprogrammed to select the AM band.

[51] FM Button

In main and tuner mode, buttons are preprogrammed to select the FM band.

[52] M1, M2, M3, M4 (Macro Keys)

These buttons are programmable for use with any source.

[53] Sleep Button

Press sleep to make the GTP-860 automatically switch off after a preset number of minutes. Pressing the sleep button once will set the sleep time to 90 minutes, after which the GTP-860 will automatically switch off into Standby mode. Sleep mode is shown on the Display Panel. To adjust the Sleep Delay, press the sleep button, each consecutive press will reduce the sleep time in 30-minute increments, as shown in the Display Panel. To cancel the sleep mode, continue pressing the sleep button until the sleep time returns to 0 minutes. Pressing the power on the front panel [1] or Stand-By button will also cancel the sleep mode.

[54] Backlight Button

No programming capabilities. Button backlights all keys for eight (8) seconds when pressed.

[55] Dim Button

In main mode, button is preprogrammed to dim GTP-860's information display.

[56] Main Button

In all modes, button provides access to the GTP-860. For instance, to turn on the test tone generator first push [56] the main button, then push [42] the test button.

2.2 Remote Function Table

This table supplements the information you've just read. Use it to quickly review button functions. The controller's capabilities are extensive and may be somewhat intimidating at first. However, you will soon find that its logical button arrangement and programming capabilities will greatly increase your enjoyment as you discover the ease with which you can operate your entire system from just one remote!

Look down the left-hand column until you see the button you want to learn about. Then look under MAIN to see if it is preprogrammed for a GTP-860 function, under CD to see what CD commands are preprogrammed, and under TUNER to see all preprogrammed tuning functions.

NOTES: Direct sunlight or very bright ambient lighting may affect the operating range and angle for the remote control handset.

The infrared remote control command receiver, located to the right of the Power button, receives commands from the remote control. There must be a clear line-of-sight path from the remote control to this window; if that path is obstructed, the remote control may not work.

BUTTONS	Main	CD	Tuner	All Others
MAIN	Selects Main	Selects Main	Selects Main	Selects Main
VID 1	Selects Video 1	Selects Video 1	Selects Video 1	Selects Video 1
VID 2	Selects Video 2	Selects Video 2	Selects Video 2	Selects Video 2
VID 3	Selects Video 3	Selects Video 3	Selects Video 3	Selects Video 3
VID 4	Selects Video 4	Selects Video 4	Selects Video 4	Selects Video 4
VID 5	Selects Video 5	Selects Video 5	Selects Video 5	Selects Video 5
TUNER	Selects Tuner	Selects Tuner	Selects Tuner	Selects Tuner
CD	Selects CD	Selects CD	Selects CD	Selects CD
POWER	Power On/Off & Macro	Power On/Off	Power On/Off	Power On/Off
MUTE	Mute Volume	Mute Volume	Mute Volume	Mute Volume
VOLUME UP	Master Volume Up	Master Volume Up	Master Volume Up	Master Volume Up
VOLUME DOWN	Master Volume Down	Master Volume Down	Master Volume Down	Master Volume Down
TAPE	Selects Tape	<i>Programmable</i>	<i>Programmable</i>	<i>Programmable</i>
EXT 5.1	Selects Ext 5.1	<i>Programmable</i>	<i>Programmable</i>	<i>Programmable</i>
D. RANGE	Dynamic Range adjust	<i>Programmable</i>	<i>Programmable</i>	<i>Programmable</i>
STOP	<i>Not programmable</i>	Stop CD	<i>Programmable</i>	<i>Programmable</i>
MODE	Surround Mode Select	Surround Mode Select	Surround Mode Select	Surround Mode Select
PAUSE	<i>Not programmable</i>	Pause CD	<i>Programmable</i>	<i>Programmable</i>
PLAY	<i>Not programmable</i>	Play CD	<i>Programmable</i>	<i>Programmable</i>
SETUP/UP	<i>Not programmable</i>	<i>Programmable</i>	<i>Programmable</i>	<i>Programmable</i>

continued on opposite

BUTTONS	Main	CD	Tuner	All Others
RIGHT	OSD Right Select	Skip Ahead	<i>Programmable</i>	<i>Programmable</i>
DOWN	OSD Scroll Down	<i>Programmable</i>	<i>Programmable</i>	<i>Programmable</i>
LEFT	OSD Left Select	Skip Back	<i>Programmable</i>	<i>Programmable</i>
SELECT	OSD "Enter" Select	<i>Programmable</i>	<i>Programmable</i>	<i>Programmable</i>
1	<i>Not programmable</i>	Track 1	<i>Programmable</i>	<i>Programmable</i>
2	<i>Not programmable</i>	Track 2	<i>Programmable</i>	<i>Programmable</i>
3	<i>Not programmable</i>	Track 3	<i>Programmable</i>	<i>Programmable</i>
4	<i>Not programmable</i>	Track 4	<i>Programmable</i>	<i>Programmable</i>
5	<i>Not programmable</i>	Track 5	<i>Programmable</i>	<i>Programmable</i>
6	<i>Not programmable</i>	Track 6	<i>Programmable</i>	<i>Programmable</i>
7	<i>Not programmable</i>	Track 7	<i>Programmable</i>	<i>Programmable</i>
8	<i>Not programmable</i>	Track 8	<i>Programmable</i>	<i>Programmable</i>
9	<i>Not programmable</i>	Track 9	<i>Programmable</i>	<i>Programmable</i>
0	<i>Not programmable</i>	Track 10	<i>Programmable</i>	<i>Programmable</i>
+10	<i>Not programmable</i>	+10	<i>Programmable</i>	<i>Programmable</i>
TEST	Test Tone On/Off	<i>Programmable</i>	<i>Programmable</i>	<i>Programmable</i>
BAL	Selects Channel Trims	<i>Programmable</i>	<i>Programmable</i>	<i>Programmable</i>
BACKS	Surr Backs On/Off	Surr Backs On/Off	Surr Backs On/Off	Surr Backs On/Off
REPEAT	<i>Not programmable</i>	Repeat Current Track	<i>Programmable</i>	<i>Programmable</i>
RANDOM	<i>Not programmable</i>	Random Play	<i>Programmable</i>	<i>Programmable</i>
AM	<i>Not programmable</i>	<i>Programmable</i>	Selects AM	<i>Programmable</i>
FM	<i>Not programmable</i>	<i>Programmable</i>	Selects FM	<i>Programmable</i>
PRE/TUNE	Selects Presets/Tuner	<i>Programmable</i>	Selects Tune/Preset	<i>Programmable</i>
RDS	Enables RDS	<i>Programmable</i>	Enables RDS	<i>Programmable</i>
TUNING UP	Tuning Up	<i>Programmable</i>	Tuning UP	<i>Programmable</i>
TUNING DOWN	Tuning Down	<i>Programmable</i>	Tuning Down	<i>Programmable</i>
M1	For Macro Use	For Macro Use	For Macro Use	For Macro Use
M2	For Macro Use	For Macro Use	For Macro Use	For Macro Use
M3	For Macro Use	For Macro Use	For Macro Use	For Macro Use
M4	For Macro Use	For Macro Use	For Macro Use	For Macro Use
SLEEP	Sleep	Sleep	Sleep	Sleep
BLACKLIGHT	Backlights All Buttons	Backlights All Buttons	Backlights All Buttons	Backlights All Buttons
DIM	Dims Display	<i>Programmable</i>	<i>Programmable</i>	<i>Programmable</i>

2.3 Programming Your ADCOM GRC-800 Remote Controller

The ADCOM universal remote controller operates eight different audio/video components. As you've already seen, it's preprogrammed to control ADCOM's GTP-860 Preamp/Tuner and the GCD-700/750 CD players. In addition, it has seven "component memory banks" available so you can program the remote to learn commands for your DVD player, satellite box, laser disc player, VCR, etc. This lets you use one remote controller for your entire system.

Using Preprogrammed Commands

Using the remote controller's preprogrammed commands is simple. For most GTP-860 functions (volume up/down, changing surround modes, etc.), follow these easy steps.

1. Press the main source selector button. This tells the remote that you want to use GTP-860 preprogrammed commands. The main button will flash red to tell you it understands.
2. Press the appropriate function button (volume up, volume down, etc.) If you've selected a button that actually triggers a GTP-860 command, the main button will again flash red to confirm your choice. If the main button does not flash, you've selected a function button that isn't preprogrammed.

(Review the table above to see which buttons are preprogrammed.)

For tuner functions (changing stations, etc.):

1. Press the tuner source selector button. It will flash red.
2. Press the tuning up (or tuning down) function button to change stations. The tuner source selector will flash red to confirm that the function button you've selected actually triggers a command. (Again, use the table to see which buttons are preprogrammed.)

Press the CD source selector first to access preprogrammed commands for ADCOM CD players.

NOTE: You can program new commands over the preprogrammed commands in tuner and CD if you wish. However, you cannot program any buttons, even those unprogrammed with GTP-860

command codes, while you're in main mode. This safety feature assures you that you will always be able to fully enjoy the GTP-860's capabilities.

Programming Your Own Commands

You can supplement preprogrammed commands with commands to operate other components. Before you begin to follow these steps, note the status LED located at the top left corner just above the remote's button panel: It will flash red, orange, or green to signal particular functions as you enter new commands into your ADCOM remote. Begin by deciding which source component's commands you will be transferring to the ADCOM remote. Then press the appropriate source selector button. For example, if you're teaching your ADCOM remote commands for your Video 1 source, press the vid 1 source selector first. You can "teach" your remote new commands for any function button (except backlight) after you've selected vid 1, vid 2, vid 3, vid 4, vid 5, tuner, or CD.

1. Place the source component's remote "head to head" with the ADCOM remote. They should be in line with each other about 2 to 3 inches apart.
2. Press the ADCOM remote's appropriate source selector and select buttons simultaneously. Hold both buttons until the status LED turns orange and the source selector button glows red. Both indicators should remain lit.
3. Decide which function button on the ADCOM remote you want to learn a new command. Press it. The orange status LED will begin to flash and the source selector LED will go out.
4. Find the corresponding button on the source component's remote. Press and hold it until the status LED on the ADCOM remote flashes green once and remains green until the button on the source remote is released. Once the button on the source remote is released, the status LED will start flashing orange again.
5. Verify that the ADCOM remote has learned the new command by pressing and holding the same button on the source remote. The ADCOM remote's status LED should flash green twice and then go back to steady orange. This indicates successful programming. Release the button on the source remote.

Repeat Steps 3 through 5 for any other commands you want to teach your ADCOM remote for that source component.

Save the commands you've just programmed into the ADCOM remote by pressing and holding the appropriate source selector and select buttons simultaneously. Hold until the status LED and source selector LED flash twice and then go out. Repeat these steps for any other source commands you wish to program.

Deleting (Clearing) Individual Programmed Commands

1. Press the ADCOM remote's source selector and select buttons simultaneously and hold until the orange status LED and the source selector button glow steadily.
2. Press the function button you wish to clear. The status LED will flash continuously.
3. Press the backlight button. The status LED will then flash green twice and then revert to steady orange. The source selector button will continue to glow.

Repeat steps 2 and 3 for any other command you wish to delete for the same source component.

4. Exit "delete mode" by pressing and holding the source selector and select buttons simultaneously. The orange status LED and the source selector button will turn off.

Deleting All The Programmed Commands for One Source Component

1. Press the ADCOM remote's source selector and select buttons simultaneously and hold until the orange Status LED and the source selector button turn on and remain lit.
2. Press and hold down the backlight button. The red Status LED and the Device button will flash five times, the Status LED will then flash green twice and turn to a constant orange, indicating that all the learned information for the device mode selected has been erased.
3. To exit this feature, press and hold the ADCOM remote's source selector and select buttons simultaneously. The orange status LED and the source selector button will flash twice and then turn off.

Deleting All The Programmed Commands for Every Source Component

NOTE: This procedure erases every programmed command accessed under the selected vid 1, vid 2, vid 3, vid 4, vid 5, tuner, and CD input selectors. Make sure you really want to do this before following the step below.

1. Press and hold the VID 5 input selector and the backlight button simultaneously. The red status LED will flash twelve times. The status LED will then flash green once, followed by a single orange pulse.

All LEDs will then turn off, indicating that every learned command in the ADCOM remote has been erased.

Macro Commands

"Macro" commands are simply a series of individual commands initiated by pushing just one button.

The ADCOM remote can learn up to 10 individual commands and store them as a single macro.

There are five "macro initiator" buttons on the ADCOM remote: power, m1, m2, m3, and m4. Each "macro initiator" can store and transmit either of two complete macros, depending on which source selector is active when you push it.

For macro programming purposes, think of the source selectors as being in two groups: main, vid1, vid 2, and vid 3 in Group 1; vid 4, vid 5, tuner, and CD in Group 2. When you program a "Group 1" macro, you will start by pushing the main source selector. After you've completed and memorized that macro command series, you can initiate it whenever you're in main, vid 1, vid 2, or vid 3 modes. Similarly, you will program "Group 2" macros by pushing vid 4 first and can use them whenever the vid 4, vid 5, tuner, or CD inputs are active.



For example, if the m1 button is programmed in Group 1 mode to turn on the TV, turn on the audio receiver, turn on the VCR, and then turn on the satellite receiver, it will perform the same series of commands whenever the m1 button is pressed IF main, vid 1, vid 2, or vid 3 sources are selected at the time you select that macro. If you've programmed a Group 2 macro, it will send out an identical command sequence whenever vid 4, vid 5, tuner, or CD inputs are selected.

2.4 Programming Macro Initiator Buttons:

1. Press either the Group 1 or Group 2 source selector button (main or vid 4 respectively) and the mute button simultaneously. Hold both buttons until the red status LED and the input selector button remain lighted.
2. Press the macro initiator button (power, m1, m2, m3 or m4) you wish to program.
3. Select and press up to 10 buttons you wish to store in the macro. Both source selector and function buttons count as individual commands. Remember that each macro can hold only up to 10 individual commands.
4. Press the tuning up button to save the macro. The red status LED and input selector button will blink twice to confirm programming and then turn off.

Please note:

- To add a power (on/off) command to the macro, use the mute button in place of the power button.
- The tuning up/down buttons cannot be used in a macro sequence.

Deleting Macro Initiator Buttons:

1. Press either the Group 1 or Group 2 source selector button (main or vid 4 respectively) and the mute button simultaneously. Hold both buttons until the red status LED and the input selector button remain lighted.
2. Press the macro initiator button (power, m1, m2, m3 or m4) you wish to delete.
3. Press the tuning up button. The red status LED and input selector button will blink twice to confirm deletion of the macro.

FUNCTION and DATA list for GTP-860(ADCOM) B: LSB first D: decimal
 Discrete (Direct Access) Custom Code: 1Ah E8h Code Type: NEC2

Function	Data(B)	D	Function	Data(B)	D
* MAIN POWER ON	0010 1010	84	* Delay Rear 15mS	0110 0000	6
* MAIN POWER OFF	1010 1010	85	* Delay Rear 10mS	1110 0000	7
* DOLBY PRO LOGIC	0111 0000	14	* Delay Rear 5mS	0010 0010	68
* SYMPHONY HALL	1111 0000	15	* Delay Rear None	1010 0010	69
* 2 CHANNEL STEREO	1111 0010	79	* Center Trim +	0001 0000	8
* 5 CHANNEL STEREO	0111 0010	78	* Center Trim -	1001 0000	9
* DOLBY PL II MOVIE	0011 1010	92	* Rear Left Trim +	0101 0000	10
* DOLBY PL II MUSIC	1011 1010	93	* Rear Left Trim -	1101 0000	11
* DOLBY PL II PANORAMA	0111 1010	94	* Rear Right Trim +	0001 0010	72
* DOLBY PL II MATRIX	1111 1010	95	* Rear Right Trim -	1001 0010	73
* Delay Front 5mS	0000 0000	0	* Subwoofer Trim +	0101 0010	74
* Delay Front 4mS	1000 0000	1	* Subwoofer Trim -	1101 0010	75
* Delay Front 3mS	0100 0000	2	* Back Left Trim +	0011 1000	28
* Delay Front 2mS	1100 0000	3	* Back Left Trim -	1011 1000	29
* Delay Front 1mS	0000 0010	64	* Back Right Trim +	0111 1000	30
* Delay Front None	1000 0010	65	* Back Right Trim -	1111 1000	31
* Dynamic Range Normal	0100 0010	66	* OSD Bypass ON	0110 1000	22
* Dynamic Range 75%	1100 0010	67	* OSD Bypass OFF	1110 1000	23
* Dynamic Range 50%	0110 0010	70	* Mute ON	0110 0001	86
* Dynamic Range 25%	1110 0010	71	* Mute OFF	1110 0001	87

* OSD bypass is not available on all units.

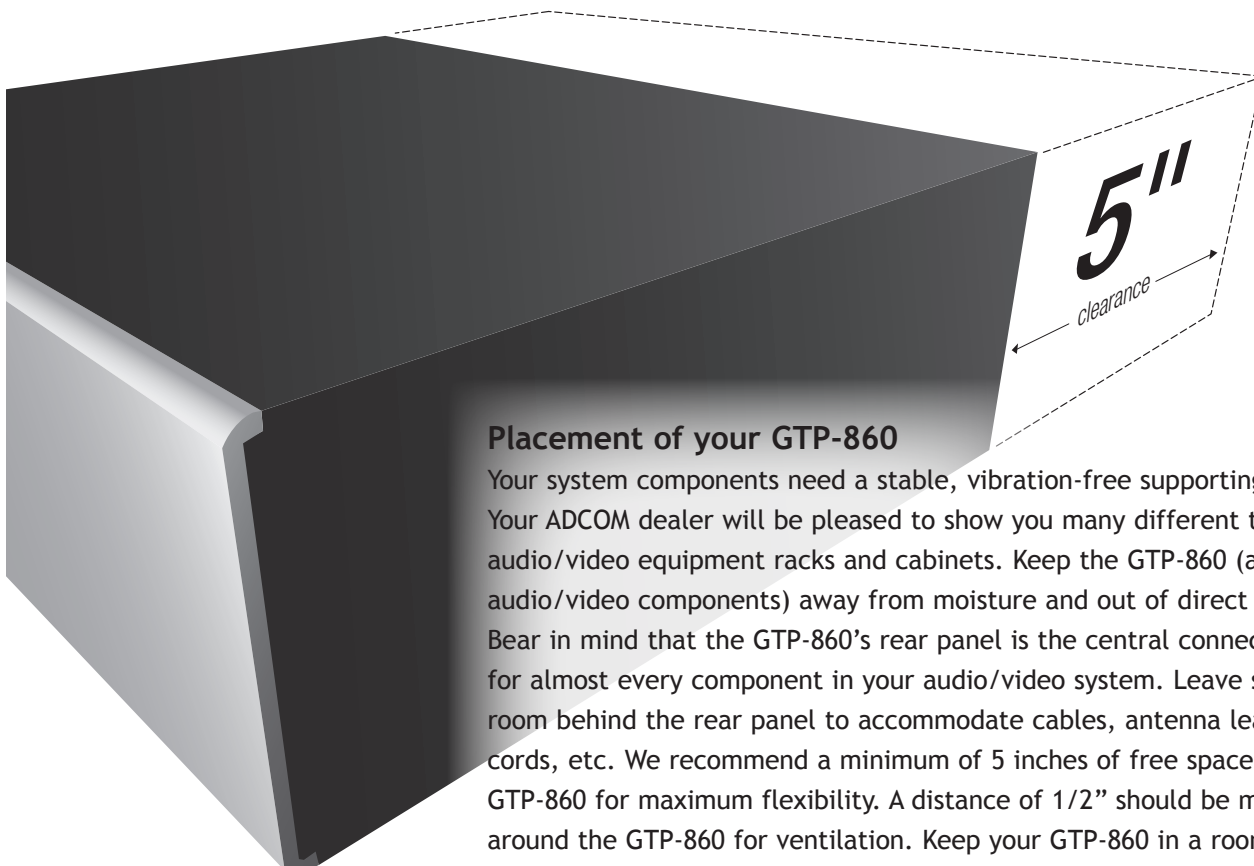

Placement of your GTP-860

Your system components need a stable, vibration-free supporting surface. Your ADCOM dealer will be pleased to show you many different types of audio/video equipment racks and cabinets. Keep the GTP-860 (and other audio/video components) away from moisture and out of direct sunlight. Bear in mind that the GTP-860's rear panel is the central connecting point for almost every component in your audio/video system. Leave sufficient room behind the rear panel to accommodate cables, antenna leads, power cords, etc. We recommend a minimum of 5 inches of free space behind the GTP-860 for maximum flexibility. A distance of 1/2" should be maintained around the GTP-860 for ventilation. Keep your GTP-860 in a room where temperatures remain fairly moderate, and never cover it with table cloths, curtains, newspapers, etc., to avoid potential overheating.

OPERATION & SETUP

After connecting your home theater, you may elect to configure the GTP-860 to the specific speaker arrangement and dimensions of your system. The procedures described in this section demonstrate how to use the GTP-860's on screen display to enter this information. Once complete, the GTP-860 stores this information so that these tasks need only be repeated if speakers are changed or substantially repositioned.

3.1 On Screen Display (OSD)

The GTP-860 is equipped with an elaborate On Screen Display facility (OSD). As the OSD is an essential tool to set up the various parameters for Surround sound correctly it is recommended that you connect your monitor or television to the GTP-860.

Depending on your source and/or the television system used you must first select the correct video system. If the OSD rolls over the screen you must select another system: PAL or NTSC.

While pressing the Memory button [4] on the front panel, press the Video 1 input selector button [11] repeatedly until the desired system is shown in the display area. The OSD can be engaged by pressing main and then setup buttons on the remote control. The SETUP Menu will appear as below:

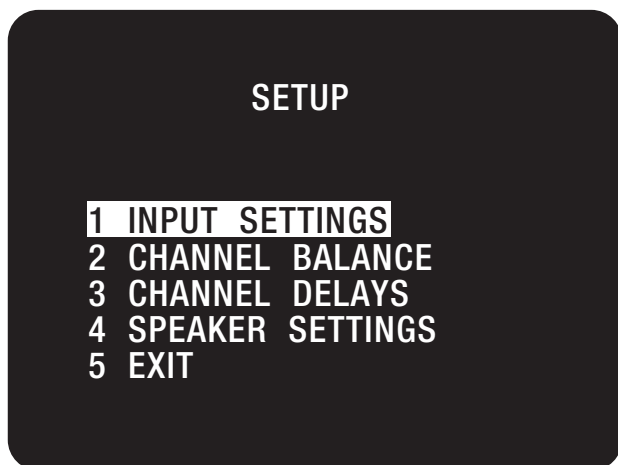

Use the cursor buttons on the remote control to navigate, select the desired menu and options, then press Select [40] to access. The Up and Down arrow buttons are used to navigate and select an option (indicated by highlighting the available option). The Left or Right arrow buttons are used to change a setting from the highlighted section, and

Select is used to choose the desired option. Otherwise, highlight EXIT and press Select to leave.

The OSD menus are at maximum two "layers" deep; this means that from the main menu (layer 1) you can select a sub menu (layer 2).

3.2 Channel Balance

The output levels of each of the speakers connected to the GTP-860 may need to be adjusted so that there is an even balance of sound from all the speakers in the system. If, for instance, the relative volume level to the Left and Right speakers and the Center speaker is set too low, most of dialogue may be difficult to follow. If, on the other hand it is set too loud, the overall balance will sound unnatural.

To adjust the channel balance the GTP-860 is equipped with a Test button [42] to help assess the loudness levels of each speaker. Before adjusting the channel balance level make sure the master volume is turned down to a normal listening level.

Pressing the Test button engages the Test signal generator to allow for adjustment of all speaker levels, so that each channel can be adjusted for equal loudness at your listening position. The test signal scrolls automatically with 3 second intervals from Left, Center, Right, Rear Right, Back Right, Back Left, Rear Left, to Subwoofer in continuous cycles. If an adjustment in setting is made for one of the channels, scrolling will stop until 3 seconds after the adjustment was made. Both the display panel and OSD show which speaker is being fed with the test signal. Use the Left and Right arrow buttons to increase or decrease the level for the current speaker.

The Channel Balance for each speaker can be adjusted in 1dB increments. (The back channels are adjusted in 2 dB increments.) Continue to calibrate the level for each speaker until equal loudness is achieved at your listening position. A more accurate adjustment can be made using a sound level meter, if available. Set the meter to "Slow" and "C-weighted" modes and re-check the settings with the meter placed in several different positions in the general listening area.

Select the channel for which you wish to adjust and set the level so that it matches the other channels. For best

results, start with the Left channel set at 0dB and to match the other channels to it. Normally, if the Right speaker is located at the same distance from the listening position to the Left speaker it should be set at the same level as the Left speaker.

Press the Test button again to leave or cancel the Test mode; any changes will be memorized automatically.

NOTE: There is no output in the Subwoofer during noise sequencer operation; therefore it is difficult to adjust the level in test mode. The Subwoofer level can be adjusted in the OSD setup menu with musical input.

After setting the balance with the Test function, you may wish to make further adjustments by ear, depending on the material you are listening to. There are two ways to access the Channel Balance screen, which allows you to adjust levels while monitoring a source.

Highlight CHANNEL BALANCE in the SETUP menu and press Select on the remote. You will see a screen similar to the following:

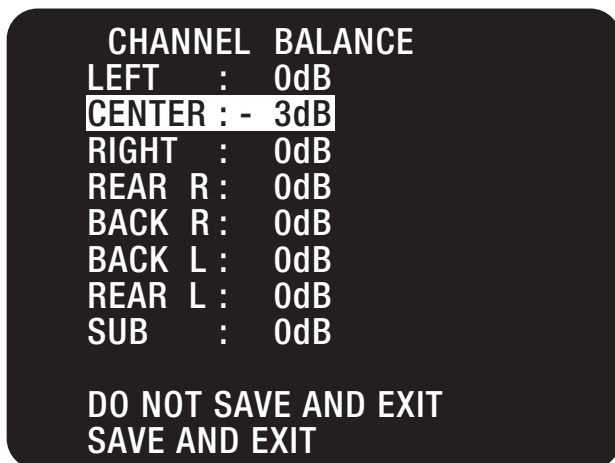

The GTP-860 allows the volume of each speaker to be individually trimmed so that none of the speakers dominates in playback and detracts from the surround illusion.

Highlight the speaker you wish to adjust, using the Up and Down arrow buttons. Use the Left arrow button to lower the output level, and the Right arrow button to raise the output level. Each speaker can be adjusted within a -10 to +10dB range, in steps of 1dB. The back channels can be adjusted within a -60 to +10 dB range, in steps of 2dB.

Highlight SAVE & EXIT and press Select to save the settings and return to the SETUP menu.

The Channel Balance menu can also be accessed directly with the bal button [39] on the remote control.

3.3 Channel Delays

For the best surround sound performance it is important that sound from all speakers reach the listener's ears at the same time. Because the surround/rear speakers are usually closer to the listener than the front speakers, there is a tendency for the ear to localize sounds to the rear, because the ear takes most notice of the sounds that arrive at the head first. Similarly, the center speaker is often closer to the listener than the front left and right speakers. To compensate for this, the GTP-860 can slightly delay the audio sent to the center and rear (closer) speakers. In this way, when playing Dolby Digital or Dolby Pro Logic soundtracks, the sound from all speakers arrives uniformly at the listening position as intended by the film's producer.

Each millisecond corresponds approximately with 1 foot or 30.5 centimeters.

To set the center channel delay time:

Call up the SETUP menu of the On Screen Display. Select the Channel Delays menu:

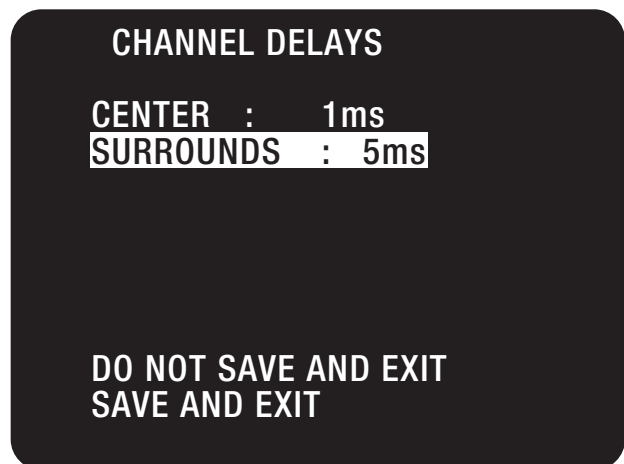

Choose CENTER and select the desired delay time (1, 2, 3, 4 or 5ms).

To set the surround channel delay time:

Use the Up or Down arrow buttons [39] to highlight the Surrounds.

Scroll through the preset delay time options and select the desired time.

When both delays have been entered, choose "SAVE & EXIT" to save the settings and return to the Main Menu.

In Dolby Digital surround mode, the rear channel delay time can be set from 0ms to 15ms with 1ms increments. The center channel can also be delayed up to 5ms, in 1ms steps.

In Dolby Pro Logic surround mode, the rear channel delay time can be set from 15ms to 30ms and 1ms per step.

For other modes including DTS, the channel delay time cannot be adjusted.

Determining Delay Values:

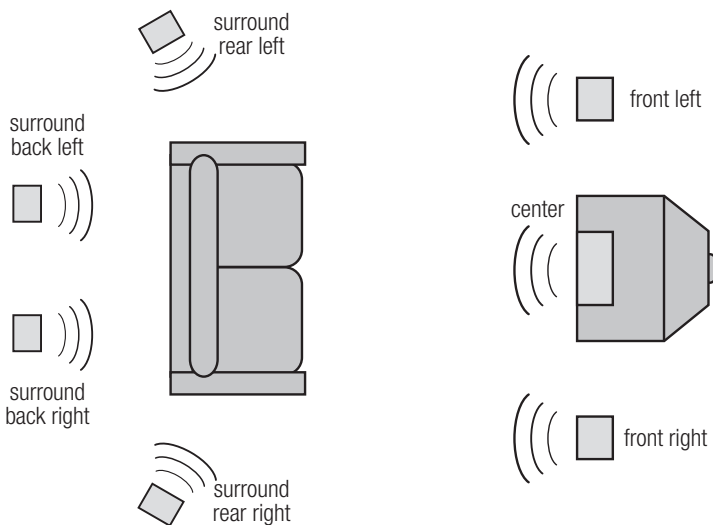

Measure the distance from the listening position to the center speaker and to one of the front speakers. Subtract the center channel distance from the front left or right channel distance. For example, if the front speakers are 12 feet (3.7 m) from the listening position and the center speaker is 10 feet (3.0 m), the difference is 2 feet (0.6 m). For this example the center channel delay is set to 2 milliseconds or ms.

The GTP-860 can delay the center channel output up to 5 milliseconds and thus compensates for center channel speakers that are up to 5 feet (1.5 m) closer to the listening position than the front left and right speakers.

In rare system setups, the center channel speaker is actually further away than the front left and right speakers.

In these cases, set the center channel delay to 0ms. The center channel delay time adjustment is only available in Dolby Digital surround mode.

Now, measure the distance from the listening position to either the left or right rear speaker. Subtract the rear speaker distance from the front speaker distance. The resulting distance is equivalent to the delay in milliseconds for the rear delay setting. For example, if your rear speaker distance is 6 feet (1.8 m) and the front distance is 12 feet (3.7 m), the correct rear channel delay setting is 6 milliseconds. Again, set the rear channel delay to 0ms if the rear channels are further from the listening position than the front speakers.

3.4 Speaker Settings

Four modes are available to the GTP-860's setup: On or Off, and Large or Small.

The On mode is used when the speaker is present. The Off mode is used when a speaker is not present. Front speakers are assumed to be present, so they cannot be turned off. Center, Surround, and Subwoofer speakers are optional, and these are the speakers you must describe to the GTP-860. Audio signals intended for speakers which are not present are redirected to the main speakers.

When a speaker is On, it can be set as Large or Small. The Large mode is used when the speaker is full range and capable of reproducing the entire audible frequency spectrum from 20Hz to 20kHz. The Small mode is used when the speaker is not capable of reproducing the deepest bass portion of the audio frequency 20Hz to 100Hz. When a speaker is set to small, the low frequencies intended for that speaker are redirected either to the Front speakers or the Subwoofer.

For best results, you should consider using a center speaker. Ideally it should be the same type as the left and right speakers. Using a separate center channel speaker will allow the dialogue to cut through even the biggest sound effects and musical scores. Having the sound spread across three front speakers also stabilizes the stereo image, making the usable listening area much bigger.

Installing surround speakers will greatly enhance the surround experience as these add considerably to the overall "ambiance." Dolby Pro Logic encoded material is deliber-

ately limited in dynamic range and frequency bandwidth for the surround channel and thus only requires speakers of far lesser capabilities compared to the front channels. Dolby Digital, however, is a full range system with two independent surround channels and with dynamics equal to that of the front channels. For this reason it is advisable to choose loudspeakers which are similar in power handling and performance capability to those of the front channels. If you are using only one pair of surround speakers, make sure to connect them to the Surround Rear outputs. If you choose to install another pair of surround speakers, locate them behind your listening position, and connect them to the Surround Back outputs. Surround Back channels add to the spaciousness and coherence of the sound field, but the Surround Rear channels must be present for the desired effect.

Many film soundtracks rely heavily on very low frequency sound effects which are difficult for normal or smaller hi-fi speakers to reproduce. To faithfully reproduce these low frequencies you can use a specially designed low frequency loudspeaker with its own built-in amplifier ("active subwoofer"). Because it is difficult to hear which direction very low frequencies are coming from, you only normally need one subwoofer and this can be placed virtually anywhere in the room. Dolby Digital uses a dedicated Low Frequency Effects (LFE) channel. If a subwoofer has been selected, the LFE channel will be fed to the subwoofer output.

First you need to indicate which speakers are present in your system. Besides the Main speakers (Left & Right), these can include a Center, two Surround Speakers and a Subwoofer.

Call up the SETUP menu of the On Screen Display.

Select the SPEAKER SETTINGS.

Highlight PRESET and use the Left and Right arrow buttons to select the preset (PRESET 1, 2 or 3) that best applies to your setup. Select a preset based on speaker sizes, then use the Up and Down arrow buttons to adjust for the absence of Center, Surround speakers, or subwoofer.

Preset 1: Default Setting / Adjustment

Main : LARGE / No Adjustment
Center : LARGE / OFF
Surround : LARGE / OFF
Subwoofer : ON / OFF

In this mode, all speaker channels are large, i.e. full range, and the home theater system has a subwoofer. This preset is particularly useful for large rooms.

Preset 2: Default Setting / Adjustment

Main : LARGE / No Adjustment
Center : SMALL / OFF
Surround : SMALL / OFF
Subwoofer : OFF / ON

This preset is useful for a home theater system that does not have full range speakers. The bass frequencies from the center and surround channels are redirected to the main speakers.

Preset 3: Default Setting / Adjustment

Main : SMALL / No Adjustment
Center : SMALL / OFF
Surround : SMALL / OFF
Subwoofer : ON / No Adjustment

This preset is ideal for those systems using 5 small speakers combined with a subwoofer. The bass frequencies from each of these 5 channels are redirected to the subwoofer.

The Surround settings affect both the Surround Rear and Surround Back speakers.

SPEAKER SETTINGS

PRESET : 1
MAIN : LARGE
CENTER : OFF
SURROUND : LARGE
SUBWOOFER : ON

DO NOT SAVE AND EXIT
SAVE AND EXIT

3.5 Surround Speaker Placement

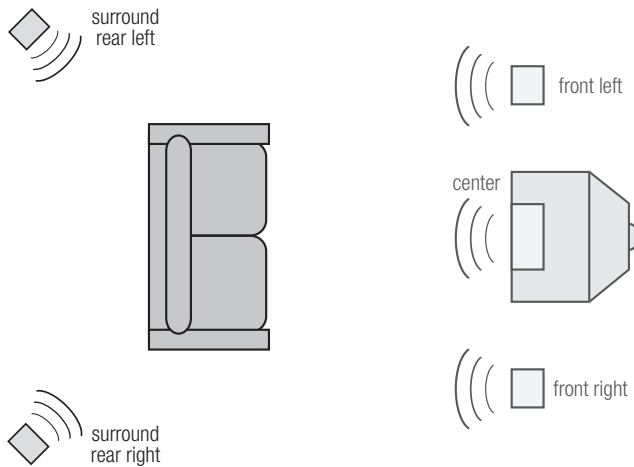

This speaker setting is preferred if you are not using surround backs.

This is the preferred speaker setting if you are using surround backs.

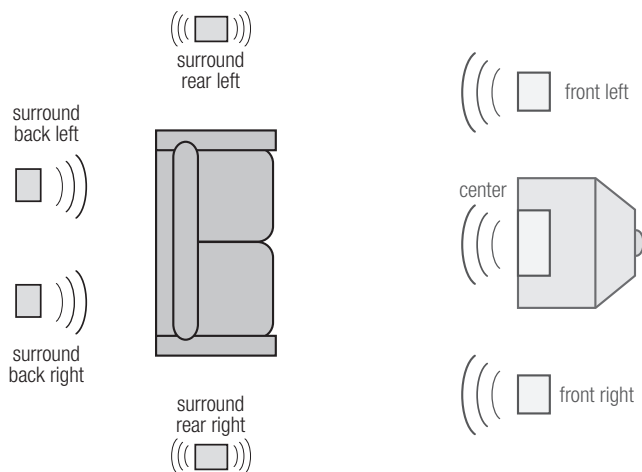
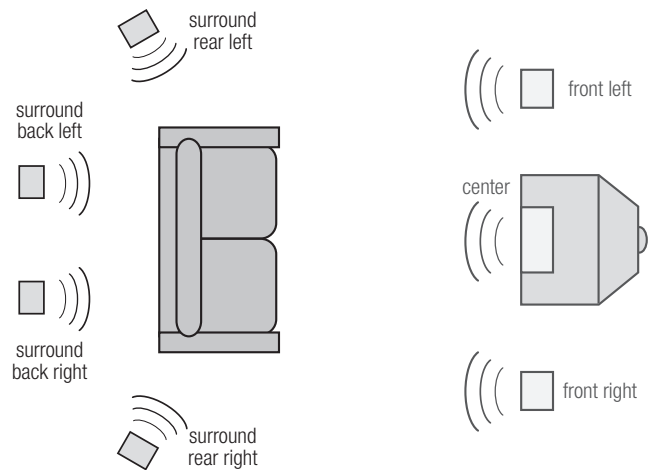

This speaker setting is preferred if you are using dipoles for your surround rears.

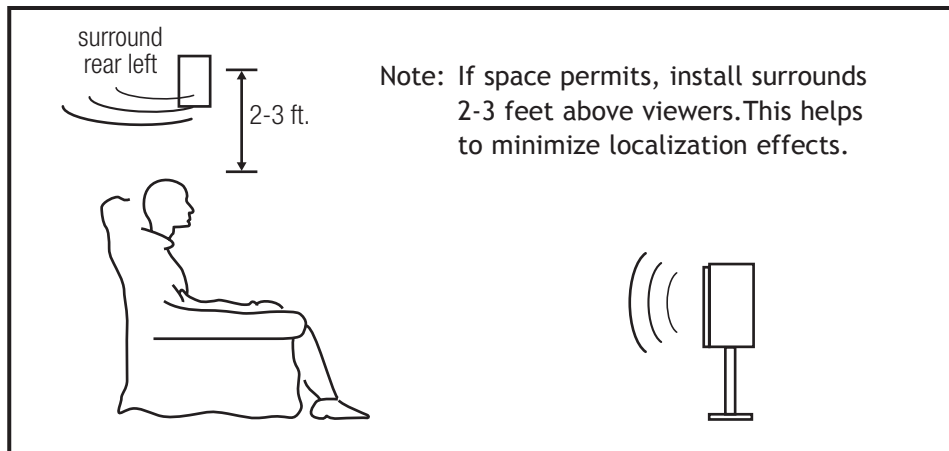

3.6 Input Settings

Input Settings shows information about the current state of operation of the GTP-860, and repeats much of the same information shown on the GTP-860's front panel. This menu should be the only part of the on-screen display you might elect to use regularly after setup is complete, as it allows you to easily see the operating mode from the listening position.

Highlight INPUT SETTINGS in the SETUP menu and press Select on the remote. You will see a screen similar to the following :

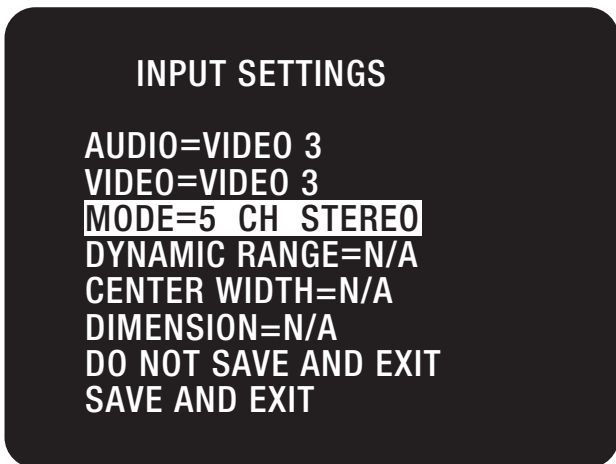

The available choices in each of the fields can be selected with the Left or Right arrow buttons on the remote; confirm the choice with Select button.

AUDIO = identifies the selected audio input

VIDEO = identifies the selected video input

MODE = indicates the surround mode of the selected input (DOLBY DIGITAL, DTS, PRO LOGIC II, HALL, STEREO, and 5 CH STEREO).

DYNAMIC RANGE = indicates the dynamic range currently selected (100%, 75%, 50% and 25%) in Dolby Digital mode only, or N/A for the other modes.

Dimension = This parameter is used when listening in Prologic II Music mode, it changes the level balance from front speakers to back speakers, much the same way the fader adjust works in some car audio systems.

Center Width = This adjustment is used when listening to Prologic II Music Mode. It changes the amount of sound coming out of the center speaker. Adjust this parameter for best over all imaging between the front left/Right and center speaker.

Highlight SAVE & EXIT and press Select to save the altered settings and return to the SETUP menu. Otherwise, select DO NOT SAVE & EXIT to leave without saving any channel.

RESOLVING PROBLEMS

Use the chart on the opposite page to solve common situations that don't require professional attention. If the steps stated in POSSIBLE SOLUTION do not resolve your problem, then please contact your ADCOM Dealer or call the ADCOM Customer Service Department. Any problems not covered here should be brought to the attention of your ADCOM Dealer or ADCOM Customer Service Department.

A special note on "hum:" When there is a low-volume "hum" audible throughout your speakers, even with the main volume turned all the way down, you have a common phenomenon known as a "ground loop." A ground loop is basically a difference in ground voltages between two or more components which are connected electrically and which creates multiple current paths where there must only be one. This difference in potentials creates a 60Hz low-level sound (approximately a low A), that seems to "hum."

It can be caused by adding new components to your system, but that does not imply there is anything electrically wrong with any new component. With the advent of audio/video and home theater systems, the problem has become commonplace. Generally, the cause is the Cable-TV incoming signal line. This new incoming line may add an additional ground at a different potential to the AC line ground of your other equipment (refer to Note 1 and 2, to troubleshoot a hum problem).

Note 1: Cable TV systems can sometimes contribute to ground loop problems which cause "hum." To determine if your cable system is the contributing factor, disconnect the Cable-TV incoming signal line (round, 75Ω) at the wall, or the first component the cable is connected to (i.e. the cable box, or VCR). If the hum is no longer present, you must insert a "75Ω Ground Loop Isolator" before reconnecting the line. You should check with your ADCOM Dealer to obtain one. If the "75Ω Ground Loop Isolator" works only partially or not at all, then please read Note 2 to complete the troubleshooting procedure.

Note 2: Make sure that the power amplifier is at least 6" from the Preamp and/or Processor. Usually putting another component between them is sufficient to minimize the hum. If this does not reduce the hum, turn the system off and disconnect all Inputs from the amplifier. If the hum still persists, then your Dealer or Service Center must examine the amplifier. If the hum disappears, try another set of RCA cables. Connect one RCA cable at a time to see if one specific cable is responsible. If any or all cables cause the hum to appear, then the preamp or processor should be evaluated for proper operation by your Dealer or Authorized Service Center.

Troubleshooting Tip

Your GTP-860's circuitry is built around advanced microprocessors. The GTP-860 may exhibit occasional anomalies arising from AC line surges, etc. If you experience unexpected behavior, or if the GTP-860 "locks up" and does not respond to control input, reset it by turning the front power switch off. (Do not use the remote control's "power" button.) Wait 10 seconds and then turn the GTP-860 on. This will reset the internal control circuitry and solve most problems.

SYMPTOM	POSSIBLE REASON	POSSIBLE SOLUTION
No sound	<ul style="list-style-type: none"> • Power AC lead unplugged or power not switched on • Tape Monitor selected • Mute on • Power Amplifier not on 	<ul style="list-style-type: none"> • Check if AC lead is plugged in and power switched on • De-select Tape Monitor mode • Switch off Mute • Turn on the Power Amplifier
No sound on one channel	<ul style="list-style-type: none"> • Speaker not properly connected or damaged. • Input lead disconnected or damaged • In Setup "OFF" for surround speaker selected 	<ul style="list-style-type: none"> • Check connections and speakers • Check leads and connections • Select appropriate Surround mode (large or small)
No sound on surround channels	<ul style="list-style-type: none"> • No surround mode selected • Mono sound source • Speakers not properly connected • Surround volume level too low 	<ul style="list-style-type: none"> • Select a Surround Mode • Test system with Stereo or Dolby Surround material • Check speakers and connections • Increase surround volume level
No sound on center channel	<ul style="list-style-type: none"> • In Setup "OFF" for center speaker selected • Speaker not connected properly • Center volume level set too low 	<ul style="list-style-type: none"> • Select appropriate Center mode (large or small) • Check speaker and connection • Increase center volume level
"Dolby Digital" OR "DTS" auto-detection function does not work	<ul style="list-style-type: none"> • Source not connected using digital input • Bit Stream is PCM 	<ul style="list-style-type: none"> • Connect digital output of source to GTP-860 • Check source material
Weak bass/Diffuse stereo image	<ul style="list-style-type: none"> • Speakers wired out of phase 	<ul style="list-style-type: none"> • Check connections to all speakers in the system
Remote control handset not working	<ul style="list-style-type: none"> • Batteries dead, or incorrectly inserted • IR transmitter or receiver windows obstructed • IR receiver in direct sun or very bright ambient light 	<ul style="list-style-type: none"> • Check or replace batteries • Remove obstruction • Place unit away from direct sun, reduce amount of ambient light
No sound with tuner	<ul style="list-style-type: none"> • Antenna leads incorrectly connected • Station not selected or weak signal with FM Mute on. 	<ul style="list-style-type: none"> • Check antenna connections to preamplifier • Re-tune or switch off FM Mute
Noise, hiss on AM and FM	<ul style="list-style-type: none"> • Weak signal 	<ul style="list-style-type: none"> • Check station tuning. Adjust or replace antenna.
Distortion on FM	<ul style="list-style-type: none"> • Multi-path signals or interference from another station 	<ul style="list-style-type: none"> • Check station tuning. Adjust or replace antenna
Whistles or buzzes on FM & AM	<ul style="list-style-type: none"> • Interference from other electrical sources - computers, games consoles 	<ul style="list-style-type: none"> • Check station tuning. Switch off or move the source of the electrical noise
Whistles or buzzes on AM	<ul style="list-style-type: none"> • Interference from fluorescent lighting or electrical motor 	<ul style="list-style-type: none"> • Check station tuning. Adjust or replace AM antenna
No RDS name (PS)	<ul style="list-style-type: none"> • Station signal too weak. • Station not transmitting RDS data 	<ul style="list-style-type: none"> • Check station tuning. Adjust or replace antenna • No remedy

CARING FOR YOUR GTP-860

Great care has been taken by ADCOM to ensure that your amplifier is as flawless in appearance as it is electronically. The front panel is a heavy-gauge, high-grade aluminum extrusion carefully finished and anodized for durability. The chassis, top cover and rear panel are heavy-gauge steel that has been powder coated and baked to ensure a lasting finish. If the front panel, top or sides become dusty or fingerprinted, they can be cleaned with a soft lint-free cloth, slightly dampened with a very mild detergent solution or glass cleaner.

Do not spray or pour liquids of any kind directly onto the GTP-860.

SERVICING

ADCOM has a Technical Service Department to answer questions pertinent to the installation and operation of your unit. In the event of difficulty, please contact us for prompt advice. If your problem cannot be resolved through our combined efforts, we may refer you to an authorized repair agency, or authorize return of the unit to our factory. To aid us in directing you to a convenient service center, it would be helpful if you indicate which major city is accessible to your home.

Please address mail inquires to:

**ADCOM Service
8551 East Anderson Drive, Suite 105
Scottsdale, Arizona 85255 USA**

Phone, Fax or Email inquires to:

**Voice: (480) 607-2277
Fax: (480) 348-9876
Monday through Friday
9:00 AM to 5:00 PM MST
Email: service@adcom.com**

For Fax inquires, please include a return Fax number for the reply. When calling or writing about your ADCOM product, be sure to note and refer to its serial number as well as the date of purchase and the dealer from whom it was purchased. In any communications to us, please include a daytime phone number where we may reach you. In the event the unit must be returned to our factory for service, you will be instructed on the proper procedure when you call or write for a Return Authorization. **UNDER NO CIRCUMSTANCES SHOULD YOUR UNIT BE SHIPPED TO OUR FACTORY WITHOUT PRIOR AUTHORIZATION, OR PACKED IN OTHER THAN ITS ORIGINAL CARTON AND FILLERS.**

If the original shipping carton and its fillers have been lost, discarded, or damaged, a duplicate carton may be obtained from our Service Department for a nominal charge.

Always ship PREPAID VIA UNITED PARCEL SERVICE (UPS) OR OTHER APPROVED CARRIER. DO NOT SHIP VIA PARCEL POST, since the packing was not designed to withstand rough Parcel Post handling.

**FREIGHT COLLECT SHIPMENTS WILL NOT BE ACCEPTED
UNDER ANY CIRCUMSTANCES.**

GTP-860 SPECIFICATIONS

Input Impedance

Audio	50k Ω
Video	75 Ω

Output Impedance

Audio	320 Ω
Video	75 Ω

Frequency Response

20Hz to 20kHz	± 0.5 dB
---------------------	--------------

THD+Noise at Rated Output

20Hz to 20kHz	$\leq 0.01\%$
---------------------	---------------

IM Distortion

CCIF at 15kHz and 16kHz	$\geq 0.009\%$
-------------------------------	----------------

Signal to Noise Ratio (at 1kHz "A" weighted)

Ref. to 1V input, max output voltage	> 95 dB
--	-----------

Sensitivity 1 volt output	220mV
---------------------------------	-------

Subwoofer Crossover Frequency	100Hz
-------------------------------------	-------

Crosstalk (@ 1kHz)	> 80 dB
--------------------------	-----------

Maximum Output Voltage	4.6V
------------------------------	------

Tone Controls (L and R front only)

Bass effective below	200Hz
----------------------------	-------

Bass Max Gain/Cut	± 10 dB @ 20Hz
-------------------------	--------------------

Treble effective above	6.3kHz
------------------------------	--------

Treble Max Gain/Cut	± 10 dB @ 20Hz
---------------------------	--------------------

FM Tuner

Usable Mono Sensitivity	15dB μ
-------------------------------	------------

50 dB Mono Quieting Sensitivity	22dB μ
---------------------------------------	------------

50 dB Stereo Quieting Sensitivity	39dB μ
---	------------

A-wtd. Signal to Noise Ratio

Mono	75dB
------------	------

Stereo	70dB
--------------	------

Stereo Separation (1 kHz)	43dB
---------------------------------	------

Alternate Channel Selectivity	> 50 dB
-------------------------------------	-----------

Capture Ratio	2dB
---------------------	-----

General

Power (user selectable 120/230 VAC)	120VAC/50-60Hz
---	----------------

Chassis Dimension	5 ³ / ₁₆ " (132mm) x 17" (432mm) x 13 ³ / ₄ " (349mm)
-------------------------	---

Maximum Dimensions	5 ⁶ / ₁₆ " (137mm) x 17" (432mm) x 15" (381mm)
--------------------------	--

Weight	20 lbs. (9.1kg)
--------------	-----------------

Weight, Packed	23 lbs. (10.4kg)
----------------------	------------------

ADCOM

A division of Klein Technology Group, LLC
8551 East Anderson Drive, Suite 105
Scottsdale, Arizona 85255
Voice: (480) 607-2277
Fax: (480) 348-9876
<http://www.adcom.com>

GTP860_manual_v1

Free Manuals Download Website

<http://myh66.com>

<http://usermanuals.us>

<http://www.somanuals.com>

<http://www.4manuals.cc>

<http://www.manual-lib.com>

<http://www.404manual.com>

<http://www.luxmanual.com>

<http://aubethermostatmanual.com>

Golf course search by state

<http://golfingnear.com>

Email search by domain

<http://emailbydomain.com>

Auto manuals search

<http://auto.somanuals.com>

TV manuals search

<http://tv.somanuals.com>