



2-CHANNEL BALANCED AMPLIFIER SYSTEM

OWNER'S MANUAL

GFA-5225

GFA-5250

GFA-5275

IF YOU READ NOTHING ELSE, PLEASE READ THIS PAGE:

① **INSTALLATION ADVISORY:** *Be sure to connect the POWER(+) and GROUND(-) correctly!! Amplifiers that are incorrectly connected are not covered by the warranty.*

② **INSTALLATION ADVISORY:** *It is possible for clipped strands of wire to enter the amplifier through the Free-Flow perforated sleeve. Be sure to clip wires well away from the amplifier to avoid this possibility*

③ **INSTALLATION ADVISORY:** *The GFI-5200 Balanced Line driver needs to be placed as close to the source unit as possible. The complete "Balanced Line System" will operate properly ONLY when the GFI-5200 is installed correctly.*

④ **OPERATION ADVISORY:** *Make sure the two sensitivity controls on the amplifiers are set fully clockwise. When matching the output of the source unit with the input of the amplifier, adjust the level controls on the GFI-5200 instead of the amplifier.*

⑤ **OPERATION ADVISORY:** *Even though Adcom amplifiers are capable of driving very low impedances, it is recommended that the configuration not be lower than 1 Ω stereo, or 2 Ω Mono. This will ensure that you receive optimum power and control, lowest distortion and greatest reliability.*

⑥ **OPERATION ADVISORY:** *If you are using this amplifier with a GFI-4600 crossover, then please see the "Connecting the GFI-4600" section on page 8.*

ADCOM[®] *car audio* OWNER'S MANUAL

Congratulations! Thank you for choosing ADCOM Car Audio components for your mobile audio needs. Your ADCOM Car Audio Balanced Amplifier System uses superior engineering principles and the highest quality components to provide a musical experience with clarity and dynamics *never* before achieved in a vehicle.

PLEASE read this manual entirely before attempting to install this system. Due to the sophisticated nature of this equipment, we highly recommend an authorized ADCOM Car Audio Dealer perform the installation to achieve the maximum performance from your mobile sound system! Your warranty is affected if you choose to install your ADCOM amplifier yourself. You will receive all the benefits of the limited warranty only if the amplifier is professionally installed by an authorized ADCOM Car Audio Dealer! Please refer to your warranty card for details.

TABLE OF CONTENTS:

THE BALANCED CONCEPT	2
CARTON CONTENTS	2
UNPACKING	2
CARE AND CLEANING	3
FAN AND LED OPERATION	3
MOUNTING	
The Amplifiers	3
The Balanced Line Driver	3
CONNECTING THE POWER	
The Amplifiers	4
The Balanced Line Driver	4
INPUT SENSITIVITY SETTINGS.....	5
SPEAKER CONNECTIONS.....	6
UNBALANCED OPERATION	7
CONNECTING THE SYSTEM	
Connecting the GFI-4600 Crossover	8
Connecting Other Brands of Balanced Equipment	8
DIAGRAM 9: Multi-Amp system with a GFI-4600 and GFY-2B	9
DIAGRAM 10: Multi-Amp system with Dual GFI-4600's	10
TROUBLESHOOTING	11
SPECIFICATIONS	12
ADAPTER CABLES.....	13
SERVICING	14

THE BALANCED CONCEPT:

The advantage of a balanced line system is simple: Noise reduction. Any noise that is induced into the signal path is automatically canceled at the input of the amplifier. Therefore, induced noise is no longer a problem or concern for car audio installers. In order to have a "balanced" system, you need 3 items:

- 1: a Balanced Line Driver (GFI-5200).
- 2: a Balanced-type Cable (*two pairs* of RCA cables).
- 3: a Balanced Amplifier (GFA-5225, GFA-5250 or GFA-5275).

If we follow the signal from the source (CD, Tape deck), to the amp, we can see exactly how a Balanced Line System works.

As the signal exits the source unit, it is converted to a balanced signal by the GFI-5200. It is then transmitted through the cables (two pairs of RCA cables) to the balanced amplifier. If, while the signal is being transmitted, it picks up any induced noise, it will travel *with the original signal* to the input of the amplifier. The amplifier's differential input will ignore the noise that was added, and only amplify the original signal.

CARTON CONTENTS:

The Adcom GFA-5225, GFA-5250 and GFA-5275 amplifiers are shipped from the factory with the GFI-5200 2-channel Balanced Line Driver.

Also included with your Balanced System is a fuse holder with an appropriately sized fuse. For proper connection of the fuse, see the CONNECTING POWER section. There should also be a Warranty Registration card included. Fill this out and drop it in the mail; there is no postage needed. Even though you send in the Warranty card, you should *always* keep your original sales receipt for proof of purchase date.

UNPACKING:

Be sure to verify that the serial number printed on the bottom of the amplifier is the same as the serial number on the carton. If either number is missing or altered, you should contact ADCOM immediately at (908) 390-1130. Before each ADCOM Car Amplifier System leaves our facility in New Jersey, it is carefully inspected for physical imperfections and electrical performance as a routine part of ADCOM's Quality Assurance system. This is to ensure flawless performance and appearance when you receive it.

After you have unpacked your amplifier, inspect it for physical damage. In the unlikely event that damage has occurred during shipping, a freight claim to cover shipping damage can be initiated. **THE RIGHT TO CLAIM AGAINST A PUBLIC CARRIER CAN BE FORFEITED IF THE CARRIER IS NOT NOTIFIED PROMPTLY AND IF THE SHIPPING CARTON AND PACKING MATERIAL ARE NOT AVAILABLE FOR INSPECTION. SAVE ALL PACKING MATERIAL UNTIL THE CLAIM HAS BEEN SETTLED.**

CARE AND CLEANING:

Great care has been taken by ADCOM to assure that your amplifier and line driver are as flawless in appearance as they are electrically. In the event that your ADCOM components needs cleaning, use a damp cloth or dry, soft bristled paint brush. Do not use cleaning fluids of any kind, as damage to the finish may result. Treat these products as precision instruments, and they will provide you with many years of musical enjoyment.

FAN AND LED OPERATION:

The thermostatically controlled fan will begin operation almost immediately upon turn-on. It will create an air flow through the heat sink. As the temperature of the heat-sink rises, the fan will increase in velocity. In the unlikely event that the amplifier thermally shuts down, the fan will continue to operate, cooling the heat sink. The amplifier will turn itself back on once the temperature drops into normal operating range.

Adcom amplifiers all have LED indicators behind the free-flow chassis vents where they can easily be seen. On each amplifier there is 1 green LED on the power supply side (on the same side as the power connections), this represents the power supply, and 2 green LEDs on the amplifier (same side as the RCA connectors) side which represent the 2 channels of amplification. Both amplifiers have a red LED on the power supply side which will only light if there is some sort of problem. See the troubleshooting section in the rear of the manual to determine the source of the problem.

MOUNTING:

The GFA-5225, GFA-5250 and GFA-5275 Amplifiers

All components should be securely mounted, as they could become airborne in the event of a collision; serious injury could occur. ADCOM Car Audio amplifiers may be mounted almost anywhere; every model is fan-cooled, so mounting possibilities are limited only by your imagination. Follow these simple guidelines to ensure long life, cosmetic integrity and sonic dependability: 1. Always securely mount the component to a flat surface using all mounting holes. 2. Never mount an audio component where loose objects can come in contact with it. 3. Never mount an amplifier under a rug, mat or carpet. Remember, the better the ventilation, the cooler your amp will run!

When mounting, do not use the amplifier as a drilling template. Use as a marking template, only. When mounting an amplifier, use only Pan-Head screws, not beveled head, and **DO NOT OVER-TIGHTEN!**



The GFI-5200 Balanced Line Driver

CRITICAL: ALWAYS MOUNT THE BALANCED LINE DRIVER AS CLOSE TO THE SOURCE UNIT AS POSSIBLE. In order to utilize the advantages of a balanced line, the signal needs to be converted from unbalanced to balanced as soon as possible. The size of the GFI unit enables it to be easily mounted in or

under the dash. The RCA input cables on the GFI-5200 are long enough to plug directly into the source unit. No extra cables should be added to this length. This will ensure that the signal is converted to balanced as close to the source unit as possible.

When mounting the GFI unit, it is preferred to attach it with both screw holes. You can, however, use only one of the holes to secure it. There will be situations where it will be impractical to secure the GFI unit with screws. In these cases, you can use wire-ties or similar mounting techniques to conceal the unit behind the dash.

CONNECTING POWER:

ADCOM amplifiers and line-drivers are designed to be used with 12 Volt, negative-ground vehicles. The first step is to *disconnect the Ground(-) connection to the vehicle's battery terminal!*

Powering The GFA-5225, GFA-5250 and GFA-5275 Amplifiers

The positive and negative gold-plated power connectors will accommodate up to 6AWG wire. All ground connections should be as short as practically possible and terminated at the same location. When the main power cable passes through a metal wall, a grommet must be used to prevent the wire from chafing and shorting to ground. See Fig. 1 for single-amp installation.

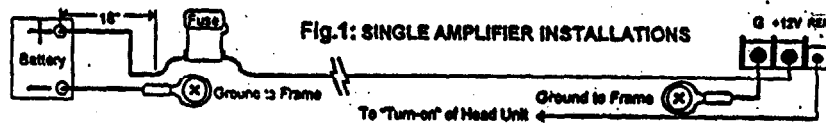

If multiple amps are to be installed, heavier gauge power/ground cables may be required. For multi-amp systems follow Fig. 2. If a fuse blows, replace it **ONLY** with an identical amperage and type fuse!

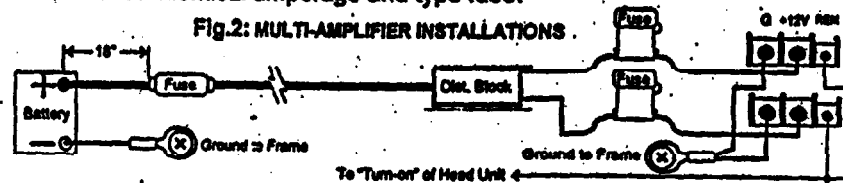

Connect the REM terminal on the amplifier to the source unit's turn-on, power antenna, or remote lead. When the source is turned on, it supplies 12 volts to the REM, which turns the amplifier(s) on. If your amp does not turn on, check this connection.

Powering The GFI-5200 Balanced Line Driver

See Fig. 3 for connecting the GFI power and ground. When you use the accessory wire, the GFI will turn on and off when you turn the ignition key. This reduces the turn-on transients that can occur with line-drivers.

INPUT SENSITIVITY SETTING:

Located on the amplifier end-panel, along with the input connectors, are two small openings that allow access to the *input sensitivity controls*. These controls are shipped from the factory in the *Full-On (clockwise)* position. The sensitivity controls on the amplifier should always be kept *FULL* when used in a balanced system. These controls should be adjusted *ONLY* when you are using the amplifier in an unbalanced mode (see *Unbalanced Operation*). If there is a need to adjust these controls, use a flat-head screwdriver no wider than $\frac{1}{8}$ inch (and $\frac{1}{32}$ inch thick). These controls should move freely, do not force or apply excessive pressure to adjust them.

To adjust the sensitivity of the *BALANCED SYSTEM*, use the level controls on the *GFI unit* instead of the amplifier. To set the input, start by turning input level controls all the way down (*counter-clockwise*). Turn up the volume on your head unit to approximately 75% of full volume. Start to increase the GFI's input controls until you hear distortion. At that point, turn down the input controls *slightly* until you don't hear the distortion. The inputs levels are now set.

STEREO CONFIGURATION:

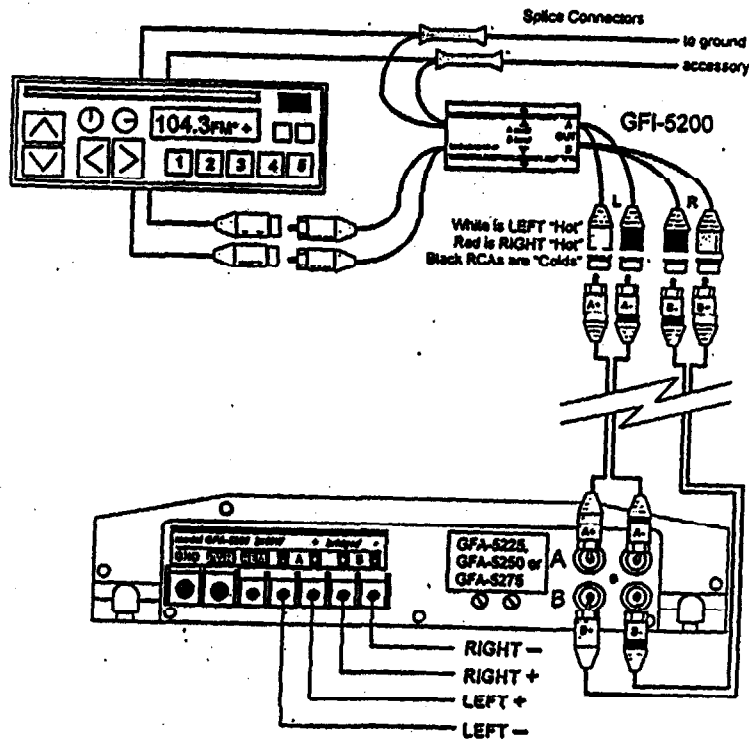

Fig. 3

SPEAKER CONNECTIONS:

ADCOM uses gold-plated speaker connectors that will accommodate up to 8AWG speaker wire. Be sure there are no frayed or loose wire strands that may end up touching other wires.

Any number of speakers may be used with your ADCOM Car Audio amplifier. The "system impedance" is dependent on the wiring configuration and selection of speakers. Although ADCOM amplifiers are stable into loads of less than $\frac{1}{2}\Omega$, continuous operation into impedances lower than 2Ω may eventually lead to thermal overload, causing the amplifier to shut down. Your authorized ADCOM Car Audio dealer is best able to maximize the performance of your system by calculating impedance, and ensuring the proper connection of all system components.

Adcom 2-channel amps can be configured for stereo or mono. They can also be run in stereo and mono simultaneously (which we call AutoMoSt™). Fig. 3 shows a standard speaker configuration for stereo. Fig. 4 is a wiring diagram for mono configuration, and Fig. 5 shows an AutoMoSt™ configuration.

MONO CONFIGURATION:

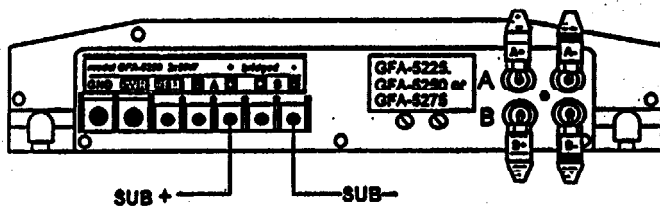

Fig. 4

AutoMoSt CONFIGURATION:

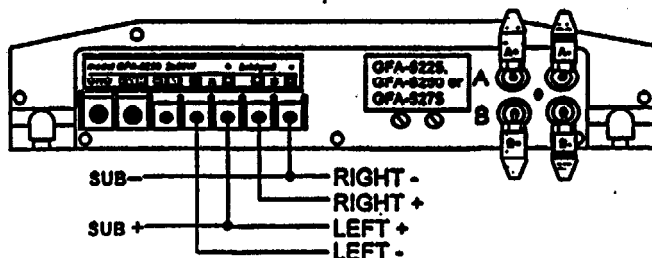

Fig. 5

UNBALANCED OPERATION:

DO NOT RUN THESE AMPS UNBALANCED UNLESS THERE IS NO ALTERNATIVE. The only time that this situation would come into play is if you were utilizing an equalizer or other signal-processor and could not mount it in the *front* of the vehicle. If the amplifier is used without the GFI-5200 you will need to use the supplied RCA Shorting Plugs (see Fig. 6). Since the GFI-5200 can provide a balanced signal with up to 18 volts of output, please be sure that if you omit the GFI-5200, that the EQ or signal processor is capable of delivering at least 2-volts of output.

If the signal processor is mounted in the front of the vehicle, then you can run the GFA-5000 amplifier in a balanced mode with the included GFI-5200. This is the preferred way to install a signal processor with the Adcom Balanced amplifiers. Refer for Fig. 8 for a basic wiring diagram.

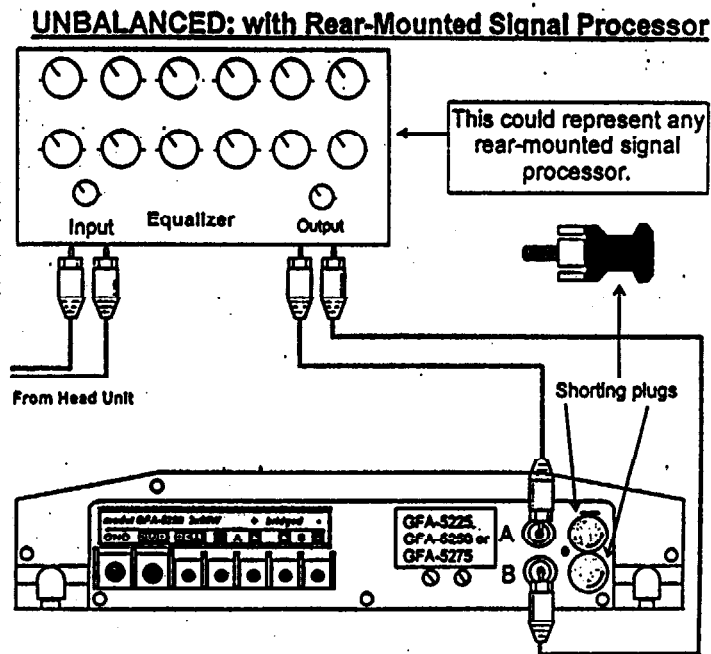

Fig. 6

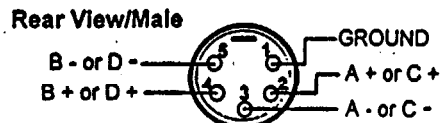

Fig. 7

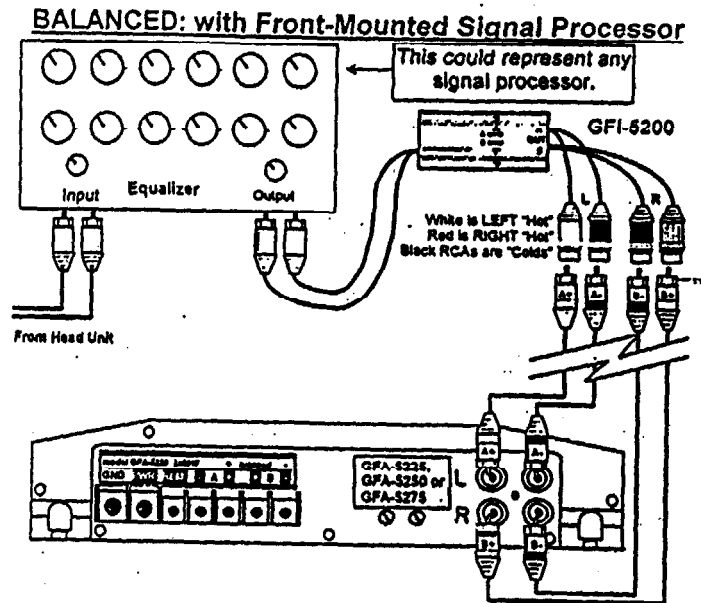

Fig. 8

Connecting The GFI-4600 Balanced Crossover/Driver

Adcom offers the GFI-4600 which is a 4-Channel, 2-Way Crossover that is also a Balanced Line Driver. It changes an unbalanced RCA signal to a balanced, XLR signal. If you are incorporating the GFI-4600 into your system, you will not need to use the GFI-5200, you will need a GFY-2B adapter cable. See Fig. 9 or Fig. 10

When using the GFI-4600 with 5000-series, 2-channel amplifier, The GFI-4600 owner's manual can be used for installation and configuration with 1 important exception: The polarity pin jumpers referred to in the "configuration" section are not to be used when bridging a 5000-series amp because of the AutoMoSt circuitry. Make sure the pin jumpers are all in the same position (all are high, or all are low).

Connecting other brands of Balanced Equipment

As more and more manufacturers are realizing the benefits of using balanced lines in the car audio environment, more processors, EQs, crossovers and even head units with balanced line capabilities have become available. As there is no standard in the industry for balanced line signals, the connectors and wiring configuration can vary greatly from brand to brand.

Compatibility among different brands of true balanced line components is possible. Whenever compatibility is in question, consult the other manufacturer and Adcom to determine the steps needed to match components. Fig. 7 shows the wiring diagram for XLR pin configuration in Adcom components.

Multi Amp System with GFI-4600 using a GFY-2B

SPECIAL NOTE ON GFI-4600: Make sure all of the Polarity Pin Jumpers are in the SAME position. There is no need to invert polarity for the 5000-Series Amps.

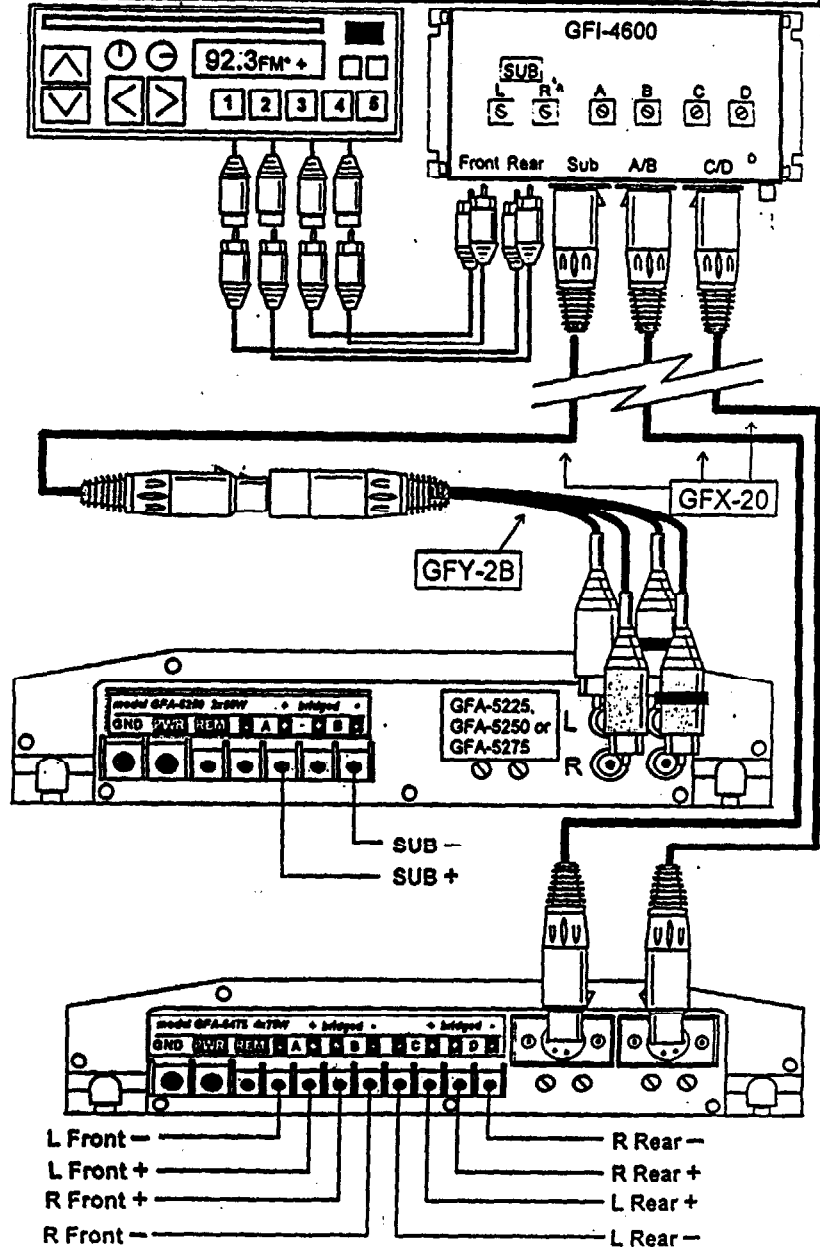

Fig. 9

Dual GFI-4600 / 2-channel 3-way system

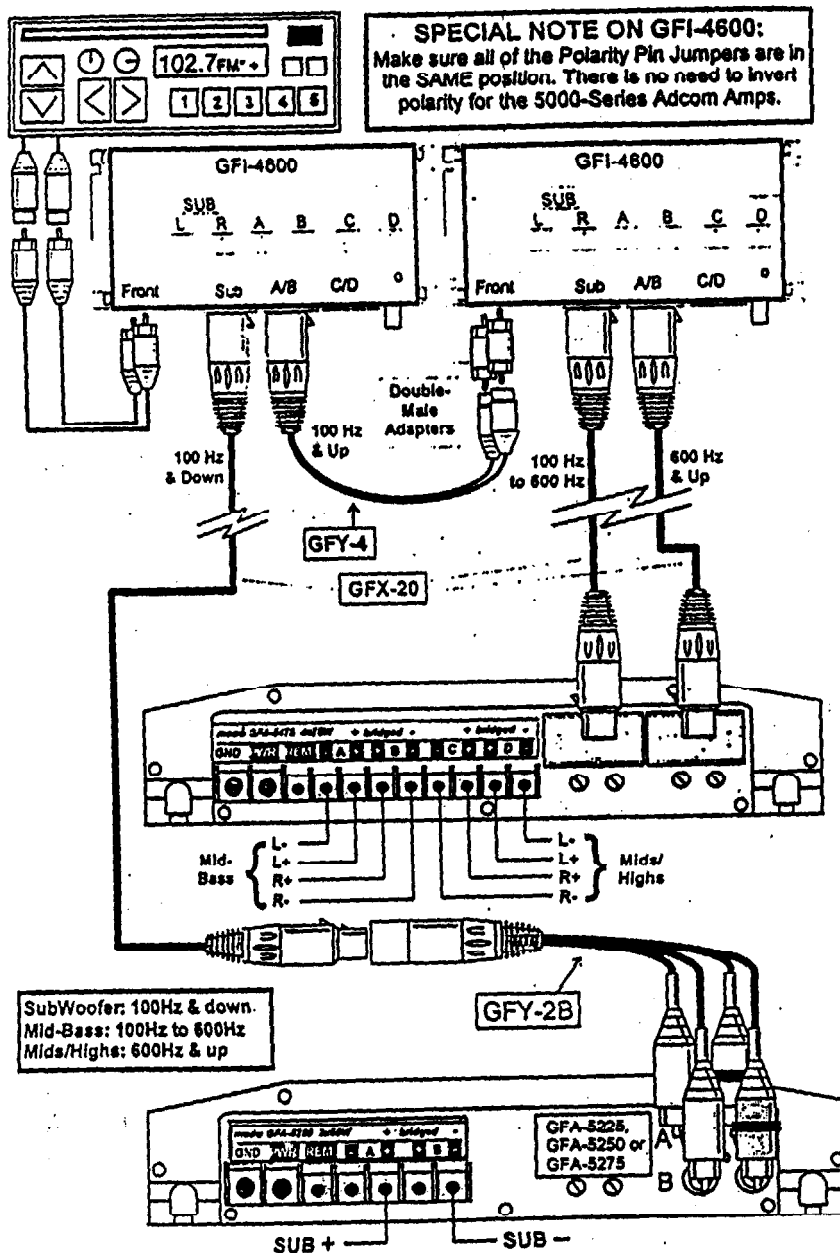

Fig. 10

TROUBLESHOOTING

It is beyond the scope of this manual to be able to cover *all* problems and solutions. If this table does not help to solve the problem, contact your dealer or the Adcom Technical Service Department for further advice.

Since the Balanced Line system eliminates induced engine noise and ground-loop potentials between the GFI-5200 and the amplifier, engine noise problems can usually be tracked down to the component(s) prior to the GFI unit.

You will need 4 RCA "shorting plugs" and an ohmmeter (or continuity tester) for some operations.

SYMPTOM	PROBABLE CAUSE(S)	POSSIBLE SOLUTION
Alternator Whine	<ul style="list-style-type: none"> ✦ Ground loop. ✦ Noise is entering through power wires of head unit. 	<ul style="list-style-type: none"> ✦ Disconnect RCA inputs to the GFI-5400 and plug the shorting plugs into the GFI inputs. If the noise remains, contact your Adcom Dealer or Adcom. ✦ If the noise goes away, the problem is not in the Balanced System and is probably "upstream" of the GFI. Try a "Noise Filter" on the power and/or the memory lead of the upstream units.
Loud squealing noise	<ul style="list-style-type: none"> ✦ Loss of a signal-ground 	<ul style="list-style-type: none"> ✦ Check to make sure all signal connections are tight. ✦ Disconnect everything and re-connect it ONE component or cable at a time. Turn the system on after each new connection. When noise appears, the item just added is the culprit.
No Bass or Weak Bass	<ul style="list-style-type: none"> ✦ One speaker or channel is out-of-phase 	<ul style="list-style-type: none"> ✦ Check speaker wire connections (both ends). Make sure "+" to "+", "-" to "-". ✦ If you are using a GFI-4600; make sure no polarity jumpers are out of phase.
Amplifier "Thermals" Easily	<ul style="list-style-type: none"> ✦ Shorted speaker wire. ✦ Load is too low. ✦ Amp is mounted incorrectly. 	<ul style="list-style-type: none"> ✦ Check speaker wires for shorts between leads, or shorts to ground. ✦ Disconnect speakers and measure DC resistance of speakers leads. ✦ Make sure fan is not obstructed, or amp is not in too small of a space.
No Sound. No LEDs lit in amp.	<ul style="list-style-type: none"> ✦ Loss of power to amp 	<ul style="list-style-type: none"> ✦ Check PWR, GND and especially REM connections. ✦ Check all fuses.
No Sound. All LEDs are lit in amp.	<ul style="list-style-type: none"> ✦ Signal not reaching amp. ✦ Loose speaker connections. 	<ul style="list-style-type: none"> ✦ Check signal path from head unit to amp. ✦ Check speakers, speaker wire and connections for integrity and continuity.
No Sound. 1 Red & 1 green LED lit in amp.	<ul style="list-style-type: none"> ✦ Thermal shutdown ✦ Fault. 	<ul style="list-style-type: none"> ✦ Let amp cool. It will reset. ✦ Contact your Adcom Dealer or Adcom Technical Service Dept.

SPECIFICATIONS:

<i>specification</i>	GFA-5225	GFA-5250	GFA-5275
4 Ω Output, both channels driven	25 Watts X 2 Typically <0.075% THD	50 Watts X 2 Typically <0.075% THD	75 Watts X 2 Typically <0.075% THD
2 Ω Output, both channels driven	50 Watts X 2 Typically <0.075% THD	90 Watts X 2 Typically <0.075% THD	150 Watts X 2 Typically <0.075% THD
4 Ω Output MONO	100 Watts Typically <0.075% THD	180 Watts Typically <0.075% THD	300 Watts Typically <0.075% THD
Frequency Response	5Hz - 20kHz +0dB, -1dB	5Hz - 20kHz +0dB, -1dB	5Hz - 20kHz +0dB, -1dB
S/N ("A" weight)	> 100 dB	> 100 dB	> 100 dB
Input Impedance	13.8k Ω Balanced	13.8k Ω Balanced	13.8k Ω Balanced
Input Sensitivity	875mV for Rated 220mV with GFI	875mV for Rated 220mV with GFI	875mV for Rated 220mV with GFI
Power Supply Capacitance	,000 uF	,000 uF	,000 uF
Operating Voltage	10 Vdc to 15 Vdc	10 Vdc to 15 Vdc	10 Vdc to 15 Vdc
Idle Current	Amps	Amps	Amps
Fuse Size	20 Amp ATC	25 Amp ATC	30 Amp ATC
Net Weight	lbs (kg)	lbs (kg)	8 lbs (3.6kg)
Shipping Weight	8 lbs (3.7kg)	8 lbs (3.7kg)	10 lbs (4.6kg)
Chassis Dimensions	9.75 x 10.75 x 2.3 W" x L" x H"	9.75 x 10.75 x 2.3 W" x L" x H"	9.75 x 12.75 x 2.3 W" x L" x H"

<i>specification</i>	GFI-5200
Max Output Level	18 Volts
Max Input Level	4 Volts
Input Sens. for 1V Out	250 mV
Input Impedance	49k Ω
Frequency Response	20Hz - 20kHz +0dB, -0.25dB
Gain	12 dB
THD @ Rated Output	< 0.05% 20-20kHz
S/N ("A" weighted)	> 98 dB (ref. = 1V)
Current Drain	< 100 mA
Inline Fuse Size	250 mA
Weight	6.2 oz. (176g)
Chassis Dimensions	1.125 x 2 x 4.125 H" x W" x L"

5000-SERIES ADAPTERS

GFY-2

APPLICATION: Use to connect GFI-4600 output (via GFX-2.5 or 20) to a non-Adcom RCA amplifier

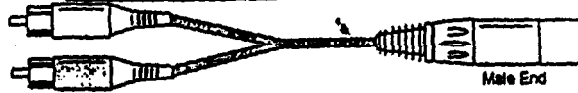

GFY-2B

APPLICATION: Use to connect GFI-4600 output (via GFX-2.5 or 20) to ADCOM RCA-type Amps in balanced mode

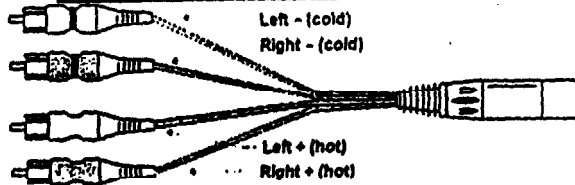

GFY-4

APPLICATION: Converts XLR input on ADCOM XLR-type Amps to RCA input

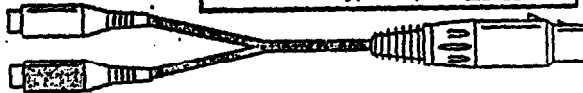

GFY-55

APPLICATION: Converts a 4-channel ADCOM amp to a Bridged 2-channel amp when using a GFI-4600 (via GFX-20)



GFX-2.5

APPLICATION: Transmits 2 balanced channels from Interface to Amplifier

GFX-20



WARNING: JUST BECAUSE AN ADAPTER PHYSICALLY FITS AN APPLICATION, THIS DOES NOT IMPLY THAT IT "FITS" ELECTRICALLY. PLEASE CONTACT ADCOM TECHNICAL SERVICE FOR ANY APPLICATIONS NOT LISTED.

SERVICING:

Adcom has a Technical Service Department to answer questions pertinent to the installation and operation of your system. In the event of difficulty, please contact your dealer or us for prompt service. If your problem cannot be resolved through our combined efforts, we may refer you to an authorized repair agency, or authorize return of the unit to our factory.

Please address mail inquiries to:
ADCOM Service Corp.
11 Elkins Road
E. Brunswick, NJ 08816
U.S.A.

Phone/Fax inquiries to:
Voice: (908) 390-1130
Fax: (908) 390-9152
Monday through Friday
9:00AM to 5:00PM Eastern.
After 6/97 use area code (972)

UNDER NO CIRCUMSTANCES SHOULD YOUR UNIT BE SHIPPED TO OUR FACTORY WITHOUT PRIOR AUTHORIZATION, OR PACKED IN OTHER THAN IT'S ORIGINAL CARTON AND FILLERS, ALWAYS CALL ADCOM'S SERVICE DEPARTMENT TO RECEIVE A RETURN AUTHORIZATION NUMBER!



11 Elkins Road
E. Brunswick, NJ 08816
Phone (908) 390-1130
Fax (908) 390-9152

Copyright 1997
©Adcom Car Audio, Inc.
All Rights Reserved

djg397

Free Manuals Download Website

<http://myh66.com>

<http://usermanuals.us>

<http://www.somanuals.com>

<http://www.4manuals.cc>

<http://www.manual-lib.com>

<http://www.404manual.com>

<http://www.luxmanual.com>

<http://aubethermostatmanual.com>

Golf course search by state

<http://golfingnear.com>

Email search by domain

<http://emailbydomain.com>

Auto manuals search

<http://auto.somanuals.com>

TV manuals search

<http://tv.somanuals.com>