

Panasonic®

Palmcorder®

Camcorder

Operating Instructions



VHS

PV-D427

Please read these instructions carefully before attempting to operate this product and save this manual.

Spanish Quick Use Guide is included.

Guía para rápida consulta en español está incluida.

VQTW0630 ©

Things You Should Know

Thank you for choosing Panasonic!

You have purchased one of the most sophisticated and reliable products on the market today. Used properly, it will bring you years of enjoyment. Please take time to fill in the information at right. The serial number is on the tag located on the underside of your Palmcorder. Be sure to **retain this manual** as your convenient Palmcorder information source.

Date of Purchase
Dealer Purchased From
Dealer Address
Dealer Phone No.
Model No.
Serial No.

Unpack your Palmcorder

These accessories are provided in order to set up or use your Palmcorder.

1 pc. AC Adaptor
(PV-A17)
with DC Power
Cable

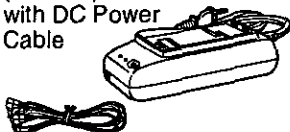

1 pc. Battery Pack
(PV-BP18)



1 pc. Audio/Video
Cable (VJAW0032)



1 pc. VHS PlayPak
(PV-P1/VYMW0009)
and one "AA" battery

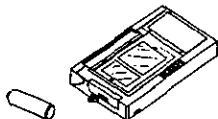

1 pc. CR2025 Clock
Battery (VSBW0004)
(installed in Palmcorder)



1 pc. Shoulder Strap
(VYCW0149)







Safety Precautions

WARNING: TO PREVENT FIRE OR SHOCK HAZARD, DO NOT EXPOSE THIS EQUIPMENT TO RAIN OR MOISTURE.

Your Compact VHS Palmcorder is designed to record and play back in Standard Play (SP) and Super Long Play (SLP) modes. You can also play a Compact VHS Palmcorder recording on your VHS VCR using the VHS PlayPak supplied.

This Palmcorder is equipped with the **HQ** System to provide excellent video pictures, and is compatible with standard VHS equipment.

It is recommended that only cassette tapes that have been tested and inspected for use in VCR machines with the **VHS** and/or **VHS** mark be used.

 CAUTION RISK OF ELECTRIC SHOCK DO NOT OPEN 	 This symbol warns the user that uninsulated voltage within the unit may have sufficient magnitude to cause electric shock. Therefore, it is dangerous to make any kind of contact with any inside part of this unit.
CAUTION: TO REDUCE THE RISK OF ELECTRIC SHOCK, DO NOT REMOVE COVER (OR BACK) NO USER-SERVICEABLE PARTS INSIDE REFER SERVICING TO QUALIFIED SERVICE PERSONNEL.	 This symbol alerts the user that important literature concerning the operation and maintenance of this unit has been included. Therefore, it should be read carefully in order to avoid any problems.

The above markings are located on the appliance bottom cover.

Important Safeguards

1. **Read Instructions** — All the safety and operating instructions should be read before the unit is operated.
2. **Retain Instructions** — The safety and operating instructions should be retained for future reference.
3. **Heed Warnings** — All warnings on the unit and in the operating instructions should be adhered to.
4. **Follow Instructions** — All operating and maintenance instructions should be followed.
5. **Cleaning** — Unplug this video unit from the wall outlet before cleaning. Do not use liquid or aerosol cleaners. Use a dry cloth for cleaning.
6. **Attachments** — Do not use attachments not recommended by the video product manufacturer as they may be hazardous.
7. **Water and Moisture** — Do not use this video unit near water — for example near a bath tub, wash bowl, kitchen sink, or laundry tub, in a wet basement, or near a swimming pool, and the like.
8. **Accessories** — Do not place this video unit on an unstable cart, stand, tripod, bracket, or table. The video unit may fall, causing serious injury to a child or adult, and serious damage to the unit. Use only with a cart, stand, tripod, bracket, or table recommended by the manufacturer, or sold with the video unit. Any mounting of the unit should follow the manufacturer's instructions and should use a mounting accessory recommended by the manufacturer. An appliance and cart combination should be moved with care. Quick stops, excessive force, and uneven surfaces may cause the appliance and cart combination to overturn.
9. **Ventilation** — Slots and openings in the cabinet are provided for ventilation and to ensure reliable operation of the video unit and to protect it from overheating. These openings must not be blocked or covered. Never place the video unit on a bed, sofa, rug, or other similar surface, or near or over a radiator or heat register. This video unit should not be placed in a built-in installation such as a bookcase or rack unless proper ventilation is provided or the manufacturer's instructions have been adhered to.
10. **Power Sources** — This video unit should be operated only from the type of power source indicated on the marking label. If you are not sure of the type of power supply to your home, consult your appliance dealer or local power company. For video units intended to be operated from battery power, or other sources, refer to the operating instructions.



11. **Grounding or Polarization** — This video unit may be equipped with either a polarized 2-wire AC (Alternating Current) line plug (a plug having one blade wider than the other) or 3-wire grounding type plug, a plug having a third (grounding) pin. The 2-wire polarized plug will fit into the power outlet only one way. This is a safety feature. If you are unable to insert the plug fully into the outlet, try reversing the plug. If the plug still fails to fit, contact your electrician to replace your obsolete outlet. Do not defeat the safety purpose of the polarized plug.
The 3-wire grounding type plug will fit into a grounding type power outlet. This is a safety feature. If you are unable to insert the plug into the outlet, contact your electrician to replace your obsolete outlet. Do not defeat the safety purpose of the grounding type plug.
12. **Power-Cord Protection** — Power-supply cords should be routed so that they are not likely to be walked on or pinched by items placed upon or against them, paying particular attention to cords of plugs, convenience receptacles, and the point where they exit from the unit.
13. **Outdoor Antenna Grounding** — If an outside antenna or cable system is connected to the video unit, be sure the antenna or cable system is grounded so as to provide some protection against voltage surges and built-up static charges. Part 1 of the Canadian Electrical Code, in USA Section 810 of the National Electrical Code, provides information with respect to proper grounding of the mast and supporting structure, grounding of the lead-in wire to an antenna discharge unit, size of grounding conductors, location of antenna discharge unit, connection to grounding electrodes, and requirements for the grounding electrode.

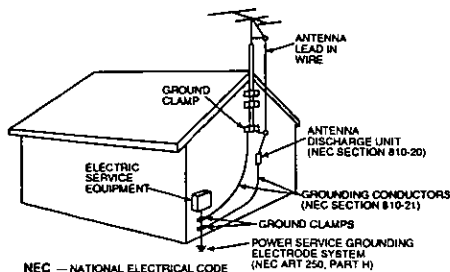

14. **Lightning** — For added protection of this video unit receiver during a lightning storm, or when it is left unattended and unused for long periods of time, unplug it from the wall outlet and disconnect the antenna or cable system. This will prevent damage to the video unit due to lightning and power-line surges.

Important Safeguards

15. **Power Lines** — An outside antenna system should not be located in the vicinity of overhead power lines or other electric light or power circuits, or where it can fall into such power lines or circuits. When installing an outside antenna system, extreme care should be taken to keep from touching such power lines or circuits as contact with them might be fatal.
16. **Overloading** — Do not overload wall outlets and extension cords as this can result in a risk of fire or electric shock.
17. **Objects and Liquids** — Never push objects of any kind into this video unit through openings as they may touch dangerous voltage points or short out parts that could result in a fire or electric shock. Never spill liquid of any kind onto the video unit.
18. **Servicing** — Do not attempt to service this video unit yourself as opening or removing covers may expose you to dangerous voltage or other hazards. Refer all servicing to qualified service personnel.
19. **Damage Requiring Service** — Unplug this video unit from the wall outlet and refer servicing to qualified service personnel under the following conditions:
 - a. When the power-supply cord or plug is damaged.
 - b. If any liquid has been spilled onto, or objects have fallen into the video unit.
 - c. If the video unit has been exposed to rain or water.
 - d. If the video unit does not operate normally by following the operating instructions. Adjust only those controls that are covered by the operating instructions, as an improper adjustment of other controls may result in damage and will often require extensive work by a qualified technician to restore the video unit to its normal operation.
 - e. If the video unit has been dropped or the cabinet has been damaged.
 - f. When the video unit exhibits a distinct change in performance — this indicates a need for service.
20. **Replacement Parts** — When replacement parts are required, be sure the service technician has used replacement parts specified by the manufacturer or have the same characteristics as the original part. Unauthorized substitutions may result in fire, electric shock or other hazards.
21. **Safety Check** — Upon completion of any service or repairs to this video unit, ask the service technician to perform safety checks to determine that the video unit is in safe operating order.

Precautions

USE & LOCATION

- **TO AVOID SHOCK HAZARD ...** Your Camcorder and power supply should not be exposed to rain or moisture. Do not connect the power supply or operate your Camcorder if it gets wet. Your Camcorder has been designed for outdoor use, however it is not designed to sustain direct exposure to water, rain, sleet, snow, sand, dust, or a direct splashing from a pool or even a cup of coffee. This action could permanently damage the internal parts of your Camcorder. Do not attempt to disassemble this unit. There are no user serviceable parts inside. Unplug your Camcorder from the power supply before cleaning.
- **DO NOT AIM YOUR CAMCORDER AT THE SUN OR OTHER BRIGHT OBJECTS**
- **DO NOT LEAVE THE PALMCORDER WITH THE EVF AIMED DIRECTLY AT THE SUN AS THIS MAY CAUSE DAMAGE TO THE INTERNAL PARTS OF THE EVF**
- **DO NOT EXPOSE YOUR CAMCORDER TO EXTENDED HIGH TEMPERATURE ...** Such as, in direct sunlight, inside a closed car, next to a heater, etc... This action could permanently damage the internal parts of your Camcorder.
- **AVOID SUDDEN CHANGES IN TEMPERATURE ...** If the unit is suddenly moved from a cold place to a warm place, moisture may form on the tape and inside the unit.
- **DO NOT LEAVE YOUR CAMCORDER OR THE POWER SUPPLY TURNED ON WHEN NOT IN USE.**
- **STORAGE OF YOUR CAMCORDER ...** Store and handle your Camcorder in a manner that will not subject it to unnecessary movement (avoid shaking and striking). Your Camcorder contains a sensitive pick-up device which could be damaged by improper handling or storage.

CARE

- **TO CLEAN YOUR CAMCORDER ...** Do not use strong or abrasive detergents when cleaning your Camcorder body.
- **TO PROTECT THE LENS ...** Do not touch the surface of the lens with your hand. Use a commercial camcorder lens solution and lens paper when cleaning the lens. Improper cleaning can scratch the lens coating.
- **TO PROTECT THE FINISH OF YOUR CAMCORDER ...** Before handling your Camcorder, make sure your hands and face are free from any chemical products, such as suntan lotion, as it may damage the finish.

Table of Contents

Getting Started

Things You Should Know	2
Important Safeguards	3
Precautions	4
Quick Operation Guide	6
Supplying Power	7
Cassette Information	10
Setting the Clock	11
Electronic Viewfinder Indications	15
Attaching the Shoulder Strap	18
Built-in Auto Light	19

Basic Operation

Camera Recording	20
Play Back your Recordings	23

Special Features

Four-Speed Power Zoom	26
High Speed Shutter	26
Focus	27
Backlight	28
One-Touch Auto Fade (BLACK or WHITE only)	28
Color Digital Fade (other than BLACK and WHITE)	29
Digital Zoom	30
Digital Electronic Image Stabilization System	31
Negative/Positive Transposer	31
Motion Security	32
Tally ON/OFF during Motion Security Recording	33
Intelligent Titrer	34
Copying your Tapes (dubbing)	35

For Your Information

Palmcorder Accessory System	36
Palmcorder Accessory Order Form	37
Notes Regarding Operations	38
Specifications	39
Before Requesting Service	40
Request for Service Notice	42
Index of Controls	43
Index	48
Warranty	49
Spanish Quick Use Guide/Guía Para Uso Rápido	51

Quick Operation Guide

Camera Recording

Charge the Battery Pack fully before operation (see page 7).

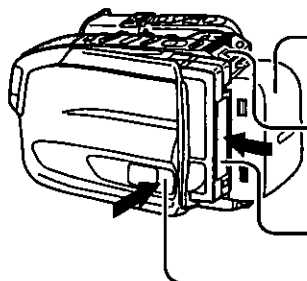

1 Attach a fully charged Battery (see page 7).

2 Slide the TAPE EJECT switch to open door.

3 Insert cassette (see page 10).

4 Press here to close door.

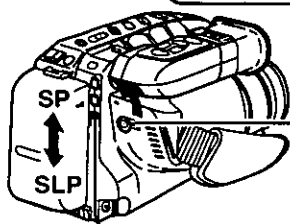

5 Set POWER switch to CAMERA. Built-In Lens Cover opens and POWER Lamp lights.

6 Slide TAPE SPEED Selector to SP or SLP (see page 10).

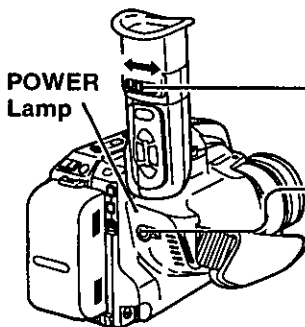

7 While looking into the Viewfinder, adjust the Vision Adjustment Control to your eyesight.

8 Press RECORD/PAUSE to start recording. Press RECORD/PAUSE again to pause recording (see page 20).

To Watch Playback in the EVF (Electronic Viewfinder)

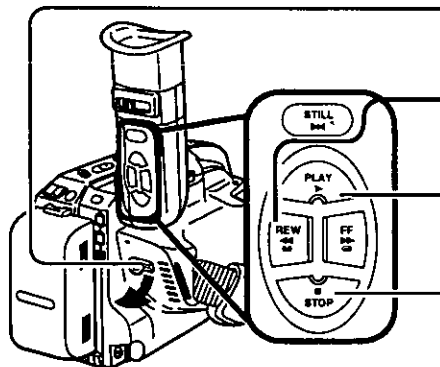

1 Set the POWER switch to VCR.

2 Press the REWIND/SEARCH to rewind tape.

3 Press PLAY to start playback.

4 Press STOP to stop playback.

Charge the Battery Pack

Charge the Battery Pack fully before operation.

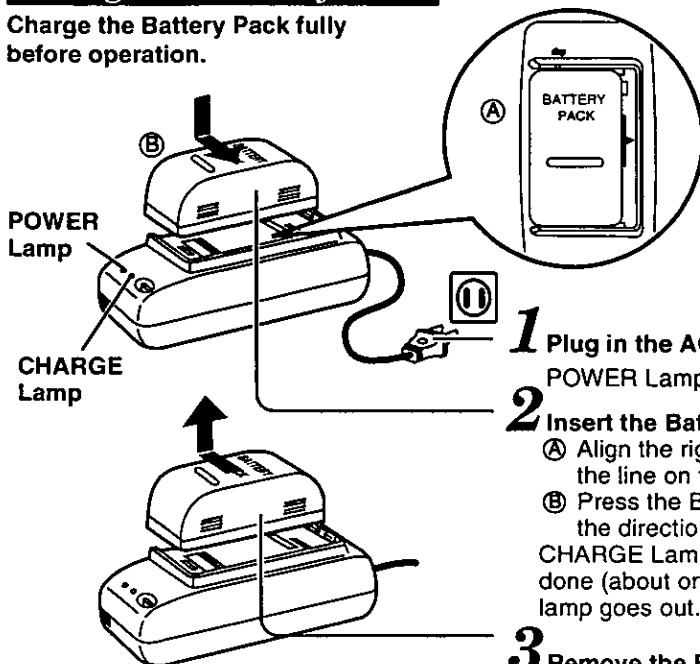

1 Plug in the AC Adaptor.
POWER Lamp lights.

2 Insert the Battery
Ⓐ Align the right side of the Battery with the line on the AC Adaptor.
Ⓑ Press the Battery down and slide it in the direction of the arrow.
CHARGE Lamp lights. When charging is done (about one and a half hours) the lamp goes out.

3 Remove the Battery
Slide the Battery out and lift up.

- The useful operation time of the Battery will gradually decrease after repeated use and recharging. The Battery is no longer serviceable if the operation time is very short, even after a sufficient charge.

Note:

After recharging the Battery Pack about 5 times, use the BATTERY REFRESH feature as explained on page 8.

Use the Battery Pack

With a fully charged Battery Pack, you will have a maximum of about one and a half hours of continuous use. (If the Built-in Light is used, battery operating time decreases.)

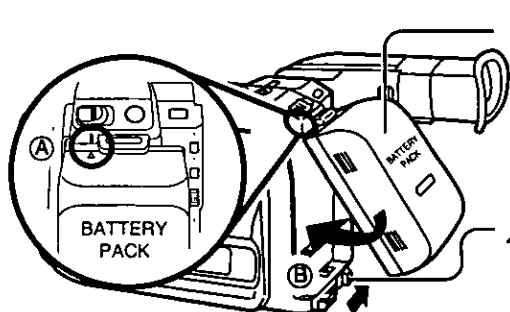

1 Attach the Battery
Ⓐ Align the Battery with the top of the mounting surface.
Ⓑ Press it into place until it locks with a click.

2 Remove the Battery
While sliding the BATTERY RELEASE button, remove the Battery.

Supplying Power

Battery Refresh Feature

This feature completely discharges the Battery before recharging begins.

To maintain your Battery's operating capacity, use the refresh feature after about every five charges.

CHARGE Lamp



1 Plug in the AC Adaptor.

- The POWER Lamp remains lit as long as the AC Adaptor is plugged in.

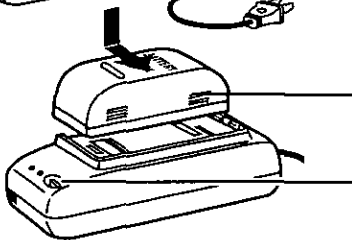

2 Place the Battery into the AC Adaptor.

3 Press the BATTERY REFRESH button.

The CHARGE Lamp flashes until discharge is complete and then stays lit until the Battery is fully charged.

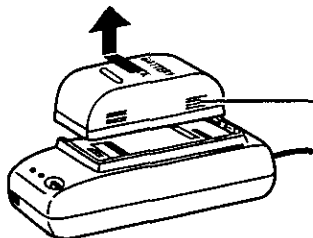

4 Remove the Battery.

- Should you accidentally press the BATTERY REFRESH button, remove the Battery and then re-insert it to begin charging.
- It takes about seven and a half hours when both Battery Refresh and recharging are performed.

Battery Care

Caution:

- Charge only with specified charger.
- Battery can be charged within a temperature range of 32° F (0° C) and 104° F (40° C).
- Battery may be warm after charging or just after use. This is normal.
- Do not use an insufficiently charged or worn-out Battery.

Safety precautions:

- Do not get the Battery near, or dispose of in fire.
- Do not directly connect (short circuit) the positive (+) and negative (-) terminals.
- Never attempt to disassemble or reassemble the Battery.

To avoid damage to the Battery:

- Do not drop or jar Battery.
- Use Battery with specified units only.
- If Battery is used in extremely high temperatures, a safety device will automatically prevent operation.

To prolong battery life:

- While not in use, remove Battery from the Palmcorder and AC Adaptor and store in a cool, dark, dry place.
- Keep Battery terminals clean.

U.S.A. CONSUMERS:

ATTENTION:

The product you have purchased is powered by a nickel cadmium battery which is recyclable. At the end of its useful life, under various state and local laws, it is illegal to dispose of this battery into your municipal waste stream. Please call 1-800-8-BATTERY for information on how to recycle this battery.



AC Adaptor

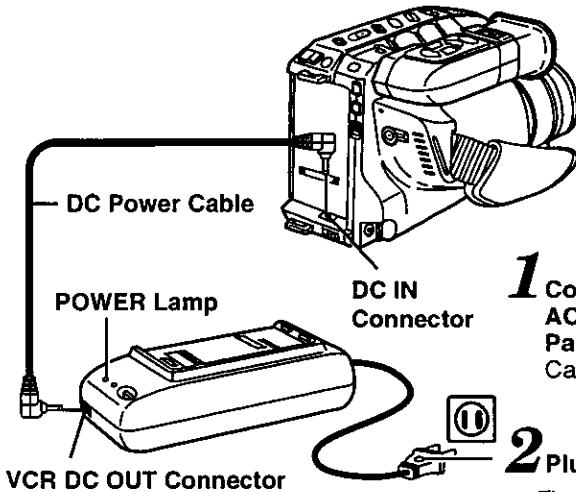

1 Connect VCR DC OUT on the AC Adaptor to DC IN on the Palmcorder with the DC Power Cable (supplied).

2 Plug in the AC Adaptor.

- The POWER Lamp will light.

Notes:

- AC Adaptor cannot be used to power the Palmcorder while charging the Battery.
- While not in use, unplug the AC Adaptor from the AC outlet. (When plugged into an AC outlet, the AC Adaptor consumes 1.2W of electric power when not in use.)

Car Battery Cord (Optional)

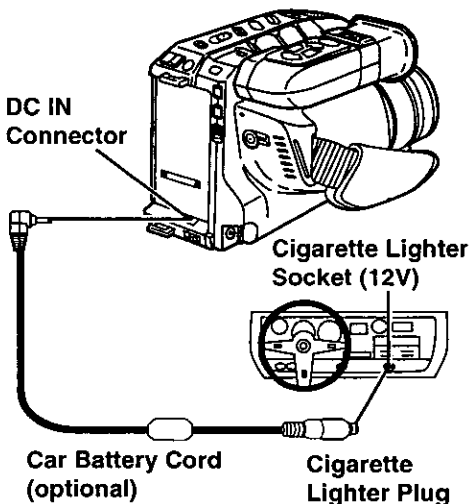

1 Connect a PV-C16 Car Battery Cord (optional) to DC IN on the Palmcorder.

2 First, start your car engine, and then insert the Car Battery Cord plug into your cigarette lighter socket.

- A fuse is located in the lighter plug end of the cord.

Should fuse replacement be necessary use the exact current rating (in amps).

Notes:

- This cord can only be used in vehicles equipped with DC 12V (negative ground) batteries. Use only the specified car battery cord. If you are not sure, check with your local car/truck dealer.
- To avoid blowing the fuse, be sure to start your car engine before inserting the cigarette lighter plug of the Car Battery Cord into the lighter socket.
- Because the car is running while your Palmcorder is in operation, make sure you're in a well ventilated area.
- Disconnect the cigarette lighter plug when your Palmcorder is not being used.

Cassette Information

Cassette Insertion/Removal

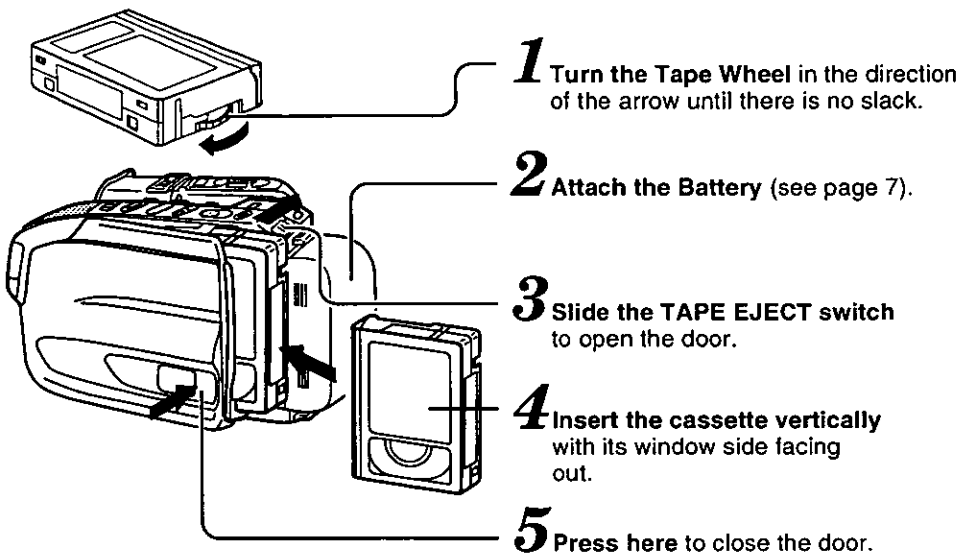

• To remove the cassette, slide the TAPE EJECT switch.

Record/Playback Time

Use tapes with the **VHSC** mark in this unit.

Tape Speed Selector Position	Cassette type		
	T-20	T-30	T-40
SP (Standard Play)	20 minutes	30 minutes	40 minutes
SLP (Super Long Play)	1 hour	1 hour 30 minutes	2 hours

TAPE SPEED Selector

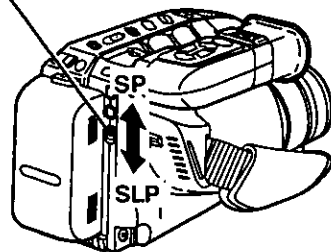

• SLP may have slightly more picture noise during playback.

Erase Protection Tab

Cassettes have a record tab to ensure that recordings are not accidentally erased.

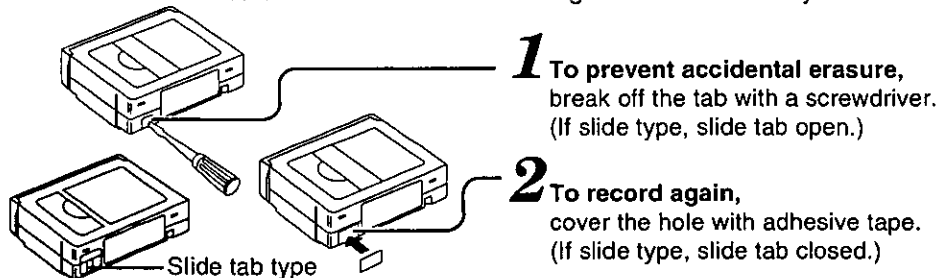

Setting the Clock

Setting the clock is divided into four sections: Time Zone, Daylight Saving Time, Date and Time, and Clock Battery. Follow instructions in the order presented.

Setting the Time Zone

The Palmcorder is set to Eastern time zone from the factory. If you live or are travelling in a different time zone, follow the steps to select the appropriate time zone from the menu screen.

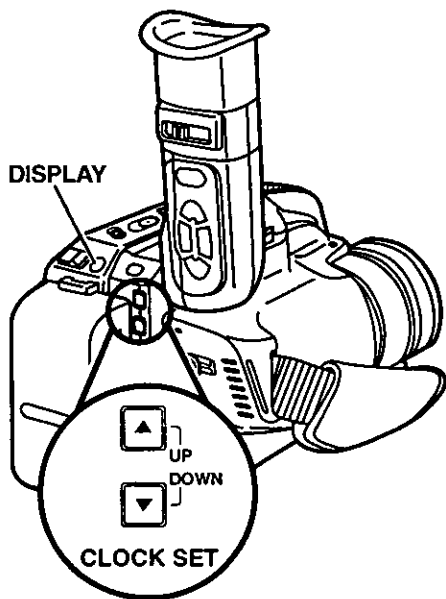

Before you begin...

- Connect the Palmcorder to a power source.
- Set the POWER switch to VCR or CAMERA.

Note:

The Palmcorder will exit the CLOCK SET menu if, after activation, none of the CLOCK SET UP/DOWN, (▲/▼) or DISPLAY buttons are not pressed within 30 seconds.

The Palmcorder's clock may lose or gain up to two minutes per month. Please adjust as necessary (refer to page 13).

- 1** Press **CLOCK SET UP ▲** to display the CLOCK SET menu.
- 2** Press **UP ▲** or **DOWN ▼** repeatedly to select **1.SELECT TIME ZONE**.

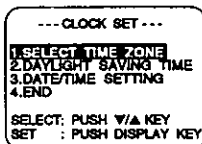

- 3** Press **DISPLAY** to display the SELECT TIME ZONE menu.

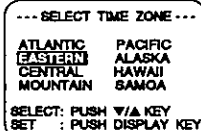

- 4** Press **UP ▲** or **DOWN ▼** repeatedly to select desired time zone.

- 5** Press **DISPLAY** to fix the Time Zone. The CLOCK SET menu appears.

To exit from the **CLOCK SET** menu, press **DOWN ▼** to select **4.END**, and then press **DISPLAY**.

Note:

When you travel outside the eight time zones shown in the time zone chart at the left, please set the clock manually (see page 13).

Time Zone chart

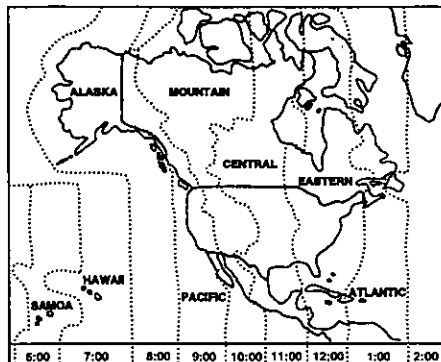

Setting the Clock

Setting the Daylight Saving Time

The clock will automatically adjust to daylight saving time.

The Palmcorder is preset to Daylight Saving Time **AUTO**. If you do not want the clock to be automatically adjusted to daylight saving time, please select **OFF** by following steps 1-5.

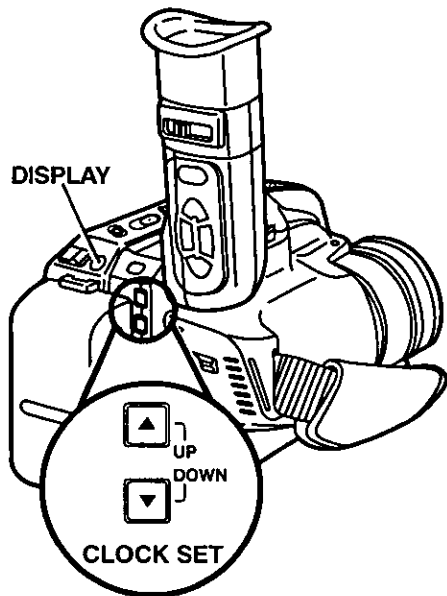

Before you begin...

- Connect the Palmcorder to a power source.
- Set the POWER switch to VCR or CAMERA.

Note:

The Palmcorder will exit the CLOCK SET menu if, after activation, none of the CLOCK SET UP/DOWN, (▲/▼) or DISPLAY buttons are not pressed within 30 seconds.

Daylight saving time feature will not function if time zone is set to Hawaii or Samoa.

- 1 Press **CLOCK SET UP ▲** to display the CLOCK SET menu.
- 2 Press **UP ▲** or **DOWN ▼** repeatedly to select **2.DAYLIGHT SAVING TIME**.

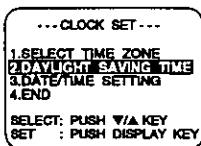

- 3 Press **DISPLAY** to display the DAYLIGHT SAVING TIME menu.

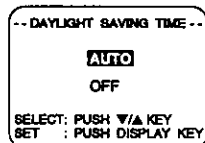

- 4 Press **UP ▲** or **DOWN ▼** to select **AUTO** or **OFF**.

- 5 Press **DISPLAY** to fix the DAYLIGHT SAVING TIME setting. The CLOCK SET menu appears.

To exit from the **CLOCK SET menu**, press **DOWN ▼** to select **4.END**, and then press **DISPLAY**.

Spring (First Sunday in April):

In **DAYLIGHT SAVING TIME: AUTO** mode, the clock is automatically moved ahead one hour.

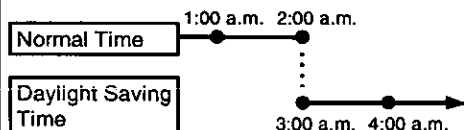

Autumn (Last Sunday in October):

In **DAYLIGHT SAVING TIME: AUTO** mode, the clock is automatically turned back one hour.

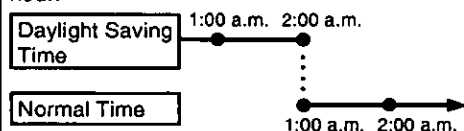

Setting the Clock

Setting the Date and Time

The date and time is calculated, including leap year, up to DEC 31 2095.

Before you begin...

- Connect the Palmcorder to a power source.
- Set the POWER switch to VCR or CAMERA.

Note:

The Palmcorder will exit the CLOCK SET menu if, after activation, none of the CLOCK SET UP/DOWN, (▲/▼) or DISPLAY buttons are not pressed within 30 seconds.

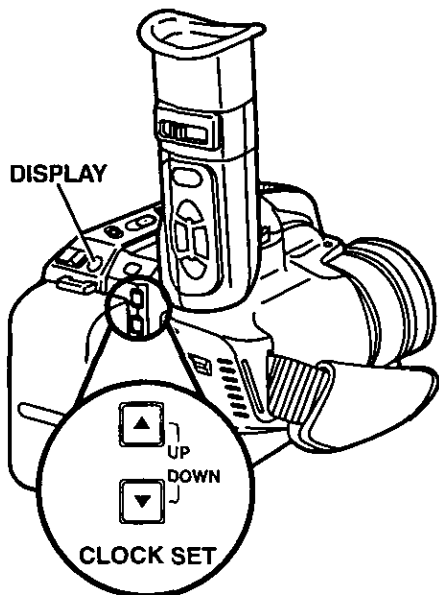

1 Press **CLOCK SET UP ▲** to display the **CLOCK SET** menu.

2 Press **UP ▲** or **DOWN ▼** repeatedly to select **3.DATE/TIME SETTING**.

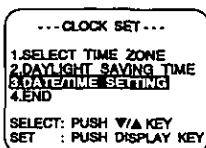

3 Press **DISPLAY** to display the **DATE/TIME SETTING** menu.

4 Press **UP ▲** or **DOWN ▼** repeatedly (or hold down) to enter the desired numbers, then press **DISPLAY** to fix that portion and move on.

EXAMPLE

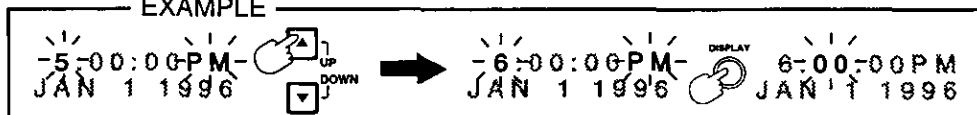

Adjust the flashing digits for the hour, minute, month, day, and year.

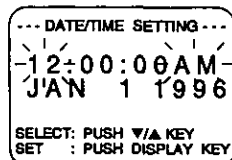

When you finish setting the year, the clock starts operating, and the **CLOCK SET** menu appears.

To exit from the **CLOCK SET** menu, press **DOWN ▼** to select **4.END**, and then press **DISPLAY**.

Setting the Clock

Replacing the Battery

The date and time operates on a miniature battery preinstalled in the underside of your Palmcorder.

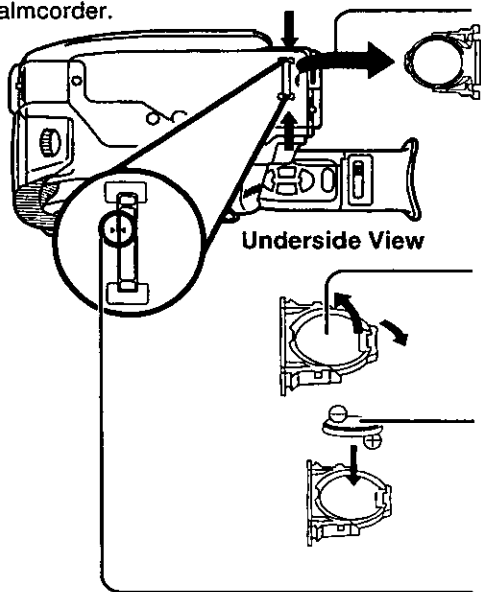

1 While pinching the stopper tabs, pull the Battery tray out of the Battery Compartment.

2 Remove the Battery by bending the locking tab outward.

3 Place the new Battery into the Battery tray with the \oplus mark facing down. Press down until it snaps into place.
• Do not reverse the polarity.

4 Insert the Battery Tray until both triangle marks meet.

WARNING:

Replace battery with Panasonic PART NO. VSBW0004 (CR2025) only. Use of another battery may present a risk of fire or explosion. Caution-battery may explode if mistreated. Dispose of used battery promptly. Keep away from children. Do not recharge, disassemble or dispose of in fire.

Note:

- Make sure your Palmcorder is off when replacing the Battery.
- Keep the Battery out of the reach of children as swallowing it may be harmful.
- Improperly installed, discharged, or missing battery will cause "CLOCK BATTERY" to appear when the DISPLAY button is pressed.
- Battery life is approximately 5 years.

Electronic Viewfinder Indications

Tape/Battery Remaining

The tape remaining and battery charge level can be displayed during recording.

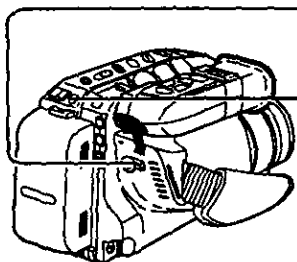

1 Set the POWER switch to CAMERA.

2 Press DISPLAY repeatedly to select the desired display.

EVF Indications

Battery Charge Remaining:



Tape Remaining:

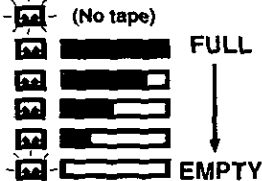

- It will take several seconds for the tape remaining indicator to operate after the tape starts moving.

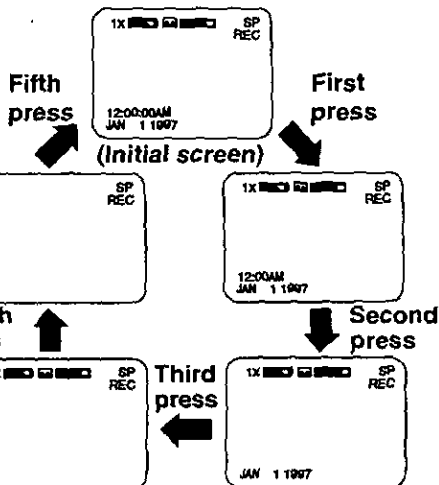

Recording the Date and Time

1 Set the POWER switch to CAMERA. When placed in Record mode, the time and date will be recorded on the tape.

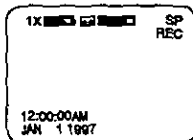

2 Press DISPLAY twice to change the display to date only. Press once or twice more to remove the date/time display.

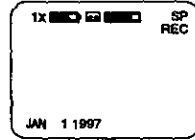

Note:

Only the Date and/or Time indications are recorded on the Tape.

Display-Off Mode

This feature allows you to remove all Electronic Viewfinder Indications except Intelligent Titler (see page 34).

Before inserting a tape, press DISPLAY and STOP together for more than one second to remove the indications except time and date*.

To display the Electronic Viewfinder Indications again, turn the Palmcorder Power off and then on again.

* To remove the time and date, press the DISPLAY button repeatedly.

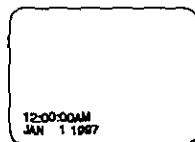

Electronic Viewfinder Indications

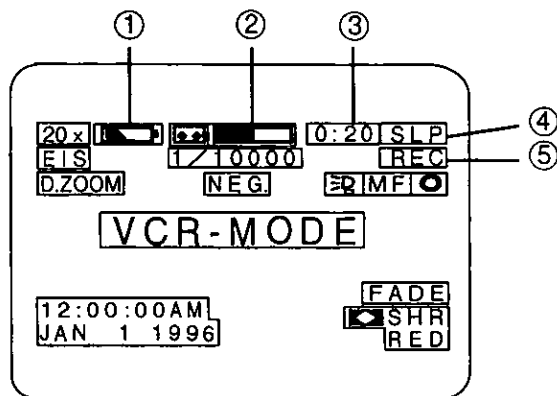

① Battery Remaining Indication (see page 15)

When a battery recharge is necessary, "WARNING LOW BATTERY" will appear in the EVF. The external Power Lamp will start to flash and the Palmcorder will automatically turn OFF in 15 seconds.

② Tape Remaining Indication

- If the Palmcorder is in the camera mode, (RECORD) with no cassette tape inserted, or the record tab is missing, "Ⓜ" will flash for one minute and "CHECK TAPE" will appear for 5 seconds.
- As the tape reaches the end during recording, "Ⓜ" will flash and "TAPE END" will appear for 5 seconds as a warning.

③ 10-Second Reminder

An elapsed time indicator appears one second for every 10 seconds that recording continues. This is a reminder of how long you have been shooting a particular scene and can help keep your recordings fresh and interesting.

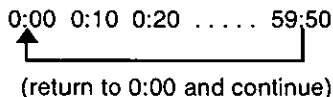

- The 10-Second Reminder will reset to 0:00 whenever you press the RECORD/PAUSE button.

④ TAPE SPEED Indication (see page 10)

Indicates the tape speed (SP or SLP).

⑤ Operating Mode Indications

REC (record)

(Appears in large then small characters.)

PAUSE

(Appears in large then small characters.)

FF (fast forward)

PLAY

REW (rewind)

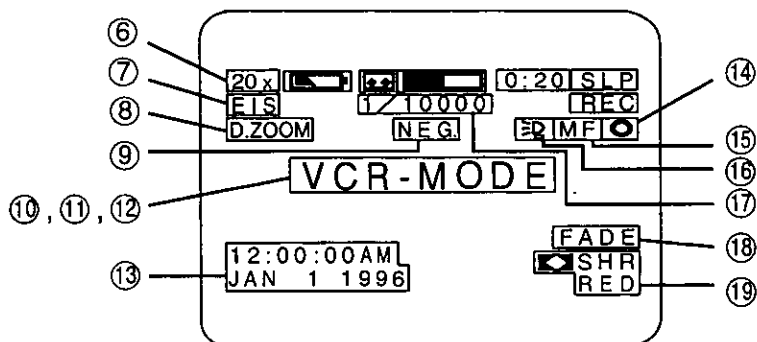

⑥ **Zoom Magnification level** (see page 26).

⑦ **Digital E.I.S. Indication** (see page 31).

⑧ **Digital Zoom Indication** (see page 30).

⑨ **Negative/Positive Indication** (see page 31).

⑩ **VCR-MODE Indication**

Appears for one minute if the POWER switch is set to VCR or the RECORD/PAUSE button is pushed in VCR MODE.

⑪ **DEW Indication**

If excessive moisture condenses in the unit, "WARNING DEW DETECTED" will appear, Power Lamp will flash, and the Palmcorder will automatically turn OFF in 15 seconds.

Wait until the indicator no longer flashes when your Palmcorder is turned on before use.

⑫ **Motion Security Indication** (see page 32).

⑬ **Date and Time Indication** (see page 13).

⑭ **Backlight Indication** (see page 28).

⑮ **Manual Focus Indication** (see page 27).

⑯ **Light ON/OFF Indication** (see page 19).

⑰ **High Speed Shutter Indication** (see page 26).

⑱ **Fade Indication** (see page 28).

⑲ **Color Digital Fade Indication** (see page 29).

Attaching the Shoulder Strap

Make sure the Battery Pack is not attached.

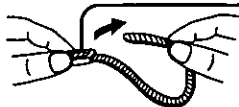

- 1** Undo the two strap ends from their buckles.

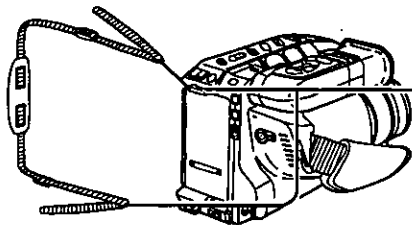

- 2** Thread the strap ends through the Strap Attachment Rings.



min. 1 inch (25.4mm)

- 3** Reinsert the strap ends through their buckles.

- Make sure the straps are not twisted.

Adjusting the Length

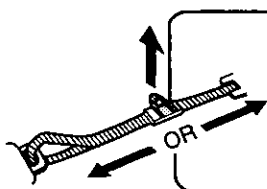

- 1** Pull a loop of the strap loose from the buckle.

- 2** Pull the strap firmly through the buckle to shorten or lengthen the strap.

Hand Strap

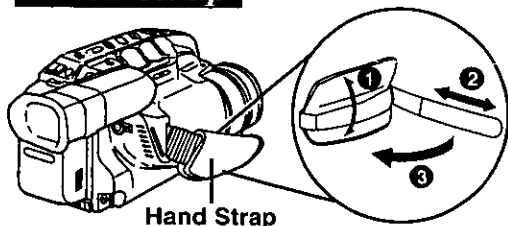

Hand Strap

Adjust the length of the Hand Strap to the size of your hand as illustrated.

Using the Built-in Auto Light

To improve recording indoors or outdoors in dim lighting conditions.

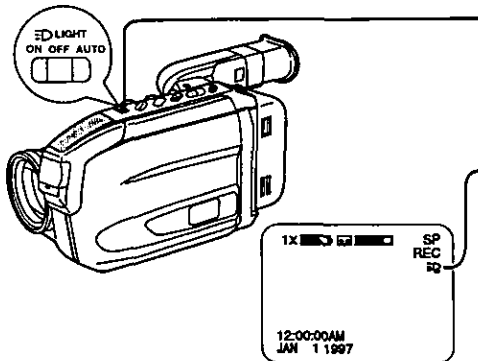

Before you begin...

- Connect the Palmcorder to a power source.
- Set the POWER switch to CAMERA.

Set the LIGHT switch to AUTO.

The built-in light automatically turns on and off depending on lighting conditions.

Or set LIGHT to ON/OFF to turn the light on and off manually.

☺ will appear in the EVF while the light is turned on.

Caution:

This light becomes hot during operation. Make sure nothing covers the Light during operation.

Replacing the Bulb

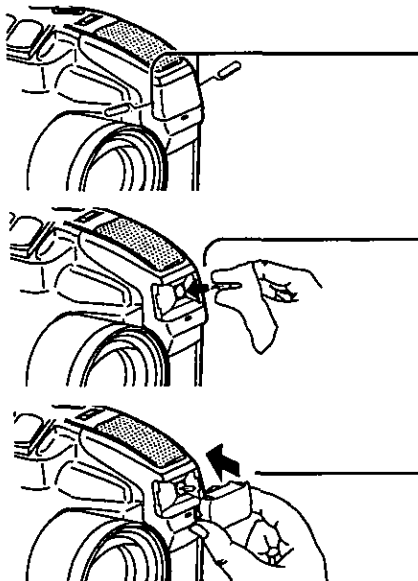

Before you begin...

- Set the POWER switch to OFF.

1 Insert a narrow object, such as the end of a paper clip, into the hole on each side of the lens cover to unlock and pull it straight out from the Palmcorder.

2 Using a clean cloth or tissue, replace the bulb.

3 To Replace: Push the lens cover straight back into place.

DANGER:

When replacing the bulb, use only lamp bulbs (PART NO. VLLW0007) supplied by Panasonic to reduce the risk of fire.

Use a cloth or tissue when handling the bulb as finger oils will decrease the bulb life.

To prevent possible burn hazard, remove the lens cover and allow the lamp to cool before replacing.

Note:

- Using the light reduces battery operating time.
- If using the Built-in Light in a hot environment for an extended period of time, be sure to provide ventilation.
- Using the Built-in Light when the Palmcorder is powered by a car battery may shorten bulb life.
- Be sure LIGHT switch is set to OFF when not in use or before placing Palmcorder into an optional carrying case.

Camera Recording

Simple Recording

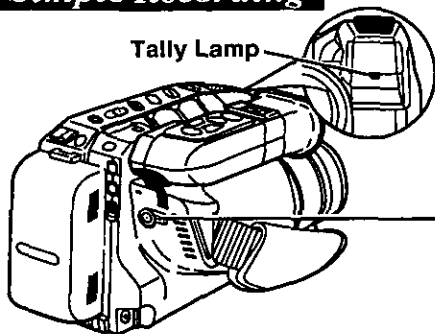

Before you begin...

- Connect the Palmcorder to a power source.
- Insert a cassette with record tab (see page 10).

1 Set the **POWER** switch to **CAMERA**.
The built-in Lens Cover opens.

- Make sure the **POWER** switch is fully rotated to the **CAMERA** position.

EVF

PAUSE

Record/Pause mode.

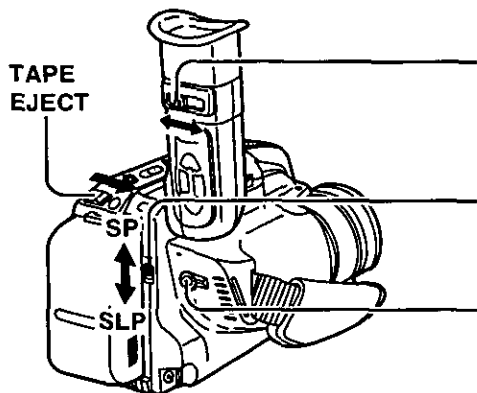

2 With the Viewfinder Eye Cup against your eye, adjust the Vision Adjustment Control to your eyesight.

3 Slide the **TAPE SPEED** Selector to **SP** or **SLP** (refer to page 10).

4 Press **RECORD/PAUSE** to start recording.
The Tally Lamp and REC Indicator are lit during recording.

WARNING:

- Do not leave the Palmcorder with the **EVF** aimed directly at the sun as this may cause damage to the internal parts of the **EVF**.

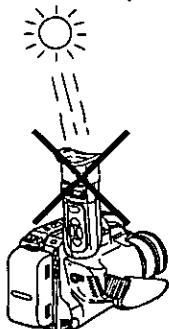

- When your Palmcorder is aimed at excessively bright objects, or bright lights, a vertical bar may appear in the picture. This is a normal characteristic of the CCD pick-up device. Try to avoid this when possible.

RECORD

Press the **RECORD/PAUSE** again to pause the recording.

Set the Power switch to **OFF** after recording is finished.

• To remove the cassette

In Record/Pause mode, slide the **TAPE EJECT** switch (refer to page 10).

Stand-by Quick Release

Whenever the Palmcorder is left in RECORD/PAUSE mode for 5 minutes, it will automatically switch to Stand-by mode to conserve energy. Activating the Stand-by Quick Release feature allows you to release the Stand-by mode and resume recording by simply pressing the RECORD/PAUSE button. If this feature is not activated, it is necessary to turn the Palmcorder OFF and back on to CAMERA to start recording again. The default setting from the factory is set to the **NON-ACTIVE** mode.

Before you begin...

- Connect the Palmcorder to a power source.
- Insert a cassette with record tab (see page 10).

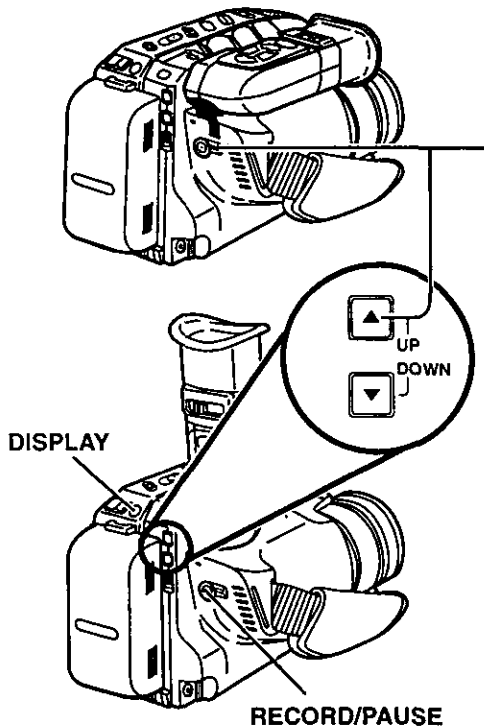

1 Continue holding down the UP ▲ button before and after turning the POWER switch to CAMERA until the STAND-BY RELEASE menu screen is displayed.

2 Press UP ▲ or DOWN ▼ to select **ACTIVE** or **NON-ACTIVE**.

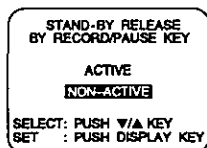

ACTIVE

You can resume recording from Stand-by mode by pressing the RECORD/PAUSE button.

NON-ACTIVE

You must set the POWER switch to OFF, and then to CAMERA to release the Stand-by mode.

3 Press DISPLAY to set your selection and exit this screen.

Camera Recording

Easy Edit Stand-by

If you stop recording but plan to resume within 24 hours, use the Edit Standby feature to make a smooth transition between scenes.

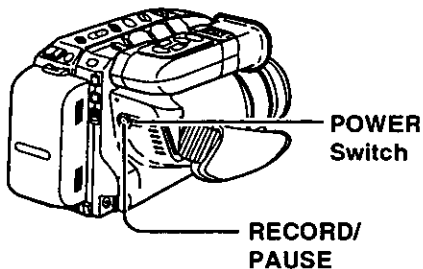

- 1** Press **RECORD/PAUSE** while recording.
- 2** Set the **POWER** switch to **OFF** and leave the cassette in the Palmcorder.
- 3** When ready to resume recording, set the **POWER** switch to **CAMERA** and press **RECORD/PAUSE**.

Note:

- If it is going to be longer than 24 hours before you resume recording, you will need to use the manual Easy Edit feature described below.

Manual Easy Editing

For proper continuity when taping from the Stop mode, or after changing the Battery Pack.

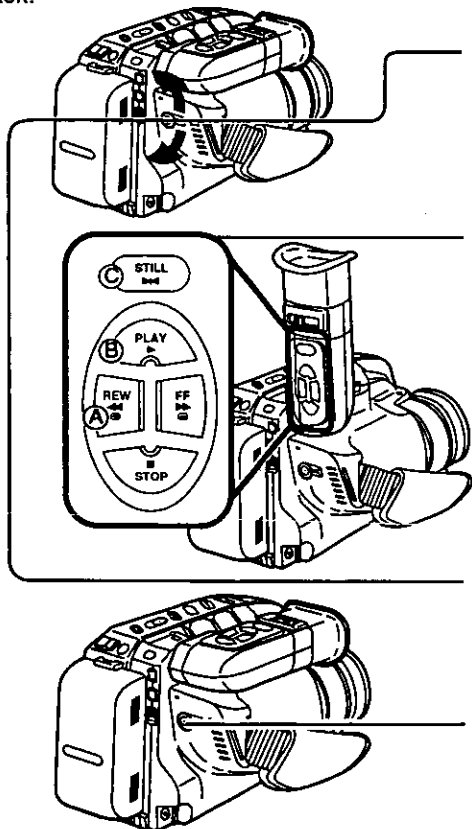

- 1** Set the **POWER** switch to **VCR**.
- 2**
 - A** Press **REWIND/SEARCH** to go back a few seconds on the tape.
 - B** Press **PLAY** to review the picture on the Viewfinder.
 - C** Press **STILL** at the location you wish to continue your recording.
- 3** Set the **POWER** switch to **CAMERA**.
- 4** Press **RECORD/PAUSE** to continue recording.

Play Back your Recordings

Playback using the EVF

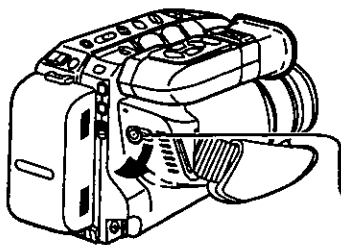

Before you begin...

- Connect the Palmcorder to a power source.
- Insert a recorded cassette.

1 Set the POWER switch to VCR.

2 **(A)** Press the REWIND/SEARCH button to rewind the tape.
(B) Press PLAY to start playback.
(C) Press STOP to stop playback.

Auto Play

When the POWER switch is set to VCR, playback will automatically begin if the record tab has been removed on the cassette.

Search Speed

Standard Play (SP) Search is about 3 times the normal speed, and Super Long Play (SLP) Search is about 9 times the normal speed.

Tracking Control

Auto Tracking

Continuously analyzes the signal of each recording for optimum picture quality.

Manual Tracking

To minimize the noise in some recordings, manual tracking may be necessary.

For Noise in Playback mode:

Press UP ▲ or DOWN ▼ until picture clears.

Press DISPLAY to return to Auto Tracking.

For Noise in Still mode:

Press UP ▲ or DOWN ▼ until picture clears.

V-Lock Control (Reduces jitter in Still mode.)

Press DISPLAY and UP ▲ or DOWN ▼ until picture is stable.

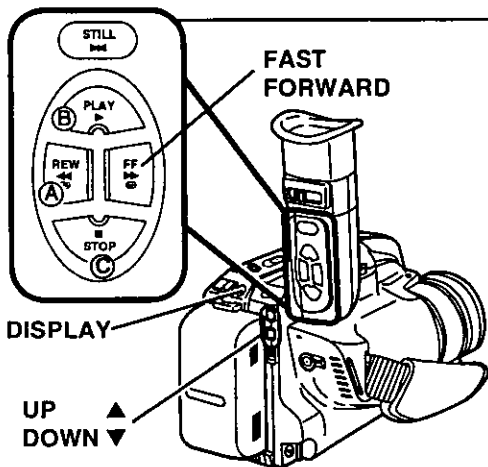
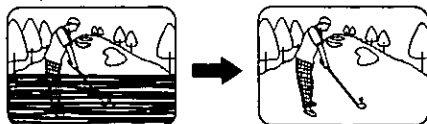

Special Effects Playback

To rapidly locate a scene

Press FAST FORWARD/SEARCH or REWIND/SEARCH for rapid visual search. Press again, or press PLAY to resume normal speed.

View a Still Picture

Press STILL to freeze the picture. Press again to resume normal playback.

Note:

- During search playback, horizontal noise bars will appear and there will be no audio.
- To protect the tape and the video heads, your Palmcorder's operating modes will revert as follows:
STILL → STAND-BY after 5 minutes.
STANDBY → POWER OFF after 5 minutes when using a Battery Pack.
- When the tape reaches its end during playback, or fast forward, it will rewind automatically.

Play Back your Recordings

TV Playback or Viewing

Your Palmcorder may be connected to a TV to play back tapes or to view what you are recording.

TV with AUDIO/VIDEO IN Jacks.

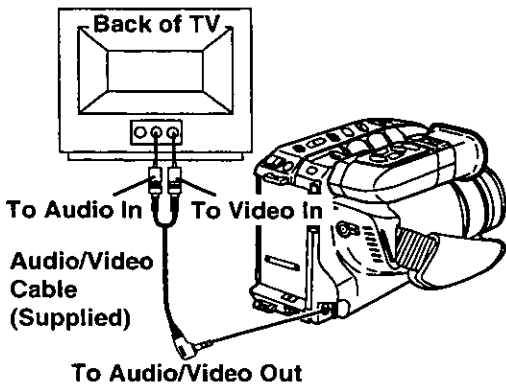

TV without AUDIO/VIDEO IN Jacks.

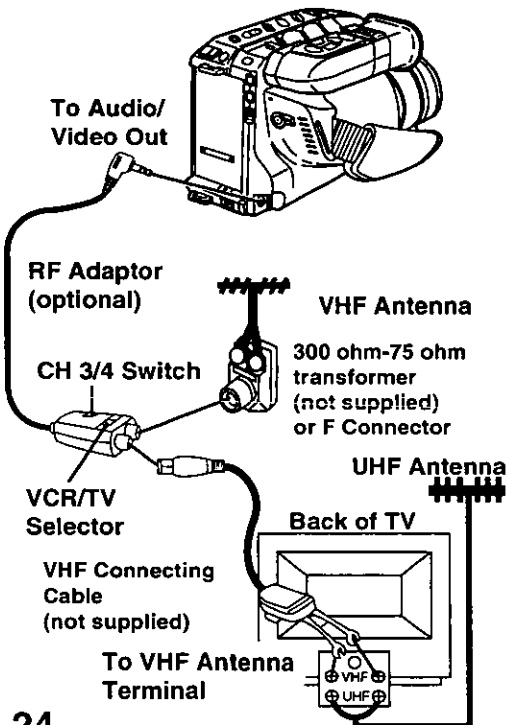

Before you begin...

- Connect the Palmcorder to a power source.

1 Set the **POWER** switch to **VCR** for tape playback.
Or, set to **CAMERA** to view what your Palmcorder is recording.

2 Turn the **TV ON** and set it to **LINE INPUT**.
Check your TV operating instructions.

Note:

If your TV has no **VIDEO** or **AUDIO IN** jacks, select **CH 3** or **4** on your TV to match the **CH 3/4** switch setting on the **OPTIONAL PV-RF16 RF Adaptor**. Set the **VCR/TV** selector on the **RF Adaptor** to **VCR** for playback.

3 Start playback or begin a recording.

If you have connected the Palmcorder to your TV using the **PV-RF16 RF Adaptor** and want to watch TV only:

Set the **POWER** switch to **OFF** on the Palmcorder.
Then, set the **VCR/TV Selector** on the **RF Adaptor** to **TV**.
Now, turn the **TV ON** and select a channel.

CATV System Installer

This reminder is provided to call the CATV system installer's attention to Article 820-40 of the NEC in USA (and to the Canadian Electrical Code in Canada) that provides guidelines for proper grounding and, in particular, specifies that the cable ground shall be connected to the grounding system of the building, as close to the point of cable entry as practical.

Play Back your Recordings in your VCR

Playback using the PlayPak

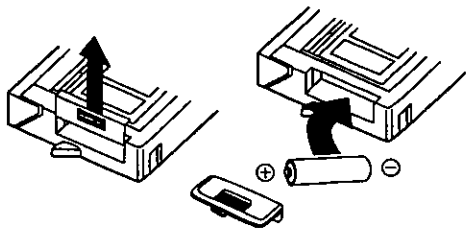

Remove the Battery Compartment lid and insert the AA size battery.

- Make sure polarities are aligned properly.
- When tape loading and unloading time becomes longer than normal, battery replacement is necessary.

Insert VHS Cassette

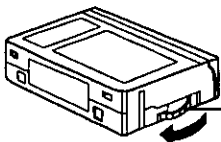

1 Turn the Tape Wheel on the **VHS** cassette in the direction of the arrow to take up any slack.

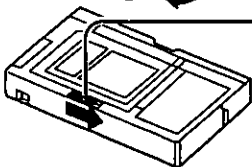

2 Slide the **RELEASE** button in the direction of the arrow to open the PlayPak door.

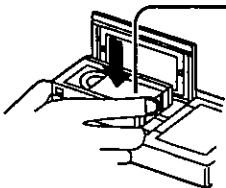

3 Insert the **VHS** cassette with the window facing up and to the left. Then, snap the lid shut.

- Be sure the cassette reel area under the PlayPak is free to turn while loading.
- Allow the Load Detector to fully retract before using the PlayPak in your standard VHS VCR.

Load Detector

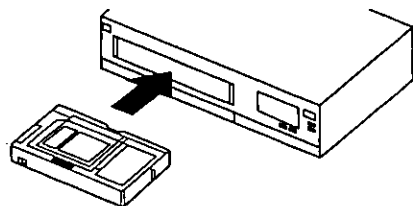

Remove VHS Cassette

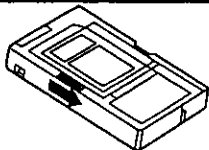

1 Slide the **RELEASE** button and wait for the lid to open.

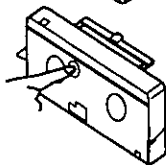

2 Hold the PlayPak securely in one hand. Using your finger, reach through the hole in the bottom of the PlayPak Adaptor and push the tape out the top.

Special Features

Four-Speed Power Zoom

You can gradually zoom in for close ups or zoom out for wide angle shots.

The zooming speed ranges from a slow speed of 16 seconds to a fast 2.2 seconds according to the pressure applied to the zoom buttons.

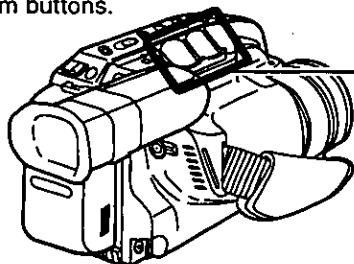

Zoom In ("T")



Zoom Out ("W")

Zoom slowly by lightly pressing the "T" (Telephoto) or the "W" (Wide Angle) side of the POWER ZOOM switch.

Zoom quickly by applying more pressure.

- The magnification level is displayed in the EVF.

High Speed Shutter

To record high speed motion (e.g. a tennis stroke) for improved STILL or SLOW MOTION playback, when watching the tape on this Palmcorder or a VHS 3 or 4 head VCR.

Auto Shutter

In the AUTO mode (no indication in the EVF), the Palmcorder will automatically adjust the shutter speed from 1/60 to 1/350 according to the brightness of the subject.

- AUTO mode is automatically selected whenever the POWER switch is set to CAMERA.

Manual Selection

The High Speed Shutter indicator flashes when the light level is inadequate. More light should be provided to achieve better picture quality and color.

1 Press HIGH SPEED SHUTTER while recording.

2 Press repeatedly to obtain one of the eight higher shutter speeds shown at right.

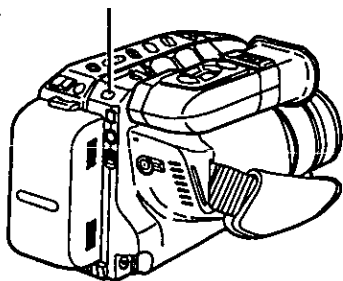

EVF Indications

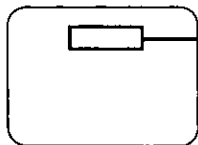

No Indication

1/60

1/100

1/250

1/500

1/1000

1/2000

1/4000

1/10000

Note:

- For proper color reproduction, it is recommended that you use this feature outdoors. For indoor High Speed Shutter recording, additional halogen or tungsten light should be provided. Fluorescent light will degrade the picture quality.
- This feature requires ample light. More light is required for the fastest shutter speeds.
- The Auto Focus system may not operate properly in insufficient light when using the High Speed Shutter.

Auto Focus

The Palmcorder will automatically focus on the subject even during zooming.

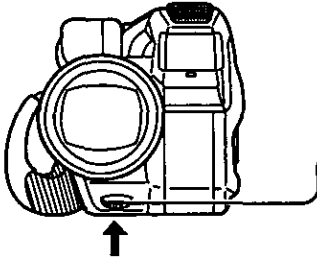

If necessary, press **MANUAL FOCUS** so that "MF" does not appear in the EVF.

Manual Focus

Use **Manual Focus (MF)** when recording:

- a subject through glass.
- a subject that is far from the Palmcorder with objects in the foreground.
- a subject with distinct horizontal stripes.
- a subject not centered in the Viewfinder.
- a subject with a shiny surface.
- an obliquely angled subject.
- a bright, flat subject such as a white wall.
- in low light situations.
- a scene with fast motions, like a golf swing.

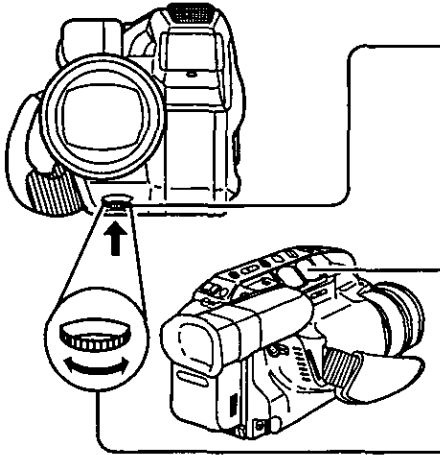

1 Press **MANUAL FOCUS** so that "MF" (Manual Focus) appears in the EVF.

EVF Indication

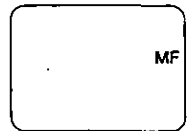

2 Press and hold the "T" side of the **POWER ZOOM** switch until the lens is zoomed in all the way (subject at maximum size).

3 Turn the **MANUAL FOCUS** control until the picture is in focus.

- It may be necessary to back away from the subject to focus the image properly.

4 Press the "W" side of the **POWER ZOOM** switch to frame the picture as desired.

- **Re-focusing may be required** when your Palmcorder is aimed at a new scene.

Macro Focus (for close-ups)

Auto Focus will function as close as 1/2 inch (12.7mm) from the subject.

Press the "W" side of the **POWER ZOOM** switch to the wide angle position. Then, bring the Palmcorder as close to the subject as desired.

Special Features

Backlight

Use when recording a subject that is darker than the surrounding scene, in a shadowed area or when the light source is in back of your subject.

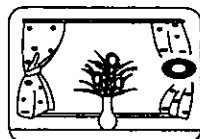
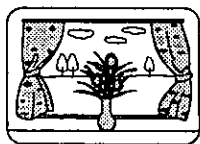

Indication appears in the EVF.

EVF Indications

Normal (no display)



First press (low)



Second press (medium)



Third press (high)

Fourth press

Select a level that makes the subject appear clearly in the EVF.

There are three levels of backlight compensation. Press the **BACKLIGHT** button to obtain the desired level while recording.

When lighting conditions are normal, press the **BACKLIGHT** button until the indicator disappears in the EVF.

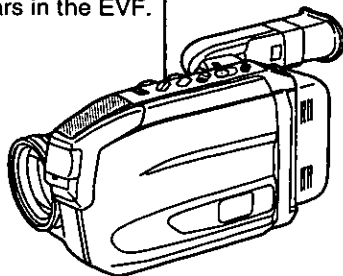

One-Touch Auto Fade (BLACK or WHITE only)

Make smooth scene transitions for a more professional look.

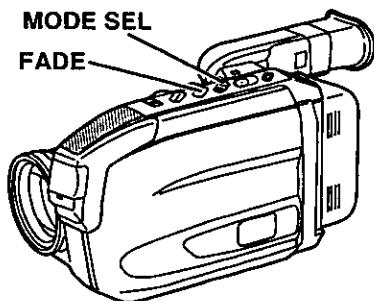

BLACK

WHITE



WHITE

BLACK



Fade In

Fade Out

Fade In:

Starting the first scene with "fade in" can be very effective.

- 1 Press the **MODE SEL** button repeatedly to select BLACK or WHITE fade.
- 2 During the **RECORD/PAUSE** mode, press the **FADE** button to make "FADE" flash in the EVF.
- 3 Press the **RECORD/PAUSE** button. The screen will turn black and the recording will start as picture and sound gradually fade in.

Fade Out:

Use to create a soft ending or, when used together with fade in, a soft transition from one scene to the next.

- 1 Press the **MODE SEL** button repeatedly to select BLACK or WHITE fade.
- 2 Press the **FADE** button to make "FADE" flash in the EVF while recording.
- 3 Press the **RECORD/PAUSE** button. The picture and sound will gradually fade out and the recording will PAUSE.

If FADE is accidentally pressed, simply press it again so that "FADE" disappears in the EVF.

Special Features

Color Digital Fade (other than BLACK and WHITE)

This feature offers 7 fade variations in your choice of eight colors for a wide variety of fade effects.

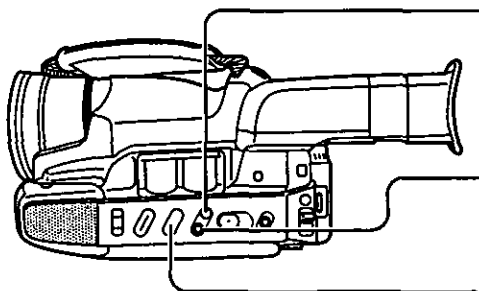

- 1 Press the MODE SEL button repeatedly** to select the desired fade effect other than BLACK and WHITE.
 - Excluding BLACK, the mode selected will appear in the EVF.
- 2 Press the COLOR button** to select the desired color other than BLACK or WHITE.
- 3 Hold the FADE button down** while recording until the picture fades out. Release to fade back in.

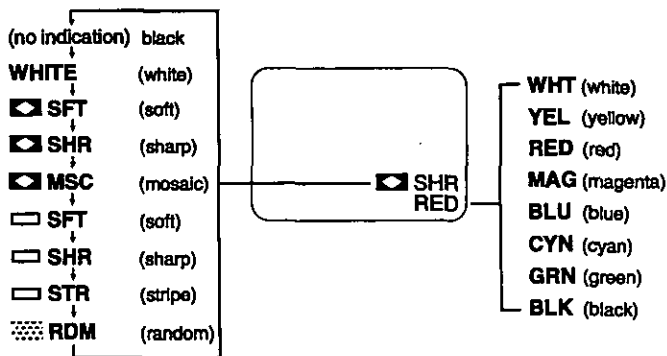

- **Create more effects:** You can stop the fade at any time by pressing the MODE SEL button (other than BLACK, WHITE, and RANDOM modes). Pressing the FADE button will continue the fade. Pressing the MODE SEL button will cancel the fade.

Note:

- Other than BLACK and WHITE modes, the audio is not affected by the fade operation.

Special Features

Digital Zoom

This feature allows you to increase the magnification of the Power Zoom.

Before you begin...

- Set the POWER switch to CAMERA.

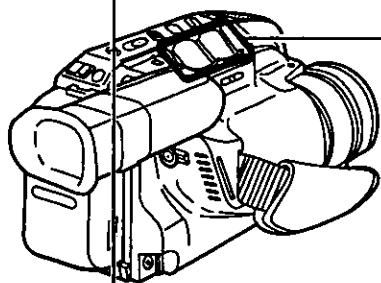
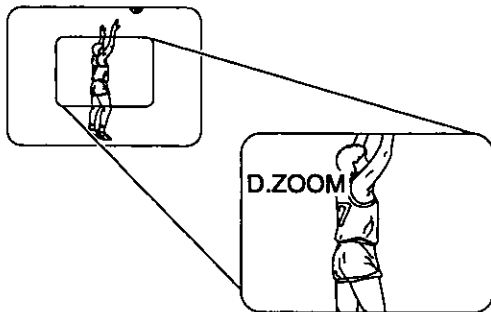

- 1** Press the **DIGITAL ZOOM** button on top of the Palmcorder to select D.ZOOM mode.

Because the image is enlarged digitally, the picture may become distorted when higher magnification levels are used.

- 2** Press and hold the "T" side of the **POWER ZOOM** switch.

Digital Zoom engages when the Optical Power Zoom reaches its maximum of 20x.

- Zoom level is displayed in the EVF (28x maximum).
- Press the "T" or "W" side of the **POWER ZOOM** switch to control the digital zoom level.
- When the level falls below 20x, the optical zooming function will resume.

- 3** For normal 20x zoom mode, press the **DIGITAL ZOOM** button again to turn the Digital Zoom feature off. (D.ZOOM indication should disappear in the EVF display.) (refer to page 26 for normal zoom operation.)

Digital Electronic Image Stabilization System

This feature helps stabilize the picture in situations such as walking or shooting from a moving vehicle.

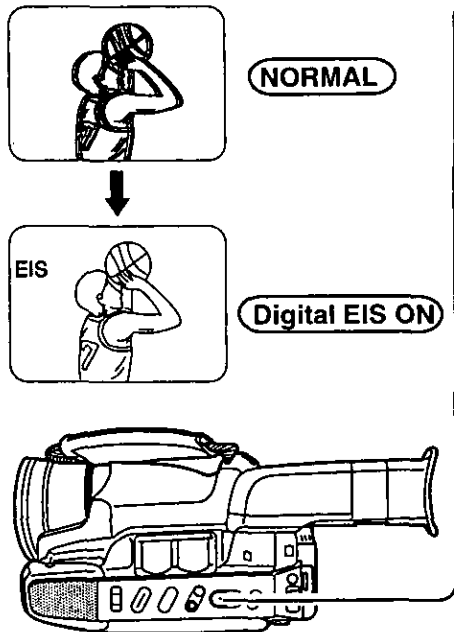

Before you begin...

- Set the POWER switch to CAMERA.

1 Press the EIS button to activate the Digital E.I.S. function. ("EIS" will appear in the EVF.)

- The image in the EVF will be enlarged slightly and the shutter speed will automatically adjust from 1/80 to 1/350 according to the brightness of the subject.

2 Press the EIS button again to cancel.

- You may also use the High Speed Shutter function (from 1/100 to 1/10000). The shutter speed you select remains active even after you cancel the Digital E.I.S. function.
- Be sure that the Digital E.I.S. is turned off when not in use.

Digital E.I.S. may not function when...

- Palmcorder movement is too extreme.
- recording a subject with distinct horizontal or vertical stripes.
- recording in low light situations.
- EIS indicator flashes when the light level is inadequate.
- recording a subject under intense fluorescent light.
- recording a scene with very fast motions.

Negative/Positive Transposer

This special effect feature allows you to change the picture from a positive to a negative image.

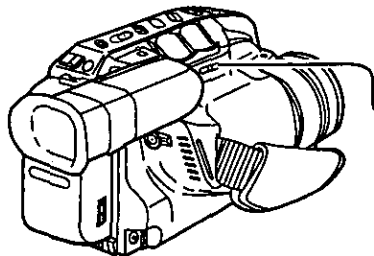

Before you begin...

- Set the POWER switch to CAMERA.

Hold down the NEG/POS button for 2 seconds (approx.) to view or record a negative image.

Press again for normal recording.

Special Features

Motion Security

Great for amateur surveillance applications.

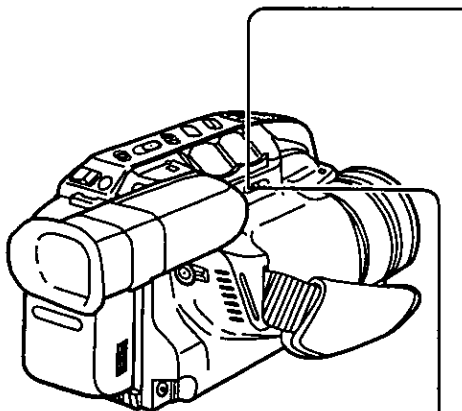

Motion Security recording may start regardless of subject motion when...

- the background is plain, such as a white wall.
- the Palmcorder is pointed at something with distinct horizontal, vertical or oblique stripes, such as a window shade.
- the brightness suddenly changes.

Motion Security recording may not start when...

- motion is very slow or very fast.
- moving object is very small.
- motion is in 1 corner of the viewing area.
- in low light situations (MOTION SECURITY will flash if the light level is inadequate.)
- the background has distinct horizontal or vertical stripes.
- the background is plain, such as a white wall.

Before you begin...

- Connect the Palmcorder to a power source. For extended Palmcorder use, it is recommended to use the AC Adaptor as a power source.
- Insert a cassette with record tab (see page 10).
- Set the POWER switch to CAMERA.
- Aim Palmcorder at desired area.

1 In Record/Pause mode, hold down the **SECURITY MODE** button for approximately 2 seconds to place the Palmcorder in Motion Security Stand-By mode. (If no cassette tape is inserted, "REC" will flash.)



- Palmcorder will start recording approximately 3 seconds after motion is detected.
- If you display the date and time (see page 15), the date and time will also be recorded.

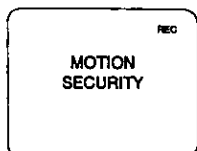

- Recording will stop 30 seconds after the motion ceases.

2 Press the **SECURITY MODE** button once to cancel the Motion Security feature.

Note:

- Make sure the Palmcorder is firmly secure. If the Palmcorder is moved, the Motion Security feature will start, regardless of the subject being recorded.
- Palmcorder cannot be placed in the Motion Security Stand-By mode during recording.
- Record/Pause, Stand-By mode, Digital E.I.S., Color Digital Fade, One-Touch Auto Fade and Negative/Positive Transposer can not be activated while Palmcorder is in the Motion Security Stand-By mode.

Tally ON/OFF during Motion Security Recording

You can choose to have the Tally lamp come on or stay off during Motion Security recording. The Palmcorder is set to **TALLY LAMP OFF** from the factory.

Before you begin...

- Connect the Palmcorder to a power source.
- Insert a cassette with record tab (see page 10).

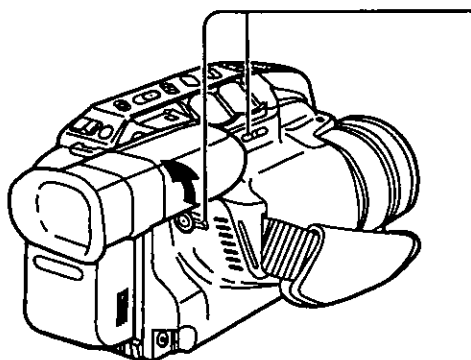

- 1** Continue holding down the **SECURITY MODE** button before and after turning the **POWER** button switch to **CAMERA** until the **SECURITY MODE** menu screen is displayed.

- 2** Press **UP ▲** or **DOWN ▼** to select **TALLY LAMP ON** or **TALLY LAMP OFF**.

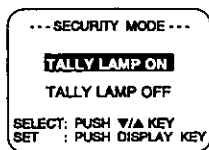
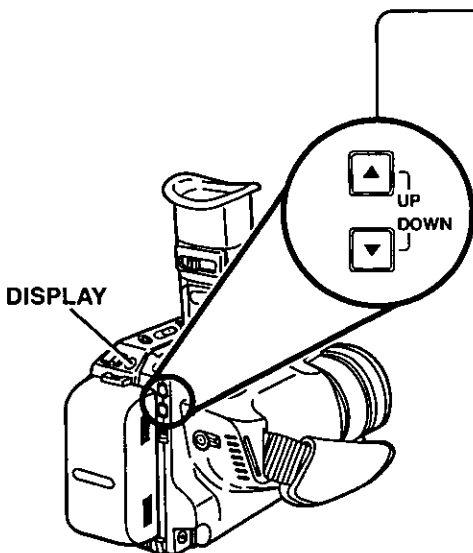

TALLY LAMP ON

Tally Lamp comes on during Motion Security recording.

TALLY LAMP OFF

Tally Lamp stays off during Motion Security recording.

- 3** Press the **DISPLAY** button to set your selection and exit this screen.

Special Features

Intelligent Titler

On selected holidays, such as New Year's Day, the Palmcorder will automatically display the appropriate title when the power is first turned on.

Automatic Title Display

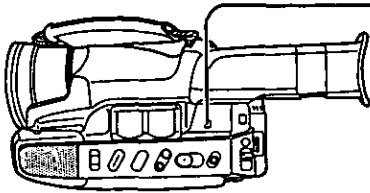

Before you begin...

- Connect the Palmcorder to a power source.
- Insert a cassette with record tab (see page 10).

1 To record the automatically displayed title, press the **RECORD/ PAUSE** button.

2 To remove the title while recording, press the **TITLE** button.

Note:

- You can display **HAPPY ANNIVERSARY**, **HAPPY BIRTHDAY**, **VACATION**, **WEDDING DAY**, or **A SPECIAL DAY** by pressing **TITLE** button repeatedly in Record/Pause mode.
- The Palmcorder will not automatically display a title once it has been removed. To redisplay the title, press **TITLE** in Record/Pause mode.

Dec. 31–Jan. 1	HAPPY NEW YEAR! / CHEERS!
Feb. 14	VALENTINE'S DAY / BE MY VALENTINE
2nd Sunday in May	HAPPY MOTHER'S DAY / WE LOVE YOU!
Last Monday in May	MEMORIAL DAY
3rd Sunday in Jun.	HAPPY FATHER'S DAY / WE LOVE YOU!
Jul. 4	INDEPENDENCE DAY
1st Monday in Sep.	LABOR DAY
Oct. 31	HAPPY HALLOWEEN
4th Thursday in Nov.	HAPPY THANKSGIVING
Dec. 24–25	MERRY CHRISTMAS / HO! HO! HO!
These Titles must be displayed manually.	HAPPY EASTER HAPPY ANNIVERSARY HAPPY BIRTHDAY VACATION WEDDING DAY A SPECIAL DAY

Manual Title Display

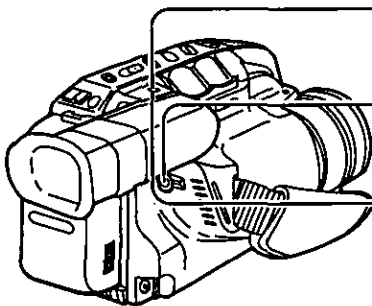

1 In Record/Pause mode, press the **TITLE** button repeatedly to display the desired title from the list shown above.

2 Press the **RECORD/PAUSE** button to record the displayed title.

3 Press the **TITLE** button while recording to remove the title.

Copying your Tapes (dubbing)

Main Operation

Before you begin...

- Connect the Palmcorder to VCR as shown below.
- Turn ON both units.
- Set the recording VCR's Input Signal Selector to LINE.
- Set the Palmcorder POWER switch to VCR.

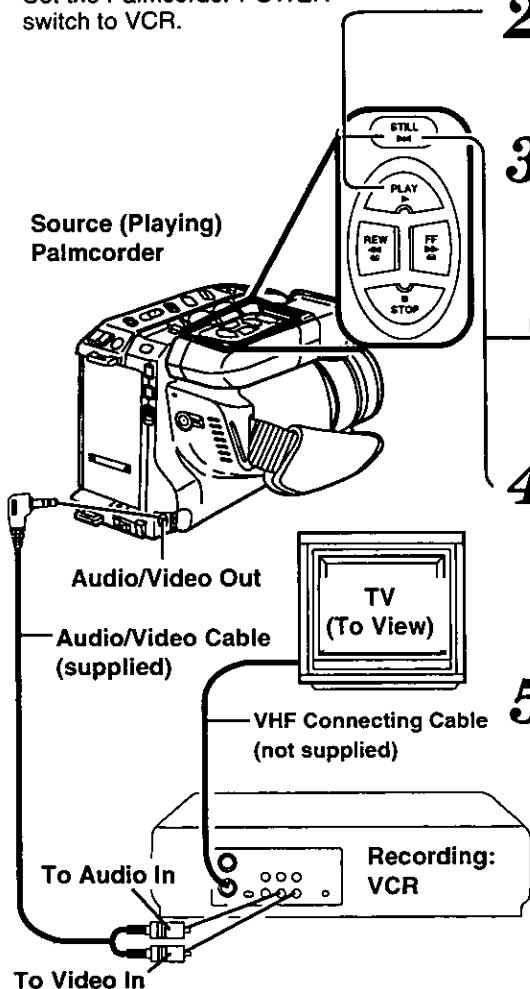

1 Insert a pre-recorded tape into the Palmcorder and a blank tape with a recording tab into your VCR.

2 Press **PLAY** on the Palmcorder and when you find the starting point, press **STILL**.

3 Press **PLAY** and **REC** together on your VCR and then immediately press **STILL/PAUSE**.

4 Press **STILL** on the Palmcorder and press **STILL/PAUSE** on the VCR to simultaneously start both units.

5 Press **STOP** on both units when dubbing is complete.

Note:

- Tapes recorded on other VCRs and used for playback in the Palmcorder must be recorded in SP or SLP mode.
- For technical reasons, dubbing a tape may reduce its quality.

CAUTION:

Unauthorized exchanging and/or copying of copyrighted recordings may be copyright infringement.









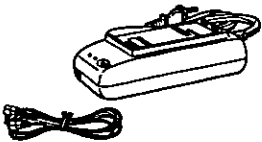

Monitor with your TV

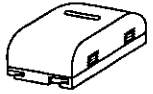
- Turn the TV ON and select its VCR channel (CH3 or CH4).
- Set the VCR/TV Selector on the recording VCR to VCR.

Palmcorder Accessory System

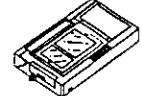
For ordering instructions, see the Accessory Order Form page.

Accessory #	Figure	Description	Price
PV-A17		AC Adaptor with DC Power Cable	\$130.00
PV-BP17		2.4Ah Battery Pack	\$50.00
PV-BP18		1.8Ah Battery Pack	\$45.00
PV-BP15		1.2Ah Battery Pack	\$45.00
PV-C16		Car Battery Cord	\$70.00
PV-RF16		RF Adaptor	\$40.00
PV-P1		VHS PlayPak	\$35.00
PV-H18		Soft Sided Carrying Case	\$49.00

Palmcorder Accessory Order Form

Please photocopy this form when placing an order.

1. Palmcorder Model # _____

2. Items Ordered

Accessory #	Description	Price Each	Quantity	Total Price
Subtotal				
Your State & Local Sales Tax				
Shipping & Handling				5.00
Total Enclosed				

3. Method of payment (check one)

- Check of Money Order enclosed (NO C.O.D.SHIPMENTS)
- VISA Credit Card # _____
- MasterCard Expiration Date _____
- Discover Customer Signature _____

Make Check or Money Order to: MATSUSHITA ACCESSORIES

(Please do not send cash)

4. Shipping information (UPS delivery requires complete street address)

Ship To:

Mr.

Mrs.

Ms.

First _____ Last _____

Phone #:

Day () _____

Street Address _____

Night () _____

City _____ State _____ Zip _____

TO OBTAIN ANY OF OUR OMNIMOVIE/PALMCORDER ACCESSORIES YOU CAN DO ANY OF THE FOLLOWING:

VISIT YOUR LOCAL PANASONIC DEALER

OR

LOCATE YOUR AUTHORIZED ACCESSORY STOCKING DISTRIBUTOR AT 1-800-545-2672

OR

CALL PANASONIC'S ACCESSORY ORDER LINE AT 1-800-332-5368 [6 AM-6 PM M-F, 6-10:30 SAT PACIFIC TIME]

OR

MAIL THIS ORDER TO: PANASONIC SERVICES COMPANY ACCESSORY ORDER OFFICE
20421 84th Avenue South Kent, WA. 98032

For Your Information

Notes Regarding Operations

Attaching Optical Filters and Lenses

Be careful not to touch the lens itself when attaching optical filters and lenses.

Cleaning the EVF (Electronic Viewfinder)

To Remove

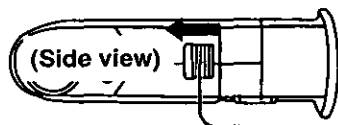

1 Slide and hold the EYEPIECE RELEASE button.

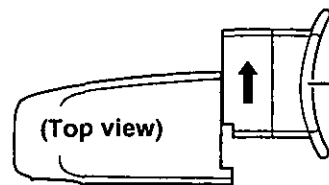

2 Slide the eyepiece in the direction of the arrow. (DO NOT TWIST)

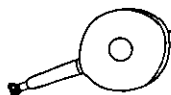
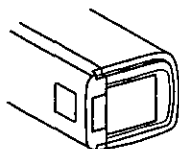

3 Remove any lint or dust particles with a blower, available at photography stores. Do not touch lenses with fingers. Then, replace the eyepiece.

FCC Warning: Any unauthorized changes or modifications to this equipment would void the user's authority to operate.

This device complies with Part 15 of the FCC Rules. Operation is subject to the following two conditions: (1) This device may not cause harmful interference, and (2) this device must accept any interference received, including interference that may cause undesired operation.

Note: This equipment has been tested and found to comply with Part 15 and part 18 of the FCC Rules. These limits are designed to provide reasonable protection against harmful interference when operated in a residential environment.

If this equipment does cause interference to radio or television reception, which can be determined by turning the equipment off and on, use the equipment in another location and/or utilize an electrical outlet different from that used by the receiver.

If necessary, consult the dealer or an experienced radio/TV technician for help. You may find the booklet, 'Something About Interference' available from FCC local regional offices helpful.

Specifications

Power Source:	Compact VHS Palmcorder: DC 6V AC Adaptor: 110/120/220/240V AC, 50/60 Hz Battery: Nickel-Cadmium Type DC 6V
Power Consumption:	Compact VHS Palmcorder: 6V DC 7.5 W (Max. 10.5 W) AC Adaptor: 24W 1.2W (when not in use.)
Video Signal:	EIA Standard (525 lines, 60 fields) NTSC color signal
Video Recording System:	4 rotary heads plus flying erase head. helical scanning system
Audio:	1 track
Pick-Up System:	Sequential color difference field reverse system
Pick-Up Device:	One integral color filter Charge Coupled Device (CCD)
Lens:	20:1 zoom lens, F1:1.6 with auto iris control Focal length: 4.0mm - 80mm Power zoom function Lens filter diameter: 58mm
Viewfinder:	0.5 inch (12.7mm) Liquid Crystal Color Electronic Viewfinder
Minimum Illumination Required:	1.2 lx (F1:1.6) 0.12 footcandles 7 lx (F1:1.6) 0.7 footcandles (EIA Standard)
Operating Temperature:	32°F~104°F (0°C~40°C)
Operating Humidity:	10%~75%
Weight:	Compact VHS Palmcorder: 2.0 lbs. 0.95 kg AC Adaptor: 0.77 lbs. 0.35 kg
Dimensions:	Compact VHS Palmcorder: 4-3/8 (W) x 4-5/8 (H) x 7 (D) inch 111 (W) x 116 (H) x 177 (D) mm AC Adaptor: 2-3/4 (W) x 1-5/8 (H) x 5-3/4 (D) inch 70 (W) x 41 (H) x 145 (D) mm

Weight and dimensions shown are approximate.
Designs and specifications are subject to change without notice.

Before Requesting Service

If you have a problem with your Palmcorder, it may be something you can correct yourself. Check the list below for symptoms and corrections.

Symptom	Correction
No picture in the EVF ...	<ul style="list-style-type: none"> • Make sure a Power Source is connected. (pp. 7, 9) • Make sure the POWER switch is set to VCR or CAMERA. (pp. 20, 23) • Check the Dew Indicator. (p. 17) • Make sure the battery is fully charged. (p. 7) • Make sure all necessary cables are connected correctly and firmly. (p. 24)
Video cassette can't be inserted ...	<ul style="list-style-type: none"> • Make sure a Power Source is connected. (pp. 7, 9) • Insert the cassette with the window side facing out. (p. 10)
Video cassette can't be removed ...	<ul style="list-style-type: none"> • Make sure a Power Source is connected. (pp. 7, 9)
No operation starts when operation buttons are pressed ...	<ul style="list-style-type: none"> • Check the Dew Indicator. (p. 17)
Recording cannot be done ...	<ul style="list-style-type: none"> • Make sure the record tab is still intact. (p. 10) • Check the Battery Indicator. (p. 15) • Check the Dew Indicator. (p. 17)
Auto Focus does not operate ...	<ul style="list-style-type: none"> • Make sure the FOCUS button is set to AUTO. (p. 27) • Make sure the unit is ON, with the POWER switch set to CAMERA (p. 20).
Sound from microphone can't be monitored ...	<ul style="list-style-type: none"> • Make sure the unit is set to REC or Record/Pause mode.
Camera picture is too dark ...	<ul style="list-style-type: none"> • Make sure the HIGH SPEED SHUTTER button is OFF (p. 26).
No playback picture, or the playback picture is noisy or contains streaks ...	<ul style="list-style-type: none"> • Press the Clock Set UP ▲/DOWN ▼ button during playback (Tracking Control) (p. 23).
During playback, the picture shows motion or blurred action ...	<ul style="list-style-type: none"> • Portions of the still picture where the normal speed motion was particularly rapid may produce this effect. This is normal.
"Panasonic IT'S VHS! SO ITS TAPES PLAY IN YOUR VCR ..." appears in the EVF and Monitor ...	<ul style="list-style-type: none"> • Set the POWER switch to CAMERA, and then hold down STOP for 5 seconds (approx).
If the top of your playback picture waves back and forth excessively ...	<ul style="list-style-type: none"> • Because the playback signal is not as stable as an off the air TV signal, the top of your TV screen may be bent or unstable when the tape is played back. This symptom is more noticeable when a tape, recorded on another VCR, is played back. To solve this problem, locate the horizontal hold control on your TV. Turn it slowly to correct the wavy picture. If your TV does not have a horizontal hold control or adjusting the control does not help, some modifications may have to be made to the TV set. Technically this is called "Horizontal AFC time constant change." If such a problem exists, please contact your local TV service center. (Some nominal service charges may be required.)

Before Requesting Service

Cleaning Care for Video Heads



Clogged Video Head

(a) Video Head Cleaning: Your Palmcorder will not normally require head cleaning; however, it is possible that the heads may become clogged when playing an old or damaged tape. If the image on your screen resembles the photograph on the left while playing back a tape, the heads may require cleaning.

(b) Cleaning the Heads: It is recommended that head cleaning be performed by a qualified service technician. Please contact your nearest Panasonic Service Center. An alternate solution is to obtain a head cleaning cassette. There are many types of cleaning cassettes, so be sure to follow the cleaning instructions carefully. Excessive use of the cleaning cassette could shorten head life.

Use this cassette only when a head clogging symptom occurs.

Refer servicing to qualified service personnel.

Auto-Reset

The Palmcorder, provided no tape is inserted, will reset the Backlight, High Speed Shutter and Focus to their AUTO or OFF modes if, after activation, none of these buttons are pressed within 5 minutes.

Request for Service Notice

Please photocopy this form when making a request for service notice.

Request for Service Notice:

In the unlikely event this product needs service.

- Please include your **proof of purchase**.
(Failure to do so will delay your repair.)
- To further speed your repair please provide an explanation of what is wrong with the unit and any symptom it is exhibiting.

Mail this completed form and your Proof of Purchase along with your unit to:
Panasonic Services Company
1705 N. Randall Road
Elgin, IL. 60123-7847
Attn: Camcorder Repair

Index of Controls

Front View

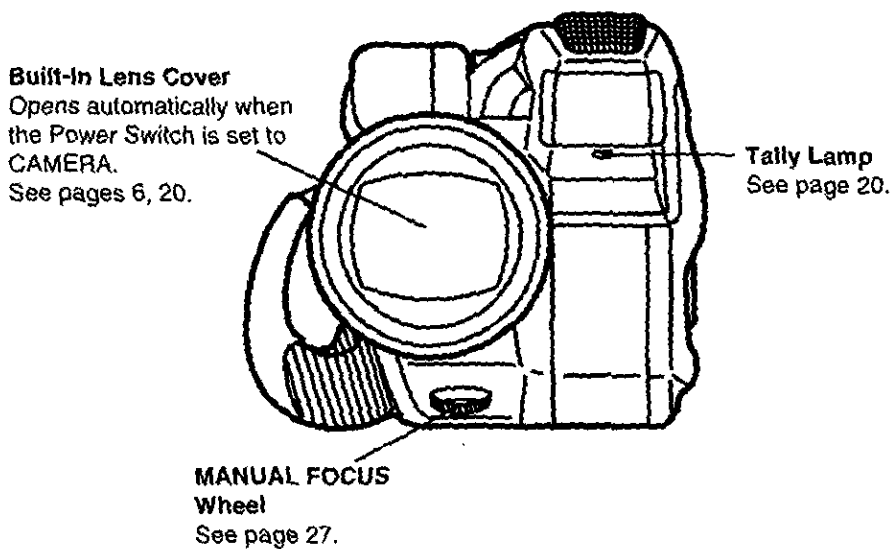
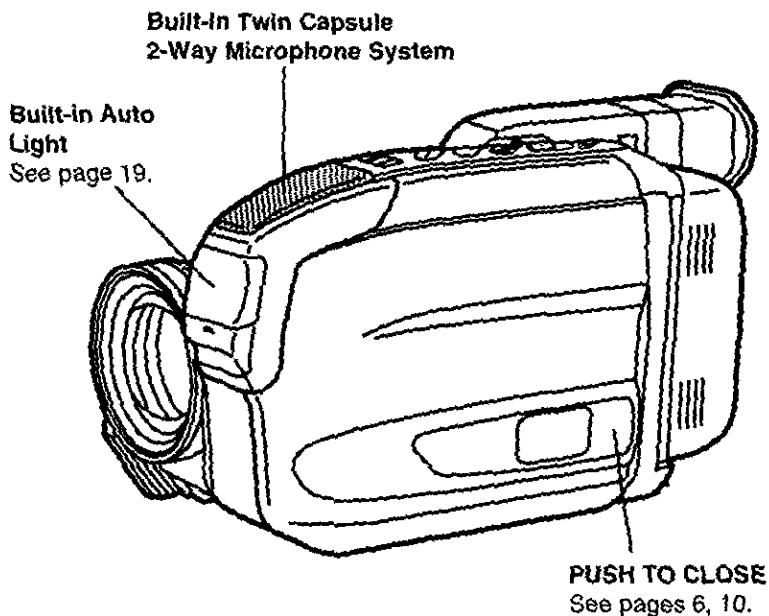

Index of Controls

Rear View

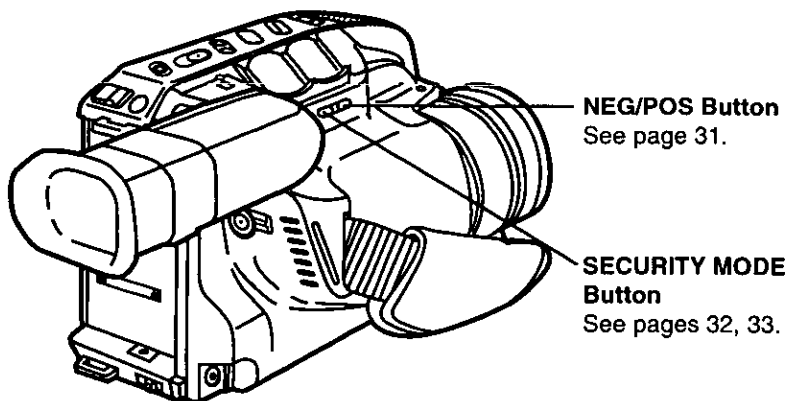
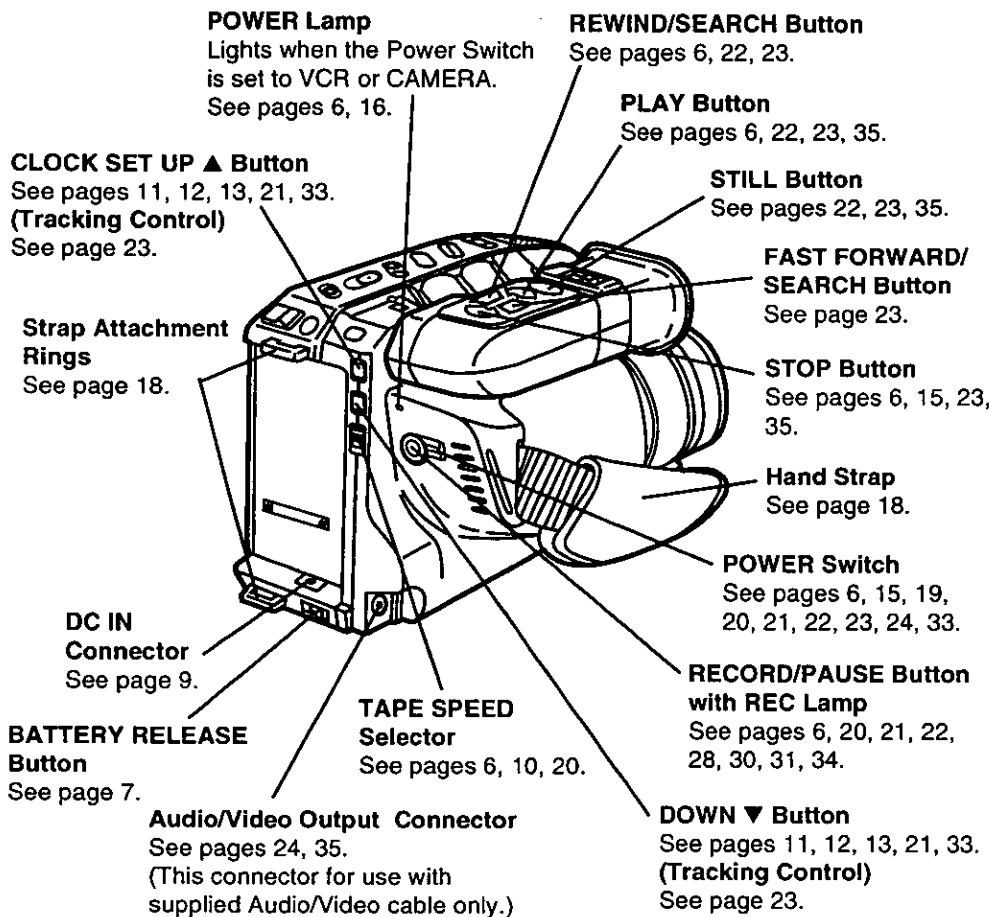

Index of Controls

Top View

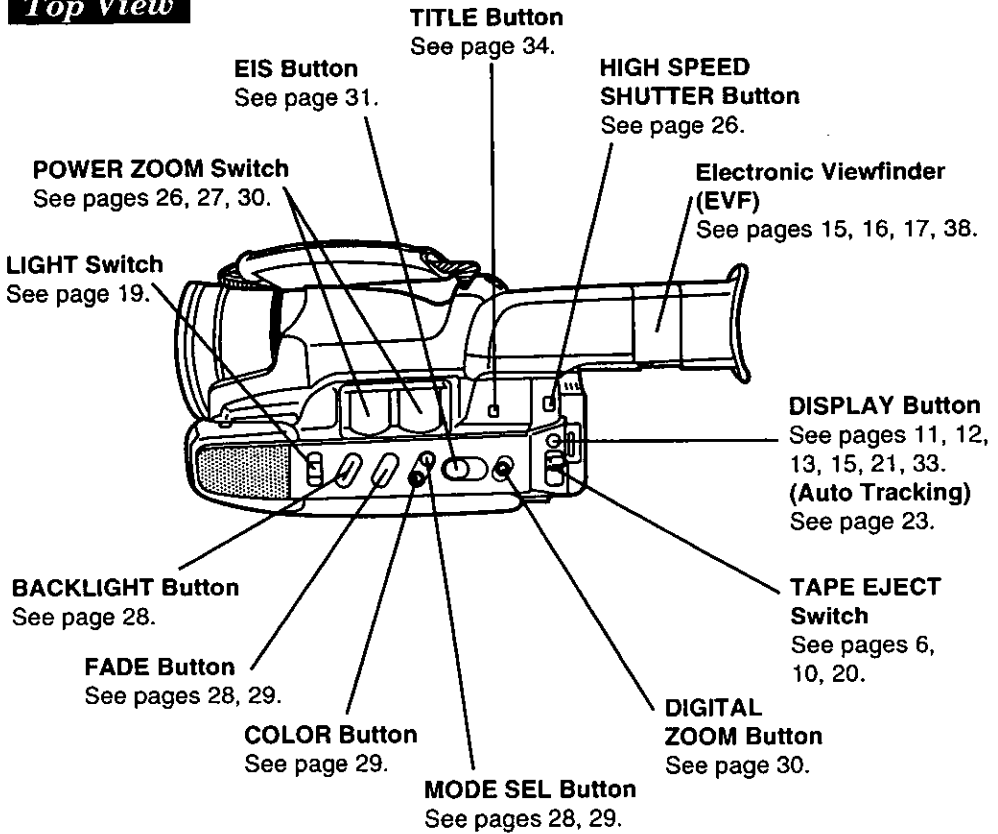

Index of Controls

Underside View

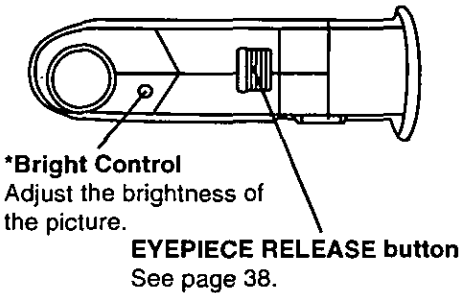
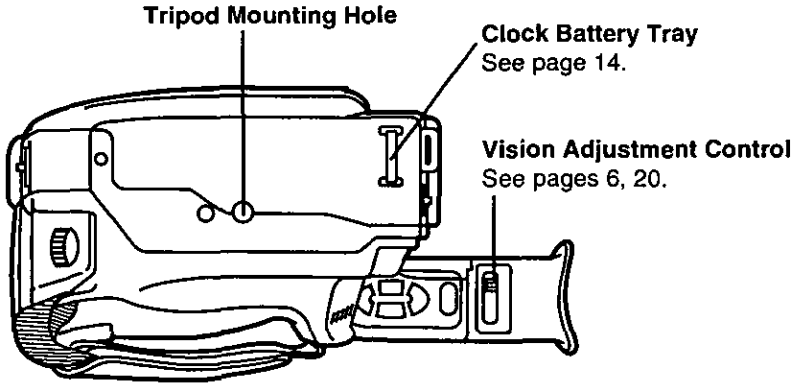

***Note:** This control has been set at the factory. It is not necessary to adjust this control under normal circumstances. But, should it become necessary, be careful to make the adjustment with a small, slender screwdriver so as not to damage the miniature control.

AC Adaptor

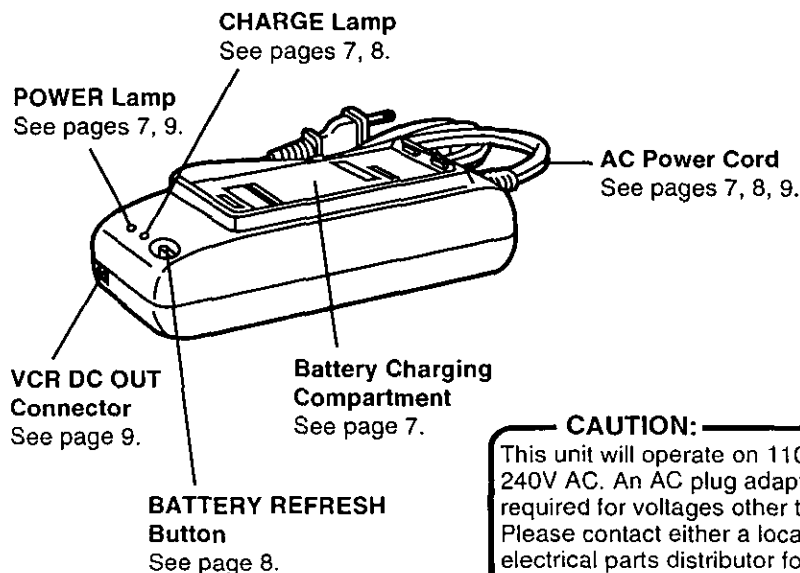

CAUTION:

This unit will operate on 110/120/220/240V AC. An AC plug adaptor may be required for voltages other than 120V AC. Please contact either a local or foreign electrical parts distributor for assistance in selecting an alternate AC plug. We recommend using the accessory power plug adaptor (VJSS0070) in an area which has special AC outlets.

Index

A		Digital Zoom	30	Request for Service	
AC Adaptor	9	Display-off Mode	15	Notice	42
Accessories (Optional)	36	E		RF Adaptor	24, 36
Accessories (Supplied)	2	Easy Edit Stand-by	22	S	
Audio/Video		Erase Protection Tab	10	Safety Precautions	2
Cable	2, 24, 35	EVF Indications	15, 16, 17	Search Speed	23
Auto Daylight Saving		F		Shoulder Strap	2, 18
Time	12	Fade	28	Special Effects Playback	23
Auto Focus	27	H		Specifications	39
Auto-Reset	41	High Speed Shutter	26	Stand-by Quick Release	21
B		High Speed Shutter		Still Picture	23
Backlight	28	Indicator	17, 26	Symptom/Correction	40
Battery Pack	2, 7, 8, 36	L		T	
Battery Remaining		Light	19	10-Second Reminder	16
Indication	15, 16	M		Tab	10
Battery Warning	16	Macro Focus	27	Tally ON/OFF during Motion	
C		Manual Focus	27	Security Recording	33
Camera		Motion Security	32	Tape Speed	10
Recording	20, 21, 22	N		Tape Warning	16
Car Battery Cord	9, 36	Negative/Positive		Titler	34
CH 3/4 Switch	24	Transposer	31	Tracking Control	23
Charging Battery	7	O		V	
Cleaning Care for Video		One-Touch Auto Fade	28	VCR-MODE Indication	17
Heads	41	P		VHF Connecting	
Clock Battery	2, 14	PLAY Indicator	16	Cable	24, 35
Clock Set	11, 12, 13, 14	Playback	23, 24, 25	Video Cassettes (tapes)	10
Color Digital Fade	29	PlayPak	25	Viewing	24
Copying your Tapes	35	Power Supply	7, 8, 9	W	
D		R		Warranty	49, 50
DC Power Cable	2, 9, 36	REC Indicator	16	Z	
DEW Indication	17			Zoom In/Out	26
Digital E.I.S.	31				

Panasonic Consumer Electronics Company, Division of Matsushita Electric Corporation of America
 One Panasonic Way Secaucus, New Jersey 07094

Panasonic Sales Company, Division of Matsushita Electric of Puerto Rico, Inc.
 Ave. 65 de Infantería. Km. 9.5
 San Gabriel Industrial Park, Carolina, Puerto Rico 00985

PANASONIC/QUASAR Video Products Limited Warranty

Panasonic Consumer Electronics Company or Panasonic Sales Company (collectively referred to as "the Warrantor") will repair this product with new or refurbished parts, free of charge, in the USA or Puerto Rico, in the event of a defect in materials or workmanship as follows (all time periods commence from the date of the original purchase):

PRODUCT	PARTS	LABOR
CAMCORDER	ONE (1) YEAR, EXCEPT CCD IMAGE SENSOR CCD IMAGE SENSOR - SIX (6) MONTHS	NINETY (90) DAYS NINETY (90) DAYS
VCR	ONE (1) YEAR	NINETY (90) DAYS
AV MIXER	ONE (1) YEAR	NINETY (90) DAYS
MONITOR-VCR	ONE (1) YEAR, EXCEPT CRT CRT - TWO (2) YEARS	NINETY (90) DAYS CRT- NINETY (90) DAYS CUSTOMER PAYS ALL LABOR CHARGES AFTER 90 DAYS

Monitor-VCR In-home or carry-in Service: 19" (diagonal) CRT / LCD and Larger
Monitor-VCR Carry-in Service: 18" (diagonal) CRT / LCD and smaller

Batteries (if included) - New rechargeable batteries in exchange for defective rechargeable batteries for ten (10) days. Non-rechargeable batteries are not warranted.

Tape (if included) - New video cassette tape in exchange for a defective video cassette tape for five (5) days.

In-home, carry-in or mail-in service, as applicable, in the USA can be obtained during the warranty period by contacting a Panasonic Services Company (PASC) Factory Servicenter listed in the Service Directory. Or call toll free 1-800-545-2672, to locate an authorized PASC Servicenter. Carry-in or mail-in service in Puerto Rico can be obtained during the warranty period by calling the Panasonic Sales Company telephone number listed in the Servicenter Directory.

This warranty is extended only to the original purchaser. A purchase receipt or other proof of the date of the original purchase is required before warranty service is rendered.

This warranty only covers failures due to defects in materials and workmanship which occur during normal use and does not cover normal maintenance, including, but not limited to, video and audio head cleaning. The warranty does not cover damage which occurs in shipment, or failures which are caused by products not supplied by the warrantor, or failures which result from accident, misuse, abuse, neglect, mishandling, misapplication, alteration, modification, faulty installation, set-up adjustments, improper antenna, inadequate signal pickup, maladjustment of consumer controls, improper operation, power line surge, improper voltage supply, lightning damage, commercial use such as hotel, office, restaurant, or other business or rental use of the product, or service by anyone other than a PASC Factory Servicenter or a PASC authorized Servicenter, or damage that is attributable to acts of God.

LIMITS AND EXCLUSIONS

There are no express warranties except as listed above. THE WARRANTOR SHALL NOT BE LIABLE FOR INCIDENTAL OR CONSEQUENTIAL DAMAGES (INCLUDING, WITHOUT LIMITATION, DAMAGE TO TAPES) RESULTING FROM THE USE OF THIS PRODUCTS, OR ARISING OUT OF ANY BREACH OF THE WARRANTY. ALL EXPRESS AND IMPLIED WARRANTIES, INCLUDING THE WARRANTIES OF MERCHANTABILITY AND FITNESS FOR PARTICULAR PURPOSE, ARE LIMITED TO THE APPLICABLE WARRANTY PERIOD SET FORTH ABOVE. Some states do not allow the exclusion or limitation of incidental or consequential damages, or limitations on how long an implied warranty lasts, so the above exclusions or limitations may not apply to you.

This warranty gives you specific legal rights and you may also have other rights which vary from state to state.

If a problem with this product develops during or after the warranty period, you may contact your dealer or Servicenter. If the problem is not handled to your satisfaction, then write to the Customer Satisfaction Center at the Panasonic Consumer Electronics Company address above.

SERVICE CALLS WHICH DO NOT INVOLVE DEFECTIVE MATERIALS OR WORKMANSHIP AS DETERMINED BY THE WARRANTOR, IN ITS SOLE DISCRETION, ARE NOT COVERED. COSTS OF SUCH SERVICE CALLS ARE THE RESPONSIBILITY OF THE PURCHASER.

warvid 2/11/97

Warranty

PRODUCT INFORMATION • OPERATION ASSISTANCE • LITERATURE REQUESTS • DEALER LOCATIONS

Customer Service Center 2F-3, One Panasonic Way, Secaucus, NJ 07094 (Headquarters)
201-348-9090 (9:00am-8:00pm Monday-Friday, EST)

ACCESSORY PURCHASES

1-800-332-5368 (Consumer Orders Only)

Panasonic Services Company 20421 84th Avenue South Kent, WA 98032
(6 am to 6 pm Monday-Friday; 6 am to 10:30 am Saturday; PST)
(Visa, Mastercard, Discover card, American Express, Check)

AUTHORIZED SERVICENTERS • PARTS DISTRIBUTOR LOCATIONS

To locate an independent authorized servicer or parts distributor in your area, within the USA dial toll free 1-800-545-2672, 24 hours a day, 7 days a week.

PRODUCT REPAIRS

MAIL TO :

Centralized Factory Servicer

Panasonic Services Company
1705 N. Randall Road,
Elgin, IL 60123-7847

Attention: Camcorder Repair

Please carefully pack and ship, prepaid and insured, to the Elgin centralized repair Factory Servicer. While there will be added handling delays, you may bring your unit to one of the following locations who will then forward the unit to Elgin for repair.

Customer's in Puerto Rico, please ship or carry in to location below ("Service in Puerto Rico").

Factory Servicers

CALIFORNIA

6550 Katella Avenue
Cypress, CA 90630
Phone (714) 373-7426
Fax (714) 894-8534

800 Dubuque Avenue S.
San Francisco, CA 94080
Phone (415) 871-6373
Fax (415) 871-6840

20201 Sherman Way
Suite 102
Canoga Park, CA 91306
Phone (818) 709-1775
Fax (818) 709-2165

3878 Ruffin Road
Suite A
San Diego, CA 92123
Phone (619) 560-9200
Fax (619) 560-1831

COLORADO

1640 South Abilene Suite D
Aurora, CO 80012
Phone (303) 752-2024
Fax (303) 752-0610

FLORIDA

3700 North 29th Avenue
Suite 102
Hollywood, FL 33020
Phone (954) 925-2880
Fax (954) 925-5224

4710 Eisenhower Boulevard
Suite A1
Tampa, FL 33634
Phone (813) 884-4746
Fax (813) 886-4564

GEORGIA

8655 Roswell Road
Suite 100
Atlanta, GA 30350
Phone (770) 518-6301
Fax (770) 518-6306

HAWAII

99-859 Iwaiwa Street
Aiea, Hawaii 96701
Phone (808) 468-1996
Fax (808) 468-4369

ILLINOIS

*1703 North Randall Road
Elgin, IL 60123
12:30 to 4:30, Mon-Fri
Phone (847) 468-5464
Fax (847) 468-5465

9060 Golf Road
Niles, IL 60714
Phone (847) 608-1010
Fax (847) 299-1710

MARYLAND

Sulphur Springs
Business Park
1838 Sulphur Springs Road
Baltimore, MD 21227
Phone (410) 242-2607
Fax (410) 247-3047

MASSACHUSETTS

60 Glacier Drive, Suite G
Westwood, MA 02090
Phone (617) 329-4280
Fax (617) 329-0586

*Pick-up/drop-off only

MICHIGAN

37048 Van Dyke Avenue
Sterling Heights, MI 48312
Phone (810) 939-2060
Fax (810) 839-2638

MINNESOTA

7850-12th Avenue South
Airport Business Center
Bloomington, MN 55425
Phone (612) 854-8624
Fax (612) 854-2089

OHIO

2236 Waycross Road
Cincinnati, OH 45240
Phone (513) 851-4180
Fax (513) 851-8443

PENNSYLVANIA

2221 Cabot Boulevard West
Suite B
Langhorne, PA 19047
Phone (215) 741-0661
Fax (215) 741-0521

Chartiers Valley Shopping
Center

1025 Washington Pike
Bridgeville, PA 15017
Phone (412) 257-4522
Fax (412) 257-4650

TENNESSEE

919-8th Avenue South
Nashville, TN 37203
Phone (615) 244-4434
Fax (615) 244-6713

TEXAS

7482 Harwin Drive
Houston, TX 77036
Phone (713) 781-1528
Fax (713) 781-0843

13615 Welch Road
Suite 101
Farmers Branch, TX 75244
Phone (972) 385-1975
Fax (972) 960-7626

WASHINGTON

20425-84th Avenue South
Kent, WA 98032
Phone (206) 872-7922
Fax (206) 872-0918

Service in Puerto Rico

Matsushita Electric
of Puerto Rico, Inc.
Panasonic Sales Company/
Factory Servicer
Ave. 85 de Infanteria, Km. 9.5
San Gabriel Industrial Park
Carolina, Puerto Rico 00985
Phone (787) 750-4300
Fax (787) 768-2910

REPAIR INQUIRIES

Regional Customer Care Department

EAST(PCE)

2221 Cabot Boulevard West
Suite A
Langhorne, PA 19047
Phone (215) 741-0678
Fax (215) 750-6492

Covers:

CT, DE, ME, MD, MA, NH, NJ,
NY, PA, RI, VT, VA, DC, WV

EAST (PCE)

1225 Northbrook Parkway
Suite 2-390
Suwanee, GA 30174
Phone (770) 338-6860
Fax (770) 338-6548

Covers:

AL, FL, GA, MS, NC, SC, TN

CENTRAL (PCC)

1707 North Randall Road
Elgin, IL 60123
Phone (847) 468-5530
Fax (847) 468-5528

Covers:

AR, IL, IN, IA, KS, KY, LA, MI,
MN, MO, NE, ND, OK, SD, TX,
WI, OH

WEST (PCW)

6550 Katella Avenue
Cypress, CA 90630
Phone (714) 373-7440
Fax (714) 373-7447

Covers:

AK, AZ, CA, CO, ID, MT, NV,
NM, OR, UT, WA, WY, HI

Spanish Quick Use Guide/Guía Para Uso Rápido

PREPARATIVOS

- Conectar la videocámara a una fuente de alimentación (batería, adaptador de CA o cable para batería de coche).
- Encender el aparato.
- Introducir el casete en el compartimiento de casetes.

GRABACION

1 Fije el interruptor a la posición de CAMERA.

2 Deslice el botón EJECT para abrir la puerta.

3 Introduzca la cinta.

4 Cierre la puerta presionando PUSH TO CLOSE.

5 Seleccione la velocidad de grabación.

6 Oprimir el botón de grabación/pausa (RECORD/PAUSE) para comenzar a filmar.

7 Volver a oprimir el botón de grabación/pausa (RECORD/PAUSE) cuando se desea hacer una pausa en la grabación.

PAUSE

PAUSE

REC

PAUSE

Spanish Quick Use Guide/Guía Para Uso Rápido

- Conectar la videocámara a una fuente de alimentación (batería, adaptador de CA o cable para batería de coche).
- Encender el aparato.
- Introducir el casete en el compartimiento de casetes.

REPRODUCCION NORMAL

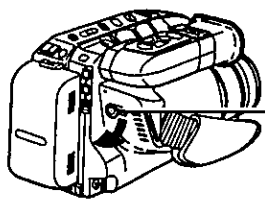

1 Fije el interruptor a la posición de VCR.

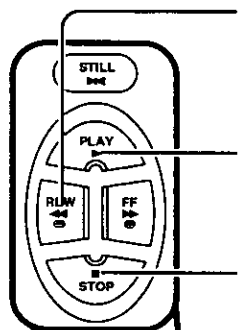

2 Rebobinar la cinta con el botón de rebobinado (REWIND) (si fuera necesario).

3 Oprimir el botón de reproducción (PLAY) para que aparezcan las imágenes en la pantalla.

4 Oprimir el botón de parada (STOP) cuando se desea parar la reproducción.

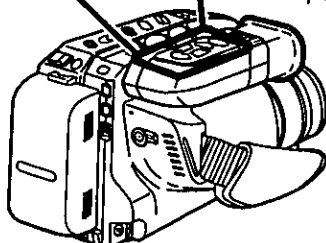

En el visor

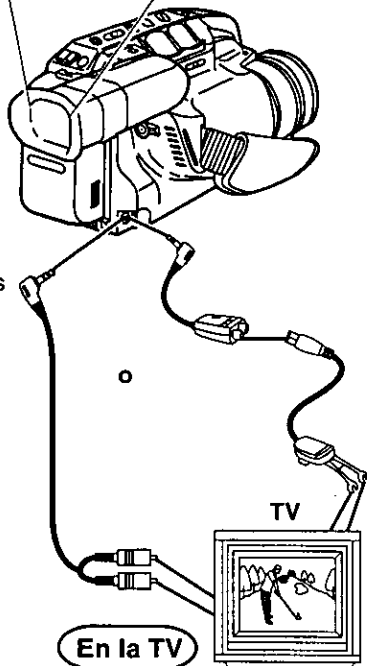

En la TV

REPRODUCCION CON EFECTOS ESPECIALES

PARA LOCALIZAR RAPIDAMENTE UNA ESCENA ESPECIFICA

- Oprimir el botón de localización (SEARCH).

PARA CONGELAR UNA IMAGEN

- Oprimir el botón de pausa/imagen fija (PAUSE/STILL).
- Oprimir nuevamente el botón cuando se desea continuar reproduciendo.

Panasonic Consumer Electronics
Company, Division of Matsushita
Electric Corporation of America
One Panasonic Way Secaucus,
New Jersey 07094

Panasonic Sales Company,
Division of Matsushita Electric of
Puerto Rico, Inc. ("PSC")
Ave. 65 de Infantería, Km. 9.5
San Gabriel Industrial Park
Carolina, Puerto Rico 00985

Free Manuals Download Website

<http://myh66.com>

<http://usermanuals.us>

<http://www.somanuals.com>

<http://www.4manuals.cc>

<http://www.manual-lib.com>

<http://www.404manual.com>

<http://www.luxmanual.com>

<http://aubethermostatmanual.com>

Golf course search by state

<http://golfingnear.com>

Email search by domain

<http://emailbydomain.com>

Auto manuals search

<http://auto.somanuals.com>

TV manuals search

<http://tv.somanuals.com>