

# User's Manual

CAMILEO S20

**TOSHIBA**  
Leading Innovation >>>

# Introduction

Welcome and thank you for choosing a TOSHIBA product.

For your convenience, your TOSHIBA product is furnished with two guides:

- a) a Quick Start Guide, and
- b) this comprehensive PDF User's Manual.

# Contents

<b>Section 1 Getting to Know Your Camcorder</b> .....	<b>6</b>
<b>Overview</b> .....	<b>6</b>
<b>Check the Components</b> .....	<b>6</b>
<b>Safety Instructions</b> .....	<b>7</b>
<b>System Requirements</b> .....	<b>7</b>
<b>Front View</b> .....	<b>8</b>
<b>Rear View</b> .....	<b>8</b>
<b>Side View</b> .....	<b>9</b>
<b>Bottom View</b> .....	<b>9</b>
<b>Section 2 Getting Started</b> .....	<b>10</b>
<b>Loading the Battery</b> .....	<b>10</b>
<b>Inserting and Removing an SD Card (Optional)</b> .....	<b>10</b>
<b>Turning the Camcorder On and Getting Started</b> .....	<b>11</b>
<b>Turning the Camcorder Off</b> .....	<b>11</b>
<b>Section 3 Record Mode</b> .....	<b>12</b>
<b>Button Function</b> .....	<b>12</b>
<b>LCD Monitor Information</b> .....	<b>13</b>
<b>Movie Recording</b> .....	<b>15</b>
<b>Using the Pre-Record Function</b> .....	<b>15</b>
<b>Picture Recording</b> .....	<b>16</b>
<b>Taking Close up Pictures/Movies</b> .....	<b>16</b>
<b>Using Digital Light or Light Function</b> .....	<b>16</b>
<b>Using Digital Zoom</b> .....	<b>16</b>
<b>Options for Record Menu</b> .....	<b>17</b>
<b>Operations for Record Mode</b> .....	<b>17</b>
<b>Movie Resolution</b> .....	<b>18</b>
<b>Picture Resolution</b> .....	<b>18</b>
<b>White Balance</b> .....	<b>19</b>
<b>Scene</b> .....	<b>19</b>
<b>Movie Effect</b> .....	<b>20</b>
<b>Picture Effect</b> .....	<b>22</b>

# Contents

<b>Section 4 Playback Mode.....</b>	<b>23</b>
<b>Button Function .....</b>	<b>23</b>
<b>LCD Monitor Information.....</b>	<b>24</b>
<b>Operations for Playback Mode .....</b>	<b>25</b>
<b>Movie Playback .....</b>	<b>26</b>
<b>Picture Playback .....</b>	<b>27</b>
<b>Section 5 Setting Your Camcorder .....</b>	<b>28</b>
<b>Setting Menu .....</b>	<b>28</b>
<b>Section 6 Viewing Pictures and Movies on TV .....</b>	<b>32</b>
<b>Connecting to a High-Definition 16:9(Wide) TV .....</b>	<b>32</b>
<b>Connecting to a non-high-definition 4:3 TV .....</b>	<b>32</b>
<b>Section 7 Viewing Movie &amp; Picture on PC.....</b>	<b>33</b>
<b>Installing Bundled Software.....</b>	<b>33</b>
<b>Transferring Pictures or Movies to a Computer.....</b>	<b>33</b>
<b>Section 8 Burning the Recorded Clip into a DVD.....</b>	<b>34</b>
<b>Section 9 Uploading Video Files to YouTube.....</b>	<b>37</b>
<b>Section 10 Video File Converter.....</b>	<b>42</b>
<b>Section 11 Specifications .....</b>	<b>44</b>
<b>Section 12 Troubleshooting .....</b>	<b>45</b>

# Contents

<b>Section 13 Other Information .....</b>	<b>46</b>
<b>TOSHIBA Support .....</b>	<b>46</b>
<b>Operating Environment Conditions .....</b>	<b>46</b>
<b>Regulatory Information .....</b>	<b>46</b>
<b>Additional Information.....</b>	<b>48</b>
<b>About the battery pack .....</b>	<b>48</b>

# Section 1

## Getting to Know Your Camcorder

### Overview

The camcorder with 5 Mega Pixel sensor can take H.264 movies. By way of using H.264 technology, more videos can be taken within certain amount of memory. High quality images with up to 16 megapixels can also be delivered smoothly. With a color LCD monitor, users can compose images and examine them easily.

The camcorder also features movie recording at an HD resolution of 1920x1080. You can also connect it to an HDTV via an HDMI cable, and easily playback the recorded high-definition videos on the wide screen HDTV.

Moreover, the camcorder has an advanced uploading feature. With the exclusive built-in **YouTube Direct** application, you can upload the videos captured by the camcorder to YouTube more effortlessly. ISO sensitivity and color balance can either be adjusted automatically or changed manually. A 4x digital zoom helps you to control over the movies and pictures you take.

The varied effect options, such as Time Lapse and Slow Motion, make recording more fun.

The built-in memory allows you to take pictures and to record movies without a memory card. The memory card slot allows users to increase the storage capacity.



#### Note

*Partial memory of the built-in memory is used for the camcorder's Firmware code.*

### Check the Components

Unpack the package and make sure all standard accessories listed are included:

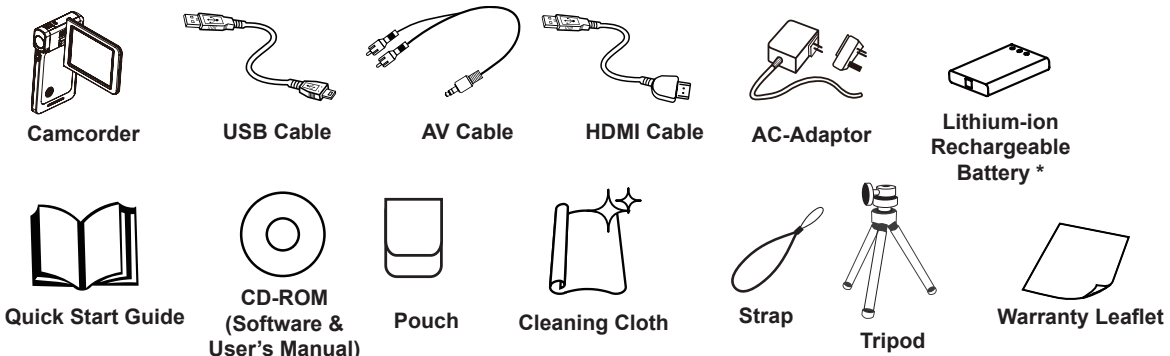

\*preinstalled in camcorder device



#### Note

*Please remove the lens protect film on lens before use.*

## Safety Instructions

1. Do not drop, puncture or disassemble the camcorder; otherwise the warranty will be voided.
2. Avoid all contact with water, and dry hands before using.
3. Do not expose the camcorder to high temperature or leave it in direct sunlight. Doing so may damage the camcorder.
4. Use the camcorder with care. Avoid pressing hard on the camcorder body.
5. For your own safety, avoid using the camcorder when there is a storm or lightning.
6. Do not use batteries of different specifications. Doing so may lead to the potential for serious damage.
7. Remove the battery during long periods between usage, as a deteriorated battery may affect the functionality of the camcorder.
8. Remove the battery if it shows signs of leaking or distortion.
9. Use only the accessories supplied by the manufacturer.
10. Keep the camcorder out of the reach of infants.
11. Risk of explosion if battery is replaced by an incorrect type.
12. Dispose of used batteries according to the instructions.

## System Requirements

- Microsoft Windows XP/Vista/7
- Intel Pentium 4 2.4GHz or above
- 512 MB RAM
- CD-ROM Drive
- 1 GB free HDD space
- Available USB port
- 16-bit Color Display



### **Note**

*The LCD screen is manufactured using extremely high-precision technology. However, some tiny black and/or bright dots (white, red, blue or green) may appear on the LCD screen. These dots are a normal result of the manufacturing process, and do not affect the recording.*

## Front View

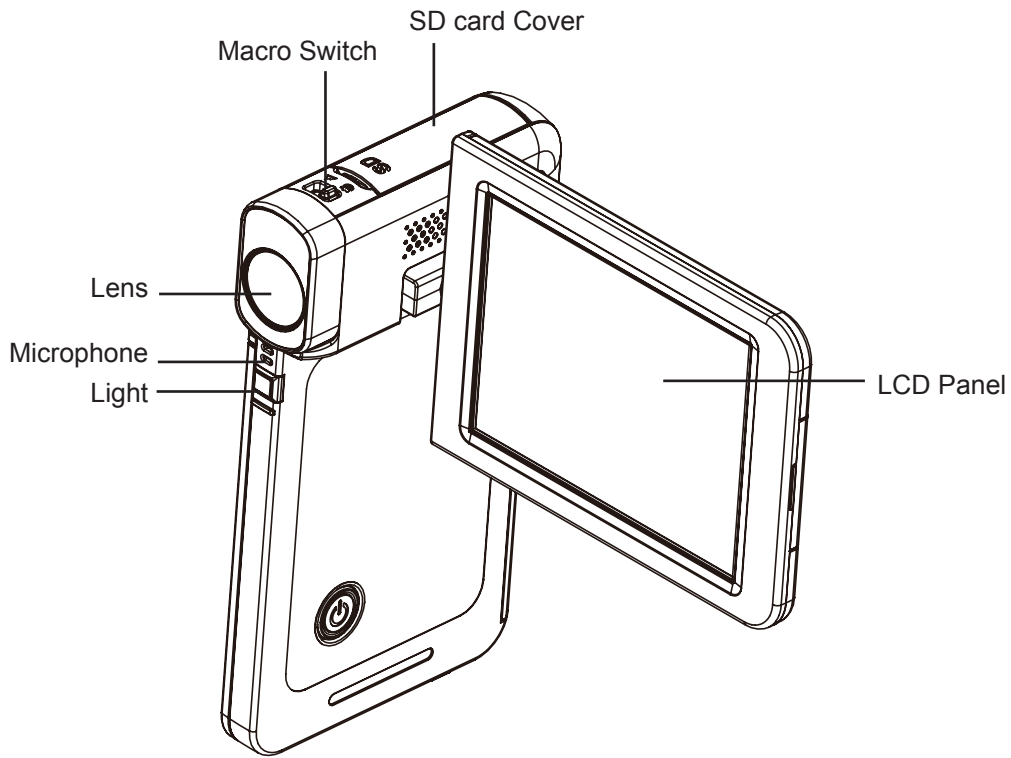

## Rear View

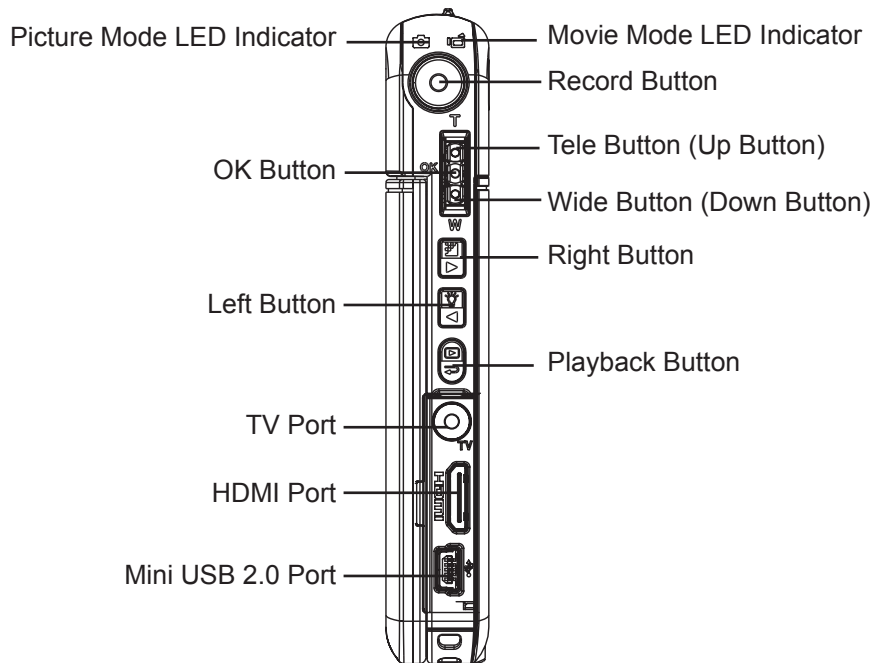



## Side View

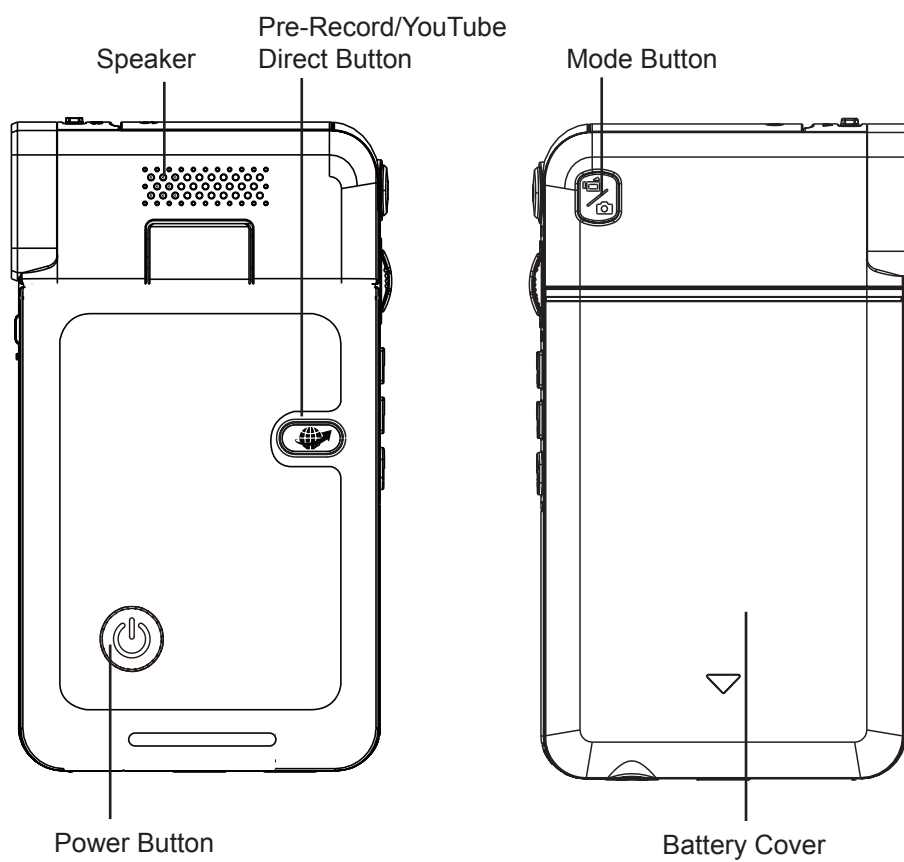

## Bottom View

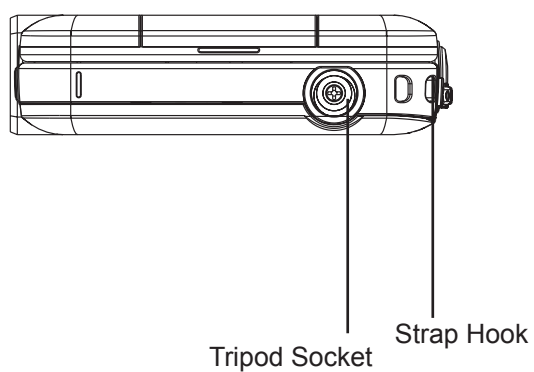

## Section 2 Getting Started

### Loading the Battery

Before using the camcorder, users must load the Lithium-ion rechargeable battery come within the package.

1. Insert the battery according to the correct polarity marks (+ or -).
2. Close the battery cover firmly.

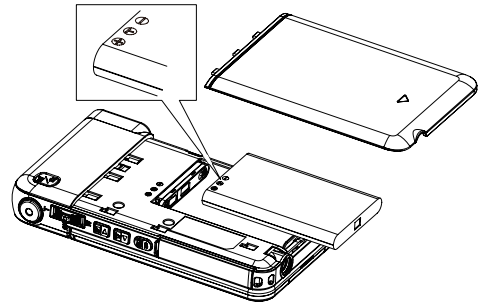

#### Note

*Please remove the insulator on battery connection before use.*

### Inserting and Removing an SD Card (Optional)

The camcorder comes with an internal memory which allows you to store pictures and movies. You can expand the memory capacity by using an optional SD/SDHC memory card.

1. Insert the memory card into the slot. Please refer to the figure on the right side.
2. To remove an installed SD card, press the card inwards to release it.
3. When the card pops out, gently remove it from its slot.
4. Recommended memory capacity: 1GB or above.

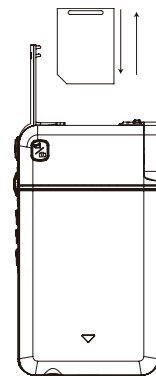



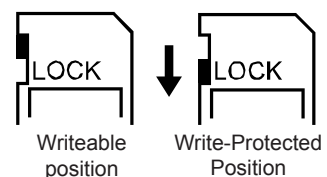

#### Note

- When a memory card is fitted, movies/pictures are saved on the card rather than on the built-in memory.
- *Protecting Data on an SD Card: SD Card is read-only when it is locked. No pictures or movies can be recorded when the SD card is locked. Make sure the lock is on the writeable position before recording any media.*



## Turning the Camcorder On and Getting Started







- To turn on the camcorder:
  1. Flip out the LCD panel; the camcorder will turn on automatically.
  2. Or press Power Button for one second to turn it on.
- To record movies: Press Mode Button to switch to the Movie Record mode. (The Movie Mode LED Indicator  will light up.) Press Record Button to record movies.
- To take a picture: Press Mode Button to switch to the Picture Record mode. (The Picture Mode LED Indicator  will light up.) Press Record Button to take pictures.
- To take a picture during movie recording: When recording movies, press Mode Button (  ) to capture the image. The Dual record icon (  ) appears on the LCD monitor.
- To view stored movies and pictures: Press Playback Button to switch to the Playback mode. Press Mode Button to switch between Movie Preview Screen and Picture Preview Screen.

## Turning the Camcorder Off

- To turn off the camcorder: You can either press the Power Button for one second, or you can place the LCD panel back to its original position.

## Section 3 Record Mode



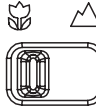







### Button Function

















	<p><b>Mode Button:</b></p> <ol style="list-style-type: none"> <li>1. Switch between Movie Mode and Picture Mode.</li> <li>2. When recording movies, press to capture the image.</li> </ol>
	<p><b>Record Button:</b></p> <ol style="list-style-type: none"> <li>1. In Movie Record Mode, press to take movies. To stop recording, press it again.</li> <li>2. In Picture Record Mode, press to take pictures.</li> </ol>
	<p><b>Playback Button:</b></p> <ol style="list-style-type: none"> <li>1. Switch between Record / Playback Mode.</li> <li>2. For quick review, press it after recording.</li> <li>3. In Record menu, press to exit.</li> </ol>
	<p><b>Direction Button:</b></p> <p><b>Right Button:</b> Resolution Switch (FHD (1080p30)/WVGA 60) (High (16MP)/Std (5MP)). In Record menu, press to switch to the submenu.</p> <p><b>Left Button:</b> Digital Light ON/ Light ON/ Light OFF. In Record menu, press to return to the main menu.</p> <p><b>Tele Button (Up Button):</b> Zoom In. Move between the option items.</p> <p><b>Wide Button (Down Button):</b> Zoom out. Move between the option items.</p> <p><b>OK Button:</b> Menu On / Validate the setting.</p>
	<p><b>Power Button:</b> Press down for one second to turn on or turn off the camcorder.</p>
	<p><b>Pre-Record/YouTube Direct Button:</b></p> <p>In Record Mode, press to activate the Pre-Record function and the movies will be recorded 3 seconds before the Record Button is pressed.</p>
	<p><b>Macro Switch:</b> Switch between Macro Mode and Normal Mode.</p>

## LCD Monitor Information

The indicators shown below may display on LCD when movies and pictures are recorded:



(1)	Movie Resolution	
		FHD (1080p 30)
		HD (720p 30)
		WVGA60
		VGA (4:3)
		Slow Motion (Record movies at 320x240(QVGA) resolution.)
	Picture Resolution	
		High (16MP)
		Standard (5MP)
	Low (3MP)	
(2)	<b>00:05:30</b>	Recording time of the movie that can still be taken at current resolution
	<b>71</b>	Number of images that can still be taken at current resolution
(3)		Self-timer enabled
		Dual Record
(4)		Stabilization



(5)		Pre-Record Mode
		Time Lapse
(6)	Scene	
		Skin
		Night
		Backlight
(7)		Macro Position Focusing
(8)		Manual White Balance
(9)		Motion Detection
(10)		Zoom meter: FHD (1080p 30): 1X (1X Digital zoom) Other video resolution: 1X~4X (4X Digital zoom)
(11)		Digital Light On
		Light On
(12)		SD Card Inserted
(13)		Battery: full power
		Battery: medium power
		Battery: low power
		Battery: empty power
		DC power mode







**Note**

Scene: B/W / Classic / Negative effect can be previewed immediately without indicator on the LCD.

## Movie Recording

- In Movie Record Mode (The Movie Record LED Indicator  lights up), press Record Button to start recording. When a movie is being recorded, a time indicator will display on the LCD monitor. To stop recording, press Record Button again.
- Optional function: Dual record: press Mode Button (  ) to capture the image. The Dual record icon (  ) appears on the LCD monitor.
- Press Playback Button to view the recorded movies.
- Four resolution settings are available:



Video Quality	
	FHD (1080p 30)
	HD (720p 30)
	WVGA60
	VGA (4:3)



### Note

- The image resolution captured during movies recording is the same as the video resolution.

## Using the Pre-Record Function

- The Pre-record function ensures that you will not miss any critical recording opportunities, The movies are recorded 3 seconds before the Record Button is pressed.
- To use the Pre-Record function:
  1. Press the Pre-Record Button (  ) in Record Mode. The Pre-Record icon (  ) appears on the LCD monitor.
  2. Aim the camcorder at the subject and position it securely.
  3. Press the Record Button to start recording. (The camcorder records 3 seconds before you actually press the Record Button.)
- To use the function again, set it again.



### Note

- Time Lapse function can not be used when the Pre-Record function is activated.

## Picture Recording







- In Picture Record Mode (The Picture Record LED Indicator  lights up), press Record Button to take pictures.
- Press Playback Button to view the picture.
- Three resolution settings are available:

Image Quality	
	<b>High Quality:</b> 16 Mega Pixels
	<b>Standard Quality:</b> 5 Mega Pixels
	<b>Low Quality:</b> 3 Mega Pixels

## Taking Close up Pictures/Movies



- Slide the macro switch to change the focus range for different distances of objects.
- To take close-up pictures:
  1. Slide the macro switch to Macro (  ).
  2. Press Record Button to start recording or to take picture.
- In Macro Mode, the macro icon (  ) will appear on the LCD monitor.



### Note

Remember to turn the macro switch back to Normal (  ) when you are not taking close-up pictures.

## Using Digital Light or Light Function

- To use light function:
  1. Press Right Button, the Digital Light icon (  ) will appear on the screen to extend dynamic range for backlight and high contrast sense so that the objects will be brighter and clearer.
  2. Press again, the Light icon (  ) will appear on the screen. The light will be turned on and keeps providing light.
  3. Press Record Button to start recording or to take picture.
  4. Press Right Button again to suspend the light.



### Note

The light will be disabled automatically when battery power is low (  ).

## Using Digital Zoom

- The digital zoom magnifies images when recording movies or taking pictures.
  1. To zoom in/out, press the Tele/Wide Button.
  2. The digital zoom can be set from 1x (FHD 1080p 30)/ 1x to 4x (for other video resolution).



## Options for Record Menu



### Movie Record Mode Menu

Movie Resolution	White Balance	Scene	Effect
<ul style="list-style-type: none"> <li>FHD (1080p 30)</li> <li>HD (720p 30)</li> <li>WVGA 60</li> <li>VGA (4:3)</li> </ul>	<ul style="list-style-type: none"> <li>Auto</li> <li>Daylight</li> <li>Fluorescent</li> <li>Tungsten</li> </ul>	<ul style="list-style-type: none"> <li>Auto</li> <li>Skin</li> <li>Night</li> <li>Backlight</li> <li>B/W (Black/White)</li> <li>Classic</li> <li>Negative</li> </ul>	<ul style="list-style-type: none"> <li>Stabilization</li> <li>Motion Detect. (Motion Detection)</li> <li>Slow Motion</li> <li>Time Lapse</li> </ul>

### Picture Record Mode Menu

Picture Resolution	White Balance	Scene	Effect
<ul style="list-style-type: none"> <li>High (16MP)</li> <li>Std (5MP)</li> <li>Low (3MP)</li> </ul>	<ul style="list-style-type: none"> <li>Auto</li> <li>Daylight</li> <li>Fluorescent</li> <li>Tungsten</li> </ul>	<ul style="list-style-type: none"> <li>Auto</li> <li>Skin</li> <li>Night</li> <li>Backlight</li> <li>B/W (Black/White)</li> <li>Classic</li> <li>Negative</li> </ul>	<ul style="list-style-type: none"> <li>Self-Timer</li> <li>ISO</li> </ul>

## Operations for Record Mode

Operation	Screen
<p>1. Press OK Button in Record Mode. The wheel menu will show on the screen.</p>	
<p>2. Use Right/Left Buttons to move between the wheel menu options, which are Resolution, White Balance, Scene, Effect, and Setting.</p> <p>3. The option submenu will pop up while stopping on each option. Press Right Button to enter the submenu.</p> <p>4. Use Up/Down Buttons to select the desired option, and then press OK Button to validate.</p> <p>5. Or press Playback Button to exit to Record Mode without any change.</p>	

## Movie Resolution

Four resolution settings are available.

- **FHD (1080p 30)**: Record movies at 1920x1080p 30 resolution.
- **HD (720p 30)**: Record movies at 1280x720p 30 resolution.
- **WVGA60**: Record movies at 848x480p 60 resolution.
- **VGA (4:3)**: Record movies at 640x480p 30 resolution.

Operation	Display Screen
<ol style="list-style-type: none"> <li>1. In Movie Record Mode, press OK Button to show the wheel menu.</li> <li>2. Use Up/Down Buttons to select [Resolution]. The submenu of Resolution pops up.</li> <li>3. Press Right Button to enter the submenu.</li> <li>4. Use Up/Down Buttons to select the desired option.</li> <li>5. Press OK Button to validate the setting.</li> </ol>	

## Picture Resolution

Three resolution settings are available.

- **High (16MP)**: Shoot picture at 4608 x 3456, 16MP quality.
- **Std (5MP)**(Standard): Shoot picture at 2592 x 1944, 5MP quality.
- **Low (3MP)**: Shoot picture at 2048 x 1536, 3MP quality.

Operation	Display Screen
<ol style="list-style-type: none"> <li>1. In Picture Record Mode, press OK Button to show the wheel menu.</li> <li>2. Use Up/Down Buttons to select [Resolution]. The submenu of Resolution pops up.</li> <li>3. Press Right Button to enter the submenu.</li> <li>4. Use Up/Down Buttons to select the desired option.</li> <li>5. Press OK Button to validate the setting.</li> </ol>	

## White Balance

The camcorder adjusts the color balance of images automatically. Three manual white balance settings are available:

- **Auto:** The camcorder automatically adjusts white balance.
- **Daylight:** Under outdoor condition.
- **Fluorescent:** Under fluorescent light condition.
- **Tungsten:** Under tungsten light condition.

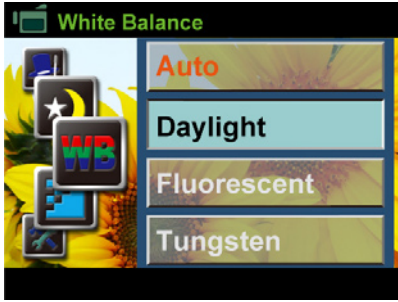
Operation	Display Screen
<ol style="list-style-type: none"> <li>1. In Movie/Picture Record Mode, press OK Button to show the wheel menu.</li> <li>2. Use Up/Down Buttons to select [White Balance]. The submenu of White Balance pops up.</li> <li>3. Press Right Button to enter the submenu.</li> <li>4. Use Up/Down Buttons to select the desired option.</li> <li>5. Press OK Button to validate the setting.</li> </ol>	

## Scene

You can select the mode according to the scene condition.

- **Auto:** Shoot without any special effect on the image.
- **Skin:** Shoot with an effect that makes skin tones more natural.
- **Night:** Use Night Mode for night scenes or low light conditions.
- **Backlight:** You can take shots when the bright light is behind the subject.
- **B/W:** The image is converted to black-and-white.
- **Classic:** The image is converted to a sepia look.
- **Negative:** The image is converted as the negative of the normal.

Operation	Display Screen
<ol style="list-style-type: none"> <li>1. In Movie/Picture Record Mode, press OK Button to show the wheel menu.</li> <li>2. Use Up/Down Buttons to select [Scene]. The submenu of Scene pops up.</li> <li>3. Press Right Button to enter the submenu.</li> <li>4. Use Up/Down Buttons to select the desired option.</li> <li>5. Press OK Button to validate the setting.</li> </ol>	



### Note

To avoid blurry pictures, place the camcorder on a flat, steady surface, or use a tripod when taking shots in the Night Mode.

## Movie Effect

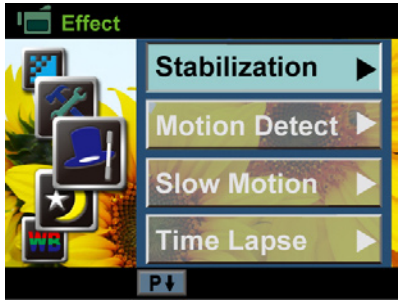
Operation	Display Screen
<ol style="list-style-type: none"> <li>1. In Movie Record Mode, press OK Button to show the wheel menu.</li> <li>2. Use Up/Down Buttons to select [Effect]. The submenu of Effect pops up.</li> <li>3. Press Right Button to enter the submenu.</li> <li>4. Use Up/Down Buttons to select the desired option, and then press Right Button to enter its option screen.</li> <li>5. The Movie Effect submenu contains 4 options-- Stabilization, Motion Detection, Slow Motion, and Time Lapse --for you to adjust the camcorder's settings.</li> </ol>	

### Stabilization

Record with an effect of reducing camcorder shake to result in more stable videos.

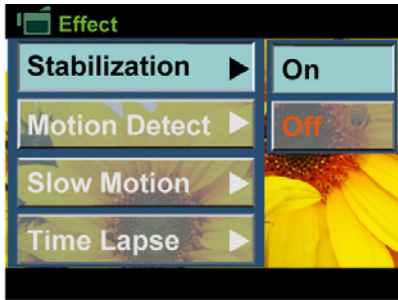
Operation	Display Screen
<ol style="list-style-type: none"> <li>1. In the Effect submenu, use Up/Down Button to select [Stabilization]. Then press Right Button to enter its option screen.</li> <li>2. Use Up/Down Buttons to select the desired option.</li> <li>3. Press OK Button to validate the setting.</li> </ol>	



#### Note

Stabilization doesn't apply on FHD (1080p 30) and WVGA 60.

### Motion Detection

Record videos automatically when the camcorder detects a movement.

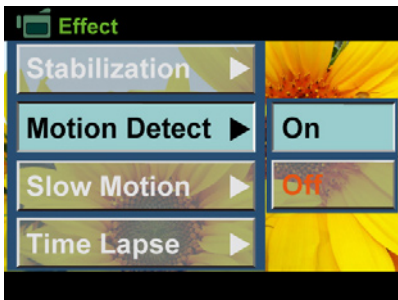
Operation	Display Screen
<ol style="list-style-type: none"> <li>1. In the Effect submenu, use Up/Down Button to select [Motion Detect]. Then press Right Button to enter its option screen.</li> <li>2. Use Up/Down Buttons to select the desired option.</li> <li>3. Press OK Button to validate the setting.</li> <li>4. Camcorder will start to record video automatically if it detects a movement. Stop recording if it does not detect a movement.</li> </ol>	

## Slow Motion

Record videos with slow motion effect. When the video is played, the playback time will be longer than the actual recording time.

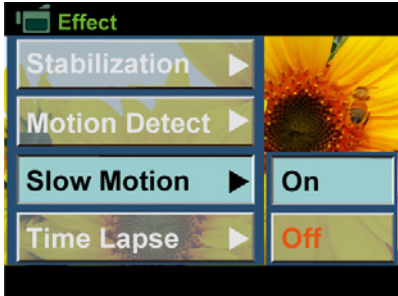
Operation	Display Screen
<ol style="list-style-type: none"> <li>In the Effect submenu, use Up/Down Button to select [Slow Motion]. Then press Right Button to enter its option screen.</li> <li>Use Up/Down Buttons to select the desired option.</li> <li>Press OK Button to validate the setting.</li> </ol>	 <p>The screenshot shows the 'Effect' menu with four options: Stabilization, Motion Detect, Slow Motion, and Time Lapse. The 'Slow Motion' option is highlighted in blue. To its right, there are two buttons: 'On' (highlighted in blue) and 'Off' (highlighted in yellow). A sunflower image is visible in the background of the menu.</p>

## Time Lapse

Record still images at specific intervals you can set and play them as one movie file.

- Off: Disable Time Lapse.
- 1 Sec.: Record one frame per second.
- 3 Sec.: Record one frame every 3 seconds.
- 5 Sec.: Record one frame every 5 seconds.

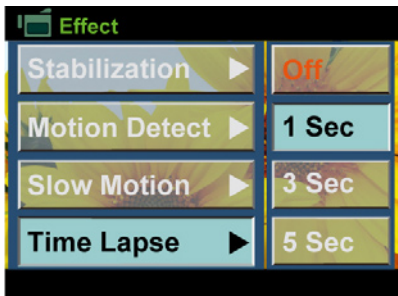
Operation	Display Screen
<ol style="list-style-type: none"> <li>In the Effect submenu, use Up/Down Button to select [Time Lapse]. Then press Right Button to enter its option screen.</li> <li>Use Up/Down Buttons to select the desired option.</li> <li>Press OK Button to validate the setting.</li> </ol>	 <p>The screenshot shows the 'Effect' menu with four options: Stabilization, Motion Detect, Slow Motion, and Time Lapse. The 'Time Lapse' option is highlighted in blue. To its right, there are four buttons: 'Off' (highlighted in yellow), '1 Sec' (highlighted in blue), '3 Sec' (highlighted in yellow), and '5 Sec' (highlighted in yellow). A sunflower image is visible in the background of the menu.</p>



### Note

- Stabilization function can not be used when Time Lapse function is activated.

## Picture Effect

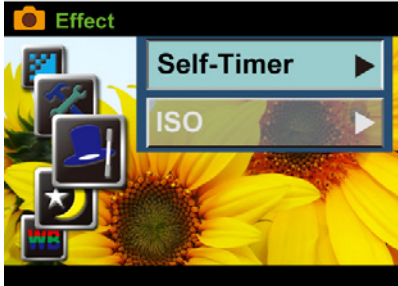
Operation	Display Screen
<ol style="list-style-type: none"> <li>1. In Picture Record Mode, press OK Button to show the wheel menu.</li> <li>2. Use Up/Down Buttons to select [Effect]. The submenu of Effect pops up.</li> <li>3. Press Right Button to enter the submenu.</li> <li>4. Use Up/Down Buttons to select the desired option, and then press Right Button to enter its option screen.</li> <li>5. The Picture Effect submenu contains 2 options -- Self-Timer and ISO-- for you to adjust the camcorder's setting.</li> </ol>	

### Self-Timer

The self-timer allows you to take pictures with a ten-second time delay. The self-timer light on the front of the camcorder will also blink. The speed of blinking will increase just before the picture is taken.

Operation	Display Screen
<ol style="list-style-type: none"> <li>1. In the Effect submenu, use Up/Down Button to select [Self-Timer]. Then press Right Button to enter its option screen.</li> <li>2. Use Up/Down Buttons to select the desired option.</li> <li>3. Press OK Button to validate the setting.</li> </ol>	

### ISO

The camcorder adjusts the ISO sensitivity of its images automatically. Two manual ISO sensitivity settings are available. (800/1600) The larger the number is, the higher the ISO sensitivity is set to. Select a small number to shoot a smoother image. Select a large number to shoot an image in a dark location or to shoot a subject moving at high speed.

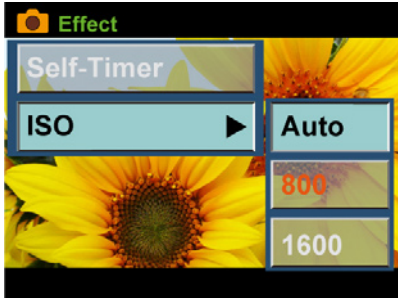
Operation	Display Screen
<ol style="list-style-type: none"> <li>1. In the Effect submenu, use Up/Down Button to select [ISO]. Then press Right Button to enter its option screen.</li> <li>2. Use Up/Down Buttons to select the desired option.</li> <li>3. Press OK Button to validate the setting.</li> </ol>	







#### Note

*The image may become noisy when the ISO number is large.*

## Section 4 Playback Mode

### Button Function









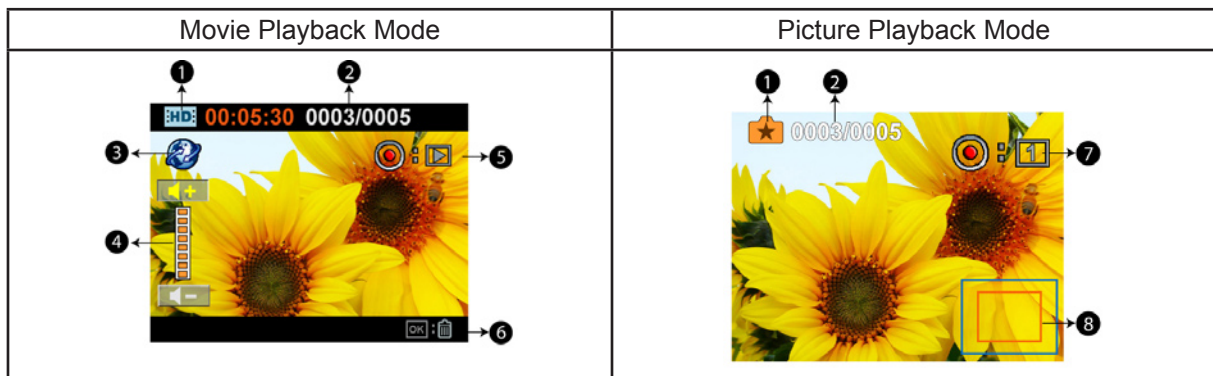
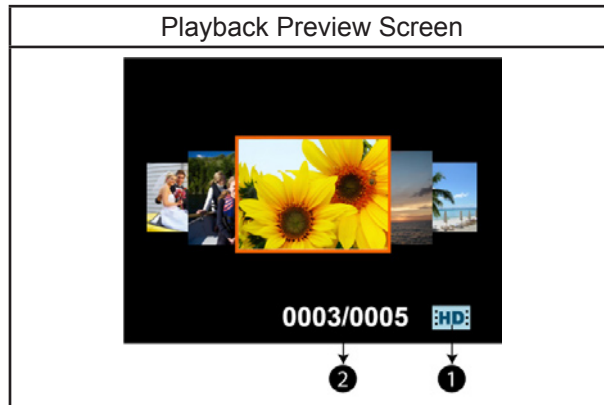

The Buttons have the following functions in Playback Mode.

	<p><b>Mode Button:</b></p> <ol style="list-style-type: none"> <li>1. Switch between Movie Preview Screen and Picture Preview Screen.</li> </ol>
	<p><b>Record Button:</b></p> <ol style="list-style-type: none"> <li>1. Press to view the movies/ picture.</li> <li>2. In Movie Playback Mode, press to play and pause the recorded movies.</li> <li>3. In Picture Playback Mode, press to start/stop the slideshow.</li> </ol>
	<p><b>Playback Button:</b></p> <ol style="list-style-type: none"> <li>1. Switch between Record /Playback Mode.</li> <li>2. Return to the previous screen.</li> </ol>
	<p><b>Direction Button:</b></p> <p><b>Right Button:</b> Go to the next movie/picture. Fast forward.</p> <p><b>Left Button:</b> Go to the previous movie/picture. Fast rewind.</p> <p><b>Tele Button (Up Button):</b> Volume increase. Zoom In.</p> <p><b>Wide Button (Down Button):</b> Volume decrease. Zoom out.</p> <p><b>OK Button:</b> Delete the current or all movies/pictures. Validate the setting.</p>
	<p><b>Pre-Record/YouTube Direct Button:</b></p> <p>In Movie Playback Mode, press to select the current movie to upload to YouTube.</p>







## LCD Monitor Information

Indicators on the LCD screen while in Playback Mode:





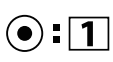

(1)	Movie Resolution	
		FHD (1080 p30)
		HD (720 p30)
		WVGA60
		VGA (4:3)
		Slow Motion (320x240)
	Picture Resolution	
		High
		Standard
		Low
	Dual Record (The image resolution captured during movies recording is the same as the video resolution.)	
(2)	<b>0003/0005</b>	Current number/ Total number of picture/movie.
	<b>00:05:30</b>	Movie playback time counter.
(3)		Upload selected movies to YouTube



(4)		Volume
(5)		Indicate the screen is in movie playback mode:Play/Pause
(6)		Press OK Button to go to the Delete option.
(7)		Press Record Button to start the slide show
		Press Record Button to stop the slide show
(8)		Magnification Indicator

## Operations for Playback Mode

The Playback Mode is for viewing and managing movies and pictures on the built-in memory or on an SD Card.

Operation	Display Screen
1. Press Playback Button (  ) to switch to the Playback mode.	
2. In the Playback preview screen, press Mode Button (  ) to switch between the Movie mode and the Picture mode. 3. Press Left Button to go to the previous picture/movie. Press Right Button to go to the next picture/movie. 4. Press Record Button to view the movies/ picture.	 

## Movie Playback

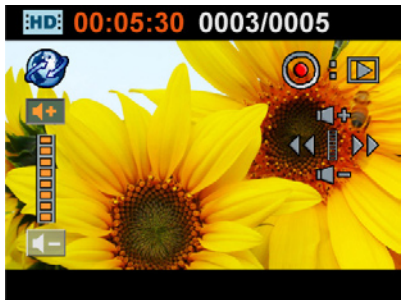
Operation	Display Screen
<ol style="list-style-type: none"> <li>1. When in Movie Playback mode, press Record Button to play/pause the movies.</li> <li>2. While playing movie, press Right/Left Buttons to fast forward/rewind, then release the button to stop.</li> <li>3. Use Up/Down Buttons to adjust volume.</li> </ol>	



### Note

When the LCD is idle for a few seconds, the playback function icons will disappear automatically.

## Delete Movies

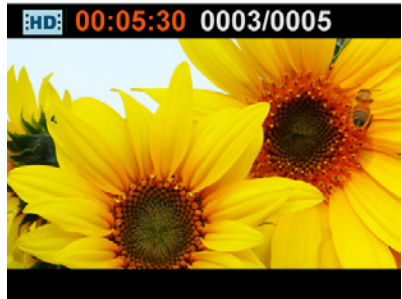
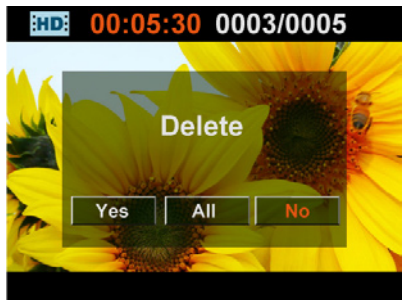
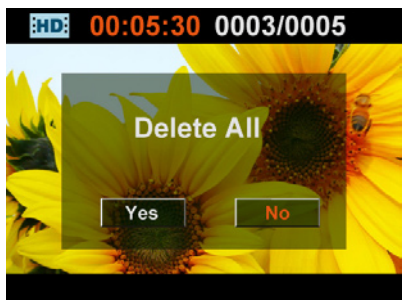
Operation	Display Screen
<ol style="list-style-type: none"> <li>1. Use Right/Left Buttons to select the movies.</li> <li>2. Press OK Button to go to the Delete option.</li> </ol>	
<ol style="list-style-type: none"> <li>3. Move between [Yes], [All] and [No] by using Right/Left Buttons.</li> <li>4. Before all movies are deleted, a confirmation screen will appear; choosing "Yes" will execute the operation and "No" will cancel the operation</li> <li>5. Press OK Button to validate the setting.</li> </ol>	
	



### Note

- If a memory card has been inserted, you can only delete those movies stored on the card.
- Movies on a written-protected memory card cannot be deleted.

## Picture Playback

Operation	Display Screen
<ol style="list-style-type: none"> <li>1. When in the Picture Playback mode, use Right/Left Buttons to go to the next or previous picture.</li> <li>2. While the picture is selected, press Tele Button to magnify. (The magnification Indicator appears on the screen)</li> <li>3. To navigate the magnified picture, press OK Button to enter navigation mode (The inner Magnification Indicator turns red).</li> <li>4. Use Direction Button to navigate the magnified picture. Press OK Button to exit navigation mode.</li> <li>5. Press Record Button to start/stop the slide show.</li> </ol>	



### Note

When the LCD is idle for a few seconds, the slideshow function icons will disappear automatically.

## Delete Picture

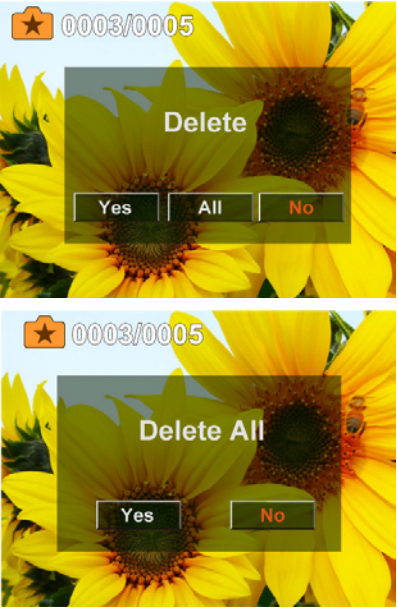
Operation	Display Screen
<ol style="list-style-type: none"> <li>1. Use Right/Left Buttons to select the picture.</li> <li>2. Press OK Button to go to the Delete option.</li> </ol>	
<ol style="list-style-type: none"> <li>3. Move between [Yes], [All] and [No] by using Right/Left Buttons.</li> <li>4. Before all movies are deleted, a confirmation screen will appear; choosing "Yes" will execute the operation and "No" will cancel the operation</li> <li>5. Press OK Button or Record Button to validate the setting.</li> </ol>	



### Note

- If a memory card has been inserted, you can only delete those pictures stored on the card.
- Pictures on a written-protected memory card cannot be deleted.

## Section 5

# Setting Your Camcorder

### Setting Menu

Operation	Display Screen
<ol style="list-style-type: none"> <li>1. In Movie/Picture Record Mode, press OK Button to show the wheel menu.</li> <li>2. Use Up/Down Buttons to select [Setting]. The submenu of Setting pops up.</li> <li>3. Press Right Button to enter the submenu.</li> <li>4. Use Up/Down Buttons to select the desired option, and then press Right Button to enter its option screen.</li> <li>5. The Setting submenu contains 6 options for configuring your camcorder setup. They are Sound (operation sound), TV, Language, Time Setting, Format, and Default Setting.</li> </ol>	

### Sound

Enable or disable the keypad tone and the operation sound.

Operation	Display Screen
<ol style="list-style-type: none"> <li>1. In the Setting submenu, use Up/Down Button to select [Sound]. Then press Right Button to enter its option screen.</li> <li>2. Use Up/Down Buttons to select the desired option.</li> <li>3. Press OK Button to validate the setting.</li> </ol>	

## TV

Ensure that the appropriate TV standard of your area is selected – either NTSC or PAL.

Wrong TV system setting may cause image flickers.

- **NTSC(60Hz) standard:** USA, Canada, Japan, South Korea and Taiwan, etc.
- **PAL(50Hz) standard:** UK, Europe, China, Australia, Singapore and Hong Kong, etc.



Operation	Display Screen
<ol style="list-style-type: none"> <li>1. In the Setting submenu, use Up/Down Button to select [TV]. Then press Right Button to enter its option screen.</li> <li>2. Use Up/Down Buttons to select the desired option.</li> <li>3. Press OK Button to validate the setting.</li> </ol>	 <p>The screenshot shows a 'Setting' menu with a sunflower background. The 'TV' option is highlighted in blue. To its right, two options are visible: 'NTSC(60Hz)' and 'PAL(50Hz)'. Other menu items include 'Sound', 'Language', and 'Time Setting'. A 'P+' button is visible at the bottom.</p>

## Language

Use this option to select the language of the user interface.

Operation	Display Screen
<ol style="list-style-type: none"> <li>1. In the Setting submenu, use Up/Down Button to select [Language]. Then press Right Button to enter its option screen.</li> <li>2. Use Up/Down Buttons to select the desired option.</li> <li>3. Press OK Button to validate the setting.</li> </ol>	 <p>The screenshot shows a 'Setting' menu with a sunflower background. The 'Language' option is highlighted in blue. To its right, four language options are visible: 'English', 'Deutsch', 'Français', and 'Italiano'. Other menu items include 'Sound', 'TV', and 'Time Setting'. Three 'P+' buttons are visible at the bottom.</p>



## Time Setting

Operation	Display Screen
<p>1. In the Setting submenu, use Up/Down Button to select [Time Setting]. Then press Right Button to enter time setting screen.</p>	
<p>2. Move between Year, Month, Day, Hour and Minute by using Right/Left Buttons. Adjust the numeric value by using Up/Down Buttons.</p> <p>3. Press OK Button to validate the setting. Or press Playback Button to leave without any change.</p>	

## Format

**Yes:** Format the built-in memory (When there is no SD card in the camcorder) / SD Card (When there is an SD card in the camcorder).

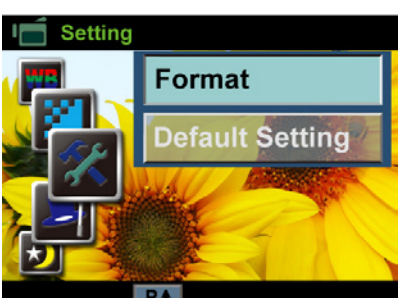
**No:** Do not format the built-in memory (When there is no SD card in the camcorder) / SD Card (When there is an SD card in the camcorder).

Operation	Display Screen
<p>1. In the Setting submenu, use Up/Down Button to select [Format]. Then press Right Button to enter the confirmation screen.</p>	
<p>2. Use Right/Left Buttons to choose Yes or No.</p> <p>3. Choosing “Yes” will execute the operation, “No” will cancel the operation.</p> <p>4. Press OK Button to validate the setting. Or press Playback Button to leave without any change.</p>	



### Note

*All the data will be erased if the SD card is formatted. Make sure all the data are copied to your PC before formatting the SD card.*

## Default Setting

To restore the default factory setting, select this option.

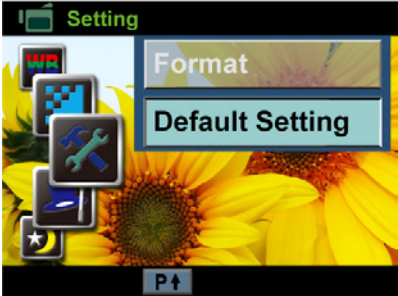
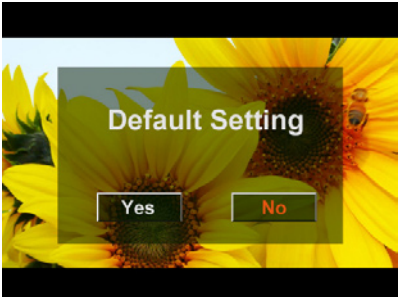
Operation	Display Screen
1. In the Setting submenu, use Up/Down Button to select [Default Setting]. Then press Right Button to enter the confirmation screen.	
2. Use Right/Left Buttons to choose Yes or No. 3. Choosing "Yes" will execute the operation, "No" will cancel the operation. 4. Press OK Button to validate the setting. Or press Playback Button to leave without any change.	

The following table indicates the camcorder's default settings

Setting	Default Factory Setting
<b>Resolution</b>	FHD (1080p 30) for Movie Std (5MP) for Picture
<b>Scene</b>	Auto
<b>Stabilization</b>	Off
<b>Motion Detection</b>	Off
<b>Slow Motion</b>	Off
<b>Time Lapse</b>	Off
<b>White Balance</b>	Auto
<b>ISO</b>	Auto
<b>Self-Timer</b>	Off
<b>Sound</b>	On
<b>TV</b>	Depends on shipping area
<b>Language</b>	Depends on shipping area
<b>Volume</b>	Level 6

## Section 6

# Viewing Pictures and Movies on TV

### Connecting to a High-Definition 16:9(Wide) TV

1. Connect the HDMI cable to your camcorder's HDMI Out port.
2. Connect the other end of the cable to a television.
3. Set the video input source of your TV to "HDMI".

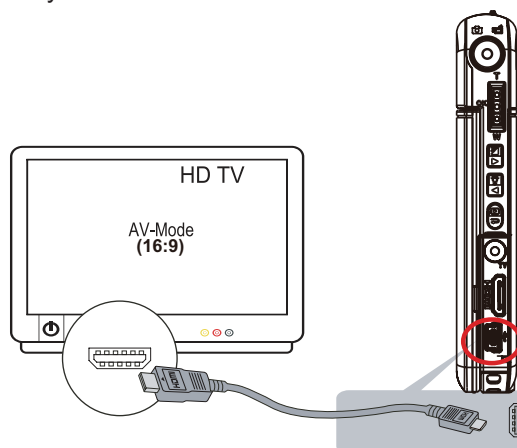

4. The steps for viewing stored pictures and movie on a TV are exactly the same as for viewing them on the LCD monitor.



#### Note

The camcorder can not run movie recording and picture taking when it is connected to an HDTV. The LCD Panel does not display when the camcorder is connected to an HDTV.

### Connecting to a non-high-definition 4:3 TV

1. Connect one end of the AV cable to your camcorder's AV out port.
2. Connect the other end of the cable to a television.
3. The steps for viewing stored pictures and movie on a TV are exactly the same as for viewing them on the LCD monitor.

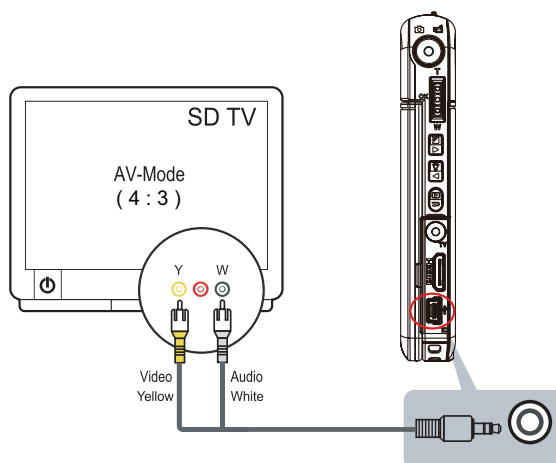

#### Note

The LCD Panel does not display when the camcorder is connected to a TV.



## Section 7

# Viewing Movie & Picture on PC

### Installing Bundled Software

The CD-ROM supplied with this camcorder contains 3 pieces of software.

- **ArcSoft MediaImpression** is a user-friendly application that helps you managing your media, burning your video into DVD, and uploading your videos to YouTube easily.
- **ArcSoft MediaConverter** is a powerful application that converts multiple video formats into compatible format with your camcorder.
- **Adobe Reader** is a popular program that you need to have installed to read the User's Manual. Many computer users will find they already have this software installed on their computer.

To install the bundled software:

1. Insert the CD-ROM into your computer's CD-ROM drive. The autorun screen appears.
2. Click "**Install Application Software**". Follow the on-screen instructions to complete the installation.



#### Note

- *The detailed information can be found in online help of all the bundled software.*

### Transferring Pictures or Movies to a Computer

You can transfer pictures or movies stored on your camcorder to a computer and send them in e-mails to friends or post them on the websites.

To do this you should:

1. Connect the computer and camcorder with the supplied mini USB 2.0 cable. The LED will light up and blink.
2. After the LED stops blinking, movies and pictures can be found on your computer at "My Computer\Removable Disk\DCIM\100MEDIA".
3. Under this folder, you can view, delete, move, or copy any movie/picture you want.
4. Use the bundled ArcSoft application software to edit the movies or pictures.

## Section 8

# Burning the Recorded Clip into a DVD

The bundled software CD contains ArcSoft MediaImpression which can be used to burn movie clips onto a DVD. You can share this DVD movie with your family or friends by using a regular DVD player.

To create a DVD:

1. Install ArcSoft MediaImpression (Refer to Section 7).
2. Click on Windows [Start] → [(All) Programs] → [ArcSoft MediaImpression].
3. The ArcSoft MediaImpression main screen will appear on your desktop.
4. Click on [Videos].

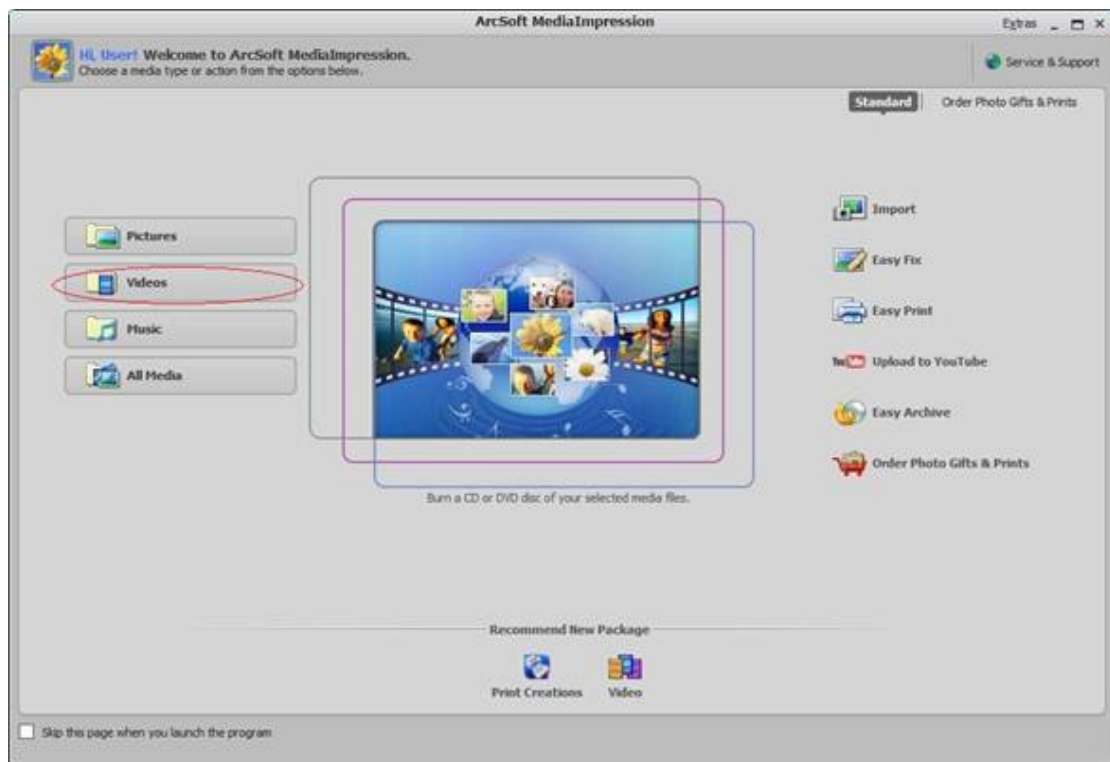

5. The operation screen will appear:

- Select the folder that contains the video files you want to burn.
- Select the files in the display area.
- Click on [Make Movie] at the bottom menu.

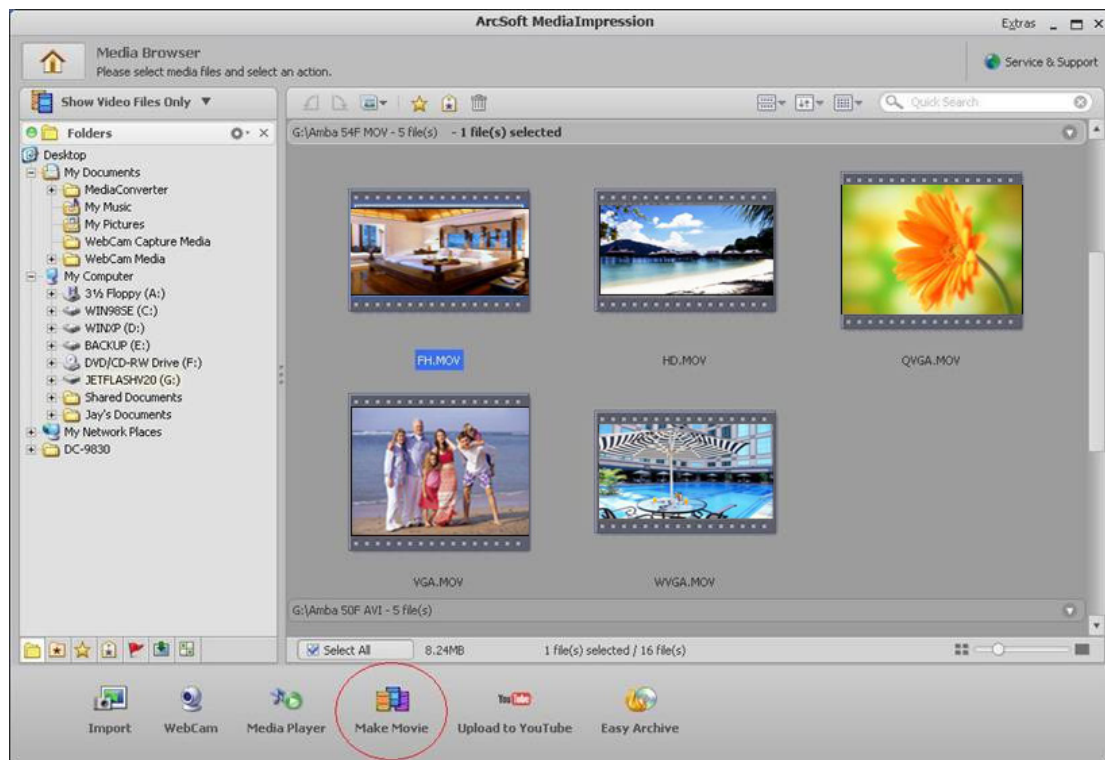

6. Click on [Add Media] (  ) to add the files into slide.

7. Click on [Save/Share].

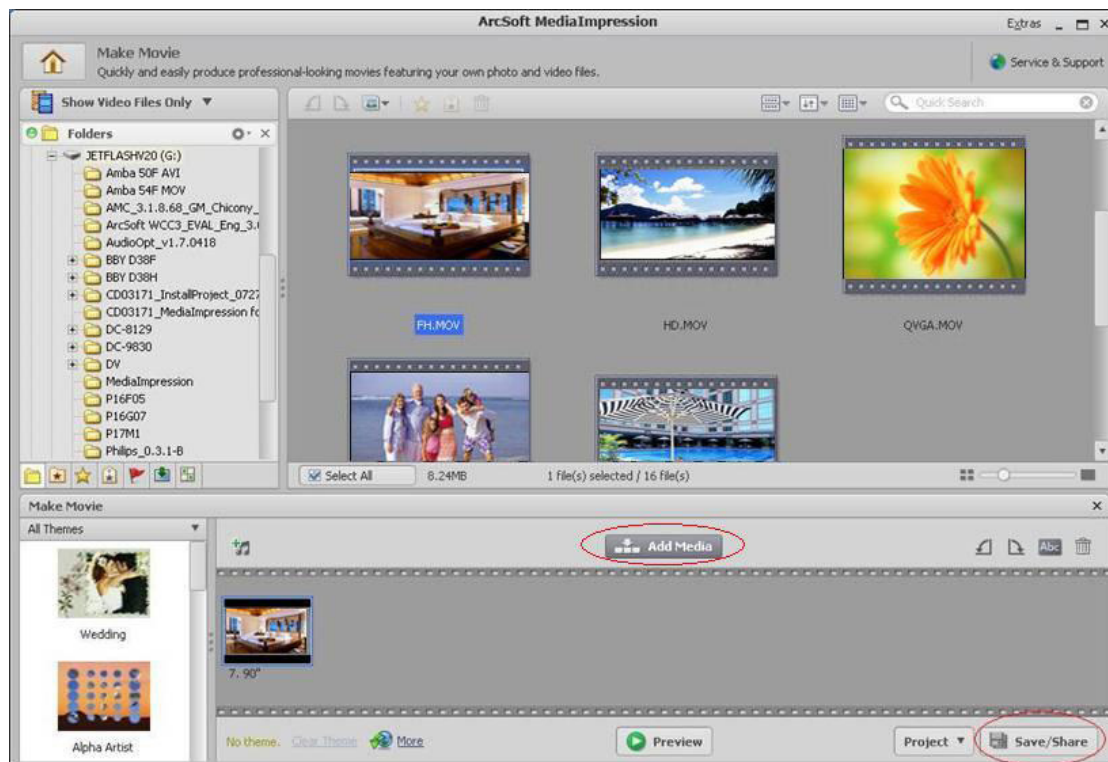

8. Select [Burn] and click on [Next] to proceed.

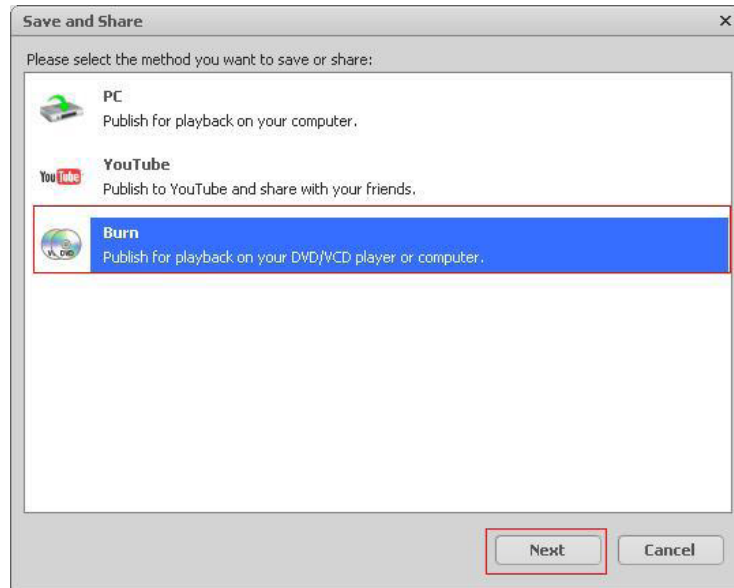

9. Click on [Start] to start the VCD/DVD burning.

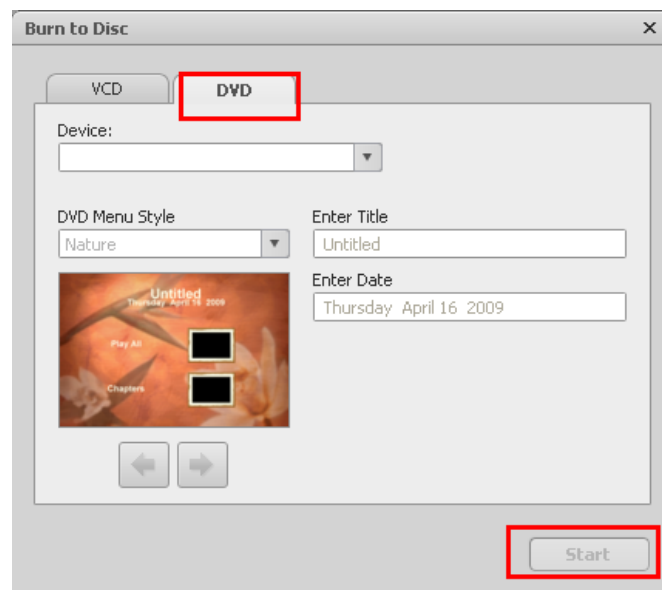

**Note**

*Please insert a blank, writable VCD or DVD into the CD/DVD Writer before clicking on [Start].*

# Section 9

## Uploading Video Files to YouTube

The built-in **YouTube Direct** application offers you an easy way to upload your video clips to YouTube instantly. It helps you share them with your family and friends on the YouTube website. Also, the bundled software, **ArcSoft MediaImpression**, can be used to upload your video clips to YouTube.

### 9.1 YouTube Direct

To upload video files marked with  to YouTube:

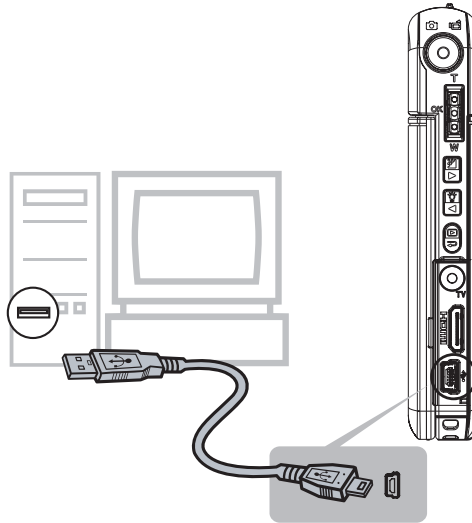

1. Select the video clips in Movie Playback Mode by pressing YouTube Direct Button .
2. Connect the camcorder to your computer by using the supplied USB cable.



3. Press YouTube Direct Button  on the camcorder to launch the YouTube Direct application automatically.  
(Before the computer launches YouTube Direct, you have to install the application included in the CD first.)



4. Upload video clips:

1. Press YouTube Direct Button  on the camcorder again.
2. The videos clips marked with  will be uploaded to the website automatically. (You may be asked to fill in your account information before uploading or you can fill in the information firstly by click on  ).
3. Click on “CANCEL” to stop uploading.

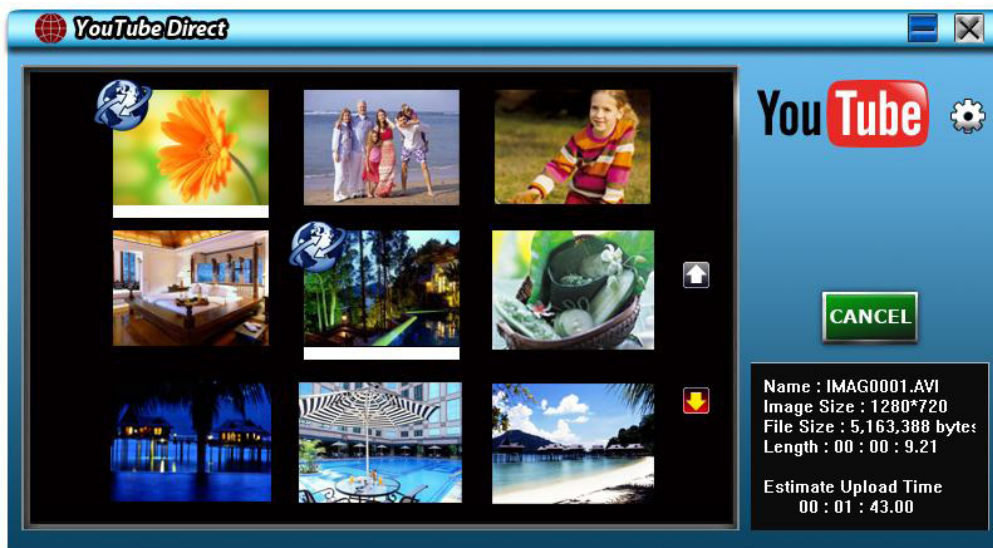



**To upload video files selected manually to YouTube:**

1. Follow the step 2 and 3 on page 40.
2. On the thumbnail screen, click on the up/down icon to change the pages. Click on the video clips you want to upload.
3. Click on “UPLOAD” to start uploading.



### To playback the video file:

1. Double click on the video clip on the thumbnail screen.
2. Click on the Play/Pause icon  to play/pause. Click on the Return icon  to return to the thumbnail preview screen.

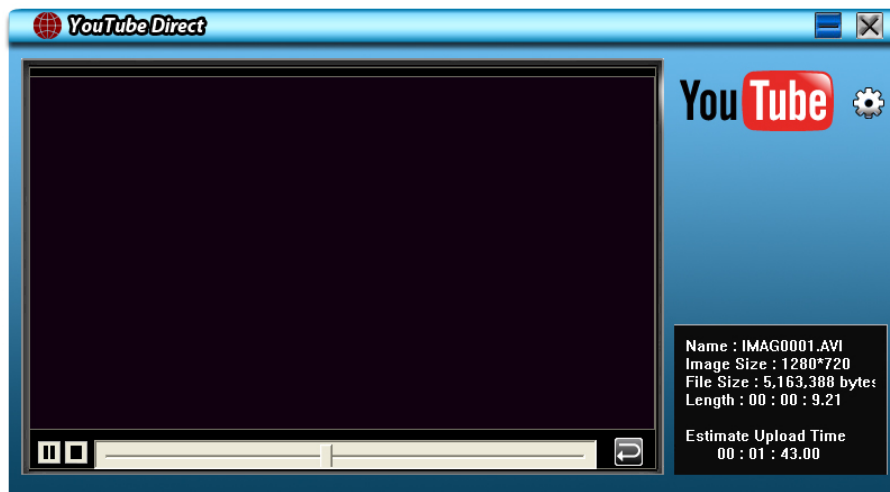

### To setup your account information for YouTube:

1. Click on  to go to the setup screen.
2. Fill in your account information in the blanks. Then click on "Save".

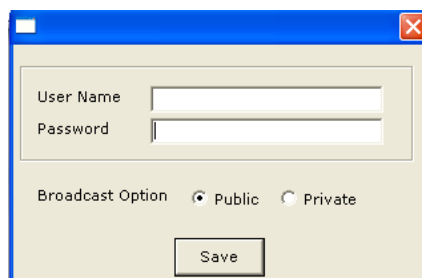
The image shows a small dialog box for account setup. It has a blue title bar with a close button. The form contains two input fields: "User Name" and "Password". Below these is a "Broadcast Option" section with two radio buttons: "Public" (selected) and "Private". At the bottom is a "Save" button.

(If you do not have a account, please sign up on YouTube first.)

## 9.2 ArcSoft MediaImpression

To upload video files to YouTube:

1. Install ArcSoft MediaImpression (Refer to Section 7).
2. Click on Windows [Start] → [(All) Programs] → [ArcSoft MediaImpression].
3. The ArcSoft MediaImpression main screen will appear on your desktop.
4. Click on [Videos].



5. The operation screen will appear:

- Select the folder that contains the video files you want to upload.
- Select the files in the display area.
- Click on [Upload to YouTube] at the bottom menu.

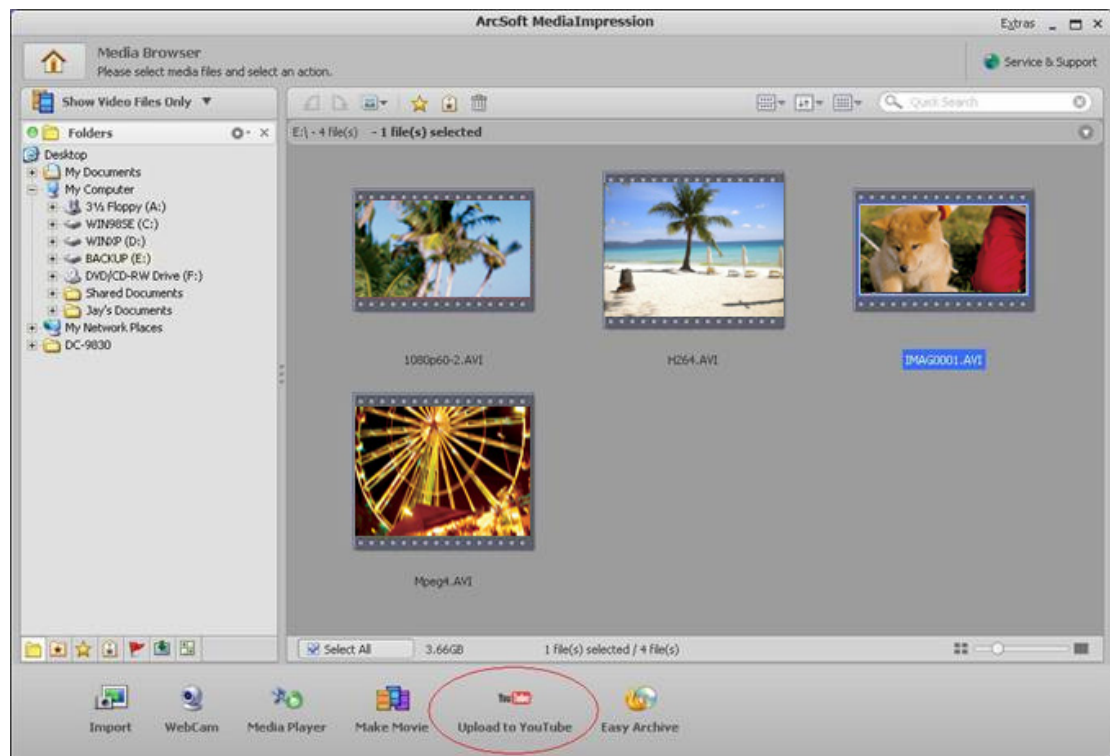



6. Fill in your YouTube account information in the blanks, and then click on [Login]

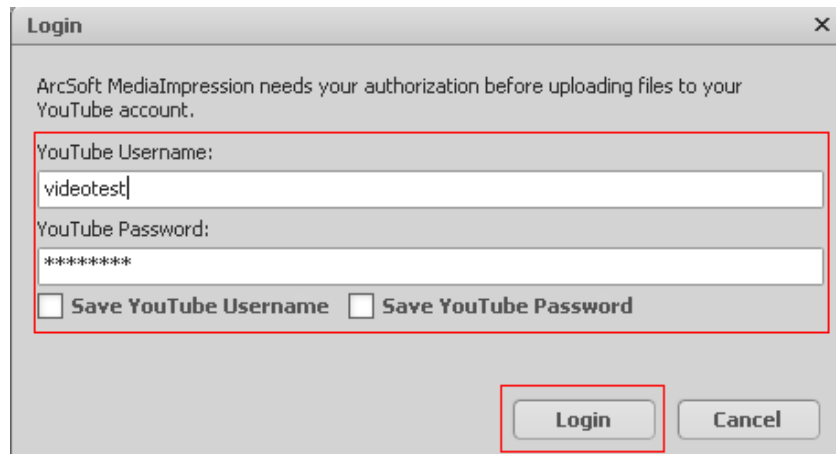

7. Fill in the information of the video clips in the blanks, and then click on [Upload]

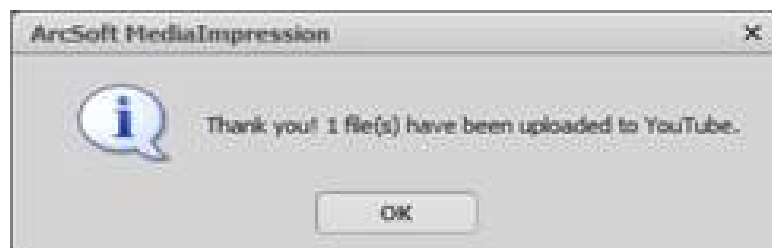
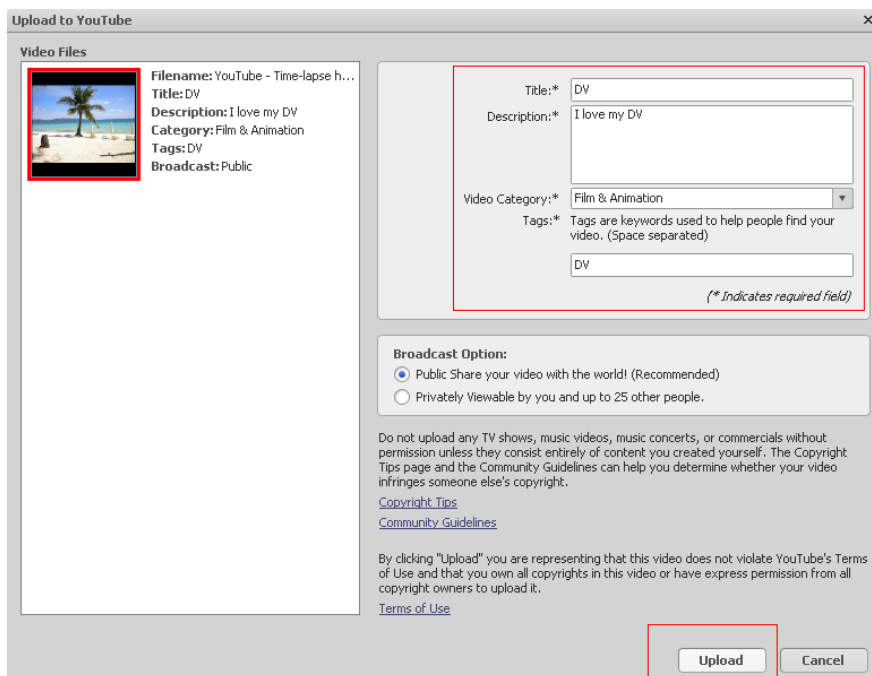

## Section 10

# Video File Converter

The bundled software CD contains ArcSoft MediaConverter that features video file converter to convert multiple video formats into compatible format with your camcorder. In this way, you can convert various video files formats and playback your favorite movies on your camcorder.

To convert a video file:

1. Install ArcSoft MediaConverter (Refer to section 7).
2. Click on Windows [Start] → [(All) Programs] → [ArcSoft MediaConverter].
3. The ArcSoft MediaConverter main screen will appear on your desktop.
4. Select [Profile 1].

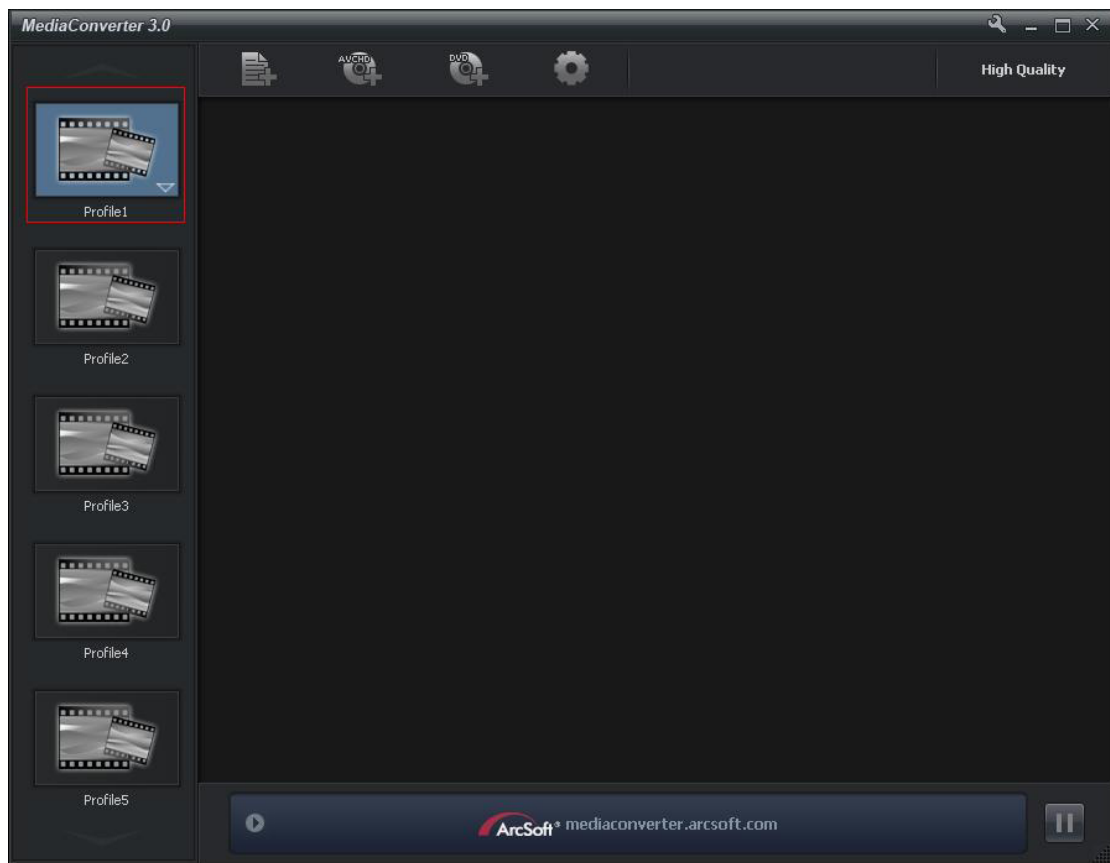

5. Select the video file you want to convert. Then, click on [Open] to convert the file.

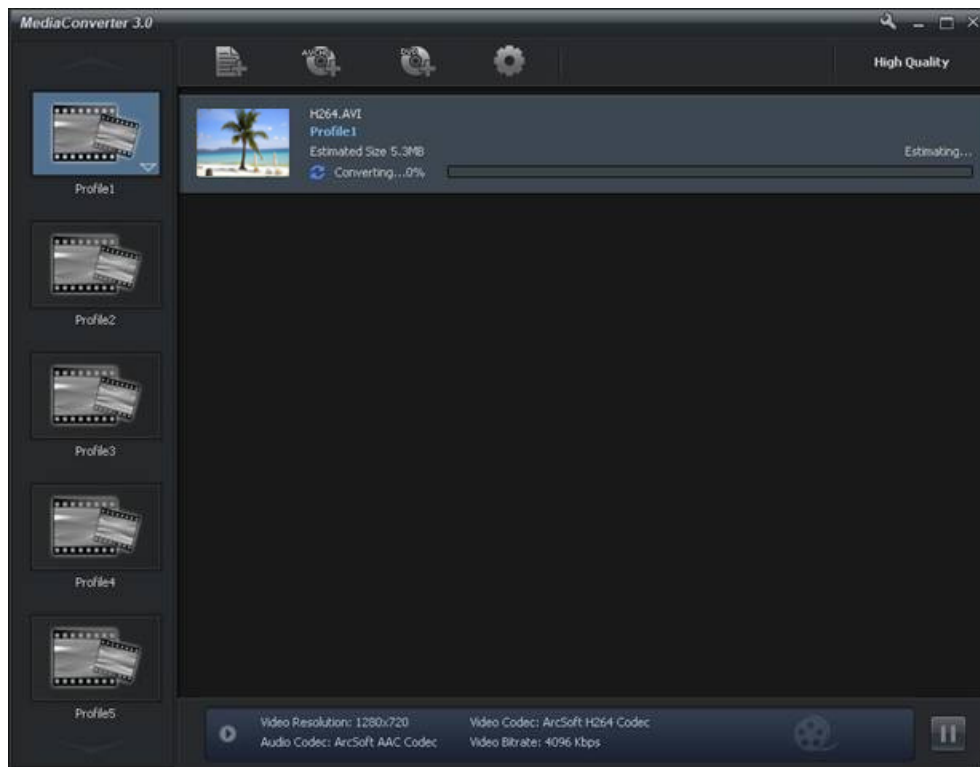
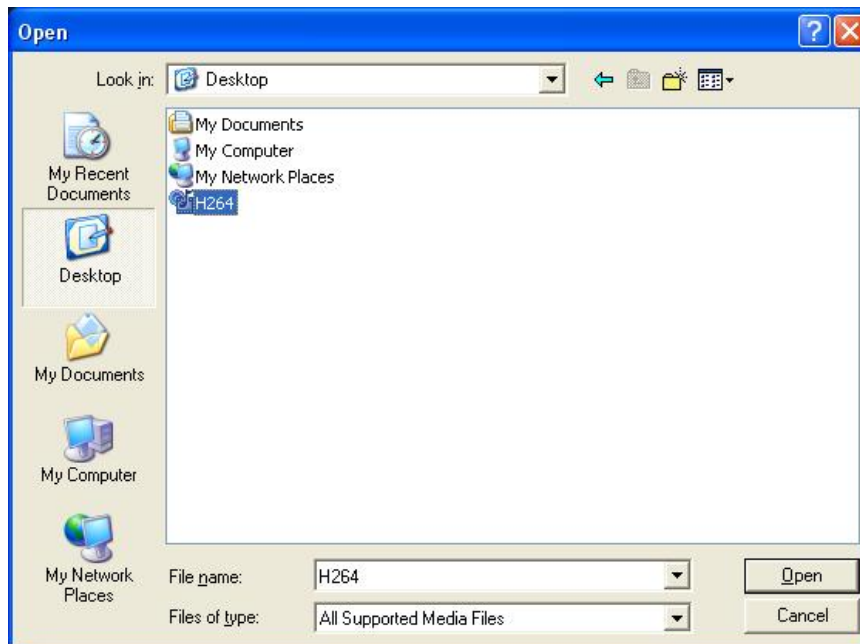

6. The converted files will be renamed "IMAG0001.avi", "IMAG0002.avi", and so on.
7. Rename the converted file to "IMAGXXXX. avi" before transferring the converted file to your camcorder. (XXXX should be a four figures, e.g. 0001 to 9999) (Please note that the converted file names can not be the same as the ones having existed in your camcorder, otherwise the video files in your camcorder may be overwritten.)
8. Connect your camcorder to PC and copy the converted videos to "My Computer\Removable Disk\ DCIM\100MEDIA" in your camcorder. (Under the circumstances of within an SD card in the camcorder and OS of the computer is Windows XP.)
9. After transferring the converted videos to the camcorder, press Playback Button to enjoy your favorite movies.



**Note**

*"My Computer\Removable Disk" would be different based on OS recognition.*

# Section 11

## Specifications

Specification	
Image sensor	5 Mega pixel CMOS sensor
Operation modes	Movie record, Picture record
Zoom	FHD (1080p30):1X (1X Digital zoom) Other video resolution:1X~4X (4X Digital zoom)
Shutter	Electronic
LCD monitor	3" / 7.6cm LCD
Storage media	Built-in 128MB memory (partial memory is used for firmware code); SD/SDHC card slot support (up to 32GB)
Image resolution	High 4608 x 3456 (16M pixels) Standard 2592x1944 (5M pixels) Low 2048x1536 (3M pixels)
Movie resolution	FHD (1080p 30) 1920X1080(30fps) HD (720p 30) 1280X720(30fps) WVGA60: 848X480(60fps) VGA (4:3) 640X480(30fps)
White balance	Auto/Manual (Daylight, Fluorescent, Tungsten)
ISO	Auto/800/1600
Self-timer	10 seconds delay
Light	Digital Light ON/ Light ON/ Light OFF.
File format	Picture: JPG Movie: AVI
Image play	Single image/Slideshow
PC interface	Mini USB 2.0 port
TV out	NTSC/PAL selectable, HDMI
Battery	Lithium-ion rechargeable battery
Dimension	59mm (W) x 106mm (H) x 17mm (D) (2.3 (W) * 4.13(H) * 0.66(D) inch)
Weight	115 g (without battery)

# Section 12

## Troubleshooting

### Troubleshooting

**1. If the LCD preview is not clear while shooting, how can the focus be adjusted?**

Try to switch between Macro and Normal Mode.

**2. The files on the memory card do not display smoothly when the LCD shows the “!” marking.**

The “!” means the SD card is low speed or is having wrong content inside. The way to solve this condition is to format SD card by the camcorder instead of a PC (Please refer to the detailed Format instruction in Section 5).

**3. Why do some of my indoor pictures look blurry and dark?**

The camcorder extends picture exposure time under low light/ indoor condition. Keep the camcorder (and the target subject) steady for several seconds when taking pictures. The shutter will sound when pictures are being taken.

**4. How do I charge battery?**

You must use the supplied AC charger or the USB cable.

The camcorder must be turned OFF; blinking light confirms charging, and the light becomes constant when the charging has been completed. Then, the light will turn itself off automatically after 5 minutes (In AC charging Mode)..

## Section 13 Other Information

### TOSHIBA Support

Need help?

For the latest driver updates, user's manuals & FAQ's please have a look at the TOSHIBA options & services support page:

*[computers.toshiba.eu/options-support](http://computers.toshiba.eu/options-support)*

Please see

*[computers.toshiba.eu/options-warranty](http://computers.toshiba.eu/options-warranty)*

for the TOSHIBA hotline numbers.

### Operating Environment Conditions

Operating temperature: 5 to 35° C

Operating humidity: 20 to 80 %

(no condensation allowed)

### Regulatory Information

#### CE compliance



This product is CE marked in accordance with the requirements of the applicable EU Directives.

Responsible for CE marking is Toshiba Europe GmbH, Hammfelddamm 8, 41460 Neuss, Germany. A copy of the official Declaration of Conformity can be obtained from following website:

<http://epps.toshiba-teg.com>.

#### Working Environment

The Electromagnetic Compliance (EMC) of this product has been verified typically for this product category for a so called Residential, Commercial & Light Industry Environment. Any other working environment has not been verified by Toshiba and the use of this product in these working environments is maybe restricted or cannot be recommended. Possible consequences of the use of this product in non verified working environments can be: Disturbances of other products or of this product in the nearby surrounding area with temporarily malfunction or data loss/corruption as result. Example of non verified working environments and related advices:

Industrial environment (e.g. where a 3-phase 380V mains is being used mainly): Danger of disturbances of this product due to possible strong electromagnetic fields especially near to big machinery or power units.

Medical environment: The compliance to the Medical Product Directive has not been verified by Toshiba, therefore this product cannot be used as a medical product without further verification. The use in usual office environments e.g. in hospitals should be no problem if there is no restriction by the responsible administration.

Automotive environment: Please search the owner instructions of the related vehicle for advices regarding the use of this product (category).

Aviation environment: Please follow the instructions of the flight personnel regarding restrictions of use.

### **Additional environments not related to EMC**

Outdoor use: As a typical home/office equipment this product has no special resistance against ingress of moisture and is not strong shock proofed.

Explosive atmosphere: The use of this product in such special working environment (Ex) is not allowed.

### REACH

#### **Following information is only valid for EU-member States:**

REACH - Compliance Statement

The new European Union (EU) chemical regulation, REACH (Registration, Evaluation, Authorization and Restriction of Chemicals), entered into force on 1 June 2007.

Toshiba will meet all REACH requirements and is committed to provide our customers with information about the chemical substances in our products according to REACH regulation.

Please consult the following website [www.toshiba-europe.com/computers/info/reach](http://www.toshiba-europe.com/computers/info/reach) for information about the presence in our articles of substances included on the candidate list according to article 59(1) of Regulation (EC) No 1907/2006 ("REACH") in a concentration above 0.1 % weight by weight.

#### **Following information is only valid for EU-member states:**

##### **Disposal of products**

The crossed out wheeled dust bin symbol indicates that products must be collected and disposed of separately from household waste. Integrated batteries and accumulators can be disposed of with the product. They will be separated at the recycling centres.

The black bar indicates that the product was placed on the market after August 13, 2005. By participating in separate collection of products and batteries, you will help to assure the proper disposal of products and batteries and thus help to prevent potential negative consequences for the environment and human health.



For more detailed information about the collection and recycling programmes available in your country, please visit our website (<http://eu.computers.toshiba-europe.com>) or contact your local city office or the shop where you purchased the product.

## Disposal of batteries and/or accumulators

The crossed out wheeled dust bin symbol indicates that batteries and/or accumulators must be collected and disposed of separately from household waste.



**Pb, Hg, Cd**

If the battery or accumulator contains more than the specified values of lead (Pb), mercury (Hg), and/or cadmium (Cd) defined in the Battery Directive (2006/66/EC), then the chemical symbols for lead (Pb), mercury (Hg) and/or cadmium (Cd) will appear below the crossed out wheeled dust bin symbol.

By participating in separate collection of batteries, you will help to assure the proper disposal of products and batteries and thus help to prevent potential negative consequences for the environment and human health.

For more detailed information about the collection and recycling programmes available in your country, please visit our website (<http://eu.computers.toshiba-europe.com>) or contact your local city office or the shop where you purchased the product.

## Additional Information

© 2009 TOSHIBA Europe GmbH. All rights reserved.

TOSHIBA reserves the right to make technical changes. TOSHIBA assumes no liability for damages incurred directly or indirectly from errors, omissions or discrepancies between this product and the documentation.

## About the battery pack

- Use only batteries recommended by TOSHIBA as replacements. The battery pack is lithium ion batteries, which can explode if not replaced, used, handled or disposed of properly. Dispose of the battery as required by local ordinances or regulations.
- Charge the battery pack only in an ambient temperature between 5 and 35 degrees Celsius. Otherwise, the electrolyte solution might leak, battery pack performance might deteriorate and the battery life might be shortened.
- Never install or remove the battery pack without first turning off the power and disconnecting the AC adaptor.
- Use only the product connected to an AC power source or optional TOSHIBA Battery charger to charge the battery pack. Never attempt to charge the battery pack with any other charger.



0970A9380L-A01S

**TOSHIBA**  
Leading Innovation >>>

For more information, please visit:

[www.toshiba-multimedia.com](http://www.toshiba-multimedia.com)

## Free Manuals Download Website

<http://myh66.com>

<http://usermanuals.us>

<http://www.somanuals.com>

<http://www.4manuals.cc>

<http://www.manual-lib.com>

<http://www.404manual.com>

<http://www.luxmanual.com>

<http://aubethermostatmanual.com>

Golf course search by state

<http://golfingnear.com>

Email search by domain

<http://emailbydomain.com>

Auto manuals search

<http://auto.somanuals.com>

TV manuals search

<http://tv.somanuals.com>