



# HOMEOWNER'S CARE AND OPERATION INSTRUCTIONS

## STANDARD SERIES



36" B-VENTED GAS APPLIANCES  
P/N 725,008M REV. F 05/2004

### MODELS

*Millivolt Models*

*B-40RMN*

*B-40RMP*

*Electronic Models*

*B-40REN*

*B-40REP*

RETAIN THESE INSTRUCTIONS  
FOR FUTURE REFERENCE



WH Report No. J20006722

**WARNING: IF THE INFORMATION IN THIS MANUAL IS NOT FOLLOWED EXACTLY, A FIRE OR EXPLOSION MAY RESULT CAUSING PROPERTY DAMAGE, PERSONAL INJURY OR LOSS OF LIFE.**

**FOR YOUR SAFETY:** Do not store or use gasoline or other flammable vapors or liquids in the vicinity of this or any other appliance.

**FOR YOUR SAFETY:** What to do if you smell gas:

- DO NOT light any appliance.
- DO NOT touch any electrical switches.
- DO NOT use any phone in your building.
- Immediately call your gas supplier from a neighbor's phone.

Follow your gas suppliers instructions.

- If your gas supplier cannot be reached, call the fire department.

Installation and service must be performed by a qualified installer, service agency or the gas supplier.

**AVERTISSEMENT: ASSUREZ-VOUS DE BIEN SUIVRE LES INSTRUCTIONS DONNÉ DANS CETTE NOTICE POUR RÉDUIRE AU MINIMUM LE RISQUE D'INCENDIE OU POUR ÉVITER TOUT DOMMAGE MATÉRIEL, TOUTE BLESSURE OU LA MORT.**

**POUR VOTRE SÉCURITÉ:** Ne pas entreposer ni utiliser d'essence ni d'autre vapeurs ou liquides inflammables dans le voisinage de cet appareil ou de tout autre appareil.

**POUR VOTRE SÉCURITÉ:** Que faire si vous sentez une odeur de gaz:

- Ne pas tenter d'allumer d'appareil.
- Ne touchez à aucun interrupteur. Ne pas vous servir des téléphones se trouvant dans le bâtiment où vous vous trouvez.
- Evacuez la pièce, le bâtiment ou la zone.
- Appelez immédiatement votre fournisseur de gaz depuis un voisin. Suivez les instructions du fournisseur.
- Si vous ne pouvez rejoindre le fournisseur de gaz, appelez le service des incendies.

L'installation et service doit être exécuté par un qualifié installateur, agence de service ou le fournisseur de gaz.

## CONGRATULATIONS!

In selecting this SUPERIOR B-vented gas appliance you have chosen the finest and most dependable fireplace to be found anywhere. A beautiful, prestigious, alternative to a wood burning fireplace. Welcome to a Family of tens of thousands of satisfied SUPERIOR Fireplace Owners.

Please read and carefully follow all of the instructions found in this manual. Please pay special attention to the safety instructions provided in this manual. The Homeowner's Care and Operation Instructions included here will assure that you have many years of dependable and enjoyable service from your SUPERIOR product.

## TABLE OF CONTENTS

Introduction .....	page 2
General Information .....	page 2
Operation/Care of Your Appliance ....	page 3
Combustion Air Controls .....	page 4
Maintenance .....	page 5
Manual Limit Switch .....	page 5
Millivolt Appliance Checkout .....	page 6
Electronic Appliance Checkout .....	page 6
Log Placement .....	page 7
Maintenance Schedule .....	page 6
Wiring Diagrams .....	page 8
Warranty .....	page 8
Product Reference Information .....	page 8
Replacement Parts .....	page 8
Lighting Instructions – Millivolt .....	page 10
Lighting Instructions – Electronic ....	page 12
Troubleshooting Guide – Millivolt .....	page 14
Troubleshooting Guide – Electronic ..	page 15
Replacement Parts List .....	page 16
Accessory Components .....	page 18

## INTRODUCTION

The millivolt appliances are designed to operate on either natural or propane gas. A millivolt gas control valve with piezo ignition system provides safe, efficient operation.

The electronic appliances are designed to operate on either natural or propane gas. An electronic intermittent pilot system provides safe, efficient operation. External electrical power is required to operate these units.

These appliances comply with National Safety Standards and are tested and listed by Warnock Hersey (Report No. J20006722) to ANSI Z21.50 - 2000 (in Canada, CSA 2.22 - 2000), and CAN/CGA-2.17-M91 in both USA and Canada, as vented gas fireplaces.

Installation must conform to local codes. In the absence of local codes, installation must comply with the current National Fuel Gas Code, ANSI Z223.1 (NFPA 54). (In Canada, the current CAN/CGA B149 installation code.)

Electrical wiring must comply with local codes. In the absence of local codes, installation must be in accordance with the National Electrical Code, NFPA 70 - (latest edition). (In Canada, the current CSA C22.1 Canadian Electric Code.)

**DO NOT ATTEMPT TO ALTER OR MODIFY THE CONSTRUCTION OF THE APPLIANCE OR ITS COMPONENTS. ANY MODIFICATION OR ALTERATION MAY VOID THE WARRANTY, CERTIFICATION AND LISTINGS OF THIS UNIT.**

**WARNING: IMPROPER INSTALLATION, ADJUSTMENT, ALTERATION, SERVICE OR MAINTENANCE CAN CAUSE INJURY OR PROPERTY DAMAGE. REFER TO THIS MANUAL. FOR ASSISTANCE OR ADDITIONAL INFORMATION CONSULT A QUALIFIED INSTALLER, SERVICE AGENCY OR THE GAS SUPPLIER.**

## GENERAL INFORMATION

*Note: Installation and repair should be performed by a qualified service person. The appliance should be inspected annually by a qualified professional service technician. More frequent inspections and cleanings may be required due to excessive lint from carpeting, bedding material, etc. It is imperative that the control compartment, burners and circulating air passage ways of the appliance be kept clean.*

*S'assurer que le brûleur et le compartiment des commandes sont propres. Voir les instructions d'installation et d'utilisation qui accompagnent l'appareil.*

Provide adequate clearances around air openings and adequate accessibility clearance for service and proper operation. Never obstruct the front openings of the appliance.

Due to high temperatures the appliance should be located out of traffic and away from furniture and draperies. Locate furniture and window coverings accordingly.

**WARNING: THESE FIREPLACES ARE VENTED DECORATIVE GAS APPLIANCES. DO NOT BURN WOOD OR OTHER MATERIAL IN THESE APPLIANCES.**

These appliances are designed to operate on natural or propane gas only. The use of other fuels or combination of fuels will degrade the performance of this system and may be dangerous.

Input of appliance is 15,000 BTU/HR.

Gas Type	Orifice Size	Elevation
Natural	#49 (.073)	0 - 4500' (0 - 1370 m)
Propane	(.045)	0 - 4500' (0 - 1370 m)

Nominal operating pressures for the manifold side of the gas control system are; 3.5 inches water column (0.87 kPa) for natural gas models and 10 inches water column (2.49 kPa) for propane gas models.

Do not use these appliances if any part has been under water. Immediately call a qualified, professional service technician to inspect the appliance and to replace any parts of the control system and any gas control which have been under water.

Ne pas se servir de cet appareil s'il a été plongé dans l'eau, complètement ou en partie. Appeler un technicien qualifié pour inspecter l'appareil et remplacer toute partie du système de contrôle et toute commande qui ont été plongés dans l'eau.

Millivolt appliances may be fitted at time of manufacture with either a Honeywell millivolt gas control valve or as SIT millivolt gas control valve. Both valves have been tested with and approved for use with these appliances and are listed accordingly.

Test gage connections are provided on the front of the millivolt gas control valve (identified IN for the inlet and OUT for the manifold side). A 1/8" NPT test gage connection is provided at the inlet and outlet side of the electronic gas control valve.

Minimum inlet gas pressure to the appliance is 5.0 inches water column (1.24 kPa) for natural gas and 11 inches water column (2.74 kPa) for propane for the purpose of input adjustment.

Maximum inlet gas supply pressure to the appliance is 10.5 inches water column (2.61 kPa) for natural gas and 13.0 inches water column (3.23 kPa) for propane.

The appliance must be isolated from the gas supply piping system (by closing its individual manual shut-off valve) during any pressure testing of the gas supply piping system at test pressures equal to or less than 1/2 psig (3.5 kPa).

The appliance and its individual shut-off valve must be disconnected from the gas supply piping system during any pressure testing of that system at pressures in excess of 1/2 psig (3.5 kPa).

These appliances must not be connected to a chimney or flue serving a separate solid fuel burning appliance.

**WARNING: FAILURE TO COMPLY WITH THE INSTALLATION AND OPERATING INSTRUCTIONS PROVIDED IN THIS DOCUMENT WILL RESULT IN AN IMPROPERLY INSTALLED AND OPERATING APPLIANCE, VOIDING ITS WARRANTY. ANY CHANGE TO THIS APPLIANCE AND/OR ITS OPERATING CONTROLS IS DANGEROUS. IMPROPER INSTALLATION OR USE OF THIS APPLIANCE CAN CAUSE SERIOUS INJURY OR DEATH FROM FIRE, BURNS, EXPLOSION OR CARBON MONOXIDE POISONING.**

**Carbon Monoxide Poisoning: Early signs of carbon monoxide poisoning are similar to the flu with headaches, dizziness and/or nausea. If you have these signs, obtain fresh air immediately. Turn off the gas supply to the appliance and have it serviced by a qualified professional, as it may not be operating correctly.**

**WARNING: B-VENT APPLIANCES ARE NOT DESIGNED TO OPERATE IN NEGATIVELY PRESSURED ENVIRONMENTS (PRESSURE WITHIN THE HOME IS LESS THAN PRESSURES OUTSIDE). SIGNIFICANT NEGATIVELY PRESSURED ENVIRONMENTS CAUSED BY WEATHER, HOME DESIGN, OR OTHER DEVICES MAY IMPACT THE OPERATION OF THESE APPLIANCES. NEGATIVE PRESSURES MAY RESULT IN POOR FLAME APPEARANCE, SOOTING, DAMAGE TO PROPERTY AND/OR SEVERE PERSONAL INJURY. DO NOT OPERATE THESE APPLIANCES IN NEGATIVELY PRESSURED ENVIRONMENTS.**

**WARNING: CHILDREN AND ADULTS SHOULD BE ALERTED TO THE HAZARDS OF HIGH SURFACE TEMPERATURES. USE CAUTION AROUND THE APPLIANCE TO AVOID BURNS OR CLOTHING IGNITION. YOUNG CHILDREN SHOULD BE CAREFULLY SUPERVISED WHEN THEY ARE IN THE SAME ROOM AS THE APPLIANCE.**

**WARNING: DO NOT PLACE CLOTHING OR OTHER FLAMMABLE MATERIALS ON OR NEAR THIS APPLIANCE.**

**AVERTISSEMENT: SURVEILLER LES ENFANTS. GARDER LES VÊTEMENTS, LES MEUBLES, L'ESSENCE OU AUTRES LIQUIDES À VAPEUR INFLAMMABLES LOIN DE L'APPAREIL.**

### OPERATION AND CARE OF YOUR APPLIANCE

1. Appliance operation may be controlled through a remotely located optional wall switch. Separate switches may provide independent control for the remote controlled fireplace operation (optional equipment). In lieu of remote or remote wall switch operation, the appliance must be operated directly through the controls located on the front of the valve located within the control compartment under the removable access panel, *Figure 1*.

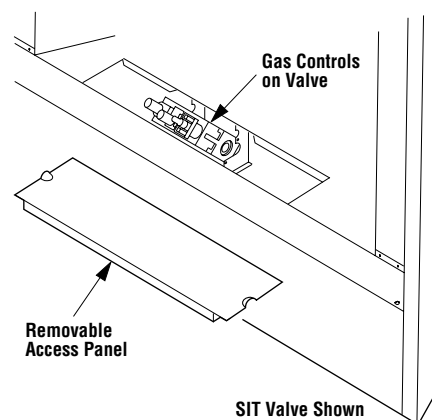

*Figure 1*

Operation of millivolt and electronic gas control systems are different. Before lighting and operating your appliance determine if you have a millivolt or electronic appliance. Refer to *Figure 1* to access the gas control compartment. Millivolt appliances will be fitted with one of the two gas control valves shown in *Figure 2*.

Appliances with electronic systems will be fitted with the electronic valve shown in *Figure 3*. Familiarize yourself with the differing controls for the valve your appliance uses.

To light millivolt appliances refer to the detailed lighting instructions found in both English and French on **pages 10 and 11** of these instructions respectively. **Millivolt and electronic appliance lighting instructions may also be found on the pull out labels attached to the gas control valve located within the gas control compartment.** See *Figure 2* to locate the appropriate location for the spark ignitor used with your appliance.

If your appliance is equipped with an optional remote wall switch or remote control kit the appliance main burner may be turned on and off with the wall switch or remote control. If the appliance is not equipped with a wall or remote control, the main burner must be turned off and on with the gas control knob. Turn the knob counter-clockwise from the PILOT position to ON to light the main burner, and clockwise from ON to PILOT to turn off the main burner.

To light electronic appliances refer to the detailed lighting instructions found in both English and French on **pages 12 and 13** of these instructions respectively. **Millivolt and electronic appliance lighting instructions may also be found on the pull out labels attached to the gas valve located within the gas control compartment.** If your appliance is equipped with an optional remote wall switch or remote control kit the appliance main burner may be turned on and off with the wall switch or remote control.

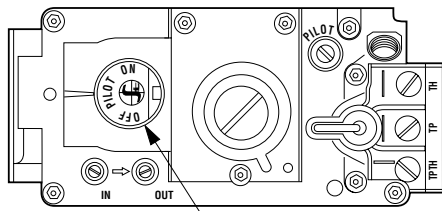

SIT Millivolt Valve Gas Control Knob

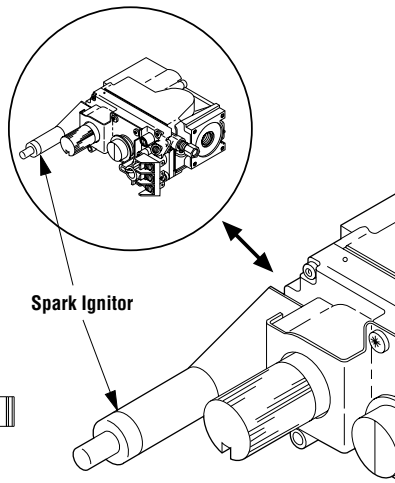

Spark Ignitor

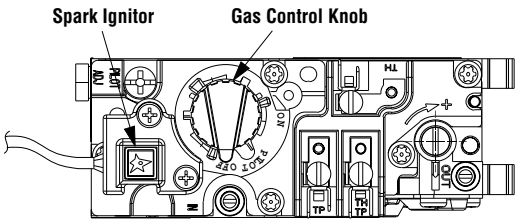

Honeywell Millivolt Valve

Figure 2

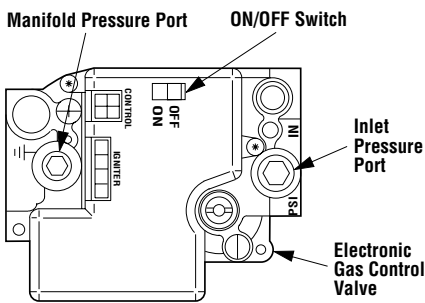

Honeywell Electronic Gas Valve

Figure 3

If the appliance is not equipped with a wall switch or remote control, the main burner must be turned off and on with the gas control switch. Toggle the switch from ON to OFF to operate the main burner from ON to OFF.

2. When lit for the first time, this appliance will emit a slight odor for an hour or two. This is due to the "burn-in" of internal paints and lubricants used in the manufacturing process.

3. Keep lower control compartment clean by vacuuming or brushing at least twice a year. More frequent cleaning may be required due to excessive lint from carpeting, bedding materials, etc. It is important that control compartments, burners and circulating air passages of the appliance be kept clean.

4. Always turn off gas to the pilot (millivolt appliances) before cleaning. Before re-lighting, refer to the lighting instructions in this manual. Instructions are also found on a pull-out panel located on the floor of the appliance.

5. Always keep the appliance area clear and free from combustible materials, gasoline and other flammable liquids.

6. Remember, Millivolt appliances have a continuous burning pilot flame. Exercise caution when using products with combustible vapors.

7. Clean the optional glass doors only when necessary. Wipe surface with clean, dampened, soft cloth. Follow with dry, soft towel as desired. Take care not to scratch the glass surface.

**WARNING: DO NOT USE ABRASIVE CLEANERS. NEVER CLEAN THE GLASS WHEN IT IS HOT.**

**CAUTION: DO NOT ATTEMPT TO TOUCH THE DOORS WITH YOUR HANDS WHILE THE FIREPLACE IS IN USE. ALWAYS USE DOOR HANDLES. DOORS WILL BECOME VERY HOT WHEN FIREPLACE IS IN USE.**

**WARNING: FIREPLACES EQUIPPED WITH OPTIONAL ACCESSORY DOORS SHOULD BE OPERATED ONLY WITH THE DOORS FULLY OPEN OR FULLY CLOSED (FIGURE 4). THIS APPLIANCE MAY ONLY BE FITTED WITH DOORS CERTIFIED FOR USE WITH THE APPLIANCE.**

**AVERTISSEMENT: POUR UTILISATION UNIQUEMENT AVEC LES PORTES EN VERRE CERTIFIÉES AVEC L'APPAREIL.**

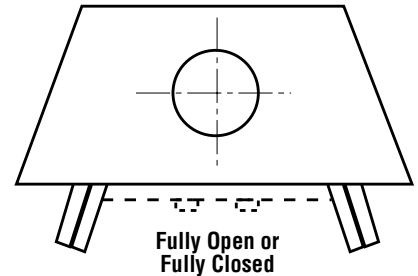

Figure 4

**COMBUSTION AIR CONTROLS**

Many appliances are equipped when installed with an outside combustion air vent system that is designed to provide the appliance with outside make-up air for combustion when in operation.

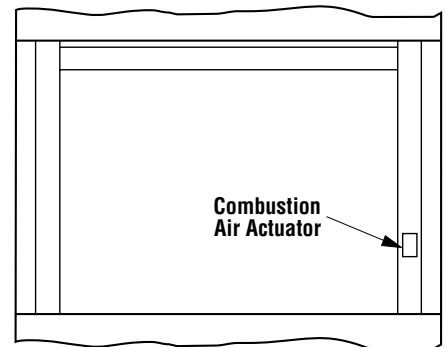
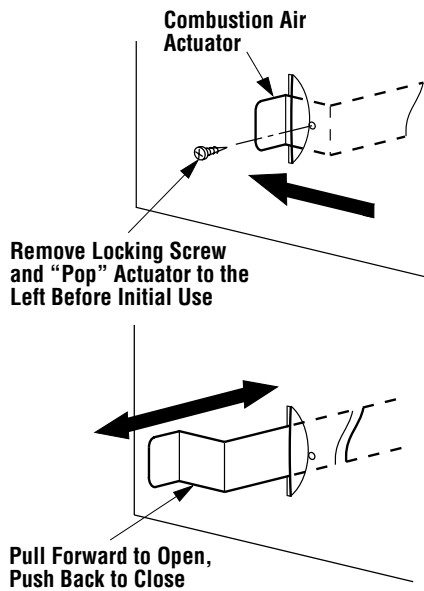

Figure 5

The actuator for combustion air system is standard on all appliances but must not be operated if the complete system is not installed. Refer to Figures 5 and 6. When the complete outside combustion air vent system is installed, the installer will remove the actuator locking screw.



**Figure 6**

If your screw is not removed and you have reason to believe that you have a complete outside combustion system, contact your distributor to have your appliance inspected for the presence of the complete system. **DO NOT** assume that you have this system in place because you have an actuating lever present on your appliance front face.

**WARNING: DO NOT OPERATE THE COMBUSTION AIR ACTUATOR UNLESS A COMPLETE OUTSIDE COMBUSTION AIR VENT SYSTEM HAS BEEN INSTALLED WITH YOUR APPLIANCE.**

To provide outside combustion air to your appliance while it is in operation, locate the combustion air actuator along the right side of the appliance opening (*refer to Figure 5*).

To operate, push the end of the actuator to the left as shown in *Figure 6*, until it "pops" free of its "locked" position. Pull the actuator forward to open the combustion air door, and push it back to close.

To "lock" the combustion air door closed, ensure the actuator is pushed all the way back, then push the end of the actuators to the right until the step in the actuator moves behind the appliance front face within the slotted opening.

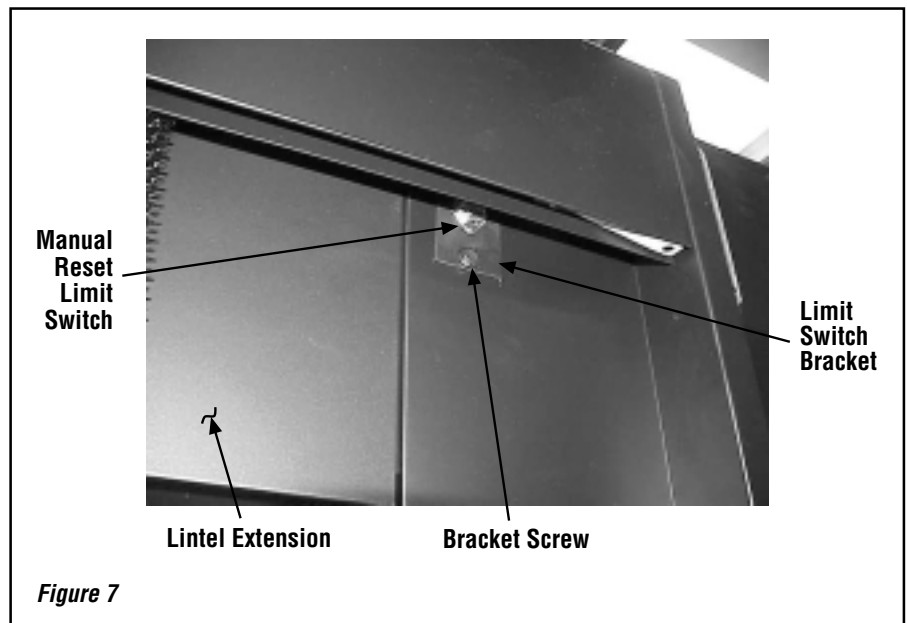

**Figure 7**

### MANUALLY-RESET BLOCKED FLUE SAFETY SWITCH

This appliance is equipped with a manually-reset blocked flue safety switch. Refer to *Figure 7* for its location. If during appliance operation, the flame goes out (independently of the burner on/off wall switch), it may be due to the operation of this safety limit switch. First **allow the appliance to cool**. Then reset the safety switch by pushing the red reset button on the back of the switch.

To access the blocked flue safety switch, remove the limit switch bracket, with switch and low voltage wires attached. Push the red reset button and then reinstall limit switch bracket.

The appliance should then relight and remain lit. If this does not occur, **turn off the appliance and call a qualified service technician**.

### Maintenance

The appliance and venting system should be thoroughly inspected before initial use and at least annually by a qualified service technician. Proper maintenance and use will require more frequent, less extensive inspections and servicing by the homeowner.

Generally, annual inspections should be performed by a qualified service technician. More frequent periodic inspections and cleanings should be performed by the homeowner. Any discrepancies discovered by the homeowner should result in a call to a qualified service technician to effect the repair or correction.

Refer to the maintenance schedule for maintenance tasks, procedures, periodicity and by whom they should be performed.

**IMPORTANT: TURN OFF GAS AND ANY ELECTRICAL POWER BEFORE SERVICING THE APPLIANCE.**

## Millivolt Appliance Checkout

The pilot flame should be steady, not lifting or floating. Flame should be blue in color with traces of orange at the outer edge.

The top  $\frac{3}{8}$ " (9 mm) at the pilot generator (thermopile) should be engulfed in the pilot flame. The flame should project 1" (25 mm) beyond the hood at all three ports (**Figure 8**).

## Electronic Appliance Checkout

Light the burner, refer to the Lightling Instructions in this manual. Ensure the ignitor lights the pilot. The pilot flame should engulf the flame rod as shown in **Figure 8**.

With proper care and maintenance, your appliance will provide many years of enjoyment. If you should experience any problem, first refer to the trouble shooting guide in this manual. If problem persists, contact your Superior distributor.

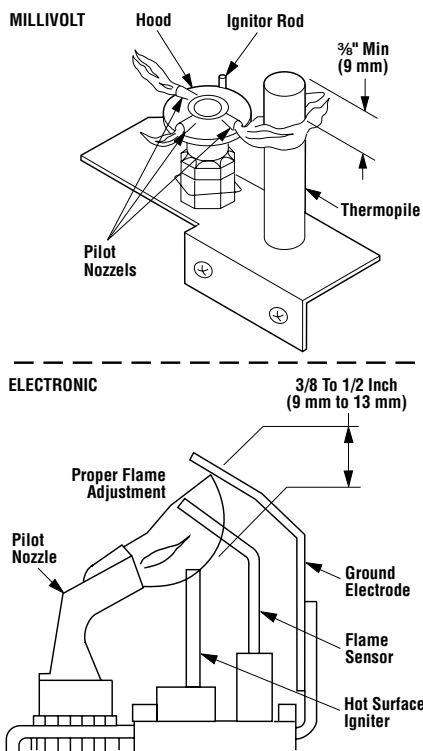

**Figure 8**

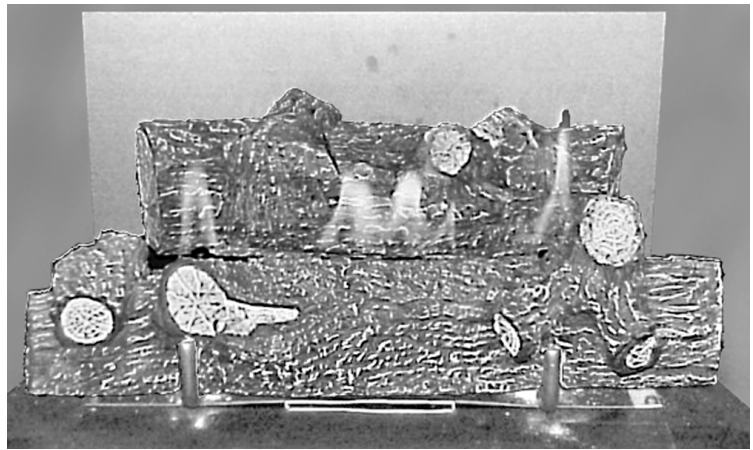

**Figure 9**

## Log Placement

**WARNING: LOGS GET VERY HOT AND WILL REMAIN HOT UP TO ONE HOUR AFTER GAS SUPPLY IS TURNED OFF. HANDLE ONLY WHEN LOGS ARE COOL. TURN OFF ALL ELECTRICITY TO THE APPLIANCE BEFORE YOU INSTALL GRATE AND LOGS.**

**WARNING: THIS APPLIANCE IS NOT MEANT TO BURN WOOD. ANY ATTEMPT TO DO SO COULD CAUSE IRREPARABLE DAMAGE TO YOUR APPLIANCE AND PROVE HAZARDOUS TO YOUR SAFETY.**

**WARNING: THE SIZE AND POSITION ON THE LOG SET WAS ENGINEERED TO GIVE YOUR APPLIANCE A SAFE, RELIABLE AND ATTRACTIVE FLAME PATTERN. ANY ATTEMPT TO USE A DIFFERENT LOG SET IN THE FIREPLACE WILL VOID THE WARRANTY AND WILL RESULT IN INCOMPLETE COMBUSTION, SOOTING, AND POOR FLAME QUALITY.**

These appliances are fitted with a pair of decorative non-combustible concrete logs that are wired in place on the log grate at the factory. Normally these logs never have to be repositioned. Occasionally they may be removed for cleaning, or just the front log may be removed to provide greater access to the pilot assembly and the control compartment below.

To remove the logs, untie the wires securing the logs to the grate. These wires are only required for shipping and should be completely cut away before repositioning the logs on the grate. Refer to **Figure 9** for log placement. Align the rear log with the slots on its bottom engaging the grate tines. Position the front log, centered on the grate and with the rear log behind it.

Decorative volcanic stone is available to enhance the look of the fireplace presentation. Decorative volcanic stone should be spread evenly through non-uniformly over the entire bottom surface of the firebox to provide the look of an ember bed.

NOTE: DIAGRAMS & ILLUSTRATIONS NOT TO SCALE.

## Maintenance Schedule

### Annually (Before the onset of the Burning Season)

Maintenance Task	Accomplishing Person	Procedure
Inspecting/Cleaning Burner, Logs and Controls	Qualified Service Technician	Inspect valve and ensure it is properly operating. Check piping for leaks. Vacuum the control compartment, fireplace logs and burner area.
Check Flame Patterns and Flame Height	Qualified Service Technician	Refer to <b>Figure 9</b> and verify the flame pattern and height displayed by the appliance conforms to the picture. Flames must not impinge on the logs.
Inspecting/Cleaning Pilot and Burner	Qualified Service Technician	Refer to <b>Figure 8</b> . Remove any surface build-up on pilot and burner assembly. Wipe the pilot nozzles, ignitor/flame rod and hood. Ensure the pilot flame engulfs the flame sensor as shown.
Checking Vent System	Qualified Service Technician	Inspect the vent system at the top and at the base (within the firebox) for signs of blockage or obstruction. Look for any signs of dislocation of the vent components.
Appliance Checkout	Qualified Service Technician	Perform the appropriate appliance checkout procedure detailed in this manual.

### Periodically (After the Burning Season)

Maintenance Task	Accomplishing Person	Procedure
Cleaning Firebox Interior	Homeowner	Carefully remove logs and volcanic stone if used. Vacuum out interior of the firebox. Clean firebox walls and log grate. Replace logs and volcanic stone as detailed in this manual.
Check Flame Patterns and Flame Height	Homeowner	Refer to <b>Figure 9</b> and verify the flame pattern and height displayed by the appliance conforms to the picture. Flames must not impinge on the logs.
Checking Vent System	Homeowner	Inspect the vent system at the top and at the base (within the firebox) for signs of blockage or obstruction. Look for any signs of dislocation of the vent components.
Cleaning Optional Glass Doors	Homeowner	Clean as necessary following the directions provided in this manual. <b>DO NOT TOUCH OR ATTEMPT TO CLEAN DOORS WHILE THEY ARE HOT.</b>

## WIRING DIAGRAMS

Wiring diagrams are provided here for reference purposes only. This information is also provided on schematics found on pullout labels attached to the gas valve located within the control compartment. Two Millivolt wiring diagrams are provided here, one each for both Honeywell and SIT equipped systems.

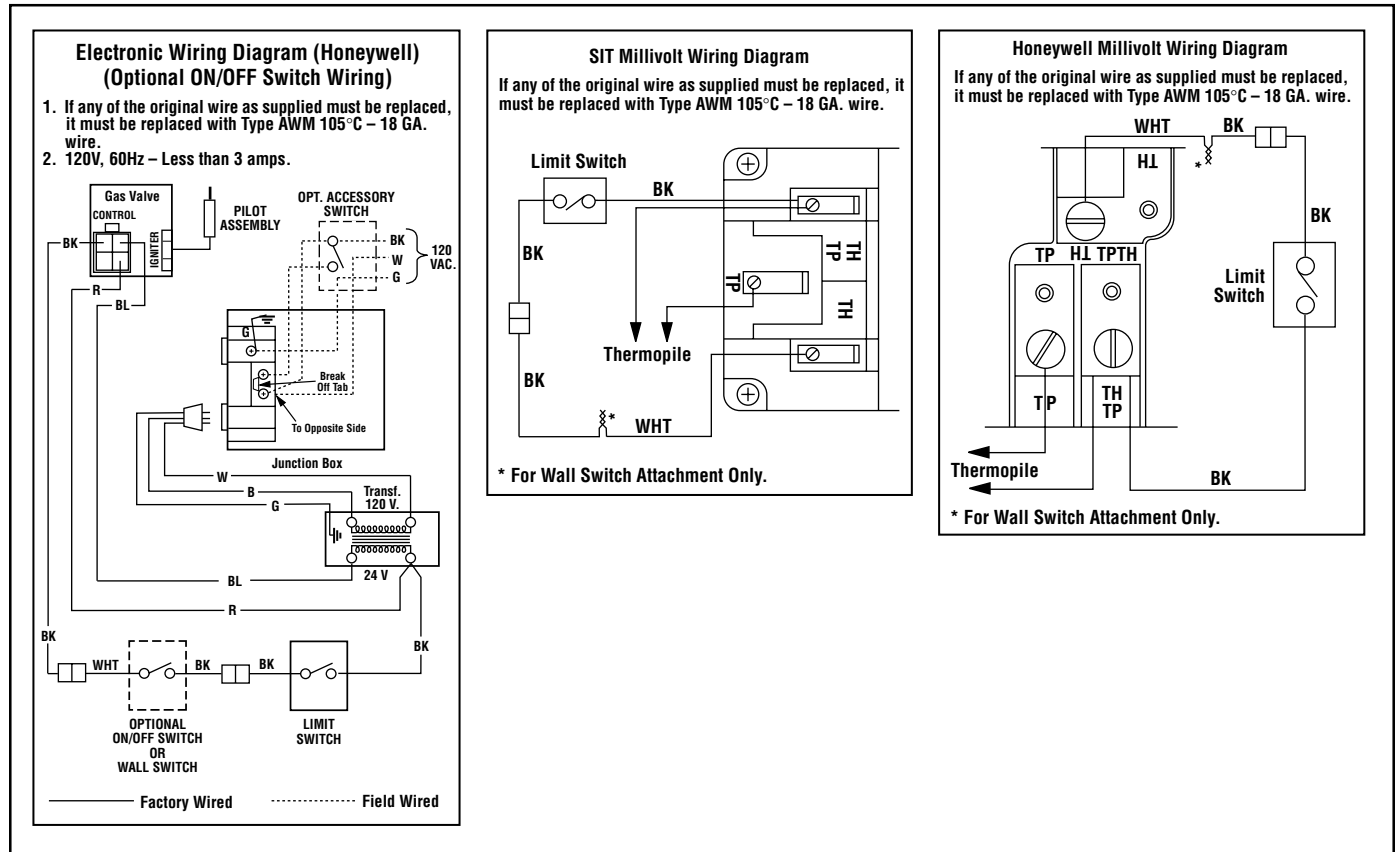

## WARRANTY

Your gas appliance is covered by a limited twenty year warranty. You will find a copy of the warranty accompanying this manual. Please read the warranty to be familiar with its coverage.

Retain this manual. File it with your other documents for future reference.

## PRODUCT REFERENCE INFORMATION

We recommend that you record the following important information about your fireplace. Please contact your Lennox dealer for any questions or concerns. For the number of your nearest Lennox dealer, please call 800-731-8101

Your Fireplace's Model Number \_\_\_\_\_

Your Fireplace's Serial Number \_\_\_\_\_

The Date On Which Your Fireplace Was Installed \_\_\_\_\_

The Type of Gas Your Fireplace Uses \_\_\_\_\_

Your Dealer's Name \_\_\_\_\_

## REPLACEMENT PARTS

A complete parts list is found at the end of this manual. Use only parts supplied from the manufacturer.

Normally, all parts should be ordered through your Lennox distributor or dealer. Parts will be shipped at prevailing prices at time of order.

When ordering repair parts, always give the following information:

1. The model number of the appliance.
2. The serial number of the appliance.
3. The part number.
4. The description of the part.
5. The quantity required.
6. The installation date of the appliance.

If you encounter any problems or have any questions concerning the installation or application of this system, please contact your distributor. For the name of your nearest distributor contact:

**LHP**  
**1110 West Taft Avenue • Orange, CA**  
**92865**



**NOTES:**

## LIGHTING INSTRUCTIONS – HONEYWELL AND SIT MILLIVOLT GAS VALVE

### FOR YOUR SAFETY READ BEFORE LIGHTING

**WARNING: IF YOU DO NOT FOLLOW THESE INSTRUCTIONS EXACTLY, A FIRE OR EXPLOSION MAY RESULT CAUSING PROPERTY DAMAGE, PERSONAL INJURY OR LOSS OF LIFE.**

- A.** This appliance has a pilot which must be lighted with a piezo ignitor. When lighting the pilot, follow these instructions exactly.
- B. BEFORE OPERATING** smell all around the appliance area for gas. Be sure to smell next to the floor because some gas is heavier than air and will settle on the floor.
- WHAT TO DO IF YOU SMELL GAS**
- Extinguish any open flame.
  - Open windows.
  - Do not light any appliance.
  - Do not touch any electrical switches.
  - Do not use any phone in your building.
  - Immediately call your gas supplier from a neighbor's phone.
  - If your gas supplier cannot be reached, call the fire department.
- C.** Use only your hand to push in or turn the gas control knob. Never use tools. If the knob will not push in or turn by hand, do not try to repair it, call a qualified service technician. Force or attempted repair may result in a fire or an explosion.
- D.** Do not use this appliance if any part has been under water. Immediately call a qualified service technician to inspect the appliance and to replace any part of the control system and any gas control which has been under water.

### LIGHTING INSTRUCTIONS

1. **STOP!** Read the safety information above on this page.
2. Access the lower control compartment.
3. Turn remote wall switch to "OFF."
4. Verify main line shut-off valve is open.
5. Push in gas control knob slightly and turn clockwise to "OFF."
6. Wait five (5) minutes to clear out any gas. If you then smell gas, STOP! Follow "B" in the safety information above on this page. If you do not smell gas, go to the next step.
7. Push in gas control knob slightly and turn counterclockwise to "PILOT."
8. Push in control knob all the way and hold in. Immediately light the pilot by triggering the spark ignitor (pushing the button) until pilot lights. Continue to hold the control knob in for about 1 ½ minutes after the pilot is lit. Release knob and it will pop back up. Pilot should remain lit. If it goes out, repeat steps 5 through 8.

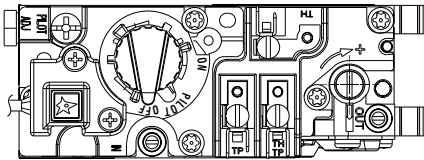

**HONEYWELL  
MILLIVOLT  
GAS VALVE**

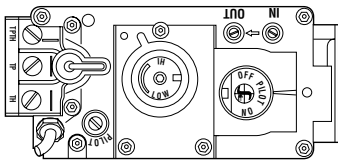

**SIT  
MILLIVOLT  
GAS VALVE**

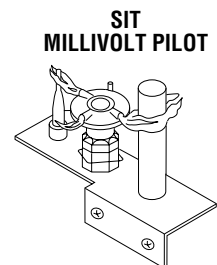

**SIT  
MILLIVOLT PILOT**

- If knob does not pop up when released, stop and immediately call your service technician or gas supplier.
- If pilot will not stay lit after several tries, turn the control knob to "OFF" and call your service technician or gas supplier.

**Note:** Knob cannot be turned from "PILOT" to "OFF" unless the knob is pushed in slightly. Do not force.

9. Turn gas control knob counterclockwise to "ON."
10. Close lower control compartment.

### TO TURN OFF GAS TO APPLIANCE

1. Turn remote wall switch "OFF." The pilot will remain lit for normal service.
2. For complete shutdown, turn remote wall switch to "OFF."
3. Access the lower control compartment.
4. Depress gas control knob slightly and turn clockwise to "OFF." Do not force.
5. Close lower control compartment.

## INSTRUCTIONS D'ALLUMAGE – VANNE GAZ MILLIVOLT HONEYWELL ET SIT

### POUR VOTRE SÉCURITÉ, LISEZ CES INSTRUCTIONS AVANT L'ALLUMAGE

**AVERTISSEMENT : SI VOUS NE SUIVEZ PAS CES INSTRUCTIONS À LA LETTRE, IL POURRAIT S'EN SUIVRE UN INCENDIE OU UNE EXPLOSION CAUSANT DES DOMMAGES MATÉRIELS, DES BLESSURES CORPORELLES OU MÊME DES PERTES DE VIE.**

- A.** Cet appareil est muni d'une veilleuse qui doit être allumée avec un allumeur piézo-électrique. Lorsque vous allumez la veilleuse, suivre exactement ces instructions.
- B. AVANT L'ALLUMAGE:** Assurez-vous que vous ne détectez aucune odeur de gaz autour de l'appareil ainsi que près du sol; certains gaz, étant plus lourds que l'air, descendent au niveau du sol.  
**VOICI CE QUE VOUS DEVEZ FAIRE SI VOUS DÉCELEZ UNE ODEUR DE GAZ:**
- Éteignez toute flamme visible.
  - Ouvrez les fenêtres.
  - N'allumez aucun appareil.
  - Ne touchez à aucun commutateur électrique.
  - Ne vous servez d'aucun téléphone dans votre édifice.
- Appelez immédiatement votre compagnie de gaz en utilisant le téléphone du voisin.
  - S'il vous est impossible de contacter votre compagnie de gaz, appelez le service des incendies.
- C.** N'utilisez que votre main pour manipuler le bouton de réglage du gaz. N'utilisez jamais d'outils. Si le bouton refuse de tourner ou de bouger, n'essayez pas de le réparer. Communiquez immédiatement avec un technicien de service qualifié. Toute tentative pour le forcer ou le réparer, risquerait de provoquer un incendie ou une explosion.
- D.** Ne vous servez pas de cet appareil si l'un de ses éléments a été immergé dans l'eau. Appelez immédiatement un technicien compétent pour faire inspecter l'appareil et remplacer toute pièce du système de réglage ou commande du gaz qui a été sous l'eau.

### INSTRUCTIONS D'ALLUMAGE

- 1. ARRÊTEZ!** Lisez les consignes de sécurité au verso de cette plaque.
- Ouvrez le compartiment de contrôle du bas.
- Tournez l'interrupteur mural à la position d'arrêt "OFF".
- Assurez-vous que la soupape d'arrêt de la canalisation principale est ouverte.
- Enfoncez légèrement le bouton de réglage du gaz et tournez-le dans le sens des aiguilles d'une montre  jusqu'à la position d'arrêt "OFF".

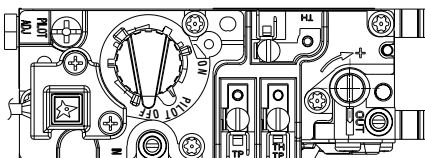

**VANNE GAZ  
MILLIVOLT  
HONEYWELL**

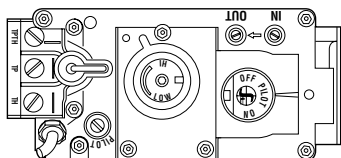

**VANNE GAZ  
MILLIVOLT SIT**

**Remarque:** Il est impossible de tourner le bouton de "PILOT" à "OFF" à moins qu'il ne soit légèrement enfoncé. Ne le forcez pas.

- Attendez cinq (5) minutes pour l'évacuation du gaz. Si vous décelez une odeur de gaz, ARRÊTEZ ! Retournez au point "B" des consignes de sécurité au verso de cette plaque. Si vous ne remarquez aucune odeur de gaz, passez à l'étape suivante.
- Enfoncez légèrement le bouton de réglage du gaz et tournez-le en sens inverse des aiguilles d'une montre jusqu'à la position de veilleuse  "PILOT".

- Enfoncez le bouton de réglage jusqu'au fond et gardez-le enfoncé. Allumez immédiatement la veilleuse en déclenchant l'allume-gaz à étincelle (en poussant le bouton) jusqu'à ce que la veilleuse s'enflamme. Continuez de tenir le bouton de réglage enfoncé pendant environ 90 secondes après l'allumage de la veilleuse. Relâchez le bouton et il sortira subitement. La veilleuse devrait rester allumée. Si elle s'éteint, répétez les étapes 5 à 8 inclusivement.

• Si le bouton ne sort pas automatiquement après avoir été relâché, arrêtez immédiatement et téléphonez à votre technicien de service ou à votre fournisseur de gaz.

• Si la veilleuse refuse de rester allumée après plusieurs tentatives, tournez le bouton de réglage jusqu'à sa position d'arrêt "OFF" et téléphonez à votre technicien de service ou à votre fournisseur de gaz.

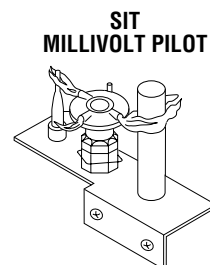

- Tournez le bouton de réglage du gaz en sens inverse des aiguilles d'une montre  jusqu'à sa position de marche "ON".

- Fermez le compartiment de contrôle du bas.

- Au besoin, rebrancher l'appareil au courant électrique et remettre l'interrupteur du brûleur principal à la position "ON" ou régler le thermostat à la température désirée.
- Si l'appareil ne fonctionne pas, suivre les instructions intitulées "Pour fermer le gaz qui alimente l'appareil" et appeler un technicien ou le fournisseur de gaz.

### POUR FERMER LE GAZ QUI ALIMENTE L'APPAREIL

- Tournez l'interrupteur mural à la position d'arrêt "OFF". La veilleuse restera allumée jusqu'au retour du service normal.
- Pour une fermeture complète, tournez l'interrupteur mural à la position d'arrêt "OFF".
- Ouvrez le compartiment de contrôle du bas.
- Enfoncez légèrement le bouton de réglage du gaz et tournez-le dans le sens des aiguilles d'une montre  jusqu'à la position d'arrêt "OFF". Ne forcez pas le bouton.
- Fermez le compartiment de contrôle du bas.

## LIGHTING INSTRUCTIONS — ELECTRONIC

### FOR YOUR SAFETY READ BEFORE LIGHTING

**WARNING: IF YOU DO NOT FOLLOW THESE INSTRUCTIONS EXACTLY, A FIRE OR EXPLOSION MAY RESULT CAUSING PROPERTY DAMAGE, PERSONAL INJURY OR LOSS OF LIFE.**

- A.** When lighting the appliance, follow these instructions exactly.
- B. BEFORE OPERATING** smell all around the appliance area for gas. Be sure to smell next to the floor because some gas is heavier than air and will settle on the floor.

#### WHAT TO DO IF YOU SMELL GAS

- Extinguish any open flame.
  - Open windows.
  - Do not light any appliance.
  - Do not touch any electrical switches.
  - Do not use any phone in your building.
- C.** Use only your hand to turn the gas control lever. Never use tools. If the lever will not turn by hand, do not try to repair it, call a qualified service technician. Force or attempted repair may result in a fire or an explosion.
- D.** Do not use this appliance if any part has been under water. Immediately call a qualified service technician to inspect the appliance and to replace any part of the control system and any gas control which has been under water.

### LIGHTING INSTRUCTIONS

1. **STOP!** Read the safety information above on this page.
2. Turn remote wall switch to “OFF.”
3. Open lower control compartment door.
4. Verify main line shut-off valve is open.

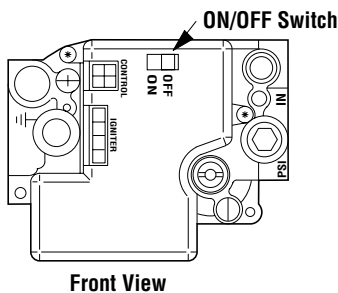

5. Turn the ON/OFF switch to “OFF”. Do not force.
6. Wait five (5) minutes to clear out any gas. If you then smell gas, STOP! Follow “B” in the safety information above on this page. If you do not smell gas, go to the next step.
7. Turn the ON/OFF switch to “ON”. Do not force.
8. Turn “ON” all electrical power to appliance (remote wall switch).
9. Close lower control compartment door.

#### TO SHUT OFF

1. Turn off all electrical power to the appliance (remote wall switch).

### TO TURN OFF GAS TO APPLIANCE

1. For complete shut-down, turn remote wall switch to “OFF.”
2. Open lower control compartment door.
3. Turn the ON/OFF switch to “OFF”. Do not force.
4. Close the main line shut-off valve.
5. Close lower control compartment door.

## INSTRUCTIONS D'ALLUMAGE — ELECTRONIC

### POUR VOTRE SÉCURITÉ, LISEZ CES INSTRUCTIONS AVANT L'ALLUMAGE

**AVERTISSEMENT: SI VOUS NE SUIVEZ PAS CES INSTRUCTIONS À LA LETTRE, IL POURRAIT S'EN SUIVRE UN INCENDIE OU UNE EXPLOSION CAUSANT DES DOMMAGES MATÉRIELS, DES BLESSURES CORPORELLES OU MÊME DES PERTES DE VIE.**

- A.** Lorsque vous allumez l'appareil, suivez exactement ces instructions.
- B. AVANT L'ALLUMAGE:** Assurez-vous que vous ne détectez aucune odeur de gaz autour de l'appareil ainsi que près du sol; certains gaz, étant plus lourds que l'air, descendent au niveau du sol.
- VOICI CE QUE VOUS DEVEZ FAIRE SI VOUS DÉCELEZ UNE ODEUR DE GAZ**
- Éteignez toute flamme visible.
  - Ouvrez les fenêtres.
  - N'allumez aucun appareil.
  - Ne touchez à aucun commutateur électrique.
  - Ne vous servez d'aucun téléphone dans votre édifice.
- Appelez immédiatement votre compagnie de gaz en utilisant le téléphone du voisin.
  - S'il vous est impossible de contacter votre compagnie de gaz, appelez le service des incendies.
- C.** N'utilisez que votre main pour manipuler l'interrupteur "ON/OFF" de la valve à gaz. N'utilisez jamais d'outils. Si l'interrupteur ne bouge pas manuellement, n'essayez pas de le réparer. Communiquez immédiatement avec un technicien de service qualifié. Toute tentative pour forcer l'interrupteur ou le réparer, risquerait de provoquer un incendie ou une explosion.
- D.** Ne vous servez pas de cet appareil si l'un de ses éléments a été immergé dans l'eau. Appelez immédiatement un technicien compétent pour faire inspecter l'appareil et remplacer toute pièce du système de réglage ou commande du gaz qui a été sous l'eau.

### INSTRUCTIONS D'ALLUMAGE

- 1. ARRÊTEZ !** Lisez les consignes de sécurité au verso de cette plaque.
2. Tournez l'interrupteur mural à la position d'arrêt "OFF".
3. Ouvrez la porte du compartiment de contrôle du bas.
4. Assurez-vous que la soupape d'arrêt de la canalisation principale est ouverte.
5. Tournez la manette de réglage du gaz à la position d'arrêt "OFF".
6. Attendez cinq (5) minutes pour l'évacuation du gaz. Si vous décelez une odeur de gaz **ARRÊTEZ !** Retournez au point "B" des consignes de sécurité au verso de cette plaque. Si vous ne remarquez aucune odeur de gaz, passez à l'étape suivante.
7. Tournez la manette de réglage du gaz jusqu'à la position de marche "ON". Ne la forcez pas.
8. Ouvrez le courant électrique ("ON") qui alimente l'appareil (interrupteur mural).
9. Fermez la porte du compartiment de contrôle du bas.
10. Au besoin, rebrancher l'appareil au courant électrique et remettre l'interrupteur principal du brûleur à la position "ON" ou réglez le thermostat à la température désirée.
11. Si l'appareil ne se met pas en marche, suivre les instructions intitulées "Pour fermer le gaz qui alimente l'appareil" et appeler un technicien ou le fournisseur de gaz.

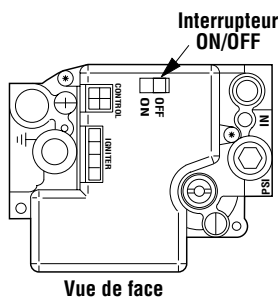

Vue de face

### POUR ÉTEINDRE L'APPAREIL

1. Coupez tout le courant électrique qui alimente l'appareil (interrupteur mural).

### POUR FERMER LE GAZ QUI ALIMENTE L'APPAREIL

1. Pour une fermeture complète, tournez l'interrupteur mural à la position d'arrêt "OFF".
2. Ouvrez la porte du compartiment de contrôle du bas.
3. Tournez la manette de réglage du gaz à la position d'arrêt "OFF". Ne la forcez pas.
4. Fermez la soupape d'arrêt de la canalisation principale.
5. Fermez la porte du compartiment de contrôle du bas.

# TROUBLESHOOTING THE MILLIVOLT GAS CONTROL SYSTEM

**Note:** Before troubleshooting the gas control system, be sure external gas shut off valve (located at gas supply inlet) is in the "ON" position.

**Important:** Valve system troubleshooting should only be accomplished by a qualified service technician.

SYMPTOM	POSSIBLE CAUSES	CORRECTIVE ACTION
1. Spark ignitor will not light pilot after repeated triggering of ignitor button.	A. Defective ignitor (no spark at electrode).	Check for spark at electrode and pilot; if no spark and electrode wire is properly connected, replace ignitor.
	B. Defective or misaligned electrode at pilot (spark at electrode).	Using a match, light pilot. If pilot lights, turn off pilot and trigger the ignitor button again. If pilot lights, an improper gas mixture caused the bad lighting and a longer purge period is recommended. If pilot will not light – check gap at electrode and pilot - should be 1/8" to have a strong spark. If gap measures 1/8", replace pilot ( <b>Figure 8 on page 6</b> ).
	C. Gas supply pressure errant.	Check inlet gas pressure. It should be within the limits as marked on the rating plate.
	D. Pilot orifice plugged.	Clean or replace pilot orifice.
2. Pilot will not stay lit after carefully following the lighting instructions.	A. Defective pilot generator (thermogenerator).	Check pilot flame, it must impinge on thermogenerator ( <b>Figure 8 on page 6</b> ). Clean and/or adjust pilot for maximum flame impingement on thermogenerator. Ensure that the connection between the valve and thermogenerator are tight and secure.
3. Pilot burning, no gas to burner, Valve knob "ON," Wall Switch "ON."	A. Wall switch or wires defective.	Check wall switch and wires for proper connections. Jumper wire across terminals at wall switch, if burner comes on, replace defective wall switch. If okay, jumper wires across wall switch wires at valve, if burner comes on, wires are faulty or connections are bad.
	B. Thermopile may not be generating sufficient millivoltage.	Check thermopile with millivolt meter. Take reading at thermopile terminals of gas valve. Should read 325 millivolts minimum with optional wall switch "OFF." Replace faulty thermopile if reading is below specified minimum.
	C. Plugged burner orifice.	Check burner orifice for stoppage and remove.
4. Frequent pilot/burner outage problem.	A. Pilot flame may be too low or blowing (high) causing the pilot/valve safety to drop out.	Clean and/or adjust pilot flame for maximum flame impingement on thermogenerator ( <b>Figure 8 on page 6</b> ).

# TROUBLESHOOTING THE ELECTRONIC IGNITION SYSTEM

**Note:** Before troubleshooting, be sure that the appliance main line gas shut-off valve, the gas control valve and the wall switch are in the "ON" position.

**Important:** Valve system troubleshooting should only be accomplished by a qualified service technician.

SYMPTOM	POSSIBLE CAUSES	CORRECTIVE ACTION
1. Burner will not light.	A. Faulty Valve System.	See Below.
	B. Faulty limit switch.	Reset the limit switch button. If still not working, remove wire nut from the leads attached to the limit switch and check for continuity. If no continuity, replace limit switch.
	C. "OFF/ON" or wall switch defective.	Disconnect the two black wires from the wire nuts. Test switch(s) for continuity with a multimeter. If continuity is not indicated, switch(s) is defective and must be replaced.  Note: Before replacing "OFF/ON" switch, be sure to check wiring for loose connections or broken wires and repair as needed.
2. Burners come "ON" but go "OFF."	A. Burner orifice plugged.	Check main burner orifice(s) for stoppage. Clean or replace.
	B. Obstructed vent system.	Check vent system for obstructions.

## START

- Turn Off Gas Supply
- Assure Valve Switch Is In ON Position
- Disconnect Control Harness
- Set Thermostat To Call For Heat

- Check For Proper Voltage At Control Harness (See Insert A). Voltage Should Be 24V Between Thermostat Or Pressure Switch And 24V Common And 24V Hot.

## CHECK

- Line Voltage Power
- Low Voltage Transformer
- Limit Controller
- Thermostat
- Wiring

- Plug Control Harness Into Valve. Wait For Internal Check Delay.

- Igniter Warms Up And Glows Red.

- With Pilot Burner Cable Connected, Measure Voltage At Valve HSI Element Output. 24V Nominal. (See Insert B)

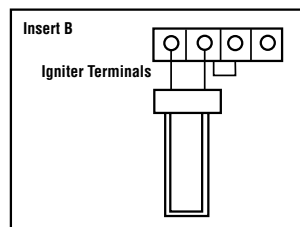
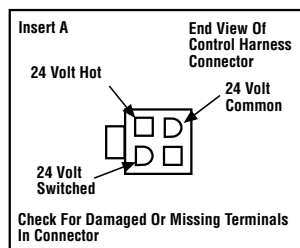

- Turn On Gas Supply. • Pilot Burner Lights.

- Check That Pilot Gas Is Flowing. Wait To Assure Pilot Gas Tubing Is Purged. Recycle Call For Heat If Necessary.

- Turn On Gas Supply. • Pilot Burner Lights.

- Measure Voltage Between 24V Hot And 24V Common Leads To Valve Control. Must Measure At Least 19.5 VAC With Igniter Powered (See Insert A). To Identify Proper Lead, This Check Must Be Done With The Valve Control Connected And Igniter Powered.

- Turn On Gas Supply. • Pilot Burner Lights.

- Replace Pilot Assembly.

- Turn On Gas Supply. • Pilot Burner Lights.

- Check That Pilot Flame Makes Good Contact With Pilot Burner Flame Rod.
- Check For Good Electrical Connection Through The Pilot Tubing.
- If Both Of The Above Are Good, Replace Igniter/Flame Rod Assembly.

- Turn On Gas Supply. • Pilot Burner Lights.

- Cycle Thermostat Off And Back On.

- Turn On Gas Supply. • Pilot Burner Lights.

- Main Burner Lights.

- Turn On Gas Supply. • Pilot Burner Lights.

- Main Burner Lights.

- Turn On Gas Supply. • Pilot Burner Lights.

- Main Burner Lights.

- Turn On Gas Supply. • Pilot Burner Lights.

- Main Burner Lights.

- Turn On Gas Supply. • Pilot Burner Lights.

- Main Burner Lights.

- Turn On Gas Supply. • Pilot Burner Lights.

- Main Burner Lights.

- Turn On Gas Supply. • Pilot Burner Lights.

- Main Burner Lights.

- Turn On Gas Supply. • Pilot Burner Lights.

- Main Burner Lights.

- Turn On Gas Supply. • Pilot Burner Lights.

- Main Burner Lights.

- Turn On Gas Supply. • Pilot Burner Lights.

- Main Burner Lights.

- Turn On Gas Supply. • Pilot Burner Lights.

- Main Burner Lights.

- Turn On Gas Supply. • Pilot Burner Lights.

- Main Burner Lights.

- Turn On Gas Supply. • Pilot Burner Lights.

- Main Burner Lights.

⚠ Igniter Will Cycle Off And Back On Once During The 90 Second Ignition Trial. All Voltage Measurements Must Be Taken While The Igniter Is Powered.

⚠ When Measured Voltage At Connections, Use Care To Assure Terminals Are Not Damaged.

## REPLACEMENT PARTS LIST

No.	DESCRIPTION	Natural		Propane	
		Part No.	Qty.	Part No.	Qty.
	Gas Fireplace Assembly	–	–	–	–
1.	Firescreen	161116	2	161116	2
2.	Rod, Screen	498169	2	498169	2
3.	Front Log	LB-97316A	1	LB-97316A	1
4.	Rear Log	LB-97317A	1	LB-97317A	1
5.	Burner	75L1101	1	75L1101	1
6.	Log Grate	LB-97307	1	LB-97307	1
7.	Burner Orifice	21L8201	1	75L1001	1
8.	Limit Switch	75L2301	1	75L2301	1

## GAS CONTROLS — MILLIVOLT

No.	DESCRIPTION	Natural		Propane	
		Part No.	Qty.	Part No.	Qty.
*10.	Gas Valve - SIT	H165801	1	H165901	1
*11.	Gas Valve - Honeywell	62L0501	1	62L0501	1
12.	Pilot Assembly (SIT)	62L1201	1	62L1301	1
13.	Pilot Generator	60J7901	1	60J7901	1
14.	Electrode And Cable	74L5801	1	74L5801	1
**15.	Piezo Igniter	111061	1	111061	1
**16.	Ignition Cable	902164	1	902164	1
17.	Pilot Tube	74L5601	1	74L5601	1

\*Appliances may be fitted at the factory with either a Honeywell or SIT Millivolt gas control valve.

\*\*For SIT gas valve equipped appliances only.

## GAS CONTROLS — ELECTRONIC

No.	DESCRIPTION	Natural		Propane	
		Part No.	Qty.	Part No.	Qty.
20.	Gas Valve - Honeywell	62L1801	1	62L1901	1
21.	Pilot Assembly - Honeywell	62L1401	1	62L1501	1
22.	Transformer	42J3201	1	42J3201	1
23.	Ignitor Assembly (Kit)	87L54	1	87L54	1



# REPLACEMENT PARTS

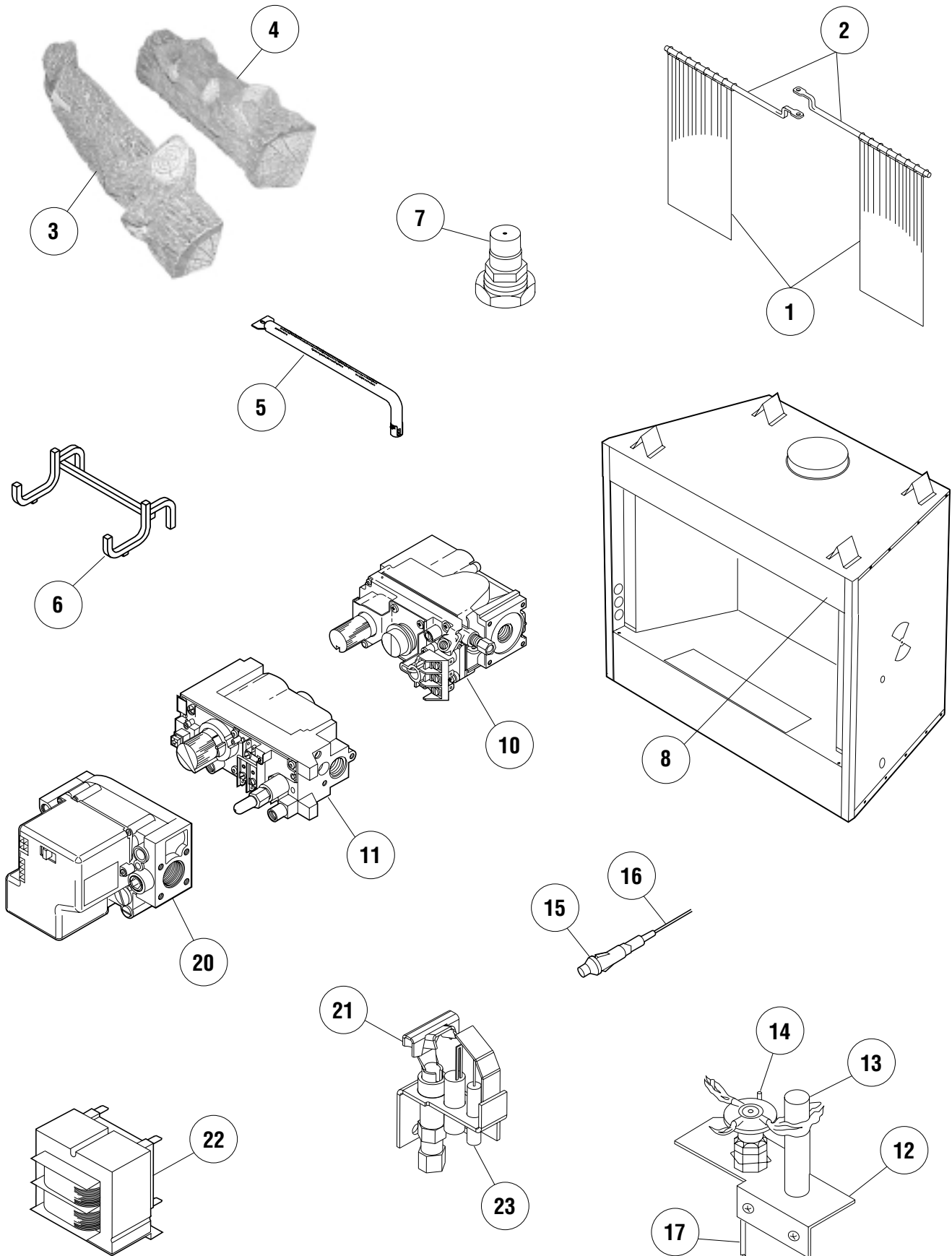

NOTE: DIAGRAMS & ILLUSTRATIONS NOT TO SCALE.

## ACCESSORY COMPONENTS



Remote Control System (Standard) H0249 RCL

### Standard Remote Control System (Model RCL)

The Model RCL (Standard) Remote Control System, features a simplistic on/off control function for the fireplace. This model includes a hand-held transmitter, a remote receiver with wall-mount coverplate and all hardware required to install the unit. The remote receiver can be wall or hearth mounted.

The transmitter has ON and OFF functions that are activated by pressing either button on the face of the transmitter. When a button on the transmitter is pressed, a signal light illuminates briefly to verify that a signal has been sent.

The Model RCL is designed to operate with all millivolt ignition systems, as well as electronic ignition systems. It may be installed with use for either natural or propane gas appliances. The RCL offers ease of installation and allows you to execute on-off commands to the fireplace effortlessly with one simple motion.

The Model RCL comes complete with detailed operating instructions.



Touch-Up Paint Kit 81L30 FTPK-B

### Touch-Up Paint Kit

Repair of minor scratches and discoloration of the appliance black painted surfaces may be accomplished with the touch-up paint kit.

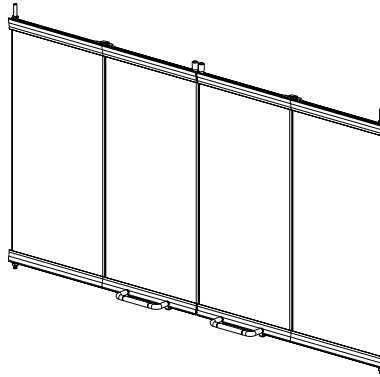

Bi-Fold Doors

### Bi-Fold Doors

Your fireplace can be fitted with beautiful bi-fold doors. Model ABF doors are available for use with these fireplace. Doors are easily fitted to the fireplace opening. Model 36 ABF doors come with standard black finish. Model 36 ABF-BB doors have a beautiful bright brass finish. Model 36 ABF-BS doors have a brushed stainless finish.

86L26	36 ABF
86L27	36 ABF-BB
86L28	36 ABF-BS
12M01	36BF
12M02	36BF-BB

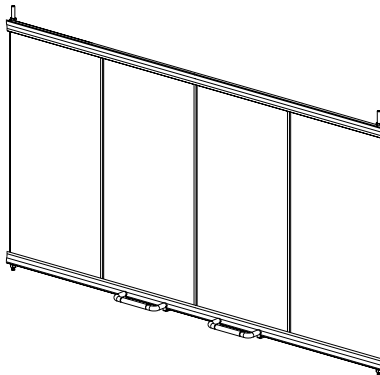

Glass Enclosure Panels 27M30 36GEP  
27M31 36GEP-BB

Your fireplace can be fitted with beautiful glass enclosure panels with a bi-fold "look" (non-operable doors once installed). Model 36GEP is finished in black trim; model 36GEP-BB is finished in polished brass trim.

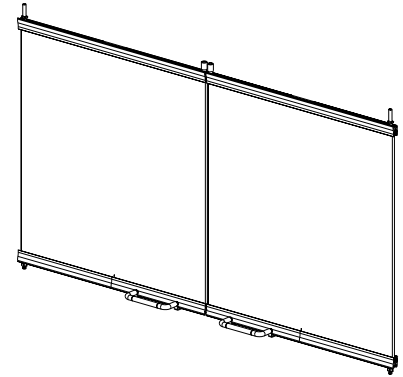

Twin Pane Doors 86L29 36 TPA-BB

### Twin Pane Doors

Your fireplace can be fitted with beautiful twin pane doors. Model TPA doors are available for use with these fireplace. Model TPA doors are easily fitted to the fireplace opening. Model 36 TPA-BB doors have a beautiful bright brass finish.

**To ensure warranty and to prevent a potential fire hazard, do not use any other doors on these appliances.**

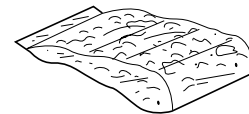

Decorative Volcanic Stone 80L42 FDVS

### Decorative Volcanic Stone

The decorative volcanic stone, Model FDVS, can be used to enhance the look of your appliance. Spread the decorative volcanic stone evenly around the bottom of the firebox.



---

The manufacturer reserves the right to make changes at any time, without notice, in design, materials, specifications, prices and also to discontinue colors, styles and products.  
Consult your local distributor for fireplace code information.

Printed in U.S.A. © 2001 by Lennox Hearth Products

**P/N 725,008M REV. F 05/2004**

**LHP**

**1110 West Taft Avenue • Orange, CA 92865**

## Free Manuals Download Website

<http://myh66.com>

<http://usermanuals.us>

<http://www.somanuals.com>

<http://www.4manuals.cc>

<http://www.manual-lib.com>

<http://www.404manual.com>

<http://www.luxmanual.com>

<http://aubethermostatmanual.com>

Golf course search by state

<http://golfingnear.com>

Email search by domain

<http://emailbydomain.com>

Auto manuals search

<http://auto.somanuals.com>

TV manuals search

<http://tv.somanuals.com>