

Sunbeam®

PARTS LIST LISTE DES PIÈCES LISTA DE PIEZAS

IMPORTANT!!
TO AVOID UNNECESSARY PROBLEMS!!
BEFORE YOU BEGIN:

Review this parts list with the parts in your carton.
If you have missing or damaged parts,
call this number IMMEDIATELY,
1-800-641-2100, for the SERVICE CENTER nearest you.

IMPORTANT!!
POUR ÉVITER LES COMPLICATIONS
INUTILES,

veuillez vérifier la liste des pièces comprise dans l'emballage **AVANT DE COMMENCER**. Si une pièce est manquante ou endommagée, veuillez appeler IMMÉDIATEMENT le 1-800-641-2100 pour connaître le CENTRE DE SERVICE le plus près de chez vous.

¡ IMPORTANTE !
PARA EVITAR PROBLEMAS INNECESARIOS
ANTES DE EMPEZAR:

Compare esta lista de piezas con las piezas que se encuentran dentro de la caja de cartón.
En caso de que falten piezas o algunas estén en mal estado, llamar a este número INMEDIATAMENTE:
1-800-641-2100, para averiguar cual es el CENTRO DE SERVICIO más cercano a usted.

MODELS · MODÈLES · MODELOS WG4610HP

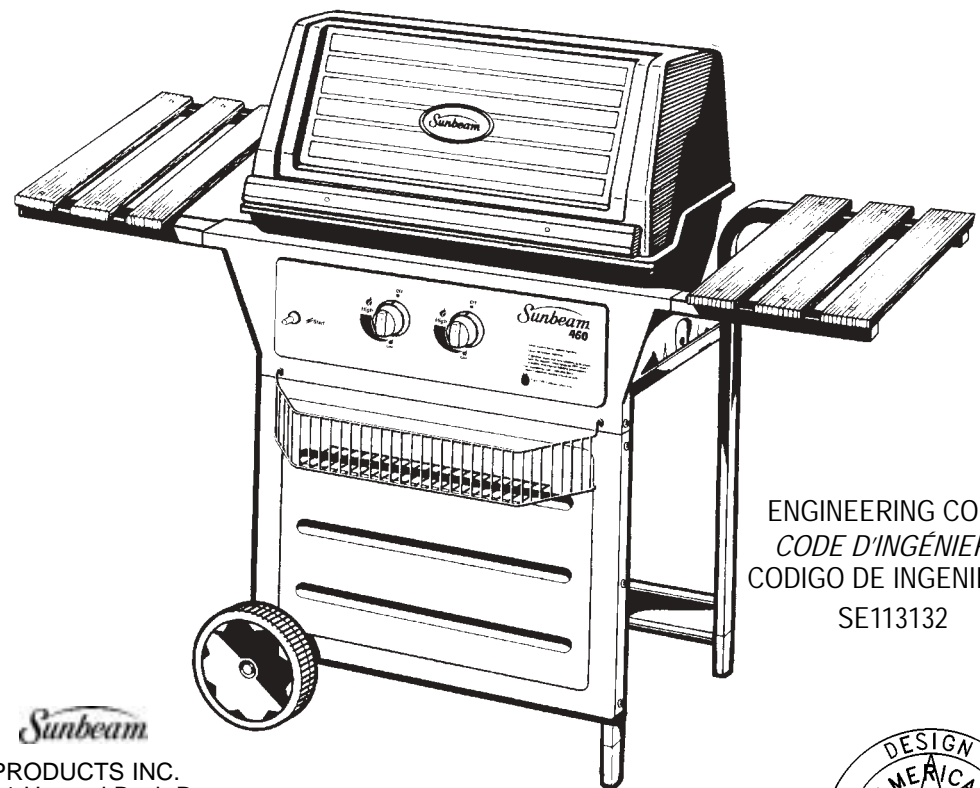

ENGINEERING CODE:
CODE D'INGÉNIERIE
CODIGO DE INGENIERIA:
SE113132

Sunbeam

PRODUCTS INC.
4101 Howard Bush Dr.
Neosho, Mo. 64850
INTERNET SITE:
SITE INTERNET :
PAGINA EN INTERNET:
www.bbqh.com



1144-0682BX 99/09

LISTA DE PIEZAS- WG4610HP PARTS LIST- LISTE DES PIÈCES

Key Réf. Clave	Qty. Qté. Cntd.	Part# N° pièce Parte#	DESCRIPTION	DESCRIPTION	DESCRIPCION
1	1	0121 0437 01	STRAP	TRVERSE DE PIÈTEMENT	TIRAS
2	1	0123 0163	TANK CADDY	TANK CADDYPORTE-BOUEILLE	CARRITO PARA EL TANQUE
3	1	0123 0148	AXLE	ESSIEU	EJE
4	2	0434 0125 01	LEGS 1"	PIED, 1 PO	PATA 1" (2,54 cm)
9	6	1116 0119 05	SIDE TABLES	TABLETTE LATÉRALE	TABLA LATERAL
14	4	3023 0192	TABLE EXTENSIONS	RALLONGE DE TABLETTE	TABLE EXTENSION
16	2	3022 0118	WHEELS	ROUE	RUEDAS
17	2	0040 0251	HUB CAPS	COUVRE-MOYEU	TAPACUBOS
18	2	3023 0198	LEG EXTENSIONS1"	RALLONGE DE PIED 1 PO	EXTENSION DE PATA 1" (2,54 cm)
20	1	0124 0209 01	FRONT PANEL	PANNEAU DE FAÇADE	PANEL FRONTAL
22	1	3822 0130	FRONT BASKET	PANIER	CESTA FRONTAL
25	1	0457 3064	CONTROL PANEL	TABLEAU DE COMMANDE	PANEL DE CONTROL
26	1	0040 4438	IGNITER	ALLUMEUR	ENCENDEDOR
26b	2	3620 0144	MAIN ELECTRODE WIRES	FILS D'ÉLECTRODE	CABLES DEL ELECTRODO
27	1	3517 0156	VALVE ASSEMBLY	ROBINET	ENSAMBLAJE DE LA VALVULA
32	2	3023 0207	CONTROL KNOBS	BOUTON DE RÉGLAGE	PERILLA DE CONTROL
33	2	3311 0125	BEZELS	ANNEAUX D'ENCADREMENT	TAPAS
42	1	3412 0210 01	BOTTOM GRILL CASTING	COQUILLE INFÉRIEURE	PIEZA INFERIOR MOLDEADA
43	1	1441 0190	BURNER	BRÛLEUR	QUEMADOR
44	1	0125 0170	VENTURI GUARD	PLAQUE COLLECTRICE	PLACA COLECTORA
47a	1	0123 0168	HEAT SHIELD	ÉCRAN THERMIQUE	PROTECCION CONTRA EL CALOR
48	2	0126 0120	GREASE DRIP PANS	COLLECTEUR DE GRAISSE	ENVASE PARA LA RECOGIDA DE GRASA
49	2	0040 4194	GREASE PAN WIRES	ÉTRIER DE COLLECTEUR DE GRAISSE	SOPORTE DE LA LATA DE GRASA
49a	2	3031 0115	DRIP PAN (not shown)	COLLECTEUR DE GRAISSE (non illustré)	BANDEJA PARA RECOGER LA GRASA
55	1	3411 0303 01	GRILL LID	COUVERCLE	TAPA DE LA PARRILLA
56	1	1512 0111	NAMEPLATE	PLAQUE DU FABRICANT	PLACA DE IDENTIFICACION
58	1	1116 0140 05	FRONT HANDLE	POIGNÉE	ASA FRONTAL
60	2	3023 0183	STANDOFFS	ENTRETOISES	SEPARADORES
61	1	0121 0492 73	"1" TENT	PLAQUE "1"	CUBIERTA "1" (2,54 cm)
63	1	0416 0145	COOKING GRID 50/50	GRILLE DE CUISSON 50/50	PARRILLA DE COCCION 50/50
65	1	3811 0114	WARMING RACK	GRILLE GARDE-AU-CHAUD	PARRILLA DE CALENTAMIENTO
66	1	3811 0113	TOP WARMING RACK	GRILLE CHAUFFE-PLATS SUPÉRIEURE	REJILLA DE CALENTAMIENTO SUPERIOR
78	2	3230 0109	CYLINDER RETAINER PINS	ÉTRIER DE BOUTEILLE	PASADOR DE RETENCION DEL TANQUE
79	1	3551 0102	CYLINDER	BOUTEILLE	TANQUE
-	1	1141 2027BX	INSTRUCTION MANUAL	MANUEL D'INSTRUCTIONS	MANUAL DE INSTRUCCION
-	1	1142 0161	USE AND CARE MANUAL	MANUEL D'UTILISATION ET D'ENTRETIEN	MANUAL DE USO Y MANTENIMIENTO

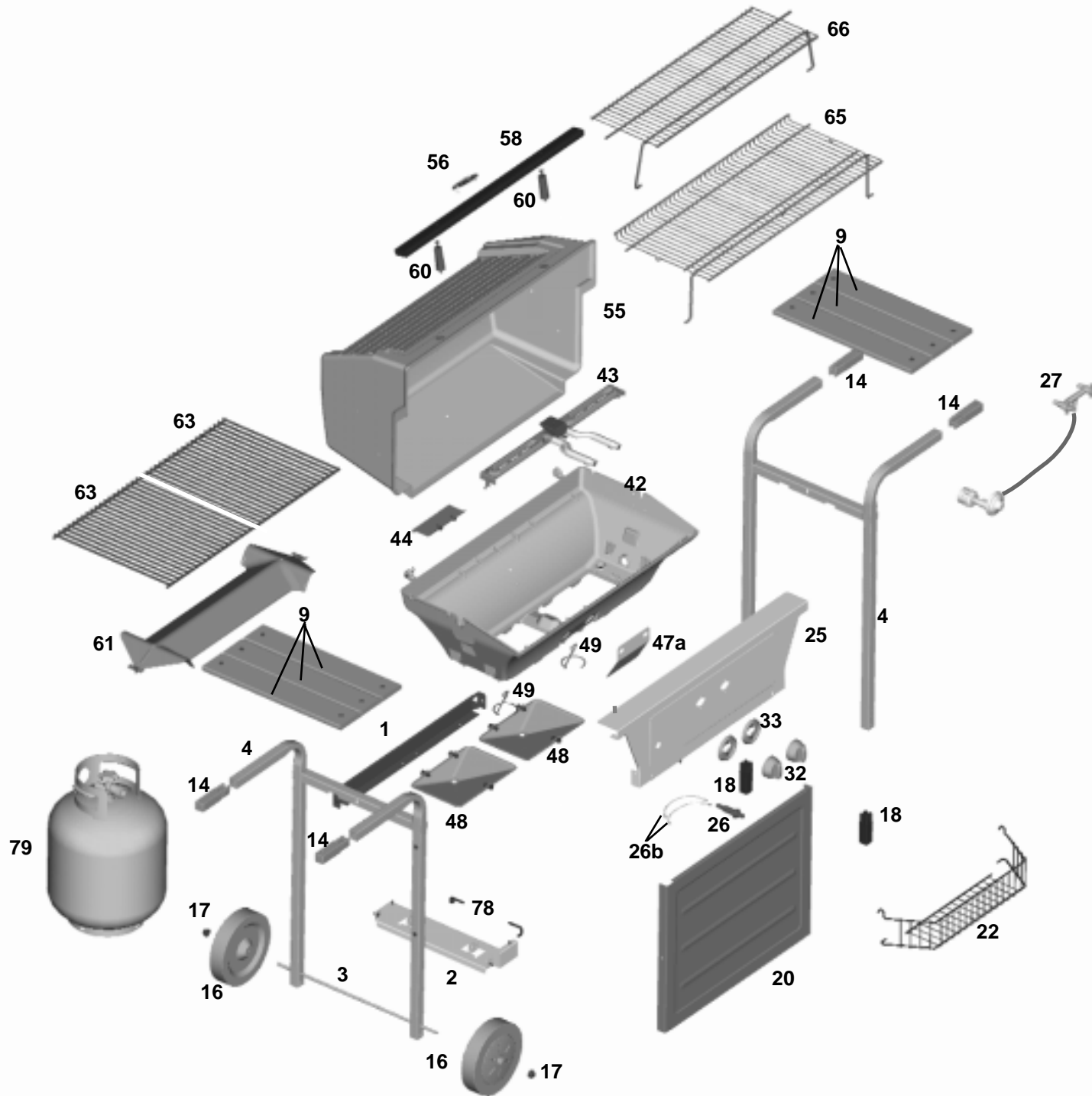

HARDWARE SHOWN ACTUAL SIZE
GRANDEUR RÉELLE DE LA BOULONNERIE
LOS HERRAJES SE MUESTRAN EN SUS TAMAÑOS REALES

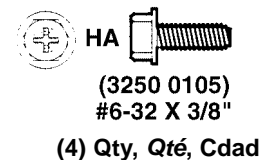
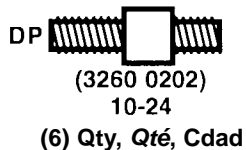
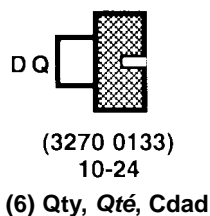
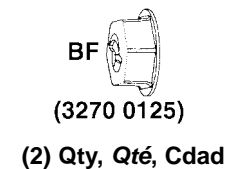
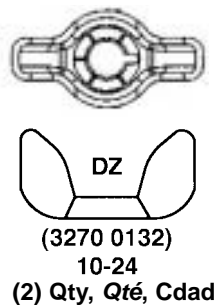
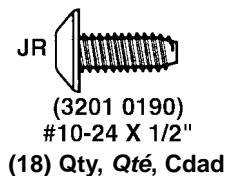
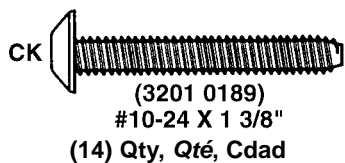
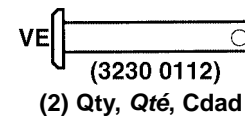
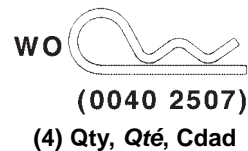
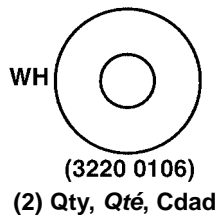
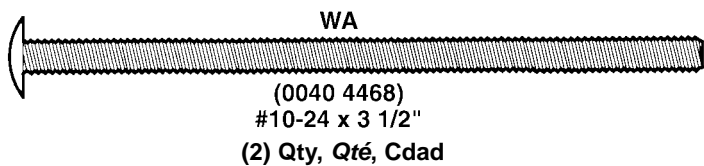

Free Manuals Download Website

<http://myh66.com>

<http://usermanuals.us>

<http://www.somanuals.com>

<http://www.4manuals.cc>

<http://www.manual-lib.com>

<http://www.404manual.com>

<http://www.luxmanual.com>

<http://aubethermostatmanual.com>

Golf course search by state

<http://golfingnear.com>

Email search by domain

<http://emailbydomain.com>

Auto manuals search

<http://auto.somanuals.com>

TV manuals search

<http://tv.somanuals.com>