

Sunbeam

Espresso Vita

15 BAR Pump espresso machine with gauge

Instruction Booklet
EM6200

Please read these instructions carefully
and retain for future reference.



Contents

Sunbeam's Safety Precautions	2
About espresso coffee	3
Features of your Sunbeam Espresso Vita	4
Using the control panel	8
Reference guide to using your espresso machine	12
Programming your espresso machine	17
Preparing your espresso machine before use	19
Guide to the perfect espresso	20
Guide to milk texturing	22
Using the hot water function	23
Espresso Recipes	24
Care and Cleaning	26
Descaling	28
Advanced programming options	30
Trouble shooting guide	34

Important instructions – retain for future use.

تأكد من تفهم احتياطات السلامة المذكورة اعلاه

請務必理解上述的安全預防措施。

Assurez-vous que les précautions ci-dessus relatives à la sécurité sont bien comprises

Versichern Sie sich, dass die obenstehenden Sicherheitsmaßnahmen verstanden werden

Βεβαιώνετε πως οι παραπάνω προφυλάξεις ασφαλείας γίνονται κατανοητές

Pastikan bahwa tindakan-tindakan keselamatan seperti di atas dimengerti anda

Accertatevi che le suddette norme di sicurezza siano comprese a dovere

上記の注意事項をよくお読みになり、安全を御確認ください

Уверете се дека погоре споменатите мерки на претпазливост се добро разбрани

Asegúrese de que las precauciones de seguridad precedentes sean bien comprendidas

کاری بکنید کہ احتیاطهای بالا حتماً درک بشوند

ต้องแน่ใจว่า ข้อควรระวังเรื่องความปลอดภัยข้างต้น เป็นที่เข้าใจกันดี

Yukarda belirtilen güvenlik önlemlerinin anlaşılığundan emin olunuz

Xin kiểm chắc rằng những biện pháp làm an toàn kể trên được hiểu rõ

Sunbeam's Safety Precautions

SAFETY PRECAUTIONS FOR YOUR SUNBEAM ESPRESSO MACHINE.

- Always place the unit on a flat, level surface.
- Do not operate without water in reservoir. Fill reservoir with only clean and cold water. Observe the maximum filling volume is 2.5 litres.
- Do not remove the filter handle during the espresso pour or water flow as the unit is under pressure. Removing the filter handle during either of these operations can lead to a scalding or injury.
- The steam wand becomes very hot during texturing milk and water flow. This may cause burns in case

Sunbeam is very safety conscious when designing and manufacturing consumer products, but it is essential that the product user also exercise care when using an electrical appliance. Listed below are precautions which are essential for the safe use of an electrical appliance:

- Read carefully and save all the instructions provided with an appliance.
- Always turn the power off at the power outlet before you insert or remove a plug. Remove by grasping the plug - do not pull on the cord.
- Turn the power off and remove the plug when the appliance is not in use and before cleaning.
- Do not use your appliance with an extension cord unless this cord has been checked and tested by a qualified technician or service person.
- Always use your appliance from a power outlet of the voltage (A.C. only) marked on the appliance.
- This appliance is not intended for use by persons (including children) with reduced physical, sensory or mental capabilities, or lack of experience and knowledge, unless they have been given supervision or instruction concerning use of the appliance by a person responsible for their safety.
- Children should be supervised to ensure that they do not play with the appliance.
- The temperature of accessible surfaces may be high when the appliance is operating.
- Never leave an appliance unattended while in use.

of contact, therefore avoid any direct contact with the steam wand.

- Always disconnect the plug from the power outlet prior to cleaning the espresso machine or if there is any problem during the coffee making process.
 - Do not allow the power cord to come into contact with the hot parts of the espresso machine, including the cup warming plate and steam wand.
 - Do not place hands directly under the steam, hot water or coffee pour as this can lead to a scalding or injury.
-
- Do not use an appliance for any purpose other than its intended use.
 - Do not place an appliance on or near a hot gas flame, electric element or on a heated oven.
 - Do not place on top of any other appliance.
 - Do not let the power cord of an appliance hang over the edge of a table or bench top or touch any hot surface.
 - Do not operate any electrical appliance with a damaged cord or after the appliance has been damaged in any manner. If damage is suspected, return the appliance to the nearest Sunbeam Appointed Service Centre for examination, repair or adjustment.
 - For additional protection, Sunbeam recommend the use of a residual current device (RCD) with a tripping current not exceeding 30mA in the electrical circuit supplying power to your appliances.
 - Do not immerse the appliance in water or any other liquid unless recommended.
 - Appliances are not intended to be operated by means of an external timer or separate remote control system.
 - This appliance is intended to be used in household and similar applications such as: staff kitchen areas in shops, offices and other working environments; farm houses; by clients in hotels, motels and other residential type environments; bed and breakfast type environments.

If you have any concerns regarding the performance and use of your appliance, please visit www.sunbeam.com.au or contact the Sunbeam Consumer Service Line. Ensure the above safety precautions are understood.

About espresso coffee

Congratulations on the purchase of your Sunbeam espresso machine.

The mastery of coffee making demands a machine that you can trust to perform time and time again. Powered by a one-piece stainless steel lined thermoblock and 15 BAR pump, the espresso machine will deliver the performance a true artist and coffee connoisseur has come to expect.

The Sunbeam Espresso Vita makes producing espresso coffees at home a pleasure with its simple to use push button operation. Seamlessly integrated PID technology monitors and controls the thermoblock heating system to achieve the precise water temperature required for each task, whether you are extracting espresso, texturing milk or brewing tea.

Designed and engineered to last, the components and features of the Sunbeam Espresso Vita are encased in full metal housing, accentuated by a polished chrome brew head. The elegant styling and craftsmanship employed in its design draw inspiration from the tradition of European espresso machine quality and design. Now you can bring the art of coffee making into your home with the Sunbeam Espresso Vita. We hope you enjoy your new espresso machine and should you need any further assistance, please visit the Sunbeam website, www.sunbeam.com.au.

Features of your Sunbeam Espresso Vita

Warming plate

Effectively pre-warms cups

Push button control panel

Easy to use control panel delivers an espresso pour, steam or hot water functions.

Group head

Brass and phenolic group handle

Extra cup height clearance

Additional clearance between the filter handle and the drip tray is designed to suit taller cups.

Water level indicator

The water level indicator floats through the drip tray grid indicating how full the drip tray is. The indicator is coloured red for easy identification.

Measuring spoon / Tamp

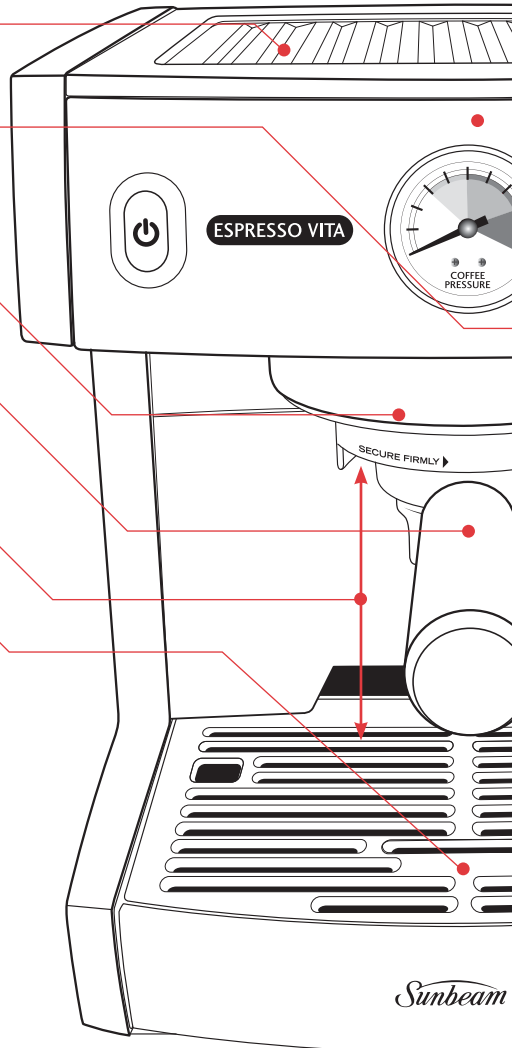
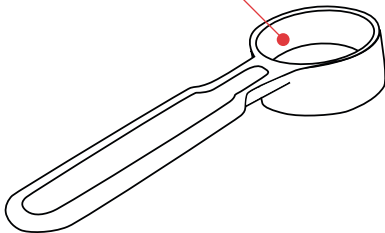

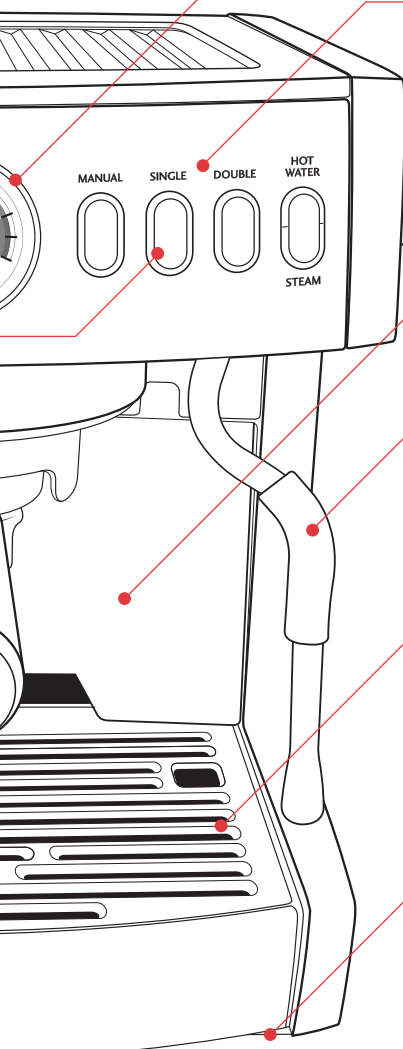

Espresso gauge

The gauge measures the resistance to the espresso pour.

Programmable control panel

For a consistent shot of espresso everytime, simply press either the single or double button.

Steam and hot water control dial

2.5L water reservoir

Removable from the front for easy filling at the tap. Water can also be added at the top of the unit.

Steam and hot water wand

Supplies powerful dry steam for achieving silky, dense and rich milk. Also dispenses a controlled flow of hot water. The commercial 360° ball joint allows the steam wand to be moved into the ideal position.

Removable drip tray and grill

The large capacity die-cast metal drip tray is lined with plastic, preventing staining from espresso oils, lightweight for easy removal and designed with no dirt traps for simple wipe down cleaning.

Non-slip rubber feet

Makes the unit sturdy, preventing it from slipping or scratching the benchtop.

600ml jug

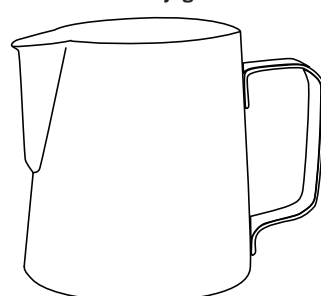

Cleaning tool



Single filter basket

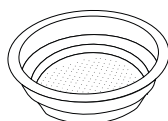

Double filter basket

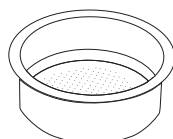

Features of your Sunbeam Espresso Vita

15 Bar Pump



The machine is fitted with a 15 BAR pump which generates the pressure required to deliver a complete extraction of oils, coffee solids and aroma.

Thermoblock Heating System

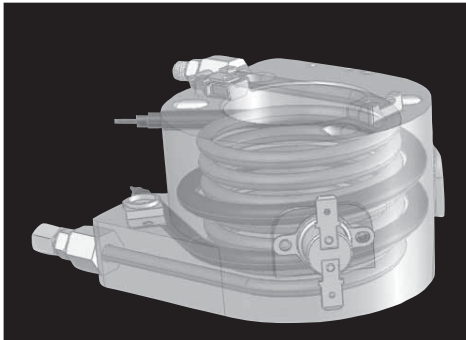

The thermoblock heating system heats the water ensuring the precise temperature is achieved for each function. Additionally, the one-piece construction and stainless steel scale tubing of the thermoblock effectively slows scale build up and reduces the frequency of cleaning required.

Pre-Infusion

Pre-infusion is programmed into the MANUAL, single and double espresso operations. It is a gradual increase of water pressure pre-soaking the coffee cake before full water pressure is applied. This in turn delivers greater body and sweetness to the espresso.

Crema System



The specially designed crema system consists of a dual-floor filter creating additional back pressure and a stabilising baffle that helps retain temperature and produces a steady pour of espresso. The dual-floor filter baskets are designed to slow the flow of liquid espresso creating a subtle aeration to ensure a golden crema.

Features of your Sunbeam Espresso Vita (continued)

Push Button Control Panel



An easy to use control panel provides the choice of manual operation or utilising the programmed espresso pour lengths. The programmed espresso pour is set to 30mls per cup while the PROGRAM function allows users to personalise and save their own espresso volumes. The user is also able to personalise and save their own settings for coffee temperature, steam temperature and steam flow.

Espresso Gauge

The espresso gauge is an indicator of the quality of the espresso pour and should be used as a guide.

It measures the pressure or resistance created by water being pumped through the tamped coffee grinds in the group handle. Whilst the needle is within the target area on the gauge it indicates that a quality serve of espresso has been made. This is indicated by a slow and steady pour of liquid espresso with a consistency similar to that of dripping honey. The crema should be dark golden in colour.

Should the needle fail to reach the target area this is an indication that the serve of espresso is 'under-extracted'. This occurs when water passes too quickly through the tamped coffee grinds and is an indication that either the grind needs to be made finer or the filter basket has been under-dosed. The pour is quick and light in colour and the resulting crema is thin with a creamy light brown colour.

When the needle goes beyond the target area it is an indication that the serve of espresso is 'over-extracted'. This occurs when the water passes very slowly through the tamped coffee grinds and is an indication that either the grind is too fine or the filter basket has been over-dosed. In this situation the hot water is in contact with the coffee grinds for too long thus creating a burnt and bitter tasting espresso. This is characterised by the espresso only slowly dripping during the entire pour and the crema is very dark.

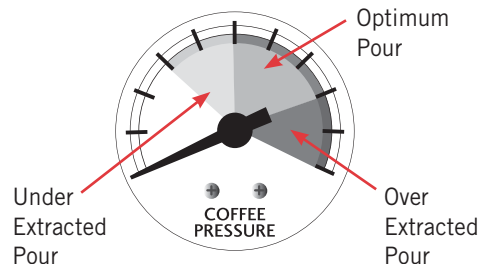

Using the control panel

Power

Press the 'POWER' button once to turn the espresso machine on. The light on the button will start flashing; this is to indicate that your espresso machine is on and is heating up.

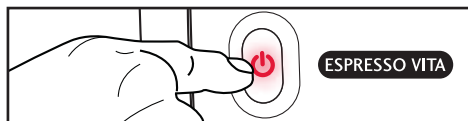

Ready Mode

When the light on the 'POWER' button stops flashing and turns to a constant red light, this indicates that the espresso machine is heated and ready to use. The lights around the 'MANUAL', 'SINGLE', 'DOUBLE' and 'HOT WATER/STEAM' buttons will show a constant red light. The machine is now in Ready Mode.



Note: Remember that if the light on the 'POWER' button is flashing it means the espresso machine is adjusting the temperature of the heating system.

To turn the espresso machine off, simply press the 'POWER' button, the red power light and all other lights on the control panel will turn off.

Manual

Note: Before activating the espresso coffee function ensure that the steam and hot water control dial is in the OFF position.

The 'MANUAL' button allows the coffee maker to have complete control over the length of the espresso pour.

Once the espresso machine is switched on and heated, so the light on the 'POWER' button is red and the lights around the 'MANUAL', 'SINGLE' and 'DOUBLE' espresso buttons show a constant red light, the coffee maker is able to use the manual operation. The coffee maker simply needs to press the 'MANUAL' button once to start the pour and again to stop.

Important: Once the manual operation is activated, before the espresso pour starts the pre-infusion feature will release three short bursts of gradual water pressure onto the coffee cake. After this the full water pressure is applied and the espresso will pour freely.

Note: When the coffee maker has activated the 'MANUAL' operation the lights around the 'SINGLE' and 'DOUBLE' espresso buttons will go off. The lights on the 'POWER' and around the 'MANUAL' buttons will remain on.

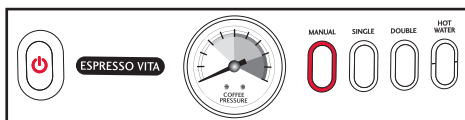

Single Espresso

Note: Before activating the espresso coffee function ensure that the steam and hot water control dial is in the OFF position.

The 'SINGLE' espresso function removes the guesswork and is programmed to pour 30mls of liquid espresso.

Tip: We recommend using the single cup filter when using the programmed 'SINGLE' espresso operation.

Once the espresso machine is switched on and heated, so the light on the 'POWER' button is red and the lights around the 'MANUAL', 'SINGLE' and 'DOUBLE' espresso buttons show a constant red light, the coffee maker is able to use the 'SINGLE' espresso

Using the control panel (continued)

operation. The coffee maker simply needs to press the 'SINGLE' espresso button once to start and the pour of liquid espresso will stop automatically.

Important: Once the 'SINGLE' espresso operation is activated, before the espresso pour starts the pre-infusion feature will release three short bursts of gradually increasing water pressure onto the coffee cake. After this the full water pressure is applied and the espresso will pour freely.

Note: When the coffee maker has activated the 'SINGLE' espresso operation the lights around the 'MANUAL' and 'DOUBLE' espresso buttons will go off. The lights on the 'POWER' and the 'SINGLE' espresso buttons will remain on.



Note: The coffee maker does not need to press the single espresso button again to end the pour as the espresso machine will stop automatically.

Once the pour of liquid espresso stops the espresso machine is ready to make another espresso.

Note: When using the single espresso operation you can stop the pour of espresso at any time by pressing the 'MANUAL', 'SINGLE', or 'DOUBLE' espresso operation buttons.

Double Espresso

Note: Before activating the espresso coffee function, ensure that the STEAM and HOT WATER control dial is in the OFF position. The 'DOUBLE' espresso function removes the guesswork and is programmed to pour 60mls of liquid espresso.

Tip: We recommend using the double cup filter when using the programmed 'DOUBLE' espresso operation.

Once the espresso machine is switched on and heated, so the light on the 'POWER' button is red and the lights around the 'MANUAL', 'SINGLE', and 'DOUBLE' espresso buttons show a constant red light, the coffee maker is able to use the 'DOUBLE' espresso operation. The coffee maker simply needs to press the 'DOUBLE' espresso button once to start and the pour of liquid espresso will stop automatically.

Important: Once the 'DOUBLE' espresso operation is activated, before the espresso pour starts the pre-infusion feature will release three short bursts of gradually increasing water pressure onto the coffee cake. After this the full water pressure is applied and the espresso will pour freely.

Note: When the coffee maker has activated the 'DOUBLE' espresso operation the lights around the 'MANUAL' and 'SINGLE' buttons will go off. The lights on the 'POWER' and 'DOUBLE' espresso buttons will remain on.

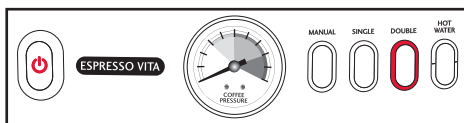

Note: The coffee maker does not need to press the 'DOUBLE' espresso button again to end the pour as the espresso machine will stop automatically.

Once the pour of liquid espresso stops the espresso machine is ready to make another espresso.

Note: When using the 'DOUBLE' espresso operation you can stop the pour of espresso at any time by pressing the 'MANUAL', 'SINGLE' or 'DOUBLE' espresso operation buttons.

Using the control panel (continued)

Programming the Single or Double pours

The program function allows the coffee maker to personalise and save their own espresso pour settings.

To program the 'SINGLE' and 'DOUBLE' coffee pours the espresso machine needs to be in STAND BY MODE (so the machine is plugged in and turned on at the wall, but the power on the machine has not yet been turned on).

To activate the program function for the 'SINGLE' and 'DOUBLE' espresso pours, the coffee maker needs to press and hold down both the 'SINGLE' and 'DOUBLE' buttons. While still holding down these two buttons briefly press the 'POWER' button and release all buttons. When in programming mode the lights around the 'SINGLE' and 'DOUBLE' buttons will slowly flash (dimming up and down).

Depending on which pour you want to program, press either the 'SINGLE' or 'DOUBLE' espresso pour buttons, upon release the pour will begin.

Note: For best results the coffee make should only make changes to the 'SINGLE' and 'DOUBLE' coffee pour volumes by engaging the coffee handle fitted with either the single or double basket, packed with coffee.

When the desired pour amount has been reached press the flashing coffee button to set the new volume. A long beep will sound confirming the program saved and the machine will go into 'READY MODE'.

Note: For more detailed information on programming refer to page 17 'Programming your espresso machine'.

Steam

The steam function allows the coffee maker to produce steam out of the steam wand for texturing milk.

To activate the steam function, the coffee maker simply needs to press the 'STEAM' button. By design the temperature of the espresso machine will adjust as necessary. There may be a short delay while you wait.

Note: When the coffee maker has activated the steam function the light around the 'STEAM' button will show a constant red light and the light behind the 'MANUAL', 'SINGLE' and 'DOUBLE' buttons will go off. Additionally the light on the 'POWER' button will remain on.

Note: If the light behind the 'STEAM' button is flashing it means the espresso machine is adjusting the temperature of the heating system. You will be able to use the steam while it is heating up but this is not advised as the steam will be wetter than if the machine is fully heated up.

Once the espresso machine is heated to the correct temperature, so the light behind the 'STEAM' button stops flashing and shows a constant red light, the coffee maker is able to use the espresso machine.

The coffee maker simply needs to turn the steam and hot water control dial anti-clockwise to the 'MAX' setting to start and turn it back to the 'OFF' position to stop. Press the 'STEAM' button again to deactivate the steam function.

Note: When you have finished steaming, ensure the steam and hot water control dial is fully turned off. If the steam and hot water control dial is left open, the coffee maker will not be able to switch to the 'COFFEE' or 'HOT WATER' functions.

Using the control panel (continued)

Note: After 10 minutes of inactivity in the steam mode, the espresso machine will automatically switch back to the 'READY MODE'.

Hot Water

The hot water function allows the coffee maker to release a controlled flow of hot water for making long blacks, hot chocolates, pre-heating cups and glasses and brewing teas.

To activate the hot water function, the coffee maker simply needs to press the 'HOT WATER' button.

Note: When the coffee maker has activated the hot water function the light around the 'HOT WATER' button will show a constant red light and the light behind the 'MANUAL', 'SINGLE' and 'DOUBLE' buttons will go off. Additionally the light on the 'POWER' button will remain on.

The coffee maker simply needs to turn the steam and hot water control dial anti-clockwise to the 'MAX' setting to start and turn it back to the 'OFF' position to stop.

Press the 'HOT WATER' button again to deactivate the hot water function.

Note: When you have finished using the hot water, ensure the steam and hot water dial is fully turned off. If the steam and hot water dial is left open, the coffee maker will not be able to switch to the 'COFFEE' or 'STEAM' functions.

Reference guide to using your espresso machine

Preparing the espresso machine

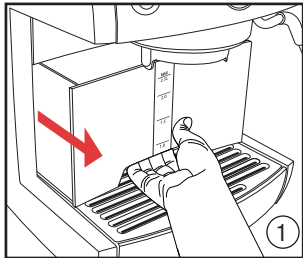

Remove water reservoir from front of unit.

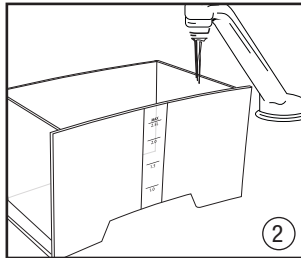

Fill at sink with cold water.

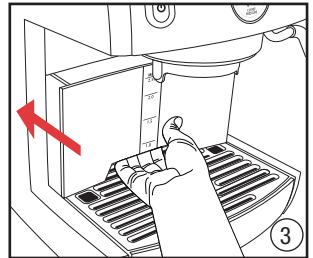

Replace the water reservoir.

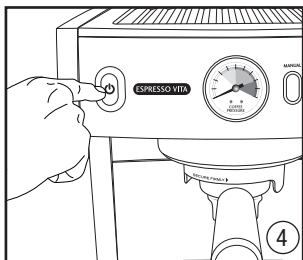

Press 'POWER' button to turn unit on.

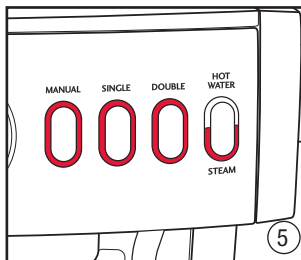

Control panel lit and ready to use. (Ready Mode)

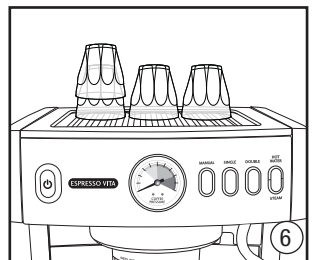

Warming the espresso cups.

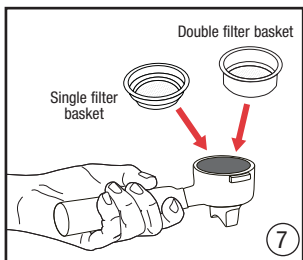

Select appropriate filter and place into group handle.

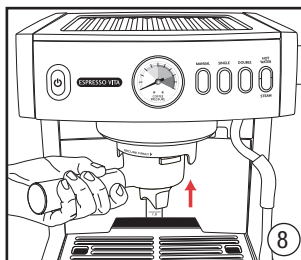

Place group handle onto group head.

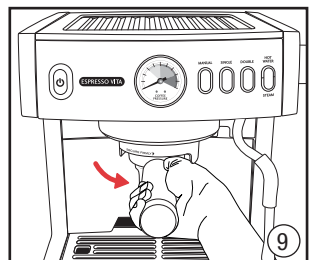

Turn group handle to the right, so it is firmly locked in position.

Reference guide to using your espresso machine (continued)

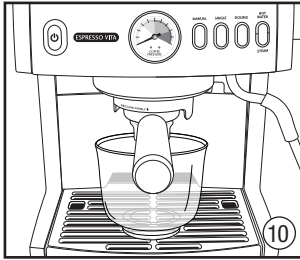

Place large container under both pouring spouts.

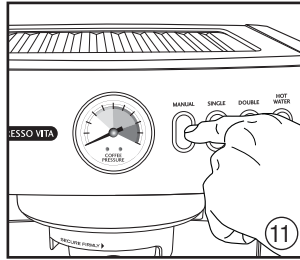

Press the 'MANUAL' button and allow the water to run through. Press button again to stop.

Making the espresso

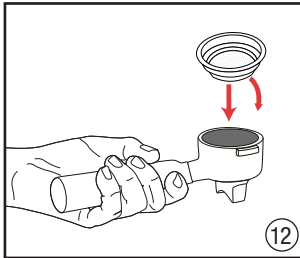

Select appropriate filter and place into group handle.

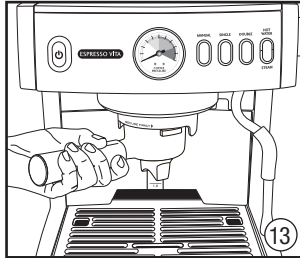

Hold group handle under group head and purge with water to preheat.

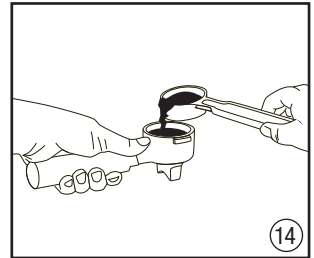

Place finely ground coffee into filter basket.

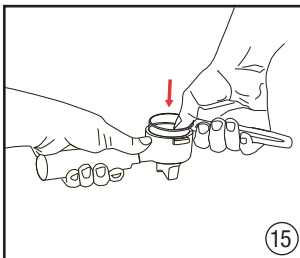

Tamp the coffee grinds. The level of coffee must be 3mm below the filter basket rim.

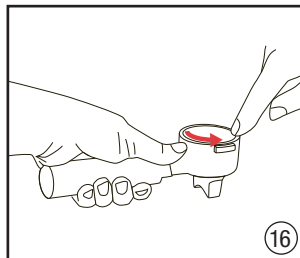

Wipe the edge of filter to remove any coffee grinds.

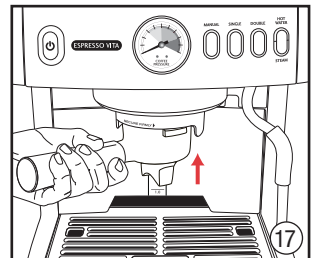

Place group handle onto group head.

Reference guide to using your espresso machine (continued)

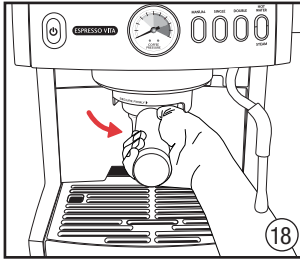

Turn group handle to the right, so it is firmly locked into position.

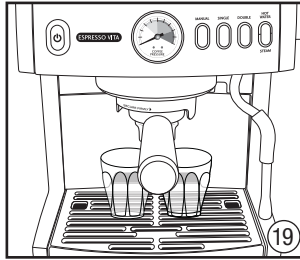

Place glasses/cups below pouring spouts.

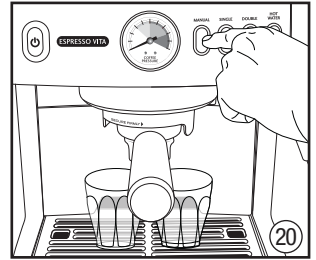

Press the 'MANUAL' button for a continuous pour. Press button again to stop pour.

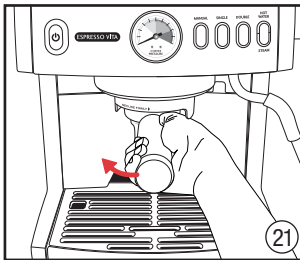

Remove group handle by turning to the left.

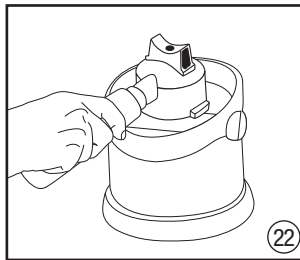

Discard the used coffee grinds.

Texturing milk

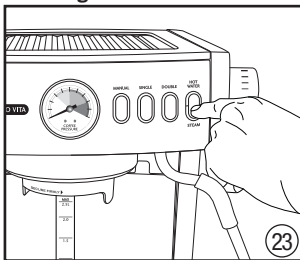

Press the 'STEAM' button to activate steam mode.

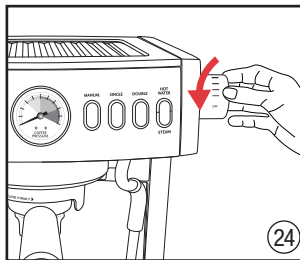

Purge the steam wand by turning dial anti-clockwise.

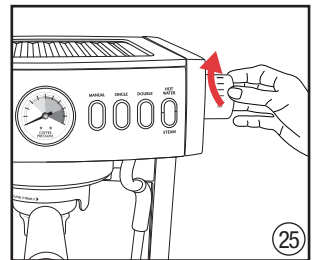

Turn off steam by turning dial clockwise.

Reference guide to using your espresso machine (continued)

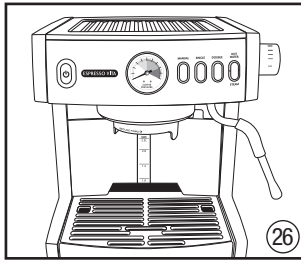

Swing steam wand to the side of espresso machine.

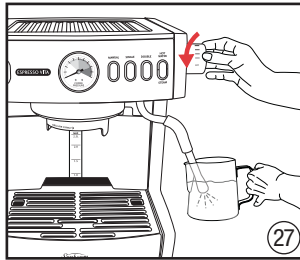

Place steam wand into milk, approx. 1cm below surface and activate the steam function.

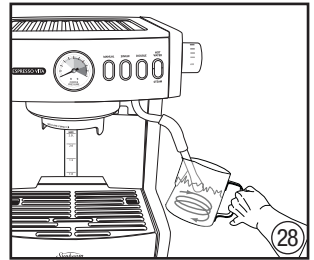

Angle jug to rest steam wand on spout and place nozzle just below surface of the milk.

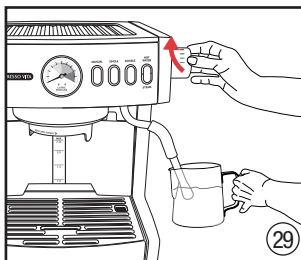

Close the steam by turning dial clockwise.

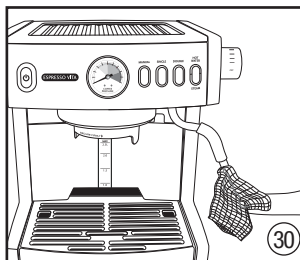

Wipe steam nozzle and wand with damp cloth and purge a small amount of steam.

Hot water

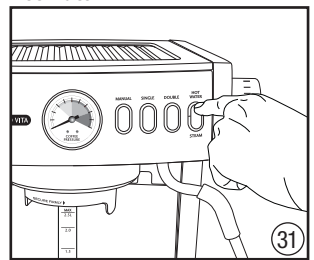

Press the 'HOT WATER' button to activate hot water mode.

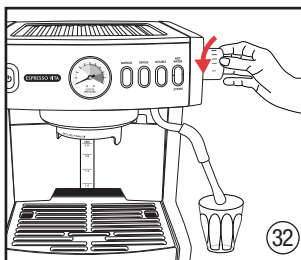

Place cup under hot water nozzle and activate the hot water function by turning dial anti-clockwise.

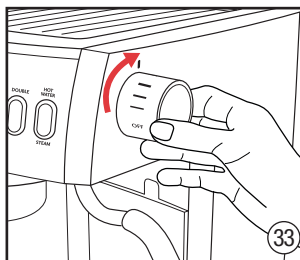

Close the hot water by turning dial clockwise.

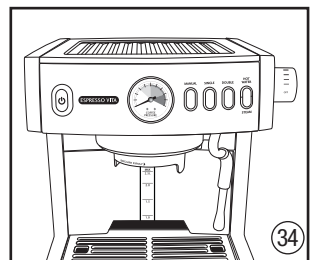

Swing the steam/hot water wand over the drip tray.

Reference guide to using your espresso machine (continued)

Cleaning

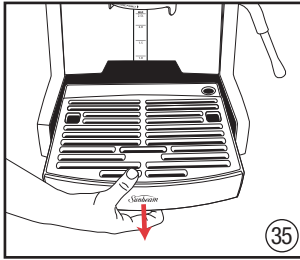

Remove the drip tray.

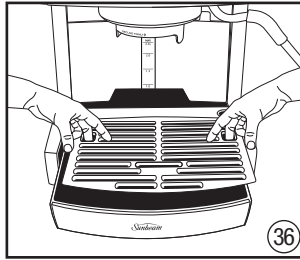

Remove drip tray grill.

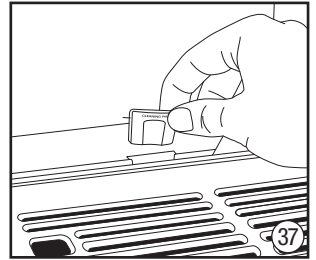

Remove both the water reservoir and drip tray to get to the 'cleaning pin'.

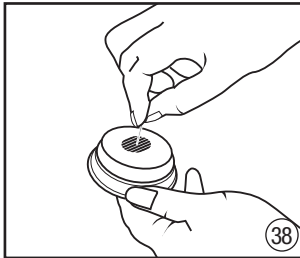

Insert thinner end of cleaning pin into the single hole in the base of the filter.

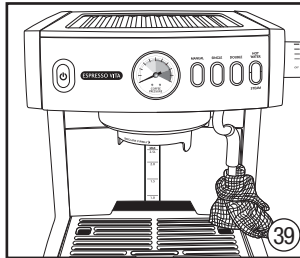

Wrap steam wand with damp cloth and turn steam on for 10 seconds.

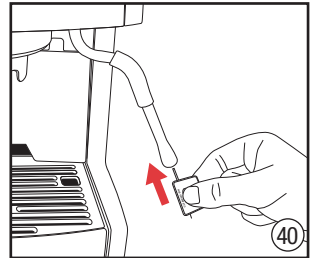

Insert thicker end of cleaning pin into the hole in the base of the steam wand.

Programming your espresso machine

The Espresso Vita has programming capabilities. Based on café settings the 'SINGLE' and 'DOUBLE' espresso functions are set at 30 and 60mls. However by following a few simple steps the coffee maker can personalise the espresso machine to achieve a serve of espresso to exactly how they like it.

Programming Single Espresso

1. To start programming the espresso machine needs to be in 'STAND BY MODE'. So the machine is plugged in and switched on at the power point, but the machine itself is not powered on.
2. Prepare the filter handle. Fit the group handle with the single filter basket (12) and fill with finely ground coffee (14). Using the coffee tamp supplied, tamp the coffee grinds (15). Secure the group handle to the group head (17)(18).
3. Place a cup under both pouring spouts (19).
4. To commence programming press and hold down both the 'SINGLE' and 'DOUBLE' espresso buttons while still holding down these buttons briefly press the 'POWER' button and release all buttons. The lights around the coffee buttons will start to slowly flash, dimming up and down.
5. Press the 'SINGLE' espresso button once to start the espresso pour.
6. Allow the espresso to pour until the desired level. Once the desired level is reached stop the espresso pour by pressing the 'SINGLE' espresso button. A long beep will signify that the new setting for the 'SINGLE' espresso operation has been programmed and stored into the machines memory.
7. The espresso machine will then go into 'READY MODE' and is ready to make espresso at the push of a button.

Programming Double Espresso

1. To start programming the espresso machine needs to be in 'STAND BY MODE'. So the machine is plugged in and switched on at the power point, but the machine itself is not powered on.
2. Prepare the group handle. Fit the group handle with the double filter basket (12) and fill with finely ground coffee (14). Using the coffee tamp supplied, tamp the coffee grinds (15). Secure the group handle to the group head (17)(18).
3. Place two cups under each pouring spout (19).
4. To commence programming press and hold down both the 'SINGLE' and 'DOUBLE' espresso buttons while still holding down these buttons briefly press the 'POWER' button and release all buttons. The lights around the coffee buttons will start to slowly flash, dimming up and down.
5. Press the 'DOUBLE' espresso button once to start the espresso pour.
6. Allow the espresso to pour until the desired level. Once the desired level is reached stop the espresso pour by pressing the 'DOUBLE' espresso button. A long beep will signify that the new setting for the 'DOUBLE' espresso operation has been programmed and stored into the machines memory.
7. The espresso machine will then go into 'READY MODE' and is ready to make espresso at the push of a button.

Resetting the Factory Settings

To revert back to the original factory settings;

1. Insert the power cord into a 230-240V AC power outlet and switch the power 'ON'.

Programming your espresso machine (continued)

Important: Although the espresso machine is on at the power outlet ensure that the actual espresso machine power is 'OFF'. Therefore no lights will be illuminated on the espresso machine control panel.

2. Press and hold down the 'POWER' button.
3. When you hear a single long beep this will indicate that the espresso machine will have returned to the original factory settings.

Preparing your espresso machine before use

1. Place the espresso machine onto a dry, stable benchtop.
 2. Ensure the drip tray and grill are in place.
 3. Fill the espresso machine with water. To do so, ensure the group handle has been taken out of the group head and swing the steam wand to the right, out of the way. Then using the handle at the front of the water reservoir simply slide out the reservoir from the front of the espresso machine (1). Then fill with fresh cold water or filtered water (2). Replace the water reservoir firmly by sliding it back into place (3).
 4. Insert the power cord into a 230-240V AC power outlet and switch the power on. Press the 'POWER' button once to turn the espresso machine on (4). The light on the 'POWER' button will illuminate red and start flashing. This is to indicate that your espresso machine is on and is heating up. When the red light on the 'POWER' button stops flashing and turns to a constant red light, this indicates that the espresso machine is heated and ready to use. The lights around the 'MANUAL', 'SINGLE', 'DOUBLE', 'STEAM' and 'HOT WATER' buttons will also show a constant red light (5). When the control panel is lit in this way, this indicates that the machine is in ready mode.
 5. Place glasses and cups on the warming plate (6).
- Important:** For first time use or if the machine has not been used for some time, it is important that the machine is rinsed as follows:
6. Fit the group handle with either the single or double filter basket (7). Secure the group handle to the group head (8) (9).
 7. Place a sufficiently large container under both pouring spouts (10).
 8. Once the espresso machine is switched on and heated, so the light on the 'POWER' button is red and the lights around the 'MANUAL', 'SINGLE', 'DOUBLE' and 'HOT WATER' buttons show a constant red light, the espresso machine is heated and ready to use.
- Tip:** Remember if the 'POWER' light is flashing red, this indicates that the espresso machine is on and is heating up.
9. Press the 'MANUAL' button (11) and allow the water to run through until the water reservoir is empty.
- Note:** You will need to press the 'MANUAL' button again to stop the water flow. It does not happen automatically.

Guide to the perfect espresso

Preheat Glasses

1. Preheat the glasses/cups by filling them with hot water as this will assist to preserve the crema of the espresso. Set the glasses/cups aside.

Caution: The hot water will be close to boiling temperature. Take care so as not to crack the glasses or burn yourself.

Preheat Group Handle and Filter Basket

2. Select the appropriate filter basket and place it into group handle (12).

Tip: Use the single filter basket for a single serve of espresso and the double filter basket for a double serve of espresso.

3. Take the group handle, hold it under the group head and purge water. With the filter basket positioned under the group head press the 'MANUAL' button to start the water flow and press it again to stop (13).

4. Dry the filter basket.

Dosing and Tamping

5. Using a grinder or the measuring spoon supplied, place the appropriate amount of finely ground coffee into the filter basket (14).

6. Reset the group handle with the filter basket in position onto the benchtop. Take the coffee tamp, apply firm level packing pressure (15), twisting 90 degrees to polish the grounds. This seals the surface of the coffee cake.

7. Brush any excess coffee grounds from around the edge of the filter basket (16).

Important: Be sure to place a sufficient amount of coffee grinds into the filter basket without over dosing it with coffee. Once tamped the level of coffee should be only a few millimetres below the rim of the filter basket. To check this, lock the group handle onto the group head (17)(18).

Then without having made a coffee remove the group handle (21) and inspect the top of the tamped coffee - it should have only a slight indent from the shower screen. Ideally the top of the tamped coffee should be fractionally below the shower screen and then during the espresso pour the coffee cake will expand up and onto the shower screen.

Tip: The coffee dosage and the degree of tamping should remain the same every time you make a coffee. The only thing that should vary is the coarseness of the coffee grounds and this will vary depending on the bean. For example to achieve a slower espresso pour rate use a finer grind and a coarser grind for a faster espresso pour rate.

Note: If purchasing pre-ground coffee or you have someone grind it for you, request/ purchase a very fine grind, the same that would be used for a commercial espresso machine.

Tip: Ensure the coffee tamp is dry because if it is wet the coffee grinds will stick to it.

The Espresso Pour

8. Lock the group handle onto the group head (17)(18).

9. Empty the glasses/cups and place below the pouring spouts (19).

Note: Check to see that the espresso machine is ready for use (see p8 Ready Mode). Remember that if the 'POWER' light is flashing red, this indicates that the espresso machine is on and heating up.

10. Press any of the coffee buttons to start the espresso pour.

Important: Should coffee grinds come out from the top of the group handle this is a sign that the group handle has not been firmly locked into position and/or the level of coffee in the basket is too high.

Guide to the perfect espresso (continued)

Pre-Infusion

11. Once the espresso operation has been activated, before the espresso pour starts, the progressive pre-infusion feature will release three short bursts of gradually increasing water pressure onto the coffee cake. After this, the full water pressure is applied to the coffee cake and the espresso will pour freely.
12. Check the espresso pour. The ideal pour starts out dark and then soon after becomes caramel with reddish reflections. The pour should hang vertically on each spout and flow slowly like dripping honey.

Tip: Once the espresso pour starts to lighten in colour you should cut off the pour.

13. Serve espresso immediately.

Caring for your Espresso Machine

13. Remove the group handle from the group head (21).
14. Discard the used coffee grinds from the filter basket (22).

Tip: After each use of the espresso machine we recommend that a small amount of water is cycled through the group head as this will wash out any old or used coffee grinds stuck to the underside of the group head. Simply press the 'MANUAL' button and allow some water to run through. Press button again to stop. We also recommend that a small amount of water is purged through the steam wand after each use.

Eco Mode and Standby Mode

After 1 hour of non-use in Ready Mode the espresso machine will automatically switch to Eco Mode. An indication that the machine is in Eco Mode is the light on the 'POWER' button will slowly flash red. While in Eco Mode the machine uses reduced power and maintains a lower temperature. While in Eco Mode, the espresso machine functions can easily be reactivated by simply pressing the 'MANUAL', 'SINGLE', 'DOUBLE', 'STEAM' or 'HOT WATER' buttons. The temperature of the espresso machine will then adjust as necessary.

After a further 1 hour of non-use in Eco Mode the espresso machine will automatically switch to Standby Mode. The lights on the control panel will all switch off. To bring the espresso machine out of Standby Mode simply press the 'POWER' button. The machine will then power on and begin heating up.

Guide to milk texturing

Milk texturing is the steaming of milk. The steam does two things, heats the milk and also the steam mixes air with the milk to form an 'emulsion' of tiny bubbles that gives a silky velvet texture. Similar to making an espresso, perfecting the art of milk texturing takes time and practice.

Tip: Remember espresso is the foundation for all espresso-coffee drinks and the milk is the variable.

Before starting to prepare for milk texturing, ensure the espresso machine is in steam mode, so the red light on the 'POWER' button and red light around the 'STEAM' button are illuminated.

Note: Should the espresso machine not be in steam mode, simply press the 'STEAM' button to activate (23).

Tip: It is recommended to use the steam function after first making espresso or using the hot water function. Making coffee in this order will reduce any waiting time or water usage while the machine adjusts to the correct temperature.

1. Determine how much milk is needed based on the number of cups being made or the size of the texturing jug.

Tip: Keep in mind that the volume of milk will increase or 'stretch' during the texturing.

2. Pour cold refrigerated milk into a stainless steel jug, between $\frac{1}{3}$ to $\frac{2}{3}$ full.

Tip: Best results will be achieved by using a clean jug and cold, fresh milk.

3. Purge the steam wand of any water. With the steam wand positioned over the drip tray activate the steam function by turning the steam and hot water control dial anti-clockwise as far as it will go (24). Once any water has been purged close the steam by turning the steam and hot water control dial clockwise (25).

4. Swing the steam wand to the side of the espresso machine (26).

5. Place the steam wand into the milk so that the tip of the steam nozzle is just below the surface of the milk and activate the steam function by turning the steam and hot water control dial anti-clockwise as far as it will go (27).

6. Angle the jug so that the steam wand is resting on the spout of the jug and lower the jug until the tip of the steam nozzle is just below the surface of the milk. The nozzle should sit just off centre in the milk. This will start to create a whirlpool action in the milk (28).

Note: How we introduce the air to the milk will determine the consistency of the foam. If we catch large gulps of air the quality of the foam will reflect this by having large bubbles. If we can introduce air to the milk in a controlled gentle fashion indicated by a gentle hissing sound the milk will have a fine aerated bead in the textured foam.

7. As the steam heats and textures the milk, the level of the milk in the jug will begin to rise. As this happens follow the level of the milk by lowering the jug, always keeping the tip of the steam nozzle just below the surface. This will create a slight hissing noise.

Tip: The amount of foam required will vary depending on the drinks being made, for example a cappuccino requires more foam than a flat white.

8. Close the steam immediately when the milk is heated to between 60-65°C by turning the steam and hot water control dial clockwise (29).

Tip: The optimum drinking temperature of milk is between 60-65°C and we advise you use a milk thermometer to achieve

Guide to milk texturing (continued)

the correct temperature. It's important to remember that if the milk is not heated long enough the drink will be too cool and if heated for too long it will start to boil at around 72°C and all texture will be lost.

Tip: If you don't have a thermometer a good indication that the correct temperature has been reached is when the jug becomes too hot to leave your fingers in contact.

Important: Do not boil the milk as the texture and taste will be affected.

9. Remove the jug, immediately wipe the steam nozzle and wand with a clean damp cloth (30) and purge a small amount of steam.
10. With the jug in hand tap the jug on the bench top to release the trapped air bubbles. Agitate the milk as this helps the milk and froth combine for an even consistency.

Note: After 10 minutes of non-use in steam mode, the espresso machine will automatically return to ready mode.

Using the hot water function

The hot water function is ideal for preheating cups and glasses, brewing teas, preparing long blacks, hot chocolates and filling coffee plungers.

When using the hot water function the espresso machine needs to be in 'HOT WATER' mode, so the red light on the 'POWER' button and the red light around the 'HOT WATER' button are illuminated.

Note: Should the espresso machine not be in hot water mode, simply press the 'HOT WATER' button to activate (31).

1. Swing the steam and hot water wand to the side of the espresso machine.
2. Place the cup or container under the steam/hot water nozzle and activate the hot water function by turning the steam and hot water control dial anti-clockwise as far as it will go (32).

Caution: The water from the hot water nozzle will be close to boiling temperature. Take care as boiling water may scald. Additionally, the wand will be hot and may burn.

3. Once you have dispensed the required amount of hot water into the cup or container, close the hot water by turning the steam/hot water control dial clockwise (33).
4. Remove the cup or container and swing the steam/hot water wand over the drip tray to catch any drips of water (34).

Espresso Recipes

ESPRESSO (SHORT BLACK)

Espresso is a concentrated, full bodied coffee with a stable layer of cream on top – known as ‘crema’. An espresso is the foundation of all café coffee. Variations are achieved by adding different amounts of milk and froth.

- 90mL espresso glass or demitasse cup
- single espresso (30-35mL)



MACCHIATO

Macchiato, Italian for ‘to stain or mark’. Traditionally served as a standard espresso with a dash of milk and a small dollop of froth into the middle of the ‘crema’.

- 90mL espresso glass or demitasse cup
- single or double espresso
- marked with steamed milk froth



LONG BLACK

A standard espresso with hot water, served in a regular coffee cup or mug. The hot water is added first so that the ‘crema’ is maintained.

- 190mL cup
- hot water (to taste)
- single or double espresso



FLAT WHITE

Another old favourite, the Flat White is an espresso with steamed milk, served in a regular coffee cup or mug. The layer of frothed milk on top should be 2mm to seal the coffee.

- 190mL cup
- single or double espresso
- steamed milk



Espresso Recipes (continued)

CAFFE LATTE

An espresso with steamed milk, typically served in a glass. The layer of frothed milk on top should be 10mm to seal the coffee.

- 220mL glass or cup
- single or double espresso
- steamed milk



CAFFE MOCHA

Made in a similar way to a cappuccino but with the addition of drinking chocolate. Simply stir the chocolate into the espresso prior to adding the steamed milk and froth.

- 190-240mL cup or tall glass
- single or double espresso
- two teaspoons of drinking chocolate
- two-thirds milky coffee, one-third froth



CAPPUCCINO

This delicious drink is an espresso with steamed milk, topped with creamy froth and a dusting of chocolate. The resulting drink is approximately two-thirds milky coffee, one-third froth.

- 190-240mL cup
- single or double espresso
- two-thirds milky coffee, one-third froth
- dusted with chocolate



CON PANNA

A variation on the original Vienna coffee, this delicious drink is made up of an espresso topped with lightly whipped cream. It can also be dusted with cinnamon or drinking chocolate.

- 190mL cup
- single or double espresso
- lightly whipped cream
- dusted with cinnamon or chocolate



Care and Cleaning

The coffee making process involves extracting oils out of coffee grinds to make espresso coffee. Deposits of these oils build up over time and affect the taste of the coffee and operation of the espresso machine.

Regular cleaning to remove these oils is essential and will maintain the quality of the coffee the espresso machine produces and result in less maintenance being required. This is easy to do by following a few quick and easy cleaning steps after each coffee making session;

- ☑ Cycle water through the group head,
- ☑ Purge steam through the steam wand,
- ☑ Wipe the steam wand clean with a damp cloth immediately after use,
- ☑ Remove the filter basket from the group handle and clean away any old coffee oils, and
- ☑ Empty the drip tray and rinse.

Important: Never wash any of the espresso machine parts or accessories in the dishwasher.

Drip tray and grill

Remove the drip tray and grill at regular intervals to empty (35) (36). Clean with water and a little non-abrasive washing up liquid, rinse and dry.

Over time it is normal for the inside of the drip tray to be stained by the oils in the coffee.

Group head, group handle & filter baskets

The filter baskets and group handle should be rinsed with warm water after each use and then dried thoroughly.

To clean the group head of any old coffee grinds cycle water through and wipe the group head and around the inside rim with a damp cloth.

Should the holes in the filter baskets become clogged with coffee grinds use a fine bristled brush to remove them. Also you can use the cleaning pin which is supplied with the espresso machine. The cleaning tool is located behind the water reservoir and drip tray (37). The cleaning tool has two pins at either end. One is the thinner and shorter of the two and is for cleaning out the hole in the filter basket. Insert the cleaning pin into the single hole in the base of the filter (38).

Group head rubber seal

The group head seal is located on the underside of the group head and creates a seal against the group handle during the espresso pour.

Note: During long periods of non-use we recommend that the group handle not be left attached to the group head as this will reduce the life of the seal.

Over time the seal will lose its elasticity and require replacement, depending on use usually every 12 months. Signs that the seal is deteriorating are when the group handle cannot create the necessary seal and steam and/or water escapes from around the group head during the espresso pour. Another sign may be when the group handle locks off to the right rather than the front.

Note: Contact Sunbeam on 1300 881 861 should you think that the group head seal needs replacing. Please do not attempt to change the seal without first consulting Sunbeam.

Care and Cleaning (continued)

Cup warming plate and exterior

Wipe over the unit with a damp cloth and wipe dry. Do not use abrasives or metal scourers as these will scratch the exterior surface.

Steam wand

Keeping the steam arm clean is essential to ensure maximum efficiency of the steam function. A build up of caramelised/dried milk on the steam wand will impair the steaming and texturing ability of the espresso machine. The steam nozzle has been specially designed to be perfectly smooth. This will help to reduce build up of dried milk.

Important: Wipe the steam wand clean with a damp cloth immediately after each use and purge a small amount of steam.

Should the milk dry/caramelize on the steam wand, simply wrap the wand with a clean damp cloth, swing the steam wand over the drip tray and turn the steam on for approximately 10 seconds (39). With the cloth still on the steam wand leave to sit for about 5 minutes and you will find that after this time the dry/caramelised milk will easily wipe away. Repeat process if still dirty.

Important: Never clean the steam wand with an abrasive pad as this will damage the steam wand.

Should the steam wand become blocked, supplied with the espresso machine is a cleaning pin. The cleaning tool is located behind the water reservoir and drip tray (37). The cleaning tool has two pins at either end. The thicker, longer pin is for cleaning the steam wand. Insert the cleaning pin into the hole in the base of the steam nozzle (40). Should the steam wand remain blocked unscrew the steam nozzle from the steam wand. Clean the steam nozzle by once again using the cleaning pin then flush under running water.

Descaling

Scale is a surface build up of minerals that naturally occur over time in all appliances that are involved with the heating of water. Therefore the espresso machine will require occasional descaling. It is recommended that the espresso machine is descaled every 4-6 months, this will vary depending on the frequency of use and water hardness.

Descaling solution

Use any of the following when descaling the espresso machine:

- Sunbeam Espresso Machine Descaling Tablets (EM0010)
- Sunbeam Liquid Descaler (KEO100), or
- Vinegar Solution.

Descaling the espresso machine

Note: Ensure the espresso machine is turned off and the power cord is unplugged.

1. Remove the water reservoir and rinse clean.

Depending on the descaling solution being used use one of the following:

A. Sunbeam Espresso Machine Descaling Tablets

Fill the water reservoir with 1 litre of warm water and place a descaling tablet into the reservoir. Once the tablet has dissolved replace the reservoir, this takes about 5-7 minutes.

B. Sunbeam Liquid Descaler

Fill the water reservoir with approximately 1.5 litres of water, add 1 capful of Sunbeam Liquid Descaler and replace the reservoir.

C. Vinegar solution

Fill the water reservoir with approximately 1.5 litres of warm water, add 3 tablespoons of vinegar and replace the reservoir.

2. Should the group handle be attached to the group head remove it, rinse thoroughly under running water and set aside.
3. Using a screwdriver unscrew the brewing filter/shower screen from the underside of the group head.

4. Remove and set aside the filter/screen, washer and screw in a safe place.

Important: Be careful not to lose the filter/screen, washer and screw once you have disassembled the group head.

5. Using a small brush scrub in and around the area at the brewing head, removing all coffee grinds.

6. Place a sufficiently large container under the group head.

7. Insert the power cord into a 230-240V AC power outlet and switch the power 'ON'. Press the 'POWER' button once to turn the espresso machine on.

Note: Check to see that the espresso machine is ready for use (see p8 Ready Mode).

Remember if the 'POWER' light is flashing red this indicates that the espresso machine is on and is heating up.

8. Press the 'MANUAL' button and allow half the solution to cycle through the group head and then once again press the 'MANUAL' button to stop the flow.

Important: Do not run descaling solution through the steam wand.

Note: Depending on the size of the container under the group head on occasion this may need to be emptied throughout this process.

9. After half the solution has cycled through press the 'MANUAL' button to stop the flow and then press the 'POWER' button to turn the machine off.

Descaling (continued)

10. Leave the machine off for 10-15 minutes to allow the descaling solution to take affect.
11. Press the 'POWER' button once to turn the espresso machine on.
12. Press the 'MANUAL' button and allow the remaining solution to cycle through the group head. Press button again to stop.
13. Remove the water reservoir from the machine and rinse thoroughly under running water, ensuring that all traces of the descaling solution are removed. Fill with clean water and replace the reservoir.
14. Press the 'MANUAL' button and allow the entire water reservoir to cycle through the group head. Press button again to stop.
Note: Depending on the size of the container under the group head on occasion this may need to be emptied throughout this process.
15. When this is finished remove the container under the group head and give the machine a good wipe over.
16. Carefully replace the rubber seal, brewing filter/shower screen and washer to the group head.
Important: Ensure the screw is tightened well.
17. Fill the water reservoir with fresh water and position it in to the machine.

Advanced programming options

Espresso Thermoblock Temperature

The water temperature of this espresso machine has been calibrated to the precise temperature of 92°C at the group head. The temperature of the water at the group head can be modified in increments of 2°C up and down should it be desired.

To do this you need to follow the instructions below:

1. Insert the power cord into a 230-240V AC power outlet and switch the power 'ON'.

Note: Although the espresso machine is ON at the power outlet ensure that the actual espresso machine power is 'OFF'. Therefore no lights will be illuminated on the espresso machine control panel.

2. Press and hold down the 'MANUAL' button.

3. While still holding down the 'MANUAL' button briefly press the 'POWER' button and release all buttons.

Note: A series of beeps will indicate the current setting.

Note: The 'MANUAL' button LED will light up as will the 'SINGLE' and 'DOUBLE' buttons.

Note: The sequence of beeps will indicate the current setting.

4. Press the 'SINGLE' button to decrease the Espresso temperature setting or press the 'DOUBLE' button to increase the espresso temperature setting. Please refer to the chart below.

Espresso Temperature Programming	
Setting	Beep Sequence
+3	3 Short Beeps
+2	2 Short Beeps
+1	1 Short Beep
0 (Factory Setting)	1 Short Beep and 1 Long Beep
-1	1 Long Beep
-2	2 Long Beeps
-3	3 Long Beeps

5. Once you have selected the desired temperature, press and hold the 'MANUAL' button to save the new setting. A single long beep will sound to indicate the new setting has been saved. The espresso machine will then turn on to 'READY MODE'.

Remember: If you do not press the 'MANUAL' button within 30 seconds the program will return to the Factory Setting and the espresso machine will then power on and begin heating up.

Advanced programming options (continued)

Steam Thermoblock Temperature

The steam temperature of this espresso machine has been calibrated to deliver a powerful and dry steam for texturing milk. The temperature of the steam can be modified in increments of 2°C up and down should it be desired.

To do this you need to follow the instructions below:

1. Insert the power cord into a 230-240V AC power outlet and switch the power 'ON'.

Note: Although the espresso machine is ON at the power outlet ensure that the actual espresso machine power is 'OFF'. Therefore no lights will be illuminated on the espresso machine control panel.

2. Press and hold down the 'HOT WATER/ STEAM' button.

3. While still holding down the 'HOT WATER/ STEAM' button briefly press the 'POWER' button and release all buttons.

Note: This activates the programmability of the Steam Thermoblock Temperature and to signal this a series of beeps will follow and the 'HOT WATER/STEAM' button LED will light up. Additionally the 'SINGLE' and 'DOUBLE' button LEDs will start to flash.

Note: A series of beeps will indicate the current setting.

4. Press the 'SINGLE' button to decrease the steam temperature or to increase the steam temperature press the 'DOUBLE' button. Please refer to the chart below.

Steam Temperature Programming	
Setting	Beep Sequence
+3 (Factory Setting)	3 Short Beeps
+2	2 Short Beeps
+1	1 Short Beep
0	1 Short Beep and 1 Long Beep
-1	1 Long Beep
-2	2 Long Beeps
-3	3 Long Beeps

5. Once you have selected the desired temperature, press and hold the 'HOT WATER/STEAM' button to save the new setting. A single long beep will sound to indicate the new setting has been saved. The espresso machine will then turn on to 'READY MODE'.

Remember: If you do not press the 'HOT WATER/STEAM' button within 30 seconds the program will return to the Factory Setting and the espresso machine will then power on and begin heating up.

Advanced programming options (continued)

Steam Wetness or Steam Pump Rate

The steam pump rate of this espresso machine has been preset. Modifying the steam pump rate enables you to make the steam wetter or dryer and aids in the delivery of a powerful, dry steam - ideal for texturing milk. The steam pump rate can be modified in flow rate increments up or down should it be desired.

To do this you need to follow the instructions below:

1. Insert the power cord into a 230-240V AC power outlet and switch the power 'ON'.

Note: Although the espresso machine is ON at the power outlet ensure that the actual espresso machine power is 'OFF'. Therefore no lights will be illuminated on the espresso machine control panel.

2. Press and hold down both the 'MANUAL' and 'HOT WATER/STEAM' buttons.

3. While still holding down the 'MANUAL' and 'HOT WATER/STEAM' buttons briefly press the 'POWER' button and release all buttons.

Note: This activates the programmability of the Steam Pump Rate and to signal this a series of beeps will follow and the 'MANUAL' and 'HOT WATER/STEAM' button LEDs will light up. Additionally the 'SINGLE' and 'DOUBLE' button LEDs will start to flash.

Note: A series of beeps will indicate the current setting.

4. Press the 'SINGLE' button to decrease to decrease the steam pump rate or to increase the steam rate press the 'DOUBLE' button. Please refer to the chart below.

Steam Pump Rate Programming	
Setting	Beep Sequence
+3 (Factory Setting)	3 Short Beeps
+2	2 Short Beeps
+1	1 Short Beep
0	1 Short Beep and 1 Long Beep
-1	1 Long Beep
-2	2 Long Beeps
-3	3 Long Beeps

5. Once you have selected the desired steam pump rate, press and hold both the 'MANUAL' and 'HOT WATER/STEAM' buttons to save the new setting. A single long beep will sound to indicate the setting has been saved. The espresso machine will then turn on to 'READY MODE'.

Remember: If you do not press the 'MANUAL' and 'HOT WATER/STEAM' buttons within 30 seconds the program will return to the Factory Setting and the espresso machine will then power on and begin heating up.

Advanced Programming Options (continued)

Factory Reset

To undo any changes made to the program you can revert back to the original factory settings.

To do this you need to follow the instructions below:

1. Insert the power cord into a 230-240V AC power outlet and switch the power 'ON'.

Note: Although the espresso machine is ON at the power outlet ensure that the actual espresso machine power is 'OFF'. Therefore no lights will be illuminated on the espresso machine control panel.

2. Press and hold down the 'POWER' button.

A single long beep will indicate a successful reset. The espresso machine will then turn on to 'READY MODE'

Note: This resets ALL the program settings back to factory settings, including the program espresso pour volumes, espresso & steam thermoblock temperatures and the steam pump rate.

Trouble shooting guide

PROBLEM	POSSIBLE CAUSE	WHAT TO DO
Coffee runs down the side of the group handle.	Group handle is not attached correctly, or has not been tightened sufficiently.	Ensure the handle is firmly positioned on to the group head. See "Guide to the perfect espresso" pg 20.
	Edge of filter basket is not free of coffee grinds.	Clean around the top edge of the filter and wipe the group head clean of coffee.
	The group head is dirty.	Wipe group head with a damp cloth.
	The group head is defective.	Contact a Sunbeam Service Centre.
	Group head rubber seal is damaged, or worn.	Contact a Sunbeam Service Centre.
No coffee runs through.	No water in the water reservoir.	Fill reservoir with water.
	Water reservoir not correctly positioned.	Push water reservoir all the way to the back of the unit to ensure it is correctly positioned.
	Steam and hot water control dial left open.	Ensure the steam and hot water control dial is in the off position.
	Group filter may be blocked. The filter is blocked, the coffee grounds are too fine or tamped down too hard.	See "Descaling" pg 28. Empty out the filter and rinse under water to clean. Wipe the group head with a cloth. Repack the filter and do not tamp the grounds so firmly.
Coffee pours out in drops.	Coffee grind is too fine or too compacted.	Ensure you are using an evenly ground coffee and do not compact the grounds so firmly.
	Machine blocked by scale build up.	See "Descaling" pg 28.
Espresso does not have any crema.	Coffee is old or dry.	Use fresh coffee and once you open the coffee be sure to store it in an airtight container.
	Coffee not compacted firmly enough.	Compact coffee grounds more firmly.
	Coffee too coarse.	Grind the coffee to a finer texture or change brands of espresso coffee to a finer grind.

Trouble shooting guide (continued)

Espresso does not have any crema.	Not enough coffee in filter.	See "Guide to the perfect espresso" pg20.
Handle comes off during group.	Coffee tamped too hard.	Tamp the coffee grounds lighter.
	Coffee grind is too fine.	Change to a coarser grind of coffee.
	Filter handle is not attached correctly, or has not been tightened sufficiently.	Ensure the handle is firmly positioned onto the group head. See "Guide to the perfect espresso" pg20.
	Top edge of filter is not free of coffee grinds.	Clean around the edge of the filter and wipe the group head clean of coffee.
	The group head is dirty.	Wipe group head with a damp cloth.
	The group head is defective.	Contact a Sunbeam Service Centre.
	Group head rubber seal is worn or damaged.	Contact a Sunbeam Service Centre.
Coffee is too cold.	Cups, filter basket and group handle are cold.	Pre-heat cups, filters and group handle. See "Guide to the perfect espresso" pg 20.
	If making a cappuccino or latte the milk may not be heated enough.	Ensure that milk is heated properly during texturing, but be sure not to boil the milk. See "Guide to milk texturing" pg 22.
No steam from the steam nozzle.	Steam nozzle is blocked.	See "Care & Cleaning" pg 26.
	'STEAM' mode is not selected.	Press the 'STEAM' button so it is illuminated.
Not enough froth when frothing	Milk is not fresh.	Ensure the milk is fresh.
	Milk temperature is too warm to begin with.	Ensure that the milk is well refrigerated before use.
	Jug	For best texturing results use a stainless steel jug and if possible refrigerate or run the jug under cold water before use.
	Steam nozzle is blocked.	See "Care & Cleaning" pg 26.
	Milk has been boiled.	Start again with fresh, chilled milk.
	Steam nozzle not in correct position.	Position steam nozzle just below the surface of the milk.

Trouble shooting guide (continued)

Uneven cup filling.	Uneven tamping or obstruction in the pouring spouts.	Ensure coffee is tamped evenly and check that there is nothing obstructing the pouring spouts.
	Defective baffle in filter handle.	Contact a Sunbeam Service Centre.
	Bench surface is uneven	Reposition the machine on a level, even surface.
Espresso tastes burnt.	Type of coffee being used.	Experiment with different brands of coffee.
	Appliance has not been rinsed after descaling.	Run a reservoir full of water properly through the machine before making another coffee.
	Coffee pour is too slow as a result of fine grind.	Increase the coarseness of your coffee grind.
Pump makes an unusually load noise.	No water in reservoir.	Fill the water reservoir.
	Water reservoir not correctly positioned.	Replace the water reservoir firmly into the unit.
Machine does not operate.	Group head filter may be blocked.	Remove group handle and clean group head. See "Care & Cleaning" pg 26.
	Machine blocked by scale build up.	See "Descaling " pg 28.

Please contact Sunbeam directly on 1300 881 861, if this guide does not solve your query. We have experienced staff on hand to assist, Monday to Friday.

12 Month Replacement Guarantee

In the unlikely event that this appliance develops any malfunction within 12 months of purchase (3 months commercial use) due to faulty materials or manufacture, we will replace it for you free of charge.

Should you experience any difficulties with your appliance, please phone our customer service line for advice on 1300 881 861 in Australia, or 0800 786 232 in New Zealand. Alternatively, you can send a written claim to Sunbeam at the address listed below. On receipt of your claim, Sunbeam will seek to resolve your difficulties or, if the appliance is defective, advise you on how to obtain a replacement or refund.

Your Sunbeam 12 Month Replacement Guarantee naturally does not cover misuse or negligent handling and normal wear and tear.

Similarly your 12 Month Replacement Guarantee does not cover freight or any other costs incurred in making a claim. Please retain your receipt as proof of purchase.

The benefits given to you by this guarantee are in addition to your other rights and remedies under any laws which relate to the appliance.

Our goods come with guarantees that cannot be excluded under the Australian Consumer Law and under the New Zealand Consumer Guarantees Act.

In Australia you are entitled to a replacement or refund for a major failure and for compensation for any other reasonably foreseeable loss or damage. You are also entitled to have the goods repaired or replaced if the goods fail to be of acceptable quality and the failure does not amount to a major failure.

Should your appliance require repair or service after the guarantee period, contact your nearest Sunbeam service centre.

For a complete list of Sunbeam's authorised service centres visit our website or call:

Australia

www.sunbeam.com.au

1300 881 861

Units 5 & 6, 13 Lord Street
Botany NSW 2019 Australia

New Zealand

www.sunbeam.co.nz

0800 786 232

26 Vestey Drive, Mt Wellington
Auckland, New Zealand

Need help with your appliance?

Contact our customer service team or visit our website for information and tips on getting the most from your appliance.

In Australia

Visit www.sunbeam.com.au

Or call 1300 881 861

In New Zealand

Visit www.sunbeam.co.nz

Or call 0800 786 232

 is a registered trademark.

Made in China.

Due to minor changes in design or otherwise, the product may differ from the one shown in this leaflet.

© Copyright. Sunbeam Corporation Limited 2012.

ABN 45 000 006 771

Units 5 & 6, 13 Lord Street
Botany NSW 2019 Australia

Unit 3, Building D
26 Vestey Drive
Mt Wellington Auckland
New Zealand

Sunbeam Corporation is a division of GUD Holdings Ltd.

Free Manuals Download Website

<http://myh66.com>

<http://usermanuals.us>

<http://www.somanuals.com>

<http://www.4manuals.cc>

<http://www.manual-lib.com>

<http://www.404manual.com>

<http://www.luxmanual.com>

<http://aubethermostatmanual.com>

Golf course search by state

<http://golfingnear.com>

Email search by domain

<http://emailbydomain.com>

Auto manuals search

<http://auto.somanuals.com>

TV manuals search

<http://tv.somanuals.com>