

Users Guide & Installation Handbook



Stoves
Freestanding Fanned Gas Uk

Part No 083306003 Date 02/12/2014

CONTENTS & INTRODUCTION

CONTENTS

- SAFETY
- USING THE PRODUCT
- CLEANING
- INSTALLATION INSTRUCTIONS
- TECHNICAL DATA
- CUSTOMER CARE

INTRODUCTION

Thank you for buying this British-built appliance from us.

This guide book is designed to help you through each step of owning your new cooker, from installation to use. Please read it carefully before you start using your product, as we have endeavored to answer as many questions as possible, and provide you with as much support as we can.

If, however, you should find something missing, or not covered, please contact our Customer Care team. Their number is located on the back page of this book.

For customers outside the UK and Northern Ireland, please contact your local supplier.

When you dial this number you will hear a recorded message and be given a number of options. This indicates that your call has been accepted and is being held in a queue. Calls are answered in strict rotation as our Customer Care representatives become available.

Alternatively, general information, spares and service information is available from our website. The address is located on the back page of this book.

WARRANTY

Your new appliance comes with our 12-month guarantee, protecting you against electrical and mechanical breakdown. To register your appliance please call **0844 481 0182**, complete the registration form included or register online at the web address located on the back page of this book.

For full terms & conditions of the manufacturer's guarantee, refer to the website on the back of this book.

In addition, you may wish to purchase an extended warranty. A leaflet explaining how to do this is included with your appliance.

European Directives

As a producer and a supplier of cooking appliances we are committed to the protection of the environment and are in the compliance with the WEEE directive. All our electric products are labelled accordingly with the crossed out wheeled bin symbol. This indicates, for disposal purposes at end of life, that these products must be taken to a recognised collection points, such as local authority sites/local recycling centres.

This appliance Complies with European Community Directives (CE) for household and similar electrical appliances and Gas appliances where applicable.

This appliance conforms to European Directive 2009/125/EC regarding Eco design requirements for energy-related products.

CONTENTS & INTRODUCTION

Our policy is one of constant development and improvement, therefore we cannot guarantee the strict accuracy of all of our illustrations and specifications - changes may have been made subsequent to publishing.

GAS WARNING

If you smell gas:

Do not try to light any appliance.

Do not touch any electrical switch.

**Call the Gas Emergency Helpline at
0800 111999**

SAFETY

BEFORE USING THE PRODUCT

Make sure that you have removed all packaging and wrapping. Some of the items inside this appliance may have additional wrapping.

It is advised that you turn the ovens and/or grill on for a short while. This will burn off any residues left from manufacturing. There may be a smell which accompanies this process - but this is nothing to worry about and is harmless.

It is recommended that you wash the oven shelves, baking tray, grill pan and grill pan trivet before their first use in hot soapy water. This will remove the protective oil coating.

GENERAL

WARNING! - The appliance and its accessible parts become hot during use. Care should be taken to avoid touching heating elements. Children less than 8 years of age shall be kept away unless continuously supervised. This appliance can be used by children aged from 8 years and above and persons with reduced physical sensory or mental capabilities or lack of experience and knowledge if they have

been given supervision or instruction concerning the use of the appliance in a safe way and understand the hazards involved. Children shall not play with the appliance. Cleaning and user maintenance shall not be made by children without supervision.

WARNING! -

Unattended cooking on a hob with fat or oil can be dangerous and may result in fire.

NEVER try to extinguish a fire with water, but switch off the appliance and then cover the flame with a lid or damp cloth.

WARNING! - Danger of fire: Do not store items on the cooking surfaces.

WARNING! - Servicing should be carried out only by authorised personnel.

SAFETY

WARNING! - The appliance must never be disconnected from the mains supply during use, as this will seriously affect the safety and performance, particularly in relation to surface temperatures becoming hot and gas operated parts not working efficiently. The cooling fan (if fitted) is designed to run on after the control knob has been switched off.

WARNING! -

Do not spray aerosols in the vicinity of this appliance while it is in operation.

WARNING! - Do not store or use flammable liquids or items in the vicinity of this appliance.

WARNING! -

Do not modify this appliance.

WARNING! - Do not use harsh abrasive cleaners or sharp metal scrapers to clean the oven door glass since they can scratch the surface, which may result in shattering of the glass.

WARNING! - Do not operate the appliance without the glass panel correctly fitted.

WARNING! - There is a risk of electric shock, so always make sure you have turned off and unplugged your appliance before starting. Always allow the product to cool down before you change a bulb.

WARNING! - Accessible parts may become hot when the grill is in use. children should be kept away.

SAFETY

WARNING! - Never place food, or dishes on the base of the main oven, the element is here and it will cause over heating.

WARNING! - Do not modify the outer panels of this appliance in any way.

WARNING! - This appliance must be earthed.

WARNING! - The top element gets extremely hot when in use, so take care to avoid touching it.

GAS WARNING! -

If you smell gas:

Do not try to light any appliance.

Do not touch any electrical switch.

Contact your local gas supplier immediately.

Caution: This appliance is for cooking purposes

only. It must not be used for other purposes, for example room heating.

WARNING! - The use of inappropriate hob guards can cause accidents.

OVEN / GRILL

Do

- Always take care when removing food from the oven as the area around the cavity may be hot.
- Always use oven gloves when handling any utensils that have been in the oven as they will be hot.
- Always make sure that the oven shelves are resting in the correct position between two runners. Do not place the oven shelves on top of the highest runner, as this is not stable and can lead to spillage or injury.
- Always use the Minute Minder (if fitted) if you are leaving the oven unattended - this reduces the risk of food burning.

Do Not

- Never place items on the door while it is open.
- Never wrap foil around the oven shelves or allow foil to block the flue.
- Never drape tea towels near the oven while it is on; this will cause a fire hazard.
- Never pull heavy items, such as turkeys or large joints of meat, out from the oven on the shelf, as they may overbalance and fall.
- Never use this appliance to heat anything other than food items and do

SAFETY

not use it for heating the room.

GAS HOB

Do

- Always ensure that pan bases are dry and flat before using them on the hob.
- Always position pans over the centre of the heat zone, and turn the handles to a safe position so they cannot be knocked or grabbed.
- Always use pans which are no smaller than 100 mm (4"), or larger than 250 mm (10") in diameter.
- Limit the maximum flat based pan diameter to 230 mm (9") above the wok burner, if two or more other hotplate burners are in use at the same time.
- Always match the size of pan to the heat zone – do not use large pans on small zones or vice versa.
- Always make sure that the burner caps, rings and pan supports are correctly placed. This will prevent pans becoming unstable while in use and ensure an uninterrupted gas flow.

Important

Ensure the wok burner skirt is positioned with the feature shown in the diagram below facing the front of the cooker. Failure to do this will cause the gas to burn incorrectly with an irregular flame pattern.

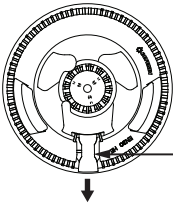

ENSURE WOK BURNER SKIRT IS POSITIONED WITH FEATURE FACING THE FRONT OF THE COOKER.

Do Not

- Never use double pans, rim-based

pans, old or misshapen pans, or any pan that is not stable on a flat surface, including round bottomed woks, directly on top of the pan supports

- Never leave cooking fat, or oil, unattended.
- Never use commercial simmering aids, or heat diffusers, as they create excessive heat and can damage the surface of the hob.
- Never use the hob for any other purpose than cooking food or raising the temperature of fluids.
- Plastic cooking utensils can melt if they come into contact with a warm hob. Never leave them close to, or on top of the hob.
- Never leave any heat zone alight without a pan covering it. This causes a fire hazard.
- Never leave an empty pan on a heating zone.
- Never leave anything lying on the hob.
- Never heat a sealed tin of food, as it might explode.
- Never use the hob surface for storage.

Fire Safety Advice

Most kitchen fires occur when people are distracted or leave things unattended. Don't let yourself be distracted while cooking. If you're called away from the cooker, either take pans off the heat, or switch off your hob.

If you do have a fire in the kitchen, don't take any risks - get everyone out of your home and call the Fire Brigade.

If a pan catches fire:

- Do not move it. It is likely to be

SAFETY

extremely hot.

- Turn off the heat if it is safe to do so but never lean over a pan to reach the controls.

If you have a fire blanket, put it over the pan. If you have put the fire out, leave the pan to cool completely.

Deep-fat frying presents more dangers in your kitchen.

- Never fill a chip pan (or other deep-fat fryer) more than one-third full of oil.
- Do not use a fire extinguisher on a pan of oil, the force of the extinguisher can spread the fire and create a fireball.

If you have an electrical fire in the kitchen:

- Pull the plug out, or switch off the power at the fuse box. This may be enough to stop the fire immediately.
- Smother the fire with a fire blanket, or use a dry powder or carbon dioxide extinguisher.
- **Remember:** never use water on a cooking oil or electrical fire.

IGNITION PROCEDURE

Prior to ignition:

Hotplate burner(s), position correctly sized, flat bottomed pan(s) directly onto the pan support above the selected burner(s).

Wok burner (if fitted)

- Position a flat bottomed wok or a correctly sized, flat bottomed pan directly onto the pan support above the wok burner.
- Position the provided wok stand directly onto the pan support above the wok burner, then position a round bottomed wok directly onto the stand.

Grill burner

Open the grill door and position the grill pan into the selected runner position. Remove the pan handle and leave the door open.



Oven burner(s)

Ensure the oven shelves are positioned into the selected runner positions. Close the door(s).

For main oven fanned gas cooking, push the convection fan button , prior to preheating for 15 minutes.

Correct procedure for ignition of all burners on this appliance.

Manual ignition (if applicable)

- Push in and keep depressed the ignition button . Sparking to all gas burners will commence.
- Push in and turn the selected gas burner control knob to the full flame symbol  or for oven burners, the maximum temperature setting. Keep the control knob depressed.
- As soon as the selected burner ignites release the ignition button.

- Continue to hold the control knob in for up to 15 seconds then release.
- If the burner fails to ignite within this time, release the control knob and wait 1 minute before attempting to re-ignite.

Dual Switch (if fitted)



Please Note:-

Your product may be fitted with a dual switch, that operates both the ignition and oven light, you will need to press the switch to the upward position and keep it depressed in order to follow the ignition procedures, and press it downwards to operate the oven light, off is the middle position.

Automatic ignition (if applicable)



- Push in and turn the selected gas burner control knob to the full flame symbol . Keep the control knob depressed. Sparking to the selected burner will commence automatically. Sparking will cease automatically once the flame is established.
- Continue to hold the control knob in for up to 15 seconds then release.
- If the burner fails to ignite within this time, release the control knob and wait 1 minute before attempting to re-ignite.

In the event of a power failure, or the ignition not working, then a lighted match or taper can be used to ignite the burner.

USING THE HOB - GAS

- Use pans which are large enough to avoid overflows onto the hob surface.
- Wipe any spillage as soon as possible.
- Clean the hob top as regularly as possible, this will prevent any build up of grease which may be a fire hazard.

Use

- Place your pan onto the pan supports above the burner you wish to use.
- Flat based woks may be positioned onto the pan support directly above the wok burner.
- To ignite, see **IGNITION PROCEDURE** page.
- To simmer, turn the control knob to the small flame symbol . This will ensure that the flame is just large enough to gently heat the contents of the pan.
- To turn off, turn the control knob to the off  position.
- Always make sure that your pans are placed centrally on the burners and do not allow the flame to extend over the base of the pan.
- Avoid the use of pans that overhang

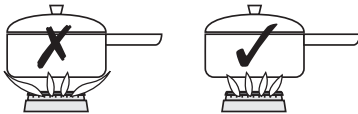

the edges of the hotplate.

- To use a round bottomed wok, position the wok stand provided onto the pan support above the wok burner, then position the wok onto the stand.

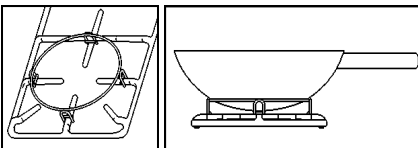

Energy Saving

- Position pans centrally over the burners.
- Only heat the amount of liquid you need.
- Once liquids have been brought to the boil, reduce the heat setting to a simmer.
- Consider using a pressure cooker if possible.
- Vegetables cut into small pieces will cook more quickly.
- Use a pan which is a close match to your burner size.
- Smaller burners are ideal for simmering and stewing in smaller pans, while the larger burners are ideal for frying and boiling.

FOLD DOWN LID (IF FITTED)

Caution: Glass lids may shatter when heated. Turn off all the burners before shutting the lid.

When opening and closing the lid, use the cooler outer sides of the lid glass.

The lid must be opened fully, so there is no danger of it closing while the hob is being used.

The appliance is fitted with a safety system, which will automatically turn off the hotplate burners if they are inadvertently left on as the lid is closed.

The lid is not intended to be used as a work surface, as it becomes hot when any part of the cooker is in use. The surface may be scratched if items with rough or sharp surfaces are placed on it.

Always remove any spillage from lid before opening.

Always allow the hob surface to cool before closing the lid.

Make sure that the wok stand is removed from the pan support before closing lid.

USING THE GRILL - GAS (IF FITTED)

Caution: Accessible parts may be hot when the grill is used - young children should be kept away.

A grill pan handle can be purchased as an optional extra from our spares department quoting the numbers below.

Handle - 082283705

Handle grip - 082469100

Complete grillpan pack - 012635666

Contact details can be found on the customer care page.

If cleaning the grill pan when it is hot, use oven gloves to move it.

Food for grilling should be positioned centrally on the trivet.

Using the grill

Important: The grill door must be fully open when the grill is used.

To ignite, see **IGNITION PROCEDURE** page.

The speed of grilling can be controlled by selecting a higher or lower shelf position. For toasting, and for grilling foods such as bacon, sausages or steaks, use a higher shelf position. For thicker foods such as chops or chicken joint pieces, use a middle to low shelf position.

The grill trivet, inside the grill pan, can be inverted to give a high or low position, or it may be removed.

Variation in grilling can be achieved by setting the control between the small and large flame symbols.

Important: Never operate the grill between the large flame and the 'OFF' position.

To turn off, turn the control knob to the off ● position.

Aluminium foil

Using aluminium foil to cover the grill pan, or putting items wrapped in foil under the grill creates a fire hazard.

The cooling fan (if fitted)

Within a couple of minutes of the grill being turned on, the cooling fan will come on. This keeps the fascia and control knobs cool during grilling. The fan will continue to operate after the grill has been turned off.

During use the fan may cycle on and off, this is normal.

USING THE GRILL - ELECTRIC (IF FITTED)

Caution: Accessible parts may be hot when the grill is used - young children should be kept away.

A grill pan handle can be purchased as an optional extra from our spares department quoting the numbers below.

Handle - 082283705

Handle grip - 082469100

Complete grillpan pack - 012635666

Contact details can be found on the customer care page.

If cleaning the grill pan when it is hot, use oven gloves to move it.

Food for grilling should be positioned centrally on the trivet.

Using the grill

Important: The grill door must be fully open when the grill is used.

Open the grill door. Turn the grill control knob to the grill symbol  position. For best cooking results, we recommend that you preheat the grill for about 3 minutes.

Push the grill pan towards the back of the shelf, to position it under the grill.

The speed of grilling can be controlled by selecting a higher or lower shelf position. For toasting, and for grilling foods such as bacon, sausages or steaks, use a higher shelf position. For thicker foods such as chops or chicken joint pieces, use a middle to low shelf position.

The grill trivet, inside the grill pan, can be inverted to give a high or low position, or it may be removed. The HIGH trivet position is suitable for toasting bread. The LOW trivet position is suitable for grilling all types of meat & fish.

With the grill trivet removed the food is placed directly on the base of the grill pan - eg: when cooking whole fish or browning dishes such as cauliflower cheese.

To switch off, turn the control knob to the off  position.

Aluminium foil

Using aluminium foil to cover the grill pan, or putting items wrapped in foil under the grill creates a fire hazard.

The cooling fan (if fitted)

When the grill is switched on, after a short delay, the cooling fan comes on to keep the fascia and control knobs cool during grilling. The fan may continue to operate for a period after the grill has been switched off.

During use the fan may cycle on and off, this is normal.

USING THE TOP OVEN - GAS

USING THE TOP OVEN

Ignition

Push in and turn the top oven control knob to the 'FULL ON' position. Hold the control knob in, and press the ignition switch (if fitted) or hold a lighted match or taper to the burner, until the burner lights. Hold the control knob in for 15 seconds. Do not hold the control knob in for longer than 15 seconds. If the burner fails to light within this time, release the control knob and wait one minute before attempting further ignition.

Turn the control knob to the required setting.

To switch off, return the control knob to the off position.

Note; Some appliances are automatic ignition and do not have an ignition switch.

Using the top oven

The top oven can be used in the same way as the main oven, to cook the full range of dishes, but it is a SECONDARY oven and there are some differences.

Foods cooked in the top oven should be in relation to the oven size. Larger dishes, or food which may rise during cooking, should be cooked in the main oven.

Large items, wide tins and tall items such as rich fruit cakes should be cooked in the main oven to obtain optimum results.

Notes:

As part of the cooking process, hot air is expelled through a vent at the top of the oven(s). When opening the oven door, care should be taken to avoid any possible contact with potentially hot air, since this may cause discomfort to people with sensitive skin. We recommend that you hold the underneath of the oven door handle.

Preheating

Always preheat the top oven for 15 minutes. However, if the main oven is being used at the same time, then preheating may not be necessary. The cooking time may need to be shortened slightly, or the cooking temperature adjusted, to allow for heat transfer from the main oven to the top oven if both ovens are used together.

If you are not preheating the oven, the cooking times in the baking guide may need to be extended, as they are based on a preheated oven.

The oven must be preheated when reheating frozen or chilled foods, and we recommend preheating for yeast mixtures, batters, soufflés and whisked sponges.

Put the oven shelves in the position required before preheating the oven.

Zones of heat

The temperature at the centre of the oven corresponds with the selected gas mark and is slightly higher towards the top of the oven and slightly lower towards the oven base.

These zones of heat can be useful as different dishes requiring different temperatures can be cooked at the same time, when more than one shelf is used.

The temperature at the oven base is suitable for cooking baked vegetables, baked fruit, milk pudding etc, and for warming bread rolls, soup, coffee, or ovenproof plates and dishes.

If you find that over a period of time, the oven becomes hotter when used at a particular gas mark, the thermostat may need to be replaced.

USING THE TOP OVEN - GAS

OVEN FURNITURE

Baking tray and roasting tins

For best cooked results and even browning, the maximum size baking trays and roasting tins that should be used are as follows;

Baking tray 350mm x 330mm

Roasting tin 370mm x 320mm

Position baking trays and roasting tins on the middle of the shelves, and leave one clear shelf position between shelves, to allow for circulation of heat.

Oven shelves

Extra shelves may be ordered from your local supplier.

The oven shelf must be positioned with the upstand at the rear of the oven and facing upwards.

The top oven shelf helps to ensure even baking in the top oven. It has a rear deflector fitted to it, and is not intended for use in the main oven.

OVEN LIGHT (IF FITTED)

Press the light button on the fascia panel. If there is no light button the oven light will come on when the oven control is operated.

SLOW COOKING

Make sure that frozen foods are thoroughly thawed before cooking.

Do not slow cook joints of meat or poultry weighing more than 2¼kg / 4½lb.

Always use the top half of the oven for slow cooking.

For roasting joints of meat or poultry, and for pot roasts preheat the oven to gas 195 °C and cook for 30 minutes, then adjust the oven control to 125 °C setting for the remainder of the cooking time.

Slow cooking times will be about three times as long as conventional cooking times.

USING THE TOP OVEN - GAS

TOP OVEN BAKING GUIDE

Food	Recommended temperature (°C)	Suggested shelf position	Approximate cooking time (preheated oven)
Scones	210	top - middle	10 - 15 mins
Meringues	125	bottom	2 - 3 hours
Cakes			
Small cakes	180	middle	15 - 25 mins
Whisked sponge	180	middle	20 - 30 mins
Swiss roll	195	middle	10 - 12 mins
Victoria sandwich (2 x 180 mm / 7" per shelf)	165	middle (side by side)	20 - 35 mins
Genoese Sponge (2 x 180 mm / 7" per shelf)	180	middle	25 - 30 mins
Pastry			
Rough Puff	210	middle	cooking time
Flaky / Puff	195	middle	depends on
Shortcrust	195	middle	recipe & type
Flan	195	middle	of filling
Biscuits			
Shortbread fingers	180	middle - top	
Nut brownies	180	middle	
Brandy snaps	165	middle - top	
Flapjacks	165	middle - top	
Ginger nuts	180	middle - top	

Baking guide hints

The temperature settings and times given in the baking guide are based on dishes made with block margarine. If tub margarine is used, it may be necessary to reduce the temperature setting.

If a different temperature setting to that shown in our guide is given in a recipe, the recipe instruction should be followed.

The cooking times given in the baking guides are based on a preheated oven. If you do not preheat the oven, cooking times should be extended.

USING THE TOP OVEN - GAS

Traditional fruit cakes

It should be remembered that ovens can vary over time, therefore cooking times can vary, making it difficult to be precise when baking fruit cakes.

It is necessary therefore, to test the cake before removal from the oven. Use a fine warmed skewer inserted into the centre of the cake. If the skewer comes out clean, then the cake is cooked.

- Do not attempt to make Christmas cakes larger than the oven can cope with, you should allow at least 25mm (1 inch) space between the oven walls and the tin.
- Always follow the temperatures recommended in the recipe.
- To protect a very rich fruit cake during cooking, tie 2 layers of brown paper around the tin.
- We recommend that the cake tin is not stood on layers of brown paper, as this can hinder effective circulation of air.
- Do not use soft tub margarine for rich fruit cakes, unless specified in the recipe.
- Always use the correct size and shape of tin for the recipe quantities.

Roast turkey

Roasting turkey involves cooking two different types of meat - the delicate light breast meat, which must not be allowed to dry out, and the darker leg meat, which takes longer to cook.

The turkey must be roasted long enough for the legs to cook, so frequent basting is necessary. The breast meat can be covered once browned.

- Always make sure that the turkey is completely thawed and that the giblets are removed before cooking.
- Turkey should be roasted at 125 °C setting for 20 minutes per lb, plus 20 minutes, unless packaging advises otherwise.
- The turkey can be open roasted, breast side down, for half of the cook time, and then turned over for the remainder of the cooking time.
- If the turkey is stuffed, add 5 minutes per lb to the cooking time.
- If roasting turkey covered with foil, add 5 minutes per 1lb to the cooking time.

To test if the turkey is cooked, push a fine skewer into the thickest part of the thigh. If the juices run clear, the turkey is cooked. If the juices are still pink, the turkey will need longer cooking.

Please note:- for all other Roasting guides refer to main oven section and see table.

USING THE TOP OVEN - GAS

Roasting guide

The times given in the roasting guide are only approximate, because the size and age of the bird will influence cooking times as will the shape of a joint and the proportion of the bone.

Frozen meat should be thoroughly thawed before cooking. For large joints it is advisable to thaw overnight.

Frozen poultry should be thoroughly thawed before cooking. The time required depends on the size of the bird - eg; a large turkey may take up to 48 hours to thaw.

Use of a trivet with a roasting tin will reduce fat splashing and will help to keep the oven interior clean. Alternatively, to help reduce fat splashing, potatoes or other vegetables can be roasted around the meat/poultry.

Notes:

- When cooking stuffed meat or poultry calculate the cooking time from the total weight of the meat plus the stuffing.
- For joints cooked in foil or covered roasters, and for lidded casseroles, add 5 minutes per 450g (1lb) to the calculated cooking time.
- Smaller joints weighing less than 1.25kg (2½lb) may require 5 minutes per 450g (1lb) extra cooking time.
- Position the oven shelf so that the meat or poultry is in the centre of the oven.
- It is recommended that the appliance is cleaned after open roasting.

Cook in oven at 180 °C setting		Approximate Cooking Time (preheated oven)
Beef	Rare	20 minutes per 450g (1lb), plus 20 minutes
	Medium	25 minutes per 450g (1lb), plus 25 minutes
	Well done	30 minutes per 450g (1lb), plus 30 minutes
Lamb	Medium	25 minutes per 450g (1lb), plus 25 minutes
	Well Done	30 minutes per 450g (1lb), plus 30 minutes
Pork		35 minutes per 450g (1lb), plus 35 minutes
Poultry		20 minutes per 450g (1lb), plus 20 minutes

USING THE MAIN OVEN - GAS

USING THE MAIN OVEN

Ignition

Push in and turn the main oven control knob to the 'FULL ON' position. Hold the control knob in, and press the ignition switch (if fitted) or hold a lighted match or taper to the burner, until the burner lights. If after 15 seconds, the burner has not lit, turn off the oven and leave the compartment door open. Wait at least one minute before a further attempt to ignite the burner.

Do not hold the control knob in for more than 15 seconds.

Turn the control knob to the required setting.

Note; Some appliances have automatic ignition and do not include or require an ignition switch.

To turn off, return the control knob to the "off" position.

Preheat the main oven for 15 minutes. If you are not preheating the oven, the cooking times in the baking guides may need to be extended, as they are based on a preheated oven.

The oven must be preheated when reheating frozen or chilled foods, and we recommend preheating for yeast mixtures, batters, soufflés and whisked sponges. Put the oven shelves in the position required before preheating the oven.

Zones of heat

The temperature at the centre of the oven corresponds with the selected gas mark and is slightly higher towards the top of the oven and slightly lower towards the oven base. These zones of heat can be useful as different dishes requiring different temperatures can be cooked at the same time, when more than one shelf is used.

The temperature at the oven base is suitable for cooking baked vegetables, baked fruit, milk pudding etc, and for warming bread rolls, soup, coffee, or ovenproof plates and dishes.

If you find that over a period of time, the oven becomes hotter when used at a particular gas mark, the thermostat may need to be replaced.

Oven light (if fitted)

Press the light button on the fascia panel. If there is no light button the oven light will come on when the oven control is operated.

OVEN FURNITURE

Baking tray and roasting tins

For best cooked results and even browning, the maximum size baking trays and roasting tins that should be used are as follows;

Baking tray 350mm x 330mm

Roasting tin 370mm x 320mm

Position baking trays and roasting tins on the middle of the shelves, and leave one clear shelf position between shelves, to allow for circulation of heat.

Oven shelves

Extra shelves may be ordered from your local supplier.

The oven shelf must be positioned with the up-stand at the rear of the oven and facing upwards.

SLOW COOKING

Make sure that frozen foods are thoroughly thawed before cooking.

Do not slow cook joints of meat or poultry weighing more than 2¼kg/4½lb.

Always use the top half of the oven for slow cooking.

USING THE MAIN OVEN - GAS

For roasting joints of meat or poultry, and for pot roasts preheat the oven to gas mark 6 and cook for 30 minutes, then adjust the oven control to the 125 °C setting for the remainder of the cooking time.

Slow cooking times will be about three times as long as conventional cooking times.

MAIN OVEN BAKING GUIDE

Food	Recommended temperature (°C)	Suggested shelf position	Approximate cooking time (preheated oven)
Scones	230	middle - top	10 - 15 mins
Meringues	125	bottom	2 - 3 hours
Cakes			
Small cakes	200	middle - top	15 - 25 mins
Whisked sponge	200	middle - top	20 - 25 mins
Swiss roll	215	middle - top	10 - 12 mins
Victoria sandwich (2 x 180mm/7")	185	middle - top	20 - 30 mins
Genoise sponge	185	middle	20 - 30 mins
Madeira (180mm/7")	170	middle	1 - 1¼ hours
Gingerbread	170	middle	1 - 1¼ hours
Semi rich fruit cake (205mm/8")	150 or 160	middle - top	2½ - 3 hours
Christmas cake (205mm/8")	150 or 160	bottom - middle	depending on recipe
Dundee cake (205mm/8")	170	middle - bottom	2 - 2½ hours
Pastry			
Rough Puff	230	middle - top	Cooking time depends on recipe and type of filling
Flaky/Puff	215	middle - top	
Shortcrust	215	middle - top	
Flan	215	middle - top	
Biscuits			
Nut brownies	200	middle - top	25 - 35 mins
Brandy snaps	185	middle - top	10 - 12 mins
Flapjacks	185	middle - top	20 - 25 mins
Gingernuts	185	middle - top	10 - 20 mins

USING THE MAIN OVEN - GAS

Traditional fruit cakes

It should be remembered that ovens can vary over time, therefore cooking times can vary, making it difficult to be precise when baking fruit cakes.

It is necessary therefore, to test the cake before removal from the oven. Use a fine warmed skewer inserted into the centre of the cake. If the skewer comes out clean, then the cake is cooked.

- Do not attempt to make Christmas cakes larger than the oven can cope with, you should allow at least 25mm (1 inch) space between the oven walls and the tin.
- Always follow the temperatures recommended in the recipe.
- To protect a very rich fruit cake during cooking, tie 2 layers of brown paper around the tin.
- We recommend that the cake tin is not stood on layers of brown paper, as this can hinder effective circulation of air.
- Do not use soft tub margarine for rich fruit cakes, unless specified in the recipe.
- Always use the correct size and shape of tin for the recipe quantities.

Roast turkey

Roasting turkey involves cooking two different types of meat - the delicate light breast meat, which must not be allowed to dry out, and the darker leg meat, which takes longer to cook.

The turkey must be roasted long enough for the legs to cook, so frequent basting is necessary. The breast meat can be covered once browned.

- Always make sure that the turkey is completely thawed and that the giblets are removed before cooking.
- Turkey should be roasted at 200 °C for 20 minutes per lb, plus 20 minutes, unless packaging advises otherwise.
- The turkey can be open roasted, breast side down, for half of the cook time, and then turned over for the remainder of the cooking time.
- If the turkey is stuffed, add 5 minutes per lb to the cooking time.
- If roasting turkey covered with foil, add 5 minutes per 1lb to the cooking time.

To test if the turkey is cooked, push a fine skewer into the thickest part of the thigh. If the juices run clear, the turkey is cooked. If the juices are still pink, the turkey will need longer cooking.

USING THE MAIN OVEN - GAS

Roasting guide

The times given in the roasting guide are only approximate, because the size and age of the bird will influence cooking times as will the shape of a joint and the proportion of the bone.

Frozen meat should be thoroughly thawed before cooking. For large joints it is advisable to thaw over night.

Frozen poultry should be thoroughly thawed before cooking. The time required depends on the size of the bird - eg; a large turkey may take up to 48 hours to thaw.

Use of a trivet with a roasting tin will reduce fat splashing and will help to keep the oven interior clean. Alternatively, to help reduce fat splashing, potatoes or other vegetables can be roasted around the meat/poultry.

Notes:

- When cooking stuffed meat or poultry calculate the cooking time from the total weight of the meat plus the stuffing.
- For joints cooked in foil or covered roasters, and for lidded casseroles, add 5 minutes per 450g (1lb) to the calculated cooking time.
- Smaller joints weighing less than 1.25kg (2½lb) may require 5 minutes per 450g (1lb) extra cooking time.
- Position the oven shelf so that the meat or poultry is in the centre of the oven.
- It is recommended that the appliance is cleaned after open roasting.

Cook in oven at 200 °C		Approximate Cooking Time (pre-heated oven)
Beef	Rare	20 minutes per 450g (1lb), plus 20 minutes
	Medium	25 minutes per 450g (1lb), plus 25 minutes
	Well done	30 minutes per 450g (1lb), plus 30 minutes
Lamb	Medium	25 minutes per 450g (1lb), plus 25 minutes
	Well Done	30 minutes per 450g (1lb), plus 30 minutes
Pork		35 minutes per 450g (1lb), plus 35 minutes
Poultry		20 minutes per 450g (1lb), plus 20 minutes

USING THE MAIN OVEN - FANNED GAS

USING THE MAIN OVEN

Ignition

Push in and turn the top oven control knob to the 'FULL ON' position. Hold the control knob in, and press the ignition switch (if fitted) or hold a lighted match or taper to the burner, until the burner lights. Hold the control knob in for 15 seconds. Do not hold the control knob in for longer than 15 seconds. If the burner fails to light within this time, release the control knob and wait one minute before attempting further ignition.

Turn the control knob to the required setting

For main oven fanned gas cooking, push the convection fan button  prior to preheating for 15 minutes.

To turn off, turn the control knob to the off  position.

Press the convection fan button to stop the oven fan once cooking is complete.

Preheating

Preheat the main oven for 15 minutes. If you are not preheating the oven, the cooking times in the baking guides may need to be extended, as they are based on a preheated oven.

The oven must be preheated when reheating frozen or chilled foods, and we recommend preheating for yeast mixtures, batters, soufflés and whisked sponges. Put the oven shelves in the position required before preheating the oven.

Cooking with a fanned oven

There are no zones of heat in a fan oven as the convection fan at the back of the oven ensures a more even temperature throughout the oven. This makes it ideal for batch baking – e.g. when preparing for a party - as all of the items will be cooked within the same period of time.

When batch baking foods that will rise during cooking – e.g. bread – always ensure that enough space has been left between the shelves to allow for the rise.

In order to maintain the free circulation of air within the oven, always leave at least 5 clear runner positions between trays.

e.g.

runner 9



runner 3



Notes:

As part of the cooking process, hot air is expelled through a vents at the top of the oven. When opening the oven door, care should be taken to avoid any possible contact with potentially hot air, since this may cause discomfort to people with sensitive skin. To open the door, we recommend that you hold the underneath of the oven door handle.

Oven light (if fitted)

Press the oven light button  on the fascia panel. If there is no light button the oven light will come on when the oven control is operated.

Main Oven Baking Guide

Cooking times and temperatures

The temperature settings and times given in the baking guide are based on dishes made with block margarine. If soft tub margarine is used it may be necessary to reduce the temperature setting.

COOKING GUIDE - FANNED GAS

The following is intended as a guide and experience may show some slight variation to be necessary to meet individual requirements. Ovens were preheated for 15 minutes before testing.

Food	Fanned gas oven		
	Recommended temperature (° C)	Oven Shelf position	Time (minutes)
Meringues			
Hard - individual	120	Any	90-180
Soft-Individual	190	Any	15-20
Pavlova - 6 egg	130	Any	75
Biscuits			
Rolled	190	Any	10-15
Spooned	200	Any	12-15
Shortbread Biscuits	170	Any	30-35
Cakes			
Patty cakes	200	Any	15-20
Sponge - 4 egg	190	Any	20-30
Plain Butter Cake	190	Any	25-40
Rich Fruit Cake	150	Any	180
Scones			
Plain or fruit	230	Any	10-15
Pastry - Short-crust			
Cornish Pasties #	210 then 190	Any	10 then 30
Custard Tart #	230 then 190	Any	10 then 35
Pastry Choux			
Cream Puffs	220	Any	25-30
Yeast Goods			
Bread	220	Any	25-30

* Shelf positions are counted from the bottom runner up.

Bottom shelf position is runner 1. Top shelf position is runner 10.

#Turn down temperature shown.

COOKING GUIDE - FANNED GAS

Cook in oven at 200 °C		Approximate Cooking Time (preheated oven)
Beef	Rare	20 minutes per 450g (1lb), plus 20 minutes
	Medium	25 minutes per 450g (1lb), plus 25 minutes
	Well done	30 minutes per 450g (1lb), plus 30 minutes
Lamb	Medium	25 minutes per 450g (1lb), plus 25 minutes
	Well Done	30 minutes per 450g (1lb), plus 30 minutes
Pork		35 minutes per 450g (1lb), plus 35 minutes
Poultry		20 minutes per 450g (1lb), plus 20 minutes



HANDLING BAKING PROBLEMS

Problem	Causes	What to do
Uneven cooking	<ul style="list-style-type: none"> • Oven not preheated adequately • Incorrect shelf position • Baking tray or dish incorrect colour • Oven tray too large • Trays not in centre of shelf • Air flow in oven uneven 	<ul style="list-style-type: none"> • Preheat oven to instructions • Refer to oven cooking guide • Electric - silver or shiny Gas - Dark Coloured • Try other trays or dishes • Put trays in centre of shelf • Turn food during cooking
Baked products too brown on top	<ul style="list-style-type: none"> • Oven not preheated • Aluminum foil in oven • Baking tins too large for recipe • Baking tins not evenly spaced • Food not evenly sized or placed on trays • Food placed too close to top of oven 	<ul style="list-style-type: none"> • Preheat until indicator light goes off for electric & at least 15 minutes for gas • Remove foil • Use correct size tins • Place baking tins so that there is at least 3 cms between tins and oven walls • Make food same size and shape and spread evenly on trays • Place food in middle or on a lower shelf
Baked products too brown on bottom	<ul style="list-style-type: none"> • Baking temperature too high • Baking tins too large for recipe • Baking tins are dark metal or glass • Food too low in oven • Oven door opened too frequently during cooking 	<ul style="list-style-type: none"> • Lower temperature • Use correct size tins • Change to Shiny, light tins or lower temperature by 10°C • Cook two shelves higher • Do not open door until half way through cooking time

HANDLING BAKING PROBLEMS

Problem	Causes	What to do
Cakes have cracked thick crust	<ul style="list-style-type: none"> • Baking temperature too high • Food too high in oven • Cake batter over mixed • Pan too deep • Baking tins too dark 	<ul style="list-style-type: none"> • Lower temperature • Cook two shelves lower • Mix just long enough to combine ingredients • Check size of pan and use recommended size • Change to shiny tins
Baking products are pale, flat and under-cooked	<ul style="list-style-type: none"> • Baking temperature too low • Food too low or high in oven • Baking time too short • Incorrect tin size 	<ul style="list-style-type: none"> • Raise temperature • Cook two shelves higher for gas or lower for electric • Increase cooking time • Use correct size tin
Cakes fallen in centre	<ul style="list-style-type: none"> • Baking temperature too low • Baking time too short • Measurement of ingredients is wrong • Door opened too early 	<ul style="list-style-type: none"> • Raise temperature • Increase cooking time • Check recipe • Do not open door until at least three quarters (3/4) of the way through cooking time or switch on oven light and view through door glass
Crusts too thick	<ul style="list-style-type: none"> • Incorrect ingredients 	<ul style="list-style-type: none"> • Check recipe
Meat and potatoes not browning in fan oven	<ul style="list-style-type: none"> • Poor circulation 	<ul style="list-style-type: none"> • Put food onto a rack to allow air to circulate properly.
Juices running out of meat		<ul style="list-style-type: none"> • Do not pierce meat with fork but turn with tongs

RECOMMENDATIONS AND GOOD PRACTICES

- After igniting the oven burner, always turn the oven burner control knob to the maximum control knob setting and then turn down to the desired temperature setting.
- After preheating the oven for 15 minutes at the selected temperature, open the door and enter the food as quickly as possible to minimise heat losses.
- Close oven door gently so as not to disturb the position of foods or cause unnecessary disturbance to the oven flame.
- Whenever possible press the oven light button  to assist viewing the cooking progress, rather than opening the door to view food.
- Do not leave the oven light on continuously during the cooking process, this wastes energy and costs you more.
- Certain dishes can leave lingering odours in an oven, which can taint the taste of the next food cooked or baked. To prevent this, after cooking a particularly odorous dish, e.g. fatty lamb, allow the oven to cool, open the oven door, wipe up any obvious spills and splashes from the oven interior, then push the oven convection fan button  and allow the fan to operate for awhile, to help force out the odours.
- **Always remember to switch the oven convection fan off after use. Do not waste energy.**

USING THE CLOCK PROGRAMMER-GAS (IF FITTED)







Function

The 'function' button in the centre is used for setting the minute minder and setting up the automatic cooking. See below for details.

To set the time of day





When the power is turned on to the appliance, the time of day starts from 0.00.

Press and release the  (minus) and  (plus) buttons simultaneously. Set the time of day, eg 2.00 with the  and  buttons while the 'dot' between the hours and minutes is flashing.

To select an alarm tone



Press and hold the  (minus) button to listen to the first tone. Release the  button and press it again to listen to the second tone, etc. Releasing the  button after the tone has sounded will automatically select that tone.

Setting the minute minder

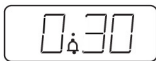

Press and release the function button. The minute minder bell symbol will appear and flash on the display. Use the plus and minus buttons to set the required alarm time. After setting, the display will revert to show

the time of day and the bell symbol will stop flashing. Pressing the function button will display the minutes remaining. If the time has counted down to the last minute, the remaining seconds are shown. The tone will sound at the end of the time set. To cancel the tone, press the function button.

Semi-automatic cooking

This clock function can be used when you have started cooking a meal or a dish in the oven and want to set the time for the oven to switch off.

Press and release the function button twice. The display will show the oven symbol flashing and also the A (auto) symbol is shown. Use the plus and minus buttons to set the display to show the length of cooking time required (eg, 2 hours *). After setting, the display will revert to show the time of day and the oven and auto symbols will be shown in the display.

The function button can be pressed and released twice to show how much cooking time remains on the clock. At the end of the cooking time, the alarm will sound and the oven will automatically switch off. To switch off the alarm, press the function button. If you wish to cancel the remaining cooking time on the clock before the alarm sounds, press the minus button until the display returns to 0.00.

NOTE - the minute minder function can be used independently from other timer functions. Eg. it is still possible to use the minute minder facility during a semi automatic cooking function. When both programs are running simultaneously, both the semi automatic indicator A, and oven symbol will be displayed alongside the minute minder bell indicator in the time of day display.

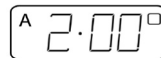

* As shown

USING THE MINUTE MINDER (IF FITTED)

Initial display

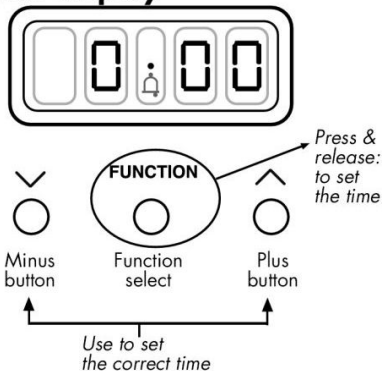

Setting the minute minder

- Press and release the plus button to change the display from clock to minute minder - the bell symbol will light.
- Use the plus and minus buttons to set the length of time before the alarm tone will sound. The display will increase/decrease in units of 10 seconds up to 99 minutes 50 seconds, and in units of 1 minute from 1 hour 40 minutes upwards. The maximum period which may be set is 10 hours.

The display format will change after 99 minutes and 50 seconds to 1 hour and 40 minutes.

During countdown, the minute minder has priority on the display, which will show (in minutes : seconds, or hours : minutes) the time remaining.

When countdown is complete, the tone will sound for 7 minutes, or it can be reset with one touch of any button.

To cancel the minute minder at any other time, run down the set time with the minus button.

The display will revert to show the time of day.

MECHANICAL MINUTE MINDER

Turn the minute minder control knob fully to the maximum setting, then turn back to the desired setting.

When countdown is complete, the timer will give a audible signal for a few seconds before it stops.

ELECTRONIC MINUTE MINDER

The digital timer enables you to set the time of day (24 hour clock) and the minute minder alarm.

Setting the "Time of Day"

- Switch on the electricity supply to the appliance.
- The display will flash.
- Press and release the time of day button.
- Set the time of day with the plus and minus buttons.
- The time will be set 7 seconds after the last plus or minus operation.

Alarm tones

After setting the time of day, you can select one of three alarm tones.

Press the minus button to listen to the first tone, then release the minus button and press it again to listen to the second tone, etc.

Releasing the minus button after a tone has sounded will automatically select that tone.

CLEANING

General

- It is important to clean the product regularly as a build up of fat can affect its performance or damage it and may invalidate your guarantee.
- Always switch off your appliance and allow it to cool down before you clean any part of it.
- Do not use undiluted bleaches, products containing chlorides, wire wool or abrasive cleaners on aluminium, stainless steel, or plastic/painted parts as they can damage the appliance. Nylon pads can also be unsuitable.
- Take extra care when cleaning over symbols on fascia panels. Excessive cleaning can lead to the symbols fading.
- If your product is fitted with stainless steel cladded strips. You may notice a small white residue on the outer edges, this can be removed with a non abrasive wipe.
- Do not use steam cleaners.

Painted & Plastic parts

- Only use a clean cloth wrung out in hot soapy water.
- Do not use abrasive cleaners, wire or nylon cleaning pads on these parts.

Stainless steel & Aluminium surfaces

- Only use a clean cloth wrung out in hot soapy water, and dry with a soft cloth.
- Stubborn marks can be removed using a stainless steel cleaner. Supplies can be purchased from the Customer Care Centre.
- Sharp objects can mark the surface of stainless steel, but will become less noticeable with time.
- Wipe any spillage immediately, taking care to avoid burning your hands-

Some foods are corrosive eg; vinegar, fruit juices and especially salt - they can mark or damage the metal if they are left on the surface.

- Baby oil can be used to restore stainless steel finishes - but only use a few drops. Don't use cooking oils as they can contain salts, which will damage the metal.

Enamel surfaces & parts

- Clean with warm, soapy water and a clean cloth.
- If larger splashes of fat do not readily disappear, you can use a mild cream cleaner to remove them. More stubborn marks can be removed using a soap filled pad.
- Rinse well and dry with a soft clean towel or cloth.
- Do not use steam cleaners.

Glass parts

- Only use a clean cloth wrung out in hot soapy water, or a specialist glass cleaner.
- Rinse away any excess cleaner and dry with a soft cloth.
- Do not use abrasives or polishes as they will scratch and damage the glass.

Chrome plated parts

- Use a moist soap filled pad, or place in a dishwasher

CLEANING

GAS HOB

Burner caps and heads

- The slots in the burner head where the flames burn should be cleared of deposits.
- Clean with a nylon brush, rinse and then dry thoroughly. There may be brown coloured markings on your burners; these are carbon deposits or fat stains and can be removed using a soap filled pad.
- Do not put burners in the dishwasher or soak them. Using dishwasher powders, washing up liquids and caustic pastes can damage the burners.
- Burner caps and heads must be repositioned correctly so that they sit squarely on to the hob as shown. This is particularly important with stainless steel models as failure to reposition the caps correctly may result in discolouration of the stainless steel around the burners.

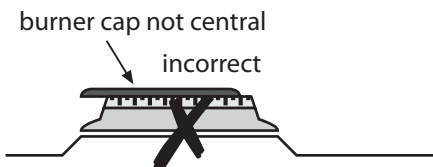
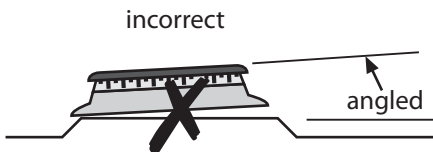
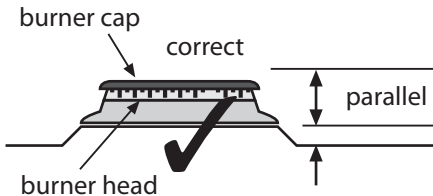

Cast iron griddle or pan supports (if fitted)

- Ensure the griddle has fully cooled and scrape off any stubborn marks and bits of food with a plastic or wooden cooking implement. Rinse in warm soapy water and dry with a tea towel.
- Do not clean in a dishwasher.
- If you notice any rusting on your griddle, or pan-supports, simply clean in warm soapy water, then re-season.
- To season: Heat the griddle for 30 seconds at a medium setting then switch off. Use a minimum amount of unsalted vegetable oil, on a dry cloth or paper towel, and apply a thin coat of oil to the element surface. Wipe off the excess and re-heat the griddle for one minute.

INSTALLATION INSTRUCTIONS - GAS

Before you start: Please read the instructions. Planning your installation will save you time and effort.

Prior to installation, ensure that the local distribution conditions (nature of the gas and gas pressure) and the adjustment of the appliance are compatible. The adjustment conditions are stated on the data badge.

This appliance is not connected to a combustion evacuation device. It shall be installed and connected in accordance with current installation regulation. Particular attention shall be given to the relevant requirements regarding ventilation.

In your own interest and that of safety, it is the law that all gas appliances be installed and serviced by competent persons. GAS SAFE registered installers undertake to work to satisfactory standards.

Where regulations or standards have been revised since this handbook was printed, always use the latest edition.

In the UK the regulations and standards are as follows:

1. Gas Safety Regulations 1996 (Installation and Use).
2. Building Regulations - Issued by the Department of the Environment.
3. Building Standards (Scotland) (Consolidated) - Issued by the Scottish Development Department.
4. The current I.E.E. Wiring Regulations.
5. Electricity at Work Regulations 1989.
6. BS 6172 Installation of Domestic Gas cooking Appliances.
7. Installation & Servicing Instructions for this appliance.

For installation in countries other than the UK, the appliance must be connected in accordance with all local gas and electrical regulations. In the Republic of Ireland, Installers should refer to IS813 Domestic Gas Appliances.

Ventilation requirements

The use of a gas cooking appliance results in the production of heat and moisture in the room in which it is installed. Ensure that the kitchen is well ventilated: keep natural ventilation holes open or install a mechanical ventilation device (mechanical extractor hood). Prolonged intensive use of the appliance may call for additional ventilation, for example, opening of a window, or more effective ventilation, for example increasing the level of mechanical ventilation where present.

The room containing the appliance should have an air supply in accordance with BS 5440: Part 2: 1989:

All rooms require an openable window, or equivalent, and some rooms will require a permanent vent as well.

For room volumes up to 5m³ an air vent of 100cm² is required.

If the room has a door that opens directly to the outside, or the room exceeds 10m³, NO AIR VENT is required.

For room volumes between 5m³ and 10m³ an air vent of 50cm² is required.

If there are other fuel burning appliances in the same room, BS 5440: Part 2: 1989 should be consulted to determine the air vent requirements.

This appliance must not be installed in a bed sitting room of less than 20m³ or in a bathroom or shower room.

INSTALLATION INSTRUCTIONS - GAS

Windows and permanent vents should therefore not be blocked or removed without first consulting a GAS SAFE gas installer.

In the Republic of Ireland, refer to relevant Irish Standards for correct ventilation requirements.

Failure to install appliances correctly is dangerous and could lead to prosecution.

Whilst every care is taken to eliminate burrs and raw edges from this product, please take care when handling - we recommend the use of protective gloves during installation.

Moving the cooker

Please note that the weight of this appliance is approximately **60kg** (unpacked). Take care if the appliance needs to be lifted during installation - always use an appropriate method of lifting.

Do not attempt to move the cooker by pulling on the doors or handles. Open the door and grasp the frame of the cooker, taking care that the door does not shut on your fingers. Take care to avoid damage to soft or uneven floor coverings when moving the appliance. Some cushioned vinyl floor coverings may not be designed to withstand sliding appliances without marking or damage.

CLEARANCES & DIMENSIONS

Appliance dimensions

All sizes are nominal - some variation is to be expected. The 'depth' of the cooker, as given below, is to the front of the door & excluding knobs & handles.

depth: 600mm
width: 500/550/600mm
height - lid down: 900 - 915mm
height - lid raised: 1430 - 1445mm

Clearances

No shelf or overhang or cooker hood should be closer than a minimum of 650mm, but check with cooker hood manufacturer's recommendations.

The cooker must have a side clearance above hob level of 90mm up to a height of 400mm.

This cooker may be fitted flush to base units. However, for models with side opening doors, we recommend a side clearance of 60mm between the cooker and any side wall.

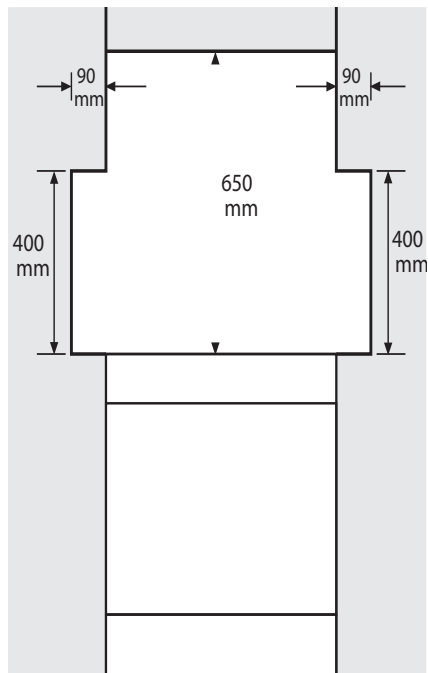

INSTALLATION INSTRUCTIONS - GAS

LEVELLING YOUR COOKER

Place a spirit level on a baking sheet onto an oven shelf.

The cooker is fitted with LEVELLING FEET. Level your cooker to your desired height using the levelling feet at the front and rear of the cooker.

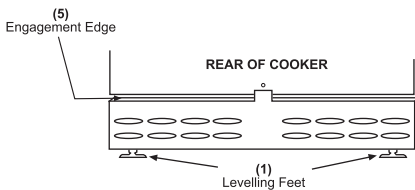

Stability bracket

If the cooker is fitted with a flexible connection, a stability bracket should be fitted to engage in the back of the cooker. A stability bracket can be bought from your local supplier.

A stability bracket can be fitted as follows:

Place the cooker in position and draw a PENCIL LINE level with the front edge (2).

Mark the centre of the cooker to give a CENTRE LINE (3).

Remove the cooker and mark off 200mm to the right of the centre line (4) on the rear wall.

Measure from FLOOR LEVEL to the ENGAGEMENT EDGE where the stability bracket will rest and add 2mm (5).

Transfer this dimension to the rear wall and secure the bracket to the wall at this height (6) using the two off centre holes in the single bracket.

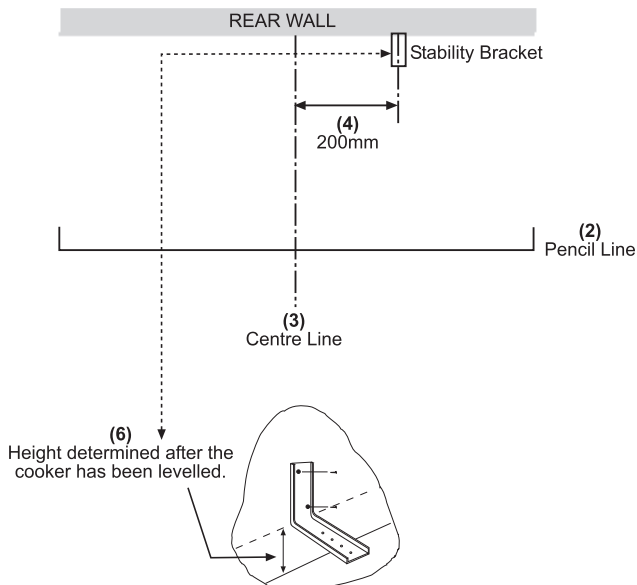

INSTALLATION INSTRUCTIONS - GAS

(Live), or coloured Red.

CONNECT TO THE ELECTRICITY SUPPLY

(mains ignition models only)

Warning: This appliance must be earthed.

The flexible mains lead is supplied connected to a BS 1363 fused plug, the plug is fitted with the correct fuse.

Replace only with a fuse of the same rating and type.

The wires in the mains lead are coloured in accordance with the following code:

Green and yellow = Earth,

Blue = Neutral,

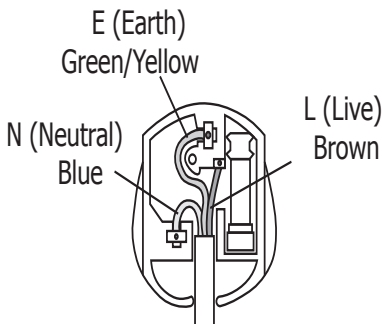

Brown = Live.

As the colours of the wires in the mains lead for the appliance may not correspond with the coloured markings identifying the terminals in your plug, proceed as follows:

1. The wire which is coloured green and yellow must be connected to the terminal marked E (Earth) or coloured Green.
2. The wire which is coloured blue must be connected to the terminal marked N (Neutral), or coloured Black.
3. The wire which is coloured brown must be connected to the terminal marked L

The plug and socket must be accessible after installation. Should the mains lead of the appliance ever require replacing, this must be carried out by a qualified electrician who will replace it with a lead of the same size and temperature rating.

Important: - ensure that you route all mains and electrical cables and flexible tubing well clear of any adjacent heat source.

Under no circumstances should the mains electric cable be allowed to come into contact with the vertical oven flue tubes on the rear of the appliance.

PRODUCTS WITH CAST IRON LID (WHERE FITTED)

A 55mm clearance is required from the back of the hotplate to the rear wall, to allow the lid to be opened fully. To ensure this clearance is maintained, the infill piece (supplied) should be fitted using the instructions below.

Fitting the infill piece between the rear of the hob and the wall

Fix the infill piece to the wall - using suitable screws and wall fixings (not supplied) - and ensure it is level with the hotplate as shown.

Note: The 55mm clearance dimension should not be reduced.

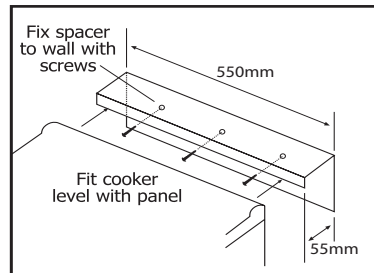

INSTALLATION INSTRUCTIONS - GAS

CONNECT TO THE GAS SUPPLY

The inlet to the cooker is ½" BSP internal situated at the rear right corner. Fit the bayonet connection. This should be located so as to ensure that the flexible connector hose does not kink.

Under no circumstances should the flexible connector be allowed to come into contact with the vertical oven flue tubes on the rear of the appliance.

Use a 900mm - 1125mm length of flexible connector.

Ensure that all pipework is of the correct rating for both size and temperature.

Natural Gas - Flexible connections should comply with BS 669. Parts of the appliance likely to come into contact with a flexible connector have a temperature rise of less than 70°C.

After installation, make sure all connections are gas sound.

COMMISSIONING

Burner aeration

All burners have fixed aeration and no adjustment is possible.

Pressure setting

G20 Natural Gas @ 20 mbar

Pressure test point

Use the oven injector.

Grill

Open the top oven / grill door. Push in and turn the top oven / grill control knob clockwise to the 'FULL ON' position. Hold the control knob in, and press the ignition switch (if fitted) or hold a lighted match or taper to the burner. Hold the control knob in for 15 seconds. Do not hold the control knob in for longer than 15 seconds. If the burner fails to light within

this time, release the control knob and wait one minute before attempting further ignition. until the burner lights.

Hob burner

Turn the control knob to the FULL ON position, wait a second before pressing the ignition switch or holding a lighted match or taper to the burner. Hold the control knob in for 15 seconds. Do not hold the control knob in for longer than 15 seconds. If the burner fails to light within this time, release the control knob and wait one minute before attempting further ignition.

Ovens

Open the oven door. Turn the control to the FULL ON position and press the ignition switch, or hold a lighted match or taper to the burner. Hold the control knob in for 15 seconds. Do not hold the control knob in for longer than 15 seconds. If the burner fails to light within this time, release the control knob and wait one minute before attempting further ignition.

Before leaving the installation

1. Place all the loose parts of the cooker into position.
2. Show the customer how to operate the cooker and give them this handbook. Thank you.

TECHNICAL DATA

GAS PRODUCTS

Data badge - Lower part of front frame

Gas category

Natural Gas - I2H, LP GAS - I3+.

Pressure setting

G20 Natural Gas @ 20 mbar

G30 Butane @ 28-30 mbar

G31 Propane @37 mbar

Pressure test point

Use the oven injector

Aeration - Fixed

Appliance class

Class 1, Freestanding

Grill - Grill burner is surface combustion type. Spark gaps 3 - 4mm.

Hob - Burners have burner heads and caps which are removable for cleaning. Concealed electrodes to each burner.

Oven - Oven burner is sheet steel, with pierced ports in stainless steel flame strip. Spark Gap: 3 - 4mm. Flame supervision: Thermoelectric type. Thermostat phial: Right hand side of oven.

Electrical supply (models with ignition)

220 - 240V ~ 50Hz

Warning: This cooker must be earthed.

Countries of destination

GB - Great Britain, IE - Ireland

Data - Oven and Grill Product with Wok				
Load (wattage): 55 - 65W				
Burner	Nominal NG Rate Qn	Nominal LPG Rate Qn	Injector Size NG	Injector Size LPG
Grill	2.4kW	2.4kW	115	76
Hob - LHF	1.0kW	1.0kW	77	50
Hob - LHR & RHR	2.0kW	2.0kW	104	70
Hob - RHF Rapid	-	-	-	-
Hob - RHF Wok	4.0kW	4.0kW	152	100
Top oven	-	-	-	-
Oven	2.5kW	2.4kW	115 Amal	70 Amal
Total heat input	13.9kW	13.8kW		

Data - Double Oven Product with Wok				
Load (wattage): 1610-1910W				
Burner	Nominal NG Rate Qn	Nominal LPG Rate Qn	Injector Size NG	Injector Size LPG
Grill	-	-	-	-
Hob - LHF	1.0kW	1.0kW	77	50
Hob - LHR & RHR	2.0kW	2.0kW	104	70
Hob - RHF Rapid	-	-	-	-
Hob - RHF Wok	4.0kW	4.0kW	152	100
Top oven	1.75kW	1.7kW	110 Amal	50 Amal
Oven	2.5kW	2.4kW	115 Amal	70 Amal
Total heat input	13.25kW	13.1kW		

CUSTOMER CARE

FAQs

What parts of the appliance can be washed in a dishwasher?

- Any enamelled parts such as the grill pan can be cleaned in a dishwasher, as can oven shelves and shelf guides.

What parts must NOT be cleaned in a dishwasher?

- Parts such as burner skirts and caps, control knobs and any cast iron items must not be cleaned in a dishwasher, they should be cleaned with hot soapy water and a nylon brush once they are cool enough.

There's been a power failure and the product won't work.

- Switch off the electricity supply.
- When the power returns switch the electricity supply back on and re-set any programmer/clock to the correct time of day.

My oven is a single combined oven and grill - can I use both functions together?

- No. You can only use one or the other.

Why is there condensation on the doors?

- Condensation is caused by hot, moist air meeting a cooler surface (i.e. the oven door). You cannot always prevent it, but you can minimise it when it happens by doing the following:
- Preheat the oven at a high temperature before putting food in the oven, and cover the food you are cooking wherever possible.
- Whenever you can, cook wet foods at higher temperatures.
- Don't leave food in the oven to cool down.
- Automatic cooking will normally pro-

duce condensation when the oven is cooling down with food inside.

Should the cooling fan continue to run once the appliance has been switched off?

- Yes. This is to make sure that you can always touch the control knobs to make temperature adjustments, and turn your appliance off.

Can all gas appliances be converted from Natural Gas to LP Gas?

- Not all gas appliances can be converted. If Category II is stated on the databadge, then the appliance may be converted and a conversion kit must be obtained if not already provided. If in doubt, please contact Customer Care for further advice - do not attempt to convert an appliance if it is not compatible.

Why won't the ignition work?

- Check there is a spark when the ignition button is depressed. If there is no spark, check the electricity supply is switched on at the socket. Check that the gas supply is switched on.

Call Customer Care for a Service Engineer's visit if:

- You find that the oven becomes hotter at a particular temperature - the thermostat may need replacing.
- The cooling fan fails to work.

CUSTOMER CARE

CUSTOMER CARE WEB SHOP

Having purchased a superior cooker, hob or hood from us, you'll naturally want to keep it looking great. And who better to help you care for it than the manufacturer?

We offer an extensive range of accessories, components and cleaning products which, will instantly give your cooker a good as new look.

In addition to the list of our most popular products below, we also have an exciting

range of Bake ware and Cookware essentials including Roasting Pans, Cake Tins and Non-Stick Cooking Liners.

For all enquires, please visit our Web Shop at www.gdhaonline.co.uk or call the Spares Sales Team on **0844 815 3745**. For countries outside the UK, please contact your local service agent.

Product Description	Where used	Purpose
Ceramic Hob Cleaner	All Ceramic glass hobs including Induction	Enables easier cleaning of your ceramic hob. Prevents build up of mineral deposits. Best used with Ceramic Hob Scraper Kit. 300ml bottle.
Ceramic Hob Scraper kit	All Ceramic glass hobs including Induction	Ideal for removing cooked on marks from ceramic glass hobs Best used with Ceramic Hob Cleaner
Sealed Hotplate Conditioner	All sealed/solid plate hobs	Restores the sleek matt black finish to solid hotplates
Multipurpose Kitchen Cleaner	General kitchen cleaner	Excellent multipurpose cleaner, For use around the kitchen. 500ml bottle.
Oven Cleaner	All cooking appliances.	Cuts through grease & burnt on grime. 500ml bottle
Restor-A-Cloth	All cooking appliances.	Chemical free cleaning cloth Ideal for cleaning & polishing glass & stainless steel
Stainless Steel Cleaner	All stainless steel parts	Oil based cleaner. Perfect for removing stubborn & greasy marks. 300ml bottle.
Rectangular carbon filters	Cooker Hoods	New filters, help to maintain efficient cooker hood operation and keep your Kitchen odour free
Round Carbon Filters	Cooker Hoods	New filters, help to maintain efficient cooker hood operation and keep your Kitchen odour free

CUSTOMER CARE

CHANGING LIGHT BULBS (where fitted)

Warning: There is a risk of electric shock, so always make sure you have turned off and unplugged your appliance before starting. Always allow the product to cool down before you change a bulb.

Not all appliances have the same number and type of bulbs. Before replacing your bulb, open the oven door and see which type you have. Then use the table to help you change your bulb correctly.

Bulbs can be purchased from hardwarestores (always take the old bulb with you).

Please remember that bulbs are not covered by your warranty.

No of Lamps	Instructions
1	Remove the oven shelves. Remove the loose oven back by unscrewing the 4 securing screws (one at each corner) and remove (Where fitted). Unscrew the lens cover by turning anticlockwise. Remove the bulb and replace. Replace the lens cover and oven back.

Please keep this handbook for future reference, or for anyone else
who may use the appliance.

Please keep this handbook for future reference, or for anyone else who may use the appliance.

Please keep this handbook for future reference, or for anyone else who may use the appliance.

CUSTOMER CARE

To contact Stoves about your appliance, please call

Warranty Registration

0844 481 0182

to register your appliance

Customer Care Helpline

0844 815 3740

in case of difficulty within the UK

Alternatively general, spares and service information is available from our website at
www.stoves.co.uk

Please ensure that you have the product's model no and serial no available when you call. These can be found on the silver data label on your product which is located:

Ovens	Open the door; adjacent to the oven cavity
High-level grill products	Inside the base compartment
Hobs	On the underside of the product

Enter appliance numbers here for future reference:

Model No

--	--	--	--	--	--	--	--	--	--

Serial No

--	--	--	--	--	--	--	--	--	--

SERVICE RECORD

Date of purchase	Installed by	Installation Date
Place of purchase:		

Date	Part(s) replaced	Engineer's name

For customers outside the UK and Northern Ireland, please contact your local supplier.

Glen Dimplex Home Appliances, Stoney Lane, Prescot, Merseyside, L35 2XW

Free Manuals Download Website

<http://myh66.com>

<http://usermanuals.us>

<http://www.somanuals.com>

<http://www.4manuals.cc>

<http://www.manual-lib.com>

<http://www.404manual.com>

<http://www.luxmanual.com>

<http://aubethermostatmanual.com>

Golf course search by state

<http://golfingnear.com>

Email search by domain

<http://emailbydomain.com>

Auto manuals search

<http://auto.somanuals.com>

TV manuals search

<http://tv.somanuals.com>