

- ▶ Operation Search
- ▶ Before use
- ▶ Getting started
- ▶ Recording
- ▶ Playback
- ▶ Saving images with an external device
- ▶ Customizing your camcorder
- ▶ Troubleshooting
- ▶ Maintenance and precautions

[➡ Contents list](#)

HDR-CX190/CX200/CX210/PJ200 User Guide

Use this manual if you encounter any problems, or have any questions about the camcorder.



HANDYCAM.

[▲ Back to top](#)

Copyright 2012 Sony Corporation

▶ **Operation Search**

▶ Before use

▶ Getting started

▶ Recording

▶ Playback

▶ Saving images with an external device

▶ Customizing your camcorder

▶ Troubleshooting

▶ Maintenance and precautions

[⇒ Contents list](#)

Operation Search

Operation Search

[Search by operation](#)

[▲ Back to top](#)

Copyright 2012 Sony Corporation

▶ [Operation Search](#)

▶ [Before use](#)

▶ [Getting started](#)

▶ [Recording](#)

▶ [Playback](#)

▶ [Saving images with an external device](#)

▶ [Customizing your camcorder](#)

▶ [Troubleshooting](#)

▶ [Maintenance and precautions](#)

[⇒ Contents list](#)

Before use

How to use this User Guide

[How to use this User Guide](#)

[Models and illustrations used in this User Guide](#)

Parts and controls/Screen indicators

[Parts and controls](#)

[Screen indicators](#)

Operating your camcorder

[Selecting items on the LCD screen](#)

[▲ Back to top](#)

▶ Operation Search

▶ Before use

▶ Getting started

▶ Recording

▶ Playback

▶ Saving images with an external device

▶ Customizing your camcorder

▶ Troubleshooting

▶ Maintenance and precautions

[⇒ Contents list](#)

Getting started

Checking the supplied items

[Supplied items](#)

Charging the battery pack

[Charging the battery using the AC Adaptor](#)

[Charging the battery using your computer](#)

[Charging the battery abroad](#)

Turning the power on, and setting the date and time

[Turning the power on, and setting the date and time](#)

Preparing the recording media

[Selecting a recording medium \(HDR-CX210\)](#)

[Inserting a memory card](#)

[▲ Back to top](#)

▶ [Operation Search](#)

▶ [Before use](#)

▶ [Getting started](#)

▶ [Recording](#)

▶ [Playback](#)

▶ [Saving images with an external device](#)

▶ [Customizing your camcorder](#)

▶ [Troubleshooting](#)

▶ [Maintenance and precautions](#)

[⇒ Contents list](#)

Recording

Recording

[Recording movies](#)

[Shooting photos](#)

Useful functions for recording images

[Zooming](#)

[Intelligent Auto](#)

[Recording the selected subject clearly \(Face Priority\) \(HDR-CX200/CX210/PJ200\)](#)

[▲ Back to top](#)

▶ [Operation Search](#)

▶ [Before use](#)

▶ [Getting started](#)

▶ [Recording](#)

▶ [Playback](#)

▶ [Saving images with an external device](#)

▶ [Customizing your camcorder](#)

▶ [Troubleshooting](#)

▶ [Maintenance and precautions](#)

[⇒ Contents list](#)

Playback

Playback

[Playing movies and photos from the Event View screen](#)

[Operating buttons while playing](#)

[Dividing a movie](#)

[Capturing a photo from a movie](#)

Highlight Playback

[Enjoying a digest of your movies \(Highlight Playback\)](#)

[Saving Highlight Playback in high definition image quality \(HD\) \(Scenario Save\)](#)

[Converting Highlight Playback scenes or Highlight Scenarios to standard definition image quality \(STD\) \(Highlight Movie\)](#)

Using the built-in projector

[Using the built-in projector \(HDR-PJ200\)](#)

Playing images on a TV

[Connecting the camcorder to a high definition TV](#)

[Connecting the camcorder to a non-high-definition TV](#)

[Connecting the camcorder to a TV via a VCR](#)

[Using "BRAVIA" Sync](#)

[▲ Back to top](#)

- ▶ [Operation Search](#)
- ▶ [Before use](#)
- ▶ [Getting started](#)
- ▶ [Recording](#)
- ▶ [Playback](#)
- ▶ [Saving images with an external device](#)
- ▶ [Customizing your camcorder](#)
- ▶ [Troubleshooting](#)
- ▶ [Maintenance and precautions](#)

[⇒ Contents list](#)

Saving images with an external device

Using the "PlayMemories Home" software

[Starting the "PlayMemories Home" software](#)

Selecting a method for saving images

[Disc creation guide](#)

[Types of media devices on which the images can be saved](#)

[The devices on which the created disc can be played back](#)

Saving images on an external media device

[Saving images on an external media device easily](#)

[Saving the desired images in the camcorder to the external media device](#)

[Playing back images in the external media device on the camcorder](#)

[Devices that cannot be used as an external media device](#)

Creating a disc with the DVD writer, DVDirect Express

[Creating a disc with DVDirect Express](#)

[Performing \[DISC BURN OPTION\]](#)

[Playing back a disc on the DVDirect Express](#)

Creating a disc with a DVD writer other than DVDirect Express

[Creating a high definition image quality \(HD\) disc with a DVD writer](#)

Creating a disc with a recorder

[Creating a standard definition image quality \(STD\) disc with a recorder, etc.](#)

[▲ Back to top](#)

- ▶ [Operation Search](#)
- ▶ [Before use](#)
- ▶ [Getting started](#)
- ▶ [Recording](#)
- ▶ [Playback](#)
- ▶ [Saving images with an external device](#)
- ▶ [Customizing your camcorder](#)
- ▶ [Troubleshooting](#)
- ▶ [Maintenance and precautions](#)

[⇒ Contents list](#)

Customizing your camcorder

Using menu items

[Setting up menu items](#)

Shooting Mode

[Movie](#)

[Photo](#)

Camera/Mic

[White Balance](#)

[Spot Meter/Fcs \(Spot meter/focus\) \(HDR-CX200/CX210/PJ200\)](#)

[Spot Meter \(Flexible spot meter\) \(HDR-CX200/CX210/PJ200\)](#)

[Spot Focus \(HDR-CX200/CX210/PJ200\)](#)

[Exposure](#)

[Focus](#)

[Low Lux](#)

[Scene Selection](#)

[Fader](#)

[Self-Timer](#)

[Tele Macro](#)

[SteadyShot \(movie\)](#)

[Digital Zoom](#)

[Auto Back Light](#)

[Face Detection](#)

[Smile Shutter](#)

[Smile Sensitivity](#)

[Bit-in Zoom Mic](#)

[Wind Noise Reduct.](#)

[Micref Level \(Microphone reference level\)](#)

[My Button](#)

[Guide Frame](#)

[Display Setting](#)

Image Quality/Size

[REC Mode](#)

[HD/STD Setting](#)

[Wide Mode](#)

[x.v.Color](#)

[Image Size](#)

Playback Function

[Event View](#)

[Highlight Movie](#)

[Scenario](#)

Edit/Copy

- Delete
- Protect
- Copy (HDR-CX210)
- Direct Copy

Setup

- Media Select (HDR-CX210)
- Media Info
- Format
- Repair Img. DB F.
- File Number
- Data Code
- Volume
- Download Music
- Empty Music
- TV Type
- HDMI Resolution
- CTRL FOR HDMI (Control for HDMI)
- USB Connect
- USB Connect Setting
- USB LUN Setting
- Disc Burn
- Beep
- LCD Brightness
- Language Setting
- Calibration (HDR-CX200/CX210/PJ200)
- Battery Info
- Eco Mode
- Demo Mode
- Date & Time Setting
- Area Setting

[▲ Back to top](#)

Copyright 2012 Sony Corporation

- ▶ [Operation Search](#)
- ▶ [Before use](#)
- ▶ [Getting started](#)
- ▶ [Recording](#)
- ▶ [Playback](#)
- ▶ [Saving images with an external device](#)
- ▶ [Customizing your camcorder](#)
- ▶ [Troubleshooting](#)
- ▶ [Maintenance and precautions](#)

[⇒ Contents list](#)

Troubleshooting

If you have problems

[If you have problems](#)

Troubleshooting

[Overall operations](#)

[Batteries/power sources](#)

[LCD screen](#)

[Memory card](#)

[Recording](#)

[Playback](#)

[Playing back images stored on memory card on other devices](#)

[Editing movies/photos on your camcorder](#)

[Playback on the TV](#)

[Copying/Connecting to other devices](#)

[Connecting to a computer](#)

Self-diagnosis display/Warning indicators

[Self-diagnosis display](#)

[Warning Indicators](#)

[▲ Back to top](#)

- ▶ Operation Search
- ▶ Before use
- ▶ Getting started
- ▶ Recording
- ▶ Playback
- ▶ Saving images with an external device
- ▶ Customizing your camcorder
- ▶ Troubleshooting
- ▶ Maintenance and precautions

[⇒ Contents list](#)

Maintenance and precautions

Maintenance and precautions

- [About the AVCHD format](#)
- [About the memory card](#)
- [About the "InfoLITHIUM" battery pack](#)
- [About x.v.Color](#)
- [About the AC Adaptor](#)

About handling of your camcorder

- [On use and care](#)
- [On moisture condensation](#)
- [On adjustment of the touch panel \(HDR-CX200/CX210/PJ200\)](#)
- [On charging the pre-installed rechargeable battery](#)
- [Notes on disposal/transfer of the camcorder](#)

Recording time of movies/number of recordable photos

- [Charging time](#)
- [Expected time of recording and playback with each battery pack](#)
- [Expected recording time of movies](#)

Using your camcorder abroad

- [Using your camcorder abroad](#)

On trademarks

- [On trademarks](#)

[▲ Back to top](#)

- ▶ [Operation Search](#)
- ▶ [Before use](#)
- ▶ [Getting started](#)
- ▶ [Recording](#)
- ▶ [Playback](#)
- ▶ [Saving images with an external device](#)
- ▶ [Customizing your camcorder](#)
- ▶ [Troubleshooting](#)
- ▶ [Maintenance and precautions](#)

[⇒ Contents list](#)

Contents list

Operation Search

Operation Search

[Search by operation](#)

[▲ Back to top](#)

Before use

How to use this User Guide

[How to use this User Guide](#)

[Models and illustrations used in this User Guide](#)

Parts and controls/Screen indicators

[Parts and controls](#)

[Screen indicators](#)

Operating your camcorder

[Selecting items on the LCD screen](#)

[▲ Back to top](#)

Getting started

Checking the supplied items

[Supplied items](#)

Charging the battery pack

[Charging the battery using the AC Adaptor](#)

[Charging the battery using your computer](#)

[Charging the battery abroad](#)

Turning the power on, and setting the date and time

[Turning the power on, and setting the date and time](#)

Preparing the recording media

[Selecting a recording medium \(HDR-CX210\)](#)

[Inserting a memory card](#)

[▲ Back to top](#)

Recording

Recording

[Recording movies](#)

[Shooting photos](#)

Useful functions for recording images

[Zooming](#)

Playback

Playback

[Playing movies and photos from the Event View screen](#)

[Operating buttons while playing](#)

[Dividing a movie](#)

[Capturing a photo from a movie](#)

Highlight Playback

[Enjoying a digest of your movies \(Highlight Playback\)](#)

[Saving Highlight Playback in high definition image quality \(HD\) \(Scenario Save\)](#)

[Converting Highlight Playback scenes or Highlight Scenarios to standard definition image quality \(STD\) \(Highlight Movie\)](#)

Using the built-in projector

[Using the built-in projector \(HDR-PJ200\)](#)

Playing images on a TV

[Connecting the camcorder to a high definition TV](#)

[Connecting the camcorder to a non-high-definition TV](#)

[Connecting the camcorder to a TV via a VCR](#)

[Using "BRAVIA" Sync](#)

Saving images with an external device

Using the "PlayMemories Home" software

[Starting the "PlayMemories Home" software](#)

Selecting a method for saving images

[Disc creation guide](#)

[Types of media devices on which the images can be saved](#)

[The devices on which the created disc can be played back](#)

Saving images on an external media device

[Saving images on an external media device easily](#)

[Saving the desired images in the camcorder to the external media device](#)

[Playing back images in the external media device on the camcorder](#)

[Devices that cannot be used as an external media device](#)

Creating a disc with the DVD writer, DVDirect Express

[Creating a disc with DVDirect Express](#)

[Performing \[DISC BURN OPTION\]](#)

[Playing back a disc on the DVDirect Express](#)

Creating a disc with a DVD writer other than DVDirect Express

[Creating a high definition image quality \(HD\) disc with a DVD writer](#)

Creating a disc with a recorder

[Creating a standard definition image quality \(STD\) disc with a recorder, etc.](#)

Customizing your camcorder

Using menu items

- Setting up menu items

Shooting Mode

- Movie

- Photo

Camera/Mic

- White Balance

- Spot Meter/Fcs (Spot meter/focus) (HDR-CX200/CX210/PJ200)

- Spot Meter (Flexible spot meter) (HDR-CX200/CX210/PJ200)

- Spot Focus (HDR-CX200/CX210/PJ200)

- Exposure

- Focus

- Low Lux

- Scene Selection

- Fader

- Self-Timer

- Tele Macro

- SteadyShot (movie)

- Digital Zoom

- Auto Back Light

- Face Detection

- Smile Shutter

- Smile Sensitivity

- Blt-in Zoom Mic

- Wind Noise Reduct.

- Micref Level (Microphone reference level)

- My Button

- Guide Frame

- Display Setting

Image Quality/Size

- REC Mode

- HD/STD Setting

- Wide Mode

- x.v.Color

- Image Size

Playback Function

- Event View

- Highlight Movie

- Scenario

Edit/Copy

- Delete

- Protect

- Copy (HDR-CX210)

- Direct Copy

Setup

- Media Select (HDR-CX210)
- Media Info
- Format
- Repair Img. DB F.
- File Number
- Data Code
- Volume
- Download Music
- Empty Music
- TV Type
- HDMI Resolution
- CTRL FOR HDMI (Control for HDMI)
- USB Connect
- USB Connect Setting
- USB LUN Setting
- Disc Burn
- Beep
- LCD Brightness
- Language Setting
- Calibration (HDR-CX200/CX210/PJ200)
- Battery Info
- Eco Mode
- Demo Mode
- Date & Time Setting
- Area Setting

[▲ Back to top](#)

| Troubleshooting

If you have problems

[If you have problems](#)

Troubleshooting

[Overall operations](#)

[Batteries/power sources](#)

[LCD screen](#)

[Memory card](#)

[Recording](#)

[Playback](#)

[Playing back images stored on memory card on other devices](#)

[Editing movies/photos on your camcorder](#)

[Playback on the TV](#)

[Copying/Connecting to other devices](#)

[Connecting to a computer](#)

Self-diagnosis display/Warning indicators

[Self-diagnosis display](#)

[Warning Indicators](#)

[▲ Back to top](#)

■ Maintenance and precautions

Maintenance and precautions

[About the AVCHD format](#)

[About the memory card](#)

[About the “InfoLITHIUM” battery pack](#)

[About x.v.Color](#)

[About the AC Adaptor](#)

About handling of your camcorder

[On use and care](#)

[On moisture condensation](#)

[On adjustment of the touch panel \(HDR-CX200/CX210/PJ200\)](#)

[On charging the pre-installed rechargeable battery](#)

[Notes on disposal/transfer of the camcorder](#)

Recording time of movies/number of recordable photos

[Charging time](#)

[Expected time of recording and playback with each battery pack](#)

[Expected recording time of movies](#)

Using your camcorder abroad

[Using your camcorder abroad](#)

On trademarks

[On trademarks](#)

[▲ Back to top](#)

Copyright 2012 Sony Corporation

▶ [Operation Search](#)

▶ [Before use](#)

▶ [Getting started](#)

▶ [Recording](#)

▶ [Playback](#)

▶ [Saving images with an external device](#)

▶ [Customizing your camcorder](#)

▶ [Troubleshooting](#)

▶ [Maintenance and precautions](#)

[⇒ Contents list](#)

Search by operation

Setting the date and time

[Date & Time Setting](#)

[Area Setting](#)

Checking the name of parts and controls

[Parts and controls](#)

Identifying part names

[Parts and controls](#)

Displaying the data code

[Data Code](#)

Selecting the suitable setting automatically for the recording situation

[Intelligent Auto](#)

Recording people clearly

[Face Detection](#)

[Recording the selected subject clearly \(Face Priority\) \(HDR-CX200/CX210/PJ200\)](#)

[Smile Shutter](#)

[Scene Selection \(Portrait\)](#)

[Scene Selection \(Spotlight\)](#)

Recording images with the selected image quality

[REC Mode](#)

[HD/STD Setting](#)

[Wide Mode](#)

[Image Size](#)

Recording images without blurring

[SteadyShot \(movie\)](#)

Adjusting the focus

[Spot Focus \(HDR-CX200/CX210/PJ200\)](#)

Tracking focus: [Recording the selected subject clearly \(Face Priority\) \(HDR-CX200/CX210/PJ200\)](#)

[Focus](#)

Recording movies in a dim place

[Low Lux](#)

[Scene Selection \(Night Scene\)](#)

Recording sound clearly

[Wind Noise Reduct.](#)

[Bit-in Zoom Mic](#)

[Micref Level \(Microphone reference level\)](#)

Capturing photos during movie recording

Recording high quality photos during movie recording (Dual capture): [Recording movies](#)

[Smile Shutter](#)

Recording sunset or fireworks beautifully

[Scene Selection \(Fireworks\)](#)

[Scene Selection \(Sunrise&Sunset\)](#)

Selecting a recording medium

[Media Select \(HDR-CX210\)](#)

Saving battery power

[Eco Mode](#)

Playing movies and photos from an event

[Event View](#)

Enjoying a digest of your movies

[Enjoying a digest of your movies \(Highlight Playback\)](#)

Using the built-in projector

[Using the built-in projector \(HDR-PJ200\)](#)

Playing images on a TV

[Connecting the camcorder to a high definition TV](#)

[Connecting the camcorder to a non-high-definition TV](#)

Editing movies and photos

[Capturing a photo from a movie](#)

[Dividing a movie](#)

[Delete](#)

Saving images with an external device

[Saving images on an external media device easily](#)

Creating a disc

[Creating a disc with DVDirect Express](#)

[Creating a high definition image quality \(HD\) disc with a DVD writer](#)

[Creating a standard definition image quality \(STD\) disc with a recorder, etc.](#)

[▲ Back to top](#)

Copyright 2012 Sony Corporation

- ▶ Operation Search
- ▶ **Before use**
- ▶ Getting started
- ▶ Recording
- ▶ Playback
- ▶ Saving images with an external device
- ▶ Customizing your camcorder
- ▶ Troubleshooting
- ▶ Maintenance and precautions

[⇒ Contents list](#)

How to use this User Guide

- ▼ [Selecting a topic to display](#)
- ▼ [Searching a topic by keyword](#)
- ▼ [Returning to a previous page](#)
- ▼ [Printing out a page](#)
- ▼ [Marks and notations used in this User Guide](#)

This User Guide explains how to use each function of the camcorder, how to change settings, and how to troubleshoot a problem.

Selecting a topic to display

The following illustrations take Internet Explorer 7 as an example.

1. Click a title in the side bar on the left of the browser window.
A list of topic titles appears in the right pane.
2. Click a topic title in the list.

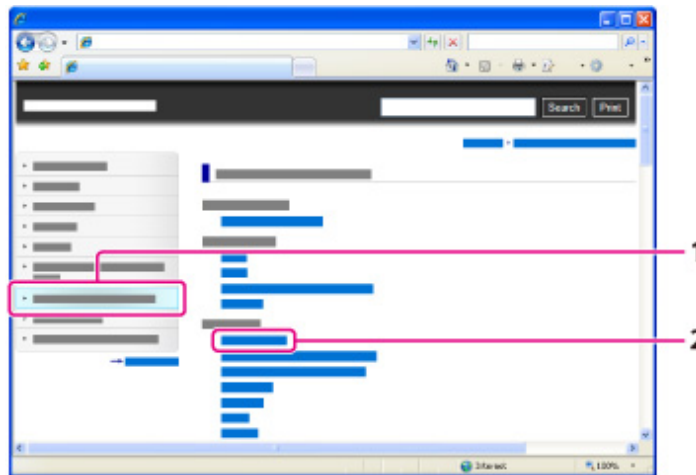

Descriptions appear in the right pane.

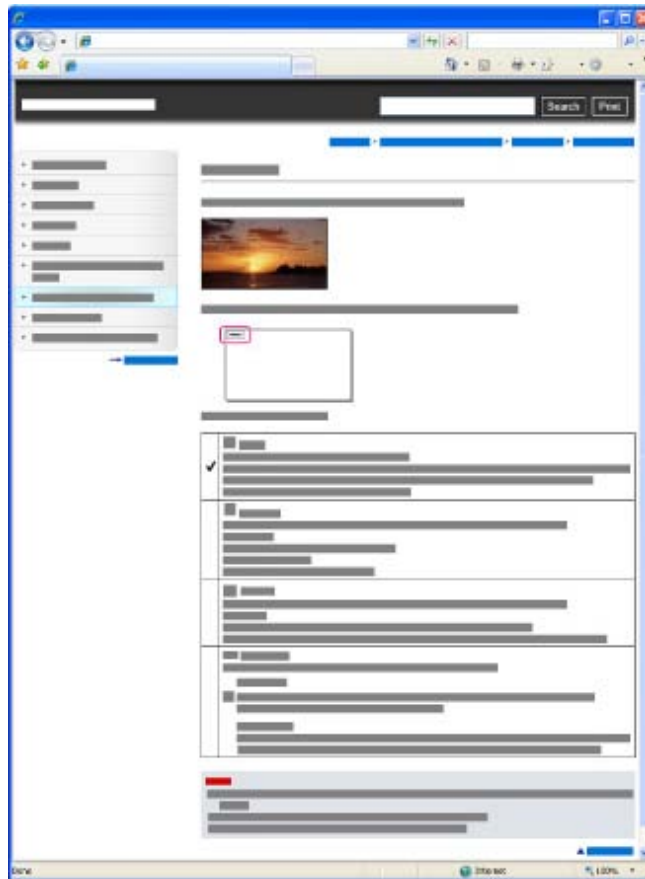

Changing the font size

Change the font size by changing the setting of your web browser. For how to change the font size setting, refer to the Help of your web browser.

Searching a topic by keyword

Enter the keyword in the search window, then click the [Search] button.

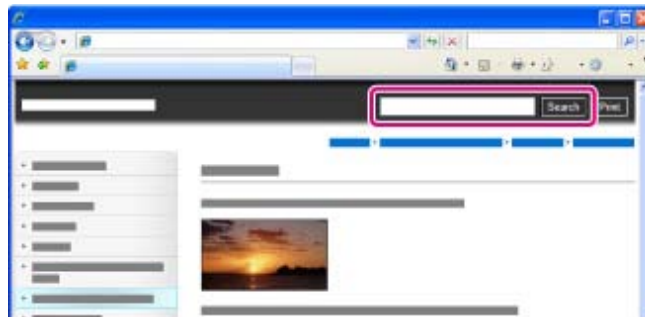

Returning to a previous page

Use the back button of your web browser or the breadcrumb trail navigation (A) to return to a page you previously viewed.

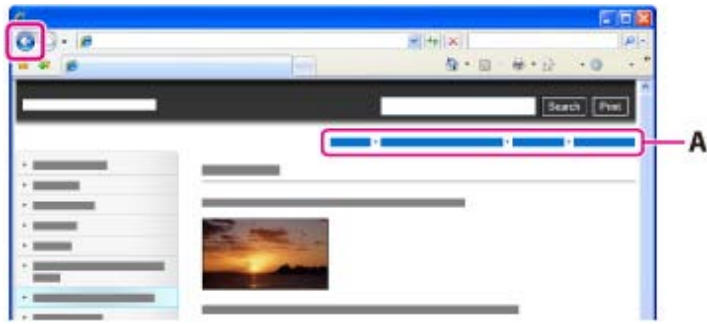

Printing out a page

Click the [Print] button to print out a page you are viewing.



Marks and notations used in this User Guide

In this User Guide, the sequence of operations is shown by arrows (→) (A).

Operate the camcorder in the order indicated.

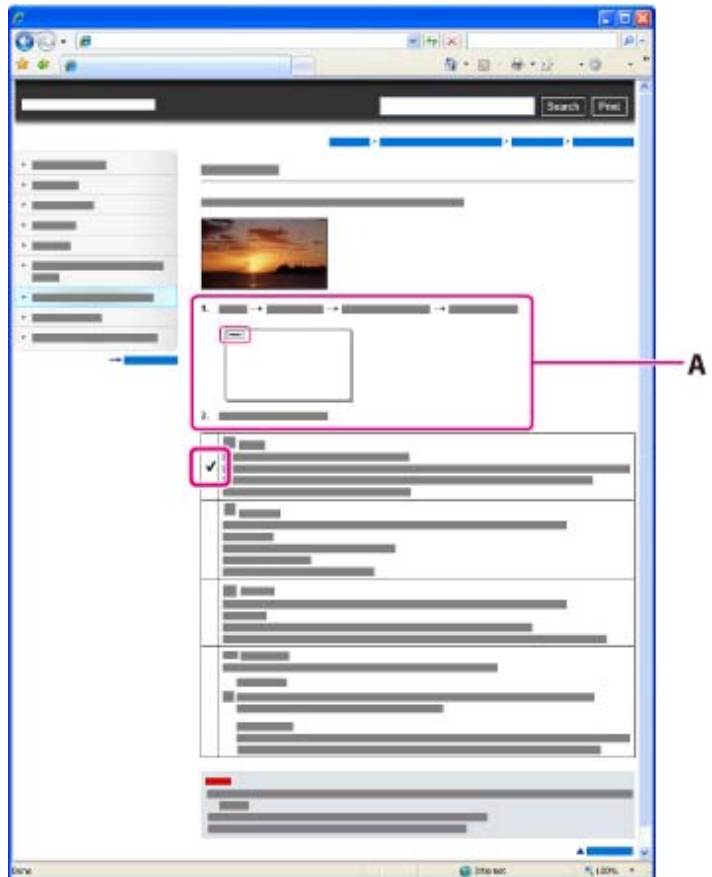

- Icons in the operating procedure sentences appear when the camcorder is in its default settings.
- The default setting is indicated by ✓.

[▲ Back to top](#)

Copyright 2012 Sony Corporation

- ▶ Operation Search
- ▶ Before use
- ▶ Getting started
- ▶ Recording
- ▶ Playback
- ▶ Saving images with an external device
- ▶ Customizing your camcorder
- ▶ Troubleshooting
- ▶ Maintenance and precautions

[⇒ Contents list](#)

[Top page](#) > [Before use](#) > [How to use this User Guide](#) > [Models and illustrations used in this User Guide](#)

Models and illustrations used in this User Guide

Models described in this User Guide

Models described in this User Guide are as follows.
HDR-CX190/CX200/CX210/PJ200

Difference of each model are as follows.

	Recording media	Capacity of internal recording media	Projector
HDR-CX190	Memory card only	—	—
HDR-CX200	Memory card only	—	—
HDR-CX210	Internal memory + memory card	8 GB	—
HDR-PJ200	Memory card only	—	✓

Illustrations and on-screen displays used in this User Guide

- The example images used in this User Guide for illustration purposes are captured using a digital still camera, and therefore may appear different from images and screen indicators that actually appear on your camcorder.
And, the illustrations of your camcorder and its screen indication are exaggerated or simplified for understandability.
- Illustrations used in this manual are based on HDR-CX210 unless otherwise specified.

[▲ Back to top](#)

Copyright 2012 Sony Corporation

- ▶ Operation Search
- ▶ **Before use**
- ▶ Getting started
- ▶ Recording
- ▶ Playback
- ▶ Saving images with an external device
- ▶ Customizing your camcorder
- ▶ Troubleshooting
- ▶ Maintenance and precautions

[→ Contents list](#)

Parts and controls

▼ To fasten the grip belt

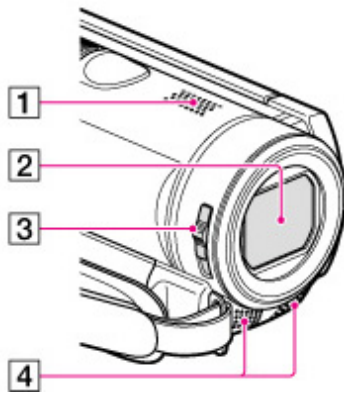

- 1** Speaker
- 2** Lens (Carl Zeiss lens)
- 3** LENS COVER switch
- 4** Built-in microphone

HDR-CX190

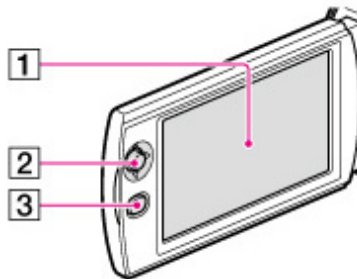

HDR-CX200/CX210

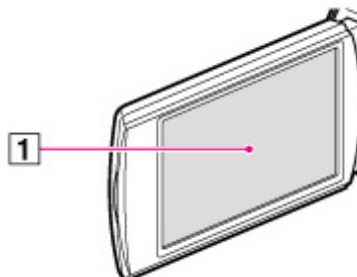

HDR-PJ200

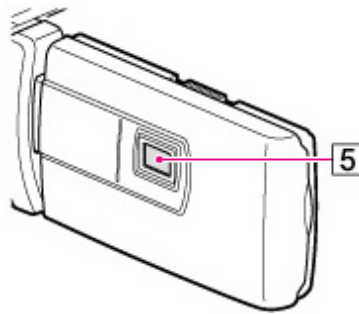
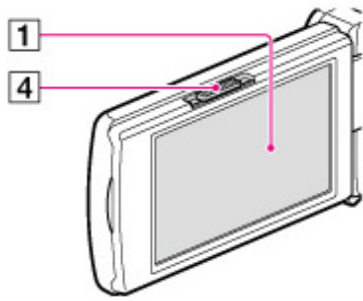

- 1** LCD screen/Touch panel (HDR-CX200/CX210/PJ200)
If you rotate the LCD panel 180 degrees, you can close the LCD panel with the LCD screen facing out. This is convenient during playback operations.
- 2** Multi selector (HDR-CX190)
- 3**  (View Images) button (HDR-CX190)
- 4** PROJECTOR FOCUS lever (HDR-PJ200)
- 5** Projector lens (HDR-PJ200)

HDR-CX190

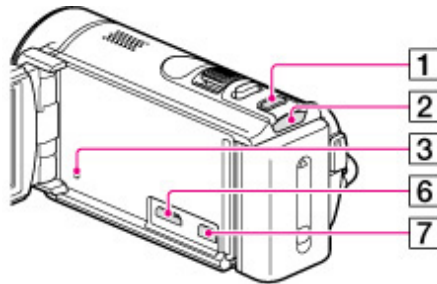

HDR-CX200/CX210

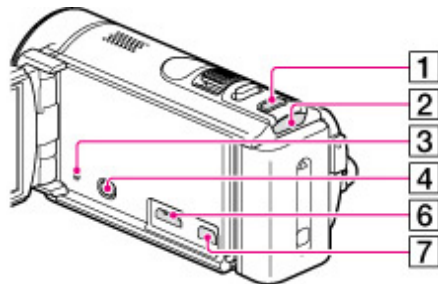

HDR-PJ200

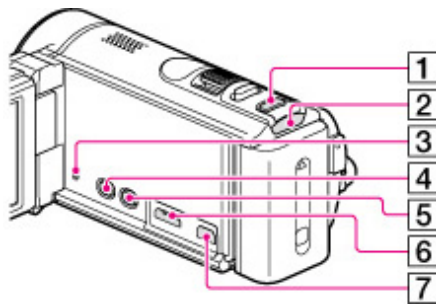

- 1** MODE button
- 2** (Movie)/ (Photo) lamp
- 3** RESET button
Press RESET using a pointed object.
Press RESET to initialize all the settings including the clock setting.
- 4** (View Images) button (HDR-CX200/CX210/PJ200)
- 5** PROJECTOR button (HDR-PJ200)
- 6** HDMI OUT jack
- 7** (USB) jack

HDR-CX190

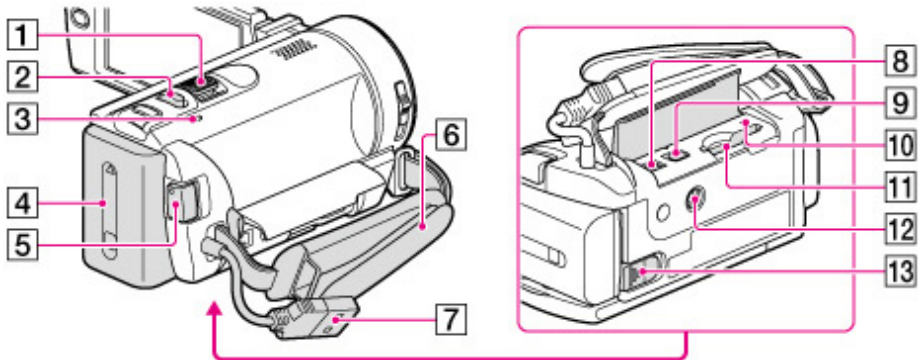

HDR-CX200/CX210/PJ200

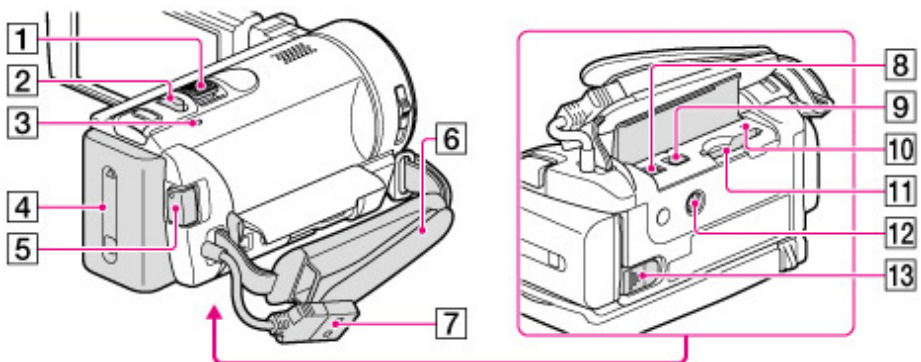

- 1** Power zoom lever
- 2** PHOTO button
- 3** CHG (charge) lamp
- 4** Battery pack
- 5**

START/STOP button

- 6** Grip belt
- 7** Built-in USB Cable
- 8** DC IN jack
- 9** A/V Remote Connector
- 10** Memory card access lamp
- 11** Memory card slot
- 12** Tripod receptacle
Attach a tripod (sold separately: the length of the screw must be less than 5.5 mm (7/32 in.))
- 13** BATT (battery) release lever

I To fasten the grip belt

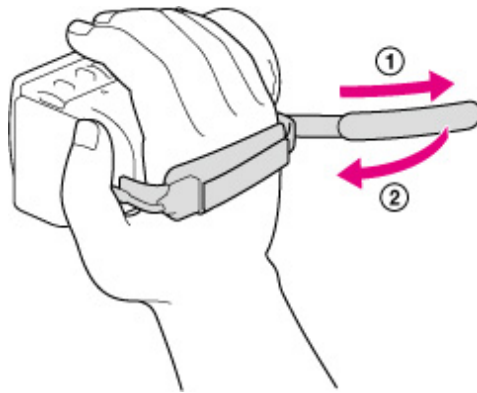

[▲ Back to top](#)

Copyright 2012 Sony Corporation

- ▶ Operation Search
- ▶ Before use
- ▶ Getting started
- ▶ Recording
- ▶ Playback
- ▶ Saving images with an external device
- ▶ Customizing your camcorder
- ▶ Troubleshooting
- ▶ Maintenance and precautions

[➔ Contents list](#)

Screen indicators

- ▼ Left 1
- ▼ Center 2
- ▼ Right 3
- ▼ Bottom 4

The following indicators appear when you change the settings.
Check also for the indicators that appear during recording or playing.

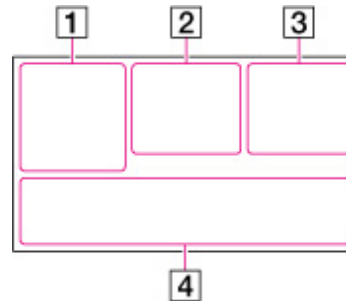







Left 1

Indicator	Meaning
	MENU button
	Self-timer recording
	Wide Mode
	Fader
	[Face Detection] set to [Off]
	[Smile Shutter] set to [Off]
	Manual focus
	Scene Selection
	White Balance
	SteadyShot off
	Tele Macro
	x.v.Color
	Destination
	Intelligent Auto (face detection/scene detection/camera-shake)



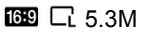



Center 2

Indicator	Meaning
	Slideshow Set
	Warning
	Playback mode

Right 3

Indicator	Meaning
	Recording image quality (HD/STD), frame rate (60i) and recording mode (FX/FH/HQ/LP)
60min 	Remaining battery
	Recording/playback/editing media
0:00:00	Counter (hour:minute:second)
00min	Estimated recording remaining time
	Photo size
9999  9999 	Approximate number of recordable photos and photo size
	Playback folder
100/112	Current playing movie or photo/Number of total recorded movies or photos
	Connection to the external media device

Bottom 4

Indicator	Meaning
	Micref Level low
	Wind Noise Reduct.
	Bit-in Zoom Mic
	Low Lux
	Spot Meter/Fcs/Spot Meter/Exposure
	Intelligent Auto
 101-0005	Data file name
	Protected image

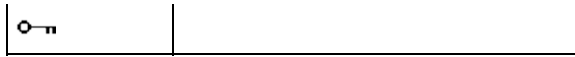

- Indicators and their positions are approximate and may differ from what you actually see.
- Some indicators may not appear, depending on your camcorder model.

[▲ Back to top](#)

Copyright 2012 Sony Corporation

- ▶ Operation Search
- ▶ Before use
- ▶ Getting started
- ▶ Recording
- ▶ Playback
- ▶ Saving images with an external device
- ▶ Customizing your camcorder
- ▶ Troubleshooting
- ▶ Maintenance and precautions

[➡ Contents list](#)

Selecting items on the LCD screen

HDR-CX190

1. Move the multi-selector towards ▼ / ▲ / ◀ / ▶ to select the desired item.
2. Press the center of the multi-selector to complete the selection.

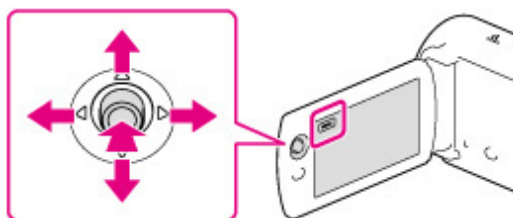

HDR-CX200/CX210/PJ200

1. Touch the desired part of the LCD screen.

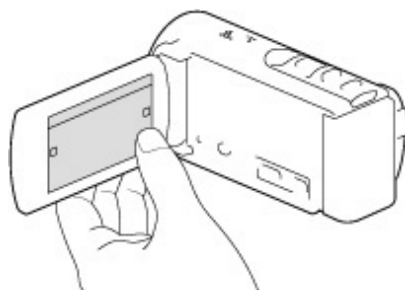

[▲ Back to top](#)

- ▶ Operation Search
- ▶ Before use
- ▶ Getting started
- ▶ Recording
- ▶ Playback
- ▶ Saving images with an external device
- ▶ Customizing your camcorder
- ▶ Troubleshooting
- ▶ Maintenance and precautions

[→ Contents list](#)

Supplied items

The numbers in () are the supplied quantity.

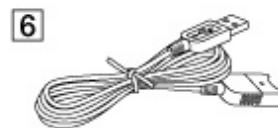
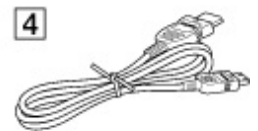
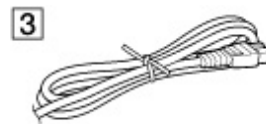

- 1** Camcorder (1)
- 2** AC Adaptor (1)
- 3** Power cord (mains lead) (1)
- 4** HDMI cable (1) (only for HDR-CX200/CX210/PJ200)
- 5** A/V connecting cable (1)
- 6** USB connection support cable (1)

- The USB connection support cable is designed for use with this camcorder only. Use this cable when the Built-in USB Cable of the camcorder is too short for connection.

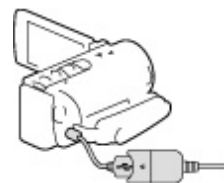

- 7** Rechargeable battery pack NP-FV30 (1)
- 8** "Operating Guide" (1)

Notes

- The "PlayMemories Home" (Lite Version) software and "PlayMemories Home" Help Guide are pre-installed in this camcorder.

[▲ Back to top](#)

- ▶ Operation Search
- ▶ Before use
- ▶ Getting started
- ▶ Recording
- ▶ Playback
- ▶ Saving images with an external device
- ▶ Customizing your camcorder
- ▶ Troubleshooting
- ▶ Maintenance and precautions

[→ Contents list](#)

Charging the battery using the AC Adaptor

- ▼ Charging time
- ▼ To remove the battery pack
- ▼ To use a wall outlet (wall socket) as a power source
- ▼ Notes on the battery pack
- ▼ Notes on the AC Adaptor

1. Close the LCD screen and attach the battery pack (①).

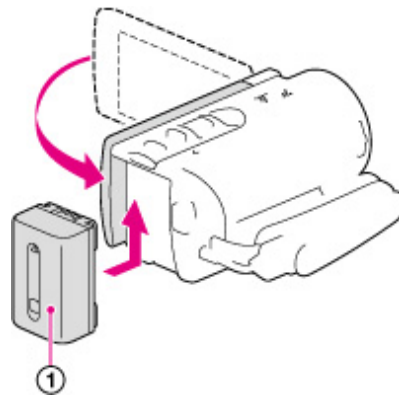

2. Connect the AC Adaptor (①) and the power cord (mains lead) (②) to your camcorder and the wall outlet (wall socket) (③).

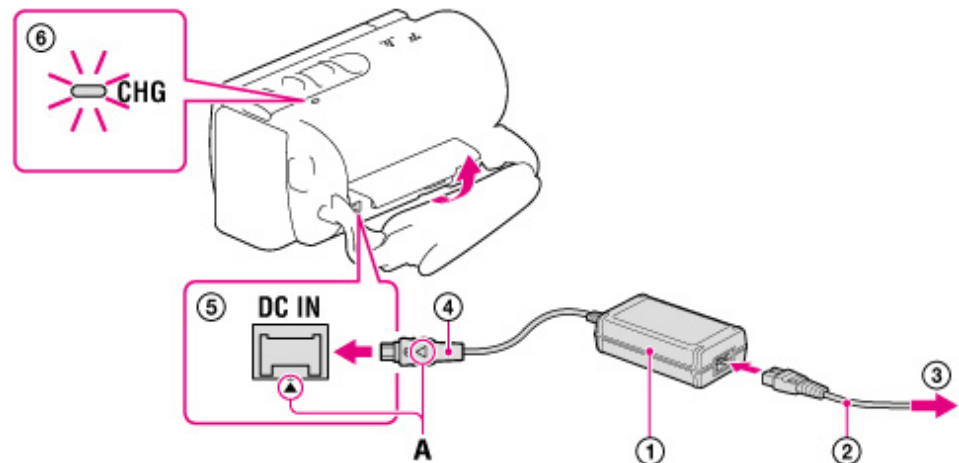

A: Align the ▲ mark on the DC plug (④) with that of DC IN jack (⑤).

- The CHG (charge) lamp (⑥) turns on.
- The CHG (charge) lamp turns off when the battery pack is fully charged. Disconnect the AC Adaptor from the DC IN jack of your camcorder.

Notes

- You cannot attach any "InfoLITHIUM" battery pack other than the V series to your camcorder.

Charging time

Approximate time (min.) required when you fully charge a fully discharged battery pack.

Battery pack	AC Adaptor
NP-FV30 (supplied)	115
NP-FV50	155
NP-FV70	195
NP-FV100	390

- The charging times shown in the table above are measured when charging the camcorder at a temperature of 25 °C (77 °F). It is recommended that you charge the battery in a temperature range of 10 °C to 30 °C (50 °F to 86 °F).

To remove the battery pack

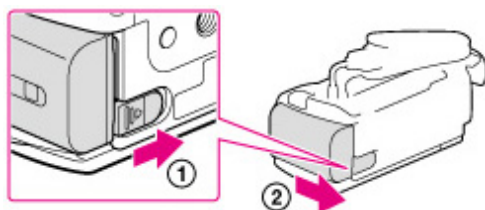

Close the LCD screen. Slide the BATT (battery) release lever (①) and remove the battery pack (②).



To use a wall outlet (wall socket) as a power source

Make the same connections as those for charging the battery pack.
Even if the battery pack is attached, the battery pack is not discharged.

Notes on the battery pack

- When you remove the battery pack or disconnect the AC Adaptor, turn the camcorder off and make sure that the  (Movie)/ (Photo) lamps, the access lamp are turned off.
- The CHG (charge) lamp flashes during charging under the following conditions.
 - The battery pack is not attached correctly.
 - The battery pack is damaged.
 - The temperature of the battery pack is low.
 - Remove the battery pack from your camcorder and put it in a warm place.
 - The temperature of the battery pack is high.
 - Remove the battery pack from your camcorder and put it in a cool place.
- In the default setting, the power turns off automatically if you leave your camcorder without any operation for about 2 minutes, to save battery power ([Eco Mode]).

Notes on the AC Adaptor

- Use the nearby wall outlet (wall socket) when using the AC Adaptor. Disconnect the AC Adaptor from the wall outlet (wall socket) immediately if any malfunction occurs while using your camcorder.
- Do not use the AC Adaptor placed in a narrow space, such as between a wall and furniture.
- Do not short-circuit the DC plug of the AC Adaptor or battery terminal with any metallic objects. This may cause a malfunction
- Disconnect the AC Adaptor from the camcorder, holding both the camcorder and the DC plug.

Related topics

[Expected time of recording and playback with each battery pack](#)

Remaining battery indicator: [Screen indicators](#)
Using your camcorder abroad
[Eco Mode]

[▲ Back to top](#)

Copyright 2012 Sony Corporation

- ▶ Operation Search
- ▶ Before use
- ▶ Getting started
- ▶ Recording
- ▶ Playback
- ▶ Saving images with an external device
- ▶ Customizing your camcorder
- ▶ Troubleshooting
- ▶ Maintenance and precautions

[➔ Contents list](#)

Charging the battery using your computer

- ▼ [To charge the battery from a wall outlet \(wall socket\) using the Built-in USB Cable](#)
- ▼ [Charging time](#)
- ▼ [To remove the battery pack](#)

1. Turn off your camcorder and connect the camcorder to a running computer using the Built-in USB Cable (①).
- ② : To the wall outlet (wall socket)

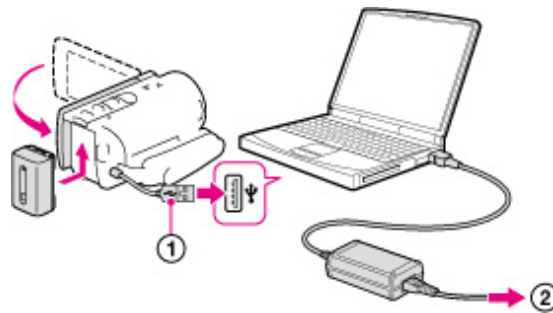

- The CHG (charge) lamp turns on.
- The CHG (charge) lamp turns off when the battery pack is fully charged. Disconnect Built-in USB Cable from your computer.

To charge the battery from a wall outlet (wall socket) using the Built-in USB Cable

You can charge the battery by connecting the Built-in USB Cable to a wall outlet (wall socket) using an AC-UD10 USB charger/AC Adaptor (sold separately). You cannot use a Sony CP-AH2R, CP-AL, or AC-UP100 portable power supply device (sold separately) to charge the camcorder.

Charging time

Approximate time (min.) required when you fully charge a fully discharged battery pack.

Battery pack	Built-in USB Cable*
NP-FV30 (supplied)	150
NP-FV50	280
NP-FV70	545
NP-FV100	1,000

- The charging times shown in the table above are measured when charging the camcorder at a temperature of 25 °C (77 °F). It is recommended that you charge the battery in a temperature range of 10 °C to 30 °C (50 °F to 86 °F).

* The charging times are measured without using the USB Connection support cable.

To remove the battery pack

Close the LCD screen. Slide the BATT (battery) release lever (①) and remove the battery pack (②).

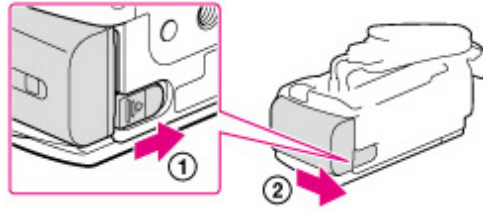

Related topics

[Charging the battery using the AC Adaptor](#)

[▲ Back to top](#)

Copyright 2012 Sony Corporation

▶ Operation Search

▶ Before use

▶ Getting started

▶ Recording

▶ Playback

▶ Saving images with an external device

▶ Customizing your camcorder

▶ Troubleshooting

▶ Maintenance and precautions

[⇒ Contents list](#)

Charging the battery abroad

You can charge the battery pack in any countries/regions using the AC Adaptor supplied with your camcorder within the AC 100 V – 240 V, 50 Hz/60 Hz range.

Notes

- Do not use an electronic voltage transformer.

Related topics

[Charging the battery using the AC Adaptor](#)

[▲ Back to top](#)

- ▶ Operation Search
- ▶ Before use
- ▶ Getting started
- ▶ Recording
- ▶ Playback
- ▶ Saving images with an external device
- ▶ Customizing your camcorder
- ▶ Troubleshooting
- ▶ Maintenance and precautions

[→ Contents list](#)

Top page > Getting started > Turning the power on, and setting the date and time > Turning the power on, and setting the date and time

Turning the power on, and setting the date and time

- ▼ To change the language setting
- ▼ To turn off the power
- ▼ To adjust the angle of the LCD screen

1. Open the LCD screen of your camcorder to turn the power on.

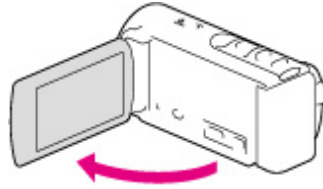

2. Select the desired language, then select [Next].

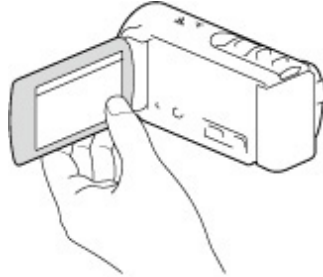

Touch the button on the LCD screen.

For HDR-CX190, select the button using the multi-selector.

3. Select the desired geographical area with ←/→, then select [Next].

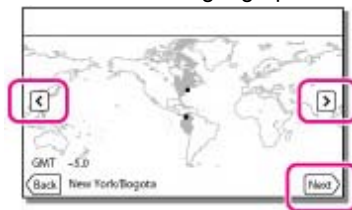

4. Set [Daylight Savings] or [Summer Time], select the date format and the date and time.

- If you set [Daylight Savings] or [Summer Time] to [On], the clock advances 1 hour.
- When you select the date and time, select one of the items and adjust the value with ↑/↓.
- When you select OK, the date and time setting operation is complete.

A: HDR-CX200/CX210/PJ200

B: HDR-CX190

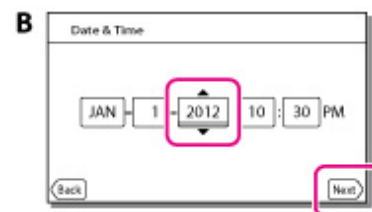
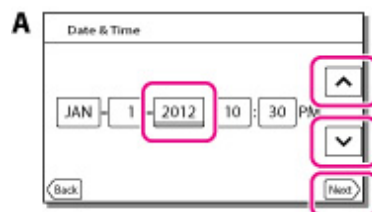

To change the language setting

You can change the on-screen displays to show messages in a specified language.

Select **MENU** → [Setup] → [General Settings] → [Language Setting] → a desired language.

To turn off the power

Close the LCD screen.

To adjust the angle of the LCD screen

First open the LCD panel 90 degrees to the camcorder (①), and then adjust the angle (②).

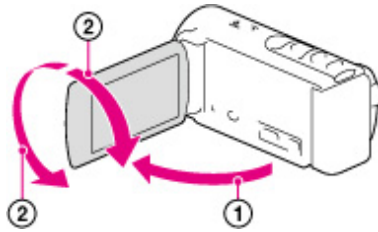

Notes

- The recording date, time and condition are recorded automatically on the recording media. They are not displayed during recording. However, you can check them as [Data Code] during playback. To display them, select **MENU** → [Setup] → [Playback Settings] → [Data Code] → [Date/Time].

Related topics

To set the date and time again: [Date & Time Setting]

To calibrate the touch panel: [Calibration (HDR-CX200/CX210/PJ200)]



[▲ Back to top](#)

- ▶ Operation Search
- ▶ Before use
- ▶ Getting started
- ▶ Recording
- ▶ Playback
- ▶ Saving images with an external device
- ▶ Customizing your camcorder
- ▶ Troubleshooting
- ▶ Maintenance and precautions

[⇒ Contents list](#)

Selecting a recording medium (HDR-CX210)

The recording media that can be used are displayed on the screen of your camcorder as following icons.

Default recording medium		Alternative recording medium	
	Internal memory		Memory card

You can select a recording medium from the menu.

1. Select **MENU** → [Setup] → [Media Settings] → [Media Select] → the desired medium.



Notes

- You cannot select a different recording medium for movies and for photos.

Related topics

[Screen indicators during recording](#)

[Expected recording time of movies](#)

[▲ Back to top](#)

- ▶ Operation Search
- ▶ Before use
- ▶ Getting started
- ▶ Recording
- ▶ Playback
- ▶ Saving images with an external device
- ▶ Customizing your camcorder
- ▶ Troubleshooting
- ▶ Maintenance and precautions

[➔ Contents list](#)

Inserting a memory card

- ▼ Types of memory card you can use with your camcorder
- ▼ To eject the memory card

1. Open the cover, and insert the memory card until it clicks.
 - The [Preparing image database file. Please wait.] screen appears if you insert a new memory card. Wait until the screen disappears.

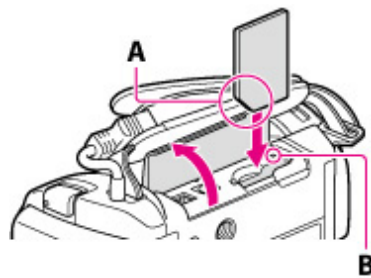

- A: Insert the card with the notched edge in the direction as illustrated
- B: Access lamp

Types of memory card you can use with your camcorder

		SD Speed Class	Capacity (operation verified)	Described in this manual
"Memory Stick PRO Duo" media (Mark2)		—	32 GB	"Memory Stick PRO Duo" media
"Memory Stick PRO-HG Duo" media				
SD memory card		Class 4 or faster	64 GB	SD card
SDHC memory card				
SDXC memory card				

- Operation with all memory cards is not assured.

Notes

- A MultiMediaCard cannot be used with this camcorder.
- Movies recorded on SDXC memory cards cannot be imported to or played back on computers or AV devices not supporting the exFAT* file system by connecting the camcorder to these devices with the USB cable. Confirm in advance that the connecting equipment is supporting the exFAT system. If you connect an equipment not supporting the exFAT system and the format screen appears, do not perform the format. All the data recorded will be lost.

* The exFAT is a file system that is used for SDXC memory cards.

■ To eject the memory card

Open the cover and lightly push the memory card in once.

Notes

- To ensure stable operation of the memory card, it is recommended to format the memory card with your camcorder before the first use. Formatting the memory card will erase all the data stored on it and the data will be irrecoverable. Save your important data on your PC, etc.
- If [Failed to create a new Image Database File. It may be possible that there is not enough free space.] is displayed, format the memory card.
- Confirm the direction of the memory card. If you forcibly insert the memory card in the wrong direction, the memory card, memory card slot, or image data may be damaged.
- When inserting or ejecting the memory card, be careful so that the memory card does not pop out and drop.

[▲ Back to top](#)

Copyright 2012 Sony Corporation

- ▶ Operation Search
- ▶ Before use
- ▶ Getting started
- ▶ Recording
- ▶ Playback
- ▶ Saving images with an external device
- ▶ Customizing your camcorder
- ▶ Troubleshooting
- ▶ Maintenance and precautions

[→ Contents list](#)

Recording movies

- ▼ To display items on the LCD screen
- ▼ Screen indicators during recording
- ▼ To record in mirror mode

In the default setting, movies and photos are recorded on the following media. Movies are recorded with high definition image quality (HD).

HDR-CX190/CX200/PJ200: Memory card

HDR-CX210: Internal recording media

1. Open the lens cover.

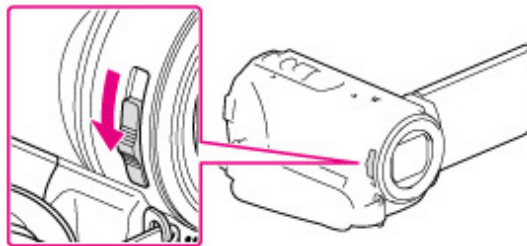

2. Open the LCD screen and press MODE to turn on the  (Movie) lamp.

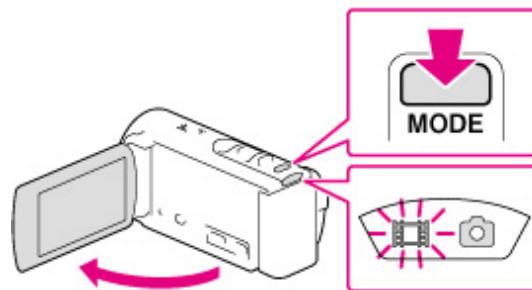

3. Press START/STOP to start recording.

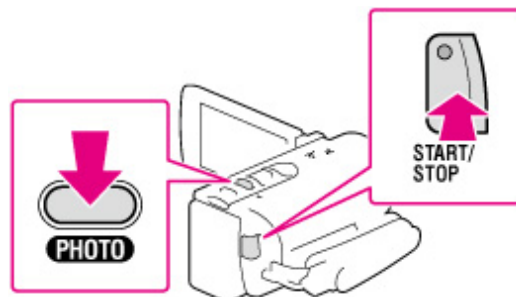

- To stop recording, press START/STOP again.
- You can record photos during movie recording by pressing PHOTO (Dual Capture).

▮ To display items on the LCD screen

Items on the LCD screen disappear if you do not operate the camcorder for a few seconds after you turn

the camcorder on or switch between the movie recording and photo shooting modes. To display the items again, do as follows.

HDR-CX190: Move the multi-selector.

HDR-CX200/CX210/PJ200: Touch anywhere except the buttons on the LCD screen.

Screen indicators during recording

Described here are icons for both movie recording and photo recording modes.

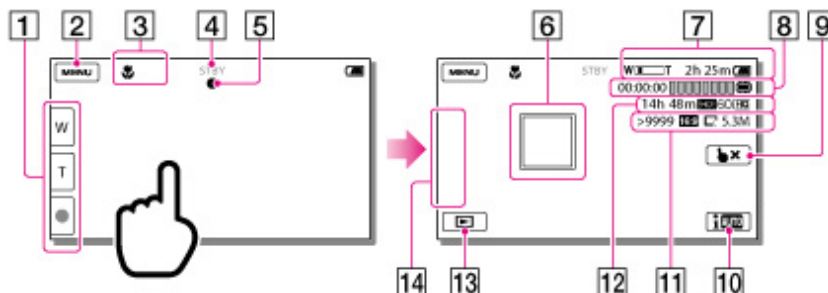

- 1** Zoom button (W: Wide/T: Telephoto), START/STOP button (in movie recording mode), PHOTO button (in photo recording mode)*¹
- 2** MENU button
- 3** Status detected by Intelligent Auto
- 4** Recording status ([STBY]/[REC])
- 5** AE/AF (automatic exposure/automatic focus) lock
- 6** Tracking focus*¹
- 7** Zoom, Remaining battery
- 8** Counter (hour: minute: second), Capturing a photo, Recording/playback/editing media*²
- 9** Tracking focus cancel button*¹
- 10** Intelligent Auto button
- 11** Approximate number of recordable photos, Aspect ratio (16:9 or 4:3), and photo size (L/S)
- 12** Estimated recording remaining time, Recording image quality (HD/STD), and recording mode (FX/FH/HQ/LP)
- 13** View Images button
- 14** My Button (you can assign your favorite functions to icons displayed in this area)

*¹ HDR-CX200/CX210/PJ200

*² HDR-CX210

To record in mirror mode

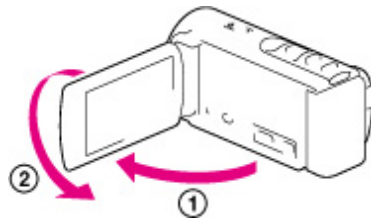

1. Open the LCD panel 90 degrees to the camcorder (①), then rotate it 180 degrees to the lens side (②).

A mirror-image of the subject appears on the LCD screen, but the image will be normal when recorded.

Notes

- If you close the LCD screen while recording movies, the camcorder stops recording.
- The maximum continuous recordable time of movies is about 13 hours.
- When a movie file exceeds 2 GB, the next movie file is created automatically.
- The following states will be indicated if data is still being written onto the recording media after recording has finished. During this time, do not apply shock or vibration to the camcorder, or remove the battery or AC Adaptor.
 - Access lamp is lit or flashing
 - The media icon in the upper right of the LCD screen is flashing
- The LCD screen of your camcorder can display recording images across the entire screen (full pixel display). However, this may cause slight trimming of the top, bottom, right, and left edges of images when played back on a TV which is not compatible with full pixel display. It is recommended you record images with [Guide Frame] set to [On] and using the outer frame of [Guide Frame] as a guide.

Related topics

[Expected recording time of movies](#)

[\[Media Select \(HDR-CX210\)\]](#)

To display items on the LCD screen all the time: [\[Display Setting\]](#)

To change the image size: [\[Image Size\]](#)

Recordable time, remaining capacity: [\[Media Info\]](#)

[Zooming](#)

[▲ Back to top](#)

Copyright 2012 Sony Corporation

- ▶ Operation Search
- ▶ Before use
- ▶ Getting started
- ▶ Recording
- ▶ Playback
- ▶ Saving images with an external device
- ▶ Customizing your camcorder
- ▶ Troubleshooting
- ▶ Maintenance and precautions

[➡ Contents list](#)

Shooting photos

In the default setting, movies and photos are recorded on the following media. Movies are recorded with high definition image quality (HD).

HDR-CX190/CX200/PJ200: Memory card

HDR-CX210: Internal recording media

1. Open the LCD screen and press MODE to turn on the  (Photo) lamp.

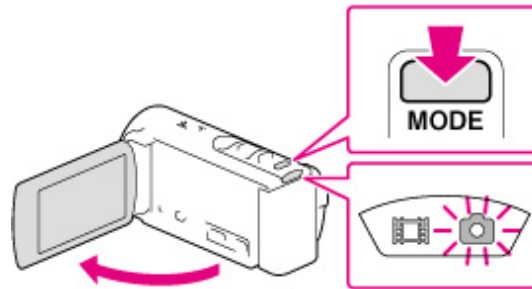

2. Press PHOTO lightly to adjust the focus, then press it fully.

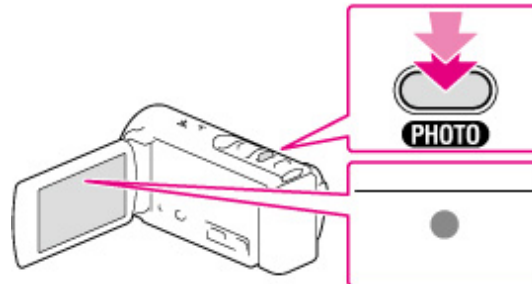

- When the focus is adjusted properly, AE/AF lock indicator appears on the LCD screen.

Related topics

[Screen indicators during recording](#)

[Zooming](#)

[▲ Back to top](#)

[▶ Operation Search](#)[▶ Before use](#)[▶ Getting started](#)[▶ Recording](#)[▶ Playback](#)[▶ Saving images with an external device](#)[▶ Customizing your camcorder](#)[▶ Troubleshooting](#)[▶ Maintenance and precautions](#)[➔ Contents list](#)

Zooming

▼ To magnify images further (Extended Zoom)

1. Move the power zoom lever to magnify or reduce the size of the image.

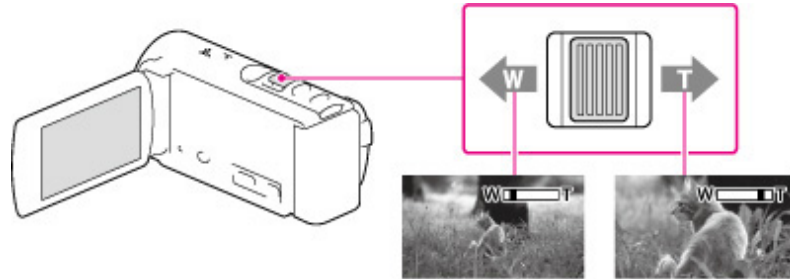

W: Wider range of view (Wide angle)

T: Close view (Telephoto)

- You can magnify images using optical zooming up to 25 times the original size with the default setting.
- Move the power zoom lever slightly for a slower zoom. Move it further for a faster zoom.

▶ To magnify images further (Extended Zoom)

1. Set [SteadyShot] to [Standard] or [Off].
- You can magnify images up to 30 times the original size by extending the wide angle.

Notes

- Be sure to keep your finger on the power zoom lever. If you move your finger off the power zoom lever, the operation sound of the power zoom lever may also be recorded.
- You cannot change the zoom speed with the button on the LCD screen (HDR-CX200/CX210/PJ200).
- The minimum possible distance between camcorder and subject while maintaining sharp focus is about 1 cm (about 13/32 in.) for wide angle and about 80 cm (about 31 1/2 in.) for telephoto.

Related topics

Further zooming: [\[Digital Zoom\]](#)

[▲ Back to top](#)



Copyright 2012 Sony Corporation

- ▶ Operation Search
- ▶ Before use
- ▶ Getting started
- ▶ Recording
- ▶ Playback
- ▶ Saving images with an external device
- ▶ Customizing your camcorder
- ▶ Troubleshooting
- ▶ Maintenance and precautions

[⇒ Contents list](#)

Intelligent Auto



Your camcorder records movies after selecting the most suitable setting for the subjects or the situation automatically. ([On] is the default setting.) When the camcorder detects a subject, the icons that correspond to the detected conditions are displayed.

1. Select  → [On] →  at the right bottom of the recording screen of movies or photos.









Face detection:

The camcorder detects faces, and adjusts the focus, color and exposure.

 (Portrait),  (Baby)

Scene detection:

The camcorder selects the most effective setting automatically, depending on the scene.

 (Backlight),  (Landscape),  (Night Scene),  (Spotlight),  (Low light),  (Macro)



Camera-shake detection:

The camcorder detects whether camera-shake occurs or not, and makes the optimum compensation.

 (Tripod)

To cancel the Intelligent Auto function, select  → [Off].

I To record images brighter than that of when using the Intelligent Auto function

Select  → [Camera/Mic] →  [Manual Settings] → [Low Lux].

Notes

- The camcorder may not detect the expected scene or subject, depending on the recording conditions.

[▲ Back to top](#)

- ▶ Operation Search
- ▶ Before use
- ▶ Getting started
- ▶ Recording
- ▶ Playback
- ▶ Saving images with an external device
- ▶ Customizing your camcorder
- ▶ Troubleshooting
- ▶ Maintenance and precautions

[➡ Contents list](#)

[Top page](#) > [Recording](#) > [Useful functions for recording images](#) > [Recording the selected subject clearly \(Face Priority\) \(HDR-CX200/CX210/PJ200\)](#)

Recording the selected subject clearly (Face Priority) (HDR-CX200/CX210/PJ200)

▼ To record subjects other than people (Tracking focus)

Your camcorder can track a face you select and adjust the focus, exposure, and skin tone of the face automatically.

1. Touch one of the faces targeted.



- A: The double-lined frame is displayed.
 B: You can release the selection.

Notes

- The subject you touched may not be detected, depending on the surrounding brightness or hairstyle of the subject.
- Make sure to set the [Face Detection] setting to other than [Off] ([Auto] is the default setting).

▶ To record subjects other than people (Tracking focus)

Touch the subject you want to record.
 Your camcorder adjusts the focus automatically.

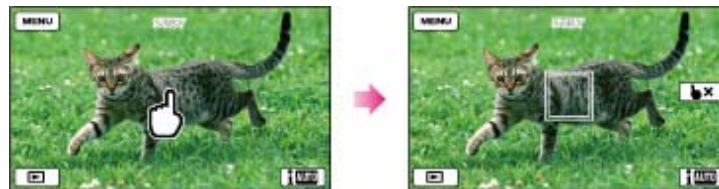

[▲ Back to top](#)

- ▶ Operation Search
- ▶ Before use
- ▶ Getting started
- ▶ Recording
- ▶ Playback
- ▶ Saving images with an external device
- ▶ Customizing your camcorder
- ▶ Troubleshooting
- ▶ Maintenance and precautions

[➔ Contents list](#)

Playing movies and photos from the Event View screen

▼ Screen display on the Event View screen

You can search for recorded images by date and time of recording (Event view).

1. Open the LCD screen and press the  button on the camcorder to enter the playback mode.

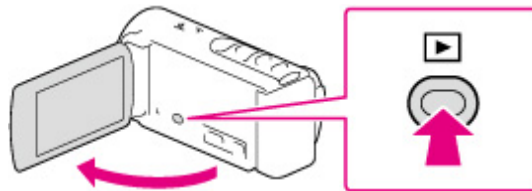

HDR-CX200/CX210/PJ200

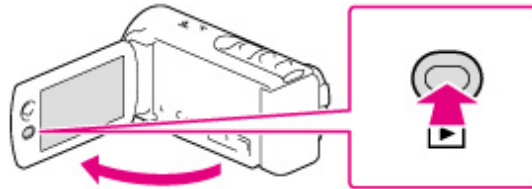

HDR-CX190



- You can enter the playback mode by selecting  on the LCD screen. [\[Details\]](#)

2. Select   to move the desired event to the center (①) and then select it (②).

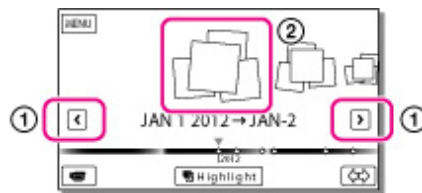

- The camcorder displays recorded images as an event automatically, based on the date and time.

3. Select the image.



- The camcorder plays from the selected image to the last image in the event.

Screen display on the Event View screen

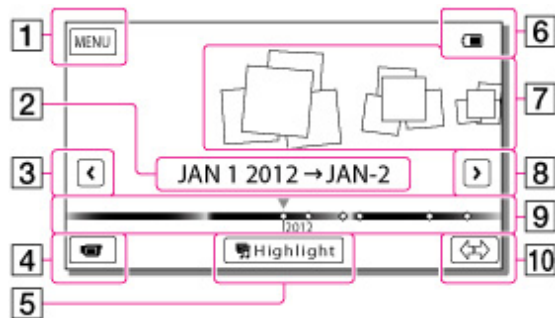

- 1** : To the MENU screen
- 2** : Event name
- 3** : To the previous event
- 4** : Change to the movie/photo recording mode
- 5** : To play back short movies
- 6** : Remaining battery
- 7** : Events
- 8** : To the next event
- 9** : Time-line bar
- 10** : Change Event Scale button

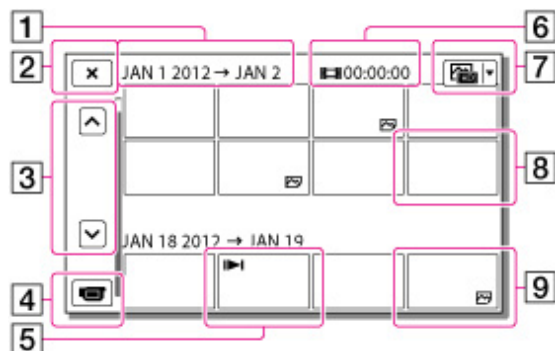

- 1** : Event title
 - 2** : To go back to the Event View screen
 - 3** : Previous/next
 - 4** : Change to the movie/photo recording mode
 - 5** : Last played image
 - 6** : Recorded time/number of photos
 - 7** : Switch image type button
 - 8** : Movie
 - 9** : Photo
- Reduced-size images which enable you to view many images at the same time on an index screen are called “thumbnails.”

Notes

- To prevent your image data from being lost, save all your recorded images on external media periodically.
- In the default setting, a protected demonstration movie is pre-recorded. (HDR-CX210)

[▲ Back to top](#)

- ▶ Operation Search
- ▶ Before use
- ▶ Getting started
- ▶ Recording
- ▶ Playback
- ▶ Saving images with an external device
- ▶ Customizing your camcorder
- ▶ Troubleshooting
- ▶ Maintenance and precautions

[⇒ Contents list](#)

Operating buttons while playing

- ▼ [While playing a movie](#)
- ▼ [While viewing photos](#)
- ▼ [To play back images with other devices](#)

Items on the LCD screen disappear if you do not operate the camcorder for a few seconds. To display the items again, do as follows.

HDR-CX190: Move the multi-selector.
 HDR-CX200/CX210/PJ200: Touch the LCD screen.

While playing a movie

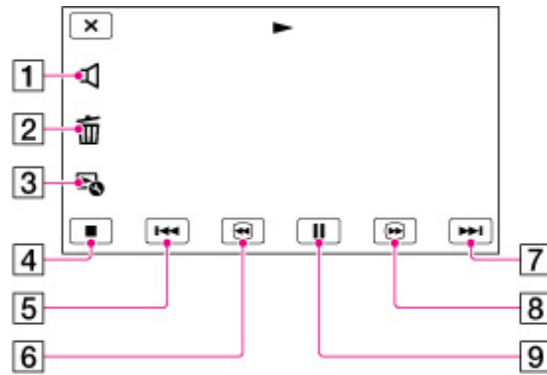

- 1** : Volume
- 2** : Delete
- 3** : Context
- 4** : To stop
- 5** : Previous
- 6** : To fast-reverse
- 7** : Next
- 8** : To fast-forward
- 9** : To pause/play

While viewing photos

Operating buttons while viewing photos will be changed depends on the setting of Switch Image Type Button.

(Movie/photo) (default setting)

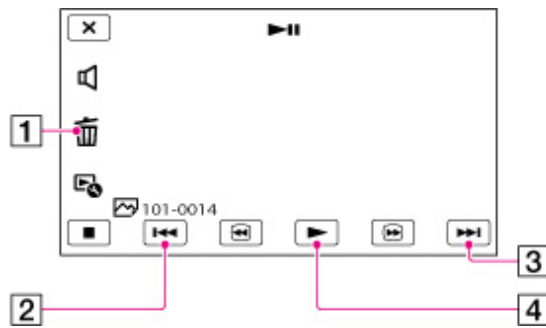



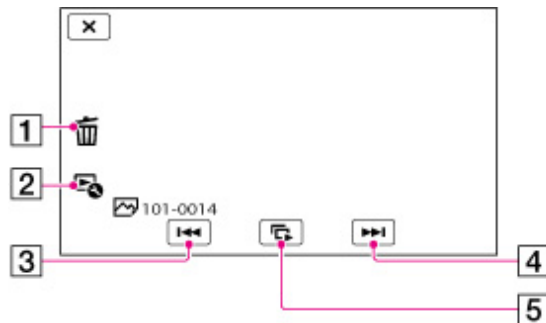

- 1** : Delete
- 2** : Previous
- 3** : Next
- 4** : To play/pause movies and photos in the order recorded

 (photo)



- 1** : Delete
- 2** : Context
- 3** : Previous
- 4** : Next
- 5** : To start/stop slide show

- As you repeat selecting  /  during playback, movies are played as fast as about 5 times → about 10 times → about 30 times → about 60 times.
- Select  /  during pause to play movies slowly.
- To repeat Slideshow, select  → [Slideshow Set].

I To play back images with other devices

- You may not be able to play back normally images recorded on your camcorder with other devices. Also, you may not be able to play back images recorded on other devices with your camcorder.
- Standard definition image quality (STD) movies recorded on SD memory cards cannot be played on AV equipment of other manufacturers.

[▲ Back to top](#)



- ▶ Operation Search
- ▶ Before use
- ▶ Getting started
- ▶ Recording
- ▶ Playback
- ▶ Saving images with an external device
- ▶ Customizing your camcorder
- ▶ Troubleshooting
- ▶ Maintenance and precautions

[⇒ Contents list](#)

Dividing a movie

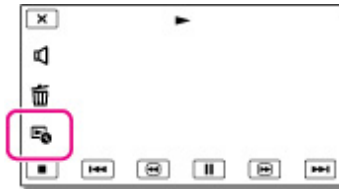
1. Select  → [Divide] on the movie playback screen.



2. Select the point where you want to divide the movie into scenes using  / , and then select OK.

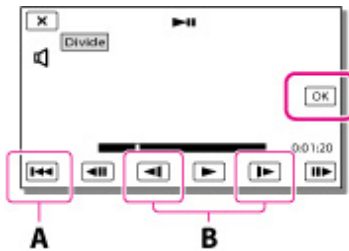

- A: Returns to the beginning of the selected movie
- B: Adjusts the dividing point with more precision

Notes

- A slight difference may occur from the point where you select and the actual dividing point, as your camcorder selects the dividing point based on about half-second increments.
- Some basic editing operations can be done on the camcorder. If you want to do advanced editing operations, use the built-in "PlayMemories Home" software.
- Do not remove the battery pack or the AC Adaptor from your camcorder while dividing the images. It may damage the recording media.
- Do not eject the memory card while dividing images from the memory card.
- If you divide movies that are included in saved scenarios, the scenarios will also be deleted.

Related topics

[\[Delete\]](#)

[▲ Back to top](#)

Copyright 2012 Sony Corporation

- ▶ Operation Search
- ▶ Before use
- ▶ Getting started
- ▶ Recording
- ▶ Playback
- ▶ Saving images with an external device
- ▶ Customizing your camcorder
- ▶ Troubleshooting
- ▶ Maintenance and precautions



[⇒ Contents list](#)

Capturing a photo from a movie

▼ On recording date and time of captured photos

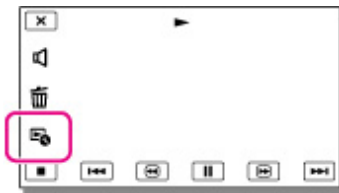
1. Select  → [Photo Capture] that appears on the playback screen of a movie.



2. Select the point where you want to capture a photo using  / , and then select .

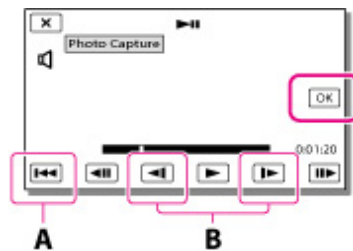

- A: Returns to the beginning of the selected movie
 B: Adjusts the capturing point with more precision

If the movie was recorded with one of the following image quality levels, the image size will be set as shown below.

- High definition image quality (HD): 2.1 M (16:9)
- Wide aspect ratio (16:9) with standard definition image quality (STD): 0.2 M (16:9)
- 4:3 aspect ratio with standard definition image quality (STD): 0.3 M (4:3)

■ On recording date and time of captured photos

- The recording date and time of captured photos is the same as the recording date and time of the movies.
- If the movie you are capturing from has no data code, the recording date and time of the photo will be the date and time you captured from the movie.

[▲ Back to top](#)



- ▶ Operation Search
- ▶ Before use
- ▶ Getting started
- ▶ Recording
- ▶ Playback
- ▶ Saving images with an external device
- ▶ Customizing your camcorder
- ▶ Troubleshooting
- ▶ Maintenance and precautions

[⇒ Contents list](#)

Enjoying a digest of your movies (Highlight Playback)

▼ To change the settings for Highlight Playback

You can enjoy a digest of high definition image quality (HD) movies and photos, similar to a short movie.

1. Press  (View Images).
2. Display the desired event at the center of the Event View, and select [ Highlight].

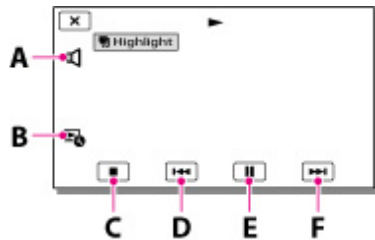

- A: Volume adjustment
- B: Context
- C: To stop
- D: Previous
- E: To pause
- F: Next

3. Select the desired operation when the highlight playback finishes.

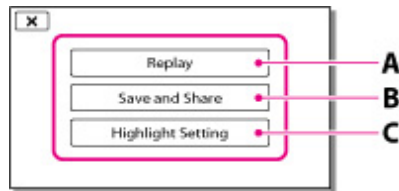





- A: The camcorder plays the Highlight Playback scenes again.
- B: You can save the Highlight Playback scenes in standard definition image quality (STD) and share it (upload it to the web, etc.).
- C: You can change the settings for Highlight Playback.



▮ To change the settings for Highlight Playback

You can change the Highlight Playback settings by selecting [Highlight Setting] on the screen after Highlight Playback has finished.

You can also change the setting by selecting  → [Highlight Setting] while the camcorder is playing highlight scenes.

- [Playback Range]: You can set the playback range (starting and ending date) of the Highlight Playback.
 - [Theme]: You can select a theme for Highlight Playback.
 - [Music]: You can select music.
 - [Audio mix]: The original sound is played back with the music.
 - [Length]: You can set the length of the Highlight Playback segment.
 - [Highlight Point]: You can set the points in a movie or photo that will be used in a Highlight Playback. Play the desired movie, and select  → . Or play the desired photo and select .
-  appears on the movie or photo that is used in a Highlight Playback.
- To erase the points, select  → [Clear All Points].

Notes

- Highlight Playback scenes will change each time you select a Highlight Playback.
- The [Playback Range] setting is cleared when the Highlight Playback stops.
- After the music file is transferred to the camcorder, if you cannot play the music, the music file may be damaged. Delete the music file by selecting  → [Setup] → [ Playback Settings] → [Empty Music], then transfer the music file again. You can restore the music data recorded on your camcorder at the default using "Music Transfer." For operating instructions, see "Music Transfer" help.
- When you connect the camcorder to an external device, such as a TV, and watch Highlight Playback, these images do not appear on the LCD screen of the camcorder.

[▲ Back to top](#)

Copyright 2012 Sony Corporation

- ▶ Operation Search
- ▶ Before use
- ▶ Getting started
- ▶ Recording
- ▶ Playback
- ▶ Saving images with an external device
- ▶ Customizing your camcorder
- ▶ Troubleshooting
- ▶ Maintenance and precautions

[⇒ Contents list](#)

[Top page](#) > [Playback](#) > [Highlight Playback](#) > [Saving Highlight Playback in high definition image quality \(HD\) \(Scenario Save\)](#)

Saving Highlight Playback in high definition image quality (HD) (Scenario Save)

▼ To play back a saved scenario

You can save your favorite Highlight Playback as a "Scenario" with high definition image quality (HD). Up to 8 scenarios can be saved and these scenarios can be played on the camcorder only.

1. Select [Replay] on the screen after a Highlight Playback has finished.
2. When the Highlight Playback starts again, select  → [Scenario Save].



▶ To play back a saved scenario

1. Select MENU → [Playback Function] → [Scenario], select the desired scenario, and then select OK.



- To erase a saved scenario, select  → [Erase]/[Erase All] while playing the scenario.

Notes

- When you connect the camcorder to an external device, such as a TV, and watch Highlight Scenario, these images do not appear on the LCD screen of the camcorder.

[▲ Back to top](#)

- ▶ Operation Search
- ▶ Before use
- ▶ Getting started
- ▶ Recording
- ▶ Playback
- ▶ Saving images with an external device
- ▶ Customizing your camcorder
- ▶ Troubleshooting
- ▶ Maintenance and precautions

[⇒ Contents list](#)

Converting Highlight Playback scenes or Highlight Scenarios to standard definition image quality (STD) (Highlight Movie)

▼ To play back a Highlight Movie

You can convert the data format of Highlight Playback or Highlight Scenarios to standard definition image quality (STD) and save them as a "Highlight Movie." Highlight movies can be used to create DVDs or be uploaded to the Web.

1. Select [Save and Share] on the screen after Highlight Playback or Highlight Scenario playback has finished.
2. Select the desired operation when the item has been saved.

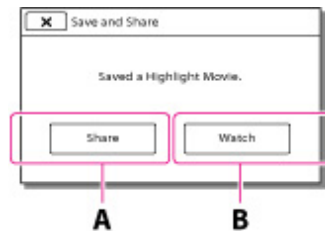

A: Selecting [Share] allows you to upload the Highlight movie to the Web using the built-in "PlayMemories Home" software, or create DVDs using the "DVDirect Express" DVD writer. [\[Details\]](#)[\[Details\]](#)

B: Your camcorder plays the Highlight Movie saved.

▶ To play back a Highlight Movie

1. Select MENU → [Playback Function] → [Highlight Movie] and select the desired Highlight Movie.
 - To erase Highlight Movie, select  while the Highlight Movie is playing.

[▲ Back to top](#)

- ▶ Operation Search
- ▶ Before use
- ▶ Getting started
- ▶ Recording
- ▶ Playback
- ▶ Saving images with an external device
- ▶ Customizing your camcorder
- ▶ Troubleshooting
- ▶ Maintenance and precautions

[➔ Contents list](#)

Using the built-in projector (HDR-PJ200)

You can use a flat surface such as a wall as a screen to view recorded images using the built-in projector.

The LCD screen turns off while an image is being projected. Use the power zoom lever/PHOTO button to operate the camcorder.

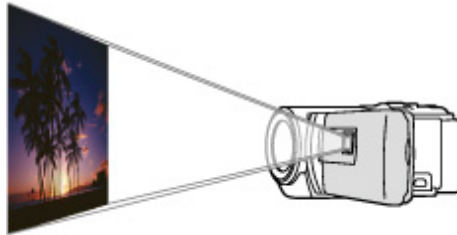

1. Face the projector lens towards a surface, such as a wall, and then press PROJECTOR.

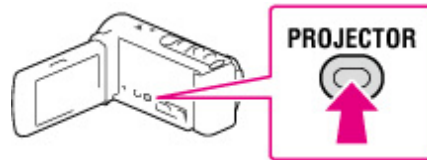

2. When the operating guide screen appears, select [Project].



- This screen appears the first time you use the built-in projector.

3. Adjust the focus of the projected image using the focus lever.

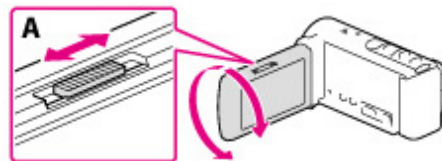

A: PROJECTOR FOCUS lever

- The projected image is larger when the distance between your camcorder and the reflecting surface increase.
- It is recommended that you place the camcorder further than 0.5 m (1.6 feet) away (approximate distance) from the surface that the images are to be projected onto.

4. Move the power zoom lever to select the image you want to play, then press PHOTO to begin playback.

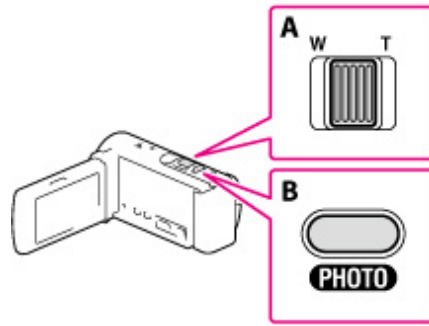

A: Power zoom lever

B: PHOTO button

- Use the power zoom lever to move the selection frame that appears on the LCD screen and press the PHOTO button to start playing the framed item.
- For details on playback, see the playback section. [\[Details\]](#)
- To turn off the projector, press PROJECTOR.

Notes

- Be careful of the following operations or situations while using the projector.
 - Make sure not to project images towards the eyes.
 - Make sure not to touch the projector lens.
 - The LCD screen and the projector lens become hot while in use.
 - Using the projector shortens battery life.
- The following operations are unavailable while you are using the projector.
 - Output of Highlight Playback to a device such as a TV
 - Operation of the camcorder with the LCD screen closed
 - Several other functions

[▲ Back to top](#)

Copyright 2012 Sony Corporation

[▶ Operation Search](#)[▶ Before use](#)[▶ Getting started](#)[▶ Recording](#)[▶ Playback](#)[▶ Saving images with an external device](#)[▶ Customizing your camcorder](#)[▶ Troubleshooting](#)[▶ Maintenance and precautions](#)[➔ Contents list](#)

Connecting the camcorder to a high definition TV

▼ On an HDMI cable

When movies are recorded with high definition image quality (HD), they are played back in high definition image quality (HD) on a high definition TV. Use the HDMI cable to connect the camcorder to a TV which has an HDMI input jack.

If the TV does not have an HDMI input jack, use the A/V connecting cable. [\[Details\]](#)

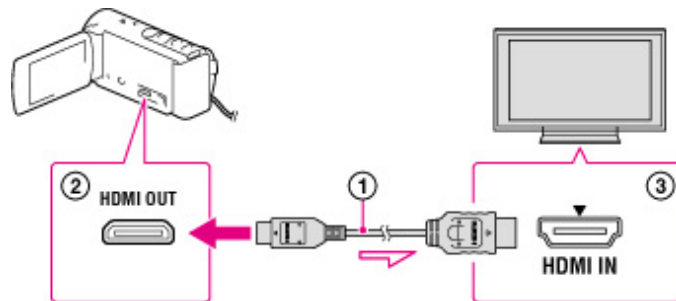

① : Supplied with HDR-CX200/CX210/PJ200

1. Switch the input on the TV to the connected jack.
2. Connect the HDMI cable (①) to the HDMI OUT jack (②) on the camcorder and to the HDMI IN jack (③) on the TV.
3. Play a movie or a photo on the camcorder.

■ On an HDMI cable

- Use an HDMI cable with the HDMI logo.
- Use an HDMI mini connector on one end (for the camcorder), and a plug suitable for connecting your TV on the other end.
- Copyright-protected images are not output from the HDMI OUT jack of your camcorder.
- Some TVs may not function correctly (e.g., no sound or image) with this connection.
- Do not connect the camcorder HDMI OUT jack to an external device HDMI OUT jack, as malfunction may result.
- HDMI (High Definition Multimedia Interface) is an interface to send both video/audio signals. The HDMI OUT jack outputs high quality images and digital audio.

Notes

- Refer to the instruction manuals of the TV as well.
- Use the supplied AC Adaptor as the power source. [\[Details\]](#)
- When movies are recorded with standard image quality (STD), they are played back in standard definition image quality (STD) even on a high definition TV.
- If you connect your camcorder to the TV using more than one type of cable to output images, HDMI output takes priority.
- The camcorder does not support the S-Video output.

[▲ Back to top](#)

- ▶ Operation Search
- ▶ Before use
- ▶ Getting started
- ▶ Recording
- ▶ Playback
- ▶ Saving images with an external device
- ▶ Customizing your camcorder
- ▶ Troubleshooting
- ▶ Maintenance and precautions

[→ Contents list](#)

[Top page](#) > [Playback](#) > [Playing images on a TV](#) > [Connecting the camcorder to a non-high-definition TV](#)

Connecting the camcorder to a non-high-definition TV

- ▼ [To set the aspect ratio according to the connected TV \(16:9/4:3\)](#)
- ▼ [When your TV is monaural \(When your TV has only one audio input jack\)](#)

When movies are recorded with high definition image quality (HD), they are played back in standard definition image quality (STD) on a non-high-definition TV. When movies are recorded with standard image quality (STD), they are played back in standard definition image quality (STD).

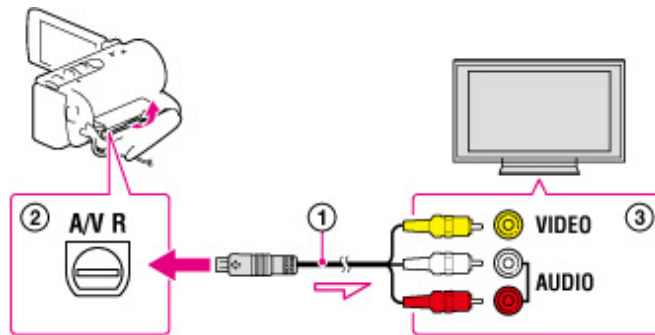

1. Switch the input on the TV to the connected jack.
2. Connect the A/V connecting cable (① ; supplied) to the A/V Remote Connector (②) on the camcorder and to the AUDIO and VIDEO input jacks (③) on the TV.
3. Play a movie or a photo on the camcorder.

| To set the aspect ratio according to the connected TV (16:9/4:3)

Set [TV Type] to [16:9] or [4:3] according to your TV.

| When your TV is monaural (When your TV has only one audio input jack)

Connect the yellow plug of the A/V connecting cable to the video input jack and connect the white (left channel) or red (right channel) plug to the audio input jack of your TV or VCR.

Notes

- Refer to the instruction manuals of the TV as well.
- Use the supplied AC Adaptor as the power source. [\[Details\]](#)
- When you play back standard definition image quality (STD) movies on a 4:3 TV that is not compatible with the 16:9 signal, set [Wide Mode] to [4:3] to record movies with 4:3 aspect ratio.
- If you connect your camcorder to the TV using more than one type of cable to output images, HDMI input takes priority on the TV.
- The camcorder does not support the S-Video output.

Related topics

- [\[TV Type\]](#)
- [\[Wide Mode\]](#)

[Top page](#) > [Playback](#) > [Playing images on a TV](#) > [Connecting the camcorder to a TV via a VCR](#)

▶ Operation Search

▶ Before use

▶ Getting started

▶ Recording

▶ Playback

▶ Saving images with an external device

▶ Customizing your camcorder

▶ Troubleshooting

▶ Maintenance and precautions

[⇒ Contents list](#)

Connecting the camcorder to a TV via a VCR

Connect your camcorder to the LINE IN input on the VCR using the A/V connecting cable. Set the input selector on the VCR to LINE (VIDEO 1, VIDEO 2, etc.).

[▲ Back to top](#)

Copyright 2012 Sony Corporation

- ▶ [Operation Search](#)
- ▶ [Before use](#)
- ▶ [Getting started](#)
- ▶ [Recording](#)
- ▶ [Playback](#)
- ▶ [Saving images with an external device](#)
- ▶ [Customizing your camcorder](#)
- ▶ [Troubleshooting](#)
- ▶ [Maintenance and precautions](#)

[⇒ Contents list](#)

Using "BRAVIA" Sync

You can operate your camcorder with the remote commander of your TV by connecting your camcorder to a "BRAVIA" Sync compatible TV launched in 2008 or later with the HDMI cable.

You can operate the menu of your camcorder by pressing the SYNC MENU button of the remote commander of your TV. You can display the camcorder screens such as Event View, play selected movies or display selected photos by pressing up/down/left/right/enter buttons of the remote commander of your TV.

Notes

- Set [CTRL FOR HDMI] to [On].
- Also set your TV accordingly. Refer to the instruction manual of the TV for details.
- The operation of "BRAVIA" Sync differs according to each model of BRAVIA. Refer to the instruction manual of your TV for details.
- If you turn off the TV, your camcorder is turned off simultaneously.

[▲ Back to top](#)

Copyright 2012 Sony Corporation

- ▶ Operation Search
- ▶ Before use
- ▶ Getting started
- ▶ Recording
- ▶ Playback
- ▶ Saving images with an external device
- ▶ Customizing your camcorder
- ▶ Troubleshooting
- ▶ Maintenance and precautions

[⇒ Contents list](#)

Starting the "PlayMemories Home" software

1. Double-click the "PlayMemories Home" icon on the computer screen.
The "PlayMemories Home" software starts up.



2. Double-click the "PlayMemories Home" Help Guide" short-cut icon on the computer screen to see how to use "PlayMemories Home."



If the icon is not displayed on the computer screen, click [Start] → [All Programs] → [PlayMemories Home] → the desired item.

[▲ Back to top](#)



- ▶ Operation Search
- ▶ Before use
- ▶ Getting started
- ▶ Recording
- ▶ Playback
- ▶ Saving images with an external device
- ▶ Customizing your camcorder
- ▶ Troubleshooting
- ▶ Maintenance and precautions

[⇒ Contents list](#)

Disc creation guide

▼ Movies that are recorded with standard definition image quality (STD)

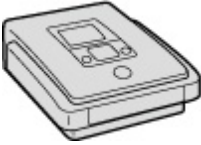

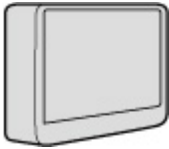
You can save high definition image quality (HD) movies using an external device. Select the method to be used according to the device.

External devices	Connecting cable
 DVDDirect Express DVD writer Saving images on a DVD disc with high definition image quality (HD). [Details]	Built-in USB cable of the DVDDirect Express
 DVD writer other than DVDDirect Express Saving images on a DVD disc with high definition image quality (HD) or with standard definition image quality (STD). [Details]	Built-in USB Cable
 Hard disk recorder, etc. Saving images on a DVD disc with standard definition image quality (STD). [Details]	A/V connecting cable (supplied)
 External media device Saving images on an external media device with high definition image quality (HD). [Details]	USB Adapter cable VMC-UAM1 (sold separately)

▮ Movies that are recorded with standard definition image quality (STD)

Use the A/V connecting cable to connect the camcorder to an external device in which images are saved.

Notes

- Delete the demonstration movie when copying or creating discs. If it is not deleted, the camcorder may not operate correctly. However, you cannot recover the demonstration movie once you delete it (HDR-CX210).
- There may be some types of discs or media devices on which movies cannot be saved, depending on the [ REC Mode] setting selected when you record the movie. Movies recorded with [ REC Mode] set to [Highest Quality ] can be saved on external media devices.

Related topics

Dubbing on a computer: [Starting the “PlayMemories Home” software](#)

[▲ Back to top](#)

Copyright 2012 Sony Corporation

[Top page](#) > [Saving images with an external device](#) > [Selecting a method for saving images](#) > [Types of media devices on which the images can be saved](#)

- ▶ Operation Search
- ▶ Before use
- ▶ Getting started
- ▶ Recording
- ▶ Playback
- ▶ Saving images with an external device
- ▶ Customizing your camcorder
- ▶ Troubleshooting
- ▶ Maintenance and precautions

[⇒ Contents list](#)

Types of media devices on which the images can be saved

Types of media that images can be saved on will depend on the recording mode selected.

Types of media	Recording mode	
	FX	FH/HQ/LP
Internal recording media on this camcorder*	✓	✓
Memory card inserted in this camcorder	✓	✓
External media (USB storage devices)	✓	✓
Blu-ray discs	✓	✓
AVCHD recording discs	—	✓

* HDR-CX210

[▲ Back to top](#)

Copyright 2012 Sony Corporation

[Top page](#) > [Saving images with an external device](#) > [Selecting a method for saving images](#) > [The devices on which the created disc can be played back](#)

- ▶ Operation Search
- ▶ Before use
- ▶ Getting started
- ▶ Recording
- ▶ Playback
- ▶ Saving images with an external device
- ▶ Customizing your camcorder
- ▶ Troubleshooting
- ▶ Maintenance and precautions

[⇒ Contents list](#)

The devices on which the created disc can be played back

DVD disc with high definition image quality (HD)

AVCHD format playback devices, such as a Sony Blu-ray disc player or a PlayStation®3

DVD disc with standard definition image quality (STD)

Ordinary DVD playback devices, such as a DVD player

Notes

- The AVCHD recording disc can be played back only on AVCHD format compatible devices.
- Discs with high definition image quality (HD) images recorded should not be used in DVD players/recorders. Because DVD players/recorders are not compatible with the AVCHD format, DVD players/recorders may fail to eject the disc.
- Always maintain your PlayStation®3 to use the latest version of the PlayStation®3 system software. The PlayStation®3 may not be available in some countries/regions.

[▲ Back to top](#)

- ▶ Operation Search
- ▶ Before use
- ▶ Getting started
- ▶ Recording
- ▶ Playback
- ▶ Saving images with an external device
- ▶ Customizing your camcorder
- ▶ Troubleshooting
- ▶ Maintenance and precautions

[⇒ Contents list](#)

Saving images on an external media device easily

▼ To delete images in the external media device

You can save movies and photos on an external media device (USB storage devices), such as an external hard disk drive. The following functions will be available after you have saved your images on an external media device.

- You can connect your camcorder and the external media device, and then play back images stored on the external media device.
- You can connect your computer and the external media device and import images to your computer using the built-in "PlayMemories Home" software.

Notes

- For this operation, you need the USB Adaptor Cable VMC-UAM1 (sold separately).
- Connect the AC Adaptor and the power cord (mains lead) to the DC IN jack of your camcorder and the wall outlet (wall socket).
- Refer to the instruction manual supplied with the external media device.

1. Connect your camcorder and the external media device using the USB Adaptor Cable (sold separately).

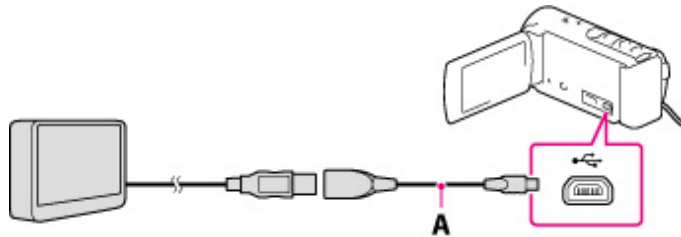

A: USB Adaptor Cable VMC-UAM1 (sold separately)

- Make sure not to disconnect the USB cable while [Preparing image database file. Please wait.] is displayed on the LCD screen.
- If [Repair Img. DB F.] is displayed on the camcorder screen, select OK.

2. Select [Copy.] on the camcorder screen.

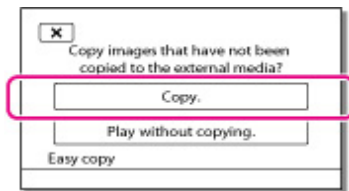

HDR-CX190/CX200/PJ200

Movies and photos that are stored in the memory card (inserted in the camcorder), and that have not yet been saved on to external media device can be saved on the connected media device at this time.

HDR-CX210

Movies and photos that are stored on one of the camcorder's recording media selected in [Media Select], and that have not yet been saved on external media device can be saved on the connected media device at this time.

-

- This operation is available only when there are newly recorded images in your camcorder.
- To disconnect the external media device, select  while the camcorder is in the playback standby mode (either Event View or Event Index is displayed).

To delete images in the external media device

1. Select [Play without copying.] in step 2 above.
2. Select **MENU** → [Edit/Copy] → [Delete], and then follow the instructions that appear on the LCD screen to delete images.

Notes

- You may not be able to use external media devices with a code function.
- The FAT file system is available for your camcorder. If the storage medium of the external device was formatted for the NTFS file system, etc., format the external media device using the camcorder before use. The format screen appears when an external media device is connected to your camcorder. Make sure that important data has not previously been saved on the external media device before you format it using the camcorder.
- Operation is not assured with every device satisfying requirements for operating.
- For details on available external media devices, go to the Sony support website in your country/region.
- The number of scenes you can save on the external media device are as follows. However, even if the external media device has free space, you cannot save scenes exceeding the following number.
 - High definition image quality (HD) movies: Max. 3,999
 - Standard definition image quality (STD) movies: Max. 9,999
 - Photos: Max. 40,000
- If your camcorder does not recognize the external media device, try the following operations.
 - Reconnect the USB Adaptor Cable to your camcorder.
 - If the external media device has the AC power cord (mains lead), connect it to the wall outlet (wall socket).
- The number of scenes may be smaller depending on the type of images recorded.
- You cannot copy images from an external media device to the internal recording medium on the camcorder.

[▲ Back to top](#)

Copyright 2012 Sony Corporation

- ▶ Operation Search
- ▶ Before use
- ▶ Getting started
- ▶ Recording
- ▶ Playback
- ▶ Saving images with an external device
- ▶ Customizing your camcorder
- ▶ Troubleshooting
- ▶ Maintenance and precautions

[⇒ Contents list](#)

Saving the desired images in the camcorder to the external media device

You can save desired images in the camcorder to the external media device.

Notes

- For this operation, you need the USB Adaptor Cable VMC-UAM1 (sold separately).
- Connect the AC Adaptor and the power cord (mains lead) to the DC IN jack of your camcorder and the wall outlet (wall socket).
- Refer to the instruction manual supplied with the external media device.

1. Connect your camcorder and the external media device using the USB Adaptor Cable (sold separately).

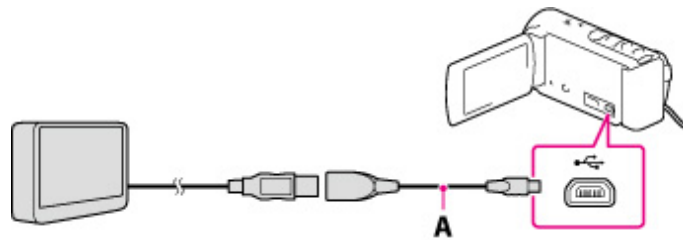

A: USB Adaptor Cable VMC-UAM1 (sold separately)

- Make sure not to disconnect the USB cable while [Preparing image database file. Please wait.] is displayed on the LCD screen.
 - If [Repair Img. DB F.] is displayed on the camcorder screen, select OK.
2. Select [Play without copying].
 3. Select MENU → [Edit/Copy] → [Copy], and then follow the instructions that appear on the LCD screen to save images.
 - If you want to copy images that have not yet been copied, select MENU → [Edit/Copy] → [Direct Copy] while your camcorder is connected to the external media device.

[▲ Back to top](#)

[Top page](#) > [Saving images with an external device](#) > [Saving images on an external media device](#) > [Playing back images in the external media device on the camcorder](#)

- ▶ Operation Search
- ▶ Before use
- ▶ Getting started
- ▶ Recording
- ▶ Playback
- ▶ Saving images with an external device
- ▶ Customizing your camcorder
- ▶ Troubleshooting
- ▶ Maintenance and precautions

[⇒ Contents list](#)

Playing back images in the external media device on the camcorder

▼ To play back high definition image quality (HD) movies on your computer

Notes

- For this operation, you need the USB Adaptor Cable VMC-UAM1 (sold separately).
- Connect the AC Adaptor and the power cord (mains lead) to the DC IN jack of your camcorder and the wall outlet (wall socket).
- Refer to the instruction manual supplied with the external media device.

1. Connect your camcorder and the external media device using the USB Adaptor Cable (sold separately).

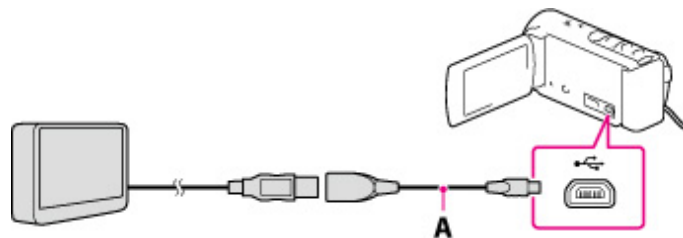

A: USB Adaptor Cable VMC-UAM1 (sold separately)

2. Select [Play without copying.] and select the image you want to view.
 - You can also view images on a TV connected to your camcorder.
 - When an external media device is connected, will appear on the Event View screen.

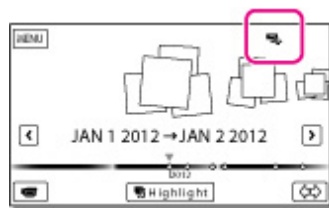

To play back high definition image quality (HD) movies on your computer

On the "PlayMemories Home" software, select the drive that represents the external media device connected, and then play movies.

[▲ Back to top](#)

[Top page](#) > [Saving images with an external device](#) > [Saving images on an external media device](#) > [Devices that cannot be used as an external media device](#)

▶ Operation Search

▶ Before use

▶ Getting started

▶ Recording

▶ Playback

▶ Saving images with an external device

▶ Customizing your camcorder

▶ Troubleshooting

▶ Maintenance and precautions

[⇒ Contents list](#)

Devices that cannot be used as an external media device

You cannot use the following devices as an external media device.

- media devices with a capacity exceeding 2 TB
- ordinary disc drive such as CD or DVD drive
- media devices connected via a USB hub
- media devices with built-in USB hub
- card reader

[▲ Back to top](#)

Copyright 2012 Sony Corporation

- ▶ Operation Search
- ▶ Before use
- ▶ Getting started
- ▶ Recording
- ▶ Playback
- ▶ Saving images with an external device
- ▶ Customizing your camcorder
- ▶ Troubleshooting
- ▶ Maintenance and precautions

[⇒ Contents list](#)

Creating a disc with DVDDirect Express



Connect your camcorder and the "DVDDirect Express" DVD writer (sold separately) using the USB cable supplied with the DVDDirect Express.

Notes

- Connect your camcorder to the wall outlet (wall socket) using the supplied AC Adaptor for this operation.
- Refer to the instruction manual supplied with the device connected.
- Sony DVD writer may not be available in some countries/regions.

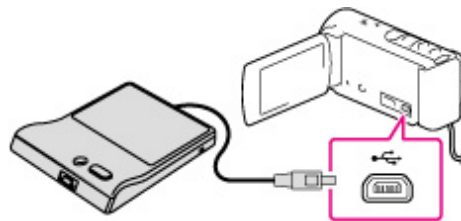
1. Connect the DVDDirect Express to the  (USB) jack of your camcorder with the USB cable of the DVDDirect Express.



2. Insert an unused disc into the DVDDirect Express, and close the disc tray.
3. Press  (DISC BURN) on the DVDDirect Express.
Movies that have not yet been saved on any disc can be saved on the disc at this time.
 - After the operation is completed, select .

Notes

- High definition (HD) and standard definition (STD) image quality movies will be saved on individual discs.
- If the total memory size of movies to be burnt by the DISC BURN operation exceeds that of the disc, disc creation stops when the limit is reached. The last movie on the disc may be cut off.
- Do not do any of the following when creating a disc.
 - Turn off the camcorder
 - Disconnect the USB cable or the AC Adaptor
 - Subject the camcorder or the DVDDirect Express to mechanical shock or vibration
 - Eject the memory card from the camcorder
- Disc creation time to copy movies to the limit of the disc is about 20 to 60 minutes. It may take more time depending on the recording mode or the number of scenes.

[▲ Back to top](#)

- ▶ Operation Search
- ▶ Before use
- ▶ Getting started
- ▶ Recording
- ▶ Playback
- ▶ Saving images with an external device
- ▶ Customizing your camcorder
- ▶ Troubleshooting
- ▶ Maintenance and precautions

[⇒ Contents list](#)

Performing [DISC BURN OPTION]

You can create a standard definition image quality (STD) disc using the DVDDirect Express (sold separately).

1. Connect the DVDDirect Express to the  (USB) jack of your camcorder with the USB cable of the DVDDirect Express.

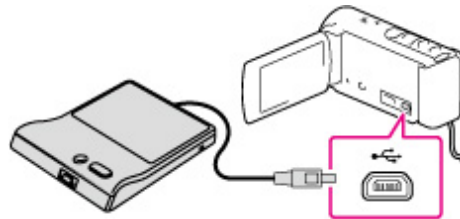

2. Insert an unused disc into the DVDDirect Express, and close the disc tray.
3. Select [DISC BURN OPTION].
4. Select the recording media containing the movie(s) you want to save (HDR-CX210)
5. Select the image quality of the disc you will create.
6. Add check marks to the images you want to copy, and then select OK.

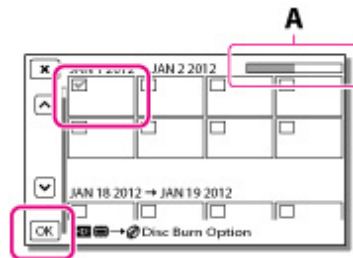

A: Remaining disc capacity

- After the operation is completed, select X.

[▲ Back to top](#)



[Top page](#) > [Saving images with an external device](#) > [Creating a disc with the DVD writer, DVDirect Express](#) > [Playing back a disc on the DVDirect Express](#)

- ▶ Operation Search
- ▶ Before use
- ▶ Getting started
- ▶ Recording
- ▶ Playback
- ▶ Saving images with an external device
- ▶ Customizing your camcorder
- ▶ Troubleshooting
- ▶ Maintenance and precautions

[⇒ Contents list](#)

Playing back a disc on the DVDirect Express

You can watch movies or photos stored on a disc in the DVDirect Express (sold separately) with the TV.

1. When you play back movies on the TV screen, connect the DVDirect Express to the  (USB) jack of your camcorder, and connect your camcorder to the TV.
2. Insert a created disc into the DVDirect Express.
3. Press the play button on the DVDirect Express.
 - After the operation is completed, select .

[▲ Back to top](#)

[Top page](#) > [Saving images with an external device](#) > [Creating a disc with a DVD writer other than DVDirect Express](#) > [Creating a high definition image quality \(HD\) disc with a DVD writer](#)

- ▶ Operation Search
- ▶ Before use
- ▶ Getting started
- ▶ Recording
- ▶ Playback
- ▶ Saving images with an external device
- ▶ Customizing your camcorder
- ▶ Troubleshooting
- ▶ Maintenance and precautions

[⇒ Contents list](#)

Creating a high definition image quality (HD) disc with a DVD writer

Use the Built-in USB Cable to connect your camcorder to a Sony DVD writer other than DVDirect Express (sold separately), etc., which is compatible with high definition image quality (HD) movies.

1. Connect a DVD writer to your camcorder with the Built-in USB Cable.

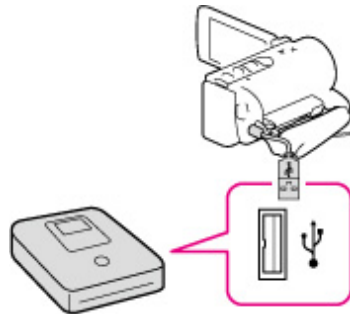

2. Select [USB Connect] on the camcorder screen.
If the [USB Select] screen does not appear, select MENU → [Setup] → [Connection] → [USB Connect].
3. Record movies on the connected device.
 - After the operation is completed, select X.

Notes

- Always maintain the firmware of the Sony DVDirect (DVD Writer) to its latest version. For details, see the following website.
<http://sony.storagesupport.com/>

[▲ Back to top](#)

[Top page](#) > [Saving images with an external device](#) > [Creating a disc with a recorder](#) > [Creating a standard definition image quality \(STD\) disc with a recorder, etc.](#)

- ▶ Operation Search
- ▶ Before use
- ▶ Getting started
- ▶ Recording
- ▶ Playback
- ▶ Saving images with an external device
- ▶ Customizing your camcorder
- ▶ Troubleshooting
- ▶ Maintenance and precautions

[➔ Contents list](#)

Creating a standard definition image quality (STD) disc with a recorder, etc.

Connect your camcorder to a disc recorder, a Sony DVD writer, etc., other than DVDirect Express, with the A/V connecting cable. You can copy images played back on your camcorder on a disc or video cassette.

1. Insert the recording medium in the recording device (a disc recorder, etc.).
 - If your recording device has an input selector, set it to the input mode.
2. Connect your camcorder to the recording device with the A/V connecting cable.

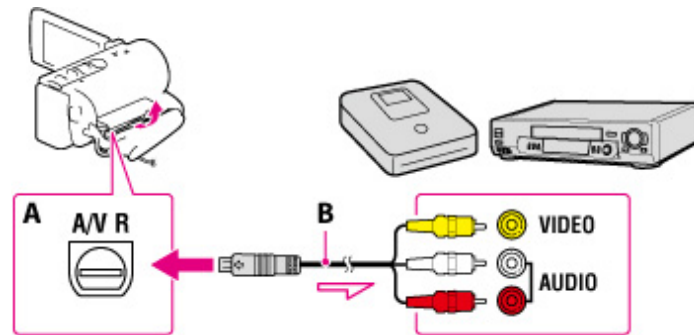

A: A/V Remote Connector

B: A/V connecting cable

➔ : Signal flow

Connect your camcorder to the input jacks of the recording device.

3. Start playback on your camcorder, and record it on the recording device.
4. When dubbing is finished, stop the recording device, and then your camcorder.

Notes

- You cannot copy images to recorders connected with an HDMI cable.
- Since copying is performed via analog data transfer, the image quality may deteriorate.
- High definition image quality (HD) movies will be copied with standard definition image quality (STD).
- When you connect a monaural device, connect the yellow plug of the A/V connecting cable to the video input jack, and the white (left channel) or the red (right channel) plug to the audio input jack on the device.

Related topics

Copying date and time information: [\[Data Code\]](#)

Using 4:3 screen size display device: [\[TV Type\]](#)

[▲ Back to top](#)







- ▶ Operation Search
- ▶ Before use
- ▶ Getting started
- ▶ Recording
- ▶ Playback
- ▶ Saving images with an external device
- ▶ Customizing your camcorder
- ▶ Troubleshooting
- ▶ Maintenance and precautions

[➔ Contents list](#)

Setting up menu items

- ▼ [To find a menu item quickly](#)
- ▼ [When you cannot select a menu item](#)

The camcorder has various menu items under each of 6 menu categories.

-  Shooting Mode (Items for selecting a shooting mode)
-  Camera/Mic (Items for customized shooting)
-  Image Quality/Size (Items for setting up image quality or size)
-  Playback Function (Items for playback)
-  Edit/Copy (Items for editing images such as copy or protect)
-  Setup (Other setup items)

1. Select MENU.



2. Select a category.

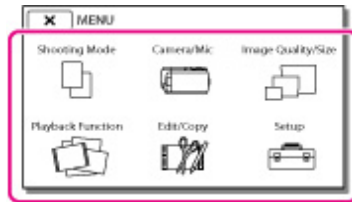

3. Select your desired menu item.

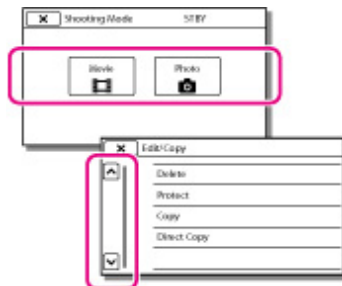

Notes

- Select X to finish setting the menu or to return to the previous screen.

▶ To find a menu item quickly

The [Camera/Mic] and [Setup] menus have sub-categories. Select the sub-category icon so that the LCD screen displays the list of menus in the sub-category selected.

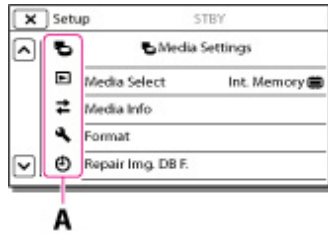

A: Sub-category icons

When you cannot select a menu item

Grayed out menu items or settings are not available.

Your camcorder displays the reason why you cannot select the menu item or the instruction of under which condition you can set the menu item.

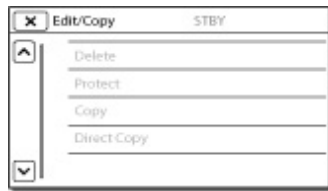

[▲ Back to top](#)

Copyright 2012 Sony Corporation

- ▶ Operation Search
- ▶ Before use
- ▶ Getting started
- ▶ Recording
- ▶ Playback
- ▶ Saving images with an external device
- ▶ Customizing your camcorder
- ▶ Troubleshooting
- ▶ Maintenance and precautions

[⇒ Contents list](#)

Movie

You can select the movie recording mode.

1. **MENU** → [Shooting Mode] → [Movie].



[▲ Back to top](#)

▶ Operation Search

▶ Before use

▶ Getting started

▶ Recording

▶ Playback

▶ Saving images with an external device

▶ Customizing your camcorder

▶ Troubleshooting

▶ Maintenance and precautions

[⇒ Contents list](#)

Photo

You can select the photo shooting mode.

1. **MENU** → [Shooting Mode] → [Photo].



[▲ Back to top](#)

- ▶ Operation Search
- ▶ Before use
- ▶ Getting started
- ▶ Recording
- ▶ Playback
- ▶ Saving images with an external device
- ▶ Customizing your camcorder
- ▶ Troubleshooting
- ▶ Maintenance and precautions

[⇒ Contents list](#)

White Balance





You can adjust the color balance to the recording environment.



1. **MENU** → [Camera/Mic] → [**Manual Settings**] → [White Balance].



2. Select the desired setting.

✓	<p>WB AUTO (Auto)</p> <p>The white balance is adjusted automatically.</p> <p>If you have changed the battery pack while [Auto] was selected, or taken your camcorder outdoors after inside use (or vice versa), aim your camcorder at a nearby white object for about 10 seconds for better color balance adjustment.</p>
	<p> (Outdoor)</p> <p>The white balance is appropriately adjusted for the following recording conditions:</p> <ul style="list-style-type: none"> ● Outdoors ● Night views, neon signs and fireworks ● Sunrise or sunset ● Under daylight fluorescent lamps
	<p> (Indoor)</p> <p>The white balance is appropriately adjusted for the following recording conditions:</p> <ul style="list-style-type: none"> ● Indoors ● At party scenes or studios where the lighting conditions change quickly ● Under video lamps in a studio, or under sodium lamps or incandescent-like color lamps
	<p> (One Push)</p> <p>The white balance will be adjusted according to the ambient light.</p> <ol style="list-style-type: none"> ① Select []. ② Keep framing white object such as a piece of paper, to fill the screen under the same lightning conditions as you will shoot the subject. ③ Select []. <p>If the lighting conditions changed by bringing your camcorder outdoors from inside the house, or vice versa, you need to redo the [One Push] procedure to readjust the white balance.</p>

- Set [White Balance] to [Auto] or adjust the color in [One Push] under white or cool white fluorescent lamps.
- While you are recording a movie,  (One Push) cannot be set.
- If you set [White Balance], [Scene Selection] is set to [Auto].

[▲ Back to top](#)

Copyright 2012 Sony Corporation

▶ Operation Search

▶ Before use

▶ Getting started

▶ Recording

▶ Playback

▶ Saving images with an external device

▶ Customizing your camcorder

▶ Troubleshooting

▶ Maintenance and precautions

[⇒ Contents list](#)

[Top page](#) > [Customizing your camcorder](#) > [Camera/Mic](#) > [Spot Meter/Fcs \(Spot meter/focus\) \(HDR-CX200/CX210/PJ200\)](#)

Spot Meter/Fcs (Spot meter/focus) (HDR-CX200/CX210/PJ200)

Brightness and focus can be adjusted for the selected subject automatically.

1. **MENU** → [Camera/Mic] → [Manual Settings] → [Spot Meter/Fcs].



2. Touch the subject of which you want to adjust the brightness and focus.
 - To adjust the brightness and focus automatically, touch [Auto].



Notes

- [Exposure] and [Focus] are automatically set to [Manual].

[▲ Back to top](#)

- ▶ Operation Search
- ▶ Before use
- ▶ Getting started
- ▶ Recording
- ▶ Playback
- ▶ Saving images with an external device
- ▶ Customizing your camcorder
- ▶ Troubleshooting
- ▶ Maintenance and precautions

[⇒ Contents list](#)

[Top page](#) > [Customizing your camcorder](#) > [Camera/Mic](#) > [Spot Meter \(Flexible spot meter\) \(HDR-CX200/CX210/PJ200\)](#)

Spot Meter (Flexible spot meter) (HDR-CX200/CX210/PJ200)

Exposure can be adjusted and set for the selected subject automatically. This function is useful when there is strong contrast between the subject and the background, such as subjects in the spotlight on stage.

1. **MENU** → [Camera/Mic] → [Manual Settings] → [Spot Meter].



2. Touch the subject of which you want to adjust the exposure.
 - To return the setting to automatic exposure, touch [Auto].



Notes

- [Exposure] is automatically set to [Manual].

[▲ Back to top](#)

- ▶ Operation Search
- ▶ Before use
- ▶ Getting started
- ▶ Recording
- ▶ Playback
- ▶ Saving images with an external device
- ▶ Customizing your camcorder
- ▶ Troubleshooting
- ▶ Maintenance and precautions

[⇒ Contents list](#)

Spot Focus (HDR-CX200/CX210/PJ200)

Focus can be adjusted automatically for the subject selected.

1. **MENU** → [Camera/Mic] → [Manual Settings] → [Spot Focus].



2. Touch the subject of which you want to adjust the focus.
 - To adjust the focus automatically, touch [Auto].



Notes

- [Focus] is automatically set to [Manual].

[▲ Back to top](#)

- ▶ Operation Search
- ▶ Before use
- ▶ Getting started
- ▶ Recording
- ▶ Playback
- ▶ Saving images with an external device
- ▶ Customizing your camcorder
- ▶ Troubleshooting
- ▶ Maintenance and precautions

[⇒ Contents list](#)

Exposure

You can fix the brightness of a picture manually. Adjust the brightness when the subject is too bright or too dark.

1. → [Camera/Mic] → [Manual Settings] → [Exposure].



2. Select the desired item.

<input checked="" type="checkbox"/>	<p>Auto The exposure is adjusted automatically.</p>
<input type="checkbox"/>	<p>Manual Select <input type="button" value="+"/> if the subject is white or the backlight is bright, or select <input type="button" value="-"/> if the subject is black or the light is dim.</p>



[▲ Back to top](#)

- ▶ Operation Search
- ▶ Before use
- ▶ Getting started
- ▶ Recording
- ▶ Playback
- ▶ Saving images with an external device
- ▶ Customizing your camcorder
- ▶ Troubleshooting
- ▶ Maintenance and precautions

[⇒ Contents list](#)

FOCUS

- ▼ [To adjust the focus](#)
- ▼ [On focal distance information](#)

You can adjust the focus manually. You can select this function also when you want to focus on a certain subject intentionally.

1. MENU → [Camera/Mic] → [Manual Settings] → [Focus].



2. Select the desired item.

<input checked="" type="checkbox"/>	Auto The focus is adjusted automatically.
<input type="checkbox"/>	Manual Adjust the focus using ⏪ (nearby subject) or ⏩ (distant subject). ⏪ appears when the focus cannot be adjusted any closer, and ⏩ appears when the focus cannot be adjusted farther away.



▮ To adjust the focus

It is easier to focus on the subject by moving the power zoom lever towards T (telephoto) to adjust the focus, then towards W (wide angle) to adjust the zoom for recording. When you want to record a subject at close range, move the power zoom lever to W (wide angle), then adjust the focus.

▮ On focal distance information

Your camcorder displays the focal distance information for a few seconds when the focus mode is switched from automatic to manual or when you set the focus manually. You can use this information as a guide when the subject is dark and focus adjustment is difficult.

Notes

- When you set [Focus] to [Manual], F appears.
- The minimum possible distance between camcorder and subject while maintaining sharp focus is

about 1 cm (about 13/32 in.) for wide angle and about 80 cm (about 31 1/2 in.) for telephoto.

[▲ Back to top](#)

Copyright 2012 Sony Corporation

- ▶ Operation Search
- ▶ Before use
- ▶ Getting started
- ▶ Recording
- ▶ Playback
- ▶ Saving images with an external device
- ▶ Customizing your camcorder
- ▶ Troubleshooting
- ▶ Maintenance and precautions

[⇒ Contents list](#)

LOW LUX

You can record bright color images, even in dim light.

1. **MENU** → [Camera/Mic] → [ Manual Settings] → [Low Lux].



2. Select the desired item.

✓	Off The Low Lux function is not used.
	On () The Low Lux function is used.

[▲ Back to top](#)

- ▶ Operation Search
- ▶ Before use
- ▶ Getting started
- ▶ Recording
- ▶ Playback
- ▶ Saving images with an external device
- ▶ Customizing your camcorder
- ▶ Troubleshooting
- ▶ Maintenance and precautions

[⇒ Contents list](#)

Scene Selection







You can record images effectively in various situations.

1. **MENU** → [Camera/Mic] → [Camera Settings] → [Scene Selection].



2. Select the desired item.

	(Auto) Adjusts image quality automatically.	
	(Night Scene)* ¹ Maintains the darkening atmosphere of the distant surroundings in night scenes.	
	(Sunrise&Sunset)* ¹ Reproduces the atmosphere of scenes such as sunsets or sunrises.	
	(Fireworks)* ¹ Takes spectacular shots of fireworks.	
	(Landscape)* ¹ Shoots distant subjects clearly. This setting also prevents your camcorder from focusing on glass or metal mesh in windows between the camcorder and the subject.	
	(Portrait) Brings out the subject such as people or flowers while creating a soft	

	background.	
	 (Spotlight)* ² Prevents people's faces from appearing excessively white when subjects are lit by strong light.	
	 (Beach)* ² Takes the vivid blue of the ocean or a lake.	
	 (Snow)* ² Takes bright pictures of a white landscape.	

*¹ Adjusted to focus on subjects farther away only.

*² Adjusted not to focus on subjects a short distance away.

[▲ Back to top](#)

Copyright 2012 Sony Corporation

- ▶ Operation Search
- ▶ Before use
- ▶ Getting started
- ▶ Recording
- ▶ Playback
- ▶ Saving images with an external device
- ▶ Customizing your camcorder
- ▶ Troubleshooting
- ▶ Maintenance and precautions

[⇒ Contents list](#)







Fader

You can record a transition with the following effects adding to the interval between scenes. Select the desired effect in [STBY] (to fading in) or [REC] (to fading out) mode.

1. **MENU** → [Camera/Mic] → [ Camera Settings] → [ Fader].



2. Select the desired item.

<input checked="" type="checkbox"/>	<p>Off Does not use an effect.</p>
<input type="checkbox"/>	<p>White Fader () Fades in/out with the white effect. Out  In</p> 
<input type="checkbox"/>	<p>Black Fader () Fades in/out with the black effect. Out  In</p> 

Notes

- When you press START/STOP, the setting is cleared.

[▲ Back to top](#)

- ▶ Operation Search
- ▶ Before use
- ▶ Getting started
- ▶ Recording
- ▶ Playback
- ▶ Saving images with an external device
- ▶ Customizing your camcorder
- ▶ Troubleshooting
- ▶ Maintenance and precautions

[⇒ Contents list](#)

📷 Self-Timer

Press PHOTO to start the count down. A photo is recorded after about 10 seconds.

1. **MENU** → [Camera/Mic] → [Camera Settings] → [Self-Timer].



2. Select the desired item.

✓	Off Cancels the self-timer.
	On (🕒) Starts the self-timer recording. To cancel the recording, select [Reset].

[▲ Back to top](#)

- ▶ Operation Search
- ▶ Before use
- ▶ Getting started
- ▶ Recording
- ▶ Playback
- ▶ Saving images with an external device
- ▶ Customizing your camcorder
- ▶ Troubleshooting
- ▶ Maintenance and precautions

[⇒ Contents list](#)

Tele Macro

You can blur out backgrounds and the subject stands out clearer. This is useful to shoot small subjects, such as flowers or insects.

1. **MENU** → [Camera/Mic] → [Camera Settings] → [Tele Macro].



2. Select the desired item.

✓	<p>Off Cancels Tele Macro. (Tele Macro is also canceled when you move the zoom lever to the W side.)</p>
	<p>On ()</p> <p>The zoom moves to the top of the T (telephoto) side automatically and allows recording subjects at close range down to about 39 cm (15 3/8 in.).</p> <div style="text-align: center;"> </div>

Notes

- When recording a distant subject, focusing may be difficult and can take some time.
- Adjust the focus manually when it is hard to focus automatically.

Related topics

[Zooming](#)
[Focus](#)



[▲ Back to top](#)

- ▶ Operation Search
- ▶ Before use
- ▶ Getting started
- ▶ Recording
- ▶ Playback
- ▶ Saving images with an external device
- ▶ Customizing your camcorder
- ▶ Troubleshooting
- ▶ Maintenance and precautions

[⇒ Contents list](#)

SteadyShot (movie)

You can compensate for camera shake.

Set [ SteadyShot] to [Off] () when using a tripod (sold separately), then the image becomes natural.

1.  → [Camera/Mic] → [ Camera Settings] → [ SteadyShot].



2. Select the desired item.

<input checked="" type="checkbox"/>	Active Provides a more powerful SteadyShot effect.
<input type="checkbox"/>	Standard Provides a SteadyShot effect, performing wide-angle recording under relatively stable recording conditions.
<input type="checkbox"/>	Off () The SteadyShot function is not used.

Notes

- If you change the setting, the imaging field will also change accordingly.
- You can zoom images up to 30 times, unless [ SteadyShot] is set to [Active].

[▲ Back to top](#)

- ▶ Operation Search
- ▶ Before use
- ▶ Getting started
- ▶ Recording
- ▶ Playback
- ▶ Saving images with an external device
- ▶ Customizing your camcorder
- ▶ Troubleshooting
- ▶ Maintenance and precautions

[⇒ Contents list](#)

Digital Zoom

You can select the maximum zoom level. Note that the image quality decreases when you use the digital zoom.

1. **MENU** → [Camera/Mic] → [Camera Settings] → [Digital Zoom].



2. Select the desired item.

✓	Off Up to 25 × zoom is performed.
	300 × Up to 300 × zoom is performed digitally. <div style="text-align: center; margin: 10px 0;"> </div> A: The zooming zone appears when you select [300 ×].

Notes

- You can magnify images up to 30 times using optical zooming, unless [SteadyShot] is set to [Active].

[▲ Back to top](#)

- ▶ Operation Search
- ▶ Before use
- ▶ Getting started
- ▶ Recording
- ▶ Playback
- ▶ Saving images with an external device
- ▶ Customizing your camcorder
- ▶ Troubleshooting
- ▶ Maintenance and precautions

[⇒ Contents list](#)

Auto Back Light

Your camcorder adjusts the exposure for backlit subjects automatically.

1. MENU → [Camera/Mic] → [Camera Settings] → [Auto Back Light].



2. Select the desired item.

✓	On The exposure for backlit subjects is adjusted automatically.
	Off Does not adjust the exposure for backlit subjects.

[▲ Back to top](#)

- ▶ Operation Search
- ▶ Before use
- ▶ Getting started
- ▶ Recording
- ▶ Playback
- ▶ Saving images with an external device
- ▶ Customizing your camcorder
- ▶ Troubleshooting
- ▶ Maintenance and precautions

[➔ Contents list](#)

Face Detection

▼ Recording conditions for better face detection performance

You can set the camcorder to detect a face automatically. Your camcorder adjusts the focus/color/exposure automatically for the face of the selected subject.

1. **MENU** → [Camera/Mic] → [Face] → [Face Detection].



2. Select the desired item.

✓	Auto Detects faces without distinction between adults and children.
	Child Priority () Gives faces of children priority.
	Adult Priority () Gives faces of adults priority.
	Off () Does not detect faces.

Recording conditions for better face detection performance

- Shoot in a sufficiently bright place.
- The subject is not wearing glasses, a hat or mask.
- The subject faces directly towards the camera.

Notes

- Faces may not be detected depending on recording conditions, subject conditions, and the setting of your camcorder.

Related topics

[Recording the selected subject clearly \(Face Priority\) \(HDR-CX200/CX210/PJ200\)](#)
[Smile Shutter](#)

[▲ Back to top](#)

- ▶ Operation Search
- ▶ Before use
- ▶ Getting started
- ▶ Recording
- ▶ Playback
- ▶ Saving images with an external device
- ▶ Customizing your camcorder
- ▶ Troubleshooting
- ▶ Maintenance and precautions

[⇒ Contents list](#)

Smile Shutter

The shutter is released automatically when the camcorder detects a smile. If you do not want to take photos automatically, select [Off].

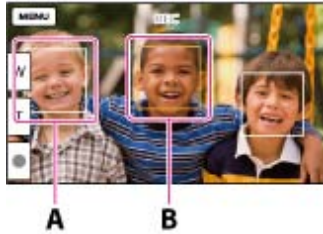

- A: The camcorder is detecting a face.
- B: The camcorder is detecting a smile (orange).

1. MENU → [Camera/Mic] → [Face] → [Smile Shutter].



2. Select the desired item.

<input checked="" type="checkbox"/>	Dual Capture Only during movie recording, the shutter is released automatically, when the camcorder detects a smile.
<input type="checkbox"/>	Always On The shutter is released when the camcorder detects a smile whenever the camcorder is in recording mode.
<input type="checkbox"/>	Off () Smiles are not detected, so photos are not recorded automatically.

Notes

- When the recording mode is set to [Highest Quality \overline{FX}], you cannot use the Smile Shutter function while recording movies.
- Smiles may not be detected depending on recording conditions, subject conditions, and the setting of your camcorder.

Related topics

[\[Smile Sensitivity\]](#)

[▲ Back to top](#)

- ▶ Operation Search
- ▶ Before use
- ▶ Getting started
- ▶ Recording
- ▶ Playback
- ▶ Saving images with an external device
- ▶ Customizing your camcorder
- ▶ Troubleshooting
- ▶ Maintenance and precautions

[⇒ Contents list](#)

Smile Sensitivity

Sets the smile detection sensitivity for using the Smile Shutter function.

1. MENU → [Camera/Mic] → [ Face] → [Smile Sensitivity].



2. Select the desired item.

	Slight Smile Detects even a slight smile.
✓	Normal Smile Detects a normal smile.
	Big Smile Detects a big smile.

[▲ Back to top](#)

- ▶ Operation Search
- ▶ Before use
- ▶ Getting started
- ▶ Recording
- ▶ Playback
- ▶ Saving images with an external device
- ▶ Customizing your camcorder
- ▶ Troubleshooting
- ▶ Maintenance and precautions

[⇒ Contents list](#)

Blt-in Zoom Mic

You can record a movie with vivid sound appropriate to the zoom position.

1. **MENU** → [Camera/Mic] → [ Microphone] → [Blt-in Zoom Mic].



2. Select the desired item.

✓	Off The microphone does not record sound following zooming in or out.
	On () The microphone records sound following zooming in or out.

[▲ Back to top](#)

- ▶ Operation Search
- ▶ Before use
- ▶ Getting started
- ▶ Recording
- ▶ Playback
- ▶ Saving images with an external device
- ▶ Customizing your camcorder
- ▶ Troubleshooting
- ▶ Maintenance and precautions

[⇒ Contents list](#)

Wind Noise Reduct.

Your camcorder records a movie with less wind noise input from the built-in microphone.

1. **MENU** → [Camera/Mic] → [Microphone] → [Wind Noise Reduct.].



2. Select the desired item.

✓	Off Disables wind noise reduction.
	On () Enables wind noise reduction.

[▲ Back to top](#)

- ▶ Operation Search
- ▶ Before use
- ▶ Getting started
- ▶ Recording
- ▶ Playback
- ▶ Saving images with an external device
- ▶ Customizing your camcorder
- ▶ Troubleshooting
- ▶ Maintenance and precautions

[⇒ Contents list](#)

Micref Level (Microphone reference level)

You can select the microphone level for recording sound.

1. **MENU** → [Camera/Mic] → [ Microphone] → [Micref Level].



2. Select the desired item.

✓	<p>Normal Records various ambient sounds, converting them into the appropriate level.</p>
	<p>Low Records ambient sound faithfully. Select [Low] when you want to record an exciting and powerful sound in a concert hall, etc. (This setting is not suitable for recording conversations.)</p>

[▲ Back to top](#)

- ▶ Operation Search
- ▶ Before use
- ▶ Getting started
- ▶ Recording
- ▶ Playback
- ▶ Saving images with an external device
- ▶ Customizing your camcorder
- ▶ Troubleshooting
- ▶ Maintenance and precautions

[⇒ Contents list](#)

My Button

You can assign functions that you frequently use when recording to one of the My Buttons.

1. **MENU** → [Camera/Mic] → [Shooting Assist] → [My Button].

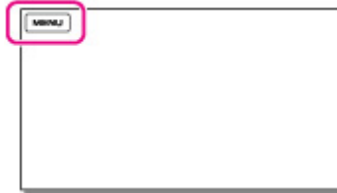

2. Select the menu item that you want to assign to a My Button using / .



3. Select one of the My Buttons to which the menu item will be assigned.



4. Select **OK**.

[▲ Back to top](#)

- ▶ Operation Search
- ▶ Before use
- ▶ Getting started
- ▶ Recording
- ▶ Playback
- ▶ Saving images with an external device
- ▶ Customizing your camcorder
- ▶ Troubleshooting
- ▶ Maintenance and precautions

[⇒ Contents list](#)

Guide Frame

You can display the frame and check that the subject is horizontal or vertical. Positioning the subject at the cross point of the guide frame makes a balanced composition. The frame is not recorded.

1. **MENU** → [Camera/Mic] → [ Shooting Assist] → [Guide Frame].



2. Select the desired item.

✓	Off Does not display the guide frame.
	On Displays the guide frame. 

Notes

- The outer frame of [Guide Frame] shows the display area of a TV which is not compatible with full pixel display.

[▲ Back to top](#)

- ▶ Operation Search
- ▶ Before use
- ▶ Getting started
- ▶ Recording
- ▶ Playback
- ▶ Saving images with an external device
- ▶ Customizing your camcorder
- ▶ Troubleshooting
- ▶ Maintenance and precautions

[⇒ Contents list](#)

Display Setting

You can set the duration of displaying the icons or indicators on the LCD screen while recording.

1. **MENU** → [Camera/Mic] → [Shooting Assist] → [Display Setting].



2. Select the desired item.

✓	Auto Displays for about 3 seconds. The rec & zoom buttons on the LCD screen is displayed.
	On Always displays. The rec & zoom buttons on the LCD screen is not displayed.

Notes

- You cannot change the setting of the icons or indicators on the LCD screen while in the playback mode.

[▲ Back to top](#)

- ▶ Operation Search
- ▶ Before use
- ▶ Getting started
- ▶ Recording
- ▶ Playback
- ▶ Saving images with an external device
- ▶ Customizing your camcorder
- ▶ Troubleshooting
- ▶ Maintenance and precautions

[⇒ Contents list](#)

REC Mode

▼ On image quality

You can switch the recording mode to select the movie quality when recording high definition image quality (HD) movies. The recording time of the recording media is changed depending on the recording mode.

1. **MENU** → [Image Quality/Size] → [**REC Mode**].



2. Select the desired recording mode.



* appears on a medium icon if a movie recorded with the selected recording mode cannot be copied on that medium.

On image quality

The image quality and the bit-rate for each recording mode can be set as follows. "M," such as in "24M," means "Mbps."

For high definition image quality (HD):

- [Highest Quality **FX**]: 1920 × 1080/60i quality, AVC HD 24M (FX)
- [High Quality **FH**]: 1920 × 1080/60i quality, AVC HD 17M (FH)
- [Standard **HQ**]: 1440 × 1080/60i quality, AVC HD 9M (HQ)*¹
- [Long Time **LP**]: 1440 × 1080/60i quality, AVC HD 5M (LP)

*¹ The default setting

For standard definition image quality (STD):

- [Standard **HQ**]: Standard quality, Standard STD 9M (HQ)*¹

*¹ Standard image quality (STD) is fixed to this value.

Related topics

[Types of media devices on which the images can be saved](#)

Recording standard definition image quality (STD) movie: [[HD/STD Setting](#)]

[Disc creation guide](#)

- ▶ Operation Search
- ▶ Before use
- ▶ Getting started
- ▶ Recording
- ▶ Playback
- ▶ Saving images with an external device
- ▶ Customizing your camcorder
- ▶ Troubleshooting
- ▶ Maintenance and precautions

[⇒ Contents list](#)

HD/STD Setting

You can select the image quality of movies.

1. **MENU** → [Image Quality/Size] → [**HD**/**STD** Setting].



2. Select the desired item.

✓	HD HD Quality Records movies in High definition image quality (HD).
	STD STD Quality Records movies in standard definition image quality (STD). This setting is highly-compatible with other playback devices.

Notes

- When you play or edit movies, only movies with the selected image quality will be displayed on your camcorder.

[▲ Back to top](#)

- ▶ Operation Search
- ▶ Before use
- ▶ Getting started
- ▶ Recording
- ▶ Playback
- ▶ Saving images with an external device
- ▶ Customizing your camcorder
- ▶ Troubleshooting
- ▶ Maintenance and precautions

[⇒ Contents list](#)

Wide Mode

When recording standard definition image quality (STD) movies, you can select the horizontal to vertical ratio.

1. MENU → [Image Quality/Size] → [ Wide Mode].



2. Select the desired item.

✓	16:9 WIDE Records movies to the full screen on a 16:9 (wide) TV screen.
	4:3 () Records movies to the full screen on a 4:3 TV screen.

Notes

- For details on the horizontal/vertical ratio of the TV that will be connected, refer to the instruction manuals of the TV.

Related topics

[\[TV Type\]](#)

[▲ Back to top](#)

Copyright 2012 Sony Corporation

- ▶ Operation Search
- ▶ Before use
- ▶ Getting started
- ▶ Recording
- ▶ Playback
- ▶ Saving images with an external device
- ▶ Customizing your camcorder
- ▶ Troubleshooting
- ▶ Maintenance and precautions

[⇒ Contents list](#)

x.v.Color

You can capture wider range of colors. Various colors such as the brilliant color of flowers and turquoise blue of the sea can be more faithfully reproduced. Refer to the instruction manuals of the TV.

1. MENU → [Image Quality/Size] → [ x.v.Color].



2. Select the desired item.

<input checked="" type="checkbox"/>	Off Records in ordinary color range.
<input type="checkbox"/>	On ((COLOR)) Select this setting if the recorded movies will be played back on an x.v.Color-compliant TV.

Notes

- If the movie recorded with this function [On] is played back on a non-x.v.Color-compliant TV, the color may not be reproduced correctly.

[▲ Back to top](#)

- ▶ Operation Search
- ▶ Before use
- ▶ Getting started
- ▶ Recording
- ▶ Playback
- ▶ Saving images with an external device
- ▶ Customizing your camcorder
- ▶ Troubleshooting
- ▶ Maintenance and precautions

[⇒ Contents list](#)

Image Size

You can select a size for the photos you are going to shot.

1. **MENU** → [Image Quality/Size] → [ Image Size].



2. Select the desired item.



Notes

- The image size selected with this setting takes effect for photos taken by the Dual Capture function [\[Details\]](#).

Related topics

[Expected number of recordable photos](#)

[▲ Back to top](#)

Copyright 2012 Sony Corporation

- ▶ [Operation Search](#)
- ▶ [Before use](#)
- ▶ [Getting started](#)
- ▶ [Recording](#)
- ▶ [Playback](#)
- ▶ [Saving images with an external device](#)
- ▶ [Customizing your camcorder](#)
- ▶ [Troubleshooting](#)
- ▶ [Maintenance and precautions](#)

[⇒ Contents list](#)

Event View

You can display the Event View screen.

1. **MENU** → [Playback Function] → [Event View].



Related topics

[Playing movies and photos from the Event View screen](#)

[▲ Back to top](#)

▶ Operation Search

▶ Before use

▶ Getting started

▶ Recording

▶ Playback

▶ Saving images with an external device

▶ Customizing your camcorder

▶ Troubleshooting

▶ Maintenance and precautions

[⇒ Contents list](#)

Highlight Movie

You can view the Highlight Movie you have saved.

1. **MENU** → [Playback Function] → [Highlight Movie].



2. Select the desired Highlight Movie.

Related topics

[Converting Highlight Playback scenes or Highlight Scenarios to standard definition image quality \(STD\) \(Highlight Movie\)](#)

[▲ Back to top](#)

Copyright 2012 Sony Corporation

- ▶ Operation Search
- ▶ Before use
- ▶ Getting started
- ▶ Recording
- ▶ Playback
- ▶ Saving images with an external device
- ▶ Customizing your camcorder
- ▶ Troubleshooting
- ▶ Maintenance and precautions

[⇒ Contents list](#)

Scenario

You can view Highlight Scenario that you have saved.

1. **MENU** → [Playback Function] → [.



2. Select the desired scenario.

Related topics

[Saving Highlight Playback in high definition image quality \(HD\) \(Scenario Save\)](#)

[▲ Back to top](#)

- ▶ Operation Search
- ▶ Before use
- ▶ Getting started
- ▶ Recording
- ▶ Playback
- ▶ Saving images with an external device
- ▶ Customizing your camcorder
- ▶ Troubleshooting
- ▶ Maintenance and precautions

[⇒ Contents list](#)

Delete

▼ To delete a part of a movie

1. **MENU** → [Edit/Copy] → [Delete].



2. Select the desired setting ([Multiple Images] or [All In Event]).

Multiple Images

Select the type of image you want to delete, add check marks ✓ to the desired images, and then select **OK** → **OK**.



All In Event

You can delete all images in the selected date at one time.

Select the date you want to delete using **▲**/**▼**, and then select **OK** → **OK**.



■ To delete a part of a movie

You can divide a movie and delete it.

Notes

- You cannot restore images once they are deleted. Save important movies and photos in advance.
- Do not remove the battery pack or the AC Adaptor from your camcorder while deleting the images. It may damage the recording media.
- Do not eject the memory card while deleting images from the memory card.
- If you delete movies/photos that are included in saved scenarios, the scenarios will also be deleted.

Related topics

Release protection: [[Protect](#)]

[[Format](#)]

To divide a movie: [Dividing a movie](#)

[▲ Back to top](#)

Copyright 2012 Sony Corporation

- ▶ Operation Search
- ▶ Before use
- ▶ Getting started
- ▶ Recording
- ▶ Playback
- ▶ Saving images with an external device
- ▶ Customizing your camcorder
- ▶ Troubleshooting
- ▶ Maintenance and precautions

[⇒ Contents list](#)

Protect

▼ To remove the protection of an event

Protect movies and photos to avoid deleting them by mistake.

☞ will be displayed on the protected images.

1. MENU → [Edit/Copy] → [Protect].



2. Select the desired setting ([Multiple Images] or [Set All In Event]).

Multiple Images

Select the type of image you want to protect, add check marks ✓ to the desired images, and then select OK → OK.

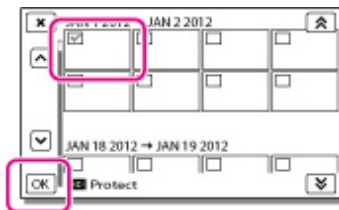

- You can select multiple images.
- Select the image with ✓ so that the ✓ mark disappears and you can remove the protection.

Set All In Event

You can protect all images in the selected date at one time.

Select the date you want to protect using ▲/▼, and then select OK → OK.



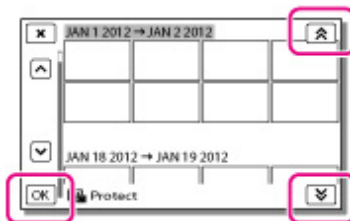

- You cannot select multiple dates.



■ To remove the protection of an event

You can remove the protection from all images in the selected date at one time.

In step 2 above, select [Remove All In Event], select the date you want to remove the protection using

/ , and then select  → .

[▲ Back to top](#)

Copyright 2012 Sony Corporation

- ▶ Operation Search
- ▶ Before use
- ▶ Getting started
- ▶ Recording
- ▶ Playback
- ▶ Saving images with an external device
- ▶ Customizing your camcorder
- ▶ Troubleshooting
- ▶ Maintenance and precautions

[⇒ Contents list](#)

Copy (HDR-CX210)

You can copy images back and forth between the internal recording medium of your camcorder and the memory card. The original copy of the image will not be deleted after the copy operation has been completed.

Select the source and the destination for the images to be copied after you select [Copy].

1. Press  (View Images).
2. **MENU** → [Edit/Copy] → [Copy].



3. Select the desired setting ([Multiple Images] or [All In Event]).

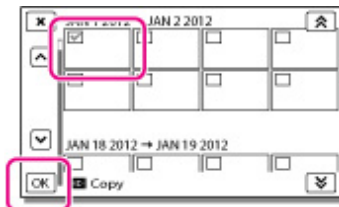

Multiple Images

Select the type of image you want to copy, add check marks ✓ to the desired images, and then select **OK** → **OK**.



- You can select multiple images.

All In Event

You can copy all images in the selected date at one time. Select the date you want to copy using  / , and then select **OK** → **OK**.

- You cannot select multiple dates.



Notes

- When you record an image on the memory card for the first time, create the image database file by selecting **MENU** → [Setup] →  [Media Settings] → [Repair Img. DB F.] → [Memory Card].
- Connect your camcorder to the wall outlet (wall socket) using the supplied AC Adaptor to prevent your camcorder from running out of power during copy.

Related topics

Checking the image copied: [\[Media Select \(HDR-CX210\)\]](#)

[Saving images on an external media device easily](#)

[▲ Back to top](#)



Copyright 2012 Sony Corporation

- ▶ Operation Search
- ▶ Before use
- ▶ Getting started
- ▶ Recording
- ▶ Playback
- ▶ Saving images with an external device
- ▶ Customizing your camcorder
- ▶ Troubleshooting
- ▶ Maintenance and precautions

[⇒ Contents list](#)

Direct Copy

You can save images on an external media device (USB storage device) manually while the device is connected to your camcorder. You can perform this operation while the camcorder is displaying the event view of the external device connected.

1. Press  (View Images).
2.  → [Edit/Copy] → [Direct Copy].



3. Follow the instructions that appear on the LCD screen.

Related topics

[Saving images on an external media device easily](#)

[▲ Back to top](#)

- ▶ Operation Search
- ▶ Before use
- ▶ Getting started
- ▶ Recording
- ▶ Playback
- ▶ Saving images with an external device
- ▶ Customizing your camcorder
- ▶ Troubleshooting
- ▶ Maintenance and precautions

[⇒ Contents list](#)

Media Select (HDR-CX210)

You can select the recording medium on which the images will be saved.

1. **MENU** → [Setup] → [ Media Settings] → [Media Select].



2. Select the desired recording medium.

[▲ Back to top](#)

- ▶ Operation Search
- ▶ Before use
- ▶ Getting started
- ▶ Recording
- ▶ Playback
- ▶ Saving images with an external device
- ▶ Customizing your camcorder
- ▶ Troubleshooting
- ▶ Maintenance and precautions

[⇒ Contents list](#)

Media Info

You can check the remaining recordable time for movies and the approximate free and used media space of the recording media.

1. **MENU** → [Setup] → [ Media Settings] → [Media Info].



2. Select the recording medium that you want to view the information.

Note

- Since there is a management file area, the used space is not displayed as 0 % even if you perform [Format]. [\[Details\]](#)

Related topics

[\[Media Select \(HDR-CX210\)\]](#)

[▲ Back to top](#)

Copyright 2012 Sony Corporation

- ▶ Operation Search
- ▶ Before use
- ▶ Getting started
- ▶ Recording
- ▶ Playback
- ▶ Saving images with an external device
- ▶ Customizing your camcorder
- ▶ Troubleshooting
- ▶ Maintenance and precautions

[⇒ Contents list](#)

Format

▼ To prevent data on the internal recording media from being recovered (HDR-CX210)

Formatting deletes all the movies and photos to recover recordable free space.

1. → [Setup] → [Media Settings] → [Format].



2. Select the recording medium that you want to format, and then select .

Notes

- Connect your camcorder to the wall outlet (wall socket) using the supplied AC Adaptor for this operation. [\[Details\]](#)
- To avoid the loss of important images, you should save them before formatting the recording media.
- Protected movies and photos will also be deleted.
- Make sure not to do the following while [Executing...] is displayed.
 - Open/Close the LCD screen.
 - Operate buttons on the camcorder.
 - Eject the memory card from your camcorder.
 - Disconnect the AC Adaptor.

▼ To prevent data on the internal recording media from being recovered (HDR-CX210)

When you dispose of or transfer the camcorder, it is recommended that you perform [Empty] to prevent the leakage of your personal data.

When the internal recording media is selected on the [Format] screen, select [Empty].

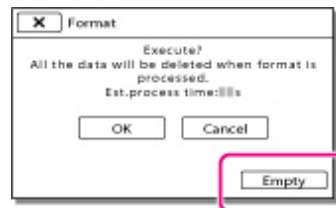

- You cannot perform [Empty] unless you connect the AC Adaptor to the wall outlet (wall socket).
- To avoid the loss of important images, they should be saved on a computer or other devices before performing [Empty].
- Disconnect all cables except the AC Adaptor. Do not disconnect the AC Adaptor during the operation.
- While deleting data, do not apply any vibrations or shocks to your camcorder.
- You can check the time that the camcorder will take to delete data on the LCD screen.
- If you stop performing [Empty] while [Executing...] appears, be sure to complete the operation by performing [Format] or [Empty] when you use the camcorder next time.

[▶ Operation Search](#)[▶ Before use](#)[▶ Getting started](#)[▶ Recording](#)[▶ Playback](#)[▶ Saving images with an external device](#)[▶ Customizing your camcorder](#)[▶ Troubleshooting](#)[▶ Maintenance and precautions](#)[⇒ Contents list](#)

Repair Img. DB F.

The camcorder may be able to repair the damaged database file using this menu item.

1. **MENU** → [Setup] → [ Media Settings] → [Repair Img. DB F.].



2. Select the recording medium that you want to repair, and then select **OK**.

[▲ Back to top](#)

- ▶ Operation Search
- ▶ Before use
- ▶ Getting started
- ▶ Recording
- ▶ Playback
- ▶ Saving images with an external device
- ▶ Customizing your camcorder
- ▶ Troubleshooting
- ▶ Maintenance and precautions

[⇒ Contents list](#)

File Number

You can select the way to assign file number of photos.

1. **MENU** → [Setup] → [Media Settings] → [File Number].



2. Select the desired item.

✓	Series Assigns file numbers of photos in sequence. The file number becomes larger each time you record a photo. Even if the memory card is replaced with another one, the file number is assigned in sequence.
	Reset Assigns file numbers in sequence, following the largest file number existing on the recording medium. When the memory card is replaced with another one, the file number is assigned for each memory card.

[▲ Back to top](#)

- ▶ Operation Search
- ▶ Before use
- ▶ Getting started
- ▶ Recording
- ▶ Playback
- ▶ Saving images with an external device
- ▶ Customizing your camcorder
- ▶ Troubleshooting
- ▶ Maintenance and precautions

[⇒ Contents list](#)

Data Code

During playback, your camcorder displays the information recorded automatically at the time of recording. You can check the following information.

1. **MENU** → [Setup] → [Playback Settings] → [Data Code].



2. Select the desired item.

✓	Off Data code is not displayed.
	Date/Time Displays the date and time.
	Camera Data Displays camera setting data.

Date/Time

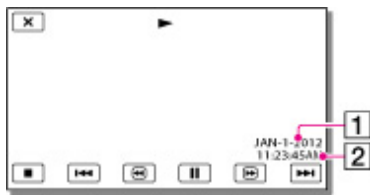

1 Date

2 Time

Camera Data

Movie

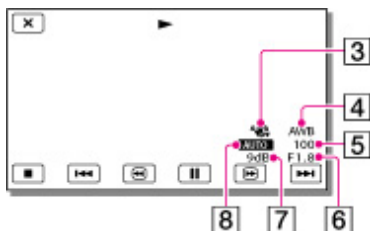

Photo



- 3** SteadyShot off
- 4** White Balance
- 5** Shutter Speed
- 6** IRIS (Aperture value)
- 7** Gain
- 8** Brightness
- 9** Exposure

Notes

- The data code is displayed on the TV screen if you connect your camcorder to a TV.
- Depending on the recording media condition, [--:--:--] may appear.

[▲ Back to top](#)

Copyright 2012 Sony Corporation

- ▶ Operation Search
- ▶ Before use
- ▶ Getting started
- ▶ Recording
- ▶ Playback
- ▶ Saving images with an external device
- ▶ Customizing your camcorder
- ▶ Troubleshooting
- ▶ Maintenance and precautions



[⇒ Contents list](#)

Volume

You can adjust the volume of playback sound.

1. **MENU** → [Setup] → [▶ Playback Settings] → [Volume].



2. Adjust the volume using  / .

[▲ Back to top](#)

[▶ Operation Search](#)[▶ Before use](#)[▶ Getting started](#)[▶ Recording](#)[▶ Playback](#)[▶ Saving images with an external device](#)[▶ Customizing your camcorder](#)[▶ Troubleshooting](#)[▶ Maintenance and precautions](#)[⇒ Contents list](#)

Download Music

You can transfer music files from audio CDs or MP3 files to your camcorder by connecting the camcorder to a computer. To transfer music files, use "Music Transfer."

1. **MENU** → [Setup] → [▶ Playback Settings] → [Download Music].



2. Follow the instructions that appear on the display.
For details, refer to "Music Transfer" Help.

[▲ Back to top](#)

[▶ Operation Search](#)[▶ Before use](#)[▶ Getting started](#)[▶ Recording](#)[▶ Playback](#)[▶ Saving images with an external device](#)[▶ Customizing your camcorder](#)[▶ Troubleshooting](#)[▶ Maintenance and precautions](#)[⇒ Contents list](#)

Empty Music

You can delete all music files stored on the camcorder.

1. **MENU** → [Setup] → [▶ Playback Settings] → [Empty Music].



2. Select [OK] or [Cancel].

Notes

- If you delete music files using [Empty Music], the music data recorded on your camcorder at the factory will be deleted as well.

[▲ Back to top](#)

- ▶ Operation Search
- ▶ Before use
- ▶ Getting started
- ▶ Recording
- ▶ Playback
- ▶ Saving images with an external device
- ▶ Customizing your camcorder
- ▶ Troubleshooting
- ▶ Maintenance and precautions

[⇒ Contents list](#)

TV Type

You need to convert the signal depending on the TV connected when playing back movies and photos. The recorded movies and photos are played back as following illustrations.

1. **MENU** → [Setup] → [Connection] → [TV Type].



2. Select the desired item.

✓	16:9 Select this to view your movies on a 16:9 (wide) TV.	
	Movies and photos recorded in 16:9 (wide) mode 	Movies and photos recorded in 4:3 mode
	4:3 Select this to view your movies and photos on a 4:3 standard TV.	
	Movies and photos recorded in 16:9 (wide) mode 	Movies and photos recorded in 4:3 mode

Notes

- Horizontal to vertical ratio of high definition image quality (HD) movies is 16:9.

[▲ Back to top](#)

- ▶ Operation Search
- ▶ Before use
- ▶ Getting started
- ▶ Recording
- ▶ Playback
- ▶ Saving images with an external device
- ▶ Customizing your camcorder
- ▶ Troubleshooting
- ▶ Maintenance and precautions

[⇒ Contents list](#)

HDMI Resolution

Select the output image resolution when connecting your camcorder to a TV with an HDMI cable.

1. MENU → [Setup] → [Connection] → [HDMI Resolution].



2. Select the desired item.

✓	Auto Normal setting (outputs the signal according to the TV automatically).
	1080p/480p Outputs high definition image quality (HD) movies with a 1080p signal and standard image quality (STD) movies with a 480p signal.
	1080i/480i Outputs high definition image quality (HD) movies with a 1080i signal and standard image quality (STD) movies with a 480i signal.
	720p/480p Outputs high definition image quality (HD) movies with a 720p signal and standard image quality (STD) movies with a 480p signal.
	480p Outputs the 480p signal.
	480i Outputs the 480i signal.

[▲ Back to top](#)

- ▶ Operation Search
- ▶ Before use
- ▶ Getting started
- ▶ Recording
- ▶ Playback
- ▶ Saving images with an external device
- ▶ Customizing your camcorder
- ▶ Troubleshooting
- ▶ Maintenance and precautions

[⇒ Contents list](#)

CTRL FOR HDMI (Control for HDMI)

When connecting your camcorder to a "BRAVIA" Sync compatible TV with a HDMI cable, you can play back movies on your camcorder by aiming the TV's Remote Commander at the TV. [\[Details\]](#)

1. **MENU** → [Setup] → [Connection] → [CTRL FOR HDMI].



2. Select the desired item.

✓	On Operates your camcorder using the TV's Remote Commander.
	Off Does not operate your camcorder using the TV's Remote Commander.

[▲ Back to top](#)

- ▶ Operation Search
- ▶ Before use
- ▶ Getting started
- ▶ Recording
- ▶ Playback
- ▶ Saving images with an external device
- ▶ Customizing your camcorder
- ▶ Troubleshooting
- ▶ Maintenance and precautions

[⇒ Contents list](#)

USB Connect

Select this item when [USB Select] does not appear on the LCD screen even when you connect the camcorder to an external device with the USB Cable.

1. **MENU** → [Setup] → [Connection] → [USB Connect].



[▲ Back to top](#)

- ▶ Operation Search
- ▶ Before use
- ▶ Getting started
- ▶ Recording
- ▶ Playback
- ▶ Saving images with an external device
- ▶ Customizing your camcorder
- ▶ Troubleshooting
- ▶ Maintenance and precautions

[⇒ Contents list](#)

USB Connect Setting

You can set the USB transfer mode for connecting the camcorder to a computer or other USB device.

1. **MENU** → [Setup] → [Connection] → [USB Connect Setting].



2. Select the desired item.

✓	Auto The camcorder automatically selects the USB transfer mode depending on the connected device.
	MTP This is a USB transfer mode compatible with certain types of computers.
	Mass Storage This is a USB transfer mode compatible with many types of USB devices.

Notes

- When you connect the camcorder to other devices using the [MTP] mode, movies that have been recorded with the same image quality as the one currently selected (selected with the [/ Setting] menu) can only be displayed on the connected device.
- When the camcorder is connected to an external device in the [MTP] mode, movie files will be displayed with the recorded date, however, some information, such as area information, included in the movie files cannot be displayed on the connected device. To import images from the camcorder to your computer, use the built-in "PlayMemories Home" software.
- If the "Device Stage*" window does not open when you connect the camcorder to a computer equipped with Windows 7, set [USB Connect Setting] to [Auto].

* "Device Stage" is a menu of Windows 7, that is used to manage devices (camcorder, camera, etc.) that are connected to the computer.

[▲ Back to top](#)

- ▶ Operation Search
- ▶ Before use
- ▶ Getting started
- ▶ Recording
- ▶ Playback
- ▶ Saving images with an external device
- ▶ Customizing your camcorder
- ▶ Troubleshooting
- ▶ Maintenance and precautions

[⇒ Contents list](#)

USB LUN Setting

Improves compatibility with external devices by limiting the functions of the USB connection.

1. **MENU** → [Setup] → [Connection] → [USB LUN Setting].



2. Select the desired item.

✓	Multi Use this setting for ordinary operations.
	Single Try this setting only if you cannot connect to an external device.

Notes

- When you install the built-in "PlayMemories Home" software on your computer, set [USB LUN Setting] to [Multi].

[▲ Back to top](#)

▶ Operation Search

▶ Before use

▶ Getting started

▶ Recording

▶ Playback

▶ Saving images with an external device

▶ Customizing your camcorder

▶ Troubleshooting

▶ Maintenance and precautions

[⇒ Contents list](#)

Disc Burn

1. **MENU** → [Setup] → [ Connection] → [Disc Burn].



2. Follow the instructions that appear on the screen.

[▲ Back to top](#)

- ▶ Operation Search
- ▶ Before use
- ▶ Getting started
- ▶ Recording
- ▶ Playback
- ▶ Saving images with an external device
- ▶ Customizing your camcorder
- ▶ Troubleshooting
- ▶ Maintenance and precautions

[⇒ Contents list](#)

Beep

You can turn on or off the operation sound.

1. **MENU** → [Setup] → [ General Settings] → [Beep].



2. Select the desired item.

✓	On A melody sounds when you start/stop recording, or operate your camcorder.
	Off Cancels the melody.

[▲ Back to top](#)

- ▶ Operation Search
- ▶ Before use
- ▶ Getting started
- ▶ Recording
- ▶ Playback
- ▶ Saving images with an external device
- ▶ Customizing your camcorder
- ▶ Troubleshooting
- ▶ Maintenance and precautions

[⇒ Contents list](#)

LCD Brightness

You can adjust the brightness of the LCD screen.

1. **MENU** → [Setup] → [General Settings] → [LCD Brightness].



2. Select the desired item.

✓	Normal Normal setting (normal brightness).
	Bright Select this when the LCD screen is not bright enough. This adjustment does not affect the recorded images in any way.

[▲ Back to top](#)

[▶ Operation Search](#)[▶ Before use](#)[▶ Getting started](#)[▶ Recording](#)[▶ Playback](#)[▶ Saving images with an external device](#)[▶ Customizing your camcorder](#)[▶ Troubleshooting](#)[▶ Maintenance and precautions](#)[⇒ Contents list](#)

Language Setting

You can select the language to be used on the LCD screen.

The camcorder offers [ENG[SIMP]] (simplified English) for when you cannot find your native tongue among the options.

1. **MENU** → [Setup] → [ General Settings] → [Language Setting].



2. Select the desired language.

[▲ Back to top](#)

- ▶ Operation Search
- ▶ Before use
- ▶ Getting started
- ▶ Recording
- ▶ Playback
- ▶ Saving images with an external device
- ▶ Customizing your camcorder
- ▶ Troubleshooting
- ▶ Maintenance and precautions

[⇒ Contents list](#)

Calibration (HDR-CX200/CX210/PJ200)

Use this function if the buttons on the touch panel does not work correctly.

It is recommended that you connect your camcorder to the wall outlet (wall socket) using the supplied AC Adaptor during the operation.

1. **MENU** → [Setup] → [General Settings] → [Calibration].



2. Touch "X" displayed on the screen with the corner of memory card or the like 3 times.

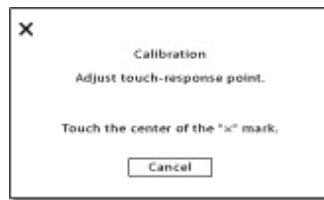

Touch [Cancel] to cancel calibration.

Notes

- If you did not press the right spot, try the calibration again.
- Do not use a sharp-pointed object for calibration. Doing so may damage the LCD screen.
- You cannot calibrate the LCD screen if it is rotated, or closed with the screen facing out.

[▲ Back to top](#)

- ▶ Operation Search
- ▶ Before use
- ▶ Getting started
- ▶ Recording
- ▶ Playback
- ▶ Saving images with an external device
- ▶ Customizing your camcorder
- ▶ Troubleshooting
- ▶ Maintenance and precautions

[⇒ Contents list](#)

Battery Info

You can check the estimated remaining capacity of the battery.

1. **MENU** → [Setup] → [General Settings] → [Battery Info].



The battery information appears.

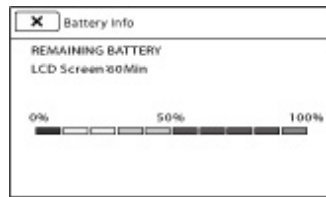

To close the screen, select **X**.

[▲ Back to top](#)

- ▶ Operation Search
- ▶ Before use
- ▶ Getting started
- ▶ Recording
- ▶ Playback
- ▶ Saving images with an external device
- ▶ Customizing your camcorder
- ▶ Troubleshooting
- ▶ Maintenance and precautions

[⇒ Contents list](#)

Eco Mode

You can change the setting for the backlight of the LCD screen and the power status of the camcorder.

1. MENU → [Setup] → [ General Settings] → [Eco Mode].



2. Select the desired item.

Off	The backlight of the LCD screen is always on brightly. The camcorder does not turn off automatically.
✓ Standard	The backlight of the LCD screen turns off automatically if you do not attempt to operate your camcorder for more than about 1 minute. The camcorder turns off automatically if you do not attempt to operate your camcorder for more than about 2 minutes.
Max ()	The brightness of the LCD screen is adjusted to the surrounding brightness automatically. The backlight of the LCD screen turns off automatically if you do not attempt to operate your camcorder for more than about 15 seconds. The camcorder turns off automatically if you do not attempt to operate your camcorder for more than about 1 minute.

[▲ Back to top](#)

- ▶ Operation Search
- ▶ Before use
- ▶ Getting started
- ▶ Recording
- ▶ Playback
- ▶ Saving images with an external device
- ▶ Customizing your camcorder
- ▶ Troubleshooting
- ▶ Maintenance and precautions

[⇒ Contents list](#)

Demo Mode

Sets playback of the demonstration movie about the functions of the camcorder.

When the camcorder is connected to a wall outlet (wall socket) and no operation is attempted within a certain period with the movie recording mode or the Event View mode set, a demonstration movie starts playing.

1. **MENU** → [Setup] → [General Settings] → [Demo Mode].



2. Select the desired item.

✓	<p>On The demonstration appears.</p> <p>HDR-CX190/CX200/CX210: You can set the interval after which a demonstration begins to play when there has been no operation attempted for the specified period of time.</p> <p>HDR-PJ200: You can select whether to use the LCD or the projector to display the demonstration that plays when there has been no operation attempted for a specified period of time.</p>
	<p>Off The demonstration does not appear.</p>

Notes

- In the default setting, the demonstration movie is in the Event View. If you delete the demonstration movie, you cannot recover it (HDR-CX210).
- A movie you have recorded will be registered as the demonstration movie if it satisfies all of the following conditions (HDR-CX210).
 - The movie is protected.
 - The movie is the one that was recorded first.
 - The movie is saved on the internal recording media.
 - The movie is recorded with high definition image quality (HD).
- When you operate your camcorder, the demonstration playback will be suspended. (It appears again if no operation is attempted for more than the specified period of time you set in [Demo Mode].)

[▲ Back to top](#)

- ▶ Operation Search
- ▶ Before use
- ▶ Getting started
- ▶ Recording
- ▶ Playback
- ▶ Saving images with an external device
- ▶ Customizing your camcorder
- ▶ Troubleshooting
- ▶ Maintenance and precautions

[⇒ Contents list](#)

Date & Time Setting

1. **MENU** → [Setup] → [Clock Settings] → [Date & Time Setting].



2. Select the desired item ([Date & Time Format], [Summer Time], or [Date & Time]).

Date & Time Format

You can select one from 4 types of date and time format.

Daylight Savings/Summer Time

You can change this setting without stopping the clock.

✓	Off Does not set the summertime.
	On Sets the summertime. The clock is set to move the time forward 1 hour.

Date & Time

You can set the clock.

[▲ Back to top](#)

- ▶ Operation Search
- ▶ Before use
- ▶ Getting started
- ▶ Recording
- ▶ Playback
- ▶ Saving images with an external device
- ▶ Customizing your camcorder
- ▶ Troubleshooting
- ▶ Maintenance and precautions

[⇒ Contents list](#)

Area Setting

You can adjust a time difference without stopping the clock. Select your local area when using the camcorder in other time zones.

1. **MENU** → [Setup] → [Clock Settings] → [Area Setting].



2. Select the desired item.

✓	Home Select this item when you are going to use the camcorder in the area where you are living.
	Destination (📍) Select this item when you want to use the camcorder with the area setting set to another place.

Related topics

[World time difference](#)

[▲ Back to top](#)

[▶ Operation Search](#)[▶ Before use](#)[▶ Getting started](#)[▶ Recording](#)[▶ Playback](#)[▶ Saving images with an external device](#)[▶ Customizing your camcorder](#)[▶ Troubleshooting](#)[▶ Maintenance and precautions](#)[⇒ Contents list](#)

If you have problems

If you run into any problems using your camcorder, follow the steps below.

1. Check the items under "Troubleshooting", and inspect your camcorder.
If a code such as "C:(or E:) □ □ : □ □ " appears on the screen, see "Self-diagnosis display/Warning indicators".
2. Disconnect the power source, attach the power source again after about 1 minute, and turn the camcorder on.
3. Press RESET using a pointed object, and turn the camcorder on. [\[Details\]](#)
 - If you press RESET, all settings, including the clock setting, are reset.
4. Contact your Sony dealer or local authorized Sony service facility.
 - During repair, we may check a minimum amount of data stored on the internal memory in order to investigate the problem. However, your Sony dealer will neither copy nor retain your data.
 - Additional information on this product and answers to frequently asked questions can be found at our Customer Support Website.
<http://www.sony.net/>

[▲ Back to top](#)

Copyright 2012 Sony Corporation

[▶ Operation Search](#)[▶ Before use](#)[▶ Getting started](#)[▶ Recording](#)[▶ Playback](#)[▶ Saving images with an external device](#)[▶ Customizing your camcorder](#)[▶ Troubleshooting](#)[▶ Maintenance and precautions](#)[⇒ Contents list](#)

Overall operations



The power does not turn on.

- Attach a charged battery pack to the camcorder. [\[Details\]](#)
- The plug of the AC Adaptor has been disconnected from the wall outlet (wall socket). Connect it to the wall outlet (wall socket). [\[Details\]](#)

The camcorder does not operate even when the power is set to on.

- It takes a few seconds for your camcorder to be ready to shoot after the power is turned on. This is not a malfunction.
- Disconnect the AC Adaptor from the wall outlet (wall socket) or remove the battery pack, then reconnect it after about 1 minute. If the functions still do not work, press RESET using a pointed object. (If you press RESET, all settings, including the clock setting, are reset. [\[Details\]](#))
- The temperature of your camcorder is extremely high. Turn off your camcorder and leave it for a while in a cool place.
- The temperature of your camcorder is extremely low. Leave your camcorder with the power of your camcorder on. Turn off your camcorder and take it to a warm place. Leave the camcorder there for a while, then turn on your camcorder.

The menu settings have been changed automatically.

- While Intelligent Auto is active, some menu settings related to image quality will be changed automatically.
- The following menu items return to the default settings when you switch between movie recording and photo recording and playback modes.
 - [ Fader]
 - [ Self-Timer]
 - [Tele Macro]

The camcorder gets warm.

- Your camcorder may become warm during operation. This is not a malfunction.

Intelligent Auto is canceled.

- The Intelligent Auto setting is canceled if you change the following settings:
 - [White Balance]
 - [Spot Meter/Fcs] (HDR-CX200/CX210/PJ200)
 - [Spot Meter] (HDR-CX200/CX210/PJ200)
 - [Spot Focus] (HDR-CX200/CX210/PJ200)
 - [Exposure]
 - [Focus]
 - [Low Lux]
 - [Scene Selection]
 - [Tele Macro]

- [ SteadyShot]
- [Auto Back Light]
- [Face Detection]

[▲ Back to top](#)

Copyright 2012 Sony Corporation

[▶ Operation Search](#)[▶ Before use](#)[▶ Getting started](#)[▶ Recording](#)[▶ Playback](#)[▶ Saving images with an external device](#)[▶ Customizing your camcorder](#)[▶ Troubleshooting](#)[▶ Maintenance and precautions](#)[⇒ Contents list](#)

Batteries/power sources

The power abruptly turns off.

- Use the AC Adaptor.
- In the default setting, when about 2 minutes have elapsed while you do not operate your camcorder, the camcorder is automatically turned off (Eco Mode). Change the setting of [Eco Mode], or turn on the power again. [\[Details\]](#)
- Charge the battery pack. [\[Details\]](#)

The CHG (charge) lamp does not light while the battery pack is being charged.

- Close the LCD screen. [\[Details\]](#)
- Attach the battery pack to the camcorder correctly. [\[Details\]](#)
- Connect the power cord (mains lead) to the wall outlet (wall socket) properly.
- The battery charge is completed. [\[Details\]](#)

The CHG (charge) lamp flashes while the battery pack is being charged.

- When the battery is being charged using the Built-in USB Cable, disconnect the Built-in USB Cable and connect it again.
- If the temperature of the battery pack is too high or too low, you may not be able to charge it. [\[Details\]](#)
- Attach the battery pack to the camcorder correctly. If the problem persists, disconnect the AC Adaptor from the wall outlet (wall socket) and contact your Sony dealer. The battery pack may be damaged. [\[Details\]](#)

The remaining battery time indicator does not indicate the correct time.

- The ambient temperature is too high or too low. This is not a malfunction.
- The battery pack has not been charged enough. Fully charge the battery again. If the problem persists, replace the battery pack with a new one. [\[Details\]](#)
- The indicated time may not be correct depending on the environment of use.

The battery pack is quickly discharged.

- The ambient temperature is too high or low. This is not a malfunction.
- The battery pack has not been charged enough. Fully charge the battery again. If the problem persists, replace the battery pack with a new one. [\[Details\]](#)

[▲ Back to top](#)

[▶ Operation Search](#)[▶ Before use](#)[▶ Getting started](#)[▶ Recording](#)[▶ Playback](#)[▶ Saving images with an external device](#)[▶ Customizing your camcorder](#)[▶ Troubleshooting](#)[▶ Maintenance and precautions](#)[⇒ Contents list](#)

LCD screen

Menu items are grayed out.

- You cannot select grayed items in the current recording/playback situation.
- There are some functions you cannot activate simultaneously.

The buttons do not appear on the LCD screen.

- Touch the LCD screen lightly. (HDR-CX200/CX210/PJ200)
- Press the multi-selector. (HDR-CX190)

The buttons on the touch panel do not work correctly or do not work at all. (HDR-CX200/CX210/PJ200)

- Adjust the touch panel ([Calibration]). [\[Details\]](#)

The buttons on the LCD screen quickly disappear.

- If you set [Display Setting] to [On], the buttons do not disappear from the LCD screen while in recording mode. [\[Details\]](#)

There are dots in the shape of a grid on the screen.

- These points are a normal result of the manufacturing process of the screen and do not affect the recording in any way.

The backlight of the LCD screen turns off if you do not attempt to operate your camcorder for a while.

- In the default setting, the backlight of the LCD screen turns off automatically if you do not attempt to operate your camcorder for more than about 1 minute. [\[Details\]](#)

[▲ Back to top](#)

▶ Operation Search

▶ Before use

▶ Getting started

▶ Recording

▶ Playback

▶ Saving images with an external device

▶ Customizing your camcorder

▶ Troubleshooting

▶ Maintenance and precautions

[⇒ Contents list](#)

Memory card

Operations using the memory card cannot be performed.

- If you use the memory card formatted on a computer, format it again on your camcorder. [\[Details\]](#)

Images stored on the memory card cannot be deleted.

- The maximum number of images that you can delete on the index screen at one time is 100.
- You cannot delete the protected images.

The data file name is not indicated correctly or flashes.

- The file is damaged.
- The file format is not supported by your camcorder. [\[Details\]](#)



[▲ Back to top](#)

[▶ Operation Search](#)[▶ Before use](#)[▶ Getting started](#)[▶ Recording](#)[▶ Playback](#)[▶ Saving images with an external device](#)[▶ Customizing your camcorder](#)[▶ Troubleshooting](#)[▶ Maintenance and precautions](#)[⇒ Contents list](#)



Recording

Refer also to "[Memory card](#)".

Pressing START/STOP or PHOTO does not record images.

- The playback screen is displayed. Press MODE to turn on the  (Movie) or  (Photo) lamp. [\[Details\]](#) [\[Details\]](#)
- Your camcorder is recording the image you have just shot on the recording media. You cannot make new recording during this period.
- The recording media is full. Delete unnecessary images. [\[Details\]](#)
- Total number of movie scenes or photos exceeds the recordable capacity of your camcorder. Delete unnecessary images. [\[Details\]](#) [\[Details\]](#)
- The temperature of your camcorder is extremely high. Turn off your camcorder and leave it for a while in a cool place.
- The temperature of your camcorder is extremely low. Turn off your camcorder and take it to a warm place. Leave the camcorder there for a while, then turn on the camcorder.

Photos cannot be recorded.

- You cannot record photos together with [ Fader].
- The camcorder cannot shoot photos while it is in the movie recording mode, depending on the [ REC Mode] selected.

The access lamp remains lit or flashing even if recording was stopped.

- Your camcorder is recording the scene you have just shot on the memory card.

The imaging field looks different.

- The imaging field may look different depending on the condition of your camcorder. This is not a malfunction.

The actual recording time for movies is less than the expected recording time of the recording media.

- Depending on the recording conditions, the time available for recording may be shorter, for example when recording a fast moving object, etc.

The camcorder stops operating.

- The temperature of your camcorder is extremely high. Turn off your camcorder and leave it for a while in a cool place.
- The temperature of your camcorder is extremely low. Turn off your camcorder and take it to a warm place. Leave the camcorder there for a while, then turn on the camcorder.

- If you keep applying vibration on the camcorder, recording may stop.

There is a time difference between the point when START/STOP is pressed and the point that the recording movie is started or stopped actually.

- On your camcorder, there may be a slight time difference between the point where you press START/STOP and the actual point that recording movie starts/stops. This is not a malfunction.



The horizontal to vertical ratio of the movie (16:9 (wide)/4:3) cannot be changed.

- The horizontal to vertical ratio of high definition image quality (HD) movies is 16:9 (wide).

The auto focus does not function.

- Set [Focus] to [Auto]. [\[Details\]](#)
- The recording conditions are not suitable for auto focus. Adjust the focus manually. [\[Details\]](#)

SteadyShot does not function.

- Set [ SteadyShot] to [Active] or [Standard]. [\[Details\]](#)
- Even if [ SteadyShot] is set to [Active] or [Standard], your camcorder may not be able to compensate for excessive vibrations.

Images cannot be recorded or played back correctly.

- If you record and delete images repeatedly for a long time, the files on the recording media may become fragmented and images cannot be recorded or played back correctly. After backing up the images on other media, format the recording media on your camcorder. [\[Details\]](#)

The subjects passing by the screen very fast appear crooked.

- This is called the focal plane phenomenon. This is not a malfunction. Because of the way the image device (CMOS sensor) reads out image signals, the subjects passing by the lens rapidly might appear crooked depending on the recording conditions.

Horizontal stripes appear on the images.

- This occurs when recording images under a fluorescent lamp, sodium lamp, or mercury lamp. This is not a malfunction.

Black bands appear when you record a TV screen or computer screen.

- Set [ SteadyShot] to an option except for [Active]. [\[Details\]](#)

LCD brightness cannot be set.

- You cannot set LCD brightness when:
 - The LCD panel is closed on your camcorder with the LCD screen facing out.
 - The power is supplied from the AC Adaptor.

Photos are recorded automatically.

- In the default setting, photos are recorded automatically when the camcorder detects a smile.

[▶ Operation Search](#)[▶ Before use](#)[▶ Getting started](#)[▶ Recording](#)[▶ Playback](#)[▶ Saving images with an external device](#)[▶ Customizing your camcorder](#)[▶ Troubleshooting](#)[▶ Maintenance and precautions](#)[⇒ Contents list](#)

Playback

Images cannot be played back.

- Select the type of recording media you want to play back. (HDR-CX210) [\[Details\]](#)
- Select the image quality of the movie you want to play back. [\[Details\]](#)
- Images recorded on other devices may not be played back. This is not a malfunction.

Photos cannot be played back.

- Photos cannot be played back if you have modified files or folders, or have edited the data on a computer. (The file name flashes in that case.) This is not a malfunction.



The movie freezes.

- Photos which were recorded while recording a movie are played back. In the default setting, movies and photos are played back continuously.

 is indicated on a thumbnail.

- This may appear on an image recorded on other devices, edited on a computer, etc.
- You removed the AC Adaptor or the battery pack while the recording media icon at the top right corner of the screen flashes, or before the access lamp is turned off after recording. This may damage your image data and  is displayed.

 is indicated on a thumbnail.

- The image data base file may be damaged.
- Check the data base file by selecting **MENU** → [Setup] → [ Media Settings] → [Repair Img. DB F.] → the recording medium (HDR-CX210). If it still appears, delete the image with . [\[Details\]](#)

No sound or only a quiet sound is heard during playback.

- Turn up the volume. [\[Details\]](#)
- When you record sound with [Micref Level] set to [Low], the recorded sound may be difficult to hear. [\[Details\]](#)

The demonstration movies cannot be played (HDR-CX210).

- Select the internal recording media for the recording media, and the high definition image quality (HD).
- The demonstration movie was deleted.

A movie is played back automatically (HDR-CX210).

- Movies play automatically as a demonstration movie when the filmed movie fulfills a certain condition on your camcorder. This is not a malfunction. [\[Details\]](#)

[▲ Back to top](#)

Copyright 2012 Sony Corporation

[Top page](#) > [Troubleshooting](#) > [Troubleshooting](#) > [Playing back images stored on memory card on other devices](#)

▶ Operation Search

▶ Before use

▶ Getting started

▶ Recording

▶ Playback

▶ Saving images with an external device

▶ Customizing your camcorder

▶ Troubleshooting

▶ Maintenance and precautions

[⇒ Contents list](#)

Playing back images stored on memory card on other devices

Images cannot be played back or the memory card is not recognized.

- The playback device does not support playing back memory cards. [\[Details\]](#)

[▲ Back to top](#)

Copyright 2012 Sony Corporation

▶ Operation Search

▶ Before use

▶ Getting started

▶ Recording

▶ Playback

▶ Saving images with an external device

▶ Customizing your camcorder

▶ Troubleshooting

▶ Maintenance and precautions

[⇒ Contents list](#)

Editing movies/photos on your camcorder

Unable to edit.

- Unable to edit because of the condition of the image.

A movie cannot be divided.

- A movie that is too short cannot be divided.
- Release the protection, and then divide.

The demonstration movies cannot be deleted.

- Release the protection, and then delete them.

A photo cannot be captured from a movie.

- The recording media where you want to save photos is full.

[▲ Back to top](#)

[▶ Operation Search](#)[▶ Before use](#)[▶ Getting started](#)[▶ Recording](#)[▶ Playback](#)[▶ Saving images with an external device](#)[▶ Customizing your camcorder](#)[▶ Troubleshooting](#)[▶ Maintenance and precautions](#)[⇒ Contents list](#)

Playback on the TV

Neither image nor sound is played on the connected TV.

- Images are not output from the HDMI OUT jack, if copyright protection signals are recorded in the images.

The top, bottom, right, and left edges of images are trimmed slightly on a connected TV.

- The LCD screen of your camcorder can display recording images across the entire screen (full pixel display). However, this may cause slight trimming of the top, bottom, right, and left edges of images when played back on a TV which is not compatible with full pixel display.
- It is recommended you record images using the outer frame of [Guide Frame] as a guide. [\[Details\]](#)

The image appears distorted on the 4:3 TV.

- This happens when viewing an image recorded in the 16:9 (wide) mode on a 4:3 TV. Set [TV Type] correctly and play back the image. [\[Details\]](#)

Black bands appear at the top and bottom of the screen of the 4:3 TV.

- This happens when viewing an image recorded in the 16:9 (wide) mode on a 4:3 TV. This is not a malfunction.

The images being played back do not appear on the LCD screen when you connect the camcorder to a TV and play back images.

- Highlight Playback or a scenario will not appear on the LCD screen of the camcorder while it is connected to a TV and play back images.

[▲ Back to top](#)

▶ Operation Search

▶ Before use

▶ Getting started

▶ Recording

▶ Playback

▶ Saving images with an external device

▶ Customizing your camcorder

▶ Troubleshooting

▶ Maintenance and precautions

[⇒ Contents list](#)

Copying/Connecting to other devices

Images are not copied correctly.

- You cannot copy images using the HDMI cable.
- The A/V connecting cable is not connected properly. Make sure to connect the cable to the input jack of another device. [\[Details\]](#)

[▲ Back to top](#)

▶ Operation Search

▶ Before use

▶ Getting started

▶ Recording

▶ Playback

▶ Saving images with an external device

▶ Customizing your camcorder

▶ Troubleshooting

▶ Maintenance and precautions

[⇒ Contents list](#)

Connecting to a computer

"PlayMemories Home" cannot be installed.

- Check the computer environment or installation procedure required to install "PlayMemories Home."

"PlayMemories Home" does not work correctly.

- Quit "PlayMemories Home" and restart your computer.

The camcorder is not recognized by the computer.

- Disconnect devices from the USB jack of the computer other than the keyboard, mouse, and your camcorder.
- Disconnect the Built-in USB Cable from the computer and your camcorder, and restart the computer, then connect the computer and your camcorder again in the correct order.
- When both the Built-in USB Cable and the USB jack of the camcorder are connected to the external devices at the same time, disconnect one that is not connected to a computer.

[▲ Back to top](#)

- ▶ Operation Search
- ▶ Before use
- ▶ Getting started
- ▶ Recording
- ▶ Playback
- ▶ Saving images with an external device
- ▶ Customizing your camcorder
- ▶ Troubleshooting
- ▶ Maintenance and precautions

[⇒ Contents list](#)

Self-diagnosis display

If indicators appear on the LCD screen, check the following.

If the problem persists even after you have tried to fix a couple of times, contact your Sony dealer or local authorized Sony service facility. In this case, when you contact them, give them all the numbers of the error code beginning with C or E.

You may hear a melody when some warning indicators appear on the screen.



C:(or E:) □ □ : □ □ (Self-diagnosis display)

C:04: □ □

- The battery pack is not an "InfoLITHIUM" battery pack (V series). Use an "InfoLITHIUM" battery pack (V series). [\[Details\]](#)
- Connect the DC plug of the AC Adaptor to the DC IN jack of your camcorder securely. [\[Details\]](#)

C:06: □ □

- The battery pack temperature is high. Change the battery pack or place it in a cool place.

C:13: □ □ / C:32: □ □

- Remove the power source. Reconnect it and operate your camcorder again.

E: □ □ : □ □

- Follow the steps from 2 on "[If you have problems](#)".

 (Battery level warning)

- The battery pack is nearly used up.
- Depending on the operating environment or battery conditions,  may flash, even if there are about 20 minutes remaining.

 (Warning indicator pertaining to battery pack temperature)

- The battery pack temperature is high. Change the battery pack or place it in a cool place.

 (Warning indicator pertaining to memory card)

Slow flashing

- Free spaces for recording images are running out. For the type of memory card you can use with your camcorder, see "[Types of memory card you can use with your camcorder](#)".

- No memory card is inserted. [\[Details\]](#)

Fast flashing

- There are not enough free spaces for recording images. After storing the images on other media, delete unnecessary images, or format the memory card. [\[Details\]](#) [\[Details\]](#)
- The image data base file may be damaged.
Check the data base file by selecting **MENU** → [Setup] → [Media Settings] → [Repair Img. DB F.] → the recording medium (HDR-CX210).
- The memory card is damaged.

(Warning indicators pertaining to memory card formatting)

- The memory card is damaged.
- The memory card is not formatted correctly. [\[Details\]](#)

(Warning indicator pertaining to incompatible memory card)

- Incompatible memory card is inserted. [\[Details\]](#)

(Warning indicator pertaining to the write-protect of the memory card)

- The memory card is write-protected.
- Access to the memory card was restricted on another device.

(Warning indicator pertaining to the external device)

- The image data base file may be damaged.
Check the data base file by selecting **MENU** → [Setup] → [Media Settings] → [Repair Img. DB F.] → the recording medium.
- The external device is damaged.

(Warning indicators pertaining to external device formatting)

- The external device is damaged.
- The external device is not formatted correctly

(Warning indicator pertaining to camera-shake warning)

- The camcorder is unsteady, so camera-shake easily occurs. Hold the camcorder steady with both hands and record the image. However, note that the camera-shake warning indicator does not disappear.

(Warning indicator pertaining to photo recording)

- The recording media is full.
- Photos cannot be recorded during processing. Wait for a while, then record.

[▲ Back to top](#)

- ▶ Operation Search
- ▶ Before use
- ▶ Getting started
- ▶ Recording
- ▶ Playback
- ▶ Saving images with an external device
- ▶ Customizing your camcorder
- ▶ Troubleshooting
- ▶ Maintenance and precautions

[⇒ Contents list](#)

If messages appear on the screen, follow the instructions.

Warning Indicators

 Cannot recognize the internal memory. Format and use again. (HDR-CX210)

- The internal recording medium of the camcorder is set differently from the default format. Performing [Format] may enable you to use your camcorder. This will delete all data in the internal recording medium. [\[Details\]](#)

Data error.

- An error occurred during reading or writing the internal recording media of the camcorder (HDR-CX210).
- This may occur when you keep applying shock on the camcorder.
- Movies recorded on other devices may not be played back.

The Image Database File is damaged. Do you want to create a new file?
HD movie management information is damaged. Create new information?

- The management file is damaged. When you select [Yes], a new management file is created. The old recorded images on the media cannot be played back (Image files are not damaged). If you execute [Repair Img. DB F.] after creating new information, playing back the old recorded images may become possible. If it does not work, copy the image using the built-in "PlayMemories Home" software.

There is no Image Database File Movies cannot be recorded or played Create a new file?

- You cannot record or play back movies because no movie management information exists. If you select [Yes], new management information is created and you can record or play back movies.

There is no HD movie management information. Create new information?

- You cannot record or play back movies because no high definition image quality (HD) movie management information exists. If you select [Yes], new management information is created and you can record or play back movies with high definition image quality (HD).
- You can record standard definition image quality (STD) movies or photos.

Inconsistencies found in image database file. Do you want to repair the image database file?

The Image Database File is damaged. Do you want to repair the Image Database File?

Inconsistencies found in image database file. Cannot record or play HD movies. Do you want to repair the image database file?

- You cannot record or play back movies because no movie management information exists. If you

select , new management information is created and you can record or play back movies.

Inconsistencies found in the image database file. Back up and recover. Recover, then import using the included PC software.

- Since the database information of high definition image quality (HD) movies has been damaged, there are inconsistencies between the information in the database and the information in the file. Select  to back up the high definition image quality (HD) movies and repair the database file. You cannot see the backed-up movies on the camcorder. By connecting the camcorder to a computer after repairing the database, you can import backed-up high definition image quality (HD) movies to the computer using the built-in "PlayMemories Home" software installed on the computer. However, it is not guaranteed that all movies can be imported to the computer.

Buffer overflow. Writing to the media was not completed in time.

- You have performed recording and erasing operations repeatedly, or a memory card that has been formatted by other device is used. Copy and take data backup to other device (such as a computer), and then format the memory card on the camcorder. [\[Details\]](#)
- The size of the inserted memory card is not sufficient for copying the movie(s). Use the recommended memory card. [\[Details\]](#)

Recovering data.

- Your camcorder tries to recover data automatically if the data writing was not performed properly.

Cannot recover data.

- Writing data onto the media of the camcorder has failed. Attempts were made to recover the data, but they were unsuccessful.

 Reinsert the memory card.

- Reinsert the memory card a few times. If even then the indicator flashes, the memory card could be damaged. Try with another memory card.

 Cannot recognize this memory card. Format and use again.

- Format the memory card. Note that if you format the memory card, all the recorded movies and photos are deleted. [\[Details\]](#)

 Still picture folder is full. Cannot record still pictures.

- You cannot create folders exceeding 999MSDCF. You cannot create or delete created folders using your camcorder.
- Format the memory card, or delete folders using your computer. [\[Details\]](#)

This memory card may not be able to record or play movies.

- Use a memory card recommended for your camcorder. [\[Details\]](#)

This memory card may not be able to record or play images correctly.

- Use a memory card recommended for your camcorder. [\[Details\]](#)

Do not eject the memory card during writing. Data may be damaged.

- Reinsert the memory card.

External media cannot execute functions.

- Check the data base file by selecting **MENU** → [Setup] → [Media Settings] → [Repair Img. DB F.] → the recording medium (HDR-CX210).
- If even then the indicator flashes, reconnect the external media device, and then perform the format. Note that if you format the external media device, all the recorded movies and photos in it are deleted.
- If you cannot perform the format, the external media may not be supported by the camcorder, or it may be damaged. Try with another external media.

Unable to access external media.

- Use the external media device in stable condition (the environment such as no vibration and room temperature, etc.).
- Make sure that the power source of the external media device is connected.

Other

Maximum number of images already selected.

- You can select only 100 images at one time for:
 - Deleting movies/photos
 - Protecting movies/photos, or releasing the protection
 - Copying movies/photos

Data protected.

- You tried to delete protected data. Release the protection of the data.

[▲ Back to top](#)

Copyright 2012 Sony Corporation

[Top page](#) > [Maintenance and precautions](#) > [Maintenance and precautions](#) > [About the AVCHD format](#)

- ▶ Operation Search
- ▶ Before use
- ▶ Getting started
- ▶ Recording
- ▶ Playback
- ▶ Saving images with an external device
- ▶ Customizing your camcorder
- ▶ Troubleshooting
- ▶ Maintenance and precautions

[⇒ Contents list](#)

About the AVCHD format

What is the AVCHD format?

The AVCHD format is a high definition digital video camera format used to record a high definition (HD) signal using efficient data compression coding technology. The MPEG-4 AVC/H.264 format is adopted to compress video data, and the Dolby Digital or Linear PCM system is used to compress audio data. The MPEG-4 AVC/H.264 format is capable of compressing images at higher efficiency than that of the conventional image compressing format.

- As the AVCHD format uses a compression coding technology, the picture may be disturbed in scenes where picture, field angles or brightness, etc. change drastically, but this is not a malfunction.

Recording and playback on your camcorder

Based on the AVCHD format, your camcorder records and plays with the high definition image quality (HD).

In addition to high definition image quality (HD), your camcorder is capable of recording a standard definition (STD) signal in the conventional MPEG-2 format.

Video signal*: MPEG-4 AVC/H.264 1920 × 1080/60i, 1440 × 1080/60i

Audio signal: Dolby Digital 2ch

Recording media:

HDR-CX190/CX200/PJ200: memory card

HDR-CX210: Internal memory, memory card

* Data recorded in AVCHD format other than the above mentioned cannot be played on your camcorder.

[▲ Back to top](#)

Copyright 2012 Sony Corporation

- ▶ Operation Search
- ▶ Before use
- ▶ Getting started
- ▶ Recording
- ▶ Playback
- ▶ Saving images with an external device
- ▶ Customizing your camcorder
- ▶ Troubleshooting
- ▶ Maintenance and precautions

[⇒ Contents list](#)

About the memory card

- A memory card formatted by a computer (Windows OS/Mac OS) does not have guaranteed compatibility with your camcorder.
- Data read/write speed may vary depending on the combination of the memory card and memory card compliant product you use.
- Damaged or lost data may occur in the following cases (the data will not be compensated for):
 - If you eject the memory card, or turn off your camcorder while your camcorder is reading or writing image files on the memory card (while the access lamp is lit or flashing)
 - If you use the memory card near magnets or magnetic fields
 - It is recommended that you make a back-up of important data on the hard disk of a computer.
- Do not attach a label or the like on memory card or memory card adaptor.
- Do not touch, or allow metallic objects to come into contact with the terminals.
- Do not bend, drop or apply strong force to the memory card.
- Do not disassemble or modify the memory card.
- Do not let the memory card get wet.
- Keep the memory card out of the reach of small children. There is danger that a child might swallow it.
- Do not insert anything other than the compliant size of memory card into the memory card slot. Doing so may cause a malfunction.
- Do not use or keep the memory card in the following locations:
 - Places subject to extremely high temperature, such as a car parked outside in the summer
 - Places under direct sunlight
 - Places with extremely high humidity or subject to corrosive gases

On the memory card adaptor

- When using memory card with memory card compliant device inserting memory card into memory card adaptor, make sure the memory card is inserted facing in the correct direction. Note that improper use may cause a malfunction.

On image data compatibility

- Image data files recorded on memory card by your camcorder conform to the "Design rule for Camera File system" universal standard established by the JEITA (Japan Electronics and Information Technology Industries Association).
- On your camcorder, you cannot play back photos recorded on other devices (DCR-TRV900 or DSC-D700/D770) that do not conform to the universal standard. (These models are not sold in some regions.)
- If you cannot use memory cards that have been used with another device, format it with your camcorder. Note that formatting erases all information on the memory card. [\[Details\]](#)
- You may not be able to play back images with your camcorder:
 - When playing back image data modified on your computer
 - When playing back image data recorded with other devices

About the "Memory Stick" media

Types of "Memory Stick" media	Recording/Playback
"Memory Stick Duo" media (with MagicGate)	—
"Memory Stick PRO Duo" media (Mark2)	✓
"Memory Stick PRO-HG Duo" media	✓

- This product does not support 8-bit parallel data transfer but it supports 4-bit parallel data transfer the same as with “Memory Stick PRO Duo” media.
- This product cannot record or play data that uses “MagicGate” technology. “MagicGate” is a copyright protection technology that records and transfers the contents in an encrypted format.

[▲ Back to top](#)

Copyright 2012 Sony Corporation

- ▶ Operation Search
- ▶ Before use
- ▶ Getting started
- ▶ Recording
- ▶ Playback
- ▶ Saving images with an external device
- ▶ Customizing your camcorder
- ▶ Troubleshooting
- ▶ Maintenance and precautions

[⇒ Contents list](#)

About the "InfoLITHIUM" battery pack

Your camcorder operates only with an "InfoLITHIUM" V series battery packs.

"InfoLITHIUM" V series battery packs have the  mark.

What is an "InfoLITHIUM" battery pack?

- An "InfoLITHIUM" battery pack is a lithium-ion battery pack that has functions for communicating information related to operating conditions between your camcorder and an AC Adaptor/charger (sold separately).
- The "InfoLITHIUM" battery pack calculates the power consumption according to the operating conditions of your camcorder, and displays the remaining battery time in minutes.

To charge the battery pack

- Be sure to charge the battery pack before you start using your camcorder.
- We recommend that you charge the battery pack in an ambient temperature range of 10 °C to 30 °C (50 °F to 86 °F) until the CHG (charge) lamp turns off. If you charge the battery pack outside of this temperature range, you may not be able to charge it efficiently.

To use the battery pack effectively

- Battery pack performance decreases when the ambient temperature is 10 °C (50 °F) or below, and the length of time you can use the battery pack becomes shorter. In that case, do one of the following to use the battery pack for a longer time.
 - Put the battery pack in a pocket to warm it up, and install it on your camcorder right before you start taking shots.
 - Use a large capacity battery pack: NP-FV70/NP-FV100 (sold separately).
- Frequent use of the LCD screen or a frequent playback, fast forward or reverse operation wears out the battery pack faster. We recommend using a large capacity battery pack: NP-FV70/NP-FV100 (sold separately).
- Be sure to close the LCD screen when not recording or playing back on your camcorder. The battery pack is also consumed when your camcorder is in recording standby or playback pause.
- Have spare battery packs ready for 2 or 3 times the expected recording time, and make trial recordings before making the actual recording.
- Do not expose the battery pack to water. The battery pack is not water resistant.

About the remaining battery time indicator

- When the power goes off even though the remaining battery time indicator indicates that the battery pack has enough power to operate, charge the battery pack fully again. Remaining battery time will be indicated correctly. Note, however, that the battery indication will not be restored if it is used in high temperatures for a long time, or if left in a fully charged state, or when the battery pack is frequently used. Use the remaining battery time indication as a rough guide only.
- The  mark that indicates low battery flashes even if there are still 20 minutes of battery time remaining, depending on the operating conditions or ambient temperature.

About storage of the battery pack

- If the battery pack is not used for a long time, fully charge the battery pack and use it up on your camcorder once a year to maintain proper function. To store the battery pack, remove it from your camcorder and put it in a dry, cool place.
- To discharge the battery pack on your camcorder completely, select MENU → [Setup] → [ General Settings] → [Eco Mode] → [Off], and leave your camcorder in recording standby until the

power goes off. [\[Details\]](#)

About battery life

- Battery capacity decreases over time and through repeated use. If decreased usage time between charges becomes significant, it is probably time to replace it with a new one.
- Each battery's life is governed by storage, operating and environmental conditions.

[▲ Back to top](#)

Copyright 2012 Sony Corporation

- ▶ [Operation Search](#)
- ▶ [Before use](#)
- ▶ [Getting started](#)
- ▶ [Recording](#)
- ▶ [Playback](#)
- ▶ [Saving images with an external device](#)
- ▶ [Customizing your camcorder](#)
- ▶ [Troubleshooting](#)
- ▶ [Maintenance and precautions](#)

[⇒ Contents list](#)

About x.v.Color

- x.v.Color is a more familiar term for the xvYCC standard proposed by Sony, and is a trademark of Sony.
- xvYCC is an international standard for color space in video. This standard can express a wider color range than the currently used broadcast standard.

[▲ Back to top](#)

[Top page](#) > [Maintenance and precautions](#) > [Maintenance and precautions](#) > [About the AC Adaptor](#)

▶ Operation Search

▶ Before use

▶ Getting started

▶ Recording

▶ Playback

▶ Saving images with an external device

▶ Customizing your camcorder

▶ Troubleshooting

▶ Maintenance and precautions

[⇒ Contents list](#)

About the AC Adaptor

- Use the nearby wall outlet (wall socket) when using the AC Adaptor. Disconnect the AC Adaptor from the wall outlet (wall socket) immediately if any malfunction occurs while using your camcorder.
- Do not use the AC Adaptor placed in a narrow space, such as between a wall and furniture.
- Do not short-circuit the DC plug of the AC Adaptor or battery terminal with any metallic objects. This may cause a malfunction.

[▲ Back to top](#)

Copyright 2012 Sony Corporation

- ▶ [Operation Search](#)
- ▶ [Before use](#)
- ▶ [Getting started](#)
- ▶ [Recording](#)
- ▶ [Playback](#)
- ▶ [Saving images with an external device](#)
- ▶ [Customizing your camcorder](#)
- ▶ [Troubleshooting](#)
- ▶ [Maintenance and precautions](#)

[→ Contents list](#)

On use and care

- ▼ [About language setting](#)
- ▼ [On recording](#)
- ▼ [Notes on use](#)
- ▼ [LCD Panel](#)
- ▼ [About this manual, illustrations and on-screen displays](#)
- ▼ [On use and care](#)
- ▼ [When not using your camcorder for a long time](#)
- ▼ [Note on the camcorder/battery pack temperature](#)
- ▼ [Notes on charging through the USB cable](#)
- ▼ [When the camcorder is connected to a computer or accessories](#)
- ▼ [Notes on optional accessories](#)
- ▼ [LCD screen](#)
- ▼ [To clean the LCD screen](#)
- ▼ [To clean the projector lens \(HDR-PJ200\)](#)
- ▼ [On handling the casing](#)
- ▼ [Carl Zeiss lens](#)
- ▼ [About care and storage of the lens](#)



About language setting

- The on-screen displays in each local language are used for illustrating the operating procedures. Change the screen language before using the camcorder if necessary.

On recording

- Before starting to record, test the recording function to make sure the image and sound are recorded without any problems.
- Compensation for the contents of recordings cannot be provided, even if recording or playback is not possible due to a malfunction of the camcorder, recording media, etc.
- TV color systems differ depending on the country/region. To view your recordings on a TV, you need a NTSC system-based TV.
- Television programs, films, video tapes, and other materials may be copyrighted. Unauthorized recording of such materials may be contrary to the copyright laws.

Notes on use

- Do not do any of the following. Otherwise, the recording media may be damaged, recorded images may be impossible to play back or may be lost, or other malfunctions could occur.
 - ejecting the memory card when the access lamp is lit or flashing
 - removing the battery pack or AC Adaptor from the camcorder, or applying mechanical shock or vibration to the camcorder when the  (Movie)/  (Photo) lamps or the access lamp are lit or flashing
- When the camcorder is connected to other devices through a USB connection and the power of the camcorder is turned on, do not close the LCD panel. The image data that has been recorded may be lost.
-

- Use the camcorder in accordance with local regulations.

LCD Panel

- The LCD screen is manufactured using extremely high-precision technology, so over 99.99% of the pixels are operational for effective use. However, there may be some tiny black points and/or bright points (white, red, blue, or green in color) that appear constantly on the LCD screen. These points are normal results of the manufacturing process and do not affect the recording in any way.

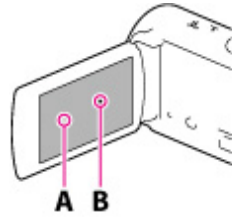

A: White, red, blue or green points



B: Black points

About this manual, illustrations and on-screen displays

- The example images used in this manual for illustration purposes are captured using a digital still camera, and therefore may appear different from images and screen indicators that actually appear on your camcorder. And, the illustrations of your camcorder and its screen indication are exaggerated or simplified for understandability.
- Design and specifications of your camcorder and accessories are subject to change without notice.
- In this manual, the internal memory (HDR-CX210) and the memory card are called “recording media.”
- In this manual, the DVD disc recorded with high definition image quality (HD) is called AVCHD recording disc.
- The model name is shown in this manual when there is a difference in specification between models. Confirm the model name on the bottom of your camcorder.

On use and care

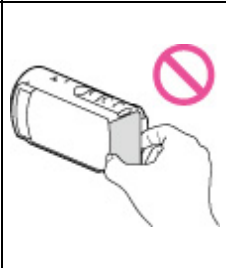
- The camcorder is not dustproofed, dripproofed or waterproofed.
- Do not hold the camcorder by the following parts, and also do not hold the camcorder by the jack covers.

LCD Screen	Battery pack	Built-in USB Cable
		

- Do not aim at the sun. Doing so might cause your camcorder to malfunction. Take images of the sun only in low light conditions, such as at dusk
- Use the camcorder in accordance with local regulations.
- Do not use or store the camcorder and accessories in the following locations:
 - Anywhere extremely hot, cold or humid. Never leave them exposed to temperatures above 60 °C (140 °F), such as under direct sunlight, near heaters or in a car parked in the sun. They may malfunction or become deformed.
 - Near strong magnetic fields or mechanical vibration. The camcorder may malfunction.
 - Near strong radio waves or radiation. The camcorder may not be able to record properly.

- Near tuner devices such as TVs or radio. Noise may occur.
- On a sandy beach or anywhere dusty. If sand or dust gets in your camcorder, it may malfunction. Sometimes this malfunction cannot be repaired.
- Near windows or outdoors, where the LCD screen, or the lens may be exposed to direct sunlight. This damages the LCD screen.
- Operate your camcorder on DC 6.8 V/7.2 V (battery pack) or DC 8.4 V (AC Adaptor).
- For DC or AC operation, use the accessories recommended in these operating instructions.
- Do not let your camcorder get wet, for example, from rain or sea water. If your camcorder gets wet, it may malfunction. Sometimes this malfunction cannot be repaired.
- If any solid object or liquid gets inside the casing, unplug your camcorder and have it checked by a Sony dealer before operating it any further.
- Avoid rough handling, disassembling, modifying, physical shock, or impact such as hammering, dropping or stepping on the product. Be particularly careful of the lens.
- Keep the LCD screen closed when you are not using your camcorder.
- Do not wrap your camcorder with a towel, for example, and operate it. Doing so might cause heat to build up inside.
- When disconnecting the power cord (mains lead), pull it by the plug and not the cord.
- Do not damage the power cord (mains lead) such as by placing anything heavy on it.
- Do not use a deformed or damaged battery pack.
- Keep metal contacts clean.
- If the battery electrolytic liquid has leaked:
 - Consult your local authorized Sony service facility.
 - Wash off any liquid that may have contacted your skin.
 - If any liquid gets in your eyes, wash with plenty of water and consult a doctor.

When not using your camcorder for a long time

- To keep your camcorder in optimum state for a long time, turn it on and let it run by recording and playing back images about once a month.
- Use up the battery pack completely before storing it.

Note on the camcorder/battery pack temperature

- When the temperature of the camcorder or battery pack becomes extremely high or extremely low, you may not be able to record or play back on the camcorder, due to the protection features of the camcorder being activated in such situations. In this case, an indicator appears on the LCD screen.

Notes on charging through the USB cable

- Operation with all computers is not assured.
- If you connect the camcorder to a laptop computer that is not connected to a power source, the battery of the laptop computer will continue to use up its charge. Do not leave the camcorder connected to a computer in this manner.
- Charging with a personally assembled computer, with a converted computer, or through a USB hub are not guaranteed. The camcorder may not function correctly depending on the USB device which is used with the computer.

When the camcorder is connected to a computer or accessories

- Do not try to format the recording media of the camcorder using a computer. If you do so, your camcorder may not operate correctly.
- When connecting the camcorder to another device with communication cables, be sure to insert the connector plug in the correct way. Pushing the plug forcibly into the terminal will damage the terminal and may result in a malfunction of the camcorder.
- When the camcorder is connected to other devices through a USB connection and the power of the camcorder is turned on, do not close the LCD panel. The image data that has been recorded may be lost.

Notes on optional accessories

- We recommend using genuine Sony accessories.
- Genuine Sony accessories may not be available in some countries/regions.

LCD screen

- Do not apply excessive pressure on the LCD screen, as it may cause uneven color and other damage.
- If your camcorder is used in a cold place, a residual image may appear on the LCD screen. This is not a malfunction.
- While using your camcorder, the back of the LCD screen may heat up. This is not a malfunction.

To clean the LCD screen

- If fingerprints or dust make the LCD screen dirty, it is recommended that you use a soft cloth to clean it.

To clean the projector lens (HDR-PJ200)

- Wipe the lens gently with a soft cloth such as a cleaning cloth or glass cleaning cloth.
- Stubborn stains may be removed with a soft cloth such as a cleaning cloth or glass cleaning cloth lightly dampened with water.
- Never use a solvent such as alcohol, benzene or thinner; acid, alkaline or abrasive detergent; or a chemical cleaning cloth, as they will damage the lens surface.

On handling the casing

- If the casing is soiled, clean the camcorder body with a soft cloth lightly moistened with water, and then wipe the casing with a dry soft cloth.
- Avoid the following to avoid damage to the finish:
 - Using chemicals such as thinner, benzene, alcohol, chemical cloths, repellent, insecticide and sunscreen
 - Handling the camcorder with above substances on your hands
 - Leaving the casing in contact with rubber or vinyl objects for a long period of time

Carl Zeiss lens

- Your camcorder is equipped with a Carl Zeiss lens, which was developed jointly by Carl Zeiss, in Germany, and Sony Corporation, and produces superior images. It adopts the MTF* measurement system for video cameras and offers a quality typical of a Carl Zeiss lens.

* Modulation Transfer Function. The number value indicates the amount of light from a subject coming into the lens.

About care and storage of the lens

- Wipe the surface of the lens clean with a soft cloth in the following instances:
 - When there are fingerprints on the lens surface
 - In hot or humid locations
 - When the lens is exposed to salty air such as at the seaside
- Store in a well-ventilated location subject to little dirt or dust.
- To prevent mold, periodically clean the lens as described above.

[▲ Back to top](#)

[Top page](#) > [Maintenance and precautions](#) > [About handling of your camcorder](#) > [On moisture condensation](#)

▶ Operation Search

▶ Before use

▶ Getting started

▶ Recording

▶ Playback

▶ Saving images with an external device

▶ Customizing your camcorder

▶ Troubleshooting

▶ Maintenance and precautions

[⇒ Contents list](#)

On moisture condensation

If your camcorder is brought directly from a cold place to a warm place, moisture may condense inside your camcorder. This may cause a malfunction to your camcorder.

- If moisture condensation has occurred

Leave your camcorder for about 1 hour without turning it on.

- Note on moisture condensation

Moisture may condense when you bring your camcorder from a cold place into a warm place (or vice versa) or when you use your camcorder in a humid place as follows:

- You bring your camcorder from a ski slope into a place warmed up by a heating device.
- You bring your camcorder from an air conditioned car or room into a hot place outside.
- You use your camcorder after a squall or a rain.
- You use your camcorder in a hot and humid place.

- How to prevent moisture condensation

When you bring your camcorder from a cold place into a warm place, put your camcorder in a plastic bag and seal it tightly. Remove the bag when the air temperature inside the plastic bag has reached the surrounding temperature (after about 1 hour).

[▲ Back to top](#)

▶ Operation Search

▶ Before use

▶ Getting started

▶ Recording

▶ Playback

▶ Saving images with an external device

▶ Customizing your camcorder

▶ Troubleshooting

▶ Maintenance and precautions

⇒ [Contents list](#)

[Top page](#) > [Maintenance and precautions](#) > [About handling of your camcorder](#) > [On adjustment of the touch panel \(HDR-CX200/CX210/PJ200\)](#)

On adjustment of the touch panel (HDR-CX200/CX210/PJ200)

The buttons on the touch panel may not work correctly. If this happens, follow the procedure below. It is recommended that you connect your camcorder to the wall outlet (wall socket) using the supplied AC Adaptor during the operation.

1. **MENU** → [Setup] → [General Settings] → [Calibration].

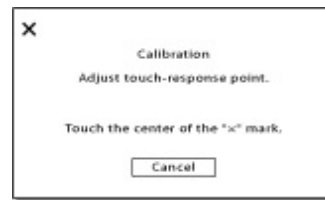

2. Touch "x" displayed on the screen with the corner of memory card or the like 3 times.
Touch [Cancel] to cancel calibration.

Notes

- If you did not press the right spot, try the calibration again.
- Do not use a sharp-pointed object for calibration. Doing so may damage the LCD screen.
- You cannot calibrate the LCD screen if it is rotated, or closed with the screen facing out.

[▲ Back to top](#)

- ▶ Operation Search
- ▶ Before use
- ▶ Getting started
- ▶ Recording
- ▶ Playback
- ▶ Saving images with an external device
- ▶ Customizing your camcorder
- ▶ Troubleshooting
- ▶ Maintenance and precautions

[⇒ Contents list](#)

[Top page](#) > [Maintenance and precautions](#) > [About handling of your camcorder](#) > [On charging the pre-installed rechargeable battery](#)

On charging the pre-installed rechargeable battery

- ▼ [On charging the pre-installed rechargeable battery](#)
- ▼ [How to charge the pre-installed rechargeable battery](#)

On charging the pre-installed rechargeable battery

Your camcorder has a pre-installed rechargeable battery to retain the date, time, and other settings even when the LCD screen is closed. The pre-installed rechargeable battery is always charged while your camcorder is connected to the wall outlet (wall socket) via the AC Adaptor or while the battery pack is attached. The rechargeable battery will be fully discharged in about 3 months if you do not use your camcorder at all. Use your camcorder after charging the pre-installed rechargeable battery.

However, even if the pre-installed rechargeable battery is not charged, the camcorder operation will not be affected as long as you are not recording the date.

How to charge the pre-installed rechargeable battery

Connect your camcorder to a wall outlet (wall socket) using the supplied AC Adaptor, and leave it with the LCD screen closed for more than 24 hours.

[▲ Back to top](#)

Copyright 2012 Sony Corporation

[▶ Operation Search](#)[▶ Before use](#)[▶ Getting started](#)[▶ Recording](#)[▶ Playback](#)[▶ Saving images with an external device](#)[▶ Customizing your camcorder](#)[▶ Troubleshooting](#)[▶ Maintenance and precautions](#)[⇒ Contents list](#)

Notes on disposal/transfer of the camcorder

[▼ Note on disposal/transfer of the camcorder \(HDR-CX210\)](#)[▼ Note on disposal/transfer of the memory card](#)

■ Note on disposal/transfer of the camcorder (HDR-CX210)

Even if you delete all movies and still images, or perform [Format], data on the internal recording media may not be completely erased. When you transfer the camcorder, it is recommended that you perform [Empty] to prevent the recovery of your data. Also, when you dispose of the camcorder, it is recommended that you destroy the actual body of the camcorder. [\[Details\]](#)

■ Note on disposal/transfer of the memory card

Even if you delete data in the memory card or format the memory card on your camcorder or a computer, you may not delete data from the memory card completely. When you give the memory card to somebody, it is recommended that you delete data completely using data deletion software on a computer. Also, when you dispose of the memory card, it is recommended that you destroy the actual body of the memory card.

[▲ Back to top](#)

[Top page](#) > [Maintenance and precautions](#) > [Recording time of movies/number of recordable photos](#) > [Charging time](#)

- ▶ Operation Search
- ▶ Before use
- ▶ Getting started
- ▶ Recording
- ▶ Playback
- ▶ Saving images with an external device
- ▶ Customizing your camcorder
- ▶ Troubleshooting
- ▶ Maintenance and precautions

[⇒ Contents list](#)

Charging time

Approximate time (min.) required when you fully charge a fully discharged battery pack.

Battery pack	Charging time	
	AC Adaptor	Built-in USB Cable* (when using your computer)
NP-FV30 (supplied)	115	150
NP-FV50	155	280
NP-FV70	195	545
NP-FV100	390	1000

- The charging times shown in the table above are measured when charging the camcorder at a temperature of 25 °C (77 °F). It is recommended that you charge the battery in a temperature range of 10 °C to 30 °C (50 °F to 86 °F).

* The charging times are measured without using the USB Connection support cable.

[▲ Back to top](#)

[Top page](#) > [Maintenance and precautions](#) > [Recording time of movies/number of recordable photos](#) > [Expected time of recording and playback with each battery pack](#)

- ▶ Operation Search
- ▶ Before use
- ▶ Getting started
- ▶ Recording
- ▶ Playback
- ▶ Saving images with an external device
- ▶ Customizing your camcorder
- ▶ Troubleshooting
- ▶ Maintenance and precautions

[⇒ Contents list](#)

Expected time of recording and playback with each battery pack

▼ Recording time



▼ Playing time

"HD" stands for high definition image quality, and "STD" stands for standard definition image quality.

Recording time

Approximate time available when you use a fully charged battery pack.
(unit: minute)

Battery pack	Continuous recording time		Typical recording time	
Image quality	HD	STD	HD	STD
NP-FV30 (supplied)	95	105	45	50
NP-FV50	180	200	90	100
NP-FV70	375	415	185	205
NP-FV100	745	830	370	415

- Each recording time is measured when the camcorder is recording high definition image quality (HD) movies with [ REC Mode] set to [Standard ].
- Typical recording time shows the time when you repeat recording start/stop, switching the MODE lamp, and zooming.
- Times measured when using the camcorder at 25 °C (77 °F). 10 °C to 30 °C (50 °F to 86 °F) is recommended.
- The recording and playback time will be shorter when you use your camcorder in low temperatures.
- The recording and playback time will be shorter depending on the conditions under which you use your camcorder.

Playing time

Approximate time available when you use a fully charged battery pack.
(unit: minute)

Battery pack		
Image quality	HD	STD
NP-FV30 (supplied)	135	145
NP-FV50	255	280
NP-FV70	525	565
NP-FV100	1045	1120

[▲ Back to top](#)

- ▶ Operation Search
- ▶ Before use
- ▶ Getting started
- ▶ Recording
- ▶ Playback
- ▶ Saving images with an external device
- ▶ Customizing your camcorder
- ▶ Troubleshooting
- ▶ Maintenance and precautions

[⇒ Contents list](#)

Expected recording time of movies

- ▼ [Expected recording time of movies](#)
- ▼ [Expected number of recordable photos](#)
- ▼ [Bit-rate and recording pixels](#)

Expected recording time of movies

Internal recording media (HDR-CX210)

High definition image quality (HD) in h (hour) and min (minute)

Recording mode	Recording time
[Highest Quality FX]	45 min (45 min)
[High Quality FH]	1 h (1 h)
[Standard HQ]	1 h 50 min (1 h 20 min)
[Long Time LP]	3 h 15 min (2 h 35 min)

Standard definition image quality (STD) in h (hour) and min (minute)

Recording mode	Recording time
[Standard HQ]	1 h 55 min (1 h 45 min)

- You can record movies of a maximum of 3,999 scenes with high definition image quality (HD), and 9,999 scenes with standard definition image quality (STD).
- The maximum continuous recording time of movies is approximately 13 hours.
- If you want to record up to the maximum recording time indicated in the table, you need to delete the demonstration movie on your camcorder.
- Your camcorder uses the VBR (Variable Bit Rate) format to automatically adjust image quality to suit the recording scene. This technology causes fluctuations in the recording time of the media. Movies containing quickly moving and complex images are recorded at a higher bit-rate, and this reduces the overall recording time.

Notes

- The number in () is the minimum recordable time.

Memory card

High definition image quality (HD)

(unit: minute)

	2 GB	4 GB	8 GB	16 GB	32 GB
[Highest Quality FX]	10 (10)	20 (20)	40 (40)	90 (90)	180 (180)
[High Quality FH]	10 (10)	25 (25)	60 (60)	120 (120)	245 (245)
[Standard HQ]	25 (15)	50 (40)	105 (80)	215 (165)	440 (330)
[Long Time LP]	45 (35)	90 (75)	185 (155)	380 (310)	770 (630)

Standard definition image quality (STD)
(unit: minute)

	2 GB	4 GB	8 GB	16 GB	32 GB
[Standard HQ]	25 (25)	55 (50)	110 (100)	225 (210)	460 (420)

- When using a Sony memory card.

Notes

- The number in () is the minimum recordable time.

Expected number of recordable photos

Internal recording media (HDR-CX210)

You can record the maximum 34,000 photos.

Memory card

	16:9 5.3M
2 GB	690
4 GB	1350
8 GB	2800
16 GB	5600
32 GB	11000

- When using a Sony memory card.
- The number of recordable photos of memory card shown is for the maximum image size of your camcorder. The actual number of recordable photos is displayed on the LCD screen during recording. [\[Details\]](#)
- The number of recordable photos of memory card may vary depending on the recording conditions.

Notes

- The unique image processing system of Sony's BIONZ allows still image resolution equivalent to the sizes described.

Bit-rate and recording pixels

The following list shows the bit-rate, pixels and aspect ratio of each recording mode for movies (movie +

audio, etc.).

- High definition image quality (HD):
 - FX: Max. 24 Mbps 1,920 × 1,080 pixels/16:9
 - FH: Approx. 17 Mbps (average) 1,920 × 1,080 pixels/16:9
 - HQ: Approx. 9 Mbps (average) 1,440 × 1,080 pixels/16:9
 - LP: Approx. 5 Mbps (average) 1,440 × 1,080 pixels/16:9
- Standard definition image quality (STD):
 - HQ: Approx. 9 Mbps (average) 720 × 480 pixels/16:9, 4:3

The photo recording pixels and the aspect ratio.

- Photo recording mode, Dual capture:
 - 3,072 × 1,728 dots/16:9
 - 2,304 × 1,728 dots/4:3
 - 1,536 × 864 dots/16:9
 - 640 × 480 dots/4:3
- Capturing a photo from a movie:
 - 1,920 × 1,080 dots/16:9
 - 640 × 360 dots/16:9
 - 640 × 480 dots/4:3

[▲ Back to top](#)

Copyright 2012 Sony Corporation

- ▶ Operation Search
- ▶ Before use
- ▶ Getting started
- ▶ Recording
- ▶ Playback
- ▶ Saving images with an external device
- ▶ Customizing your camcorder
- ▶ Troubleshooting
- ▶ Maintenance and precautions

[⇒ Contents list](#)

Using your camcorder abroad

Power supply

You can use your camcorder in any countries/regions using the AC Adaptor supplied with your camcorder within the AC 100 V to 240 V, 50 Hz/60 Hz range.

Viewing high definition image quality (HD) movies

In countries/regions where 1080/60i is supported, you can view the movies with the same high definition image quality (HD) as that of the recorded movies. You need a NTSC-system-based and 1080/60i compatible TV (or monitor). An HDMI cable must be connected.

Viewing standard definition image quality (STD) movies

To view standard definition image quality (STD) movies, you need a NTSC-system-based TV with AUDIO/VIDEO input jacks. An A/V connecting cable must be connected.

On TV color systems

Your camcorder is a NTSC-system-based camcorder. If you want to view the playback image on a TV, it must be a NTSC-system-based TV with an AUDIO/VIDEO input jack.

System	Used in
NTSC	Bahama Islands, Bolivia, Canada, Central America, Chile, Colombia, Ecuador, Guyana, Jamaica, Japan, Korea, Mexico, Peru, Surinam, Taiwan, the Philippines, the USA, Venezuela, etc.
PAL	Australia, Austria, Belgium, China, Czech Republic, Denmark, Finland, Germany, Holland, Hong Kong, Hungary, Italy, Kuwait, Malaysia, New Zealand, Norway, Poland, Portugal, Singapore, Slovak Republic, Spain, Sweden, Switzerland, Thailand, United Kingdom, etc.
PAL-M	Brazil
PAL-N	Argentina, Paraguay, Uruguay
SECAM	Bulgaria, France, Guiana, Iran, Iraq, Monaco, Russia, Ukraine, etc.

Setting to the local time

You can easily set the clock to the local time by setting a time difference when using your camcorder abroad. Select **MENU** → [Setup] → [Clock Settings] → [Date & Time Setting] → [Daylight Savings] or [Summer Time], and **MENU** → [Setup] → [Clock Settings] → [Area Setting]. [\[Details\]](#)

World time difference

Time-zone differences	Area setting
GMT	Lisbon, London
+01:00	Berlin, Paris
+02:00	Helsinki, Cairo, Istanbul
+03:00	Nairobi

+03:30	Tehran
+04:00	Moscow, Abu Dhabi, Baku
+04:30	Kabul
+05:00	Karachi, Islamabad
+05:30	Calcutta, New Delhi
+06:00	Almaty, Dhaka
+06:30	Yangon
+07:00	Bangkok, Jakarta
+08:00	Hong Kong, Singapore, Beijing
+09:00	Tokyo, Seoul
+09:30	Adelaide, Darwin
+10:00	Melbourne, Sydney
+11:00	Solomon Is
+12:00	Fiji, Wellington, Eniwetok, Kwajalein
-11:00	Samoa
-10:00	Hawaii
-09:00	Alaska
-08:00	Los Angeles, Tijuana
-07:00	Denver, Arizona
-06:00	Chicago, Mexico City
-05:00	New York, Bogota
-04:00	Santiago
-03:30	St. John's
-03:00	Brasilia, Montevideo
-02:00	Fernando de Noronha
-01:00	Azores, Cape Verde Is.



[▲ Back to top](#)

Copyright 2012 Sony Corporation

- ▶ Operation Search
- ▶ Before use
- ▶ Getting started
- ▶ Recording
- ▶ Playback
- ▶ Saving images with an external device
- ▶ Customizing your camcorder
- ▶ Troubleshooting
- ▶ Maintenance and precautions

[⇒ Contents list](#)

On trademarks

- "Handycam" and **HANDYCAM** are registered trademarks of Sony Corporation.
 - "AVCHD" and "AVCHD" logotype are trademarks of Panasonic Corporation and Sony Corporation.
 - "Memory Stick," , "Memory Stick Duo," **MEMORY STICK DUO**," "Memory Stick PRO Duo," **MEMORY STICK PRO DUO**," "Memory Stick PRO-HG Duo," **MEMORY STICK PRO-HG DUO**," "MagicGate," **MAGICGATE**," "MagicGate Memory Stick" and "MagicGate Memory Stick Duo" are trademarks or registered trademarks of Sony Corporation.
 - "InfoLITHIUM" is a trademark of Sony Corporation.
 - "x.v.Color" is a trademark of Sony Corporation.
 - "BIONZ" is a trademark of Sony Corporation.
 - "BRAVIA" is a trademark of Sony Corporation.
 - "DVDirect" is a trademark of Sony Corporation.
 - "Blu-ray Disc" and the logo are trademarks.
 - Dolby and the double-D symbol are trademarks of Dolby Laboratories.
 - HDMI, the HDMI logo and High-Definition Multimedia Interface are trademarks or registered trademarks of HDMI Licensing LLC in the United States and other countries.
 - Microsoft, Windows, Windows Vista, and DirectX are either registered trademarks or trademarks of Microsoft Corporation in the United States and/or other countries.
 - Mac and Mac OS are registered trademarks of Apple Inc. in the U.S. and other countries.
 - Intel, Intel Core, and Pentium are trademarks or registered trademarks of Intel Corporation or its subsidiaries in the United States and other countries.
 -  and "PlayStation" are registered trademarks of Sony Computer Entertainment Inc.
 - Adobe, the Adobe logo, and Adobe Acrobat are either registered trademarks or trademarks of Adobe Systems Incorporated in the United States and/or other countries.
 - SDXC logo is a trademark of SD-3C, LLC.
 - MultiMediaCard is a trademark of MultiMediaCard Association.
- All other product names mentioned herein may be the trademarks or registered trademarks of their respective companies. Furthermore, TM and ® are not mentioned in each case in this manual.

Notes on the License

ANY USE OF THIS PRODUCT OTHER THAN CONSUMER PERSONAL USE IN ANY MANNER THAT COMPLIES WITH THE MPEG-2 STANDARD FOR ENCODING VIDEO INFORMATION FOR PACKAGED MEDIA IS EXPRESSLY PROHIBITED WITHOUT A LICENSE UNDER APPLICABLE PATENTS IN THE MPEG-2 PATENT PORTFOLIO, WHICH LICENSE IS AVAILABLE FROM MPEG LA, L.L.C., 250 STEELE STREET, SUITE 300, DENVER, COLORADO 80206.

THIS PRODUCT IS LICENSED UNDER THE AVC PATENT PORTFOLIO LICENSE FOR THE PERSONAL AND NON-COMMERCIAL USE OF A CONSUMER TO

(i) ENCODE VIDEO IN COMPLIANCE WITH THE AVC STANDARD ("AVC VIDEO") AND/OR

(ii) DECODE AVC VIDEO THAT WAS ENCODED BY A CONSUMER ENGAGED IN A PERSONAL AND

NON-COMMERCIAL ACTIVITY AND/OR WAS OBTAINED FROM A VIDEO PROVIDER LICENSED TO PROVIDE AVC VIDEO. NO LICENSE IS GRANTED OR SHALL BE IMPLIED FOR ANY OTHER USE. ADDITIONAL INFORMATION MAY BE OBTAINED FROM MPEG LA, L.L.C.

SEE <[HTTP://WWW.MPEGLA.COM](http://www.mpegla.com)>

We provide the software in your camcorder based on license agreements with the owners of the respective copyrights. Based on requests by the owners of copyright of these software applications, we have an obligation to inform you of the following. Please read the following sections.

Copies of the licenses (in English) are stored in the internal memory of your camcorder. Establish a Mass Storage connection between your camcorder and a computer, and read the files in the "LICENSE" folder in "PMHOME."

On GNU GPL/LGPL applied software

The software that is eligible for the following GNU General Public License (hereinafter referred to as "GPL") or GNU Lesser General Public License (hereinafter referred to as "LGPL") are included in the camcorder.

This informs you that you have a right to have access to, modify, and redistribute source code for these software programs under the conditions of the supplied GPL/LGPL.

Source code is provided on the web. Use the following URL to download it. When downloading the source code, select HDR-CX210E as the model for your camcorder.

<http://www.sony.net/Products/Linux/>

We would prefer you do not contact us about the contents of source code.

Copies of the licenses (in English) are stored in the internal memory of your camcorder. Establish a Mass Storage connection between your camcorder and a computer, and read the files in the "LICENSE" folder in "PMHOME."

[▲ Back to top](#)

Copyright 2012 Sony Corporation

Free Manuals Download Website

<http://myh66.com>

<http://usermanuals.us>

<http://www.somanuals.com>

<http://www.4manuals.cc>

<http://www.manual-lib.com>

<http://www.404manual.com>

<http://www.luxmanual.com>

<http://aubethermostatmanual.com>

Golf course search by state

<http://golfingnear.com>

Email search by domain

<http://emailbydomain.com>

Auto manuals search

<http://auto.somanuals.com>

TV manuals search

<http://tv.somanuals.com>