

Form 18932
(1035)
Printed in U.S.A.

LIST OF PARTS



SINGER**

MACHINE No. 96-41

THE SINGER MANUFACTURING COMPANY

INSTRUCTIONS FOR OILING

To ensure easy running and prevent unnecessary wear of the parts which are in movable contact, the machine requires oiling and when in continuous use, "TYPE B" or "TYPE D" OIL, sold by Singer Sewing Machine Company, should be applied at least twice each day to all oil holes marked "OIL", as instructed in Form 8939.

"TYPE D" OIL should be used when an oil is desired which will produce a minimum of stain on fabrics, even after a long period of storage.

CAUTION: These machines are equipped with a lubricating system, designed to use oil instead of grease in the hook driving gears.

INDEX

	Page
Accessories.....	15
Bobbin Winders.....	15
Finger Guards.....	18
Foot Lifter Parts.....	18
Knee Lifter Parts.....	20
Machine Base.....	15
Machine No. 96-41.....	5
Numerical List of Parts.....	23
Obsolete Parts.....	21
Thread Unwinder.....	21

Copyright, U. S. A., 1921, 1933, 1934 and 1935
by The Singer Manufacturing Company
All Rights Reserved for all Countries

INSTRUCTIONS FOR ORDERING

In ordering from this list, use ONLY the part NUMBER in the FIRST column.

The number stamped on a Sewing Machine Part is in every case the number of the single part only.

Every combination of parts sent out as such has its specific number, which, although not stamped on the parts, must be used when ordering the combination.

Each number always indicates the SAME PART in whatever list it appears, or for whatever machine.

The letters after some of the numbers indicate the style of finish only, as follows:

- A-Hardened, Polished, Nickel Plated and Buffed
- B-Polished, Nickel Plated and Buffed
- C-Hardened Only
- D-Polished Only
- E-Soft, Not Polished
- F-Hardened and Polished
- H-Blued
- J-Nickel Plated Only
- K-Hardened and Nickel Plated
- L-Brass Plated
- M-Oxidized
- N-Japanned, Dull
- P-Japanned, Bright
- R-Merlized
- T-Copper Plated
- T.A-Hardened, Polished, Copper and Nickel Plated and Buffed
- T.B-Copper and Nickel Plated and Polished
- T.J-Copper and Nickel Plated Only
- T.K-Hardened, Copper and Nickel Plated
- T.M-Copper Plated and Oxidized
- T.L-Copper and Brass Plated
- U-Zinc Plated
- V-Silver Plated
- W-Polished and Nickel Plated
- Y-Black Nickel Plated Only
- Z-Chromium Plated
- Z.B-Polished, Nickel Plated, Buffed and Chromium Plated
- Z.J-Nickel and Chromium Plated

These letters MUST BE USED when they appear in the list; and AFTER the number as in the list.

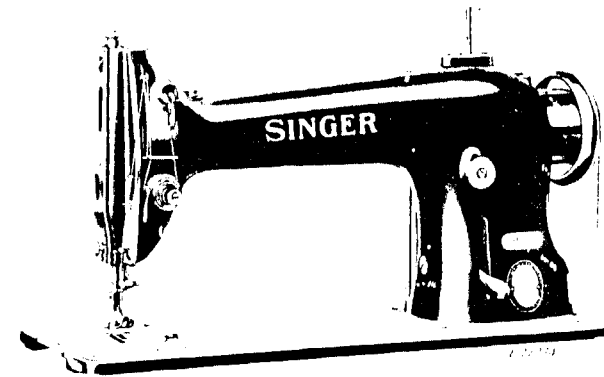
In this series:

- I to 1500, 50001 to 51500 and 140001 to 142000 are Screw Numbers
- 1501 to 1800 and 51501 to 51800 are Nut Numbers
- 1801 to 2000 and 51801 to 52000 are Roller Numbers
- 2001 to 50000 and 52001 to 140001 and 142000 to 190000 are Sewing Machine Parts, 190001 and upward are numbers of Electrical Parts

The figures in the second column refer only to the plates, illustrating the parts, and are NOT TO BE USED in ordering.

Parts marked with an asterisk (*) are furnished only when repairs are made at factory.

LIST OF PARTS COMPLETE FOR



MACHINE NO. 96-41

FOR CLOAKS, CLOTHING. OVERALLS AND OTHER WORK IN CLOTH. HAS REVERSIBLE FEED MECHANISM. THE MACHINE IS FITTED WITH HEAVY GEAR SHAFTS. THE GEARS ARE LUBRICATED WITH OIL INSTEAD OF GREASE. SPEED UP TO 3500, ACCORDING TO THE MATERIAL BEING STITCHED.

No.	Plate	Name
*127214	-----	Arm with 15404 and two each 15405 and 56015.....
Note: Due to the accuracy required for gear alignment, Arm cannot be supplied separately and can only be sent out as a unit, Arm and Bed assembled.		
16532	21801	Arm Dowel Pin.....
52183	21801	" O11 Tube with 52184, for oiling 52024.
52180	21801	" " " (long) with 52184, for oiling 52022.....
52185	21801	Arm O11 Tube (short) with 42367, for oiling 52022.....
52182	21801	Arm O11 Tube with 52184, for oiling 24040.
52186	21801	" " " " 52184, for oiling 127158 for 127193.....
127187	21801	Arm O11 Tube (bent) with 42367, for oiling 127152, for 127193.....

No.	Plate	Name
375C	21827	Feed Connecting Link Hinge Screw.....
1518J	21827	" " " " " Nut.....
52073	21827	" " " " " Stud.....
50083C	21827	" " " " " Set Screw.
28603	-----	Feed Dog, 20 teeth (16 teeth to the inch) for 20356 and 20357.....
28380	-----	Feed Dog, 15 conical teeth (12 teeth to the inch) for 20356 and 20357.....
121446	7738	Feed Dog, 13 spiked teeth (10 teeth to the inch) for 20356 and 20357.....
Note: Feed Dog 121446 is sent with this machine un- less another Feed Dog is specified on order.		
50117E	21827	Feed Dog Screw.....
127202	7739	" and Feed Lifting Eccentric with 448C, 1299C, 52210 and 52211.....
52210	21827	Feed and Feed Lifting Eccentric Lubricat- ing Pad (long) wood.....
52211	21827	Feed and Feed Lifting Eccentric Lubricat- ing Pad (short) wood.....
448C	7725	Feed and Feed Lifting Eccentric Set Screw.
1299C	21809	" " " " " Position Screw.....
127152	7739	Feed and Feed Lifting Eccentric Sleeve....
52407	22201	" Forked Connection.....
52451	-----	" " " " 52407 with 375C, 1518E and 52165.....
375C	21827	Feed Forked Connection Hinge Screw.....
1518E	21827	" " " " " Nut....
52384	7733	" Lifting Rock Shaft.....
52385	-----	Feed Lifting Rock Shaft complete, Nos. 12376 and 52384.....
127156	22201	Feed Lifting Rock Shaft Connecting Rod with two 966E.....
966E	21827	Feed Lifting Rock Shaft Connecting Rod Cap Screw.....
375C	21827	Feed Lifting Rock Shaft Connecting Rod Hinge Screw.....
1518J	21827	Feed Lifting Rock Shaft Connecting Rod Hinge Screw Nut.....
12376	7739	Feed Lifting Rock Shaft Crank with 157J and 1813.....
157J	21827	Feed Lifting Rock Shaft Crank Clamping Screw.....
1813	21827	Feed Lifting Rock Shaft Crank Roller and Stud.....
50191C	21827	Feed Lifting Rock Shaft Screw Center.....
52097	-----	" " " " " 50191C with 1513J.....
1513J	21827	Feed Lifting Rock Shaft Screw Center Nut..

No.	Plate	Name
50338E	7735	Feed Regulating Stud.....
58032	7735	" " " " Head with 58033.....
50193J	7735	" " " " Cap Screw.....
58033	7735	" " " " Stop Pin.....
58034	7735	" " " " Lock Pin.....
58035	7735	" " " " " Spring.....
52408	7739	" Regulator with 50083C.....
*52411	-----	" " 52408 with 52073.....
1128E	7725	" " Hinge Screw.....
52409	7739	" Reverse Lever with 158E and 51848....
50339D	7735	" " " Hinge Screw.....
158E	21827	" " " " " Clamping Screw.....
52410	7737	Feed Reverse Lever Hinge Screw Friction Washer.....
51848	7737	Feed Reverse Lever Roller and Stud.....
52386	7733	" Rock Shaft.....
29633	7739	" " " Crank with 157J.....
157J	21827	" " " Clamping Screw.....
52387	-----	Feed Rock Shaft complete, Nos. 29633 and 52386.....
50191C	21827	Feed Rock Shaft Screw Center.....
52097	-----	" " " " " 50191C with 1513J.....
1513J	21827	Feed Rock Shaft Screw Center Nut.....
25866	22201	Guide.....
50190J	21827	" Thumb Screw.....
127088	22201	Needle Bar (hollow).....
127116	-----	" " 127088 with 229J, 52306 and 52307.....
127188	7725	Needle Bar Bushing (lower).....
1133E	21809	" " " " Set Screw.....
52014	22201	" " " (upper).....
1133E	21809	" " " Set Screw.....
52205	21804	" " Connecting Link with 52207....
52206	-----	" " " " 52205 with 24041.....
775E	21809	Needle Bar Connecting Link Cap Screw.....
52207	7725	" " " " Lubricating Pad (wood).....
24041	21804	Needle Bar Connecting Stud with 207E.....
207E	2834	" " " Clamping Screw.
127201	22201	" " Crank with 1036C, 1037C and 1065C.....
1065C	7725	Needle Bar Crank Position Screw.....
52306	7725	" " Thread Guard.....
229J	7725	" " " Screw.....
52307	7725	" Clamp with 51460F.....
51460F	7725	" " Screw.....

No.	Plate	Name
*52201	-----	Oil Absorbent Wick.....
52202	7732	" " " 52201 with 52203, for lower cavity in head of Arm.....
*52203	-----	Oil Absorbent Wick Wire.....
127191	22201	" Tube with 52184.....
127091	22201	" " Bracket.....
127092	22201	" " " 127091 with 127191, for oiling Feed Connecting Link.....
52184	7736	Oil Tube Packing (wick).....
12391	22202	Presser Bar (hollow).....
52338	5936	" " Guide Bracket with 223C and 453C.....
453C	5936	Presser Bar Guide Bracket Set Screw.....
52016	5936	" " Lifter.....
689C	5936	" " " Hinge Screw.....
1520J	5936	" " " " Nut.....
12327	5936	" " Lifting and Releasing Lever Bracket.....
127108	22202	Presser Bar Spring.....
11170	5936	" " " Washer.....
62527	21809	" Foot Hinge Pin.....
52426	-----	" " Plate.....
52390	-----	" " Shank.....
26231	7738	" " Spring.....
52427	7738	Presser Foot (spring hinged) complete, Nos. 26231, 52390, 52426 and 62527.....
176J	21809	Presser Foot Screw.....
688J	7735	Pressure Regulating Thumb Screw.....
1986	7737	Roller, 7/8 in. diam., 9/64 in. face, fine with 652D and 1528D, for 52461.....
51824	7737	Roller, 9/16 in. diam., 3/16 in. face, coarse, with 388D and 1550D, for 52457.....
52456	7737	Roller Arm for 52457.....
52460	7737	" " " 52461.....
440F	7737	" " Adjusting Screw.....
1547J	7737	" " " Nut.....
2206	7737	" " Bracket.....
316F	7737	" " " Screw Center.....
1547J	7737	" " " " Nut.....
2205	7737	" " Lock Spring.....
176D	21809	" " " " Screw.....
1549J	7737	" " " " " Nut.....
389D	7737	" Screw.....
652D	7737	" Screw.....
1528D	7737	" " Nut.....
1550D	2834	" " Nut.....
52457	22202	Roller Presser complete, 9/16 in. coarse roller, Nos. 176D, 440F, 1549J, 2205, 2206, 51824, 52456, two 316F and three 1547J..

No.	Plate	Name
52461	22202	Roller Presser complete, 7/8 in. fine roller, Nos. 176D, 440F, 1549J, 1986, 2205, 2206, 52460, two 316F and three 1547J...
127095	-----	Rotating Hook with three 1253C.....
127096	-----	" " 127095 with 127102 and four 1053D.....
*127119	-----	Rotating Hook 127096 with 40274, 127100 and three 1367D.....
127097	21808	Rotating Hook 127096 with 40274 and three 1367D (For Agents Only).....
127098	-----	Rotating Hook 127119 with 52473.....
40264	21808	" " Bobbin.....
52472	-----	" " " Case.....
52481	-----	" " " " 52472 with 591F, 1380E and 40394.....
40392	21808	Rotating Hook Bobbin Case Latch.....
125320	21808	" " " " " Lever.....
2974	21808	" " " " " " Full- crum Pin.....
2975	21808	Rotating Hook Bobbin Case Latch Spring....
592E	21808	" " " " " Stop Screw
40393	-----	" " " " " Hinge Nos. 2974, 40392 and 125320.....
591F	21808	Rotating Hook Bobbin Case Tension Regulat- ing Screw.....
40394	21808	Rotating Hook Bobbin Case Tension Spring..
1380E	21808	" " " " " " Screw.....
52473	21808	Rotating Hook Bobbin Case complete, Nos. 592E, 2975, 40393 and 52481.....
127099	-----	Rotating Hook Bobbin Case 52473 with 127100 (For Agents Only).....
127100	21808	Rotating Hook Bobbin Case Holder with 52475 and two 52476.....
52018	21808	Rotating Hook Bobbin Case Holder Position Bracket.....
704J	21809	Rotating Hook Bobbin Case Holder Position Bracket Screw.....
*52475	-----	Rotating Hook Bobbin Case Locating Plate..
*52476	-----	" " " " " Rivet.....
40274	21808	Rotating Hook Section.....
1367D	21808	" " " Screw.....
1253C	21809	" " Set Screw.....
127059	7733	" " Shaft.....
127004	21804	" " Bushing (back).....
127043	-----	" " " " " 127004 with 52045.....

No.	Plate	Name
52045	7736	Rotating Hook Shaft Bushing (back) Packing (wick).....
1143C	21809	Rotating Hook Shaft Bushing (back) Set Screw.....
127005	21804	Rotating Hook Shaft Bushing (front).....
127044	-----	" " " " " 127005 with 52045.....
54897	21809	Rotating Hook Shaft Bushing (front) Oil Cup.....
52045	7736	Rotating Hook Shaft Bushing (front) Packing (wick).....
1148C	21809	Rotating Hook Shaft Bushing (front) Set Screw.....
127073	21827	Rotating Hook Shaft Bevel Gear with two 1259C.....
127007	21811	Rotating Hook Shaft Bevel Gear Case (two pieces) with 121E and 50234E.....
50234E	7737	Rotating Hook Shaft Bevel Gear Case Plug Screw.....
121E	21827	Rotating Hook Shaft Bevel Gear Case Screw.
1259C	21809	" " " " " Set Screw..
127102	21808	" " Thread Guard.....
1053D	21809	" " " " Screw.....
52337	5936	Slack Thread Regulator.....
223C	5936	" " " Set Screw.....
2102	3471	Tension Disc.....
1560C	21809	" Regulating Thumb Nut.....
32572	7735	" Releasing Disc.....
43944	5936	" " Lever.....
12398	5936	" " " Hinge Pin.....
12329	5936	" " " Spring.....
32574	7735	" " Pin.....
2103	7735	" Spring.....
50304C	7735	" Stud.....
52098	-----	" " 50304C with 1560C.....
50305C	7725	" " Set Screw.....
52397	-----	Tension complete, Nos. 2103, 32572, 32574, 52083, 52098, 52394 and two 2102.....
52027	7735	Thread Guard (side of arm).....
52454	21804	" Retainer.....
624C	21809	" " Set Screw.....
52215	-----	Thread Take-up complete, Nos. 11204, 52025 and 52217.....
52216	21804	Thread Take-up Crank.....
52217	-----	" " " 52216 with 775E and 52206.....
1037C	21809	Thread Take-up Crank Position Screw.....
1038C	21809	" " " Set Screw.....
52022	22201	" " Lever with 52130.....

No.	Plate	Name
52023	21809	Thread Take-up Lever Hinge Pin.....
52024	21804	" " " Link.....
11204	21804	" " " " Hinge Pin.....
435C	7725	" " " " " Set Screw.....
52130	7725	Thread Take-up Lever Thread Eyelet Bushing
52025	-----	Thread Take-up Lever complete, Nos. 52022 to 52024.....
52394	7735	Thread Take-up Spring.....
52083	7735	" " " Regulator with 50305C
448C	7725	" " " " Set Screw.
20356	7738	Throat Plate, large needle hole, for 26603 28360 and 121446.....
20357	-----	Throat Plate, small needle hole, for 26603 28360 and 121446.....
Note: Throat Plate 20356 is sent with this machine unless another Throat Plate is specified on order.		
691F	7738	Throat Plate Screw.....
44212	7734	Drip Pan with four 1 in. wire nails.....
*15404	-----	Trade Mark.....
15405	-----	" " Rivet.....

SINGER Needles should be used
in SINGER Machines
These Needles and their Containers
are marked with the
Company's Trade Mark "SIMANCO.**" 1

Needles in Containers marked
"FOR SINGER MACHINES"
are NOT SINGER made needles. 2

MACHINE BASE

No.	Plate	Name
19219	7729	Bed Frame Cushion (leather).....
158C	21827	" " " Screw.....
19220	7730	" " " Spring.....
19226	7730	" " Hinge Connection.....
19398	-----	" " " " 19226 with 211E and 19397.....
19397	7729	Bed Frame Hinge Connection Cap.....
211E	7729	" " " " " Screw.....
16555	7730	" " " Plate.....
14010	7729	" " " Rivet.....
20087	819	" " with two each 16555,19398, four each 19219,19220, six each 14010, wood screws 1 1/4 in. No. 12 and eight 158C.

SINGER Needles should be used
in SINGER Machines
These Needles and their Containers
are marked with the
Company's Trade Mark "SIMANCO.***" 1

Needles in Containers marked
"FOR SINGER MACHINES"
are NOT SINGER made needles. 2

ACCESSORIES

No.	Plate	Name
12361	7730	Machine Hinge Connection.....
44139	7730	" " Plate.....
44140	-----	Machine Hinge complete, Nos. 12361,44139 and merlized wood screw 1 1/4 in. No.14
12405	7729	Machine Rest Felt.....
41400	22202	" " Pin (wood).....
120342	21835	Oiler (copper plated) with 120343.....
120343	21835	" Spout, 3 1/2 in. long.....
26026	21835	Screw Driver (large).....
26485	21835	" " (small).....
8909	21835	Wrench for 1513 and 1518.....
8908	21835	" " 1519 and 1520.....

BOBBIN WINDERS

BOBBIN WINDER
(SWINGING AUTOMATIC, LEFT HAND)

No.	Plate	Name
41913	21834	Bracket with 457C.....
41583	21834	Frame with 457C.....
34105	21834	" Hinge Pin.....

No.	Plate	Name
457C	7729	Frame Hinge Pin Set Screw.....
41914	21834	" Spring.....
41585	21834	Pulley with 171D.....
171D	7729	" Set Screw.....
41586	21834	Spindle.....
41587	21834	Stop Latch.....
42614	21834	" " Hinge Stud.....
457C	7729	" " " " Set Screw.....
7958	7729	" " Stop Pin.....
41588	21834	" " Tripping Arm with 185H.....
185H	7729	" " " " Clamping Screw.....
150459	21834	Tension Bracket with 460C.....
150460	----	Tension Bracket complete, Nos. 12403,41593 to 41595,52186,127187,150459 and two 2455.....
158J	21827	Tension Bracket Screw.....
12403	7725	" " Spool Pin and Thread Eye- let.....
8879	5936	Tension Bracket Spool Pin Washer (cloth)..
2455	2834	" Disc.....
41593	5936	" Spring.....
41594	5936	" Stud.....
460C	7729	" " Set Screw.....
41595	5936	" Thread Guide.....
60845	----	Bobbin Winder, Nos. 7958,34105,41583,41585 to 41588,41913,41914 and 42614.....
41915	21834	Bobbin Winder 60845 with 880E and 25446...
150461	----	Bobbin Winder (swinging automatic, left hand) complete, Nos. 41915 and 150460..
880E	7729	Bobbin Winder Screw.....
25446	7729	" " " Washer.....

BOBBIN WINDER
(SWINGING AUTOMATIC, RIGHT HAND)

No.	Plate	Name
41339	2833	Base.....
41340	2833	Frame.....
1429D	2834	" Hinge Screw.....
41341	2833	" Spring.....
207D	2834	" " Screw.....
41342	2833	Pulley with 200F.....
200F	2834	" Set Screw.....
41343	2834	Spindle.....
27306	2834	Spool Pin.....
27307	2833	" Stand.....

No.	Plate	Name
27308	2833	Spool Stand complete, Nos. 418E,1562J,2106 10141,11241,27306,27307 and two each 2455 and wood screws 1 in. No. 10.....
11241	2833	Spool Washer (cloth).....
41344	2834	Stop Latch.....
41345	2834	" " Finger.....
152F	2834	" " " Screw.....
1430D	2834	" " Hinge Screw.....
1550H	2834	" " " " Nut.....
41346	2834	" " Lever.....
1430D	2834	" " " Hinge Screw.....
2455	2834	Tension Disc.....
1562J	2834	" " Regulating Thumb Nut.....
418E	2834	" " Screw Stud.....
10141	2834	" Spring.....
2106	2834	" Thread Guide.....
60456	----	Bobbin Winder, Nos. 152F,207D,1429D,1550H, 41339 to 41346 and three 1430D.....
41347	2833	Bobbin Winder, Nos. 60456 and two each 9331 and wood screws 1 in. No. 10 R.H.H
41348	----	Bobbin Winder (swinging automatic, right hand) complete, Nos. 27308 and 41347...
9331	2834	Bobbin Winder Washer.....

BOBBIN WINDER
(SWINGING AUTOMATIC, RIGHT HAND)
FOR POWER TABLE

No.	Plate	Name
225433	22205	Bobbin Winder and Tension Bracket Base....
225453	22204	Frame with 202277 and 225438.....
225454	3471	" Hinge Pin.....
202277	3471	" Oil Packing (wick).....
225438	3471	" " Well Cap.....
225455	3471	" Spring.....
225456	3471	" " Plunger.....
202473	22204	Pulley with 200380C.....
200380C	3471	" Set Screw.....
225381	22204	Spindle.....
225444	3471	Stop Latch.....
200056E	3471	" " Screw.....
225458	3471	" " Thumb Lever.....
225459	3471	" " " " Hinge Stud.....
225459	3471	" " " " Joint Stud.....
202478	3471	" " Trip Lever.....
200299H	3471	" " " " Hinge Screw.....

No.	Plate	Name
225461	3471	Tension Bracket with 201499B.....
200082D	3471	" " Screw.....
228026	-----	" " Washer.....
2102	3471	" Disc.....
202407	3471	" Spring.....
201499B	3471	" Stud.....
201572B	3471	" " Thumb Nut.....
225462	-----	Tension Bracket complete, Nos. 201572B, 202407,225461 and two 2102.....
225382	22205	Bobbin Winder complete, Nos.200056E, 200082D,200299H,202473,202478,225381, 225433,225444,225453 to 225456,225458, 225462,228026, two each 225459 and wood screws 3/4 in. No. 12 R.H.B.....

FINGER GUARDS

No.	Plate	Name
36818	22202	Finger Guard.....
36819	7736	" " Friction Washer.....
36820	22202	" " Holder with 196J.....
196J	7736	" " " Screw.....
50316J	7736	" " Set Screw.....
36821	22202	Finger Guard complete, Nos. 36818 to 36820 and 50316J.....
120496	22202	Finger Guard.....
120497	22202	" " Holder with 50302J.....
50302J	7736	" " " Screw.....
236J	7736	" " Set Screw.....
120498	22202	Finger Guard complete, Nos. 236J,120496 and 120497.....
120857	22202	Finger Guard.....
120858	22202	" " Holder with 50302J.....
50302J	7736	" " " Screw.....
236J	7736	" " Set Screw.....
120860	22202	Finger Guard complete, Nos. 120857, 120858 and two 236J.....

FOOT LIFTER PARTS

No.	Plate	Name
5596	7732	Bell Crank.....
56848	-----	" " 5596 with 5599 and 5601.....

No.	Plate	Name
5599	7732	Bell Crank Bracket.....
178E	7729	" " " Screw.....
5601	7729	" " Hinge Pin.....
5735	7730	" " Spring.....
5598	7732	Bell Crank complete, Nos. 5735 and 56848..
5670	-----	Chain, length 28 in. to 35 in., with 56864 and 56865.....
Note: When ordering No. 5670, state length required		
56864	7730	Chain Hook (large).....
56865	7730	" " (small).....
4879	7730	" Connecting Link.....
12237	22203	Lifting Lever with 448C.....
52028	22203	" " Connecting Rod.....
12416	5936	" " " " Joint.....
76D	7729	" " " " Hinge Screw.....
1521E	7729	Lifting Lever Connecting Rod Lock Nut.....
802D	7729	" " Hinge Screw.....
12241	5936	" " Link.....
766D	7729	" " " Hinge Screw.....
12240	5936	" " Pin.....
448C	7725	" " Set Screw.....
2763	819	Rock Shaft.....
12242	819	" " Hanger with two wood screws 1 in. No. 10.....
6337	819	Rock Shaft Lifting Bracket with two 356C..
12243	819	" " " " Hook.....
7125	819	" " " " Hook.....
356C	7729	" " " " Set Screw.
356C	7729	" " " " Set Screw.....
2770	22205	" " Stop Dog with 356C.....
356C	7729	" " " Set Screw.....
4880	819	Rock Shaft complete, Nos. 2763,2770, 7125 12243 and two each 6337 and 12242.....
4881	819	Treadle.....
4882	22202	" Shaft.....
4883	22202	" Spring.....
4884	819	" Stand.....
4885	819	Treadle complete, Nos. 4879,4881 to 4884 and two wood screws 1 in. No. 16.....
52319	-----	Foot Lifter complete, Nos. 76D,766D,802D, 1521E,4880,4885,5598,5670,12237,12240, 12241,12416,52028 and two 178E.....

KNEE LIFTER PARTS

No.	Plate	Name
5596	7732	Bell Crank.....
56848	-----	" " 5596 with 5599 and 5601.....
5599	7732	" " Bracket.....
178E	7729	" " " Screw.....
5601	7729	" " Hinge Pin.....
5735	7730	" " Spring.....
5598	7732	Bell Crank complete, Nos. 5735 and 56848..
12237	22203	Lifting Lever with 448C.....
52028	22203	" " Connecting Rod.....
12416	5936	" " " " Joint.....
76D	7729	" " " " " Hinge Screw.....
1521E	7729	Lifting Lever Connecting Rod Lock Nut....
802D	7729	" " Hinge Screw.....
12241	5936	" " Link.....
766D	7729	" " " Hinge Screw.....
12240	5936	" " Pin.....
448C	7725	" " " Set Screw.....
2763	819	Rock Shaft.....
7539	22205	" " Hanger with two wood screws 1 in. No. 10.....
2765	22205	Rock Shaft Knee Arm.....
2766	22205	" " " Hub with 356C.....
356C	7729	" " " " Set Screw.....
2768	-----	Rock Shaft Knee Arm complete, Nos. 2765 to 2767.....
2767	22205	Rock Shaft Knee Plate with 356C.....
356C	7729	" " " " Set Screw.....
6337	819	" " Lifting Bracket with two 356C..
2778	22205	" " " " Hook.....
356C	7729	" " " " Set Screw.....
356C	7729	" " " " Set Screw.....
2770	22205	" " Stop Dog with 356C.....
356C	7729	" " " " Set Screw.....
12250	22205	Rock Shaft complete, Nos. 2763,2768,2778, 6337 and two each 2770 and 7539.....
52320	-----	Knee Lifter complete (power table) Nos.76D 766D,802D,1521E,5598,12237,12240,12241, 12250,12416,52028 and two 178E.....

THREAD UNWINDER

FOR TWO SPOOLS OR TWO LARGE CONES OF THREAD

No.	Plate	Name
225257	20335	Spool Rest with 201018C.....
150203	20335	" " Cushion (felt).....
225388	20335	" " Rod.....
200383C	7729	" " " Set Screw.....
201018C	7729	" " " Set Screw.....
202490	20335	" Stand with 200383C.....
225391	20335	Thread Guide.....
201696J	7729	" " Lock Nut.....
225326	20335	" " Position Cup.....
225324	20335	" " Rod with 208E and 225322.....
208E	7729	" " " Screw.....
225322	7729	" " " Washer.....
225258	20335	Thread Unwinder complete, Nos. 201696J, 202490,225257,225324,225326,225388, two each 150203,225391 and three wood screws 7/8 in. No. 12.....
27739	22204	Thread Cone (wood) for large cones.....
225390	22204	" " Holder for inverted cones.....

Note: Nos. 27739 and 225390 are used with, but not
included in 225258.

OBSOLETE PARTS

No.	Plate	Name
127080	22203	Arm Top Cover for 52175.....
52175	22203	" " " 127080 with 12403,52186 and 127187.....
24040	7736	Needle Bar Connecting Link with 794E for 24894.....
24894	-----	Needle Bar Connecting Link 24040 with 24041, for 52143.....
794E	7735	Needle Bar Connecting Link Adjusting Screw for 24040.....
24052	22203	Needle Bar Crank with 1036C,1037C and 1065C, for 96-41 Machine.....
52436	22203	Needle Bar Crank with 1036C,1037C and 1065C, for 96-44 Machine.....
52054	-----	Thread Take-up complete for 96-41 Machine, Nos. 11204,52025 and 52143.....
52021	7736	Thread Take-up Crank for 52143.....

No.	Plate	Name
52143	-----	Thread Take-up Crank 52021 with 775E and 24894, for 52054.....
150371	22203	Bobbin Winder Tension Bracket with 460C, for 150374.....
150374	-----	Bobbin Winder Tension Bracket complete, Nos. 12403,41593 to 41595,52186,127187, 150371 and two 2455, for 150375.....
150375	-----	Bobbin Winder (swinging automatic, left hand) complete, Nos. 41915 and 150374..

SINGER Needles should be used
in SINGER Machines
These Needles and their Containers
are marked with the
Company's Trade Mark "SIMANCO."**" 1

Needles in Containers marked
"FOR SINGER MACHINES"
are NOT SINGER made needles. 2

NUMERICAL LIST OF PARTS

No.	Plate	Name
76D	7729	Lifting Lever Connecting Rod Joint Hinge Screw for 52319 and 52320.....
116E	7725	Arm Screw (back).....
121E	21827	" Shaft (horizontal) Bevel Gear Case Screw for 127070.....
121E	21827	Rotating Hook Shaft Bevel Gear Case Screw for 127007.....
144D	21827	Arm Shaft (horizontal) Screw.....
152F	2834	Bobbin Winder Stop Latch Finger Screw for 60458.....
157J	21827	Feed Lifting Rock Shaft Crank Clamping Screw for 12376 and 52434.....
157J	21827	Feed Rock Shaft Crank Clamping Screw for 29633.....
158J	21827	Arm Top Cover Screw.....
158C	21827	Bed Frame Cushion Screw for 20067.....
158J	21827	Bobbin Winder Tension Bracket Screw.....
158E	21827	Feed Reverse Lever Hinge Screw Clamping Screw for 52409.....
171D	7729	Bobbin Winder Pulley Set Screw for 41585..
176J	21809	Face Plate Screw.....
176J	21809	Presser Foot Screw.....
176D	21809	Roller Arm Lock Spring Screw for 52457 and 52461.....
178E	7729	Bell Crank Bracket Screw for 52319 and 52320.....
185H	7729	Bobbin Winder Stop Latch Tripping Arm Clamping Screw for 41588.....
196J	7736	Finger Guard Holder Screw for 36820.....
200F	2834	Bobbin Winder Pulley Set Screw for 41342..
207D	2834	" " Frame Spring Screw for 60458
207E	2834	Needle Bar Connecting Stud Clamping Screw for 24041.....
208E	7729	Thread Unwinder Thread Guide Rod Screw for 225324.....
210J	7725	Balance Wheel Oil Cover Screw.....
211E	7729	Bed Frame Hinge Connection Cap Screw for 19398.....
219J	7725	Arm Side Cap Screw.....
223C	5936	Slack Thread Regulator Set Screw for 52338
226J	21809	Face Plate Thread Guard (lower) Screw for 52052.....
226J	21809	Face Plate Thread Guard (upper) Screw for 52052.....

No.	Plate	Name
229J	7725	Needle Bar Thread Guard Screw for 127118..
236J	7738	Finger Guard Set Screw for 120498 and 120860.....
313C	21827	Feed Bar Screw Center for 56813.....
316F	7737	Roller Arm Bracket Screw Center for 52457 and 52461.....
356C	7729	Rock Shaft Knee Arm Hub Set Screw for 2768
356C	7729	" " " Plate Set Screw for 2767..
356C	7729	" " Lifting Bracket Hook Set Screw for 6337.....
356C	7729	Rock Shaft Lifting Bracket Set Screw for 6337.....
356C	7729	Rock Shaft Stop Dog Set Screw for 2770....
375C	21827	Feed Connecting Link Hinge Screw.....
375C	21827	" Forked Connection Hinge Screw for 52451.....
375C	21827	Feed Lifting Rock Shaft Connecting Rod Hinge Screw.....
388D	7737	Roller Screw for 51824.....
418E	2834	Bobbin Winder Tension Disc Screw Stud for 27308.....
432C	21809	Arm Shaft (upright) Bushing (lower) Set Screw.....
435C	7725	Arm Shaft (horizontal) Flanged Bushing (front) Set Screw.....
435C	7725	Arm Shaft (upright) Bushing (upper) Set Screw.....
435C	7725	Thread Take-up Lever Link Hinge Pin Set Screw.....
440F	7737	Roller Arm Adjusting Screw for 52457 and 52461.....
448C	7725	Arm Shaft (horizontal) Flanged Bushing (back) Set Screw.....
448C	7725	Balance Wheel Set Screw for 52187.....
448C	7725	Feed and Feed Lifting Eccentric Set Screw for 127202.....
448C	7725	Lifting Lever Pin Set Screw for 12237....
448C	7725	Thread Take-up Spring Regulator Set Screw.
453C	5936	Presser Bar Guide Bracket Set Screw for 52338.....
457C	7729	Bobbin Winder Frame Hinge Pin Set Screw for 41583.....
457C	7729	Bobbin Winder Stop Latch Hinge Stud Set Screw for 41913.....
480C	7729	Bobbin Winder Tension Stud Set Screw for 150371 and 150459.....
591F	21808	Rotating Hook Bobbin Case Tension Regulating Screw for 52481.....

No.	Plate	Name
592E	21808	Rotating Hook Bobbin Case Latch Stop Screw for 52473.....
624C	21809	Thread Retainer Set Screw.....
652D	7737	Roller Screw for 1986.....
688J	7735	Pressure Regulating Thumb Screw.....
689C	5936	Presser Bar Lifter Hinge Screw.....
691F	7738	Throat Plate Screw.....
704J	21809	Rotating Hook Bobbin Case Holder Position Bracket Screw.....
725E	21827	Bed Slide Spring Screw for 12432.....
766D	7729	Lifting Lever Link Hinge Screw for 52319 and 52320.....
775E	21809	Needle Bar Connecting Link Cap Screw for 52143,52217 and 127065.....
794E	7735	Needle Bar Connecting Link Adjusting Screw for 24040, obsolete.....
802D	7729	Lifting Lever Hinge Screw for 52319 and 52320.....
854E	7725	Arm Screw (front).....
880E	7729	Bobbin Winder Screw for 41915.....
966E	21827	Feed Lifting Rock Shaft Connecting Rod Cap Screw for 127158.....
1036C	21809	Arm Shaft (horizontal) Bevel Gear Set Screw for 127072.....
1036C	21809	Thread Take-up Crank Set Screw for 24052, 52436,127201 and 127222.....
1037C	21809	Thread Take-up Crank Position Screw for 24052,52436,127201 and 127222.....
1053D	21809	Rotating Hook Thread Guard Screw for 127098.....
1065C	7725	Needle Bar Crank Position Screw for 24052, 52436,127201 and 127222.....
1128E	7725	Feed Regulator Hinge Screw.....
1133E	21809	Needle Bar Bushing (lower) Set Screw.....
1133E	21809	" " " (upper) Set Screw.....
1143C	21809	Rotating Hook Shaft Bushing (back) Set Screw.....
1148C	21809	Rotating Hook Shaft Bushing (front) Set Screw.....
1253C	21809	Rotating Hook Set Screw for 127095.....
1259C	21809	Arm Shaft (upright) Bevel Gear (lower) Set Screw for 127073.....
1259C	21809	Arm Shaft (upright) Bevel Gear (upper) Set Screw for 127074.....
1259C	21809	Rotating Hook Shaft Bevel Gear Set Screw for 127073.....
1299C	21809	Feed and Feed Lifting Eccentric Position Screw for 127202.....

No.	Plate	Name
1367D	21808	Rotating Hook Section Screw for 127097 and 127119.....
1380E	21808	Rotating Hook Bobbin Case Tension Spring Screw for 52481.....
1429D	2834	Bobbin Winder Frame Hinge Screw for 60456.
1430D	2834	" " Stop Latch Hinge Screw for 60456.....
1430D	2834	Bobbin Winder Stop Latch Lever Hinge Screw for 60456.....
1513J	21827	Feed Lifting Rock Shaft Screw Center Nut for 52097.....
1513J	21827	Feed Rock Shaft Screw Center Nut for 52097
1518J	21827	" Connecting Link Hinge Screw Nut.....
1518E	21827	" Forked Connection Hinge Screw Nut for 52451.....
1518J	21827	Feed Lifting Rock Shaft Connecting Rod Hinge Screw Nut.....
1519J	21809	Feed Bar Screw Center Nut for 56813.....
1520J	5936	Presser Bar Lifter Hinge Screw Nut.....
1521E	7729	Lifting Lever Connecting Rod Lock Nut for 52319 and 52320.....
1528D	7737	Roller Screw Nut for 1986.....
1547J	7737	" Arm Adjusting Screw Nut.....
1547J	7737	" " Bracket Screw Center Nut for 52457 and 52461.....
1549J	7737	Roller Arm Lock Spring Screw Nut for 52457 and 52461.....
1550H	2834	Bobbin Winder Stop Latch Hinge Screw Nut for 60456.....
1550D	2834	Roller Screw Nut for 51824.....
1560C	21809	Tension Regulating Thumb Nut for 52098....
1562J	2834	Bobbin Winder Tension Disc Regulating Thumb Nut for 27308.....
1811	7735	Feed Reverse Lever Roller and Stud for 96-44 Machine.....
1813	21827	Feed Lifting Rock Shaft Crank Roller and Stud for 12376 and 52434.....
1986	7737	Roller, 7/8 in. diam., 9/64 in. face, fine, with 652D, and 1528D, for 52461.....
2102	3471	Bobbin Winder Tension Disc for 225462....
2102	3471	Tension Disc for 52397.....
2103	7735	" Spring for 52397.....
2106	2834	Bobbin Winder Tension Thread Guide for 27308.....
2205	7737	Roller Arm Lock Spring for 52457 and 52461
2206	7737	" " Bracket for 52457 and 52461....
2455	2834	Bobbin Winder Tension Disc for 27308, 150374 and 150460.....

No.	Plate	Name
2763	819	Rock Shaft for 4880 and 12250.....
2765	22205	" " Knee Arm for 2768.....
2766	22205	" " " Hub with 356C, for 2768.....
2767	22205	Rock Shaft Knee Plate with 356C, for 2768.
2768	-----	Rock Shaft Knee Arm complete, Nos. 2765, to 2767, for 12250.....
2770	22205	Rock Shaft Stop Dog with 356C, for 4880 and 12250.....
2778	22205	Rock Shaft Lifting Bracket Hook for 12250.
2974	21808	Rotating Hook Bobbin Case Latch Lever Fulcrum Pin for 40393.....
2975	21808	Rotating Hook Bobbin Case Latch Spring for 52473.....
4307	7739	Bed Slide Spring for 12432.....
4879	7730	Chain Connecting Link for 4885.....
4880	819	Rock Shaft complete, Nos. 2763, 2770, 7125, 12243 and two each 6337 and 12242, for 52319.....
4881	819	Treadle for 4885.....
4882	22202	" Shaft for 4885.....
4883	22202	" Spring for 4885.....
4884	819	" Stand for 4885.....
4885	819	Treadle complete, Nos. 4879, 4881 to 4884 and two wood screws 1 in. No. 16, for 52319.....
5596	7732	Bell Crank for 56848.....
5598	7732	Bell Crank complete, Nos. 5735 and 56848, for 52319 and 52320.....
5599	7732	Bell Crank Bracket for 56848.....
5601	7729	" " Hinge Pin for 56848.....
5670	-----	Chain length 28 in. to 35 in. with 56864 and 56885, for 52319.....
5735	7730	Bell Crank Spring for 5598.....
5990	22202	Presser Bar Lifter, for 96-44 Machine....
6337	819	Rock Shaft Lifting Bracket with two 356C, for 4880 and 12250.....
7125	819	Rock Shaft Lifting Bracket Hook for 4880..
7298	7738	Presser Foot Hinge Pin for 52439.....
7539	22205	Rock Shaft Hanger with two wood screws 1 in. No. 10, for 12250.....
7958	7729	Bobbin Winder Stop Latch Stop Pin for 60845.....
8879	5936	Arm Spool Pin Washer (cloth).....
8879	5936	Bobbin Winder Tension Bracket Spool Pin Washer (cloth).....
8908	21835	Wrench for 1519 and 1520 (Accessories)....
8909	21835	" " 1513 and 1518 (Accessories)....
9331	2834	Bobbin Winder Washer for 41347.....

No.	Plate	Name
10141	2834	Bobbin Winder Tension Spring for 27308....
11170	5936	Presser Bar Spring Washer.....
11204	21804	Thread Take-up Lever Link Hinge Pin for 52054, 52215 and 52447.....
11241	2833	Bobbin Winder Spool Washer (cloth) for 27308.....
12237	22203	Lifting Lever with 448C, for 52319 and 52320.....
12240	5936	Lifting Lever Pin for 52319 and 52320....
12241	5936	" " Link for 52319 and 52320....
12242	819	Rock Shaft Hanger with two wood screws 1 in. No. 10, for 4880.....
12243	819	Rock Shaft Lifting Bracket Hook for 4880..
12250	22205	Rock Shaft complete, Nos. 2763, 2768, 2778, 6337 and two each 2770 and 7539, for 52320.....
12327	5936	Presser Bar Lifting and Releasing Lever Bracket.....
12329	5936	Tension Releasing Lever Spring.....
12361	7730	Machine Hinge Connection for 44140.....
12376	7739	Feed Lifting Rock Shaft Crank with 157J and 1813, for 52385.....
12391	22202	Presser Bar (hollow).....
12398	5936	Tension Releasing Lever Hinge Pin.....
12403	7725	Arm Spool Pin and Thread Eyelet for 52175 and 127193.....
12403	7725	Bobbin Winder Tension Bracket Spool Pin and Thread Eyelet for 150374 and 150460
12405	7729	Machine Rest Felt (Accessories).....
12416	5936	Lifting Lever Connecting Rod Joint for 52319 and 52320.....
12431	-----	Bed Slide for 12432.....
12432	21806	Bed Slide complete, Nos. 4307, 12431 and two 725E.....
14010	7729	Bed Frame Hinge Plate Rivet for 20067.....
*15404	-----	Trade Mark for 127214.....
15405	-----	" " Rivet for 127214.....
16532	21801	Arm Dowel Pin.....
16555	7730	Bed Frame Hinge Plate for 20067.....
19219	7729	" " Cushion (leather) for 20067.....
19220	7730	" " Spring for 20067.....
19226	7730	" " Hinge Connection for 19398.....
19397	7729	" " " " Cap for 19398..
19398	-----	" " " " 19226 with 211E and 19397, for 20067.....
20067	819	Machine Base Bed Frame with two each 16555 19398, four each 19219, 19220, six each 14010 wood screws 1 1/4 in. No. 12 and eight 158C.....

No.	Plate	Name
20356	7738	Throat Plate, large needle hole, for 26603 28360 and 121446.....
20357	-----	Throat Plate, small needle hole, for 26603 28360 and 121446.....
24040	7736	Needle Bar Connecting Link with 794E, for 24894, obsolete.....
24041	21804	Needle Bar Connecting Stud with 207E, for 24894 and 52206.....
24052	22203	Needle Bar Crank with 1036C, 1037C and 1065C, for 96-41 Machine, obsolete....
24894	-----	Needle Bar Connecting Link 24040 with 24041, for 52143, obsolete.....
25446	7729	Bobbin Winder Screw Washer for 41915.....
25866	22201	Guide.....
26026	21835	Screw Driver (large) Accessories.....
26231	7738	Presser Foot Spring for 52427 and 52439...
26485	21835	Screw Driver (small) Accessories.....
26803	-----	Feed Dog, 20 teeth (16 teeth to the inch) for 20356 and 20357.....
27306	2834	Bobbin Winder Spool Pin for 27308.....
27307	2833	" " Stand for 27308.....
27308	2833	Bobbin Winder Spool Stand complete, Nos. 416E, 1562J, 2106, 10141, 11241, 27306, 27307 and two each 2455 and wood screws 1 in. No. 10, for 41348.....
27739	22204	Thread Unwinder Thread Cone (wood) for large cones.....
28360	-----	Feed Dog, 15 conical teeth (12 teeth to the inch) for 20356 and 20357.....
29633	7739	Feed Rock Shaft Crank with 157J, for 52387
32572	7735	Tension Releasing Disc for 52397.....
32574	7735	" " Pin for 52397.....
34105	21834	Bobbin Winder Frame Hinge Pin for 60845...
36818	22202	Finger Guard for 36821.....
36819	7736	" " Friction Washer for 36821....
36820	22202	" " Holder with 196J, for 36821..
36821	22202	Finger Guard complete, Nos. 36818 to 36820 and 50316J.....
40264	21808	Rotating Hook Bobbin.....
40274	21808	" " Section for 127097 and 127119.....
40392	21808	Rotating Hook Bobbin Case Latch for 40393.
40393	-----	" " " " Hinge, Nos. 2974 40392 and 125320, for 52473.....
40394	21808	Rotating Hook Bobbin Case Tension Spring for 52481.....
41339	2833	Bobbin Winder Base for 60456.....
41340	2833	" " Frame for 60456.....
41341	2833	" " Spring for 60456.....

No.	Plate	Name
41342	2833	Bobbin Winder Pulley with 200F, for 60456.
41343	2834	" " Spindle for 60456.....
41344	2834	" " Stop Latch for 60456.....
41345	2834	" " " " Finger for 60456.
41346	2834	" " " " Lever for 60456..
41347	2833	Bobbin Winder Nos. 60456 and two each 9331 and wood screws 1 in. No. 10 R.H.B. for 41348.....
41348	-----	Bobbin Winder (swinging automatic, right hand) complete, Nos. 27308 and 41347...
41400	22202	Machine Rest Pin (wood) Accessories.....
41583	21834	Bobbin Winder Frame with 457C, for 60845..
41585	21834	" " Pulley with 171D, for 60845..
41586	21834	" " Spindle for 60845.....
41587	21834	" " Stop Latch for 60845.....
41588	21834	" " " " Tripping Arm with 185H, for 60845.....
41593	5936	Bobbin Winder Tension Spring for 150374 and 150460.....
41594	5936	Bobbin Winder Tension Stud for 150374 and 150460.....
41595	5936	Bobbin Winder Tension Thread Guide for 150374 and 150460.....
41913	21834	Bobbin Winder Bracket with 457C, for 60845
41914	21834	" " Frame Spring for 60845.....
41915	21834	" " 60845 with 880E and 25446, for 150375 and 150461.....
42367	21801	Arm Oil Tube Packing (braided cotton) for 52185 and 127187.....
42614	21834	Bobbin Winder Stop Latch Hinge Stud for 60845.....
43944	5936	Tension Releasing Lever.....
44139	7730	Machine Hinge Plate for 44140.....
44140	-----	Machine Hinge complete, Nos. 12361,44139 and merlized wood screw 1 1/4 in. No.14 (Accessories).....
44212	7734	Drip Pan with four 1 in. wire nails.....
50053J	21827	Arm Side Cover Thumb Screw.....
50083C	21827	Feed Connecting Link Hinge Stud Set Screw for 52408.....
50117E	21827	Feed Dog Screw.....
50190J	21827	Face Plate Thumb Screw.....
50190J	21827	Guide Thumb Screw.....
50191C	21827	Feed Lifting Rock Shaft Screw Center for 52097.....
50191C	21827	Feed Rock Shaft Screw Center for 52097....
50193J	7735	" Regulating Stud Head Cap Screw.....
50234E	7737	Rotating Hook Shaft Bevel Gear Case Plug Screw for 127007.....

No.	Plate	Name
50302J	7736	Finger Guard Holder Screw for 120497 and 120858.....
50304C	7735	Tension Stud for 52098.....
50305C	7725	" " Set Screw for 52083.....
50316J	7736	Finger Guard Set Screw for 36821.....
50338E	7735	Feed Regulating Stud.....
50339D	7735	" Reverse Lever Hinge Screw.....
51460F	7725	Needle Clamp Screw for 52307.....
51824	7737	Roller, 9/16 in. diam., 3/16 in. face, coarse, with 388D and 1550D, for 52457.
51846	7737	Feed Reverse Lever Roller and Stud for 52409.....
52014	22201	Needle Bar Bushing (upper).....
52016	5936	Presser Bar Lifter.....
52018	21808	Rotating Hook Bobbin Case Holder Position Bracket.....
52021	7736	Thread Take-up Crank for 52143, obsolete..
52022	22201	" " Lever with 52130, for 52025
52023	21809	" " " Hinge Pin for 52025..
52024	21804	" " " Link for 52025.....
52025	-----	Thread Take-up Lever complete, Nos. 52025 to 52024, for 52054,52215 and 52447....
52027	7735	Thread Guard (side of arm).....
52028	22203	Lifting Lever Connecting Rod for 52319 and 52320.....
52045	7736	Rotating Hook Shaft Bushing (back) Packing (wick) for 127043.....
52045	7736	Rotating Hook Shaft Bushing (front) Packing (wick) for 127044.....
52051	-----	Face Plate for 52052.....
52052	21811	Face Plate complete, Nos. 52051,52053, 52170 and two 226J.....
52053	7725	Face Plate Thread Guard (lower) for 52052.
52054	-----	Thread Take-up complete, for 96-41 Machine Nos. 11204,52025 and 52143, obsolete...
52063	21811	Balance Wheel Oil Cover.....
52073	21827	Feed Connecting Link Hinge Stud for 52411.
52083	7735	Thread Take-up Spring Regulator with 50305C, for 52397.....
52097	-----	Feed Lifting Rock Shaft Screw Center 50191C with 1513J.....
52097	-----	Feed Rock Shaft Screw Center 50191C with 1513J.....
52098	-----	Tension Stud 50304C with 1560C, for 52397.
52130	7725	Thread Take-up Lever Thread Eyelet Bushing for 52022.....
52143	-----	Thread Take-up Crank 52021 with 775E and 24894, for 52054, obsolete.....
52148	21801	Arm Oil Tube for 52149.....

No.	Plate	Name
52149	-----	Arm Oil Tube 52148 with 52150, for oiling 127073 and 127074.....
52150	21801	Arm Oil Tube Packing (braided cotton) for 52149.....
52165	21827	Feed Connecting Link for 52451.....
52170	7725	Face Plate Thread Guard (upper) for 52052.
52175	22203	Arm Top Cover 127080 with 12403,52186 and 127187, obsolete.....
52180	21801	Arm Oil Tube (long) with 52184, for oiling 52022.....
52182	21801	Arm Oil Tube with 52184, for oiling 24040.
52183	21801	" " " " 52184, for oiling 52024.
52184	7736	" " " Packing (wick) for 52180, 52182,52183 and 52186.....
52184	7736	Oil Tube Packing (wick) for 127191.....
52185	21801	Arm Oil Tube (short) with 42367 for oiling 52022.....
52186	21801	Arm Oil Tube with 52184, for oiling 127156 for 52175,127193,150374 and 150460.....
52187	21811	Balance Wheel (power disc) 2 3/16 in. pulley with two 448C.....
52191	7739	Arm Shaft (horizontal) Flanged Bushing (back) for 52192.....
52192	-----	Arm Shaft (horizontal) Flanged Bushing (back) 52191 with 52193 and 52194.....
52193	7725	Arm Shaft (horizontal) Flanged Bushing (back) Oil Pad (inside) braided cotton, for 52192.....
52193	7725	Arm Shaft (horizontal) Flanged Bushing (front) Oil Pad (inside) braided cotton for 52196.....
52194	7725	Arm Shaft (horizontal) Flanged Bushing (back) Oil Pad (outside) felt for 52192
52195	7739	Arm Shaft (horizontal) Flanged Bushing (front) for 52196.....
52196	-----	Arm Shaft (horizontal) Flanged Bushing (front) 52195 with 52193 and 52198.....
52198	7725	Arm Shaft (horizontal) Flanged Bushing (front) Oil Pad (outside) felt for 52196.....
*52201	-----	Oil Absorbent Wick for 52202.....
52202	7732	" " " 52201 with 52203, for lower cavity in head of Arm.....
*52203	-----	Oil Absorbent Wick Wire for 52202.....
52205	21804	Needle Bar Connecting Link with 52207, for 52206.....
52206	-----	Needle Bar Connecting Link 52205 with 24041, for 52217 and 127065.....

No.	Plate	Name
52207	7725	Needle Bar Connecting Link Lubricating Pad (wood) for 52205.....
52210	21827	Feed and Feed Lifting Eccentric Lubricating Pad (long) wood for 127202.....
52211	21827	Feed and Feed Lifting Eccentric Lubricating Pad (short) wood for 127202.....
52215	-----	Thread Take-up complete, Nos. 11204, 52025 and 52217.....
52216	21804	Thread Take-up Crank for 52217.....
52217	-----	" " " 52216 with 775E and 52206, for 52215.....
52306	7725	Needle Bar Thread Guard for 127116.....
52307	7725	" Clamp with 51460F, for 127116.....
52319	-----	Foot Lifter complete, Nos. 76D,766D,802D, 1521E,4880,4885,5598,5670,12237,12240, 12241,12416,52028 and two 178E.....
52320	-----	Knee Lifter complete (power table) Nos.76D 766D,802D,1521E,5598,12237,12240,12241, 12250,12416,52028 and two 178E.....
52337	5936	Slack Thread Regulator.....
52338	5936	Presser Bar Guide Bracket with 224C and 453C.....
*52383	-----	Bed.....
52384	7733	Feed Lifting Rock Shaft for 52385 and 52433.....
52385	-----	Feed Lifting Rock Shaft complete, Nos. 12376 and 52384.....
52386	7733	Feed Rock Shaft for 52387.....
52387	-----	Feed Rock Shaft complete, Nos. 29633 and 52386.....
52390	-----	Presser Foot Shank for 52427.....
52394	7735	Thread Take-up Spring for 52397.....
52397	-----	Tension complete, Nos. 2103,32572,32574, 52083,52098,52394 and two 2102.....
52407	22201	Feed Forked Connection for 52451.....
52408	7739	" Regulator with 50083C, for 52411.....
52409	7739	" Reverse Lever with 158E and 51846.....
52410	7737	" " " Hinge Screw Friction Washer.....
*52411	-----	Feed Regulator 52408 with 52073.....
52426	-----	Presser Foot Plate for 52427.....
52427	7738	Presser Foot (spring hinged) complete, Nos. 26231,52390,52426 and 62527.....
52433	-----	Feed Lifting Rock Shaft complete, Nos. 52384 and 52434, for 96-44 Machine.....
52434	22202	Feed Lifting Rock Shaft Crank with 157J and 1813, for 52433.....
52436	22203	Needle Bar Crank with 1036C,1037C and 1065C, for 96-44 Machine, obsolete.....

No.	Plate	Name
52437	-----	Presser Foot Plate for 52439.....
52438	-----	" " Shank for 52439.....
52439	7738	Presser Foot (spring hinged) complete, Nos. 7298, 26231, 52437 and 52438, for 96-44 Machine.....
52445	7738	Tension Releasing Lever for 96-44 Machine.
52446	7736	Thread Take-up Crank for 127065.....
*52447	-----	Thread Take-up complete, Nos. 11204, 52025 and 127065, for 96-44 Machine.....
52448	22203	Needle Bar Bushing (upper) for 96-44 Machine.....
52451	-----	Feed Forked Connection 52407 with 375C, 1518E and 52165.....
52452	7739	Feed Bar.....
52454	21804	Thread Retainer.....
52456	7737	Roller Arm for 52457.....
52457	22202	Roller Presser complete, 9/16 in. coarse roller, Nos. 176D, 440F, 1549J, 2205, 2206, 51824, 52456, two 316F and three 1547J..
52460	7737	Roller Arm for 52461.....
52461	22202	Roller Presser complete, 7/8 in. fine roller, Nos. 176D, 440F, 1549J, 1986, 2205, 2206, 52460, two 316F and three 1547J..
52472	-----	Rotating Hook Bobbin Case for 52481.....
52473	21808	Rotating Hook Bobbin Case complete, Nos. 592E, 2975, 40393 and 52461, for 127098.. and 127099.....
*52475	-----	Rotating Hook Bobbin Case Locating Plate for 127100.....
*52476	-----	Rotating Hook Bobbin Case Locating Plate Rivet for 127100.....
52481	-----	Rotating Hook Bobbin Case 52472 with 591F, 1380E and 40394, for 52473.....
52492	21804	Arm Shaft (upright) Bushing (lower).....
52493	21804	" " " " (upper).....
54897	21809	Rotating Hook Shaft Bushing (front) Oil Cup.....
56015	21801	Arm Oil Tube for oiling 127058, for 127214
56032	7735	Feed Regulating Stud Head with 56033.....
56033	7735	" " " " Stop Pin for 56032.....
56034	7735	Feed Regulating Stud Lock Pin.....
56035	7735	" " " " " Spring.....
56813	-----	Feed Bar Screw Center 313C with 1519J.....
56848	-----	Bell Crank 5596 with 5599 and 5601, for 5598.....
56864	7730	Chain Hook (large) for 5670.....
56865	7730	" " (small) for 5670.....

No.	Plate	Name
60456	-----	Bobbin Winder Nos. 152F, 207D, 1429D, 1550H, 41339 to 41346 and three 1430D, for 41347.....
60845	-----	Bobbin Winder Nos. 7958, 34105, 41583, 41585 to 41588, 41913, 41914 and 42614, for 41915.....
62527	21809	Presser Foot Hinge Pin for 52427.....
68350	21801	Arm Shaft (horizontal) Front Bearing Oil Cup.....
120342	21835	Oiler (copper plated) with 120343 Accessories.....
120343	21835	Oiler Spout, 3 1/2 in. long, for 120342...
120496	22202	Finger Guard for 120498.....
120497	22202	" " Holder with 50302J, for 120498
120498	22202	Finger Guard complete, Nos. 236J, 120496 and 120497.....
120857	22202	Finger Guard for 120860.....
120858	22202	" " Holder with 50302J, for 120860
120860	22202	Finger Guard complete, Nos. 120857, 120858 and two 236J.....
121446	7738	Feed Dog, 13 spiked teeth (10 teeth to the inch) for 20356 and 20357.....
125320	21808	Rotating Hook Bobbin Case Latch Lever for 40393.....
127004	21804	Rotating Hook Shaft Bushing (back) for 127043.....
127005	21804	Rotating Hook Shaft Bushing (front) for 127044.....
127007	21811	Rotating Hook Shaft Bevel Gear Case (two pieces) with 121E and 50234E.....
127043	-----	Rotating Hook Shaft Bushing (back) 127004 with 52045.....
127044	-----	Rotating Hook Shaft Bushing (front) 127005 with 52045.....
127047	7733	Arm Shaft (horizontal).....
127058	7739	" " (upright).....
127059	7733	Rotating Hook Shaft.....
127065	-----	Thread Take-up Crank 52446 with 775E and 52206, for 52447.....
127070	21811	Arm Shaft (horizontal) Bevel Gear Case (two pieces) with 121E.....
127072	21827	Arm Shaft (horizontal) Bevel Gear with two 1036C.....
127073	21827	Arm Shaft (upright) Bevel Gear (lower) with two 1259C.....
127073	21827	Rotating Hook Shaft Bevel Gear with two 1259C.....
127074	21827	Arm Shaft (upright) Bevel Gear (upper) with two 1259C.....

No.	Plate	Name
127079	21811	Arm Side Cover.....
127080	22203	" Top Cover for 52175, obsolete.....
127088	22201	Needle Bar (hollow) for 127116.....
127091	22201	Oil Tube Bracket for 127092.....
127092	22201	" " " 127091 with 127191, for oiling Feed Connecting Link.....
127095	-----	Rotating Hook with three 1253C, for 127096
127096	-----	" " 127095 with 127102 and four 1053D, for 127097 and 127119.....
127097	21808	Rotating Hook 127096 with 40274 and three 1367D (For Agents Only).....
127098	-----	Rotating Hook 127119 with 52473.....
127099	-----	" " Bobbin Case 52473 with 127100 (For Agents Only).....
127100	21808	Rotating Hook Bobbin Case Holder with 52475 and two 52476, for 127099 and 127119.....
127102	21808	Rotating Hook Thread Guard for 127096.....
127108	22202	Presser Bar Spring.....
127116	-----	Needle Bar 127088 with 229J, 52306 and 52307.....
*127119	-----	Rotating Hook 127096 with 40274, 127100 and three 1367D, for 127098.....
127146	21806	Arm Side Cap.....
127152	7739	Feed and Feed Lifting Eccentric Sleeve....
127156	22201	" Lifting Rock Shaft Connecting Rod with two 966E.....
127187	21801	Arm Oil Tube (bent) with 42367, for oiling 127152, for 52175, 127193, 150374 and 150460.....
127188	7725	Needle Bar Bushing (lower).....
127191	22201	Oil Tube with 52184, for 127092.....
127192	7739	Arm Top Cover for 127193.....
127193	7739	" " " 127192 with 12403, 52186 and 127187.....
127201	22201	Needle Bar Crank with 1036C, 1037C and 1065C.....
127202	7739	Feed and Feed Lifting Eccentric with 448C, 1299C, 52210 and 52211.....
*127214	-----	Arm with 15404 and two each 15405 and 56015.....
127222	22202	Needle Bar Crank with 1036C, 1037C and 1065C, for 96-44 Machine.....
150203	20335	Thread Unwinder Spool Rest Cushion (felt) for 225258.....
150371	22203	Bobbin Winder Tension Bracket with 460C, for 150374, obsolete.....

No.	Plate	Name
150374	-----	Bobbin Winder Tension Bracket complete, Nos. 12403, 41593 to 41595, 52186, 127187, 150371 and two 2455, for 150375, obso- lete.....
150375	-----	Bobbin Winder (swinging automatic, left hand) complete, Nos. 41915 and 150374, obsolete.....
150459	21834	Bobbin Winder Tension Bracket with 460C, for 150460.....
150460	-----	Bobbin Winder Tension Bracket complete, Nos. 12403, 41593 to 41595, 52186, 127187, 150459 and two 2455, for 150461.....
150461	-----	Bobbin Winder (swinging automatic, left hand) complete, Nos. 41915 and 150460.
200056E	3471	Bobbin Winder Stop Latch Screw for 225382.
200082D	3471	" " Tension Bracket Screw for 225382.....
200299H	3471	Bobbin Winder Stop Latch Trip Lever Hinge Screw for 225382.....
200380C	3471	Bobbin Winder Pulley Set Screw for 202473.
200383C	7729	Thread Unwinder Spool Rest Rod Set Screw for 202490.....
201018C	7729	Thread Unwinder Spool Rest Set Screw for 225257.....
201499B	3471	Bobbin Winder Tension Stud for 225461.....
201572B	3471	" " " " Thumb Nut for 225462.....
201696J	7729	Thread Unwinder Thread Guide Lock Nut for 225258.....
202277	3471	Bobbin Winder Frame Oil Packing (wick) for 225453.....
202407	3471	Bobbin Winder Tension Spring for 225462...
202473	22204	" " Pulley with 200380C, for 225382.....
202478	3471	Bobbin Winder Stop Latch Trip Lever for 225382.....
202490	20335	Thread Unwinder Spool Stand with 200383C, for 225258.....
225257	20335	Thread Unwinder Spool Rest with 201018C, for 225258.....
225258	20335	Thread Unwinder complete, Nos. 201696J, 202490, 225257, 225324, 225326, 225388, two each 150203, 225391 and three wood screws 7/8 in. No. 12.....
225322	7729	Thread Unwinder Thread Guide Rod Screw Washer for 225324.....
225324	20335	Thread Unwinder Thread Guide Rod with 208E and 225322, for 225258.....

No.	Plate	Name
225326	20335	Thread Unwinder Thread Guide Position Cup for 225258.....
225381	22204	Bobbin Winder Spindle for 225382.....
225382	22205	Bobbin Winder complete, Nos. 200056E, 200082D, 200299H, 202473, 202478, 225381, 225433, 225444, 225453 to 225456, 225458, 225462, 228026, two each 225459 and wood screws 3/4 in. No. 12 R.H.B.....
225388	20335	Thread Unwinder Spool Rest Rod for 225258.
225390	22204	" " Thread Cone Holder for inverted cones.....
225391	20335	Thread Unwinder Thread Guide for 225258...
225433	22205	Bobbin Winder and Tension Bracket Base for 225382.....
225438	3471	Bobbin Winder Frame Oil Well Cap for 225453.....
225444	3471	Bobbin Winder Stop Latch for 225382.....
225453	22204	" " Frame with 202277 and 225438 for 225382.....
225454	3471	Bobbin Frame Hinge Pin for 225382.....
225455	3471	" Winder Frame Spring for 225382.....
225456	3471	" " " " Plunger for 225382.....
225458	3471	Bobbin Winder Stop Latch Thumb Lever for 225382.....
225459	3471	Bobbin Winder Stop Latch Thumb Lever Hinge Stud for 225382.....
225459	3471	Bobbin Winder Stop Latch Thumb Lever Joint Stud for 225382.....
225461	3471	Bobbin Winder Tension Bracket with 201499B for 225462.....
225462	----	Bobbin Winder Tension Bracket complete, Nos. 201572B, 202407, 225461 and two 2102 for 225382.....
228026	----	Bobbin Winder Tension Bracket Screw Washer for 225382.....

PLATE 819—ONE-FOURTH SIZE

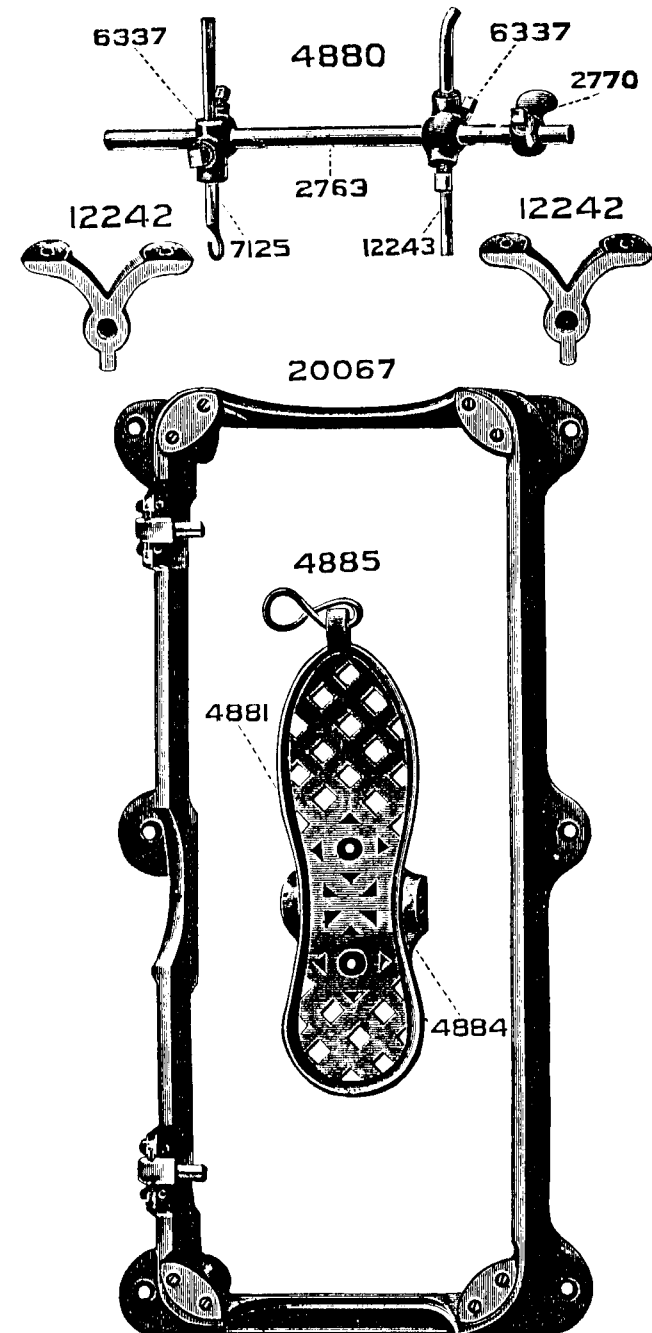


PLATE 2833--ONE-HALF SIZE

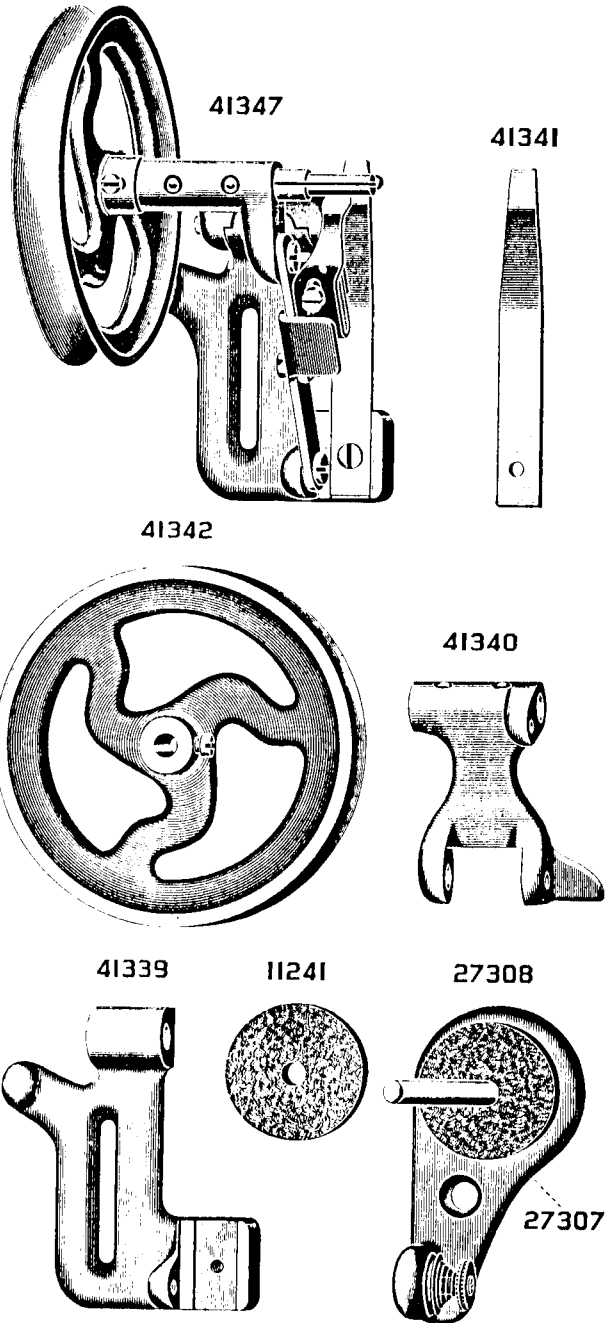


PLATE 2834--FULL SIZE

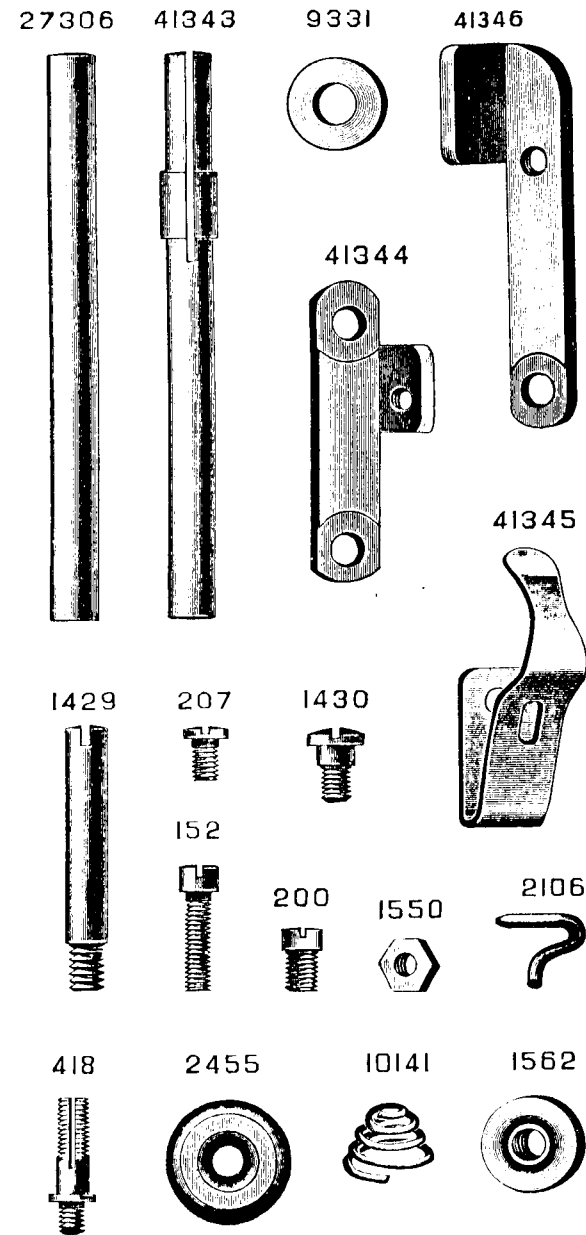


PLATE 3471—FULL SIZE

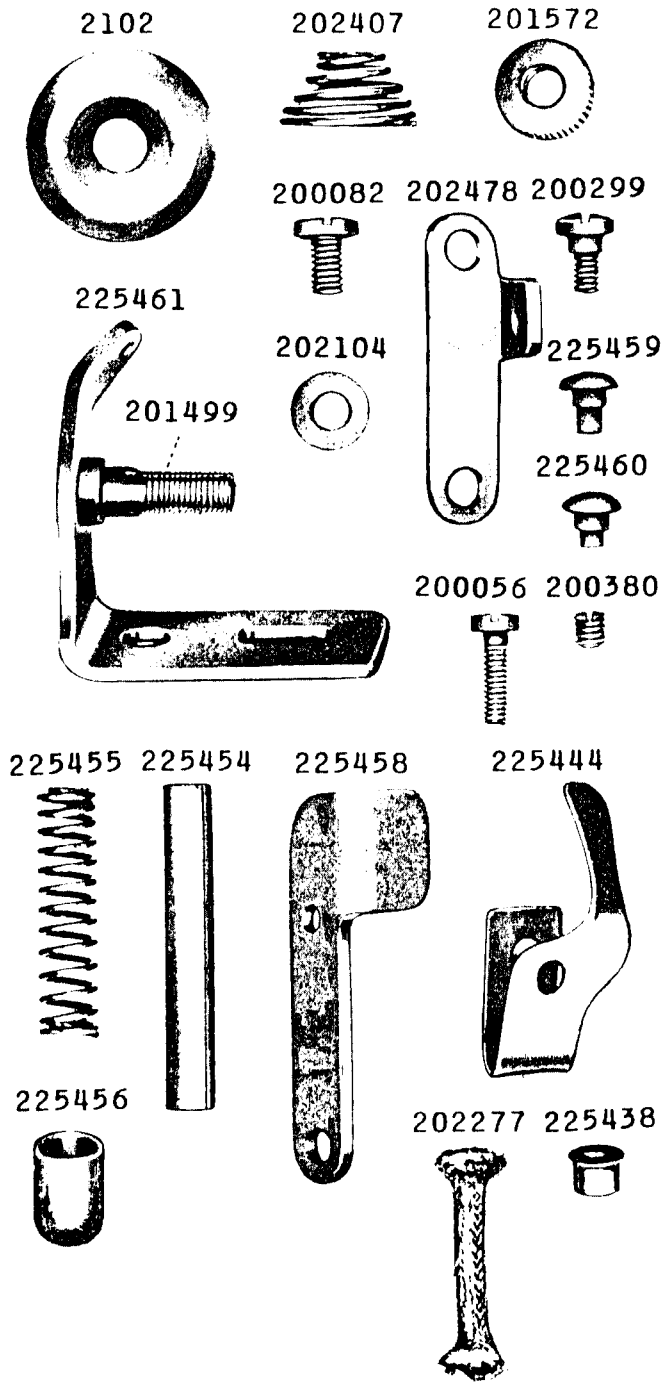


PLATE 5936—FULL SIZE

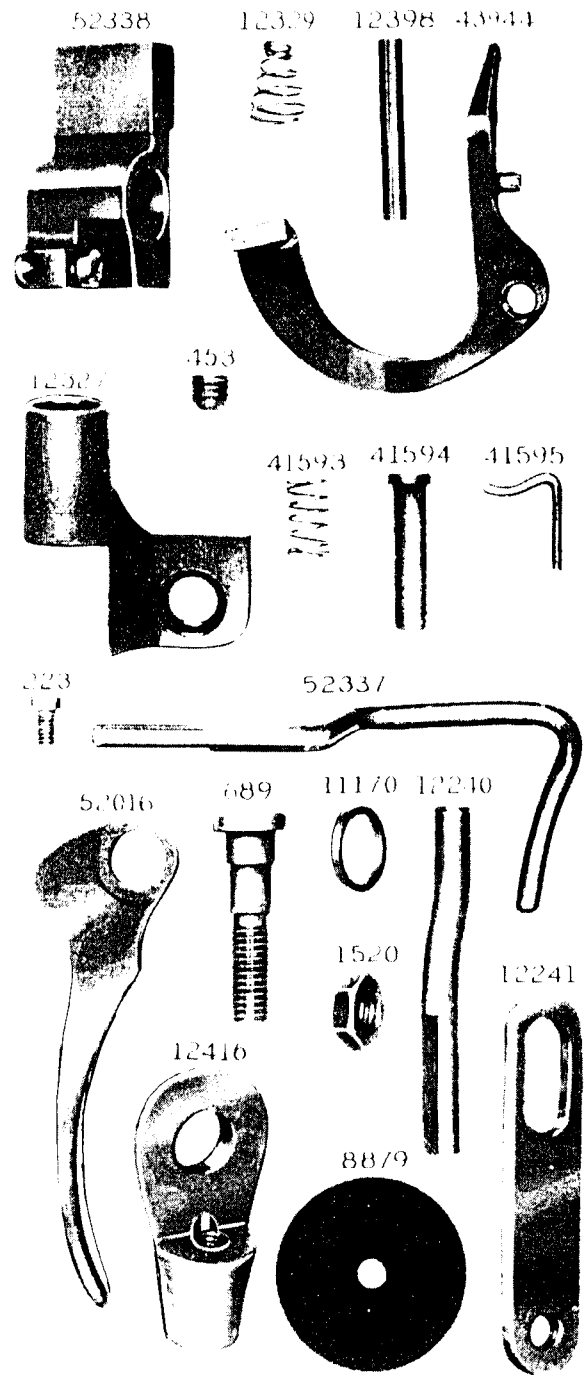


PLATE 7725—FULL SIZE

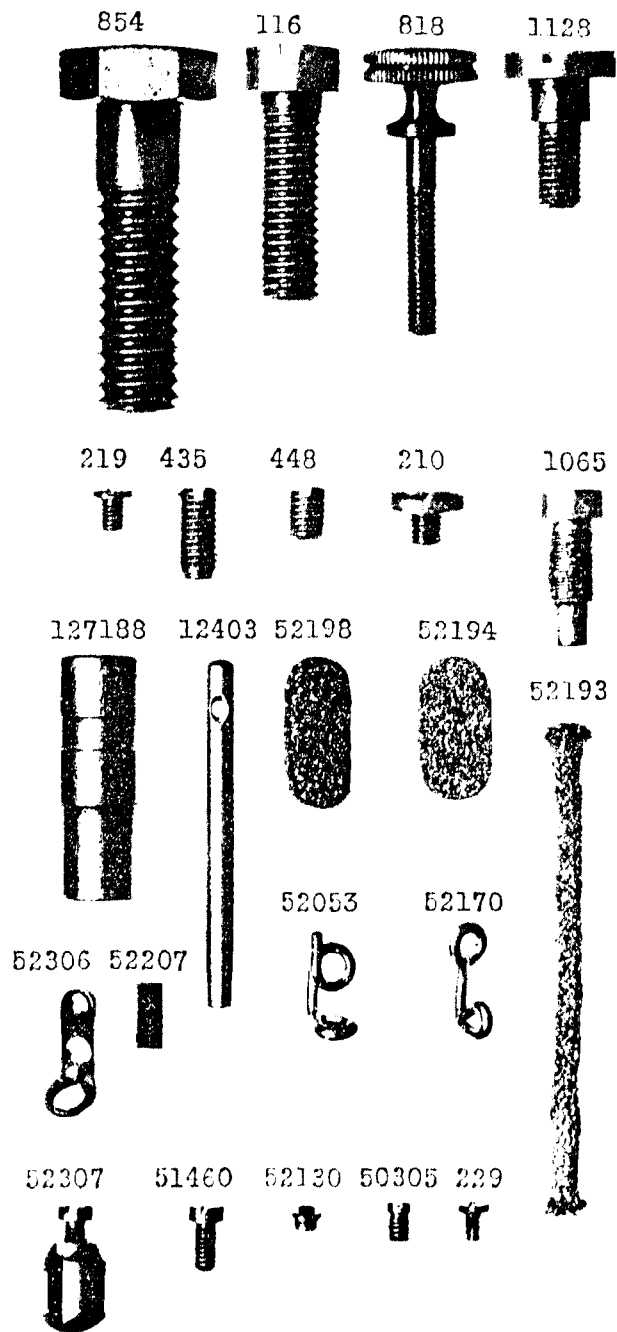


PLATE 7729—FULL SIZE

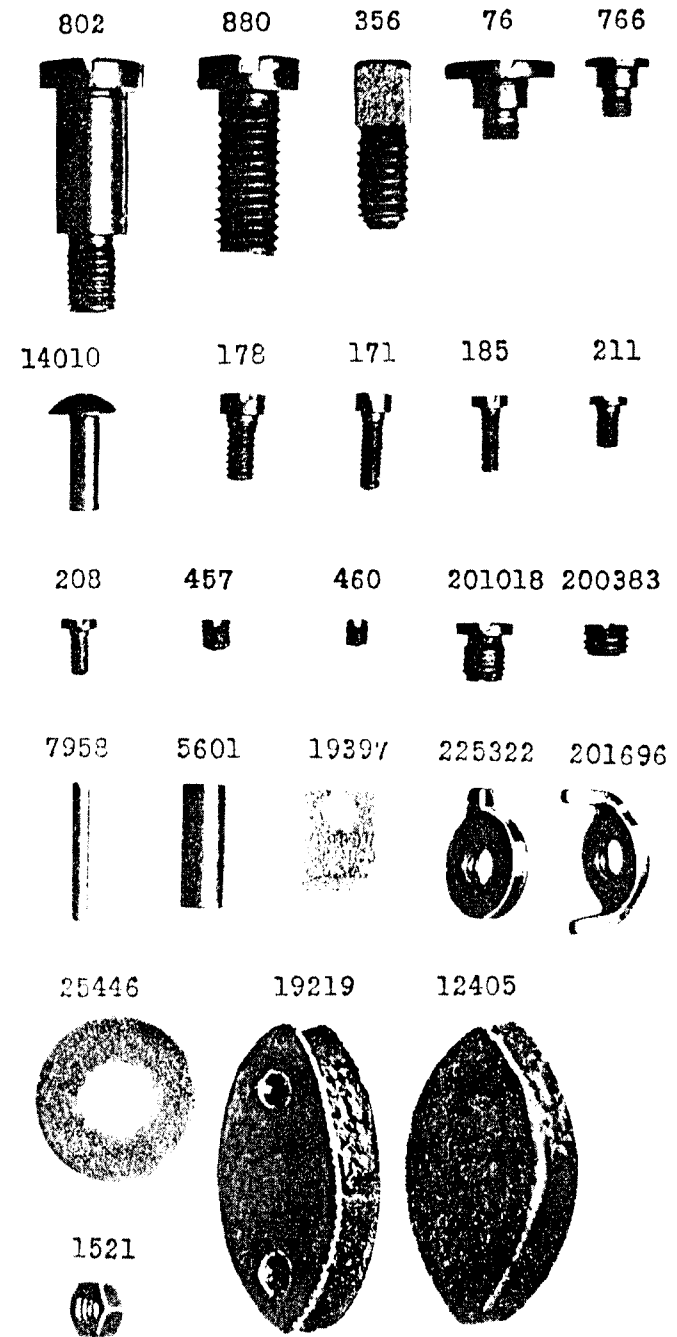
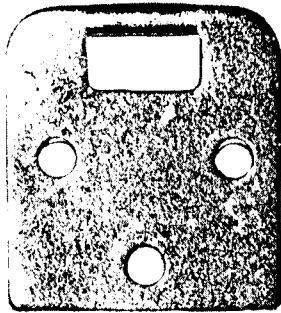
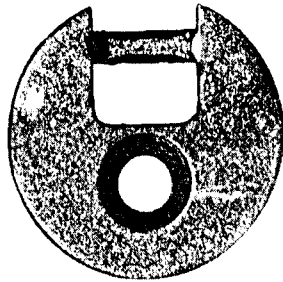


PLATE 7730—FULL SIZE

16555



44139



19220



12361



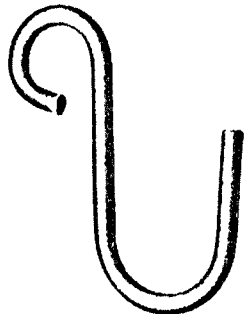
19226



56865



56864



4879



5735

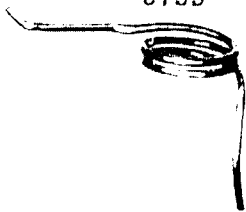
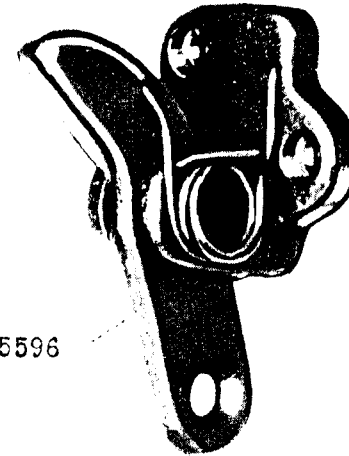


PLATE 7732—FULL SIZE

5598



5599

5596

52202



PLATE 7733--ONE-HALF SIZE

127047

52386

52384 127059

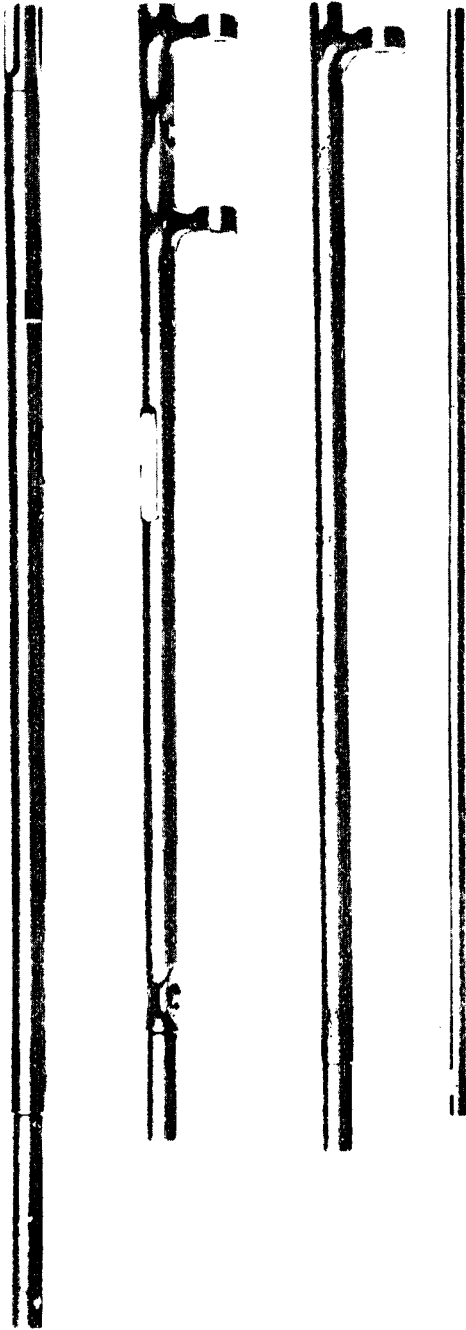


PLATE 7734--ONE-FOURTH SIZE

44212

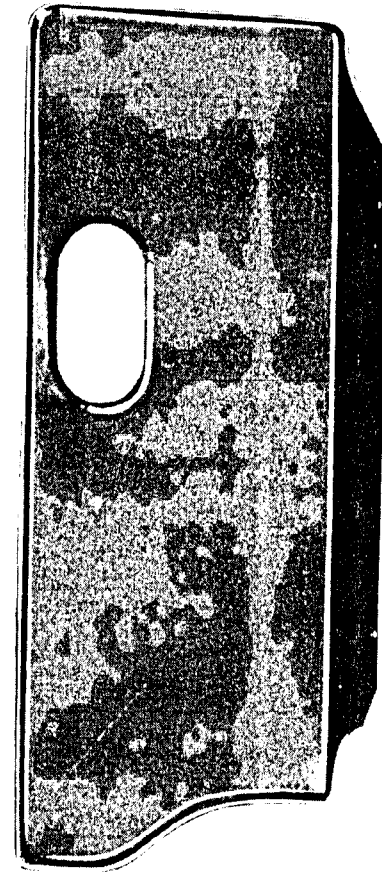
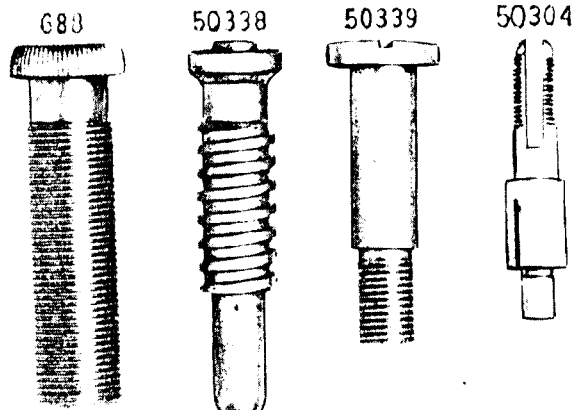
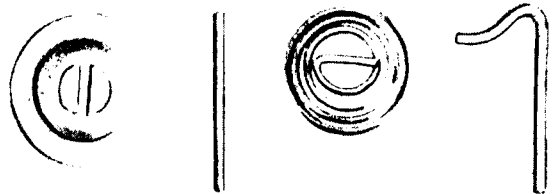


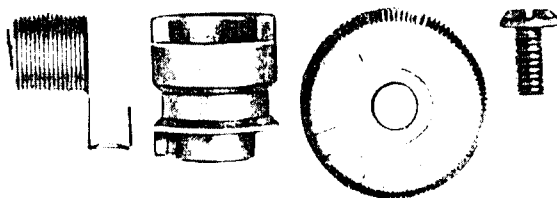
PLATE 7735—FULL SIZE



688 50338 50339 50304
32572 32574 2103 52027



52394 52083 56032 50193



56034 56035 56033 1811 794

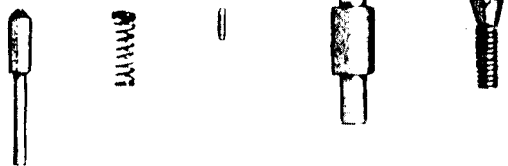
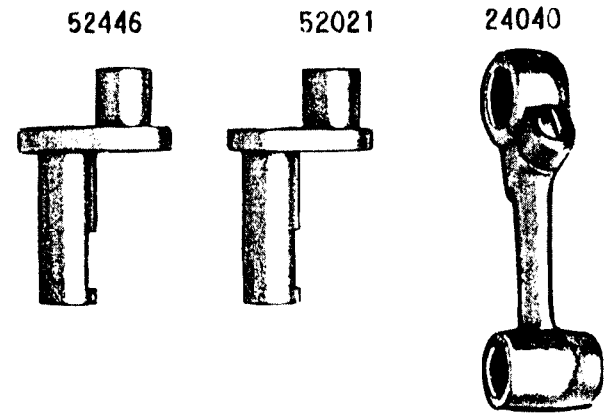
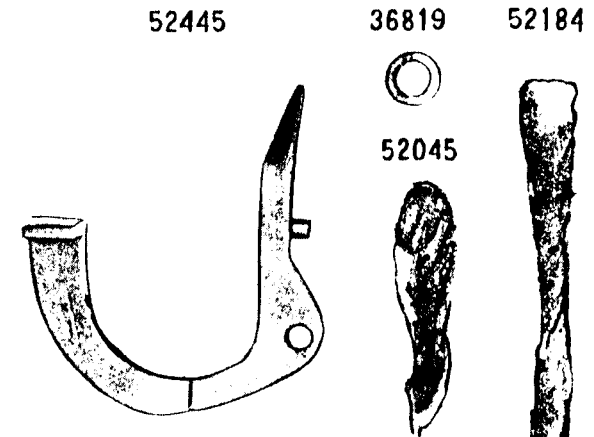


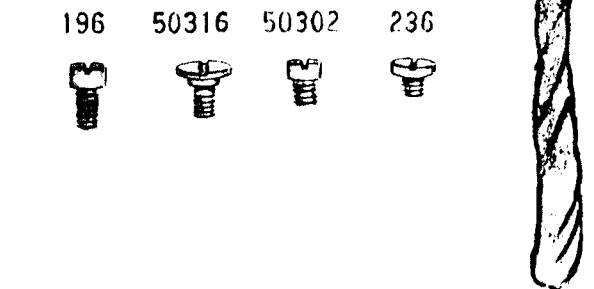
PLATE 7736—FULL SIZE



52446 52021 24040



52445 36819 52184



196 50316 50302 236

PLATE 7737—FULL SIZE

51824



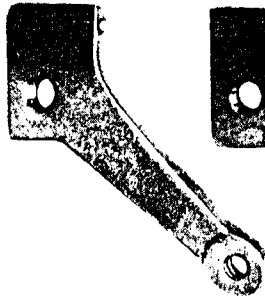
1986



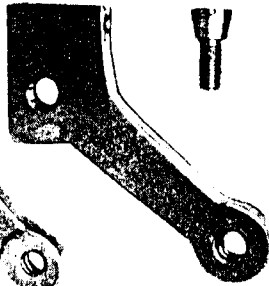
2205



52456



52400



369



50231



2206



652



51846



52410



316



440



1528



1547

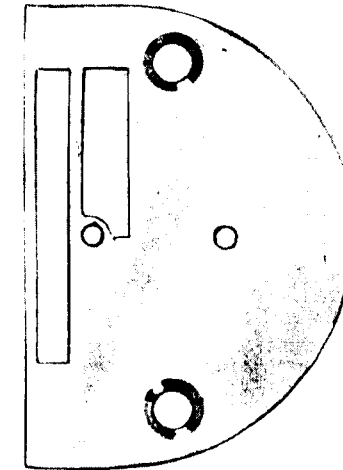


1549



PLATE 7738—FULL SIZE

20356



121446



691



7298



26231



52427



52439

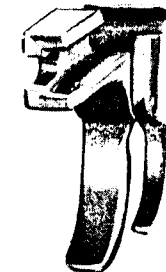


PLATE 7739—ONE-HALF SIZE

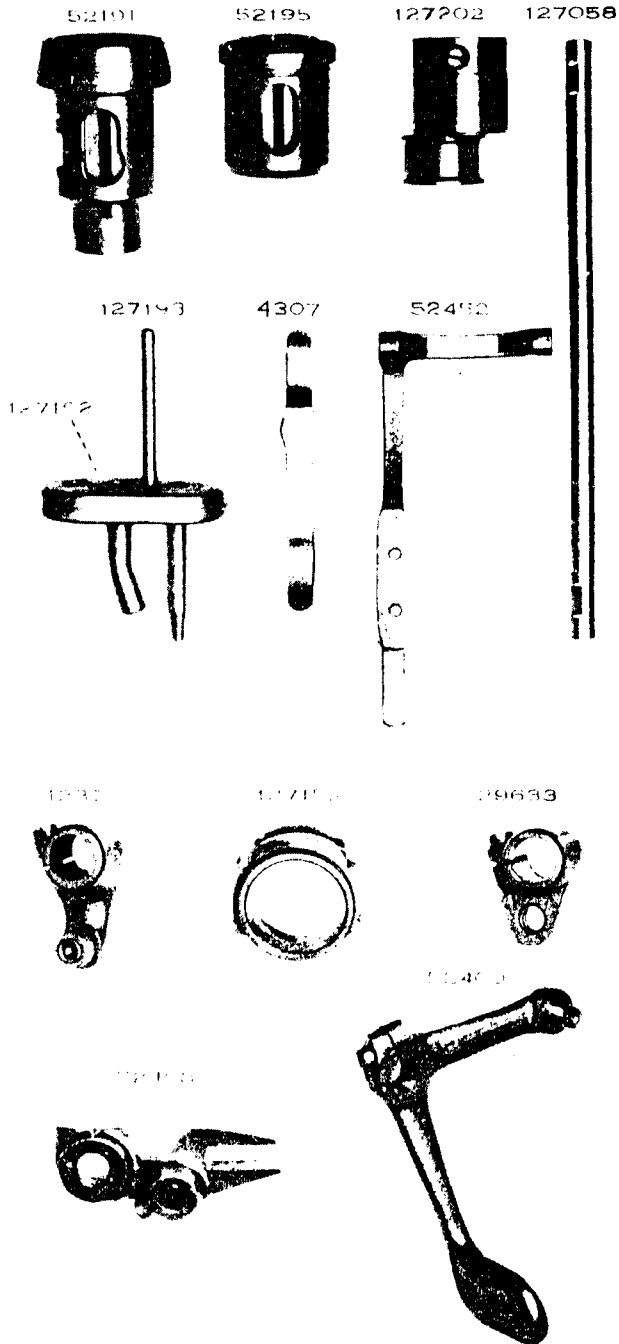


PLATE 20335—ONE-SIXTH SIZE

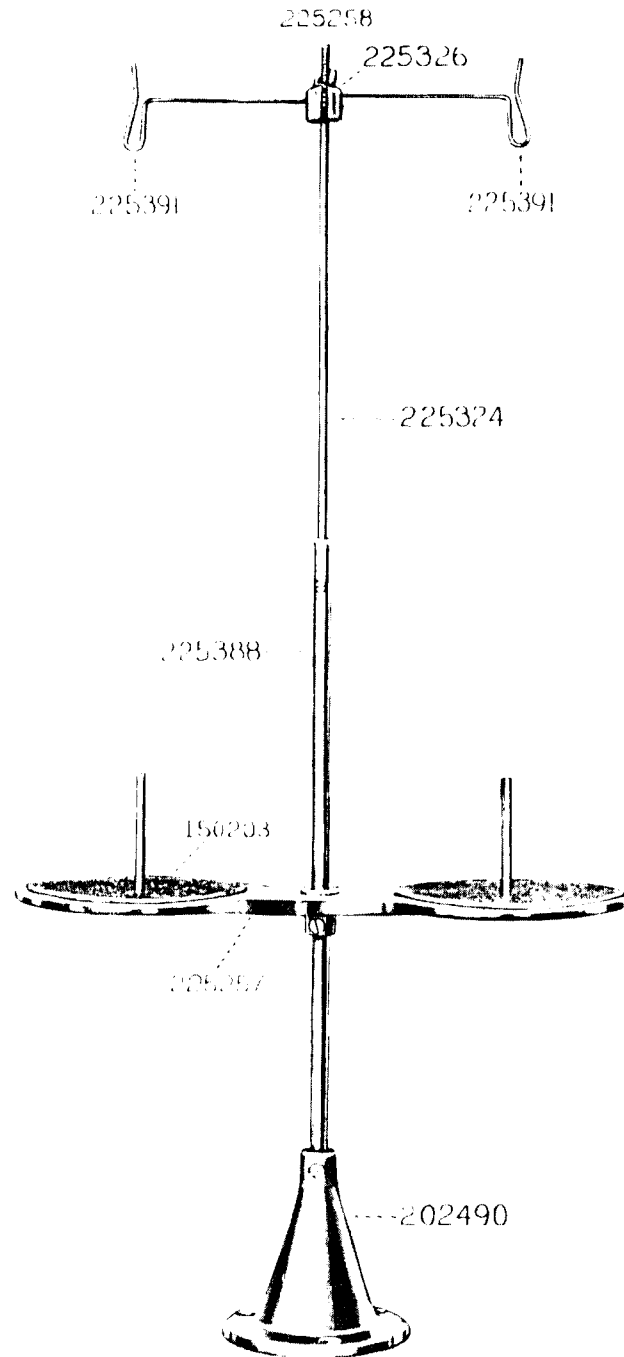
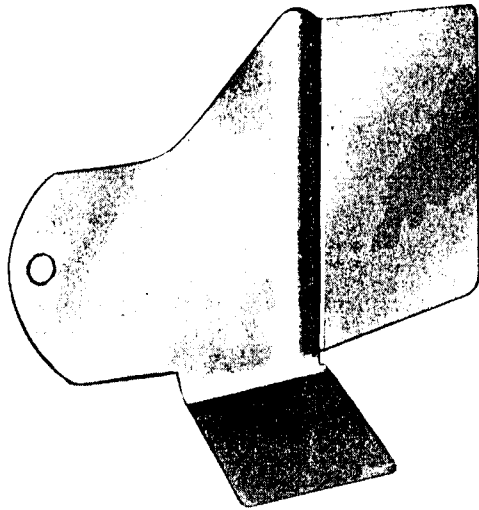


PLATE 21806--FULL SIZE

127146



12432

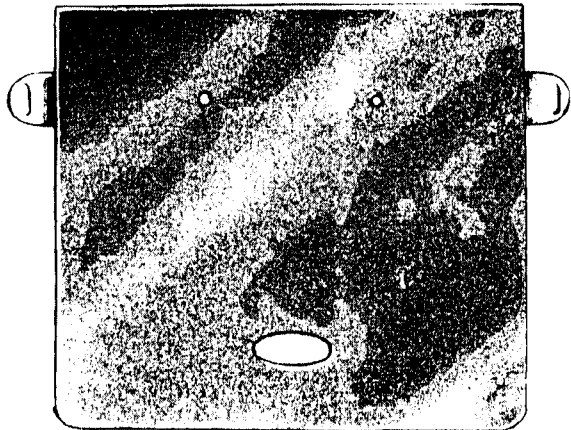
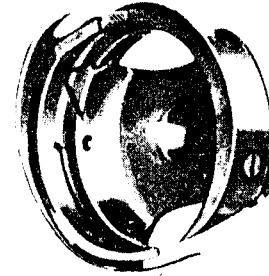
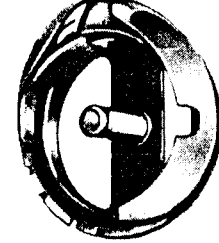


PLATE 21808--FULL SIZE

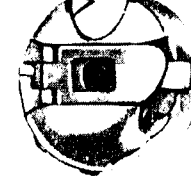
127097



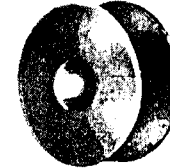
127100



52473



40264



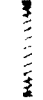
40274



40392



2975



125320



127102



40394



52018



591



592



1380



2974



1367



PLATE 21809—FULL SIZE

1148 1143 176 775 1253



432 1299 1036 1037 1259



857 226 624 1133 1053



52023 1519 1560 62527 704

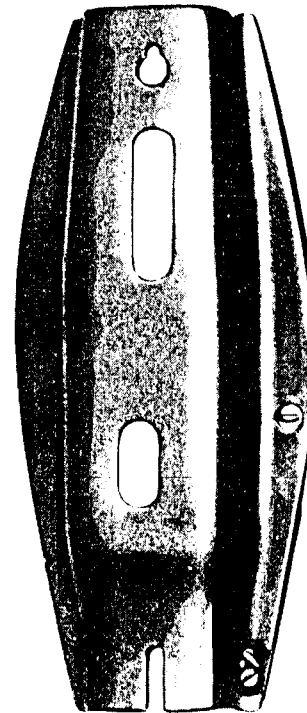


54897

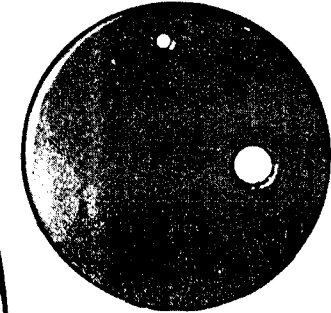


PLATE 21811—ONE-HALF SIZE

52052



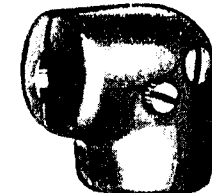
127079



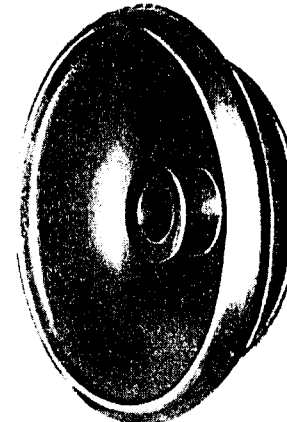
127070



127007



52187



52063

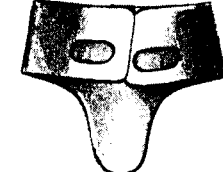


PLATE 21827 FULL SIZE

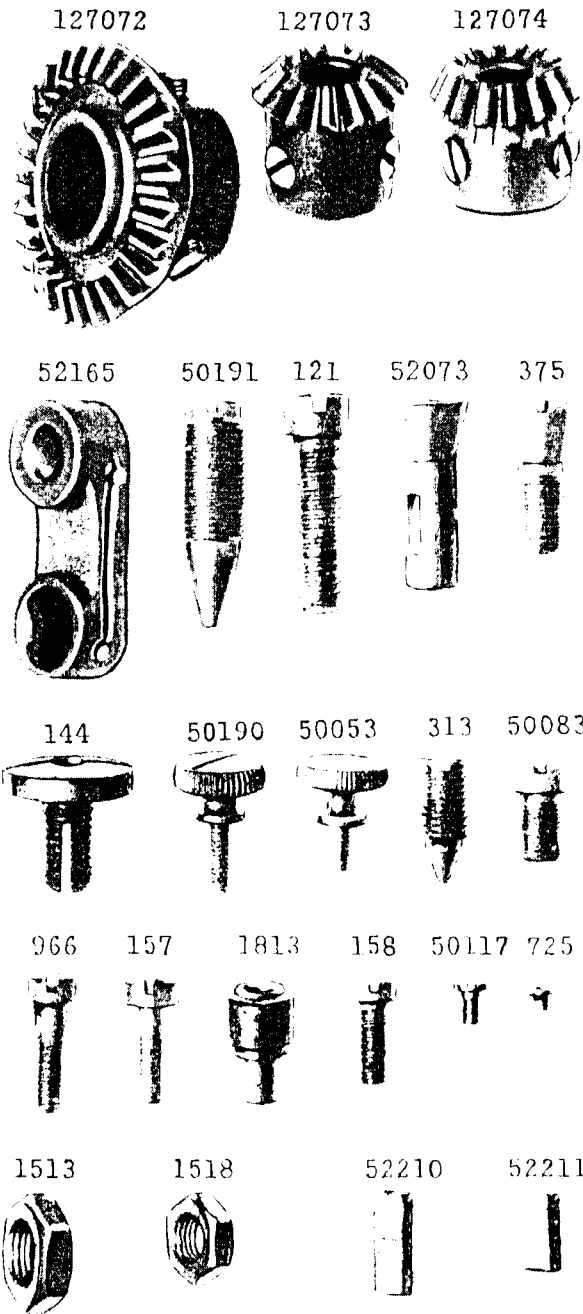


PLATE 21834-ONE-HALF SIZE

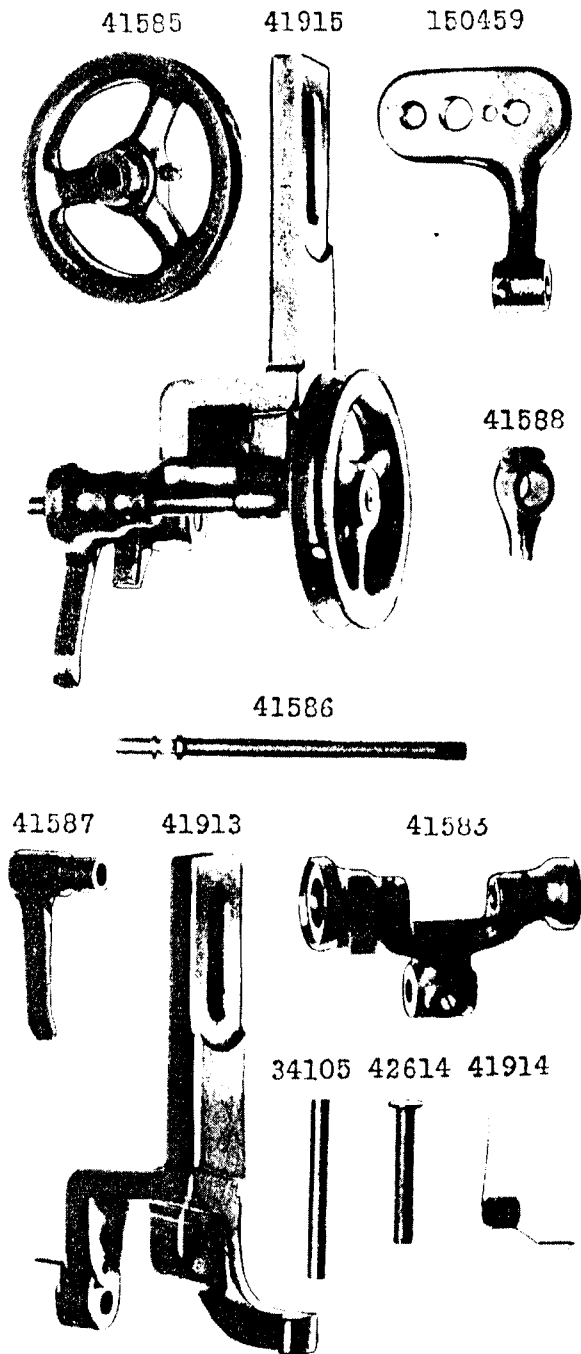
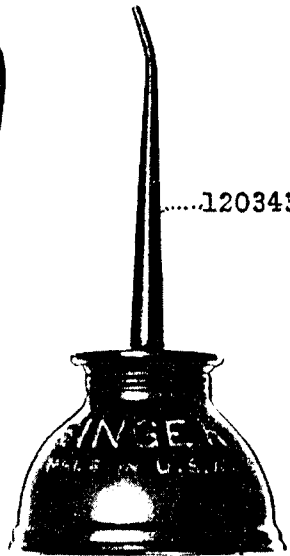


PLATE 21835—ONE-HALF SIZE

26026



120342

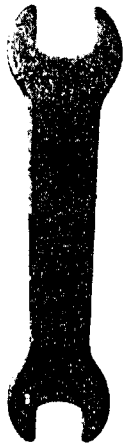


.....120343

26485



8909



8908

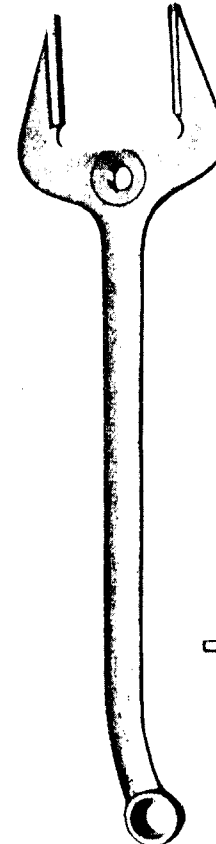


PLATE 22201 - ONE-HALF SIZE

127156



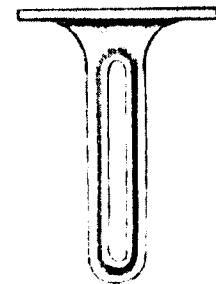
52407



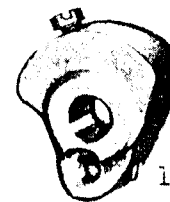
127088 52014



25866



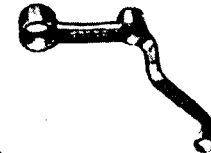
127201



127092



52022

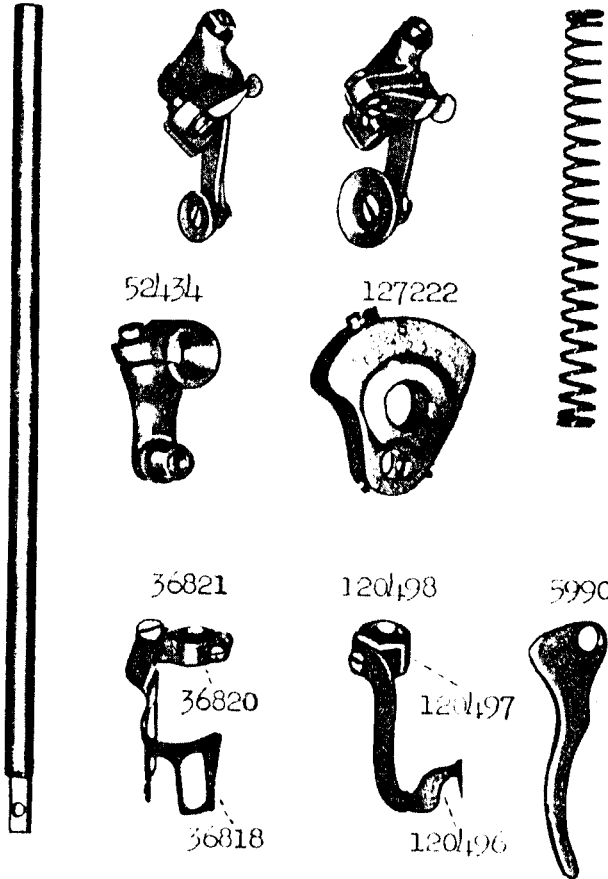


127091

127191

PLATE 22202 - ONE-HALF SIZE

12571 52457 52461 127108



111400 4882 4883 120460

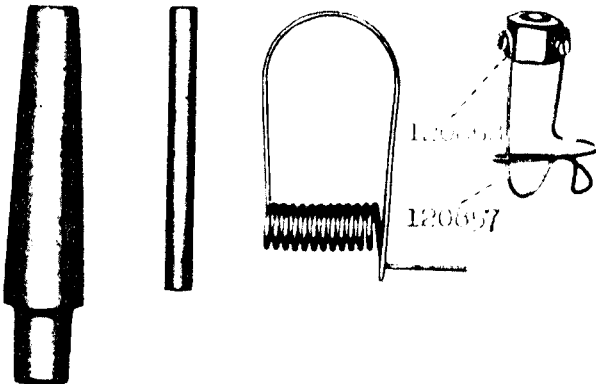


PLATE 22203 - ONE-HALF SIZE

127077 52032 52448 52175

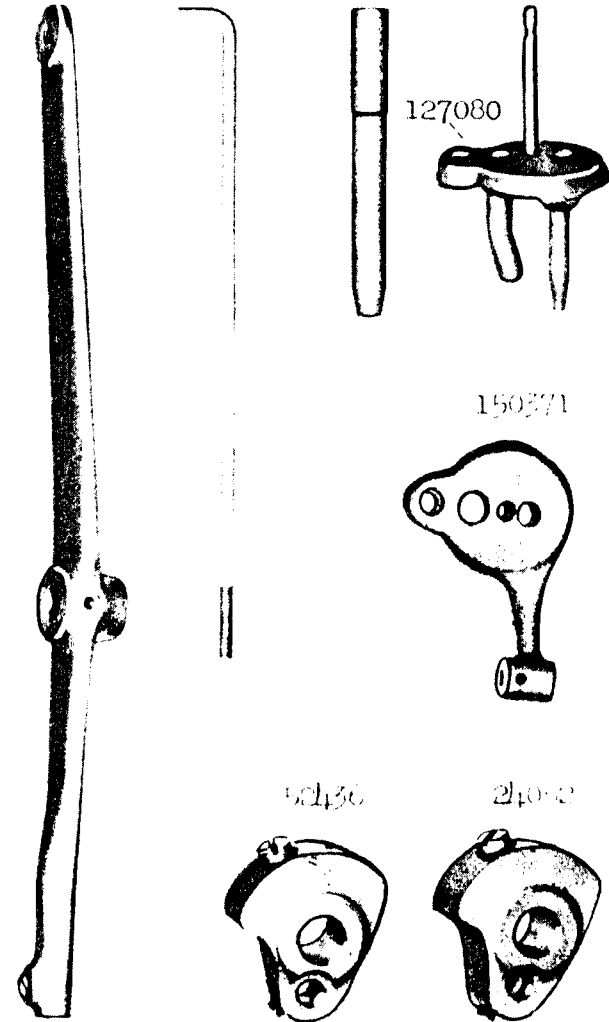


PLATE 22204-ONE-HALF SIZE

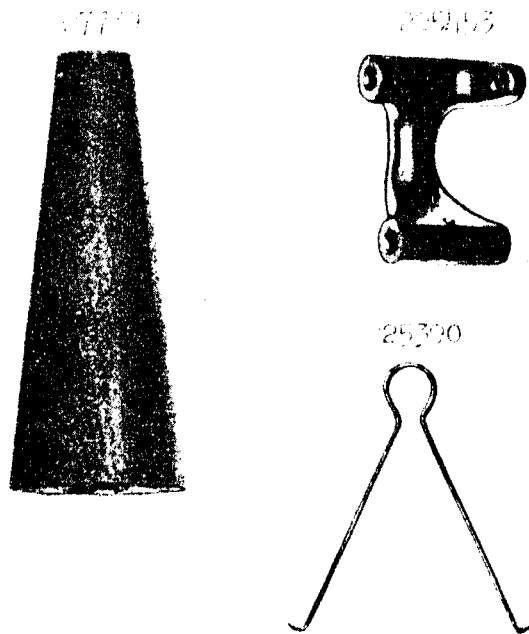
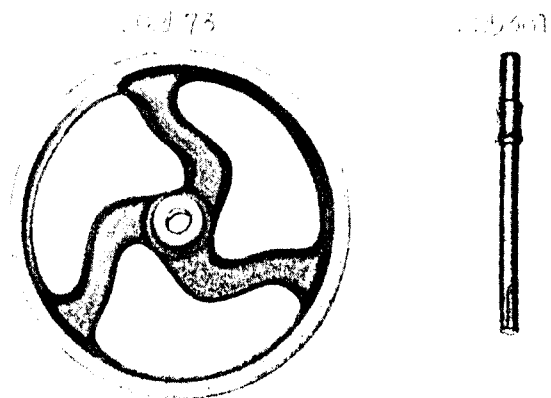
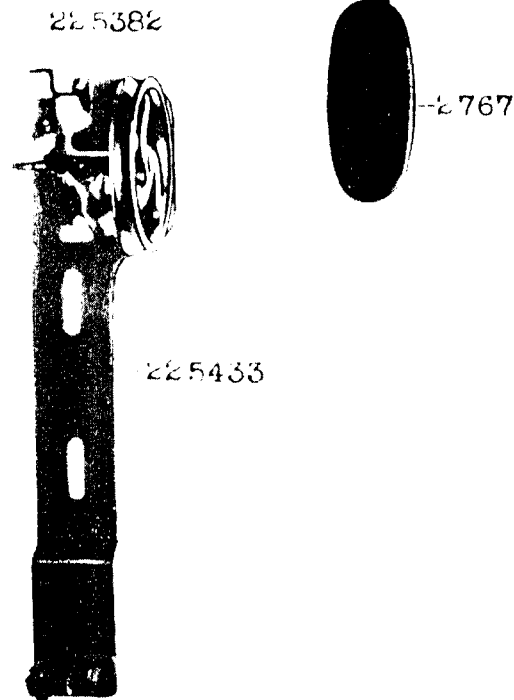
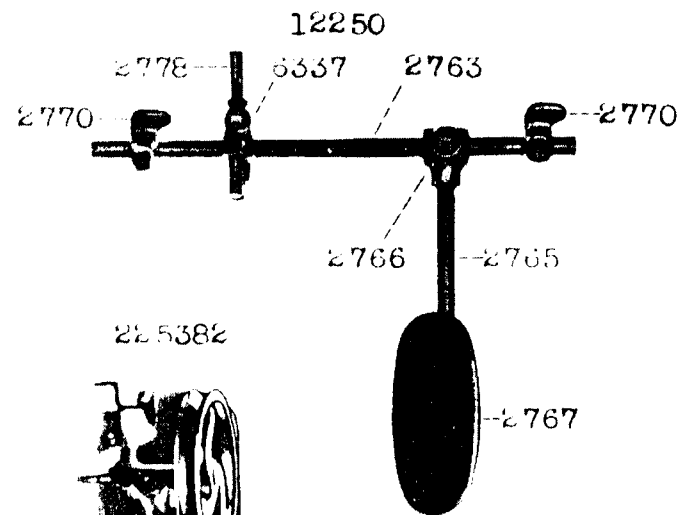


PLATE 22205-ONE-FOURTH SIZE



Free Manuals Download Website

<http://myh66.com>

<http://usermanuals.us>

<http://www.somanuals.com>

<http://www.4manuals.cc>

<http://www.manual-lib.com>

<http://www.404manual.com>

<http://www.luxmanual.com>

<http://aubethermostatmanual.com>

Golf course search by state

<http://golfingnear.com>

Email search by domain

<http://emailbydomain.com>

Auto manuals search

<http://auto.somanuals.com>

TV manuals search

<http://tv.somanuals.com>