

SHARP

MINI COMPONENT SYSTEM

MODEL

CD-G10000

SPEAKER SYSTEM

MODEL

CP-G10000S

OPERATION MANUAL

Thank you for purchasing this SHARP product.
To obtain the best performance from this product, please read this manual carefully. It will guide you in operating your SHARP product.

CD-G10000

CD-G10000 Mini Component System consisting of CD-G10000 (main unit) and GBOXSA090AWM1 (rear speaker system).

CP-G10000S

CP-G10000S Speaker System consisting of CP-G10000S (front speaker system) and CP-SW10000S (active subwoofer).

COMPACT
disc
DIGITAL AUDIO

MP3

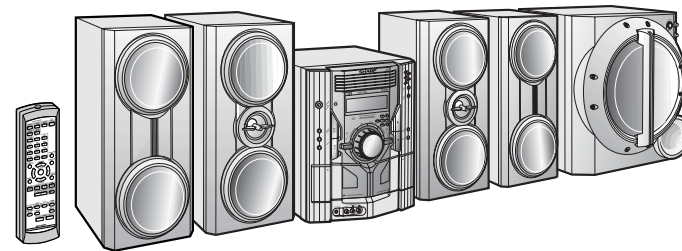



CD-R/RW
Playable

5CD CHANGER

Active
Subwoofer System

Accessories

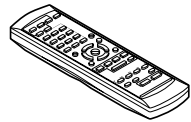
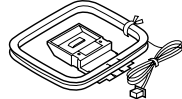
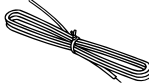
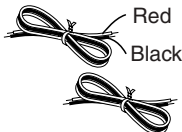
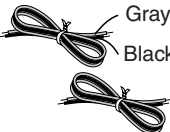
Please confirm that the following accessories are included.

 Remote control × 1 (RRMCG0395AWSA)	 AM loop antenna × 1 (QANTL0005AWZZ)	 FM antenna × 1 (92LFANT1746A)
 Wire for front speaker × 2 (QCNWHA003AWZZ)	 Wire for rear speaker × 2 (QCNWHA004AWZZ)	 Subwoofer cable × 1 (QCNWGA003AWPZ)

Note:

Only the above accessories are included.

SPECIAL NOTES

Important Instruction



CAUTION
 RISK OF ELECTRIC SHOCK
 DO NOT OPEN



CAUTION: TO REDUCE THE RISK OF ELECTRIC SHOCK, DO NOT REMOVE COVER (OR BACK). NO USER-SERVICEABLE PARTS INSIDE. REFER SERVICING TO QUALIFIED SERVICE PERSONNEL.

Explanation of Graphical Symbols:



The lightning flash with arrowhead symbol, within an equilateral triangle, is intended to alert the user to the presence of uninsulated "dangerous voltage" within the product's enclosure that may be of sufficient magnitude to constitute a risk of electric shock to persons.



The exclamation point within an equilateral triangle is intended to alert the user to the presence of important operating and maintenance (servicing) instructions in the literature accompanying the appliance.

WARNING: TO REDUCE THE RISK OF FIRE OR ELECTRIC SHOCK, DO NOT EXPOSE THIS APPLIANCE TO RAIN OR MOISTURE.

Caution - use of controls or adjustments or performance of procedures other than those specified herein may result in hazardous radiation exposure.

NOTE
 This equipment has been tested and found to comply with the limits for a Class B digital device, pursuant to Part 15 of the FCC Rules. These limits are designed to provide reasonable protection against harmful interference in a residential installation. This equipment generates, uses, and can radiate radio frequency energy and, if not installed and used in accordance with the instructions, may cause harmful interference to radio communications. However, there is no guarantee that interference will not occur in a particular installation. If this equipment does cause harmful interference to radio or television reception, which can be determined by turning the equipment off and on, the user is encouraged to try to correct the interference by one or more of the following measures:

- Reorient or relocate the receiving antenna.
- Increase the separation between the equipment and receiver.
- Connect the equipment into an outlet on a circuit different from that to which the receiver is connected.
- Consult the dealer or an experienced radio/TV technician for help.

WARNING
 FCC Regulations state that any unauthorized changes or modifications to this equipment not expressly approved by the manufacturer could void the user's authority to operate this equipment.

NOTES

- It is the intent of Sharp that this product be used in full compliance with the copyright laws of the United States and that prior permission be obtained from copyright owners whenever necessary.
- Licensed under one or more of U.S. Pat. 4,972,484, 5,214,678, 5,323,396, 5,530,655, 5,539,829, 5,544,247, 5,606,618, 5,610,985, 5,740,317, 5,777,992, 5,878,080 or 5,960,037.

FOR YOUR RECORDS

For your assistance in reporting this unit in case of loss or theft, please record below the model number and serial number which are located on the rear of the unit. Please retain this information.

Model number

Serial number

Date of purchase

Place of purchase

IMPORTANT SAFETY INSTRUCTIONS

CD-G10000
CP-G10000S

- 1 Read Instructions** - All the safety and operating instructions should be read before the product is operated.
- 2 Retain Instructions** - The safety and operating instructions should be retained for future reference.
- 3 Heed Warnings** - All warnings on the product and in the operating instructions should be adhered to.
- 4 Follow Instructions** - All operating and use instructions should be followed.
- 5 Cleaning** - Unplug this product from the wall outlet before cleaning. Do not use liquid cleaners or aerosol cleaners. Use a damp cloth for cleaning.
- 6 Attachments** - Do not use attachments not recommended by the product manufacturer as they may cause hazards.
- 7 Water and Moisture** - Do not use this product near water - for example, near a bath tub, wash bowl, kitchen sink, or laundry tub; in a wet basement; or near a swimming pool; and the like.
- 8 Accessories** - Do not place this product on an unstable cart, stand, tripod, bracket, or table. The product may fall, causing serious injury to a child or adult, and serious damage to the product. Use only with a cart, stand, tripod, bracket, or table recommended by the manufacturer, or sold with the product. Any mounting of the product should follow the manufacturer's instructions, and should use a mounting accessory recommended by the manufacturer.
- 9** A product and cart combination should be moved with care. Quick stops, excessive force, and uneven surfaces may cause the product and cart combination to overturn.



- 10 Ventilation** - Slots and openings in the cabinet are provided for ventilation and to ensure reliable operation of the product and to protect it from overheating, and these openings must not be blocked or covered. The openings should never be blocked by placing the product on a bed, sofa, rug, or other similar surface. This product should not be placed in a built-in installation such as a bookcase or rack unless proper ventilation is provided or the manufacturer's instructions have been adhered to.
- 11 Power Sources** - This product should be operated only from the type of power source indicated on the marking label. If you are not sure of the type of power supply to your home, consult your product dealer or local power company. For products intended to operate from battery power, or other sources, refer to the operating instructions.
- 12 Grounding or Polarization** - This product may be equipped with a polarized alternating-current line plug (a plug having one blade wider than the other). This plug will fit into the power outlet only one way. This is a safety feature. If you are unable to insert the plug fully into the outlet, try reversing the plug. If the plug should still fail to fit, contact your electrician to replace your obsolete outlet. Do not defeat the safety purpose of the polarized plug.
Alternate Warnings - This product is equipped with a three-wire grounding-type plug, a plug having a third (grounding) pin. This plug will only fit into a grounding-type power outlet. This is a safety feature. If you are unable to insert the plug into the outlet, contact your electrician to replace your obsolete outlet. Do not defeat the safety purpose of the grounding-type plug.
- 13 Power-Cord Protection** - Power-supply cords should be routed so that they are not likely to be walked on or pinched by items placed upon or against them, paying particular attention to cords at plugs, convenience receptacles, and the point where they exit from the product.
- 14 Protective Attachment Plug** - The product is equipped with an attachment plug having overload protection. This is a safety feature. See Instruction Manual for replacement or resetting of protective device. If replacement of the plug is required, be sure the service technician has used a replacement plug specified by the manufacturer that has the same overload protection as the original plug.

Important Instruction

IMPORTANT SAFETY INSTRUCTIONS (continued)

15 Outdoor Antenna Grounding - If an outside antenna or cable system is connected to the product, be sure the antenna or cable system is grounded so as to provide some protection against voltage surges and built-up static charges. Article 810 of the National Electrical Code, ANSI/NFPA 70, provides information with regard to proper grounding of the mast and supporting structure, grounding of the lead-in wire to an antenna discharge unit, size of grounding conductors, location of antenna discharge unit, connection to grounding electrodes, and requirements for the grounding electrode.

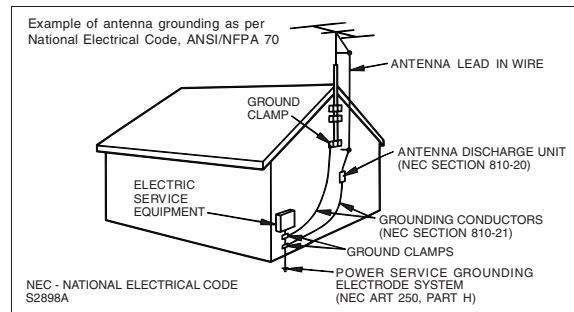

16 Lightning - For added protection for this product during a lightning storm, or when it is left unattended and unused for long periods of time, unplug it from the wall outlet and disconnect the antenna or cable system. This will prevent damage to the product due to lightning and power-line surges.

17 Power Lines - An outside antenna system should not be located in the vicinity of overhead power lines or other electric light or power circuits, or where it can fall into such power lines or circuits. When installing an outside antenna system, extreme care should be taken to keep from touching such power lines or circuits as contact with them might be fatal.

18 Overloading - Do not overload wall outlets, extension cords, or integral convenience receptacles as this can result in a risk of fire or electric shock.

19 Object and Liquid Entry - Never push objects of any kind into this product through openings as they may touch dangerous voltage points or short-out parts that could result in a fire or electric shock. Never spill liquid of any kind on the product.

20 Servicing - Do not attempt to service this product yourself as opening or removing covers may expose you to dangerous voltage or other hazards. Refer all servicing to qualified service personnel.

21 Damage Requiring Service - Unplug this product from the wall outlet and refer servicing to qualified service personnel under the following conditions:

- a) When the power-supply cord or plug is damaged,
- b) If liquid has been spilled, or objects have fallen into the product,
- c) If the product has been exposed to rain or water,
- d) If the product does not operate normally by following the operating instructions. Adjust only those controls that are covered by the operating instructions as an improper adjustment of other controls may result in damage and will often require extensive work by a qualified technician to restore the product to its normal operation,
- e) If the product has been dropped or damaged in any way, and
- f) When the product exhibits a distinct change in performance - this indicates a need for service.

22 Replacement Parts - When replacement parts are required, be sure the service technician has used replacement parts specified by the manufacturer or have the same characteristics as the original part. Unauthorized substitutions may result in fire, electric shock, or other hazards.

23 Safety Check - Upon completion of any service or repairs to this product, ask the service technician to perform safety checks to determine that the product is in proper operating condition.

24 Wall or Ceiling Mounting - The product should be mounted to a wall or ceiling only as recommended by the manufacturer.

25 Heat - The product should be situated away from heat sources such as radiators, heat registers, stoves, or other products (including amplifiers) that produce heat.

ENERGY STAR® Program Information



Products that have earned the ENERGY STAR® are designed to protect the environment through superior energy efficiency.

To comply with the ENERGY STAR® standards mentioned above, please cancel the demonstration mode, as described on page 15.

ENERGY STAR® is a U.S. registered mark.

Contents

	Page
> General Information	
Precautions	6
Controls and indicators	7 - 10
> Preparation for Use	
System connections	11 - 15
Remote control	16
Subwoofer control	17
> Basic Operation	
General control	18
Setting the clock	19
> CD or MP3 disc Playback	
Listening to a CD or MP3 disc	20 - 22
Advanced CD or MP3 disc playback	23 - 25
MP3 navigation (only for MP3 files)	26 - 29
> Radio	
Listening to the radio	30, 31
> Tape Playback	
Listening to a cassette tape (TAPE 1 or TAPE 2)	32, 33
> Tape Recording	
Recording on a cassette tape	33 - 35
> Advanced Features	
Timer and sleep operation	36 - 39
Enhancing your system	40, 41
> References	
Troubleshooting chart	41 - 43
Maintenance	44
Specifications	45, 46
CONSUMER LIMITED WARRANTY	Back cover

Precautions

> General

- Please ensure that the system is positioned in a well-ventilated area and ensure that there is at least 4" (10 cm) of free space along the sides, top and back of the unit.

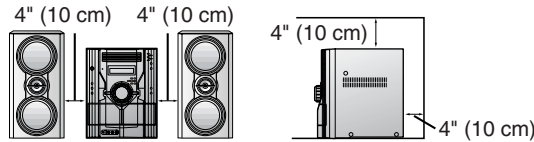

- **Do not place active subwoofer system on the same surface as main unit to prevent sound interruption during playback.**

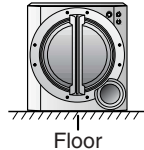

- Use the unit on a firm, level surface free from vibration.

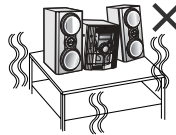

- Keep the unit away from direct sunlight, strong magnetic fields, excessive dust, humidity and electronic/electrical equipment (home computers, facsimiles, etc.) which generate electrical noise.



- Do not place anything on top of the unit and subwoofer.
- Do not expose the system to moisture, to temperatures higher than 140°F (60°C) or to extremely low temperatures.
- If your system does not work properly, disconnect the AC power cord from the AC outlet. Plug the AC power cord back in, and then turn on your system.

- In case of an electrical storm, unplug the system for safety.

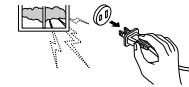

- Hold the AC power plug by the head when removing it from the AC outlet, as pulling the cord can damage internal wires.

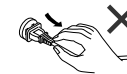

- **Do not remove the outer cover, as this may result in electric shock. Refer internal service to your local SHARP service facility.**

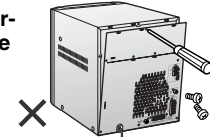

- This system should only be used within the range of 41°F - 95°F (5°C - 35°C).

Warning:

The voltage used must be the same as that specified on this unit. Using this product with a higher voltage other than that which is specified is dangerous and may result in a fire or other type of accident causing damage. SHARP will not be held responsible for any damage resulting from use of this unit with a voltage other than that which is specified.

> Volume control

The sound level at a given volume setting depends on speaker efficiency, location and various other factors. It is advisable to avoid exposure to high volume levels, which occurs while turning the unit on with the volume control setting up high, or while continually listening at high volumes.

Controls and indicators

CD-G10000
CP-G10000S

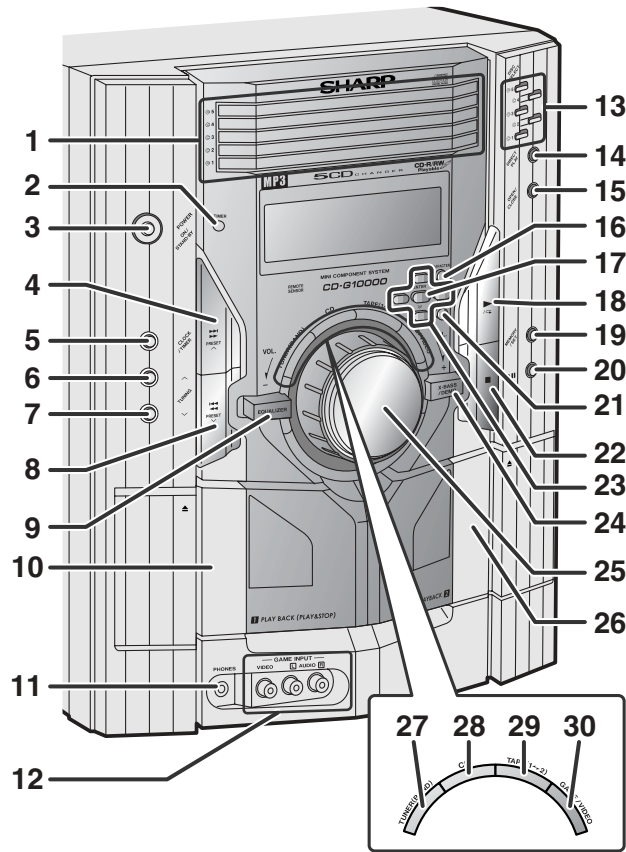

Front panel

	Reference page
1. Disc Trays	21
2. Timer Indicator	37
3. Power On/Stand-by Button	18
4. Disc Track Up or Fast Forward, Tape 2 Fast Forward, Tuner Preset Up, Time Up Button	19, 22, 31, 33
5. Clock/Timer Button	19, 36, 39
6. Tuning Up Button	30
7. Tuning Down Button	30
8. Disc Track Down or Fast Reverse, Tape 2 Rewind, Tuner Preset Down, Time Down Button	19, 22, 31, 33
9. Equalizer Mode Select Button	18
10. Tape 1 Cassette Compartment	32
11. Headphone Jack	41
12. Game/Video Input Jacks	40
13. Disc Number Select Buttons	21
14. Disc Direct Play Button	23
15. Disc Tray Open/Close Button	21
16. Character Button	28
17. Enter Button	27
18. Disc Play or Repeat, Tape Play Button	21, 24, 32
19. Memory/Set Button	19, 25, 29, 31, 36, 39
20. Tape 2 Record Pause Button	34, 35
21. MP3 Disc Navigation Mode Select Button	27
22. Disc or Tape Stop Button	22, 33
23. Cursor Buttons	27
24. Extra Bass/Demo Mode Button	15, 18
25. Volume Control	18
26. Tape 2 Cassette Compartment	32
27. Tuner (Band) Button	30
28. CD Button	21
29. Tape (1 - 2) Button	32
30. Game/Video Button	40

General Information

Controls and indicators (continued)

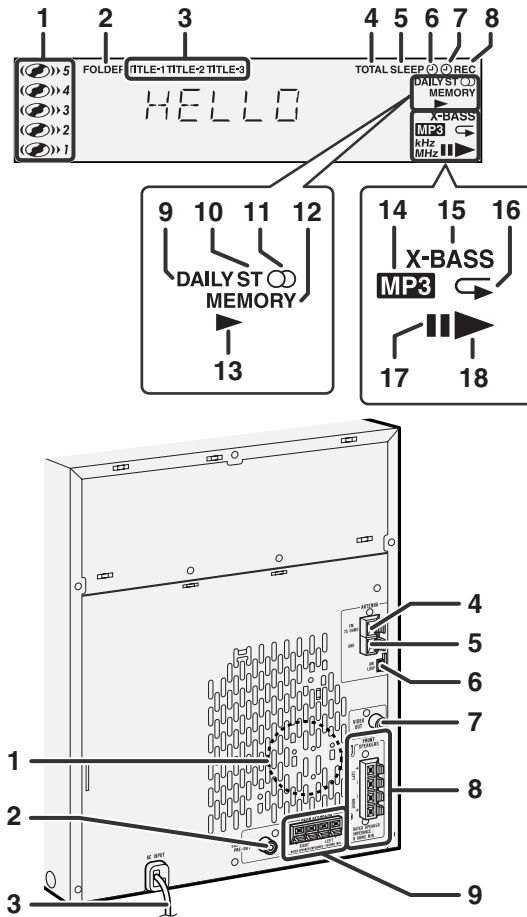

> Display

	Reference page
1. Disc Number Indicators	23
2. MP3 Folder Indicator	26
3. MP3 Title Indicators	26
4. MP3 Total Indicator	27
5. Sleep Indicator	39
6. Timer Play Indicator	37
7. Timer Recording Indicator	37
8. Tape 2 Record Indicator	34
9. Daily Timer Indicator	37
10. FM Stereo Mode Indicator	30
11. FM Stereo Receiving Indicator	30
12. Memory Indicator	25, 29, 31
13. Tape Play Indicator	32
14. MP3 Disc Indicator	21
15. Extra Bass Indicator	18
16. Disc Repeat Play Indicator	24
17. Disc Pause Indicator	22
18. Disc Play Indicator	21

> Rear panel

	Reference page
1. Cooling Fan	15
2. Subwoofer Pre-output Jack	14
3. AC Power Cord	14
4. FM 75 Ohms Antenna Terminal	12
5. FM Antenna Ground Terminal	12
6. AM Loop Antenna Jack	12
7. Video Output Jack	40
8. Front Speaker Terminals	12
9. Rear Speaker Terminals	12

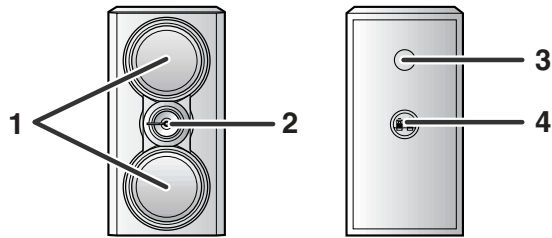

> **Front speaker**

- 1. Woofers
- 2. Tweeter
- 3. Bass Reflex Duct
- 4. Speaker Terminals

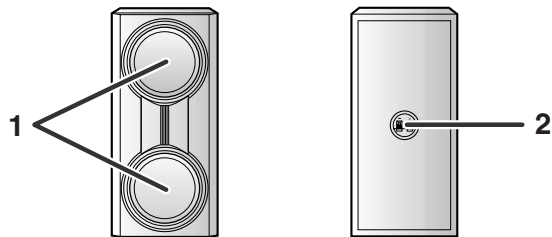

> **Rear speaker**

- 1. Full-range Speakers
- 2. Speaker Terminals

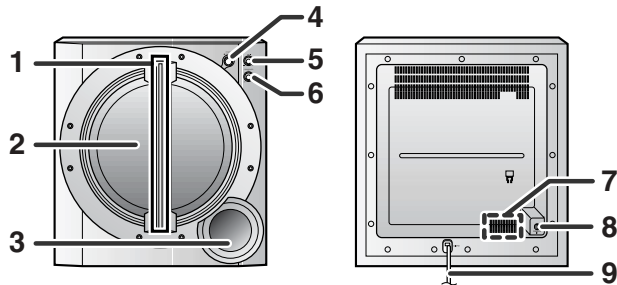

> **Active subwoofer**

	Reference page
1. Power Indicator	17
2. Subwoofer	17
3. Bass Reflex Duct	17
4. Power Switch	17
5. Volume Control	17
6. Crossover Frequency Control	17
7. Cooling Fan	15
8. Subwoofer Input Jack	14
9. AC Power Cord	14

Controls and indicators (continued)

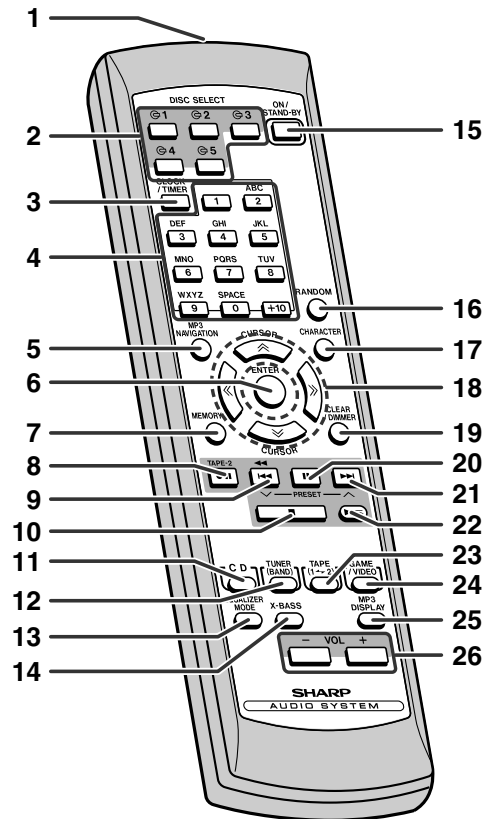

> Remote control

Reference page

1. Remote Control Transmitter	16
2. Disc Number Select Buttons	21
3. Clock/Timer Button	19, 36, 39
4. Character Input/Disc Direct Search Buttons	23, 28
5. MP3 Disc Navigation Mode Select Button	27
6. Enter Button	27
7. Memory/Set Button	19, 25, 29, 31, 36, 39
8. Tape 2 Record Pause Button	34, 35
9. Disc Track Down or Fast Reverse, Tape 2 Rewind, Tuner Preset Down, Time Down Button	19, 22, 31, 33
10. Disc or Tape Stop Button	22, 33
11. CD Button	21
12. Tuner (Band) Button	30
13. Equalizer Mode Select Button	18
14. Extra Bass Button	18
15. Power On/Stand-by Button	18
16. Disc Random Button	24
17. Character Button	28
18. Cursor Buttons	27
19. Disc Clear/Dimmer Button	18, 25
20. Disc Pause Button	22
21. Disc Track Up or Fast Forward, Tape 2 Fast Forward, Tuner Preset Up, Time Up Button	19, 22, 31, 33
22. Disc Play or Repeat, Tape Play Button	21, 24, 32
23. Tape (1 - 2) Button	32
24. Game/Video Button	40
25. MP3 Disc Display Button	22
26. Volume Up and Down Buttons	18

System connections

CD-G10000
CP-G10000S

Make sure to unplug the AC power cord before making any connections.

■ Antenna connection (see page 12)

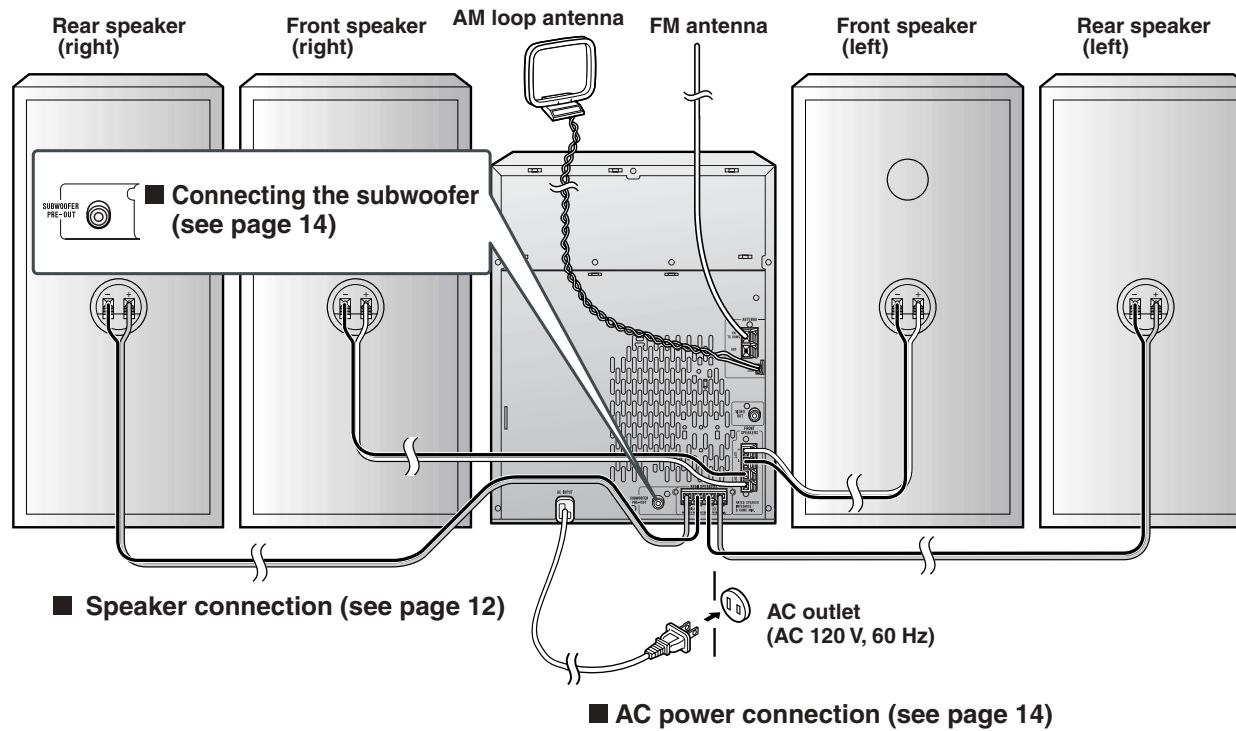

Preparation for Use

System connections (continued)

> Antenna connection

Supplied FM antenna:

Connect the FM antenna wire to the FM 75 OHMS terminal and position the FM antenna wire in the direction where the strongest signal can be received.

Supplied AM loop antenna:

Connect the AM loop antenna to the AM LOOP jack. Position the AM loop antenna for optimum reception. Place the AM loop antenna on a shelf, etc., or attach it to a stand or a wall with screws (not supplied).

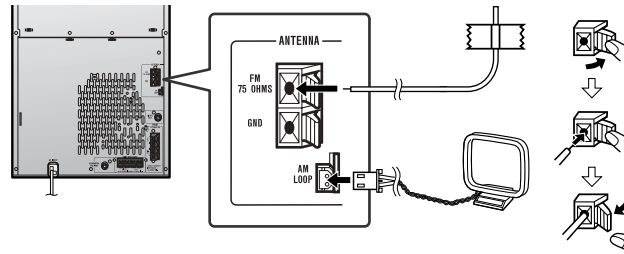

Note:

Placing the antenna on the unit or near the AC power cord may cause noise pickup. Place the antenna away from the unit for better reception.

Installing the AM loop antenna:

< Assembling >

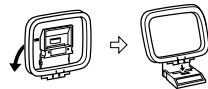

< Attaching to the wall >



> Speaker connection

Front speakers:

Connect the black wire to the FRONT SPEAKERS (-) terminal, and the red wire to the FRONT SPEAKERS (+) terminal.

Rear speakers:

Connect the black wire to the REAR SPEAKERS (-) terminal, and the gray wire to the REAR SPEAKERS (+) terminal.

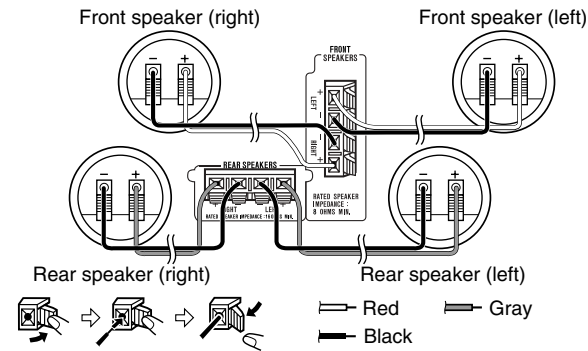

Caution:

- Connect the speaker wires to the speakers first, then to the unit.
- Never mistake the FRONT SPEAKERS and the REAR SPEAKERS terminals. Otherwise the unit or the speakers may be damaged.
- If you use other speakers with impedance lower than that specified, the unit may be damaged.
Front speakers: 8 ohms Rear speakers: 16 ohms
- Do not mistake the right and the left channels. The right speaker is the one on the right side when you face the unit.
- **Do not let the bare speaker wires touch each other.**
- Do not allow any objects to fall into or to be placed in the bass reflex ducts.
- Do not stand or sit on the speakers. You may be injured.

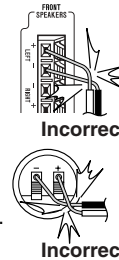

> **Placing the speaker system**

To enjoy the surround effect, we recommend that you place each speaker as shown to the below.

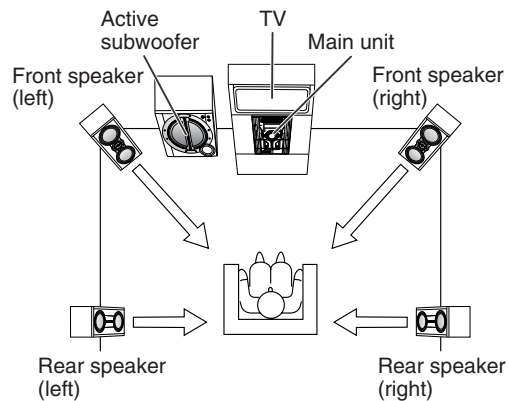

Notes:

The front speakers, rear speakers and active subwoofer are magnetically shielded. Therefore, they do not affect the display even if you use them near the TV. However, some color variation may occur, depending on the type of TV used.

If color variation occurs...

Turn off the TV (from the power switch).
After 15 - 30 minutes, turn the TV on again.

If the color variation is still present...

Move the speakers further away from the TV.

If any kind of magnet or an electromagnet is placed too close to the TV and the system, irregular colors may appear on the TV screen.

Note:

The speaker grilles are not removable.

> **Outdoor FM antenna**

Use an outdoor FM antenna if you require better reception. Consult your dealer.

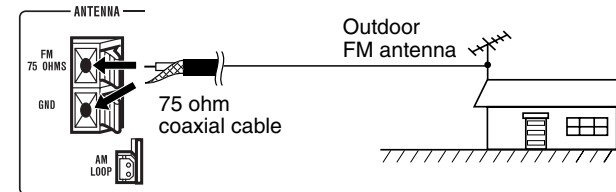

Note:

When an outdoor FM antenna is used, disconnect the supplied FM antenna wire.

System connections (continued)

Make sure to unplug the AC power cord of the main unit before making any connections.

> Connecting the subwoofer

Use the subwoofer cable to connect the SUBWOOFER PRE-OUT jack on the main unit and the SUBWOOFER IN jack on the active subwoofer.

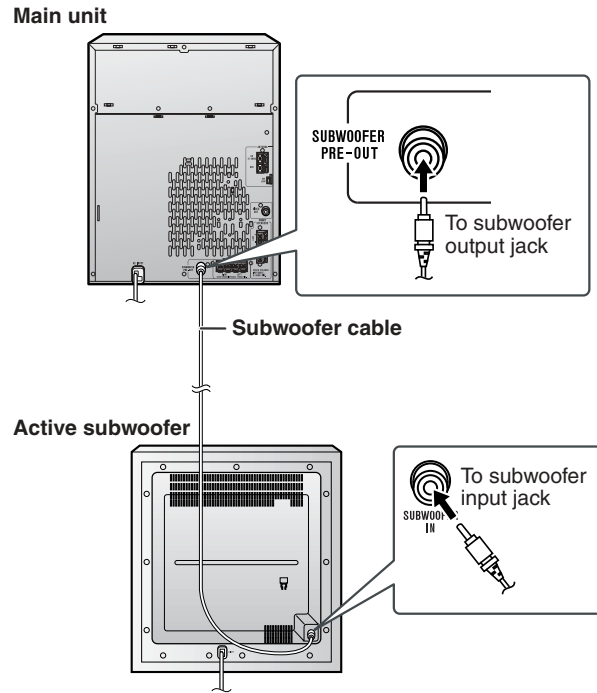

> AC power connection

After checking all the connections have been made correctly, plug the AC power cord of this unit into the AC outlet. If you plug in the unit first, the unit will enter the demonstration mode.

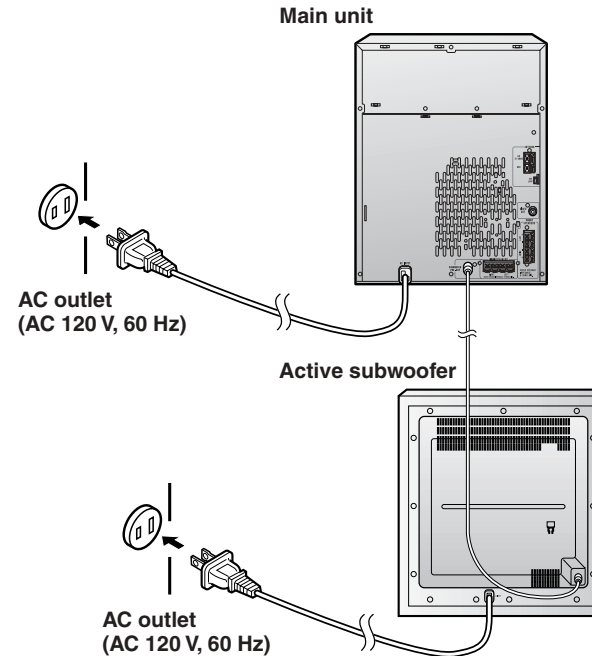

Notes:

- The unit will start the tape initialization when plugged in to the AC outlet. During this process, an initializing sound will be heard and the unit cannot be turned on. Wait until the process is finished.
- Unplug the AC power cord from the AC outlet if the unit will not be in use for a prolonged period of time.

Cooling fan:

The main unit and the active subwoofer are built with a cooling fan at the rear of the units for improved cooling. Please do not cover the opening of the fan with any obstacles, as this will block proper ventilation.

Main unit

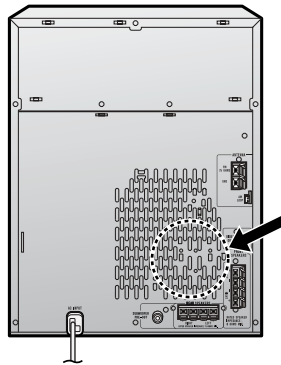

Active subwoofer

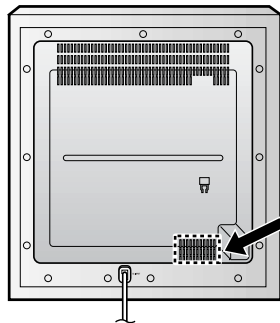

> **Demonstration mode**

When you plug the unit in for the first time, the unit will enter the demonstration mode. You will see words scroll.

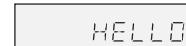

To cancel the demonstration mode:

When the unit is in the power stand-by mode (demonstration mode), press the X-BASS/DEMO button. The unit will enter the low power consumption mode.

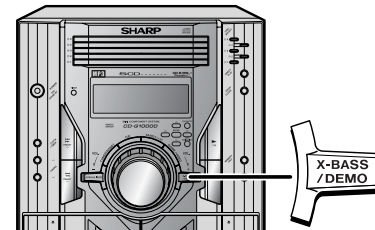

To return to the demonstration mode:

When the unit is in the power stand-by mode, press the X-BASS/DEMO button again.

Note:

When the power is on, the X-BASS/DEMO button can be used to select the extra bass mode.

Remote control

> Battery installation

Use 2 "AA" size batteries (UM/SUM-3, R6, HP-7 or similar).
Batteries are not included.

- 1 **Open the battery cover.**
- 2 **Insert the batteries according to the direction indicated in the battery compartment.**
When inserting or removing the batteries, push them toward the ⊖ battery terminals.
- 3 **Close the battery cover.**

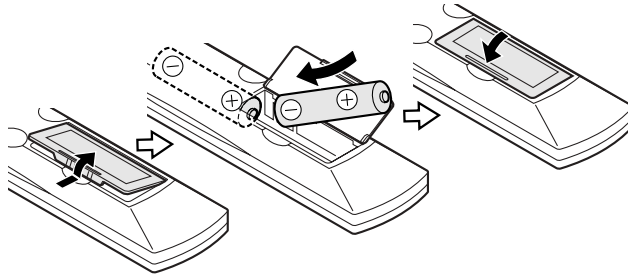

Precautions for battery use:

- Replace all old batteries with new ones at the same time.
- Do not mix old and new batteries.
- Remove the batteries if the unit will not be used for long periods of time. This will prevent potential damage due to battery leakage.

Caution:

- Do not use rechargeable batteries (nickel-cadmium battery, etc.).
- Installing the batteries incorrectly may cause the unit to malfunction.

Battery removal:

Open the battery cover, and pull up the battery to take out.

Notes concerning use:

- Replace the batteries if the operating distance is reduced or if the operation becomes erratic.
- Periodically clean the transmitter on the remote control and the sensor on the unit with a soft cloth.
- Exposing the sensor on the unit to strong light may interfere with operation. Change the lighting or the direction of the unit.
- Keep the remote control away from moisture, heat, shock, and vibrations.

> Test of the remote control

Check the remote control after checking all the connections (see pages 11 - 14).
Point the remote control directly at the remote sensor on the unit.

The remote control can be used within the range shown below:
Press the ON/STAND-BY button. Does the power turn on? Now, you can enjoy music.

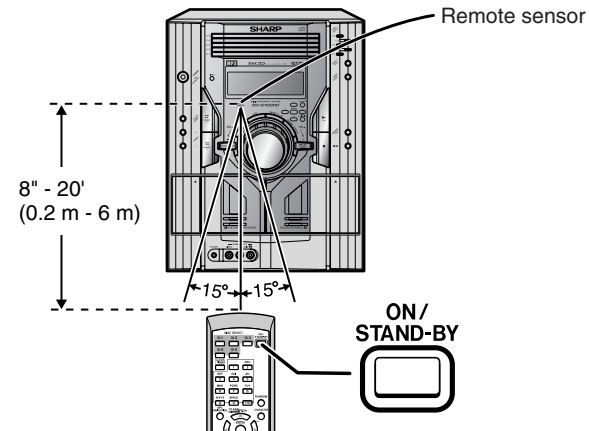

Subwoofer control

CD-G10000
CP-G10000S

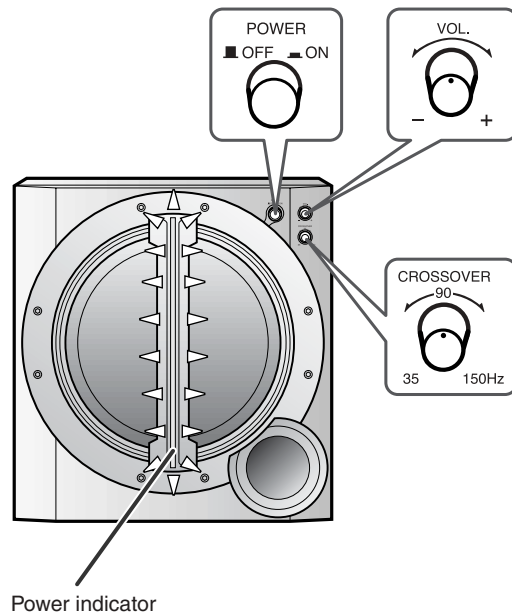

Before you turn the system on/off on the main unit, minimize the speaker volume on the main unit and turn the VOL. control of the subwoofer to "-".

> **Power switch**

The POWER indicator lights up when you press the POWER switch to = ON.

> **Volume control**

Turn the VOL. control clockwise to increase the volume, and turn it counterclockwise to decrease the volume.

> **Crossover frequency control**

Adjust the high frequency cut-off point. Frequencies higher than the set frequency are removed.
To emphasize the bass, turn this control toward 35 Hz and increase the volume.

Note:

Observe the following to avoid malfunction and sound distortion.
Do not set the volume too high on the main unit. The subwoofer may be damaged.

General control

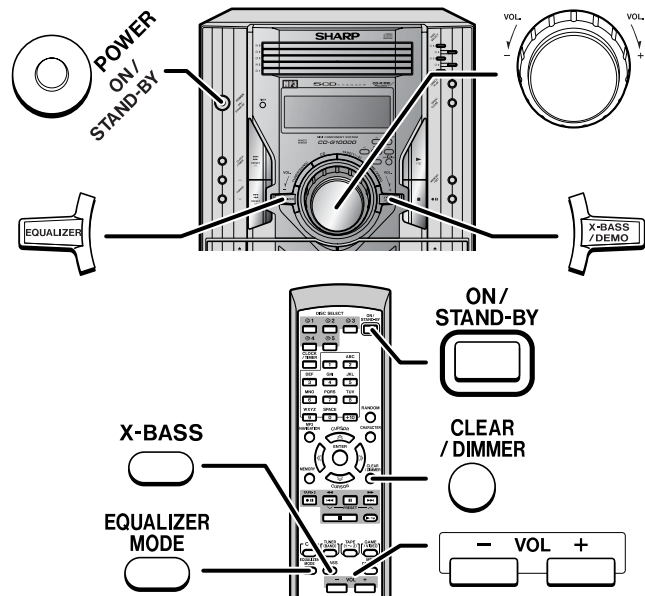

> **To turn the power on**
Press the ON/STAND-BY button to turn the power on.

After use:
Press the ON/STAND-BY button to enter the power stand-by mode.

> **Illumination light control**
When the power is turned on, light illuminates around the display. Hold down the CLEAR/DIMMER button on the remote control for 2 seconds or more to turn on/off the light.

> Volume control

Main unit operation:
When the VOL. control is turned clockwise, the volume will increase. When it is turned counterclockwise, the volume will decrease.

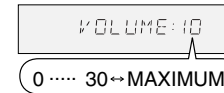

Remote control operation:
Press the VOL (+ or -) button to increase or decrease the volume.

> Bass control (X-BASS)

When the power is first turned on, the unit will enter the extra bass mode which emphasizes the bass frequencies, and "X-BASS" will appear. To cancel the extra bass mode, press the X-BASS/DEMO (X-BASS) button.

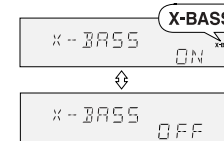

> Equalizer

When the EQUALIZER (EQUALIZER MODE) button is pressed, the current mode setting will be displayed. To change to a different mode, press the EQUALIZER (EQUALIZER MODE) button repeatedly until the desired sound mode appears.

In CD/TUNER/TAPE mode	In GAME/VIDEO mode
→ FLAT No equalization.	→ FLAT No equalization.
↓ ROCK For rock music.	↓ ROCK For rock music.
↓ CLASSIC For classical music.	↓ CLASSIC For classical music.
↓ POPS For pop music.	↓ ACTION For action games.
↓ VOCAL Vocals are enhanced.	↓ SPORTS For sports games.
↓ JAZZ For jazz.	↓ RACING For car racing games.



Note:
The extra bass mode is canceled when the EQUALIZER (EQUALIZER MODE) button is pressed.

Setting the clock

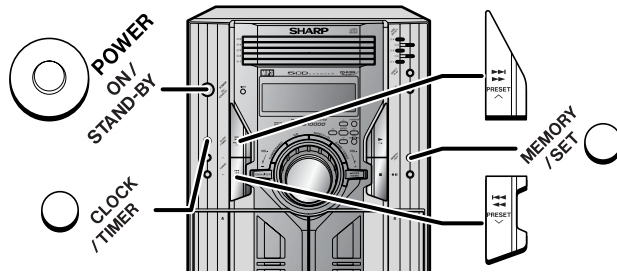
CD-G10000
CP-G10000S



In this example, the clock is set for the 12-hour (AM 12:00) display.

1	Press the ON/STAND-BY button to turn the power on.
2	Press the CLOCK/TIMER button.
3	Within 10 seconds, press the MEMORY/SET button to select "CLOCK", and press the MEMORY/SET button.
	
4	Press the MEMORY/SET button to select 12-hour or 24-hour display and then press the MEMORY/SET button.
	
"AM 12:00"	→ The 12-hour display will appear. (AM 12:00 - PM 11:59)
"AM 0:00"	→ The 12-hour display will appear. (AM 0:00 - PM 11:59)
"0:00"	→ The 24-hour display will appear. (0:00 - 23:59)

5 Press the **MEMORY/SET** button to adjust the hour and then press the **MEMORY/SET** button.



Press the **MEMORY/SET** button once to advance the time by 1 hour. Hold it down to advance continuously.

6 Press the **MEMORY/SET** button to adjust the minutes and then press the **MEMORY/SET** button.

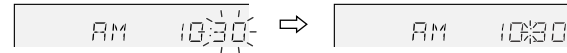

Press the **MEMORY/SET** button once to advance the time by 1 minute. Hold it down to change the time in 5-minute intervals.

To confirm the time display:

[When the unit is in the stand-by mode]
Press the **CLOCK/TIMER** button.

The time display will appear for about 10 seconds.

[When the power is on]

Press the **CLOCK/TIMER** button.

Within 10 seconds, press the **MEMORY/SET** button to display the time.
The time display will appear for about 10 seconds.

Note:

The "CLOCK" will appear or time will flash to confirm the time display when the AC power supply is restored after a power failure or unplugging the unit. If incorrect, readjust the clock as follows.

To readjust the clock:

Perform "Setting the clock" from step 1. If the "CLOCK" does not appear in step 3, step 4 (for selecting the 12-hour or 24-hour display) will be skipped.

To change the 12-hour or 24-hour display:

- 1 Clear all the programmed contents. [Refer to "Clearing all the memory (reset)" on page 43 for details.]
- 2 Perform "Setting the clock" from step 1.

Note:

The clock can also be set with the remote control.

Listening to a CD or MP3 disc

This system can play back a standard CD, CD-R/RW in the CD format and CD-R/RW with MP3 files, but cannot record on them. Some audio CD-R and CD-RW discs may not be playable due to the state of the disc or the equipment used for recording.

MP3 is a form of compression. It is an acronym which stands for MPEG Audio Layer 3.

MP3 is a type of audio code which is processed by significant compression from the original audio source with very little loss in sound quality.

Notes:

- "MP3" indicator will light up after the unit reads information on an MP3 disc.
- This system supports MPEG 1 Layer 3, MPEG 2 Layer 3, and VBR files.
- During VBR file playback, time counter in the display may differ from its actual playback time.

Auto power on function:

When you press any of the following buttons, the unit turns on.

- CD button (main unit and remote control): The unit turns on and the "CD" function is activated.
- ▶ / ◀ button (main unit and remote control): The unit turns on and playback of the last function starts (CD/TAPE/TUNER/GAME).

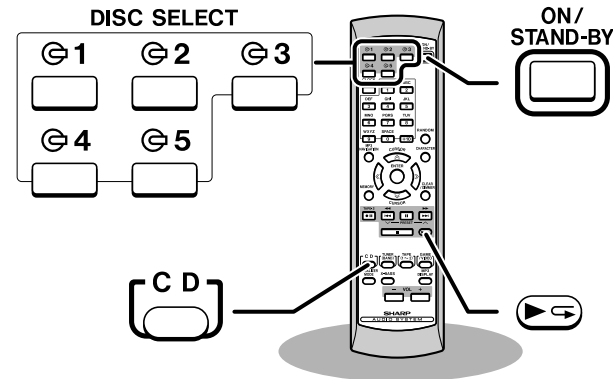
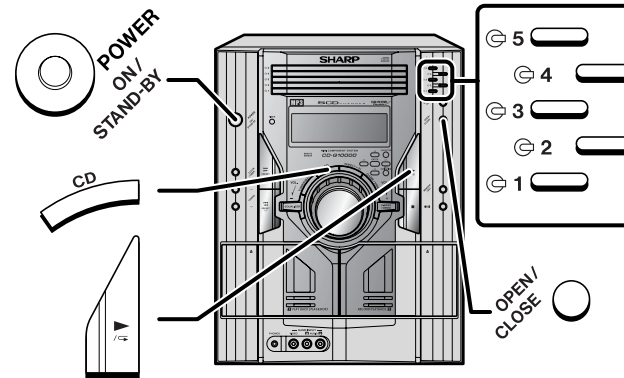

1 Press the ON/STAND-BY button to turn the power on.

2 Press the CD button.

3 Press the \ominus 1 button and within 5 seconds, press the OPEN/CLOSE button to open the disc tray 1.

4 Place the disc on the disc tray 1, label side up.
Be sure to place 3" (8 cm) disc in the middle of the disc trays.

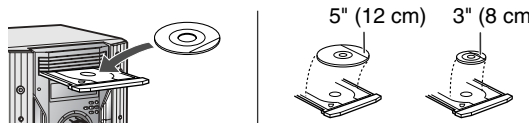

5 Press the OPEN/CLOSE button to close the disc tray 1.

[CD]



Total number of tracks on the disc whose number is flashing

Total playing time of the disc whose number is flashing

[MP3] MP3 disc indicator

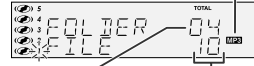

Total number of folders

Total number of files

Due to the structure of its disc information, it takes longer to read an MP3 disc than a normal CD (approximately 20 to 90 seconds).

6 You can place discs on the trays 2 - 5 by following steps 3 - 5.

7 Press the \triangleright / \triangleleft button to start playback.

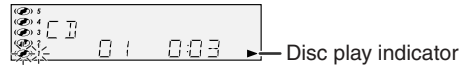

- Playback will begin from track 1 on the disc 1. After that disc finishes playing, the next disc will automatically play.
- After the last track on the fifth disc is played, the unit will stop automatically.
- When there is no disc in one of the disc trays (1 - 5), the empty tray will be skipped to the next tray with a disc.

To exchange other discs while playing a disc:

Press one of the \ominus 1 - \ominus 5 buttons for the stopped disc and within 5 seconds, press the OPEN/CLOSE button and exchange discs.

To remove the discs:













In the stop mode, press the \ominus 1 - \ominus 5 button and within 5 seconds, press the OPEN/CLOSE button.

Caution:

- Do not place two discs in one disc tray.
- Do not play discs of special shapes (heart, octagon, etc.) as it may cause malfunctions.
- Do not push the disc tray while it is moving.
- If the power fails while the tray is open, wait until the power is restored.
- If the disc tray is stopped with force, "ER-CD20" will appear on the display for 3 seconds and the unit will not function. If this occurs, press the ON/STAND-BY button to enter the power stand-by mode and then turn the power on again.
- If TV or radio interference occurs during CD operation, move the unit away from the TV or radio.
- If a disc is damaged, dirty, or loaded upside down, the disc will skip.

Listening to a CD or MP3 disc (continued)

> Various disc functions

Function	Main unit	Remote control	Operation
Play 			Press in the stop mode.
Stop 			Press in the playback mode.
Pause 			Press in the playback mode. Press the ► / ◀ button to resume playback from the paused point.
Track up/ Track down			Press in the playback or stop mode. If you press the button in the stop mode, press the ► / ◀ button to start the desired track.
Fast forward/ Fast reverse			Press and hold down in the playback mode. Release the button to resume playback.

Notes:

- Track up/track down is possible only within individual discs.
- The sound is heard during fast forward/fast reverse with a CD, but not with an MP3 disc. For fast forward or fast reverse of an MP3 disc, refer to playback time on the display.

Notes for CD:

- Fast forward/fast reverse is possible only within individual discs.
- When the end of the last track is reached during fast forward, "END" will appear on the display and CD operation will be paused. When the beginning of the first track is reached during fast reverse, the unit will enter the playback mode.

Notes for MP3 discs:

- Fast forward/fast reverse is possible only within individual tracks.
- When the end of the track is reached during fast forward, the next track will be played. Playback of the track will begin when its beginning is reached during fast reverse.

> To change the display (MP3 discs only)

While a disc is playing, press the MP3 DISPLAY button. Each time the button is pressed, the display will change as follows.

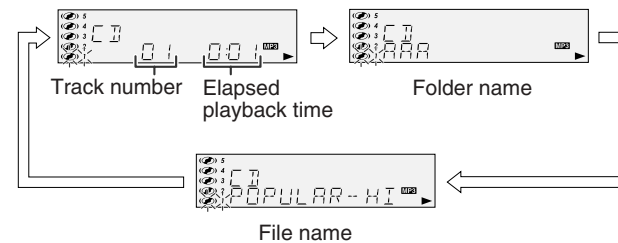
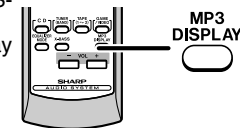

Advanced CD or MP3 disc playback

CD-G10000
CP-G10000S

> To specify a disc to play

You can play a disc by specifying the disc number.

1 Press one of the 1 - 5 buttons to select the desired disc.

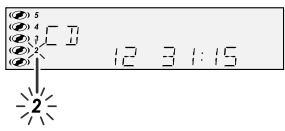

Selected disc number

2 Within 5 seconds, press the DIRECT PLAY button on the main unit.

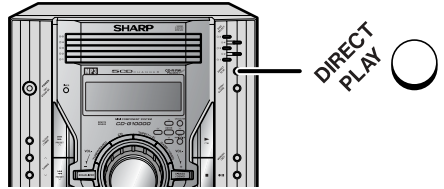

- Playback will begin from track 1 on the chosen disc.
- After the last track on the chosen disc is played, the unit stops automatically.

Note:

If the button of the disc tray with no disc is pressed, playback will not start and the disc indicator will go out.

To stop playback:

Press the ■ button.

> Direct track search

By using the direct search buttons, the desired tracks on the current disc can be played.

Use the direct search buttons on the remote control to select the desired track while playing the selected disc.

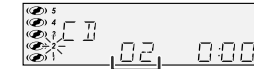

Selected track number

- The direct search buttons allow you to select up to number 9.
- When selecting number 10 or higher, use the "+10" button.

A. For example, to choose 13

- 1 Press the "+10" button once.
- 2 Press the "3" button.

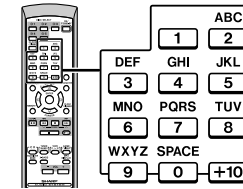

B. For example, to choose 30

- 1 Press the "+10" button three times.
- 2 Press the "0" button.

If the direct search buttons are pressed while the disc is stopped, press the ► / ◀ button to start the desired track on the current disc.

Notes:

- A track number higher than the number of tracks on the disc cannot be selected.
- During random play, direct search is not possible.

Advanced CD or MP3 disc playback (continued)

> Repeat play

Repeat play can play all 5 discs, all tracks on a chosen disc, or a programmed sequence continuously.

To repeat all tracks on up to 5 discs:

Press the ► / ◀ button twice.

To repeat desired tracks:

Perform steps 1 - 6 in "Programmed play" section on page 25 and then press the ► / ◀ button twice.

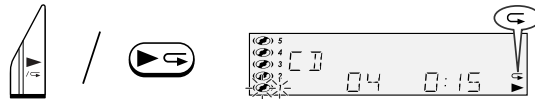

To cancel repeat play:

Press the ► / ◀ button again.
"R" will go out.

To repeat all tracks on the chosen disc:

- 1 Press one of the 1 - 5 buttons.
- 2 Within 5 seconds, press the DIRECT PLAY button twice.



To cancel repeat play:

Press the DIRECT PLAY button again.
"R" will go out.

> Random play

The tracks on the disc(s) can be played in random order automatically.

To random play all tracks on up to 5 discs:

Press the RANDOM button on the remote control.

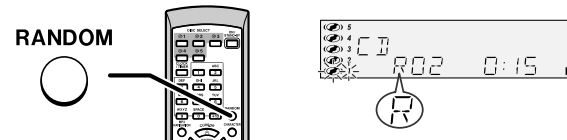

To cancel random play:

Press the ► / ◀ button.
"R" will go out.

To random play all tracks on the chosen disc:

- 1 Press one of the 1 - 5 buttons.
- 2 Within 5 seconds, press the DIRECT PLAY button.
- 3 Press the RANDOM button on the remote control.

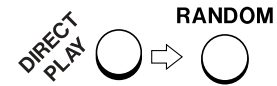

To cancel random play:

Press the DIRECT PLAY button.
"R" will go out.

Notes:



- If you press the ►► button during random play, you can move to the next track by the random operation. On the other hand, the ◀◀ button does not allow you to move to the previous track. The beginning of the track being played will be located.
- In random play, the unit will select and play tracks automatically. (You cannot select the order of the tracks.)

Caution:

After performing repeat or random play, be sure to press the ■ button. Otherwise, the disc(s) will play continuously.

> Programmed play

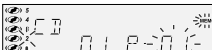
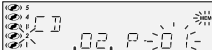
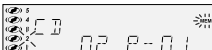
You can choose up to 32 selections for playback in the order you like.

<p>1 While in the stop mode, press the MEMORY/SET (MEMORY) button to enter the programming save mode.</p>	
<p>2 Press one of the 1 - 5 buttons to select the desired disc.</p>	 <p>Selected disc number</p>
<p>3 Press the direct search buttons on the remote control to select the desired track.</p>	 <p>Selected track number</p> <p>You can also select a track by pressing the ◀◀ or ▶▶ button.</p>
<p>4 Press the MEMORY/SET (MEMORY) button to save the track number.</p>	
<p>5 Repeat steps 2 - 4 for other tracks. Up to 32 tracks can be programmed. If you make a mistake, the programmed tracks can be cleared by pressing the CLEAR/DIMMER button.</p>	
<p>6 Press the ■ button. The total number of memory will appear.</p>	
<p>7 Press the ▶ / ⏪ button to start playback.</p>	

To clear the programmed selections:

Press the **CLEAR/DIMMER** button on the remote control while the "MEMORY" indicator is flashing. Each time the button is pressed, one track will be cleared, beginning with the last track programmed.

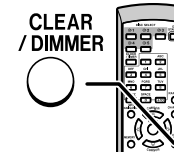

To cancel the programmed play mode:

While in the stop mode and the "MEMORY" indicator is lit, press the **CLEAR/DIMMER** button on the remote control. The "MEMORY" indicator will disappear and all the programmed contents will be cleared.

Adding tracks to the program:

If a program has been previously stored, the "MEMORY" indicator will be displayed. Then follow steps 1 - 6 to add tracks. The new tracks will be stored after the last track of the original program.

To check which tracks are programmed:

While the unit is stopped in the programmed play mode, press the **◀◀** or **▶▶** button.

Notes:

- When a disc with programmed tracks is ejected, the program is automatically canceled.
- Even if you press the **ON/STAND-BY** button to enter the stand-by mode or change the function from CD to another, the programmed selections will not be cleared.
- During the program operation, random play is not possible.
- During programmed play, the **DIRECT PLAY** button will not work.

MP3 navigation (only for MP3 files)

MP3 navigation:

You can search and play files by folder or title. For example, when you assign three titles to a file, enter genre (such as jazz) as title 1, album name as title 2, and music title as title 3 to search the file by any title.

- You can search and play files by folder or title 1/2/3 within one MP3 disc (see page 27).
- By entering a name, you can search files by folder or title 1/2/3 within one MP3 disc (see page 28).
- Folders or titles can be programmed within one MP3 disc (see page 29).

When you enter file names on your PC, connect words with hyphens. This product recognizes the first word as title 1, second one as title 2, and third one as title 3. Up to three words can be recognized.

Example:

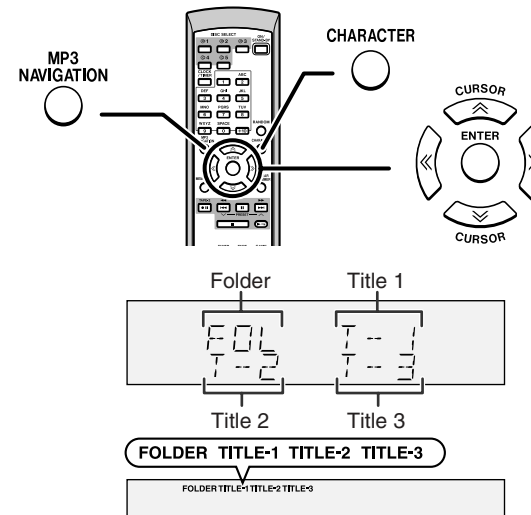
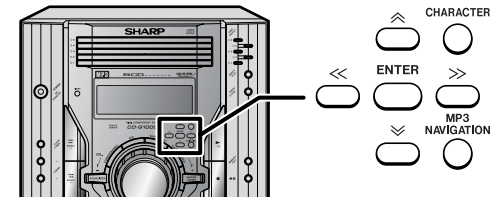
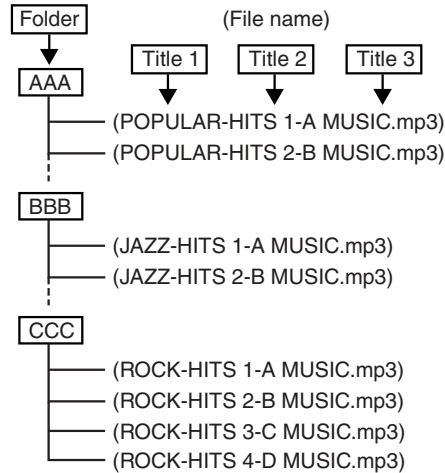

Notes:

- MP3 files must have the extension ".mp3".
- Up to 100 folders or 300 files can be read on the unit. If either limit is exceeded, no more folders/files are displayed.
- This unit recognizes and displays up to 48 characters for folder names, and up to 32 characters for title 1/2/3.
- All file/folder names appear in uppercase.

> **File search (by folder or title 1/2/3)**

You can search and play files by folder or title 1/2/3 within one MP3 disc.

1 Press one of the 1 - 5 buttons to select a disc tray containing an MP3 disc.

2 Press the ► / ◀ button, and the unit starts to read the MP3 disc.

3 Press the ■ button to stop playback.
"NAVI READ" appears and the display shows the total number of folders and files on the selected disc.

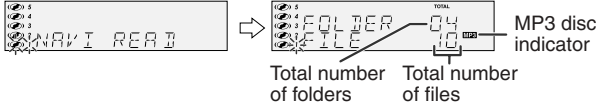

4 Press the MP3 NAVIGATION button.

5 Press the ◀, ▶, ⏪ or ⏩ button to select "FOL", "T-1", "T-2" or "T-3". To search files by folder name, select "FOL" (will flash).

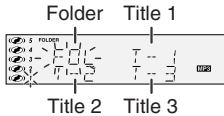

The following steps describe file search by folder:

6 Press the ENTER button.
The total number of folders (or titles) appears for 2 seconds, and names of the first 2 folders (or titles) are displayed.

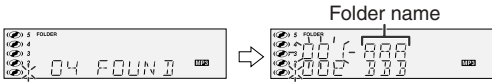

- The MP3 NAVIGATION button allows you to go one step back.
- Press the MP3 DISPLAY button to check the number of files.

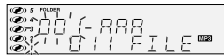

7 Use the ⏪ or ⏩ button to scroll and select a folder (or title), and then press the ENTER button.



If you press the ► / ◀ button instead of the ENTER button, all files in the selected folder (or title) are played.

8 Use the ⏪ or ⏩ button to scroll and select a file.



9 Press the ► / ◀ button to start playback.

The unit plays from the selected file to the last file in the selected folder (or title), and the previous display returns.

File search by title 1/2/3:

- In step 5, select "T-1", "T-2" or "T-3" and follow the same steps as file search by folder.
- The unit searches all files on the disc, regardless of the folder.

To stop playback:

Press the ■ button.

To exit the MP3 navigation mode:

In the stop mode, press the ■ button.

Notes:

- In the MP3 navigation mode, direct play and direct search functions are disabled.
- If a folder, title or file name does not appear, or appears incorrectly, remove and reinsert the disc and try again.
- If you press the RANDOM button in the stop mode, the MP3 navigation mode will be canceled.

MP3 navigation (only for MP3 files) (continued)

> Character search (for folder or title 1/2/3)

By entering a name, you can search files by folder or title 1/2/3 within one MP3 disc.

1 Perform steps 1 - 3 in "File search (by folder or title 1/2/3)" on page 27.

2 Press the MP3 NAVIGATION button.

3 Press the \ll , \gg , \wedge or \vee button to select "FOL", "T-1", "T-2" or "T-3". To search files by folder name, select "FOL" (will flash).

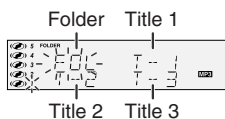

4 Press the CHARACTER button for 2 seconds.

The display will be ready for editing characters.

1st row: String table

2nd row: Input editor (8 digits)



5 Press the \ll or \gg button to select the desired alphabet.

Press the \lll or \ggg button to go to the next page of character display.

6 Press the CHARACTER button and the active character will be entered in the 2nd row of the display.



To delete an entered character, move the cursor to the character with the \wedge or \vee button and press the CLEAR/DIMMER button on the remote control.

7 Repeat steps 5 and 6 to enter characters.

In the folder (or title) name search, you do not have to enter the full name. The unit searches for names beginning with the entered characters.

8 When finished, press the ENTER button. The unit searches for the same name within folders (or titles).



If the search word is not in the folder (or title) name, "NOT FOUND" appears and the menu returns.

9 Use the \wedge or \vee button to scroll and select a folder (or title).

10 Press the \triangleright / \square button to start playback.

All files in the selected folder (or title) are played, and the previous display returns.

To exit the MP3 navigation mode:

In the stop mode, press the \blacksquare button.

Notes:

- The unit searches regardless of the case, and found names appear in uppercase.
- Some symbols do not appear properly.

Character entry with direct buttons:

The direct buttons on the remote control can also be used for character entry.

In step 5 on the left, use buttons 0 - 9 to enter alphabets.

Alphabet types change as you press a button.

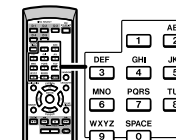

For example, press "2" four times to enter "C".

2 → A → B → C

Characters:

1	ABC	DEF	GHI	JKL	MNO	PQRS	TUV	WXYZ	SPACE
1	2 ABC	3 DEF	4 GHI	5 JKL	6 MNO	7 PQRS	8 TUV	9 WXYZ	0 []

[] : indicates a space.

> **Programmed play (for folder, title 1/2/3)**

Folders or titles can be programmed within one MP3 disc. Folder, title 1, title 2 and title 3 cannot be programmed together simultaneously.

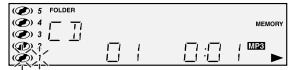
- | |
|--|
| <p>1 Perform steps 1 - 3 in "File search (by folder or title 1/2/3)" on page 27.</p> |
| <p>2 Press the MP3 NAVIGATION button.</p> |
| <p>3 Press the «, », ⌂ or ≡ button to select "FOL", "T-1", "T-2" or "T-3" and then press the ENTER button.
The total number of folders (or titles) appears for 2 seconds, and names of the first 2 folders (or titles) are displayed.</p> |
| <p>4 Press the ⌂ or ≡ button to select the desired folder (or title) and then press the MEMORY button.</p> <div style="text-align: center;">  </div> <p>The folder (or title) is memorized with all the files.</p> |
| <p>5 Repeat step 4 for other folders (or titles).
Up to 10 folders (or 10 titles) can be programmed.</p> |
| <p>6 Press the ▶ / ⏪ button to start playback.</p> <div style="text-align: center;">  </div> <p>Programmed play will always start from the smallest folder (or title) number.</p> |

To stop playback:

Press the ■ button.

- The programmed contents are not cleared.

To check, add or delete programmed contents:

In the stop mode, select a folder (or title) with the ⌂ or ≡ button. If the folder (or title) is programmed, "MEMORY" flashes.

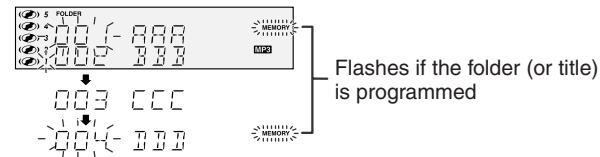

- When you press the MEMORY button with "MEMORY" flashing, the folder (or title) is removed from the program.
- If you press the MEMORY button with "MEMORY" off, the folder (or title) is added to the program.
- To clear all programs, press the CLEAR/DIMMER button in the stop mode.

To exit the MP3 navigation mode:

In the stop mode, press the ■ button.

- The programmed contents are cleared.

Notes:

- The programmed contents are cleared when you eject a disc, play another disc, switch the function, or enter the stand-by mode with the ON/STAND-BY button.
- During programmed play, the DIRECT PLAY button on the main unit will not work.
- If you press the RANDOM button in the stop mode, the MP3 navigation mode will be canceled.

If tracks are programmed using track numbers (see "Programmed play" on page 25):

In the MP3 navigation mode, only programs by folder (or title) name are played. When you exit the mode, the programs by folder (or title) name are cleared.

Even when you exit the MP3 navigation mode, programs by track number are retained, and you can play tracks according to the numbers.

(Programs by track number are cleared when you remove the disc.)

Listening to the radio

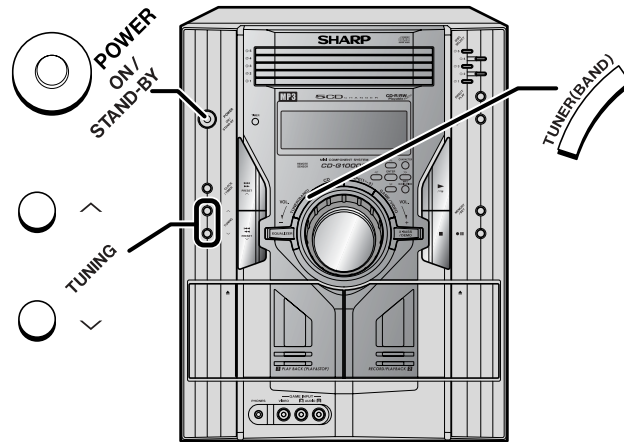

Auto power on function:

When you press any of the following buttons, the unit turns on.

- TUNER (BAND) button (main unit and remote control): The unit turns on and the "TUNER" function is activated.
- ► / ◀ button (main unit and remote control): The unit turns on and playback of the last function starts (CD/TAPE/TUNER/GAME).

> Tuning

- 1** Press the ON/STAND-BY button to turn the power on.
- 2** Press the TUNER (BAND) button repeatedly to select the desired frequency band (FM or AM).
- 3** Press the TUNING (∨ or ∧) button to tune in to the desired station.

Manual tuning:

Press the TUNING button as many times as required to tune in to the desired station.

Auto tuning:

When the TUNING button is pressed for more than 0.5 seconds, scanning will start automatically and the tuner will stop at the first receivable broadcast station.

Notes:

- When radio interference occurs, auto scan tuning may stop automatically at that point.
- Auto scan tuning will skip weak signal stations.
- To stop the auto tuning, press the TUNING button again.

To receive an FM stereo transmission:

Press the TUNER (BAND) button to display the "ST" indicator.

- "∞" will appear when an FM broadcast is in stereo.
- If the FM reception is weak, press the TUNER (BAND) button to extinguish the "ST" indicator. The reception changes to monaural, and the sound becomes clearer.

FM stereo mode indicator

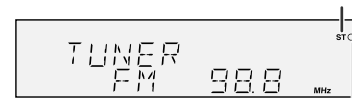

FM stereo receiving indicator

> **Memorizing a station**

You can store 40 AM and FM stations in memory and recall them at the push of a button. (Preset tuning)

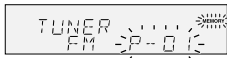
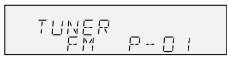
<p>1 Perform steps 1 - 3 in "Tuning" on page 30.</p>
<p>2 Press the MEMORY/SET (MEMORY) button to enter the preset tuning saving mode.</p> 
<p>3 Within 30 seconds, press the PRESET (∨ or ∧) button to select the preset channel number. Store the stations in memory, in order, starting with preset channel 1.</p>
<p>4 Within 30 seconds, press the MEMORY/SET (MEMORY) button to store that station in memory.</p>  <p>If the "MEMORY" and preset number indicators go out before the station is memorized, repeat the operation from step 2.</p>
<p>5 Repeat steps 1 - 4 to set other stations, or to change a preset station. When a new station is stored in memory, the station previously memorized for that preset channel number will be erased.</p>

Note:

The backup function protects the memorized stations for a few hours should there be a power failure or the AC power cord become disconnected.

> **To recall a memorized station**

Press the PRESET (∨ or ∧) button for less than 0.5 seconds to select the desired station.

> **To scan the preset stations**

The stations saved in memory can be scanned automatically. (Preset memory scan)

- 1 Press the PRESET (∨ or ∧) button for more than 0.5 seconds. The preset number will flash and the programmed stations will be tuned in sequentially, for 5 seconds each.
- 2 Press the PRESET (∨ or ∧) button again when the desired station is located.

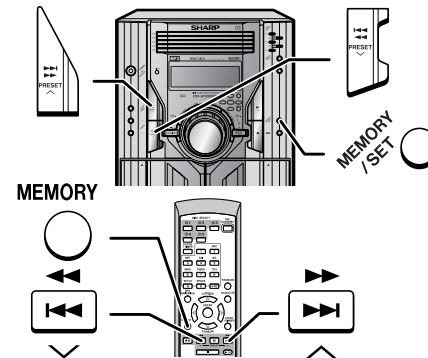

> **To erase entire preset memory**

- 1 Press the ON/STAND-BY button to enter the stand-by mode.
- 2 While pressing down the ●|| button and the X-BASS/DEMO button, press the CLOCK/TIMER button until "TUNER CL" appears.



Listening to a cassette tape (TAPE 1 or TAPE 2)

Before playback:

- For playback, use normal or low-noise tapes for the best sound. (Metal or CrO₂ tapes are not recommended.)
- Do not use C-120 tapes or poor-quality tapes, as they may cause malfunctions.
- Before loading a tape into the cassette compartment, tighten the slack with a pen or a pencil.

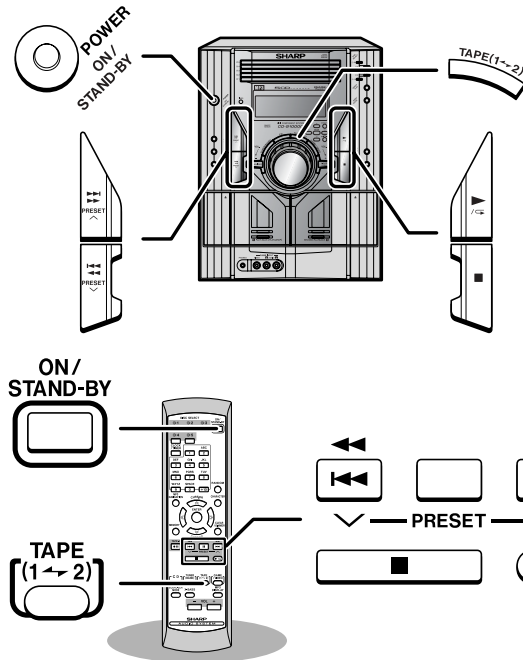

> Tape playback

1 Press the ON/STAND-BY button to turn the power on.

2 Open the cassette compartment by pushing the area marked "▲".

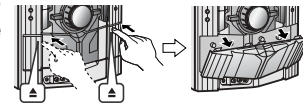

3 Load a cassette into the TAPE 1 compartment or TAPE 2 compartment with the side to be played facing toward you.

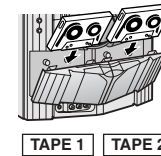

4 Press the TAPE (1 ~ 2) button to select the cassette you want to listen to.



5 Press the ▶ / ◀ button to start playback.

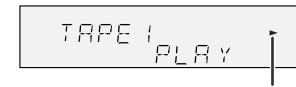









Tape play indicator

Auto power on function:

When you press any of the following buttons, the unit turns on.

- TAPE (1 ~ 2) button (main unit and remote control): The unit turns on and the "TAPE" function is activated.
- ▶ / ◀ button (main unit and remote control): The unit turns on and playback of the last function starts (CD/TAPE/TUNER/GAME).

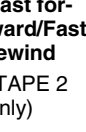
> **Various tape functions**

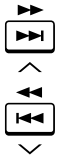
Function	Main unit	Remote control	Operation
Play 			Press in the stop mode.
Stop 			Press in the playback, fast forward or fast rewind mode.
Fast forward/Fast rewind (TAPE 2 only) 			Press in the playback or stop mode.

Caution:

- To remove the cassette, press the ■ button, and then open the compartment.
- Before changing from one tape operation to another, press the ■ button.
- If a power failure occurs during tape operation, the tape head will remain engaged with the tape and the cassette door will not open. In this case, wait until the power is restored.

Recording on a cassette tape

Before recording:

- When recording important selections, make a preliminary test to ensure that the desired material is properly recorded.
- SHARP is not liable for damage or loss of your recording arising from malfunction of this unit.
- The volume and sound controls can be adjusted with no effect on the recorded signal (Variable Sound Monitor).
- **For recording, use only normal tapes. Do not use metal or CrO₂ tapes.**
- Recording can be operated in the TAPE 2 compartment only. The TAPE 1 is for playback only.

Erase-prevention tab of cassette tapes:

- When recording on a cassette tape, make sure that the erase-prevention tabs are not removed. Cassettes have removable tabs that prevent accidental recording or erasing.
- To protect the recorded sound, remove the tab after recording. Cover the tab hole with adhesive tape to record on the tape without the tab.

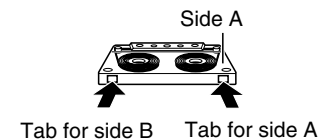

Recording on a cassette tape (continued)

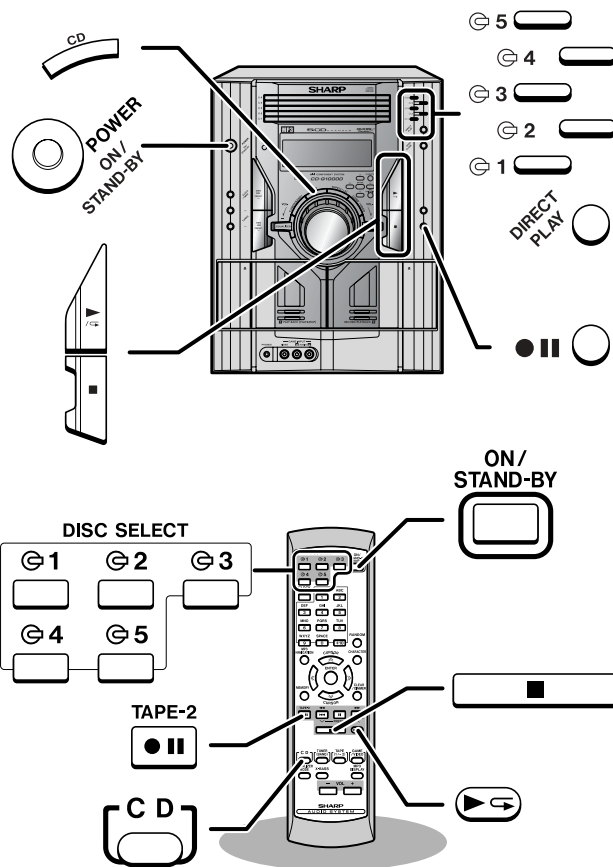

> Recording from a CD or MP3 disc

You can record the desired disc using the DIRECT PLAY button.

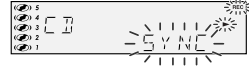
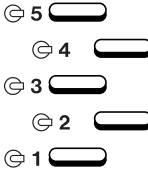
- 1 Press the ON/STAND-BY button to turn the power on.**
- 2 Press the CD button.**
- 3 Load a cassette into the TAPE 2 cassette compartment with the side to be recorded on facing you.**
Wind past the leader of the tape, on which recording cannot be performed.
- 4 Press the  button.**
Recording will be paused. 
- 5 Press one of the  buttons to select the desired disc.**
- 6 Within 5 seconds, press the DIRECT PLAY button to start recording.**
 - Recording is started from the selected disc. When the playback of the last track is finished or the end of the tape is reached, the disc and the cassette will stop automatically.
 - Playback of the disc will start approximately 7 seconds after the tape starts.

To stop recording:

Press the  button.
The disc and tape will stop.

Sequential recording from several discs:

- 1 Perform steps 1 - 5 in "Recording from a CD or MP3 disc" on page 34.
- 2 Within 5 seconds, press the ► / ◀ button.

To perform programmed recording:

- 1 Program discs and tracks (see pages 25, 29).
- 2 Press the ●|| button.
- 3 Press the ► / ◀ button.

To stop recording:

Press the ■ button.
The disc and tape will stop.

> **Recording from the radio**

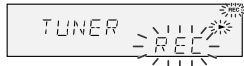
<p>1 Tune in to the desired station (see page 30).</p>
<p>2 Load a cassette into the TAPE 2 cassette compartment with the side to be recorded on facing you. Wind past the leader of the tape, on which recording cannot be performed.</p>
<p>3 Press the ● button. Recording will be paused.</p> <div style="text-align: center;">  </div>
<p>4 Press the ► / ◀ button to start recording.</p>

To interrupt recording:

Press the ●|| button.
To resume recording, press the ► / ◀ button.

To stop recording:

Press the ■ button.

Note:

If you hear a whistling noise while recording an AM station, move the AM loop antenna.

> **Dubbing from tape to tape**

You can record from TAPE 1 to TAPE 2.

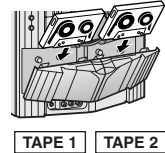
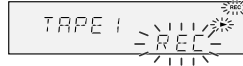
<p>1 Press the ON/STAND-BY button to turn the power on.</p>	
<p>2 Load a prerecorded cassette into the TAPE 1 cassette compartment. Insert a blank tape into the TAPE 2 cassette compartment.</p> <div style="text-align: center;">  </div>	
<p>It is recommended that the recording tape is the same length as the master tape.</p>	
<p>3 Press the TAPE (1 → 2) button until "TAPE 1" appears on the display.</p>	
<p>4 Press the ● button. Recording will be paused.</p> <div style="text-align: center;">  </div>	
<p>5 Press the ► / ◀ button to start dubbing.</p>	

To stop dubbing:

Press the ■ button.
TAPE 1 and TAPE 2 will simultaneously stop.

> **Erasing recorded tapes**

- 1 Load the tape to be erased into the TAPE 2 cassette compartment with the side to be erased facing toward you.
- 2 Press the TAPE (1 → 2) button until "TAPE 2" appears on the display.
- 3 Press the ●|| button.
- 4 Press the ► / ◀ button to start erasing.

Note:

Make sure that the TAPE 1 is not in use.

Timer and sleep operation

Timer playback:

The unit turns on and plays the desired source (CD, MP3 disc, tuner, tape) at a preset time.

Timer recording:

The unit turns on and starts recording from the tuner at the preset time.

This unit has 2 types of timer: ONCE TIMER and DAILY TIMER.

Once timer: Once timer play or once timer recording works for one time only at a preset time.

For example, if you are away but want to record a program on a radio station.

Daily timer: Daily timer play or daily timer recording works at the same preset time every day.

For example, set the timer as a wake-up call every morning.

Using the once timer and daily timer in combination:

For example, use the once timer to record a radio program, and use the daily timer to wake up.

- 1 Set the daily timer (pages 36 - 38).
- 2 Set the once timer (pages 36 - 38).

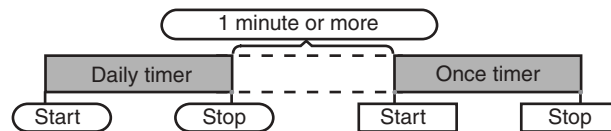

Note:

When set times for the daily timer and once timer overlap, the once timer takes priority. Allow an interval of at least 1 minute between operations.

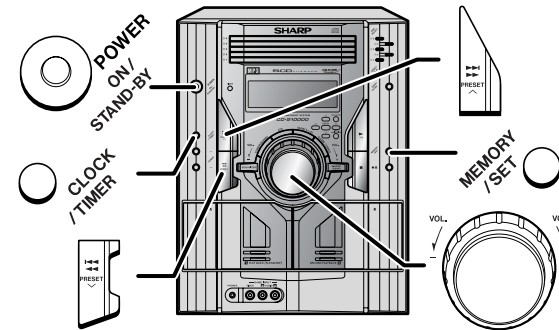

> Timer playback or timer recording

Before setting timer:

- 1 Check that the clock is set to the correct time (refer to page 19). If it is not set, you cannot use the timer function.
- 2 For timer playback: Load a cassette or discs to be played.
For timer recording: Load a cassette for recording in the TAPE 2 cassette compartment.



- 1 Press the ON/STAND-BY button to turn the power on.
- 2 Press the CLOCK/TIMER button.
- 3 Within 10 seconds, press the <<<< or >>>> button to select "ONCE" or "DAILY", and press the MEMORY/SET button.



Set the clock to the correct time if "ONCE" or "DAILY" does not appear.

4 Within 10 seconds, press the **◀◀◀** or **▶▶▶** button to select "ONCE SET" or "DAILY SET", and press the MEMORY/SET button.



5 Press the **◀◀◀** or **▶▶▶** button to select "PLAY" or "REC", and press the MEMORY/SET button.

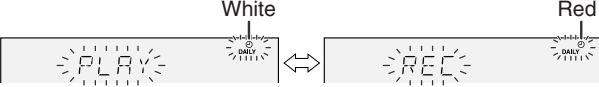

The illustrations show the daily timer setting.

6 Press the **◀◀◀** or **▶▶▶** button to adjust the hour and then press the MEMORY/SET button.

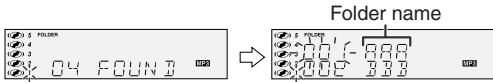

The illustrations show the timer playback setting in the daily timer mode.

7 Press the **◀◀◀** or **▶▶▶** button to adjust the minutes and then press the MEMORY/SET button.



8 Set the time to finish as in steps 6 and 7 above.

9 Switch input with the **◀◀◀** or **▶▶▶** button, and then press the MEMORY/SET button.

To select the timer playback source: CD, TUNER, TAPE 1 or TAPE 2.

To select the timer recording source: TUNER.

- When you select the tuner, select a station by pressing the **◀◀◀** or **▶▶▶** button, and then press the MEMORY/SET button.
- If a station has not been programmed, "NO PRESET" will be displayed and timer setting will be canceled.

10 Adjust the volume using the VOL. control, and then press the MEMORY/SET button.

Do not turn the volume up too high.

11 Press the ON/STAND-BY button to enter the power stand-by mode.

The "TIMER" indicator lights up and the unit is ready for timer playback or timer recording.

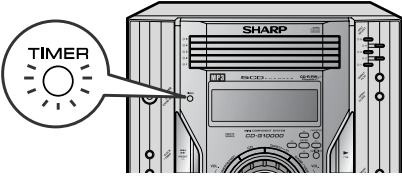

Continued to the next page

Timer and sleep operation (continued)

12 When the preset time is reached, playback or recording will start.

The volume will increase gradually until it reaches the preset volume.

13 When the timer end time is reached, the system will enter the power stand-by mode automatically.

Once timer:

The timer will be canceled.

Daily timer:

The timer will operate at the same time every day. It will continue until the daily timer setting is canceled. Cancel the daily timer when it is not in use.

Note:

When performing timer playback or recording using another unit connected to the GAME INPUT jacks, select "GAME" in step 9. This unit will turn on or enter the power stand-by mode automatically, however, the connected unit will not turn on or off.

Checking the timer setting in the timer stand-by mode:

- 1 Press the CLOCK/TIMER button.
- 2 Within 10 seconds, press the **◀◀** or **▶▶** button to select "ONCE" or "DAILY", and press the MEMORY/SET button.
- 3 Within 10 seconds, press the **◀◀** or **▶▶** button to select "ONCE CALL" or "DAILY CALL", and press the MEMORY/SET button.
The unit returns to the timer stand-by mode after displaying the settings in order.

Canceling the timer setting in the timer stand-by mode:

- 1 Press the CLOCK/TIMER button.
- 2 Within 10 seconds, press the **◀◀** or **▶▶** button to select "ONCE" or "DAILY", and press the MEMORY/SET button.
- 3 Within 10 seconds, press the **◀◀** or **▶▶** button to select "ONCE OFF" or "DAILY OFF", and press the MEMORY/SET button.
Timer will be canceled (the setting will not be canceled).

Reusing the memorized timer setting:

The timer setting will be memorized once it is entered. To reuse the same setting, perform the following operations.

- 1 Turn the power on and press the CLOCK/TIMER button.
- 2 Within 10 seconds, press the **◀◀** or **▶▶** button to select "ONCE" or "DAILY", and press the MEMORY/SET button.
- 3 Within 10 seconds, press the **◀◀** or **▶▶** button to select "ONCE ON" or "DAILY ON", and press the MEMORY/SET button.
- 4 Press the ON/STAND-BY button to enter the power stand-by mode.

Note:

The timer can also be set with the remote control.

> **Sleep operation**

The radio, CD, MP3 disc and cassette tape can all be turned off automatically.

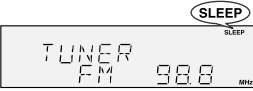
1	Play back the desired sound source.	
2	Press the CLOCK/TIMER button.	
3	Within 10 seconds, press the \lll or \ggg button to select "SLEEP", and press the MEMORY/SET button.	
4	Press the \lll or \ggg button to select the time. (Maximum: 3 hours - Minimum: 1 minute) <ul style="list-style-type: none"> · 3 hours - 5 minutes → 5-minute intervals · 5 minutes - 1 minute → 1-minute intervals 	
5	Press the MEMORY/SET button. "SLEEP" will appear.	
6	The unit will enter the power stand-by mode automatically after the preset time has elapsed. The volume will be turned down 1 minute before the sleep operation finishes.	

To confirm the remaining sleep time:

- 1 While "SLEEP" is indicated, press the CLOCK/TIMER button.
- 2 Within 10 seconds, press the \lll or \ggg button to select "SLEEP X : XX".
"X : XX" is remaining sleep time.
 - The remaining sleep time is displayed for about 10 seconds.
 - You can change the remaining sleep time while it is displayed by pressing the MEMORY/SET button (steps 4 - 5).

To cancel the sleep operation:

Press the ON/STAND-BY button while "SLEEP" is indicated. To cancel the sleep operation without setting the system to the stand-by mode, proceed as follows.

- 1 While "SLEEP" is indicated, press the CLOCK/TIMER button.
- 2 Within 10 seconds, press the \lll or \ggg button to select "SLEEP OFF", and press the MEMORY/SET button.

> **To use timer and sleep operation together**

Sleep and timer playback:

For example, you can fall asleep listening to the radio and wake up to CD in the next morning.

Sleep and timer recording:

For example, you can fall asleep listening to the CD and record radio programs while sleeping.

- 1 Set the sleep time (see left, steps 1 - 5).
- 2 While the sleep timer is set, set the timer playback or recording (steps 2 - 10, pages 36 - 37).

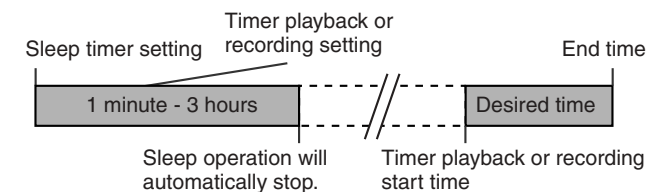

Caution:

When using the cassette deck, be sure the tape length is long enough to perform both functions. If you want to sleep and wake up listening to a tape, and the length of the tape is shorter than the sleep timer setting, timer playback or recording will not be possible.

Enhancing your system

The connection cord is not included. Purchase a commercially available cord as shown below.

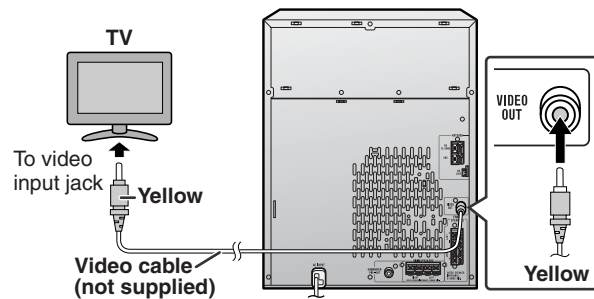
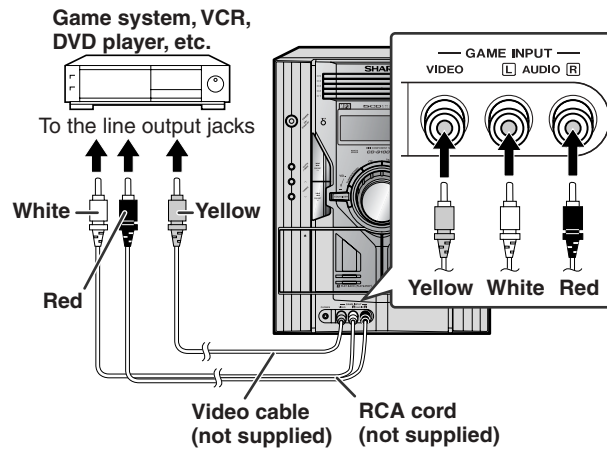

> Listening to sounds of game, VCR, DVD, etc.

- 1 Connect a video game system, VCR, DVD, etc. to the front GAME INPUT (VIDEO, AUDIO L and R) jacks.
- 2 Connect a TV to the rear VIDEO OUT jack.
Switch the TV input to auxiliary.
- 3 Press the ON/STAND-BY button to turn the power on.
- 4 Press the GAME/VIDEO button.
- 5 Play the connected equipment.

You can enjoy sounds from the supplied speakers and images on the TV.

Note:

To prevent noise interference, place the unit away from the television.

Auto power on function:

When you press any of the following buttons, the unit turns on.

- GAME/VIDEO button (main unit and remote control): The unit turns on and the "GAME" function is activated.
- ► / ◀ button (main unit and remote control): The unit turns on and playback of the last function starts (CD/TAPE/TUNER/GAME).

> To record sounds of game, VCR, etc.

- 1 Insert a cassette in the TAPE 2 cassette compartment.
- 2 Press the GAME/VIDEO button.
- 3 Press the ●|| button.
- 4 Press the ► / ◀ button.
- 5 Start the game system, VCR, etc.

- > **Headphones**
- Before plugging in or unplugging the headphones, reduce the volume.
- Be sure your headphones have a 1/8" (3.5 mm) diameter plug and impedance between 16 and 50 ohms. The recommended impedance is 32 ohms.
- Plugging in the headphones disconnects the speakers automatically. Adjust the volume using the VOL. control.

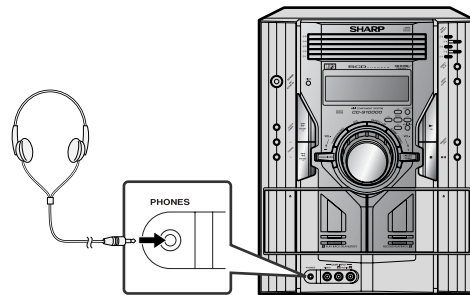

Troubleshooting chart

Many potential problems can be resolved by the owner without calling a service technician. If something is wrong with this product, check the following before calling your authorized SHARP dealer or service center.

> General

Symptom	Possible cause
• The clock is not set to the correct time.	• Did a power failure occur? Reset the clock. (Refer to page 19.)
• When a button is pressed, the unit does not respond.	• Set the unit to the power standby mode and then turn it back on. • If the unit still malfunctions, reset it. (Refer to page 43.)
• No sound is heard.	• Is the volume level set to "0"? • Are the headphones connected? • Are the speaker wires disconnected?

> CD player

Symptom	Possible cause
• Playback does not start.	• Is the disc loaded upside down?
• Playback stops in the middle or is not performed properly.	• Does the disc satisfy the standards? • Is the disc distorted or scratched?
• Playback sounds are skipped, or stopped in the middle of a track.	• Is the unit located near excessive vibrations? • Is the disc very dirty? • Has condensation formed inside the unit?

Troubleshooting chart (continued)

> Cassette deck

Symptom	Possible cause
* Cannot record.	* Is the erase-prevention tab removed?
* Cannot record tracks with proper sound quality. * Cannot erase completely.	* Is it a normal tape? (You cannot record on a metal or CrO ₂ tape.)
* Sound skipping.	* Is there slack in the tape? * Is the tape stretched?
* Cannot hear treble. * Sound fluctuation.	* Are the capstans, pinch rollers, or heads dirty?
* Cannot remove the tape.	* If a power failure occurs during playback, the heads remain engaged with the tape. Do not open the compartment with great force.

> Remote control

Symptom	Possible cause
* The remote control does not operate.	* Is the AC power cord of the unit plugged in? * Is the battery polarity correct? * Are the batteries dead? * Is the distance or angle incorrect? * Does the remote control sensor receive strong light?

> Tuner

Symptom	Possible cause
* The radio makes unusual noises continuously.	* Is the unit placed near the TV or computer? * Is the FM antenna or AM loop antenna placed properly? Move the antenna away from the AC power cord if it's located nearby.

> Condensation

Sudden temperature changes, storage or operation in an extremely humid environment may cause condensation inside the cabinet (CD pickup, tape heads, etc.) or on the transmitter on the remote control. Condensation can cause the unit to malfunction. If this happens, leave the power on with no disc (or cassette) in the unit until normal playback is possible (about 1 hour). Wipe off any condensation on the transmitter with a soft cloth before operating the unit.

> **If trouble occurs**

When this product is subjected to strong external interference (mechanical shock, excessive static electricity, abnormal supply voltage due to lightning, etc.) or if it is operated incorrectly, it may malfunction.

If such a problem occurs, do the following:

- 1 Set the unit to the stand-by mode and turn the power on again.
- 2 If the unit is not restored in the previous operation, unplug and plug in the unit, and then turn the power on.

Note:

If neither operation above restores the unit, clear all the memory by resetting it.

> **Clearing all the memory (reset)**

- 1 Press the ON/STAND-BY button to enter the power stand-by mode.
- 2 While pressing down the ●|| button and the X-BASS/DEMO button, press the ◀◀ ◀◀ PRESET ▾ button until "CLEAR ALL" appears.



Caution:

This operation will erase all data stored in memory including clock, timer settings, tuner preset, and CD program.

> **Before transporting the unit**

Remove all CDs from the unit. Make sure there is no CD in the disc tray. Then, set the unit to the power stand-by mode. Carrying the unit with discs left inside can damage the unit.

> **Care of compact discs**

Compact discs are fairly resistant to damage, however mistracking can occur due to an accumulation of dirt on the disc surface. Follow the guidelines below for maximum enjoyment from your CD collection and player.

- Do not write on either side of the disc, particularly the non-label side from which signals are read. Do not mark this surface.
- Keep your discs away from direct sunlight, heat, and excessive moisture.
- Always hold the CDs by the edges. Fingerprints, dirt, or water on the CDs can cause noise or mistracking. If a CD is dirty or does not play properly, clean it with a soft, dry cloth, wiping straight out from the center, along the radius.

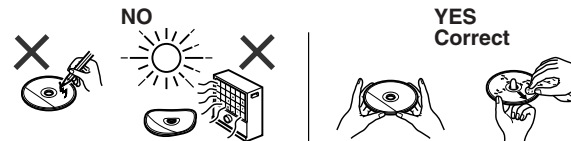

Maintenance

> Cleaning the tape-handling parts

- Dirty heads, capstans or pinch rollers can cause poor sound and tape jams. Clean these parts with a cotton swab moistened with commercial head/pinch roller cleaner or isopropyl alcohol.
- When cleaning the heads, pinch rollers, etc., unplug the unit which contains high voltages.

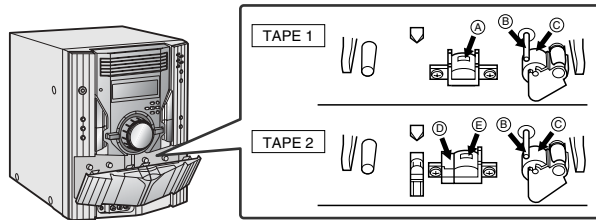

- A Playback head
- B Capstan
- C Pinch roller
- D Erase head
- E Recording/Playback head

- After long use, the deck's heads and capstans may become magnetized, causing poor sound. Demagnetize these parts once every 30 hours of playing/recording time by using a commercial tape head demagnetizer. Read the demagnetizer's instructions carefully before use.

> Cleaning the CD pickup lens

In order to ensure proper operation of the CD player, preventative maintenance (cleaning of the laser pickup lens) should be performed periodically. Lens cleaners are commercially available. Contact your local CD software dealer for options.

> Cleaning the cabinet

Periodically wipe the cabinet with a soft cloth and a diluted soap solution, then with a dry cloth.

Caution:

- Do not use chemicals for cleaning (gasoline, paint thinner, etc.). It may damage the cabinet finish.
- Do not apply oil to the inside of the unit. It may cause malfunctions.

Specifications

As part of our policy of continuous improvement, SHARP reserves the right to make design and specification changes for product improvement without prior notice. The performance specification figures indicated are nominal values of production units. There may be some deviations from these values in individual units.

> General

Power source	AC 120 V, 60 Hz
Power consumption	175 W
Dimensions	Width: 10-1/4" (260 mm) Height: 13" (330 mm) Depth: 12-7/8" (326 mm)
Weight	23.0 lbs. (10.4 kg)

> CD player

Type	5-disc multi-play compact disc player
Signal readout	Non-contact, 3-beam semiconductor laser pickup
D/A converter	1-bit D/A converter
Frequency response	20 - 20,000 Hz
Dynamic range	90 dB (1 kHz)

> Amplifier

Output power	
Front speakers	135 watts minimum RMS per channel into 8 ohms from 100 Hz to 20 kHz, 10% total harmonic distortion
Rear speakers	65 watts minimum RMS per channel into 16 ohms from 5 kHz to 20 kHz, 10% total harmonic distortion
Output terminals	Front speakers: 8 ohms Rear speakers: 16 ohms Headphones: 16 - 50 ohms (recommended: 32 ohms) Subwoofer pre-out (audio signal): 200 mV/10 k ohms at 70 Hz Video out: 1 Vp-p (75 ohms)
Input terminals	Game/ Auxiliary (audio signal): 500 mV/ 47 k ohms Game/Video: 1 Vp-p (75 ohms)

CD-G10000
CP-G10000S

Specifications (continued)

> Tuner

Frequency range	FM: 87.5 - 108.0 MHz AM: 530 - 1,720 kHz
------------------------	---

> Cassette deck

Frequency response	50 - 14,000 Hz (normal tape)
Signal/noise ratio	55 dB (TAPE 1, playback) 50 dB (TAPE 2, recording/playback)
Wow and flutter	0.3 % (WRMS)

> Front speaker

Type	2-way type speaker system 2" (5 cm) tweeter × 1 5-1/8" (13 cm) woofer × 2
Maximum input power	270 W
Rated input power	135 W
Impedance	8 ohms
Dimensions	Width: 8-11/16" (220 mm) Height: 16-9/16" (420 mm) Depth: 16-15/16" (430 mm)
Weight	12.1 lbs. (5.5 kg)/each

> Rear speaker

Type	Full-range speaker system 4" (10 cm) speaker × 2
Maximum input power	130 W
Rated input power	65 W
Impedance	16 ohms
Dimensions	Width: 7-7/8" (200 mm) Height: 16-9/16" (420 mm) Depth: 16-15/16" (430 mm)
Weight	8.8 lbs. (4.0 kg)/each

> Active subwoofer

Power source	AC 120 V, 60 Hz
Power consumption	120 W
Output power	400 watts minimum RMS into 6 ohms from 50 Hz to 120 Hz, 10% total harmonic distortion
Input terminals	Subwoofer input (audio signal): 200mV / 10 k ohms at 70 Hz
Speaker type	10" (25 cm) woofer
Impedance	6 ohms
Dimensions	Width: 15-3/4" (400 mm) Height: 16-9/16" (420 mm) Depth: 20-1/16" (510 mm)
Weight	47.6 lbs. (21.6 kg)

CONSUMER LIMITED WARRANTY

SHARP ELECTRONICS CORPORATION warrants to the first consumer purchaser that this Sharp brand product (the "Product"), when shipped in its original container, will be free from defective workmanship and materials, and agrees that it will, at its option, either repair the defect or replace the defective Product or part thereof with a new or remanufactured equivalent at no charge to the purchaser for parts or labor for the period(s) set forth below.

This warranty does not apply to any appearance items of the Product nor to the additional excluded item(s) set forth below nor to any Product the exterior of which has been damaged or defaced, which has been subjected to improper voltage or other misuse, abnormal service or handling, or which has been altered or modified in design or construction.

In order to enforce the rights under this limited warranty, the purchaser should follow the steps set forth below and provide proof of purchase to the servicer.

The limited warranty described herein is in addition to whatever implied warranties may be granted to purchasers by law. ALL IMPLIED WARRANTIES INCLUDING THE WARRANTIES OF MERCHANTABILITY AND FITNESS FOR USE ARE LIMITED TO THE PERIOD(S) FROM THE DATE OF PURCHASE SET FORTH BELOW. Some states do not allow limitations on how long an implied warranty lasts, so the above limitation may not apply to you.

Neither the sales personnel of the seller nor any other person is authorized to make any warranties other than those described herein, or to extend the duration of any warranties beyond the time period described herein on behalf of Sharp.

The warranties described herein shall be the sole and exclusive warranties granted by Sharp and shall be the sole and exclusive remedy available to the purchaser. Correction of defects, in the manner and for the period of time described herein, shall constitute complete fulfillment of all liabilities and responsibilities of Sharp to the purchaser with respect to the Product, and shall constitute full satisfaction of all claims, whether based on contract, negligence, strict liability or otherwise. In no event shall Sharp be liable, or in any way responsible, for any damages or defects in the Product which were caused by repairs or attempted repairs performed by anyone other than an authorized servicer. Nor shall Sharp be liable or in any way responsible for any incidental or consequential economic or property damage. Some states do not allow the exclusion of incidental or consequential damages, so the above exclusion may not apply to you.

THIS WARRANTY GIVES YOU SPECIFIC LEGAL RIGHTS. YOU MAY ALSO HAVE OTHER RIGHTS WHICH VARY FROM STATE TO STATE.

Model Specific Section

Your Product Model Number & Description:

CD-G10000 Mini Component System / CP-G10000S Speaker System

(Be sure to have this information available when you need service for your Product.)

Warranty Period for this Product:

One (1) year parts and labor from the date of purchase.

Additional Item(s) Excluded from Warranty Coverage (if any):

Non-functional accessories, supplies, and consumable items.

Where to Obtain Service:

At a Sharp Authorized Servicer located in the United States.

To find a location of the nearest Sharp Authorized Servicer, call Sharp toll free at 1-800-BE-SHARP.

What to do to Obtain Service:

Ship prepaid or carry in your Product to a Sharp Authorized Servicer.

Be sure to have **Proof of Purchase** available. If you ship the Product, be sure it is insured and packaged securely.

TO OBTAIN SUPPLY, ACCESSORY OR PRODUCT INFORMATION, CALL 1-800-BE-SHARP.

SHARP

SHARP ELECTRONICS CORPORATION

Sharp Plaza, Mahwah, New Jersey 07430-2135

SHARP CORPORATION

Printed in Malaysia

TINSEA075AWZZ

04K R YT ①

Free Manuals Download Website

<http://myh66.com>

<http://usermanuals.us>

<http://www.somanuals.com>

<http://www.4manuals.cc>

<http://www.manual-lib.com>

<http://www.404manual.com>

<http://www.luxmanual.com>

<http://aubethermostatmanual.com>

Golf course search by state

<http://golfingnear.com>

Email search by domain

<http://emailbydomain.com>

Auto manuals search

<http://auto.somanuals.com>

TV manuals search

<http://tv.somanuals.com>