

SHARP



**MODEL
SJ-TD555S**

REFRIGERATOR - FREEZER OPERATION MANUAL

CONTENTS

• WARNING	2
• CAUTION	2
• INSTALLATION	2
• DESCRIPTION	3
• WATER DISPENSER	4
• STORING FOOD	4
• CARE AND CLEANING	5
• BEFORE YOU CALL FOR SERVICE	6
• SPECIFICATION	7

**Household use only
Free standing type**

Thank you for buying this SHARP product. Before using your SHARP refrigerator, please read this operation manual to ensure that you gain the maximum benefit from it.

WARNING

- Highly volatile and flammable materials such as ether, petrol, propane gas, adhesive agents and pure alcohol etc. are liable to explode. Do not store these materials in the refrigerator.
- Dust deposited on the power plug may cause fire. Wipe it off carefully.
- Do not attempt to change or modify this refrigerator. This may result in fire, electric shock or injury.
- Ensure that the refrigerator presents no danger to children while being stored for disposal. (e.g. remove the door to prevent child entrapment.)
- This refrigerator should be disposed appropriately. Take the refrigerator to a recycling plant for flammable insulation blowing gases.

CAUTION

- Attention about Power supply:
 - Do not use an extension cord or adapter plug.
 - Make sure that the power cord has not been damaged during installation or moving. If the power plug or cord is loose, do not insert the power plug. There is a risk of electric shock or fire.
 - Disconnect from the mains electricity supply by removing the mains plug from the electricity supply socket. Do not remove by pulling the mains lead. This may cause electric shock or fire.
 - Should the flexible supply cord be damaged, it must be replaced by service agent approved by SHARP as a special cord is required.
- Do not touch the compressor unit or its peripheral parts, as they become extremely hot during operation and the metal edges may cause injury.
- Do not touch food or metal containers in the freezer compartment with wet hands. This may cause frostbite.
- Do not place bottled and canned drinks in the freezer as they may crack when frozen.
- The refrigeration system behind and inside the refrigerator contains refrigerant. If this system is punctured it could result in serious damage to your refrigerator, therefore do not allow any sharp objects to come into contact with the refrigeration system.
- In case of gas leak, ventilate the area by opening a window, etc. Do not touch the refrigerator or the power outlet.
- Do not place objects containing liquid or unsteady objects on top of refrigerator.
- This refrigerator is not intended for use by persons (including children) with reduced physical, sensory or mental capabilities, or lack of experience and knowledge, unless they have been given supervision or instruction concerning use of the refrigerator by a person responsible for their safety. Young children should be supervised to ensure that they do not play with the refrigerator.

INSTALLATION

WARNING

- Do not install the refrigerator in a damp or wet location as this may cause damage to the insulation. Condensation may also build on the outer cabinet and cause rust.

- Keep adequate ventilation space around the refrigerator.
 - The figure shows the minimum required space for installing the refrigerator. The amount of space around the refrigerator affects the amount of power consumption.
 - Insufficient spacing will decrease cooling efficiency and increase energy consumption. This may reduce the life of the unit and void warranty.

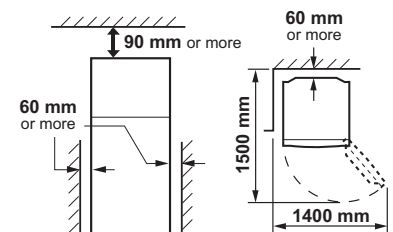

- Using the two front adjustable feet, ensure that the refrigerator is positioned firmly and level on the floor.
- Remove the 2 screws of the cabinet lower part, and use these to fit the foot covers. (supplied inside the refrigerator compartment)

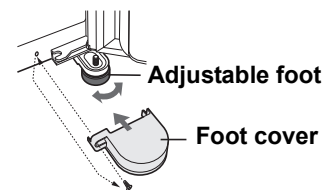

- Connect the power plug to a 230/240 volt. 10 amp. power point.

NOTE

- Position your refrigerator so that the plug is accessible.
- Keep your refrigerator out of direct sunlight.
- Do not place next to heat generating appliance.
- This refrigerator is designed for indoor use only, do not place the unit on an unsealed surface.

When transporting

- Using the casters, it is possible to move back and forth.
- Carry the refrigerator by holding the handles located on the rear and bottom.

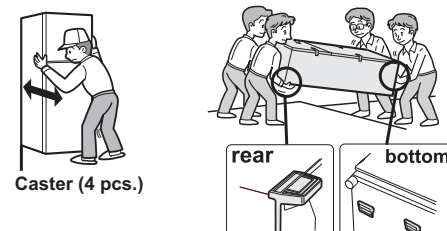

Before using your refrigerator

Clean the inside parts with a cloth soaked in warm water. If soapy water is used, wipe it off thoroughly with water.

DESCRIPTION

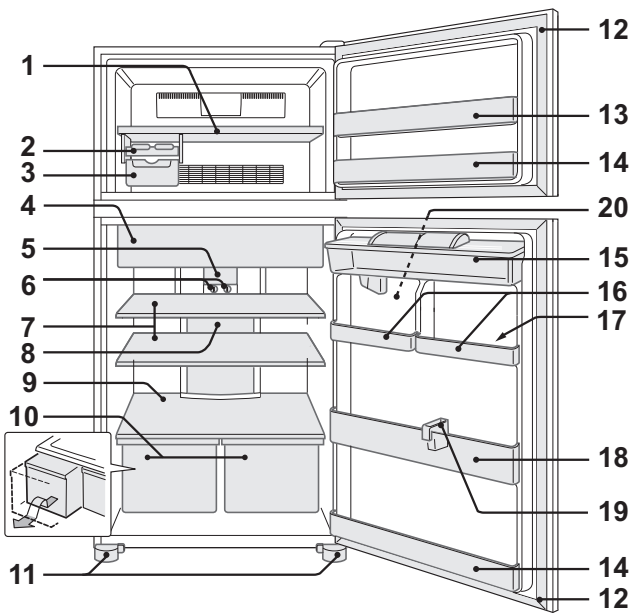

1. Freezer shelf

2. Ice cube maker

- 1) Do not over fill the Ice cube trays; otherwise the ice cubes will be joined together when frozen.
- 2) When the ice cubes are made, turn the lever clockwise to empty the ice into the Ice cube box.

Lever

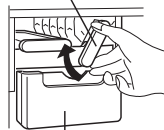

Ice cube box

NOTE To prevent damage to the Ice cube box, do not make ice in the Ice cube box.

3. Ice cube box

4. Fresh case & door

5. Refrigerator light

6. Temp. control knobs

Adjustable by turning each knob.

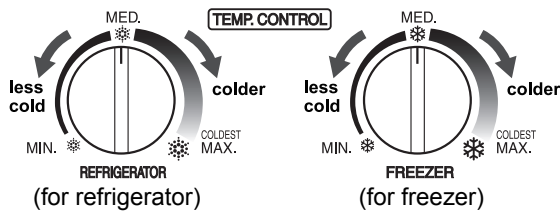

7. Refrigerator shelves (2 pcs.)

8. Hybrid cooling panel (Aluminum panel)

The panel is cooled from the rear, thus indirectly cooling the refrigerator compartment. In this way, food is refrigerated gently, without exposing it to cold air flow.

9. Fruit and vegetable crisper

10. Fruit and vegetable crisper (2 pcs.)

11. Adjustable feet & covers (2 pcs.)

12. Magnetic door seals (2 pcs.)

13. Flexible pocket

Tall food items (e.g. pizza box) can be stored by lifting the partition from the bottom of the pocket.

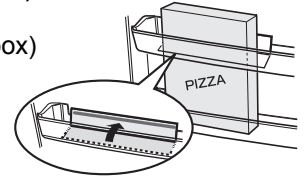

14. Door pockets (2 pcs.)

15. Water tank

16. Utility pockets (2 pcs.)

17. Egg holder

18. Bottle pocket

19. Bottle stopper / Tube stand

Prevents bottles etc. from falling. Stick-type food products can also be stored inside.

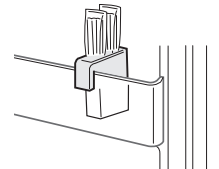

20. Water dispenser

Attach the tray included in the package.

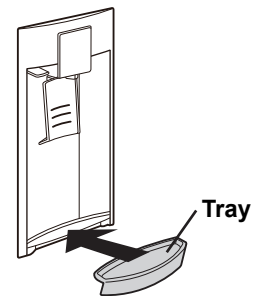

Deodorising unit

A deodorising catalyst is installed on the routes of cold air. No operation and cleaning required.

Defrosting

Defrosting is fully automatic due to a unique energy saving system.

If a refrigerator lamp blows

The lamp should only be replaced by a SHARP approved service centre.

WATER DISPENSER

How to fill the water dispenser

WARNING

■ Fill with potable water only.

- 1 To open or close slide the lid of the water tank as shown. Ensure that the lid is shut after filling to prevent spillage. Do not overfill.

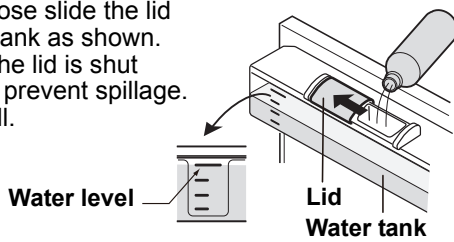

NOTE

- Do not open or close the door with force. Water may spill from the water tank.
- Only fill with water. If other liquid such as juice is poured in, it might cause a failure. (Do not fill with hot water. Maximum temperature is approximately 50°C)

How to dispense water

- 1 Push the lever with a glass to dispense water. Move the glass slowly away from the lever. (The lever returns to the original position, and water stops.)



NOTE

- For hygienic reasons, replace the water in the water tank approximately once a week.
- Frequently empty spillage from tray.
- If the water dispenser is not used for an extended period of time, clean and dry the water tank thoroughly, and attach it to the original position.

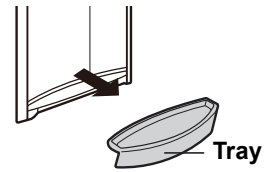

Child lock

The water dispenser can be locked. Use this feature to prevent children or someone from tampering with the dispenser.

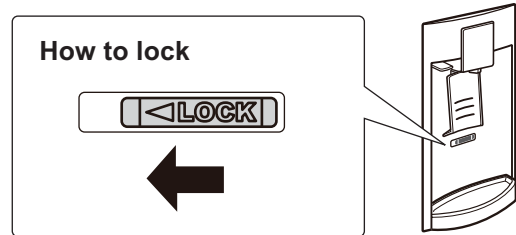

STORING FOOD

Refrigeration reduces the rate of food spoilage. To maximise the shelf life of perishable food products, ensure that the food is the freshest possible quality. The following is a general guide to help promote longer food storage.

- Ensure all cooked food is wrapped securely or placed in an airtight container.
- To minimise spoilage, fruit and vegetables should be loosely enclosed in a plastic material e.g. wrap, bags (do not seal) and place in the fruit and vegetable crisper.
- Eggs should be stored in the Egg holder.
- Evenly place the food on the shelves to allow the cooling air to circulate efficiently.
- Hot foods should be cooled before storing. Storing hot foods increases the temperature in the unit and increases the risk of food spoilage.
- Do not block the outlet and inlet of the cool air circulating system with food or containers; otherwise the food will not be evenly cooled throughout the refrigerator.
- Keep the door securely closed.

For best freezing

- Quality of food should be fresh.
- Freeze small quantities of food at a time to freeze them quickly.
- Food should be properly stored or covered and the air should be removed to seal tightly.
- Evenly place the food in the freezer.
- Label bags or containers to keep an inventory of freezing food.

← IN
→ OUT

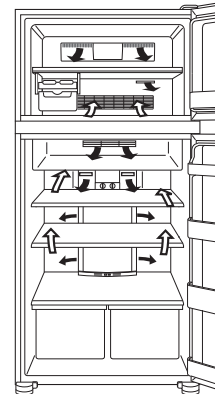

Do not place food directly in front of cold air outlet. This may lead to the food freezing.

CARE AND CLEANING

WARNING

- **Unplug the refrigerator first to prevent electric shock.**
- **Do not splash water directly on the outer cabinet or the interior. This may lead to rusting and deterioration of the electrical insulation.**

IMPORTANT

To prevent cracking on inside surfaces and plastic components, follow these tips:

- Wipe any food oils adhered to plastic components.
- Some household chemicals may cause damage, so use only diluted washing-up liquid (soapy water).
- If undiluted detergent is used or soapy water is not wiped off thoroughly, cracking of plastic parts can result.
- Wipe any spills from the refrigerator immediately, as acid or alkaline in the food can cause cracking and staining of plastic parts.

- 1** Remove the accessories e.g. shelves from the cabinet and door. Wash them in warm soapy dishwashing water; rinse in clean water and dry. (Only fruit and vegetable shelf is not removable.)
- 2** Clean the inside with a cloth soaked in warm soapy dishwashing water. Then, use cold water to wipe off soapy water.
- 3** Wipe the exterior with a soft cloth each time it is soiled.
- 4** Clean the magnetic door seal with a toothbrush and warm soapy dishwashing water.

NOTE

- Do not use hot water, household cleaning powders, creams or spray-on cleaning products, or any other cleaning products such as mineral turpentine, methylated spirits, thinners, petrol etc. These may damage your refrigerator and may void any warranty.
- If the power supply is disconnected, please wait for at least 5 minutes before re-connecting power.
- The glass shelves weigh approximately 3 kg each. Hold firmly when removing from the cabinet or carrying.
- Do not drop objects inside the refrigerator or strike the inner wall. This may cause the inner surface to crack.

How to remove the water tank

(Cleaning once a month is recommended.)

- 1** Push the lever and let out all water in the water tank.
- 2** Remove the pipe cover. Disconnect the both ends of the joint pipe.

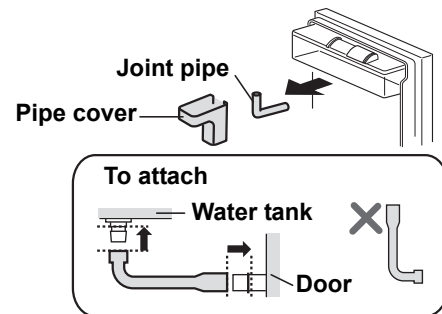

- 3** Remove the water tank from the door.

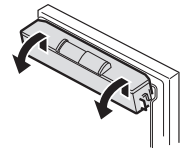

- 4** Remove the cover and take out the mesh filter.

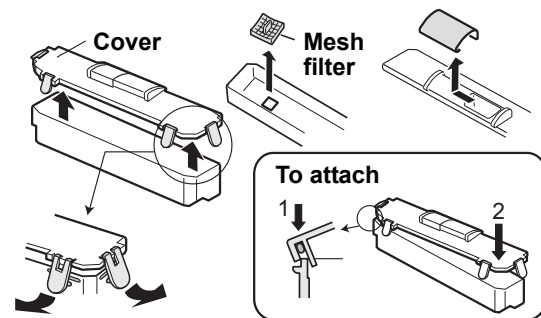

NOTE

Ensure that all parts are reassembled. Incorrect assembly may cause water leakage.

Switching off your refrigerator

If the refrigerator needs to be switched off for an extended period, the following steps should be taken to reduce the symptom of mould:

- 1.** Remove all food.
- 2.** Remove the power plug from the power point.
- 3.** Clean and dry the interior thoroughly.
- 4.** Ensure that all the doors are wedged open slightly for air circulation.

BEFORE YOU CALL FOR SERVICE

Before you call for service, check the following points.

Problem	Solution
The outside of the cabinet is hot when touched.	This is normal. The hot pipe is in the cabinet in order to prevent condensation generation.
When there is refrigerator noise.	It is normal for the refrigerator to produce the following sounds: <ul style="list-style-type: none"> • Loud noise produced by the compressor when operation starts --- Sound becomes quieter after a while. • Loud noise produced once a day by the compressor --- Operating sound produced immediately after automatic defrost operation. • Sound of flowing fluid (gurgling sound, fizzing sound) --- Sound of refrigerant flowing in pipes (sound may become louder from time to time). • Cracking or crunching sound, squeaking sound --- Sound produced by expansion and contraction of inner walls and internal parts during cooling.
Frosting or condensation generation occurs inside or outside the refrigerator.	This may occur in one of the following cases. Use a wet cloth for wiping frost and a dry cloth for wiping condensation. <ul style="list-style-type: none"> • When the ambient humidity is high. • When the door is frequently opened and closed. • When food containing plenty of moisture is stored. (Wrapping is required.)
The foods in the refrigerator compartment freeze.	<ul style="list-style-type: none"> • Is the refrigerator operated for a long time with temp. control set at MAX? • Low ambient temperature may cause food to freeze even if refrigerator temp. control is set to MIN.
Noticeable odours.	<ul style="list-style-type: none"> • Wrapping is required for food with strong odours. • Deodorising unit cannot remove all of the odours.

If you still require service contact your SHARP Approved Service Centre.

SHARP Approved Service Centre locations can be found in the Support area of our website:

Australia : <http://www.sharp.net.au>

New Zealand : <http://www.sharp.net.nz>

SPECIFICATION

		SJ-TD555S
Rated voltage (V~)		230 - 240
Rated frequency (Hz)		50
Rated current (A)		0.53 - 0.54
Rated input of heating systems (W)		160 - 170
Defrosting input (W)		160 - 170
Internal lamp input (W)		15 max.
Climate class		T
Refrigerant		HFC - 134a
Charge (g)		110
Insulation blowing gas		Cyclo pentane
Rated storage volume (L)		514
Rated gross volume (L)		555
Group (AS / NZS 4474.1)		5T
Net weight (kg)		81
Outer dimensions (mm)	Height	1670
	Width	800
	Depth (Including the handle)	720 (725)

If further depth reduction is required for site access/installation, the doors can be removed to reduce the overall depth from 725 mm to 635 mm. Only a SHARP Approved Service Centre can perform removal and replacement of the doors. The customer should obtain an estimate from a SHARP Approved Service Centre prior to purchase.

SHARP

SHARP CORPORATION OF AUSTRALIA PTY.LTD.

A. B. N. 40 003 039 405

1 HUNTINGWOOD DRIVE, HUNTINGWOOD, N.S.W. 2148

P.O.BOX 6827, BLACKTOWN. N.S.W. 2148

SHARP CORPORATION OF NEW ZEALAND LIMITED

59 HUGO JOHNSTON DRIVE PENROSE, AUCKLAND

Printed in Thailand

TINS-B059CBRZ 09JK (TH) ①

Free Manuals Download Website

<http://myh66.com>

<http://usermanuals.us>

<http://www.somanuals.com>

<http://www.4manuals.cc>

<http://www.manual-lib.com>

<http://www.404manual.com>

<http://www.luxmanual.com>

<http://aubethermostatmanual.com>

Golf course search by state

<http://golfingnear.com>

Email search by domain

<http://emailbydomain.com>

Auto manuals search

<http://auto.somanuals.com>

TV manuals search

<http://tv.somanuals.com>