

# SHARP®

## OPERATION MANUAL MODEL PG-B10S



### LCD PROJECTOR



香港電器安全規格  
(國際電工委員會規格適合)

Introduction

Basic Operation

Projection

Functions

Using the Menu

Connections

Screen Setup

Appendix

## IMPORTANT

For your assistance in reporting the loss or theft of your Projector, please record the Serial Number located on the bottom of the projector and retain this information. Before recycling the packaging, please be sure that you have checked the contents of the carton thoroughly against the list of "Supplied accessories" on page 9.

**Model No.: PG-B10S**

**Serial No.:**

This equipment complies with the requirements of Directives 89/336/EEC and 73/23/EEC as amended by 93/68/EEC.

Dieses Gerät entspricht den Anforderungen der EG-Richtlinien 89/336/EWG und 73/23/EWG mit Änderung 93/68/EWG.

Ce matériel répond aux exigences contenues dans les directives 89/336/CEE et 73/23/CEE modifiées par la directive 93/68/CEE.

Dit apparaat voldoet aan de eisen van de richtlijnen 89/336/EEG en 73/23/EEG, gewijzigd door 93/68/EEG.

Dette udstyr overholder kravene i direktiv nr. 89/336/EEC og 73/23/EEC med tillæg nr. 93/68/EEC.

Quest' apparecchio è conforme ai requisiti delle direttive 89/336/EEC e 73/23/EEC, come emendata dalla direttiva 93/68/EEC.

Η εγκατάσταση αυτή ανταποκρίνεται στις απαιτήσεις των οδηγιών της Ευρωπαϊκής Ένωσης 89/336/ΕΟΚ και 73/23/ΕΟΚ, όπως οι κανονισμοί αυτοί συμπληρώθηκαν από την οδηγία 93/68/ΕΟΚ.

Este equipamento obedece às exigências das directivas 89/336/CEE e 73/23/CEE, na sua versão corrigida pela directiva 93/68/CEE.



Este aparato satisface las exigencias de las Directivas 89/336/CEE y 73/23/CEE, modificadas por medio de la 93/68/CEE.

Denna utrustning uppfyller kraven enligt riktlinjerna 89/336/EEC och 73/23/EEC så som kompletteras av 93/68/EEC.

Dette produktet oppfyller betingelsene i direktivene 89/336/EEC og 73/23/EEC i endringen 93/68/EEC.

Tämä laite täyttää direktiivien 89/336/EEC ja 73/23/EEC vaatimukset, joita on muutettu direktiivillä 93/68/EEC.

**SPECIAL NOTE FOR USERS IN THE U.K.**

The mains lead of this product is fitted with a non-rewireable (moulded) plug incorporating a 5A fuse. Should the fuse need to be replaced, a BSI or ASTA approved BS 1362 fuse marked  or  and of the same rating as above, which is also indicated on the pin face of the plug, must be used.

Always refit the fuse cover after replacing the fuse. Never use the plug without the fuse cover fitted.

In the unlikely event of the socket outlet in your home not being compatible with the plug supplied, cut off the mains plug and fit an appropriate type.

**DANGER:**

The fuse from the cut-off plug should be removed and the cut-off plug destroyed immediately and disposed of in a safe manner.

Under no circumstances should the cut-off plug be inserted elsewhere into a 5A socket outlet, as a serious electric shock may occur.

To fit an appropriate plug to the mains lead, follow the instructions below:

**WARNING:**

THIS APPARATUS MUST BE EARTHED.

**IMPORTANT:**

The wires in this mains lead are coloured in accordance with the following code:

Green-and-yellow : Earth  
Blue : Neutral  
Brown : Live

As the colours of the wires in the mains lead of this apparatus may not correspond with the coloured markings identifying the terminals in your plug proceed as follows:

- The wire which is coloured green-and-yellow must be connected to the terminal in the plug which is marked by the letter E or by the safety earth symbol  or coloured green or green-and-yellow.
- The wire which is coloured blue must be connected to the terminal which is marked with the letter N or coloured black.
- The wire which is coloured brown must be connected to the terminal which is marked with the letter L or coloured red.

IF YOU HAVE ANY DOUBT, CONSULT A QUALIFIED ELECTRICIAN.

The supplied CD-ROM contains operation instructions in English, German, French, Swedish, Spanish, Italian, Dutch, Portuguese, Chinese (Traditional Chinese and Simplified Chinese) and Korean. Carefully read through the operation instructions before operating the projector.

Die mitgelieferte CD-ROM enthält Bedienungsanleitungen in Englisch, Deutsch, Französisch, Schwedisch, Spanisch, Italienisch, Niederländisch, Portugiesisch, Chinesisch (Traditionelles Chinesisch und einfaches Chinesisch) und Koreanisch. Bitte lesen Sie die Bedienungsanleitung vor der Verwendung des Projektors sorgfältig durch.

Le CD-ROM fourni contient les instructions de fonctionnement en anglais, allemand, français, suédois, espagnol, italien, néerlandais, portugais, chinois (chinois traditionnel et chinois simplifié) et coréen. Veuillez lire attentivement ces instructions avant de faire fonctionner le projecteur.

Den medföljande CD-ROM-skivan innehåller bruksanvisningar på engelska, tyska, franska, svenska, spanska, italienska, holländska, portugisiska, kinesiska (traditionell kinesiska och förenklad kinesiska) och koreanska. Läs noga igenom bruksanvisningen innan projektorn tas i bruk.

El CD-ROM suministrado contiene instrucciones de operación en inglés, alemán, francés, sueco, español, italiano, holandés, portugués, chino (chino tradicional y chino simplificado) y coreano. Lea cuidadosamente las instrucciones de operación antes de utilizar el proyector.

Il CD-ROM in dotazione contiene istruzioni per l'uso in inglese, tedesco, francese, svedese, spagnolo, italiano, olandese, portoghese, cinese (cinese tradizionale e cinese semplificato) e coreano. Leggere attentamente le istruzioni per l'uso prima di usare il proiettore.

De meegeleverde CD-ROM bevat handleidingen in het Engels, Duits, Frans, Zweeds, Spaans, Italiaans, Nederlands, Portugees, Chinees (Traditioneel Chinees en Vereenvoudigd Chinees) en Koreaans. Lees de handleiding zorgvuldig door voor u de projector in gebruik neemt.

O CD-ROM fornecido contém instruções de operação em Inglês, Alemão, Francês, Sueco, Espanhol, Italiano, Holandês, Português, Chinês, (Chinês Tradicional e Chinês Simplificado) e Coreano. Leia cuidadosamente todas as instruções de operação antes de operar o projetor.

附送之CD-ROM光碟中，有用英文、德文、法文、瑞典文、西班牙文、意大利文、荷蘭文、葡萄牙文、中文（繁體中文和簡體中文）和韓國文所寫的使用說明書。在操作本投影機之前，請務必仔細閱讀整本使用說明書。

附送之CD-ROM光碟中，有用英文、德文、法文、瑞典文、西班牙文、意大利文、荷兰文、葡萄牙文、中文（繁体中文和简体中文）和韩国文所写的使用说明书。在操作本投影机之前，请务必仔细阅读整本使用说明书。

제공된 CD-ROM에는 영어, 독일어, 프랑스어, 스웨덴어, 스페인어, 이탈리아어, 네덜란드어, 포르투갈어, 중국어(번체자와 간체자), 그리고 한국어로 작성된 조작 설명서가 포함되어 있습니다. 프로젝터를 조작하기 전에 조작 지침을 상세하게 숙지하십시오.

Before using the projector, please read this operation manual carefully.

# Introduction

ENGLISH

There are two important reasons for prompt warranty registration of your new SHARP Projector, using the REGISTRATION CARD packed with the projector.

## 1. WARRANTY

This is to assure that you immediately receive the full benefit of the parts, service and labor warranty applicable to your purchase.

## 2. CONSUMER PRODUCT SAFETY ACT

To ensure that you will promptly receive any safety notification of inspection, modification, or recall that SHARP may be required to give under the 1972 Consumer Product Safety Act, PLEASE READ CAREFULLY THE IMPORTANT "LIMITED WARRANTY" CLAUSE.



U.S.A. ONLY

**WARNING:** High brightness light source. Do not stare into the beam of light, or view directly. Be especially careful that children do not stare directly into the beam of light.



**WARNING:** To reduce the risk of fire or electric shock, do not expose this product to rain or moisture.

See bottom of projector.

	<b>CAUTION</b> RISK OF ELECTRIC SHOCK. DO NOT REMOVE SCREWS EXCEPT SPECIFIED USER SERVICE SCREW.	
<b>CAUTION: TO REDUCE THE RISK OF ELECTRIC SHOCK, DO NOT REMOVE COVER. NO USER-SERVICEABLE PARTS EXCEPT LAMP UNIT. REFER SERVICING TO QUALIFIED SERVICE PERSONNEL.</b>		



The lightning flash with arrowhead symbol, within an equilateral triangle, is intended to alert the user to the presence of uninsulated "dangerous voltage" within the product's enclosure that may be of sufficient magnitude to constitute a risk or electric shock to persons.



The exclamation point within a triangle is intended to alert the user to the presence of important operating and maintenance (servicing) instructions in the literature accompanying the product.

**WARNING:** FCC Regulations state that any unauthorized changes or modifications to this equipment not expressly approved by the manufacturer could void the user's authority to operate this equipment.

U.S.A. ONLY

## INFORMATION

This equipment has been tested and found to comply with the limits for a Class A digital device, pursuant to Part 15 of the FCC Rules. These limits are designed to provide reasonable protection against harmful interference when the equipment is operated in a commercial environment. This equipment generates, uses, and can radiate radio frequency energy and, if not installed and used in accordance with the operation manual, may cause harmful interference to radio communications. Operation of this equipment in a residential area is likely to cause harmful interference, in which case the user will be required to correct the interference at his own expense.

U.S.A. ONLY

The enclosed computer cable must be used with the device. The cable is provided to ensure that the device complies with FCC Class A verification.

U.S.A. ONLY

## WARNING:

This is a Class A product. In a domestic environment this product may cause radio interference in which case the user may be required to take adequate measures.

## WARNING:

The cooling fan in this projector continues to run for about 90 seconds after the projector enters the standby mode. During normal operation, when putting the projector into the standby mode always use the STANDBY button on the projector or on the remote control. Ensure the cooling fan has stopped before disconnecting the power cord. DURING NORMAL OPERATION, NEVER TURN THE PROJECTOR OFF BY DISCONNECTING THE POWER CORD. FAILURE TO OBSERVE THIS WILL RESULT IN PREMATURE LAMP FAILURE.

## PRODUCT DISPOSAL

This projector utilizes tin-lead solder, and a pressurized lamp containing a small amount of mercury. Disposal of these materials may be regulated due to environmental considerations. For disposal or recycling information, please contact your local authorities or, if you are located in the United States of America, the Electronic Industries Alliance: [www.eiae.org](http://www.eiae.org).

## Caution Concerning Lamp Replacement

See "Replacing the Lamp" on page 65.

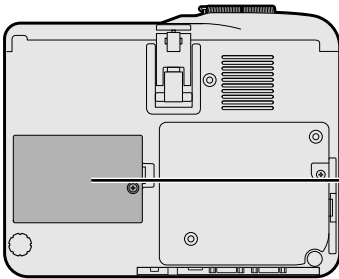

### LAMP REPLACEMENT CAUTION

BEFORE REMOVING THE SCREW, DISCONNECT POWER CORD. HOT SURFACE INSIDE. ALLOW 1 HOUR TO COOL BEFORE REPLACING THE LAMP. REPLACE WITH SAME SHARP LAMP UNIT TYPE BQC-PGB10S/1 ONLY.  
UV RADIATION : CAN CAUSE EYE DAMAGE. TURN OFF LAMP BEFORE SERVICING.  
HIGH PRESSURE LAMP : RISK OF EXPLOSION. POTENTIAL HAZARD OF GLASS PARTICLES IF LAMP HAS RUPTURED. HANDLE WITH CARE. SEE OPERATION MANUAL.



### PRECAUTIONS A OBSERVER LORS DU REMPLACEMENT DE LA LAMPE.

DEBRANCHER LE CORDON D'ALIMENTATION AVANT DE RETIRER LA VIS. L'INTERIEUR DU BOITIER ETANT EXTREMEMENT CHAUD, ATTENDRE 1 HEURE AVANT DE PROCEDER AU REMPLACEMENT DE LA LAMPE.  
NE REMPLACER QUE PAR UNE LAMPE SHARP DE TYPE BQC-PGB10S/1.  
RAYONS ULTRAVIOLETS : PEUVENT ENDOMMAGER LES YEUX. ETEINDRE LA LAMPE AVANT DE PROCEDER A L'ENTRETIEN.  
LAMPE A HAUTE PRESSION : RISQUE D'EXPLOSION. DANGER POTENTIEL DE PARTICULES DE VERRE EN CAS D'ECLATEMENT DE LA LAMPE. A MANIPULER AVEC PRECAUTION, SE REPORTER AU MODE D'EMPLOI.

This SHARP projector uses an LCD (Liquid Crystal Display) panel. This very sophisticated panel contains 480,000 pixels (x RGB) TFTs (Thin Film Transistors). As with any high technology electronic equipment such as large screen TVs, video systems and video cameras, there are certain acceptable tolerances that the equipment must conform to.

This unit has some inactive pixels within acceptable tolerances which may result in inactive dots on the picture screen. This will not affect the picture quality or the life expectancy of the unit.

## When Attaching the "QUICK GUIDE" Label

Attaching the "QUICK GUIDE" Label (supplied) on the projector will help you check the setup procedure. Be sure to attach the "QUICK GUIDE" Label on the top cabinet of the projector as shown in the drawing on the right. Do not attach the "QUICK GUIDE" Label anywhere else to avoid blocking an air intake or exhaust vent.

"QUICK GUIDE"  
Label

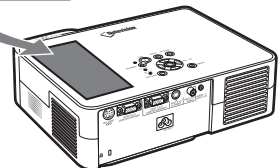

- Microsoft and Windows are registered trademarks of Microsoft Corporation in the United States and/or other countries.
- PC/AT is a registered trademark of International Business Machines Corporation in the United States.
- Adobe Acrobat is a trademark of Adobe Systems Incorporated.
- Macintosh is a registered trademark of Apple Computer, Inc. in the United States and/or other countries.
- All other company or product names are trademarks or registered trademarks of their respective companies.

# How to Read this Operation Manual

- In this operation manual, the illustration and the screen display are simplified for explanation, and may differ slightly from actual display.

## Using the Menu Screen

The menu screens allow you to adjust the image and various projector settings. The menu can be operated to achieve two functions, adjustment and setting. (For adjusting the menu items, see pages 32 and 33. For setting the menu items, see pages 34 and 35.)

Example: "Picture" menu screen for INPUT 1 (RGB) mode

On-screen display

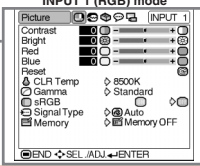

Buttons used in this operation

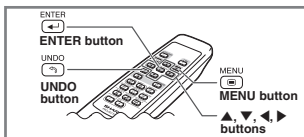



### Menu Selections (Adjustments)

- The following procedure is the operating method in an adjustment menu.
- This operation can also be performed by using the buttons on the projector.





- 1 Press .

  - The "Picture" menu screen for the selected input mode is displayed.

**Note**

  - The on-screen display shown on the right is displayed when the INPUT 1 (RGB) mode is selected.
- 2 Press  or  to display the other menu screens.

  - The menu icon for the selected menu screen is highlighted.

Menu icon	Menu screen
	Picture
	Fine Sync
	Options
	Language
	PRJ Mode

**Note**

  - The "Fine Sync" menu is not available for INPUT 2 or 3.
  - For items on the menus, see the tree charts on pages 30 and 31.

Button used in this step

Buttons used in this operation

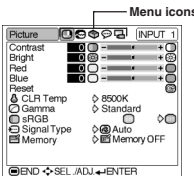

©-32

 **Info** .....Indicates safeguards when using the projector.

 **Note** .....Indicates additional information on setup and operation.

## For Future Reference

Maintenance

➔ **Page 60**

Troubleshooting

➔ **Pages 71 and 72**

Glossary

➔ **Page 76**

# Contents

## Introduction

<b>How to Read this Operation Manual</b> .....	<b>3</b>
<b>Contents</b> .....	<b>4</b>
<b>IMPORTANT SAFEGUARDS</b> .....	<b>6</b>
<b>How to Access the PDF Operation Manuals</b> .....	<b>8</b>
<b>Accessories</b> .....	<b>9</b>
<b>Part Names</b> .....	<b>10</b>
Projector (Front and Top View) .....	10
About the Indicators on the Projector .....	11
Projector (Rear View) .....	12
INPUT/OUTPUT Terminals and Connectable Main Equipment .....	13
Remote Control (Front View) .....	14
<b>Using the Remote Control</b> .....	<b>15</b>
Usable Range .....	15
Inserting the Batteries .....	15

## Basic Operation

<b>Setup and Projection</b> .....	<b>16</b>
-----------------------------------	-----------

## Projection

<b>Image Projection</b> .....	<b>18</b>
Turning the Projector on .....	18
Switching the INPUT Mode .....	19
Adjusting the Volume .....	19
Displaying the Black Screen and Turning off the Sound Temporarily .....	20
Correcting Trapezoidal Distortion .....	20
Turning the Power off (Putting the Projector into the Standby Mode) .....	21
Adjusting the Lens .....	22
Using the Adjustment Feet .....	23
<b>Variable Lens Shift Feature</b> .....	<b>24</b>
Adjusting the Projected Image Position .....	25

## Functions

<b>Resize Mode</b> .....	<b>26</b>
Switching the Resize Mode .....	26
<b>Freeze and Enlarge Image</b> .....	<b>28</b>
Freezing a Moving Image .....	28
Displaying an Enlarged Portion of an Image .....	28
<b>Keylock Function</b> .....	<b>29</b>
Locking the Operation Buttons .....	29
Taking the Keylock off .....	29

## Using the Menu

<b>Menu Items</b> .....	<b>30</b>
<b>Using the Menu Screen</b> .....	<b>32</b>
Menu Selections (Adjustments) .....	32
Menu Selections (Settings) .....	34
<b>Picture Adjustment</b> .....	<b>36</b>
Adjusting the Image .....	36
CLR Temp (Adjusting the Color Temperature) .....	36
Gamma (Gamma Correction) .....	37
sRGB (sRGB Setting) .....	37
Signal Type (Signal Type Setting) .....	38
Memory (Storing and Selecting the Adjustment Settings) .....	38
<b>Computer Image Adjustment</b> .....	<b>39</b>
Adjusting the Computer Image .....	39
Special Modes (Special Mode Settings) .....	39
Auto Sync (Auto Sync Adjustment) .....	40
Signal Info (Checking the Input Signal) .....	40
<b>Using the “Options” Menu</b> .....	<b>41</b>
Lamp Timer (Life) (Checking the Lamp Life Status) .....	41
OSD Display (Setting On-screen Display) .....	41
Video System (Setting the Video System) .....	42
Background (Selecting a Startup and Background Image) .....	42
Eco Mode (Setting the Eco Mode) .....	43
Auto Power Off (Auto Power Off Function) .....	43
Menu Position (Selecting the Menu Screen Position) .....	44
Menu Color (Selecting the Menu Color) .....	44
Password (Setting a Password) .....	45
If You Forget Your Password .....	45
Anti-Theft (Setting the Anti-Theft) .....	46
<b>Using the “Language” Menu</b> .....	<b>48</b>
Selecting the On-screen Display Language .....	48
<b>Using the “PRJ Mode” Menu</b> .....	<b>49</b>
Reversing the Projected Image .....	49



## Connections

<b>Connecting the Projector to Other Devices ...</b>	<b>50</b>
Before Connecting .....	50
This projector can be connected to: .....	50
Connecting the Projector to a Computer .....	51
Connecting to Video Equipment .....	52
Controlling the Projector Using a Computer .....	54
Connecting to a Monitor .....	55
Connecting the Power Cord to the Projector .....	55

## Screen Setup

<b>Setting up the Screen .....</b>	<b>56</b>
Screen Size and Projection Distance .....	57
Projecting a Reversed Image .....	58

## Appendix

<b>Carrying the Projector .....</b>	<b>59</b>
How to Use the Carrying Case .....	59
<b>Maintenance .....</b>	<b>60</b>
<b>Replacing the Air Filter .....</b>	<b>61</b>
Cleaning and Replacing the Air Filter .....	61
<b>Maintenance Indicators .....</b>	<b>63</b>
<b>Regarding the Lamp .....</b>	<b>65</b>
Lamp .....	65
Caution Concerning the Lamp .....	65
Replacing the Lamp .....	65
Removing and Installing the Lamp Unit .....	66
Resetting the Lamp Timer .....	67
<b>Connecting Pin Assignments .....</b>	<b>68</b>
<b>RS-232C Specifications and</b>	
<b>Command Settings .....</b>	<b>69</b>
<b>Computer Compatibility Chart .....</b>	<b>70</b>
<b>Troubleshooting .....</b>	<b>71</b>
<b>For SHARP Assistance .....</b>	<b>73</b>
<b>Specifications .....</b>	<b>74</b>
<b>Dimensions .....</b>	<b>75</b>
<b>Glossary .....</b>	<b>76</b>
<b>Index .....</b>	<b>77</b>

# IMPORTANT SAFEGUARDS

**CAUTION:** Please read all of these instructions before you operate this product and save these instructions for later use.

Electrical energy can perform many useful functions. This product has been engineered and manufactured to assure your personal safety. BUT IMPROPER USE CAN RESULT IN POTENTIAL ELECTRICAL SHOCK OR FIRE HAZARDS. In order not to defeat the safeguards incorporated in this product, observe the following basic rules for its installation, use and servicing.

## 1. Read Instructions

All the safety and operating instructions should be read before the product is operated.

## 2. Retain Instructions

The safety and operating instructions should be retained for future reference.

## 3. Heed Warnings

All warnings on the product and in the operating instructions should be adhered to.

## 4. Follow Instructions

All operating and use instructions should be followed.

## 5. Cleaning

Unplug this product from the wall outlet before cleaning. Do not use liquid cleaners or aerosol cleaners. Use a damp cloth for cleaning.

## 6. Attachments

Do not use attachments not recommended by the product manufacturer as they may cause hazards.

## 7. Water and Moisture

Do not use this product near water—for example, near a bath tub, wash bowl, kitchen sink, or laundry tub; in a wet basement; or near a swimming pool; and the like.

## 8. Accessories

Do not place this product on an unstable cart, stand, tripod, bracket, or table. The product may fall, causing serious injury to a child or adult, and serious damage to the product. Use only with a cart, stand, tripod, bracket, or table recommended by the manufacturer, or sold with the product. Any mounting of the product should follow the manufacturer's instructions, and should use a mounting accessory recommended by the manufacturer.

## 9. Transportation

A product and cart combination should be moved with care. Quick stops, excessive force, and uneven surfaces may cause the product and cart combination to overturn.



## 10. Ventilation

Slots and openings in the cabinet are provided for ventilation to ensure reliable operation of the product and to protect it from overheating, and these openings must not be blocked or covered. The openings should never be blocked by placing the product on a bed, sofa, rug, or other similar surface. This product should not be placed in a built-in installation such as a bookcase or rack unless proper ventilation is provided or the manufacturer's instructions have been adhered to.

## 11. Power Sources

This product should be operated only from the type of power source indicated on the marking label. If you are not sure of the type of power supply to your home, consult your product dealer or local power company. For products intended to operate from battery power, or other sources, refer to the operating instructions.

## 12. Grounding or Polarization

This product is provided with one of the following types of plugs. If the plug should fail to fit into the power outlet, please contact your electrician.

Do not defeat the safety purpose of the plug.

- Two-wire type (mains) plug.
- Three-wire grounding type (mains) plug with a grounding terminal.  
This plug will only fit into a grounding type power outlet.

## 13. Power-Cord Protection

Power-supply cords should be routed so that they are not likely to be walked on or pinched by items placed upon or against them, paying particular attention to cords at plugs, convenience receptacles, and the point where they exit from the product.

## 14. Lightning

For added protection for this product during a lightning storm, or when it is left unattended and unused for long periods of time, unplug it from the wall outlet and disconnect the cable system. This will prevent damage to the product due to lightning and power-line surges.

## 15. Overloading

Do not overload wall outlets, extension cords, or integral convenience receptacles as this can result in a risk of fire or electric shock.

## 16. Object and Liquid Entry

Never push objects of any kind into this product through openings as they may touch dangerous voltage points or short-out parts that could result in a fire or electric shock. Never spill liquid of any kind on the product.

## 17. Servicing

Do not attempt to service this product yourself as opening or removing covers may expose you to dangerous voltage or other hazards. Refer all servicing to qualified service personnel.

## 18. Damage Requiring Service

Unplug this product from the wall outlet and refer servicing to qualified service personnel under the following conditions:

- When the power-supply cord or plug is damaged.
- If liquid has been spilled, or objects have fallen into the product.
- If the product has been exposed to rain or water.
- If the product does not operate normally by following the operating instructions. Adjust only those controls that are covered by the operating instructions, as an improper adjustment of other controls may result in damage and will often require extensive work by a qualified technician to restore the product to normal operation.
- If the product has been dropped or damaged in any way.
- When the product exhibits a distinct change in performance, this indicates a need for service.

## 19. Replacement Parts

When replacement parts are required, be sure the service technician has used replacement parts specified by the manufacturer or have the same characteristics as the original part. Unauthorized substitutions may result in fire, electric shock, or other hazards.

## 20. Safety Check

Upon completion of any service or repairs to this product, ask the service technician to perform safety checks to determine that the product is in proper operating condition.

## 21. Wall or Ceiling Mounting

This product should be mounted to a wall or ceiling only as recommended by the manufacturer.

## 22. Heat

This product should be situated away from heat sources such as radiators, heat registers, stoves, or other products (including amplifiers) that produce heat.

## Be sure to read the following safeguards when setting up your projector.

### Caution concerning the lamp unit

- Potential hazard of glass particles if lamp ruptures. In case of lamp rupture, contact your nearest Sharp Authorized Projector Dealer or Service Center for a replacement.

See "Replacing the Lamp" on page 65.

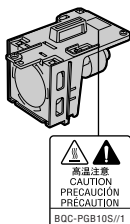

### Caution concerning the setup of the projector

- For minimal servicing and to maintain high image quality, SHARP recommends that this projector be installed in an area free from humidity, dust and cigarette smoke. When the projector is subjected to these environments, the lens must be cleaned more often. As long as the projector is regularly cleaned, use in these environments will not reduce the overall operation life of the unit. Internal cleaning should only be performed by a Sharp Authorized Projector Dealer or Service Center.

### Do not set up the projector in places exposed to direct sunlight or bright light.

- Position the screen so that it is not in direct sunlight or room light. Light falling directly on the screen washes out the colors, making viewing difficult. Close the curtains and dim the lights when setting up the screen in a sunny or bright room.

### The projector may be safely tilted to a maximum angle of 12 degrees.

- Placement should be within  $\pm 12$  degrees of horizontal.



### Do not subject the projector to hard impact and/or vibration.

- Take care with the lens so as not to hit or damage the surface of the lens.

### Rest your eyes occasionally.

- Continuously watching the screen for long hours will cause eye strain. Be sure to occasionally rest your eyes.

### Avoid locations with extremes of temperature.

- The operating temperature of the projector is from 41°F to 95°F (+5°C to +35°C).
- The storage temperature of the projector is from -4°F to 140°F (-20°C to +60°C).

### Do not block the exhaust and intake vents.

- Allow at least 7 <sup>7</sup>/<sub>8</sub> inches (20 cm) of space between the exhaust vent and the nearest wall or obstruction.
- Be sure that the intake vent and the exhaust vent are not obstructed.

- If the cooling fan becomes obstructed, a protection circuit will automatically put the projector into the standby mode. This does not indicate a malfunction. Remove the projector power cord from the wall outlet and wait at least 10 minutes. Place the projector where the intake and exhaust vents are not blocked, plug the power cord back in and turn on the projector. This will return the projector to the normal operating condition.

### Caution regarding transportation of the projector

- When transporting the projector, be sure not to subject it to hard impact and/or vibration, as this can result in damage. Take extra care with the lens. Before moving the projector, be sure to unplug the power cord from the wall outlet, and disconnect any other cables connected to it.
- Do not carry the projector by holding the lens.
- When transporting the projector, be sure to attach the lens shipping block and the lens cap to the projector.

### Other connected equipment

- When connecting a computer or other audio-visual equipment to the projector, make the connections AFTER unplugging the power cord of the projector from the AC outlet and turning off the equipment to be connected.
- Please read the operation manuals of the projector and the equipment to be connected for instructions on how to make the connections.

### Using the projector in other countries

- The power supply voltage and the shape of the plug may vary depending on the region or country you are using the projector in. When using the projector overseas, be sure to use an appropriate power cord for the country you are in.

### Temperature monitor function

- If the projector starts to overheat due to setup problems or blockage of the air vents, "X" and "TEMP." will illuminate in the lower left corner of the picture. If the temperature continues to rise, the lamp will turn off, the temperature warning indicator on the projector will blink, and after a 90-second cooling-off period the projector will enter the standby mode. Refer to "Maintenance Indicators" on page 63 for details.



### Info

- The cooling fan regulates the internal temperature, and its performance is automatically controlled. The sound of the fan may change during projector operation due to changes in the fan speed. This does not indicate malfunction.
- Do not unplug the power cord during projection or cooling fan operation. This can cause damage due to rise in internal temperature, as the cooling fan also stops.

# How to Access the PDF Operation Manuals

PDF operation manuals in several languages are included in the CD-ROM, so that you can work with the projector, even if you do not have this manual. To utilize these manuals, you need to install Adobe Acrobat Reader on your PC (Windows or Macintosh). If you have not installed Acrobat Reader yet, you can install it from the CD-ROM.

## To install Acrobat Reader from the CD-ROM

### For Windows:

- ① Insert the CD-ROM in the CD-ROM drive.
- ② Double click the "My Computer" icon.
- ③ Double click the "CD-ROM" drive.
- ④ Double click the "ACROBAT" folder.
- ⑤ Double click the language (name of the folder) that you want to install.
- ⑥ Double click the installation program and follow the instructions on the screen.

### For Macintosh:

- ① Insert the CD-ROM in the CD-ROM drive.
- ② Double click the "CD-ROM" icon.
- ③ Double click the "ACROBAT" folder.
- ④ Double click the language (name of the folder) that you want to install.
- ⑤ Double click the installation program and follow the instructions on the screen.

### For other operating systems:

Please download Acrobat Reader from the Internet (<http://www.adobe.com>).

### For other languages:

If you prefer using Acrobat Reader for languages other than those included in the CD-ROM, please download the appropriate version from the Internet.

## Accessing the PDF Manuals

### For Windows:

- ① Insert the CD-ROM in the CD-ROM drive.
- ② Double click the "My Computer" icon.
- ③ Double click the "CD-ROM" drive.
- ④ Double click the "MANUALS" folder.
- ⑤ Double click the language (name of the folder) that you want to view.
- ⑥ Double click the "B10" pdf file to access the projector manuals.

### For Macintosh:

- ① Insert the CD-ROM in the CD-ROM drive.
- ② Double click the "CD-ROM" icon.
- ③ Double click the "MANUALS" folder.
- ④ Double click the language (name of the folder) that you want to view.
- ⑤ Double click the "B10" pdf file to access the projector manuals.

### Note

- If the desired pdf file cannot be opened by double clicking the mouse, start Acrobat Reader first, then specify the desired file using the "File", "Open" menu.
- See the "readme.txt" file on the CD-ROM for important information not included in this operation manual.

## Supplied accessories



Remote control  
RRMCGA187WJSA



Two R-6 batteries  
("AA" size, UM/SUM-3, HP-7 or similar)

### Power cord\*

(1)

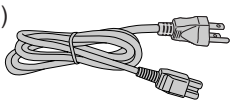

For U.S., Canada, etc.  
(6' (1.8 m))  
QACCD A016WJPZ

(2)

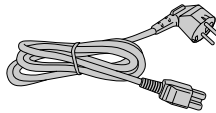

For Europe, except U.K.  
(6' (1.8 m))  
QACCVA006WJPZ

(3)

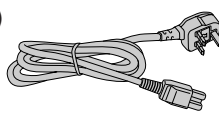

For U.K., Hong Kong and  
Singapore  
(6' (1.8 m))  
QACCBA015WJPZ

(4)

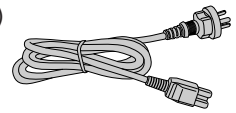

For Australia, New  
Zealand and Oceania  
(6' (1.8 m))  
QACCLA005WJPZ

\* Use the power cord that corresponds to the wall outlet in your country.

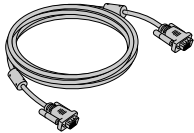

RGB cable  
(9'10" (3.0 m))  
QCNWGA012WJPZ

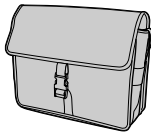

Carrying case  
GCASNA009WJSA

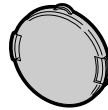

Lens cap (attached)  
CCAPHA004WJ01

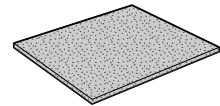

Extra air filter  
PFILDA010WJZZ

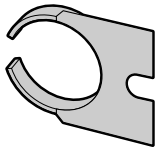

Lens shipping  
block (attached)  
SPAKXA333WJZZ

Projector manual and  
technical reference  
CD-ROM  
UDSKAA039WJZZ

"QUICK GUIDE" label  
TLABZA439WJZZ

Operation manual  
(this manual)

## Optional accessories

- |   |   |
|---|---|
| ■ 3 RCA to 15-pin D-sub cable (9'10" (3.0 m))                           | AN-C3CP                                     |
| ■ Computer RGB cable (32'10" (10.0 m))                                  | AN-C10BM (15-pin mini D-sub male connector) |
| ■ 5 BNC to 15-pin D-sub cable (9'10" (3.0 m))                           | AN-C3BN                                     |
| ■ DIN-D-sub RS-232C adaptor (5 <sup>57</sup> / <sub>64</sub> " (15 cm)) | AN-A1RS                                     |
| ■ RS-232C serial control cable (32'10" (10.0 m))                        | AN-C10RS                                    |
| ■ Remote receiver   | AN-MR1EL                                    |

### Note

- Some of the cables may not be available depending on the region. Please check with your nearest Sharp Authorized Projector Dealer or Service Center.

# Part Names

Numbers in    refer to the main pages in this operation manual where the topic is explained.

## Projector (Front and Top View)

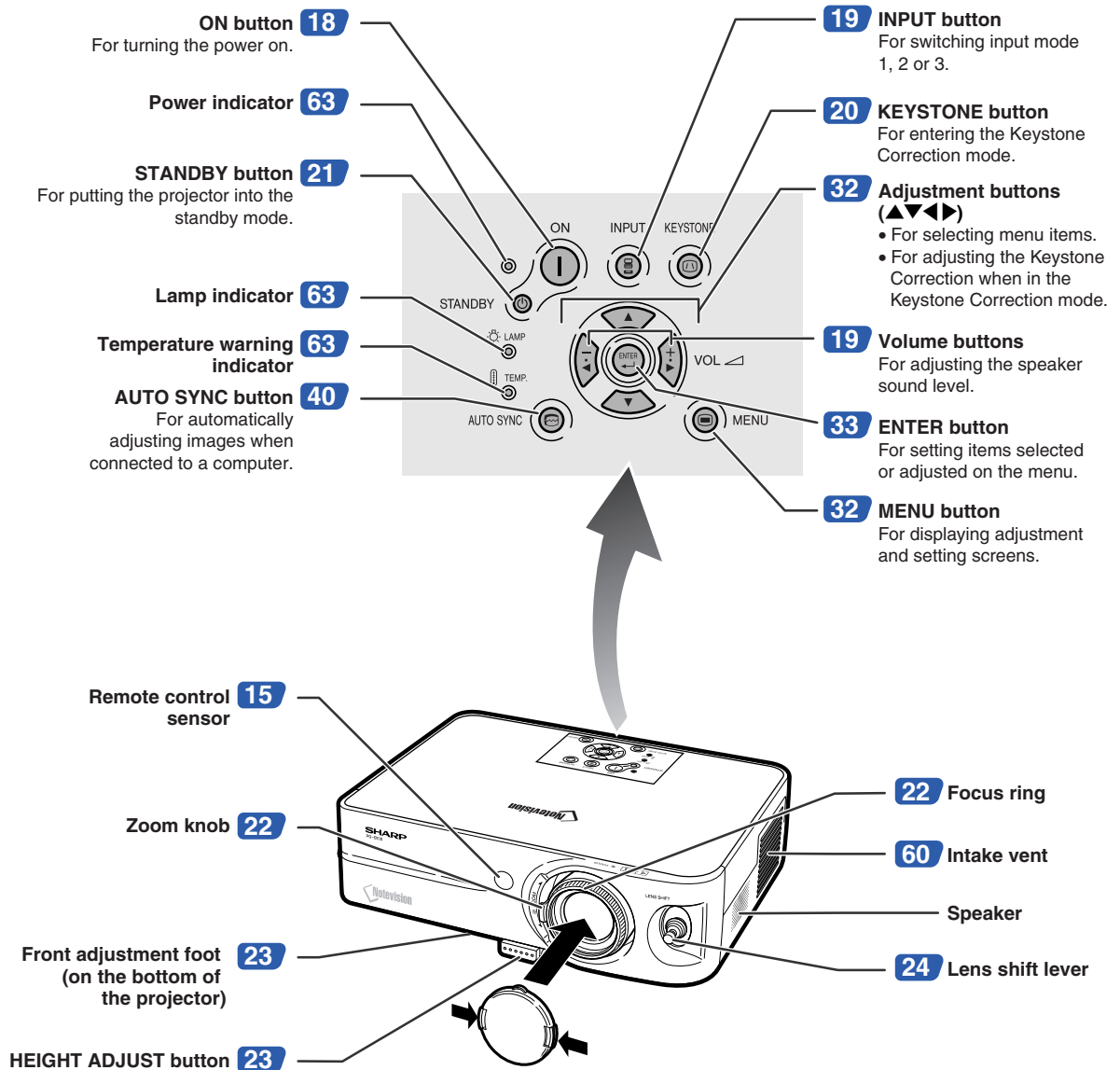

### Attaching and removing the lens cap

- Press on the two buttons of the lens cap and attach it to the lens, then release the buttons to lock it in place.
- Press on the two buttons of the lens cap and remove it from the lens.

## About the Indicators on the Projector

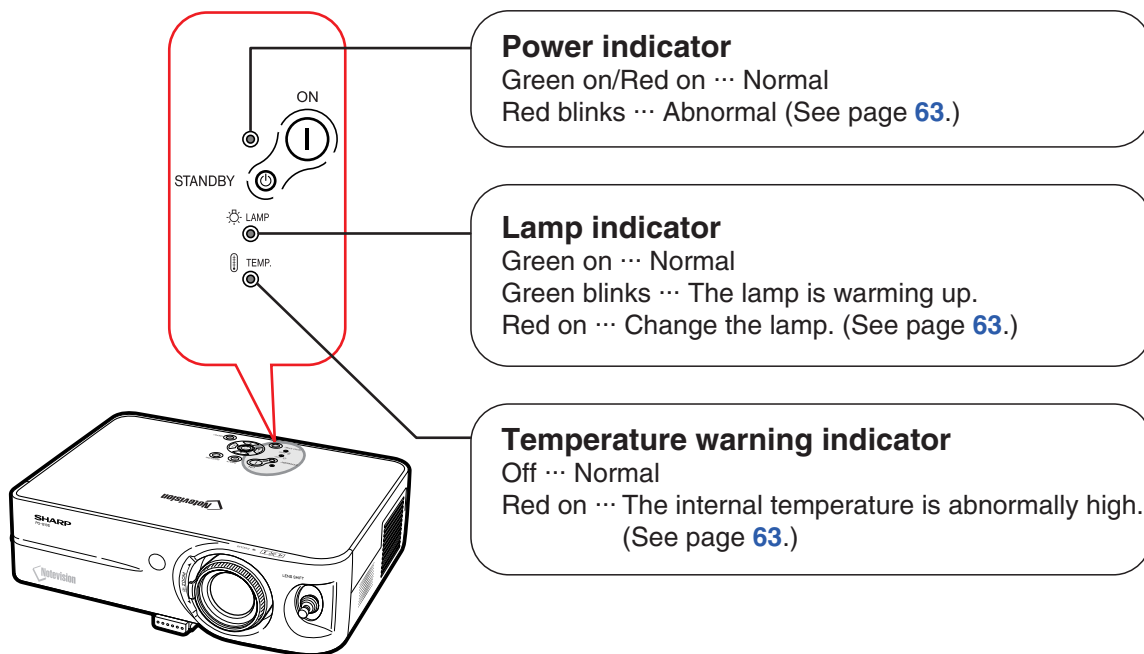

### Attaching and Removing the Lens Shipping Block

When attaching the lens shipping block, be sure to return the lens shift lever to the center position. If the lens is shifted upward or downward, the lens shipping block cannot be attached.

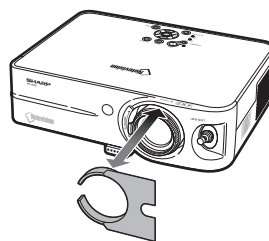

Numbers in    refer to the main pages in this operation manual where the topic is explained.

## Projector (Rear View)

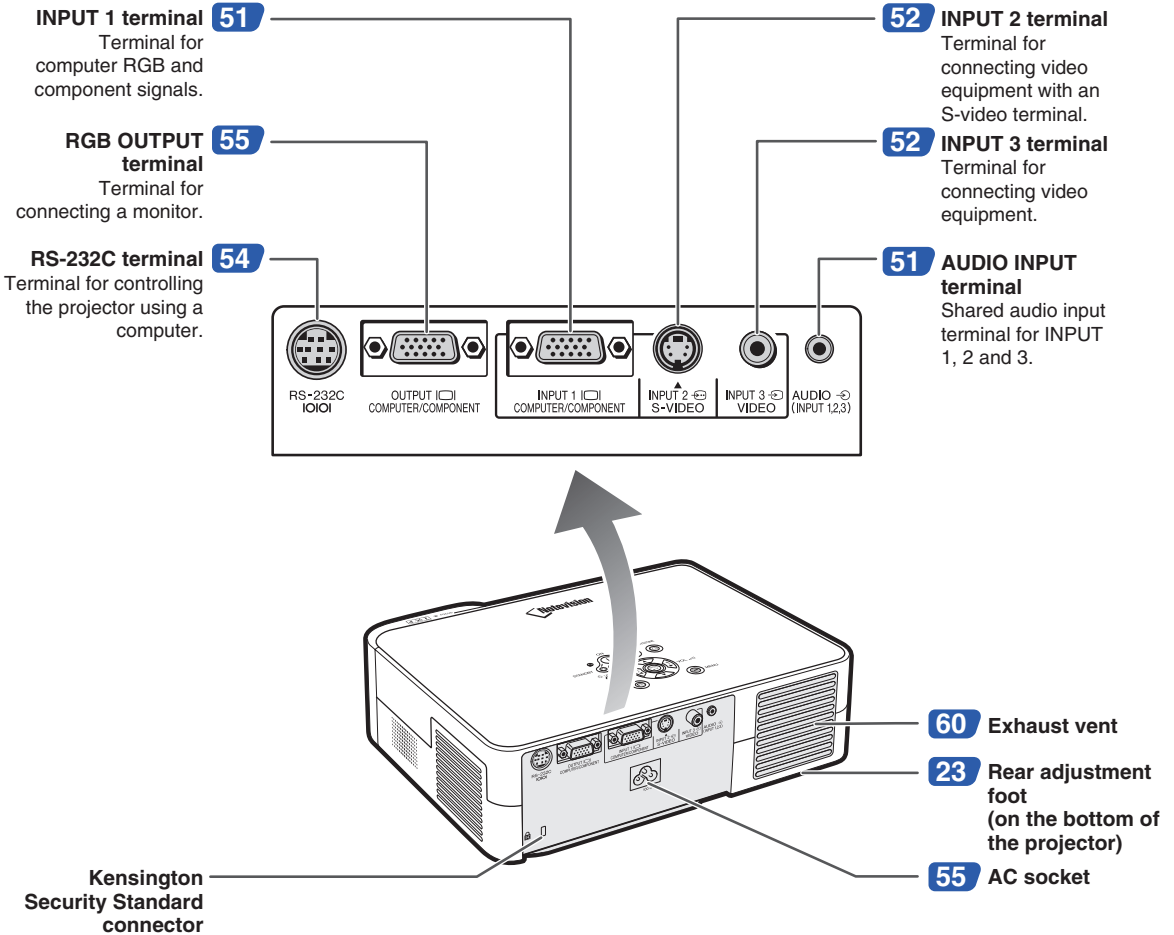

### Using the Kensington Lock

- This projector has a Kensington Security Standard connector for use with a Kensington MicroSaver Security System. Refer to the information that came with the system for instructions on how to use it to secure the projector.



## INPUT/OUTPUT Terminals and Connectable Main Equipment

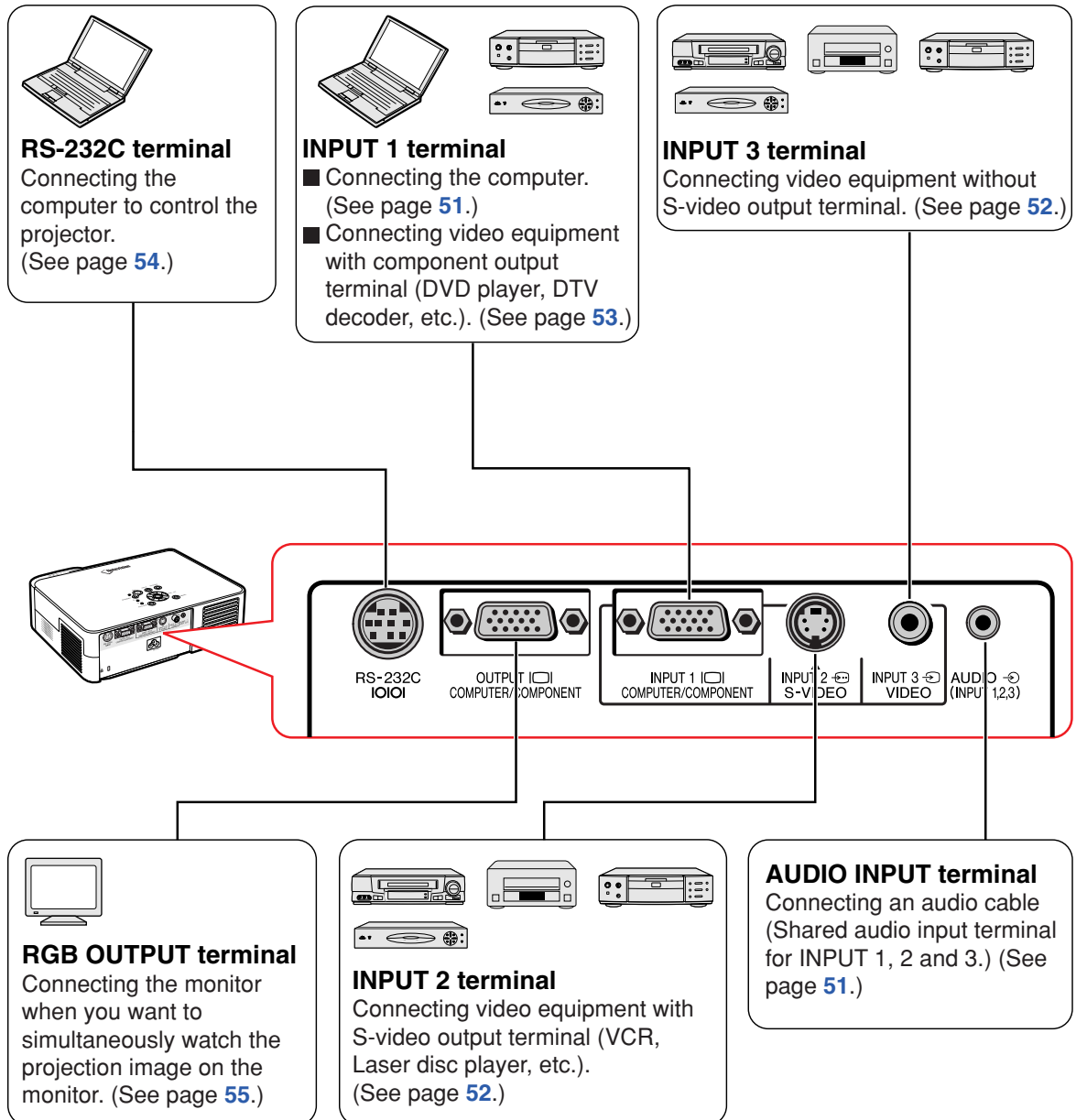

Numbers in    refer to the main pages in this operation manual where the topic is explained.

## Remote Control (Front View)

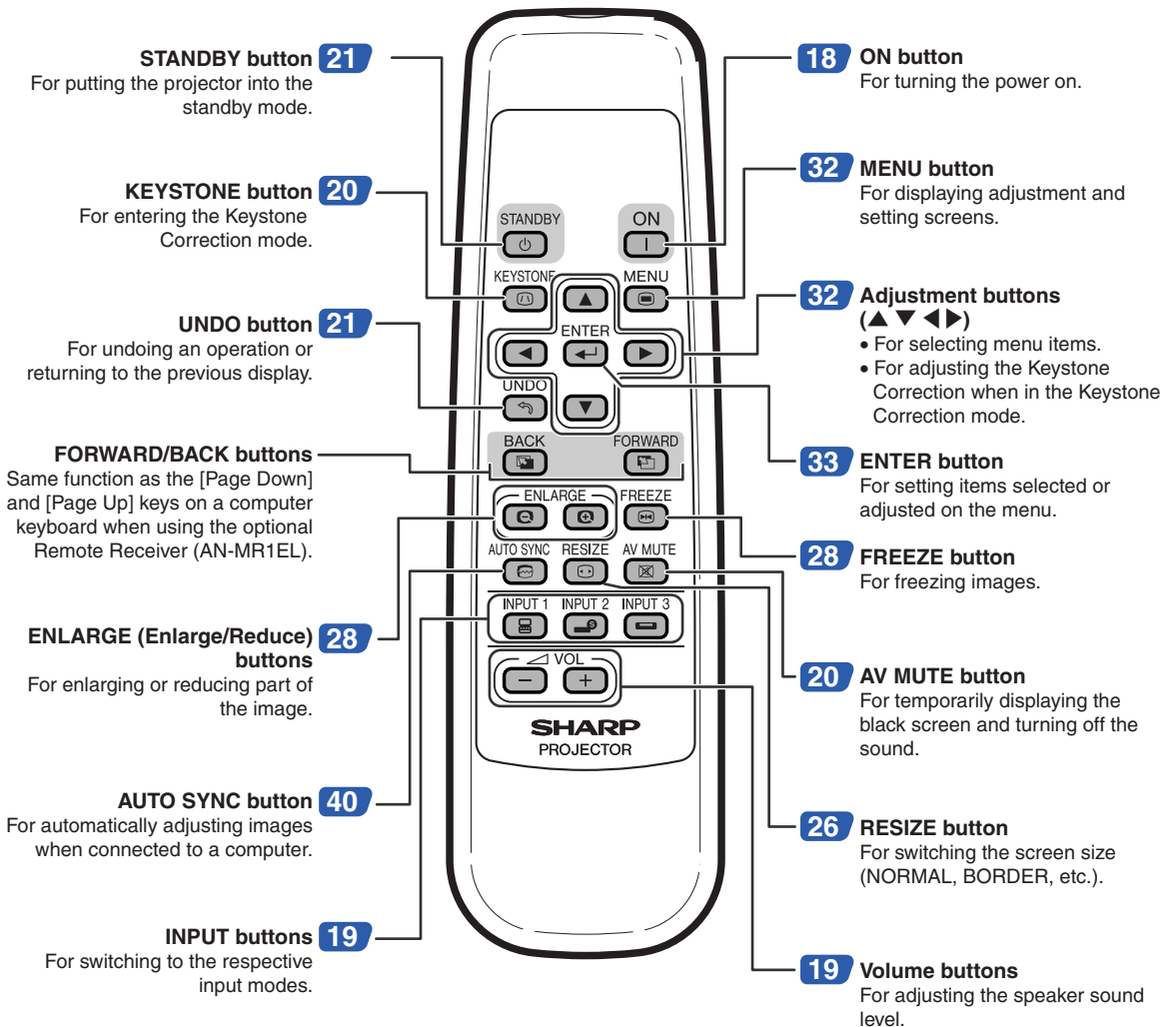

# Using the Remote Control

## Usable Range

The remote control can be used to control the projector within the ranges shown in the illustration.

### Note

- The signal from the remote control can be reflected off a screen for easy operation. However, the effective distance of the signal may differ depending on the screen material.

### When using the remote control:

- Be sure not to drop, expose to moisture or high temperature.
- The remote control may malfunction under a fluorescent lamp. In this case, move the projector away from the fluorescent lamp.

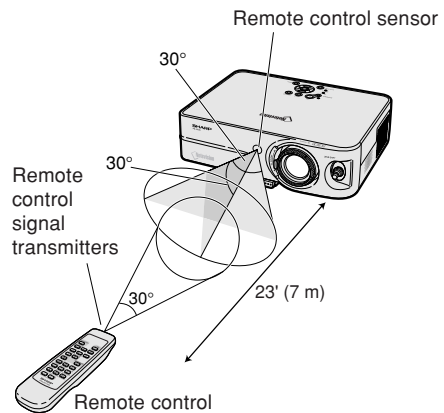

## Inserting the Batteries

The batteries (two R-6 batteries ("AA" size, UM/SUM-3, HP-7 or similar)) are supplied in the package.

**1** Press the ▲ mark on the cover and slide it in the direction of the arrow.

**2** Insert the batteries.

- Insert the batteries making sure the polarities correctly match the ⊕ and ⊖ marks inside the battery compartment.

**3** Attach the cover and slide it until it clicks into place.

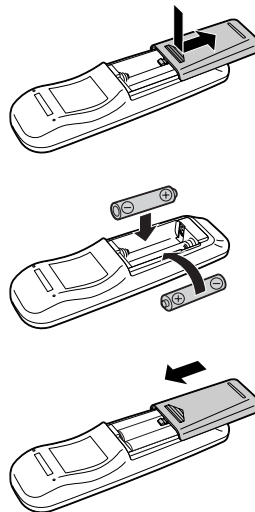

**Incorrect use of the batteries may cause them to leak or explode. Please follow the precautions below.**

### ⚠ Caution

- Insert the batteries making sure the polarities correctly match the ⊕ and ⊖ marks inside the battery compartment.
- Batteries of different types have different properties, therefore do not mix batteries of different types.
- Do not mix new and old batteries.  
This may shorten the life of new batteries or may cause old batteries to leak.
- Remove the batteries from the remote control once they have run out, as leaving them in can cause them to leak. Battery fluid from leaked batteries is harmful to skin, therefore be sure to first wipe them and then remove them using a cloth.

- The batteries included with this projector may run down in a short period, depending on how they are kept. Be sure to replace them as soon as possible with new batteries.
- Remove the batteries from the remote control if you will not be using the remote control for a long time.

# Setup and Projection

In this section, connection of the projector and the computer is explained as an example.

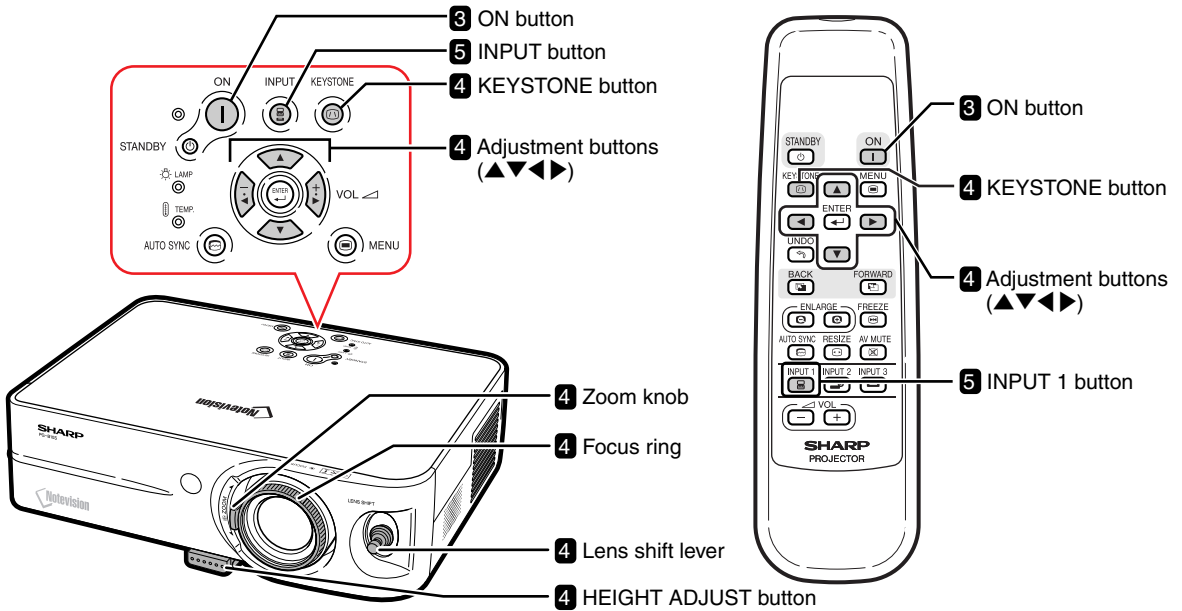

## 1. Place the projector facing a wall or a screen

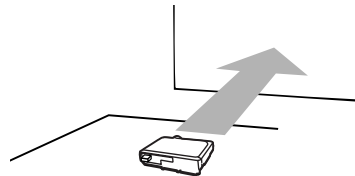

➔ Page 56

## 2. Connect the projector to the computer and plug the power cord into the AC socket of the projector

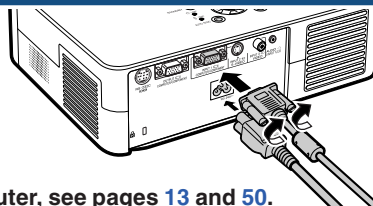

When connecting equipment other than the computer, see pages 13 and 50.

➔ Pages 51, 55

## 3. Turn the projector on

On the projector



On the remote control



➔ Page 18

## 4. Adjust the projected image

### ① Bring the projected image into focus and adjust the projected image size

#### Focus

- Bring the projected image into focus using the focus ring.

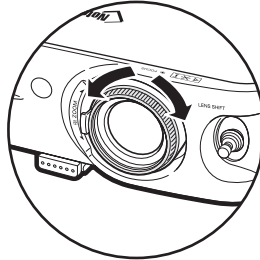

➔ Page 22

#### Zoom

- Adjust the projected image size using the zoom knob.

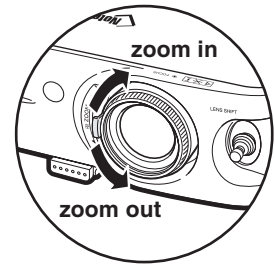

➔ Page 22

### ② Adjust the projected image position and the projector angle

#### Projection position

- Adjust the projected image position using the lens shift lever.

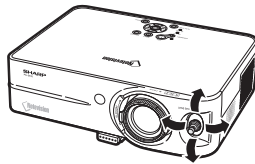

➔ Page 25

#### Angle

- Adjust the projector angle using the HEIGHT ADJUST button.

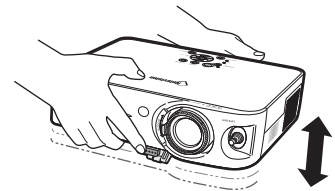

➔ Page 23

### ③ Correct trapezoidal distortion

Correcting trapezoidal distortion using the Keystone Correction.

#### On the projector

KEYSTONE



Compresses upper side.

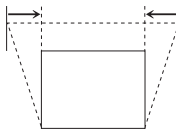

Compresses lower side.

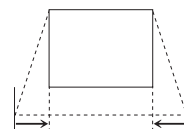

#### On the remote control

KEYSTONE



➔ Page 20

## 5. Select the INPUT mode

Select the "INPUT 1" using the INPUT button on the projector or the INPUT 1 button on the remote control.

#### On the projector

INPUT



#### On the remote control

INPUT 1



#### On-screen display (RGB)



#### On-screen display (Component)



- When pressing on the projector, input mode switches in order of INPUT 1 → INPUT 2 → INPUT 3.

- When using the remote control, press to switch the INPUT mode.

➔ Page 19

# Image Projection

## Turning the Projector on

Connect the required external equipment to the projector before carrying out the following procedures. (See page 50.)

### Info

- The language preset at the factory is English. If you want to change the on-screen display to another language, reset the language according to the procedure on page 48.

### 1 Plug the power cord into the wall outlet.

- The power indicator illuminates red, and the projector enters standby mode.

### 2 Press on the projector or on the remote control.

- The power indicator illuminates green.
- After the lamp indicator illuminates, the projector is ready to start operation.

### Note

- The lamp indicator illuminates, indicating the status of the lamp.
  - Green:** The lamp is ready.
  - Blinking in green:** The lamp is warming up.
  - Red:** The lamp should be replaced.
- If the projector is put into the standby mode and immediately turned on again, the lamp indicator may take some time to illuminate.

- When “Anti-Theft” is set, the keycode input box will appear. Enter the keycode. For details about the Anti-Theft function, refer to “Anti-Theft (Setting the Anti-Theft)” on page 46.
- When bringing the image into focus or adjusting the projection image size, see page 22.
- When adjusting the projection angle, see “Using the Adjustment Feet” on page 23 or “Variable Lens Shift Feature” on page 24.

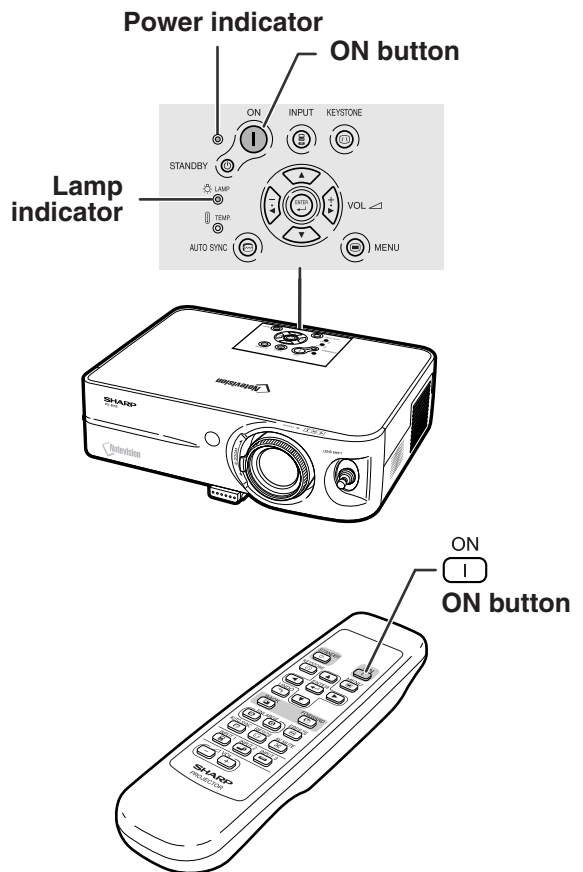





### ▼ Keycode input box



## Switching the INPUT Mode

Select the appropriate input mode for the connected equipment.

Press ,  or  on the remote control to select the INPUT mode.

•When pressing  on the projector, input mode switches in order of   
 →INPUT 1→INPUT 2→INPUT 3.

### Note

- When no signal is received, “NO SIGNAL” will be displayed. When a signal that the projector is not preset to receive is received, “NOT REG.” will be displayed.
- The INPUT mode is not displayed when “OSD Display” of the “Options” menu is set to “OFF”. (See page 41.)

### About the INPUT mode

INPUT 1 (RGB/ Component)	Used for projecting images from equipment that sends RGB signals or component signals connected to the RGB input terminal.
INPUT 2 (S-Video)	Used for projecting images from equipment connected to the S-VIDEO input terminal.
INPUT 3 (Video)	Used for projecting images from equipment connected to the VIDEO input terminal.

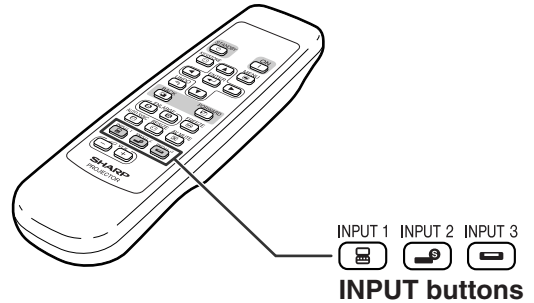



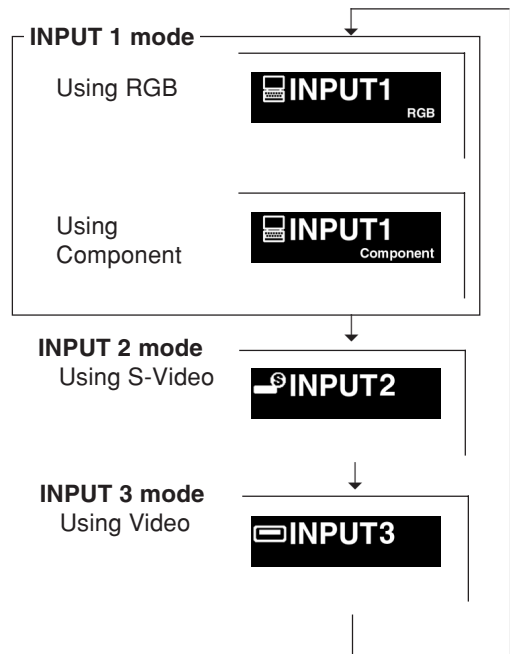

### ▼On-screen Display of INPUT Mode (Example)



## Adjusting the Volume

Press  or  on the remote control to adjust the volume.

### Note

- Pressing  will lower the volume. Pressing  will raise the volume.
- On the projector, the volume can be adjusted by pressing  or .

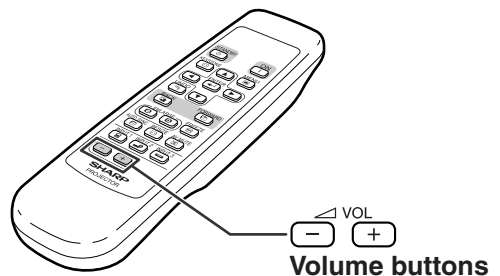

## Displaying the Black Screen and Turning off the Sound Temporarily

Press  on the remote control to temporarily display a black screen and turn off the sound.

 Note

- Pressing  again will turn the projected image and sound back on.

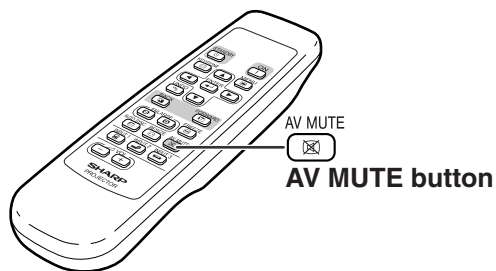

**AV MUTE**

## Correcting Trapezoidal Distortion

When the image is projected either from the top or from the bottom towards the screen at an angle, the image becomes distorted trapezoidally. The function for correcting trapezoidal distortion is called **Keystone Correction**.

 Note

- The Keystone Correction can be adjusted up to an angle of approximately  $\pm 35$  degrees and the screen can also be set up to an angle of approximately  $\pm 35$  degrees (when the resize mode is set to "NORMAL" (see page 26)).
- The Keystone Correction cannot be adjusted in the lateral direction.

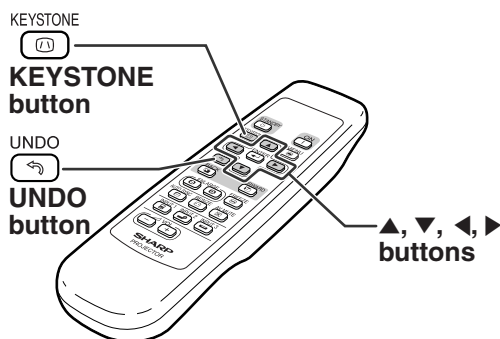

**1**

Press  to enter the **Keystone Correction mode**.

- You can also use  on the projector.

▼ On-screen display (Keystone Correction mode)





## 2 Press ▲, ▼, ◀ and ▶ to adjust the Keystone Correction.

- You can also adjust the Keystone Correction using the  buttons on the projector.

### Note

- Press  to return to the default setting.
- Straight lines or the edges of images may appear jagged while adjusting the image.

## 3 Press .

- The on-screen display of the Keystone Correction mode will disappear.
- You can also use  on the projector.

### Note

- You can use the same settings used in NORMAL mode 4:3 for 16:9.

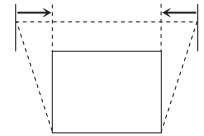
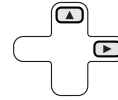

Compresses upper side.



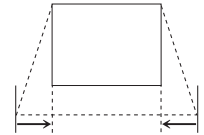
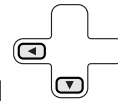

Compresses lower side.



## Turning the Power off (Putting the Projector into the Standby Mode)

- Press  on the projector or  on the remote control, then press that button again while the confirmation message is displayed, to put the projector into the standby mode.

### Note

- If you accidentally pressed  or  and do not want to put the projector into the standby mode, wait until the confirmation message disappears.

STANDBY

  
STANDBY  
button

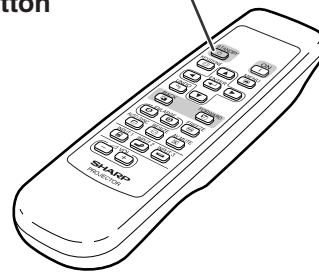

Enter STANDBY mode?  
Yes: Press Again. No: Please Wait.

- Unplug the power cord from the AC outlet after the cooling fan stops.

### Info

- Do not unplug the power cord during projection or cooling fan operation. The cooling fan in this projector continues to run for about 90 seconds after the projector enters the standby mode. This can cause damage due to rise in internal temperature, as the cooling fan also stops.

## Adjusting the Lens

The image is focused and adjusted to the desired size using the focus ring or zoom knob on the projector.

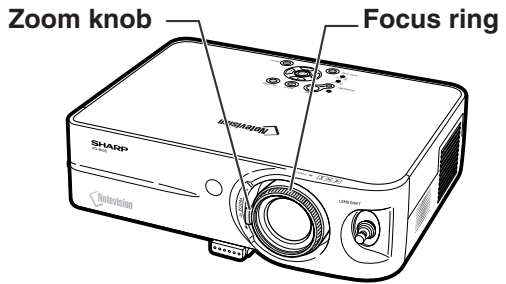

- 1 Adjust the focus by rotating the focus ring.

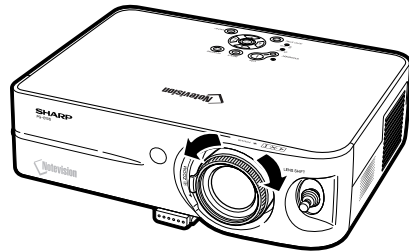

- 2 Adjust zooming by moving the zoom knob.

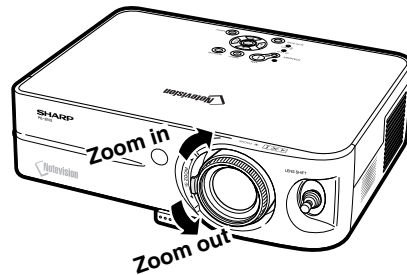

### Indication of the Projection Image Size and Projection Distance

For details, see "Screen Size and Projection Distance" on page 57.

Example : NORMAL Mode (4:3)

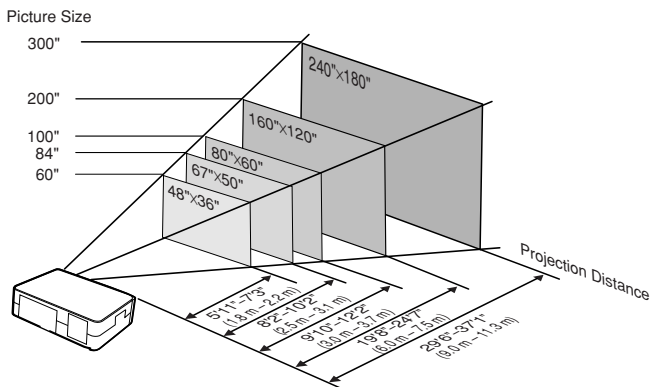

## Using the Adjustment Feet

The height of the projector can be adjusted using the adjustment feet at the front and rear of the projector.

When the screen is in a higher position than the projector, the projection image can be made higher by adjusting the projector.

### 1 Press HEIGHT ADJUST button.

- The front adjustment foot comes out.

### 2 Lift the projector to adjust its height while pressing the HEIGHT ADJUST button.

- The projector is adjustable up to approximately 12 degrees (5 steps).
- When lowering the projector, it may be difficult to move the front adjustment foot because the installation surface is difficult to slide. In this case, pull the projector back slightly and adjust its height.

### 3 Remove your hands from the HEIGHT ADJUST button of the projector after its height has been finely adjusted.

### 4 Use the rear adjustment foot to make the projector level.

- The projector is adjustable  $\pm 1$  degree from the standard position.

#### Note

- When the height of the image is being adjusted by the adjustment feet, the image becomes distorted trapezoidally. In this case, see "Correcting Trapezoidal Distortion" on the page 20 to correct the trapezoidal distortion.

#### Info

- Do not press the HEIGHT ADJUST button when the front adjustment foot comes out without firmly holding the projector.
- Do not hold the lens when lifting or lowering the projector.
- When lowering the projector, be careful not to get your fingers caught in the area between the adjustment foot and the projector.

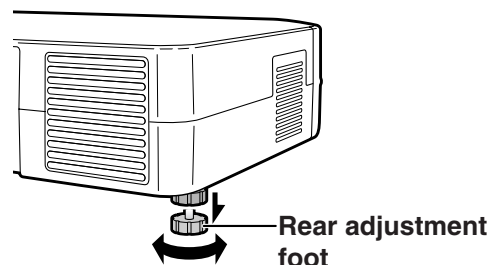
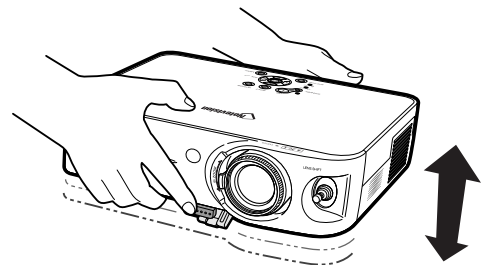
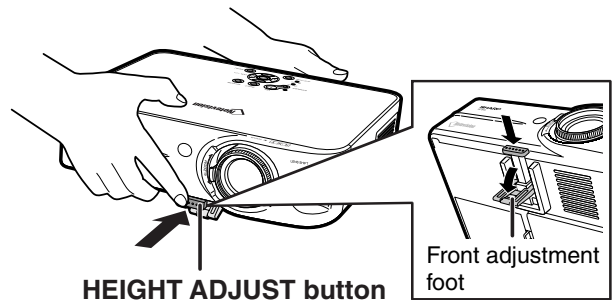
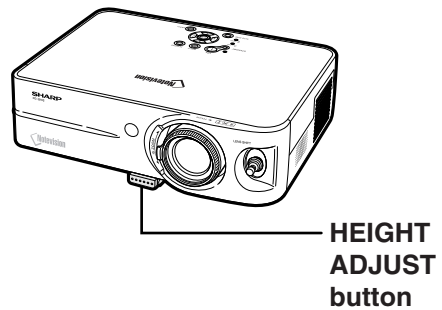

# Variable Lens Shift Feature

In addition to the zoom function and adjustment of projection angle using the adjustment foot, it is possible to move the lens up and down and left and right (360°) to adjust the projection position simply by moving the lens shift lever on the front of the projector. This is a useful function in cases such as when the screen can not be moved.

When moving upward or downward

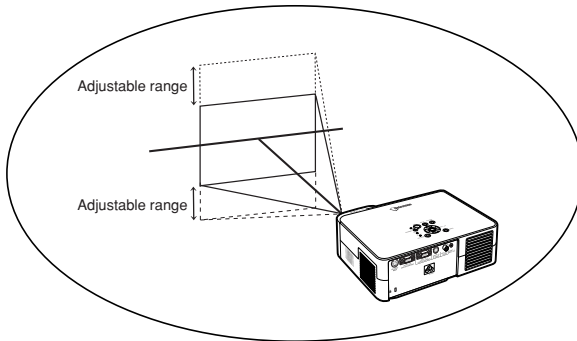

When moving in the left and right direction

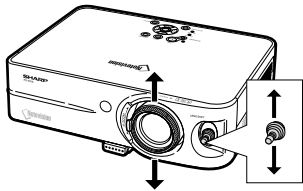
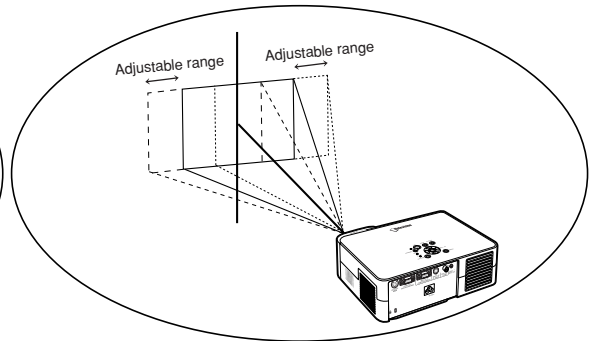

Lens shift lever

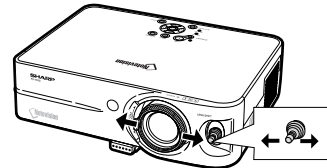

Lens shift lever

## Adjustable range of the lens shift lever

The adjustable range using the lens shift lever has limitations. The image can be adjusted as shown below.

Image center locus

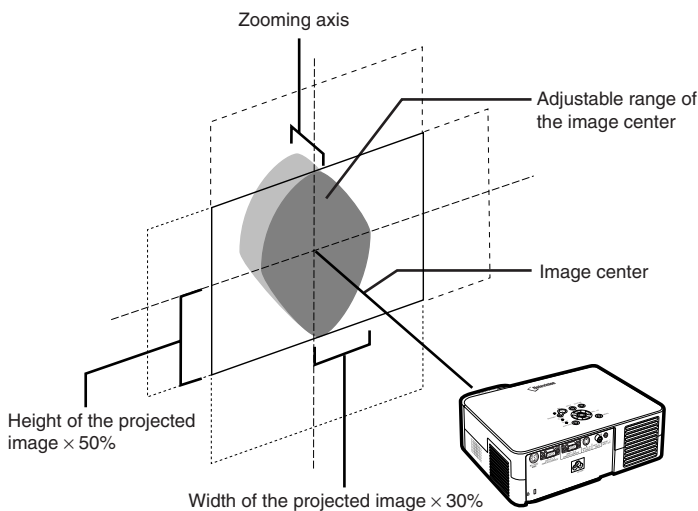

## Adjusting the Projected Image Position

Adjust the projected image position using the lens shift lever.

### Info

- When using the projector (during projection), be sure not to subject the projector to any impact. If the projector is subjected to impact, the projection image may deviate from the adjusted position.
- When transporting or carrying the projector, attach the lens shipping block and the lens cap to the projector.
- When the angle is being adjusted using the adjustment foot, deviation of the projected image arising when carrying out lens shift in the lateral direction can not be corrected by the Keystone Correction.

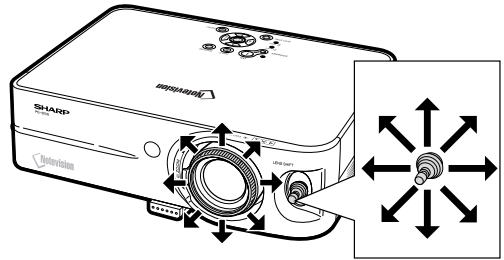



# Resize Mode

This function allows you to modify or customize the resize mode to enhance the input image. Depending on the input signal, you can choose “NORMAL”, “DOT BY DOT”, “BORDER” or “STRETCH” image.

## Switching the Resize Mode

Press .

- Pressing  changes the display as shown on pages 26 and 27.
- To return to the standard image, press  while “RESIZE” is displayed on the screen.

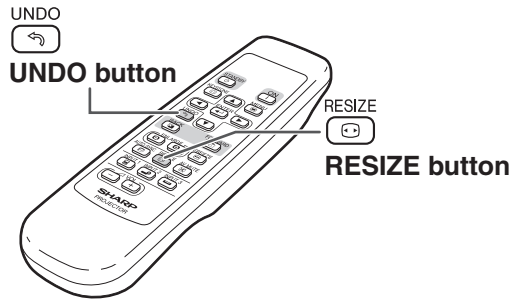

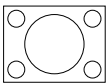
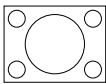
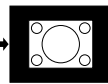
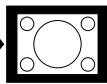
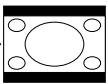
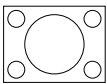
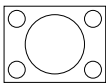
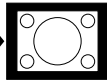
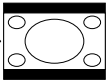
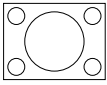
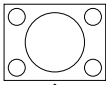
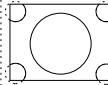
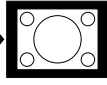
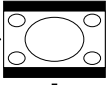
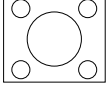
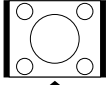
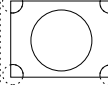
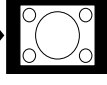
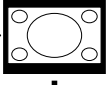
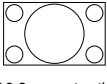
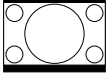

## COMPUTER

		NORMAL	DOT BY DOT	BORDER	STRETCH
4:3 aspect ratio	SVGA (800 × 600)	800 × 600	—	600 × 450	800 × 450
	XGA (1024 × 768)		1024 × 768		
	SXGA (1280 × 960)		1280 × 960		
	SXGA+ (1400 × 1050)		1400 × 1050		
Other aspect ratios	SXGA (1280 × 1024)	750 × 600	1280 × 1024	562 × 450	750 × 450
	1280 × 720	—	—	—	800 × 450

Input Signal		Output screen image			
Computer	Image type	NORMAL Projects a full screen image while maintaining the aspect ratio.	DOT BY DOT Projects the original resolution signal of the image.	BORDER Projects 4:3 image fully in STRETCH (the following column) image.	STRETCH Projects 16:9 image evenly over entire screen (top/bottom blank bands).
Resolution lower than SVGA	 4:3 aspect ratio				
SVGA	 4:3 aspect ratio		—		
Resolution higher than SVGA	 4:3 aspect ratio				
SXGA (1280 × 1024)	 5:4 aspect ratio				
1280 × 720	 16:9 aspect ratio	—	—	—	

\* Mode for projecting an image with the original aspect ratio without cutting any portions.

 : Cutout area on which images cannot be projected.

 : Area where the signals are off screen.

# VIDEO

		NORMAL	BORDER	STRETCH
480I, 480P, NTSC, PAL, SECAM	4:3 aspect ratio. Letter box, squeeze	800 × 600	600 × 450	800 × 450
540P, 720P, 1080I	16:9 aspect ratio	—	—	

• "STRETCH" is fixed when 540P, 720P or 1080I signals are entered.

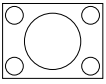
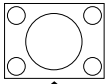
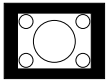
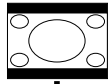
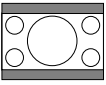
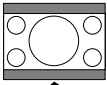
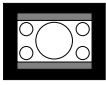
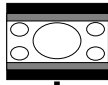
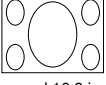
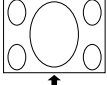
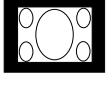
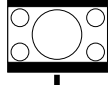
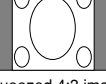
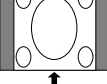
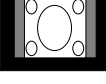
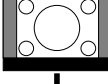
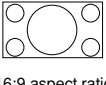
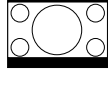
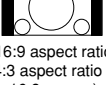
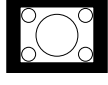
Input Signal		Output screen image		
		NORMAL Projects a full screen image.	BORDER Projects 4:3 image fully in STRETCH (the following column) image.	STRETCH Projects 16:9 image evenly over entire screen (top/bottom black bands).
DVD / Video	Image type			
480I, 480P, NTSC, PAL, SECAM	 4:3 aspect ratio	* 	* 	
	 Letter box	* 	* 	
	 Squeezed 16:9 image			* 
	 Squeezed 4:3 image			* 
540P, 720P, 1080I (16:9)	 16:9 aspect ratio	—	—	* 
	 16:9 aspect ratio (4:3 aspect ratio in 16:9 screen)	—	—	* 

\* Mode for projecting an image with the original aspect ratio without cutting any portions.

 : Cutout area on which images cannot be projected.

 : Area on which the image is not included in the original signals.

# Freeze and Enlarge Image

You can instantly freeze a moving image and enlarge a specific portion of an image with the remote control. Using these functions, you can explain the image to the audience more effectively.

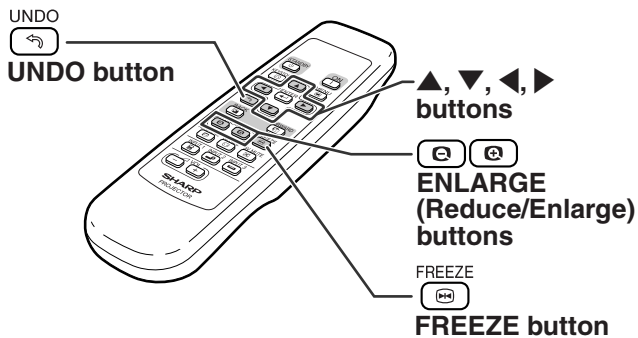

## Freezing a Moving Image



**1** Press .

- The projected image is frozen.

**2** Press  again to return to the moving image from the currently connected device.

## Displaying an Enlarged Portion of an Image

**1** Press .

- Pressing  or  enlarges or reduces the projected image.

### Note

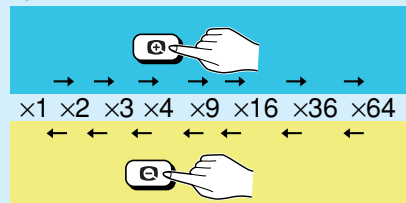

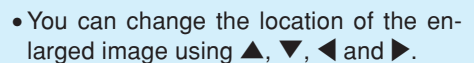
- You can change the location of the enlarged image using .

**2** Press  to cancel the operation.

- The magnification then returns to  $\times 1$ .

### Note

In the following cases, the image will return to the normal size ( $\times 1$ ).

- When switching the INPUT mode.
- When  has been pressed.
- When the input signal is changed.
- When the input signal resolution and refresh rate (vertical frequency) change.



# Keylock Function

Use this function to lock the operation buttons on the projector.

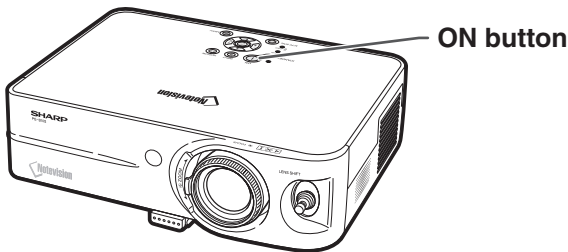

## Locking the Operation Buttons

Hold down  on the projector for about 3 seconds while the projector is being turned on.

### Note

- The keylock function does not affect the operation with the remote control buttons.
- You cannot use the keylock function while the projector is warming up.

### ▼ On-screen display

Keylock function ON

## Taking the Keylock off

Hold down  on the projector for about 3 seconds.

### Note

- The keylock function does not affect the operation with the remote control buttons.
- You cannot use the keylock function while the projector is warming up.

### ▼ On-screen display

Keylock function OFF

# Menu Items

The following shows the items that can be set in the projector.

## “Picture” menu

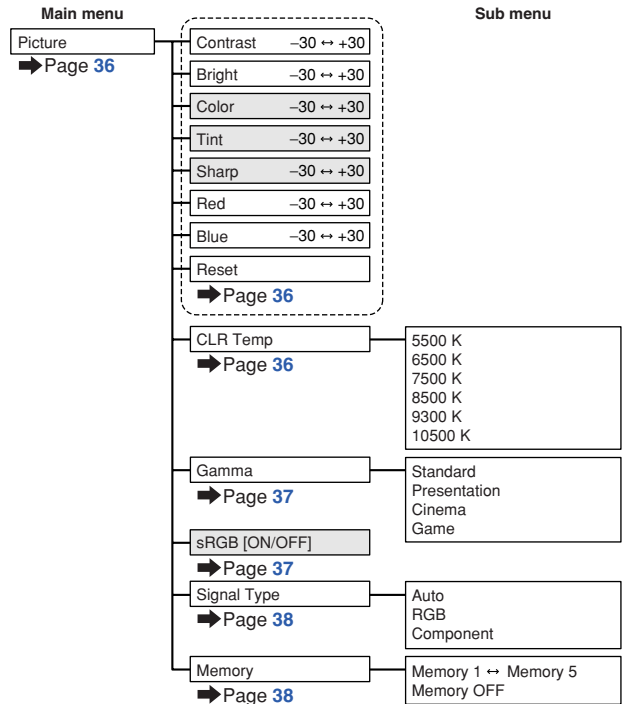
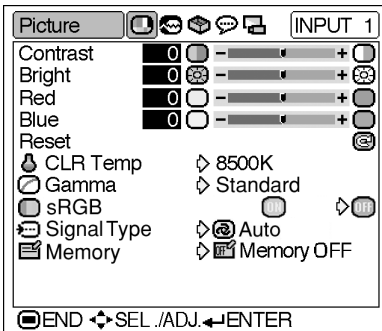

### Note

#### When using the INPUT 1 mode:

- In the “Picture” menu of INPUT 1, “Color”, “Tint” and “Sharp” are only displayed when “Signal Type” is set to “Component” or set to “Auto” and the input signal is recognized as a component signal.
- In the “Picture” menu of INPUT 1, “sRGB” is only displayed when “Signal Type” is set to “RGB” or set to “Auto” and the input signal is recognized as an RGB signal.

#### When using the INPUT 2 or INPUT 3 mode:

- There is no “Signal Type” item in the “Picture” menu.
- In the “Picture” menu of INPUT 2 or INPUT 3, “Sharp” is adjustable between  $-3$  and  $+3$ .

## “Fine Sync” menu

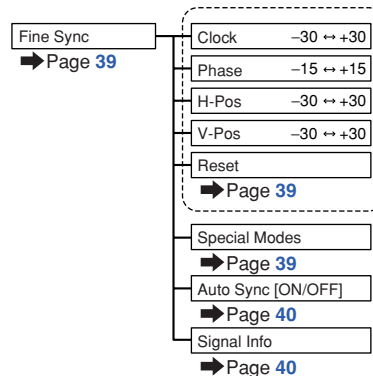
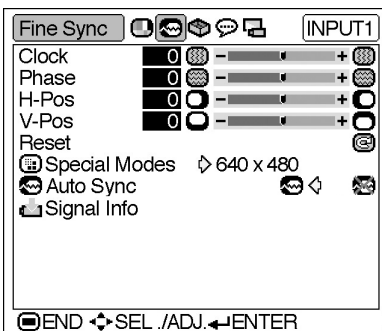

### Note

#### When using the INPUT 1 mode:

- “Fine Sync” menu is only displayed when the projector input is INPUT 1.

## “Options” menu

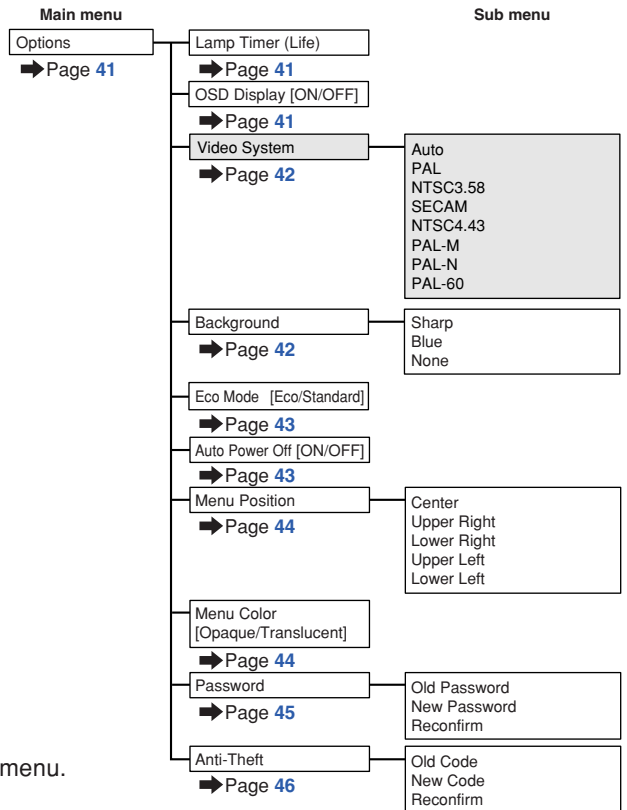
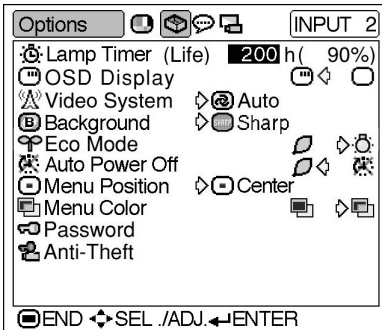

Note

### When using the INPUT 1 mode:

- There is no “Video System” item in the “Options” menu.

## “Language” menu

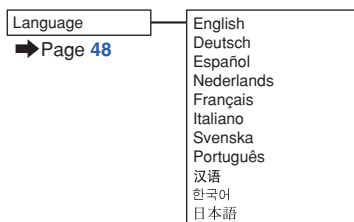

## “PRJ Mode” menu

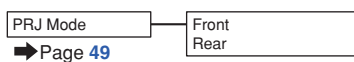
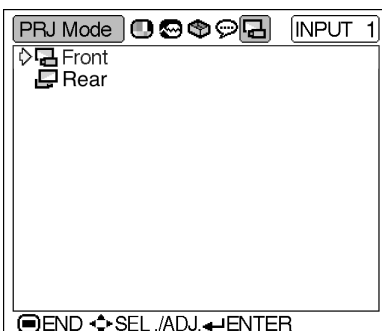

# Using the Menu Screen

The menu screens allow you to adjust the image and various projector settings.

The menu can be operated to achieve two functions, adjustment and setting.

(For adjusting the menu items, see pages 32 and 33. For setting the menu items, see pages 34 and 35.)

Example: "Picture" menu screen for

**INPUT 1 (RGB) mode**

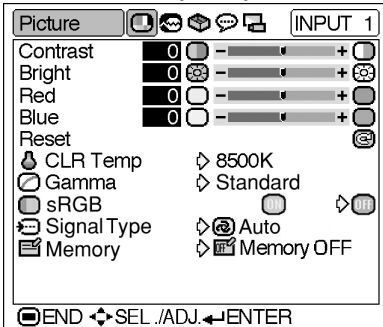

## Menu Selections

### (Adjustments)

- The following procedure is the operating method in an adjustment menu.
- This operation can also be performed by using the buttons on the projector.

#### 1 Press .





- The "Picture" menu screen for the selected input mode is displayed.

#### Note

- The on-screen display shown on the right is displayed when the INPUT 1 (RGB) mode is selected.

#### 2 Press or to display the other menu screens.

- The menu icon for the selected menu screen is highlighted.

Menu icon	Menu screen
	Picture
	Fine Sync
	Options
	Language
	PRJ Mode

#### Note

- The "Fine Sync" menu is not available for INPUT 2 or 3.
- For items on the menus, see the tree charts on pages 30 and 31.

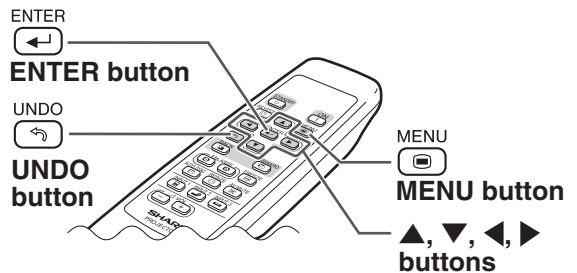

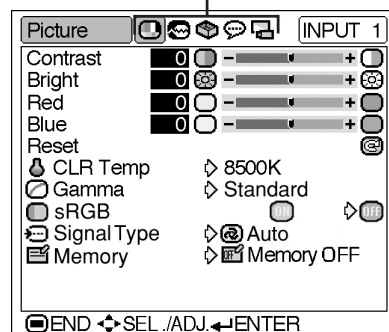

#### Menu icons



### 3 Press ▲ or ▼ to select the item you want to adjust.

- The selected item is highlighted.

#### Note

- To display a single adjustment item, press  after selecting the item. Only the selected adjustment item will be displayed. When pressing ▲ or ▼, the following item ("Red" after "Bright") will be displayed.
- Press  to return to the previous screen.

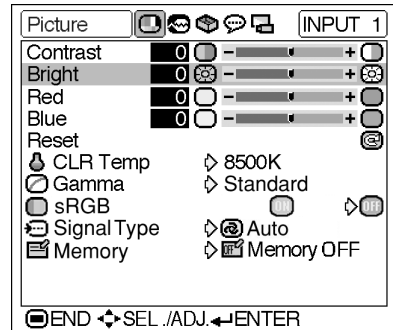

### 4 Press ◀ or ▶ to adjust the item selected.

- The adjustment is stored.

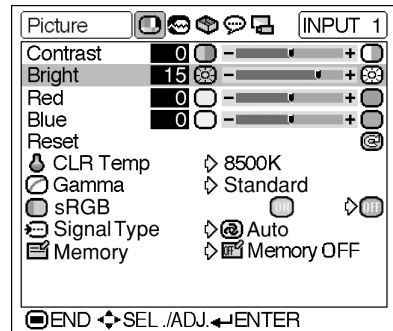

### 5 Press .

- The menu screen will disappear.

## Menu Selections

### (Settings)

- The following procedure is the operating method in a setting menu.
- This operation can also be performed by using the buttons on the projector.

#### 1 Press .

- The “Picture” menu screen for the selected input mode is displayed.



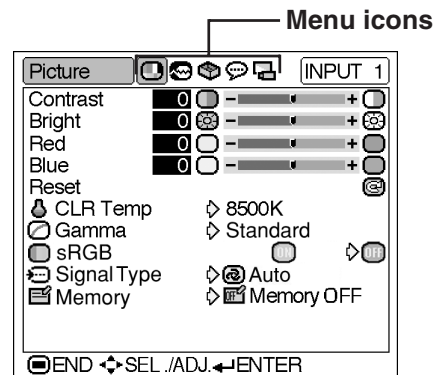
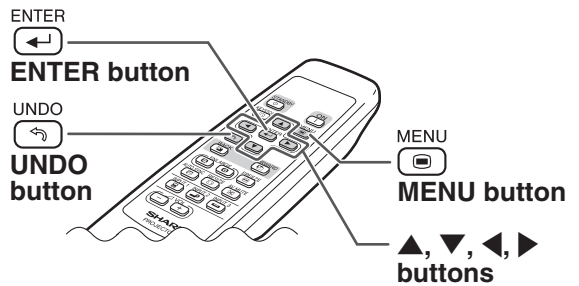

#### Note

- The on-screen display shown on the right is displayed when INPUT 1 (RGB) mode is selected.



#### 2 Press or to display the other menu screens.

- The menu icon for the selected menu screen is highlighted.

Menu icon	Menu screen
	Picture
	Fine Sync
	Options
	Language
	PRJ Mode

#### Note

- The “Fine Sync” menu is not available for INPUT 2 or 3.
- For items on the menus, see the tree charts on pages 30 and 31.

#### Example: “Options” menu screen for INPUT 1 mode

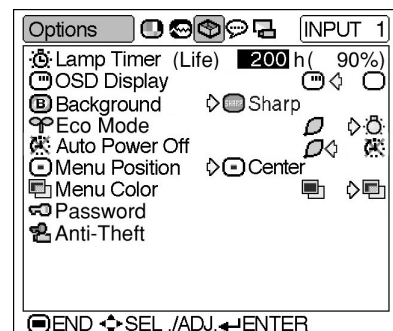

**3** Press ▲ or ▼ to select the item you want to set, and then press ► to display the sub menu.

- The selected item is highlighted.
- When you select “Password” or “Anti-Theft” on the “Options” menu, press .

 **Note**

UNDO

- Press  or ◀ to return to the previous screen.
- For some items, press ◀ or ▶ to select the icon using “→”.

**4** Press ▲ or ▼ to select the setting of the item displayed in the sub menu.

**5** Press .

- The item selected is set.

**6** Press .

- The menu screen will disappear.

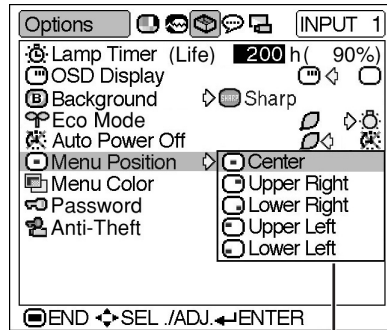

Sub menu

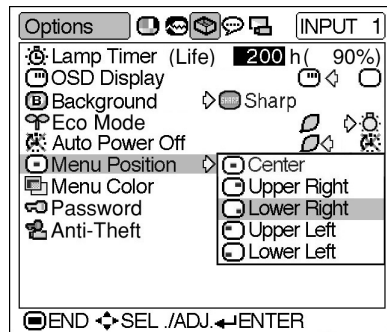

# Picture Adjustment

You can adjust the projector's picture to your preferences using the "Picture" menu.

## Adjusting the Image

Select the item on the "Picture" menu and adjust the image.

Adjusting the menu screen ➡ Page 32

Example: "Picture" screen menu for INPUT 1 (RGB) mode

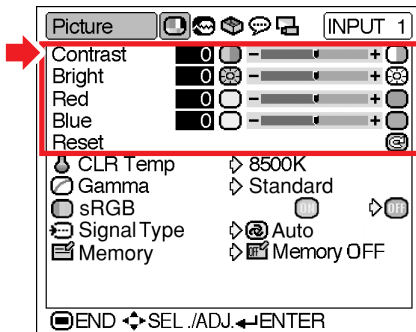

### Description of Adjustment Items

Selectable items	Press ◀	Press ▶
Contrast	for less contrast.	for more contrast.
Bright	for less brightness.	for more brightness.
Color	for less color intensity.	for more color intensity.
Tint	for making skin tones purplish.	for making skin tones greenish.
Sharp	for less sharpness.	for more sharpness.
Red	for weaker red.	for stronger red.
Blue	for weaker blue.	for stronger blue.

### Note

- "Color", "Tint" and "Sharp" are not displayed when selecting INPUT 1 and setting the "Signal Type" to "RGB" or setting the "Signal Type" to "Auto" and the input signal is recognized as an RGB signal.
- "Red" and "Blue" cannot be adjusted when "sRGB" is set to "ON".
- "Sharp" can be adjusted when 480I, 480P, 540P, 580I, 580P, 720P, 1035I or 1080I signals are detected while "Signal Type" for INPUT 1 is set to "Component" or set to "Auto" and the input signal is recognized as a component signal.
- To reset all adjustment items, select "Reset" and press .

## CLR Temp (Adjusting the Color Temperature)

Select "CLR Temp" on the "Picture" menu and the desired color temperature setting.

Setting the menu screen ➡ Page 34

Example: "Picture" screen menu for INPUT 1 (RGB) mode

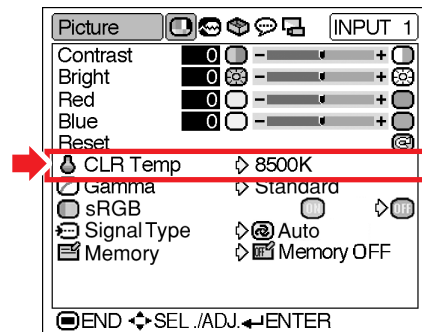

### Description of Color Temperature Settings

Selectable settings	Description
5500K	For lower color temperature for warmer, reddish incandescent-like images.
6500K	
7500K	
8500K	
9300K	For higher color temperature for cooler, bluish, fluorescent-like images.
10500K	

### Note

- Values for "CLR Temp" are only approximations.
- "CLR Temp" cannot be set when "sRGB" is set to "ON".



## **Gamma (Gamma Correction)**

Gamma is an image quality enhancement function that offers a richer image by brightening the darker portions of the image without altering the brightness of the brighter portions.

When you are displaying images with frequent dark scenes, such as a film or concert, or when you are displaying images in a bright room, this feature makes the dark scenes easier to see and gives the impression of greater depth in the image.

Select “Gamma” on the “Picture” menu and the desired gamma mode.

Setting the menu screen ➡ Page 34

### Example: “Picture” screen menu for INPUT 1 (RGB) mode

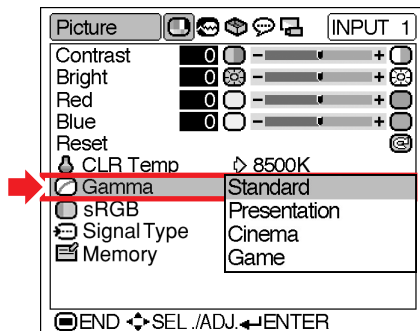

### Description of Gamma Modes

Selectable settings	Description
Standard	For standard image
Presentation	Brightens darker portions of image for more enhanced presentations.
Cinema	Gives greater depth to darker portions of image for a more exciting theater experience.
Game	For natural color gradation for playing a game, etc.

#### Note

- Gamma is not available for INPUT 1 when “sRGB” on the “Picture” menu is set to “ON”.

## **sRGB (sRGB Setting)**

When you want to display the image in a natural tint based on an original image from the computer, select “sRGB” and set it to “” (ON).

Select “sRGB” on the “Picture” menu and set it to “” (ON).

Setting the menu screen ➡ Page 34

### Example: “Picture” screen menu for INPUT 1 (RGB) mode

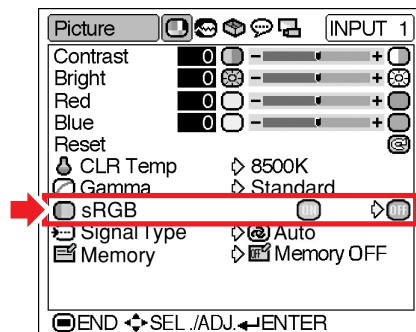

#### Note

- When “sRGB” is set to “” (ON);
  - Gamma is not available.
  - “Red”, “Blue” or “CLR Temp” on the “Picture” menu cannot be adjusted.
- For additional information about the sRGB function, visit “<http://www.srgb.com/>”.

#### Info

- When “sRGB” is set to “” (ON), the projected image may become dark, but this does not indicate a malfunction.

## Signal Type (Signal Type Setting)

The signal type setting is preset to “Auto”; however, in rare cases a clear picture may not be displayed. In that case, select “RGB” or “Component” in accordance with the input signal.

Select “Signal Type” on the “Picture” menu and set it to “Auto”, “RGB” or “Component” for INPUT 1.

Setting the menu screen ➡ Page 34

Example: “Picture” screen menu for INPUT 1 (RGB) mode

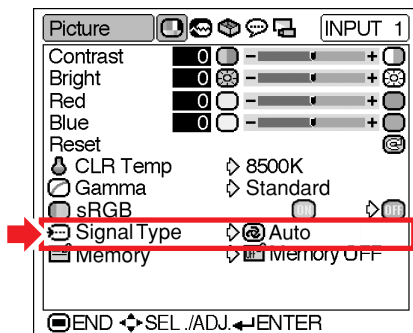

### Description of Signal Type Settings

Selectable settings	Description
Ⓐ Auto	Input signals are automatically recognized as RGB or Component.
Ⓜ RGB	Set when RGB signals are received.
Ⓜ Component	Set when Component signals are received.

## Memory (Storing and Selecting the Adjustment Settings)

Use this function to store the adjustment settings on the “Picture” menu. No matter which input mode or signal type is selected, you can select and apply the settings you have stored in a memory location.

Select “Memory” on the “Picture” menu and the memory location where you want to store the settings. Then adjust the setting items on the “Picture” menu.

Setting the menu screen ➡ Page 34

Example: “Picture” screen menu for INPUT 1 (RGB) mode

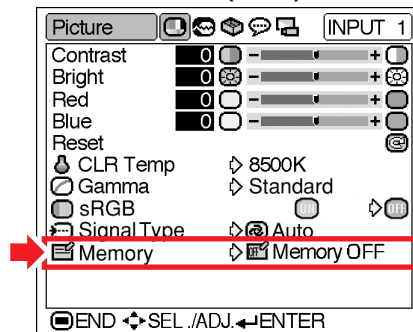

### Description of Memory Positions

Selectable settings	Description
Ⓜ Memory 1	Settings of all items on the “Picture” menu can be stored in memory location. The stored settings can be selected in any input mode.
Ⓜ Memory 2	
Ⓜ Memory 3	
Ⓜ Memory 4	
Ⓜ Memory 5	
Ⓜ Memory OFF	Besides “Memory 1” to “Memory 5”, other settings on the “Picture” menu can be stored for each input mode. The settings stored in “Memory OFF” cannot be applied when another input mode is selected.

If you want to apply the stored settings on the “Picture” menu, select “Memory” on the “Picture” menu and the memory location where you have stored the settings.

### Note

- You can change the stored settings after selecting the memory location for those settings.

# Computer Image Adjustment

Using the “Fine Sync” menu, you can adjust the computer image, match the computer display mode, and check the input signal.

## Adjusting the Computer Image

When “Auto Sync” is set to OFF or when vertical stripes or flickering occur in portions of the screen even if “Auto Sync” is set to ON, adjust “Clock”, “Phase”, “H-Pos” or “V-Pos” to obtain the best computer image.

Select the item on the “Fine Sync” menu and adjust the computer image.

Adjusting the menu screen ➡ Page 32

Example: “Fine Sync” menu screen for INPUT 1 mode

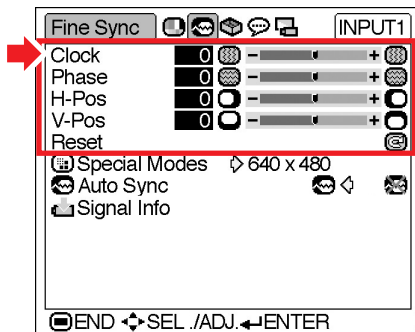

### Description of Adjustment Items

Selectable items	Use ◀ and ▶ to
Clock	adjust vertical noise.
Phase	adjust horizontal noise (similar to tracking on your VCR).
H-Pos	center the on-screen image by moving it to the left or right.
V-Pos	center the on-screen image by moving it up or down.

#### Note

- You can automatically adjust the computer image by setting “Auto Sync” on the “Fine Sync” menu or pressing the AUTO SYNC button. See next page for details.
- To reset all adjustment items, select “Reset” and press .

## Special Modes (Special Mode Settings)

Ordinarily, the type of input signal is detected and the correct resolution mode is automatically selected. However, for some signals, the optimal resolution mode in “Special Modes” on the “Fine Sync” menu may need to be selected to match the computer display mode.

Select “Special Modes” on the “Fine Sync” menu and the appropriate resolution.

Setting the menu screen ➡ Page 34

Example: “Fine Sync” menu screen for INPUT 1 mode

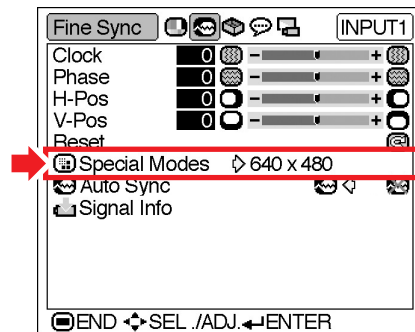

#### Note

- If your computer displays patterns which repeat every other line (horizontal stripes), flickering may occur which makes the image hard to see.
- When a DVD player or Digital Video is connected, select 480P as the input signal.
- See “Signal Info (Checking the Input Signal)” on the next page for information on the currently selected input signal.

## **Auto Sync (Auto Sync Adjustment)**

Used to automatically adjust a computer image.



Select “Auto Sync” on the “Fine Sync” menu and set it to “” (ON) or “” (OFF).

Setting the menu screen ➔ Page 34

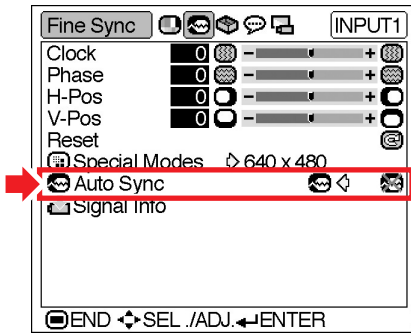

Example: “Fine Sync” menu screen for INPUT 1 mode



### Description of Auto Sync Adjustment

Selectable Settings	Description
 ON	Auto Sync adjustment will occur when the projector is turned on or when the input signals are switched, when connected to a computer.
 OFF	Auto Sync adjustment is not automatically performed.

#### Note

- Auto Sync adjustment is also performed by pressing  on the projector or  on the remote control.
- The Auto Sync adjustment may take some time to complete, depending on the image of the computer connected to the projector.
- When the optimum image cannot be achieved with Auto Sync adjustment, use manual adjustments. (See page 39.)

## **Signal Info (Checking the Input Signal)**

Select “Signal Info” on the “Fine Sync” menu to check the current input signal information.

Checking the menu screen ➔ Page 34

Example: “Fine Sync” menu screen for INPUT 1 mode

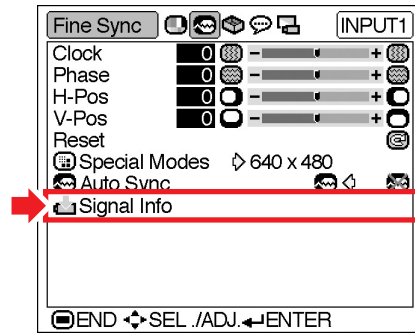

#### Note

- The projector will display the number of scanned lines available from audio-visual equipment such as a DVD player or Digital Video.

# Using the “Options” Menu

You can use the “Options” menu to enhance the usage for the projector.

## **Lamp Timer (Life) (Checking the Lamp Life Status)**

You can confirm the cumulative lamp usage time and the remaining lamp life (percentage).



Display the “Options” menu to check the lamp life status.

Checking the menu screen ➡ Page 34

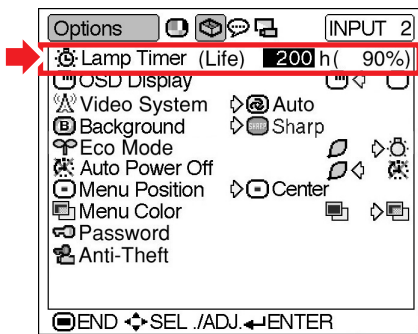

Example: “Options” menu screen for INPUT 2 (S-Video) mode



### Description of Lamp Life

Lamp usage condition	Remaining lamp life	
	100%	5%
Operated exclusively in Eco mode (  )	Approx. 4,000 hours	Approx. 200 hours
Operated exclusively in Standard mode (  )	Approx. 2,000 hours	Approx. 100 hours

### Note

- It is recommended that the lamp be changed when the remaining lamp life becomes 5%. For lamp replacement, contact your nearest Sharp Authorized Projector Dealer or Service Center.
- The table above indicates rough estimates in the case of using only in each mode shown. Remaining lamp life changes within the range of the values shown depending on the frequency at which “Eco Mode” is switched to “  ” (Eco mode) and “  ” (Standard mode) (see page 43).

## **OSD Display (Setting On-screen Display)**

This function allows you to turn the on-screen messages on or off.



Select “  ” (ON) or “  ” (OFF) in “OSD Display” on the “Options” menu.

Setting the menu screen ➡ Page 34

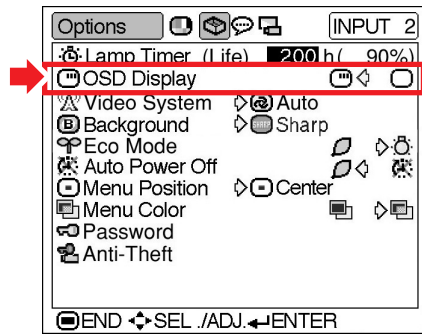
Example: “Options” menu screen for INPUT 2 (S-Video) mode



### Description of “OSD Display” Settings

Selectable settings	Description
 (ON)	All On-screen Displays are displayed.
 (OFF)	INPUT/VOLUME/AV MUTE/FREEZE/AUTO SYNC/ENLARGE/ “An invalid button has been pressed.” / “All buttons on Projector are locked.”* are not displayed.

\*Displayed when the STANDBY button is pressed while the keylock function is active.

## **A** Video System (Setting the Video System)

The video input system mode is preset to “Auto”; however, a clear picture from the connected audio-visual equipment may not be received, depending on the video signal difference. In that case, switch the video signal.

Select “Video System” on the “Options” menu and the appropriate video system.

Setting the menu screen ➡ Page 34

### Example: “Options” menu screen for INPUT 2 (S-Video) mode

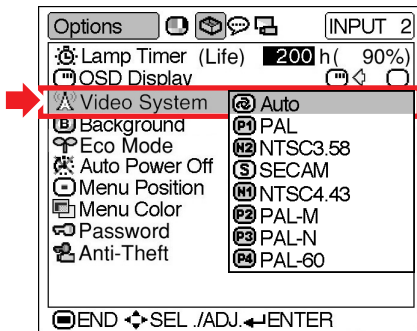

### Description of Video Systems

Selectable settings	Description
<b>P1</b> PAL	When connected to PAL video equipment.
<b>S</b> SECAM	When connected to SECAM video equipment.
<b>M1</b> NTSC4.43	When reproducing NTSC signals in PAL video equipment.
<b>M2</b> NTSC3.58	When connected to NTSC video equipment.

#### Note

- The video signal can only be set in INPUT 2 or INPUT 3 mode.
- When the system mode is set to “Auto”, you may not receive a clear picture due to signal differences. Should this occur, switch to the video system of the source signal.

## **B** Background (Selecting a Startup and Background Image)

Select “Background” on the “Options” menu and the image displayed upon the projector’s startup and when no signal is being sent to the projector.

Setting the menu screen ➡ Page 34

### Example: “Options” menu screen for INPUT 2 (S-Video) mode

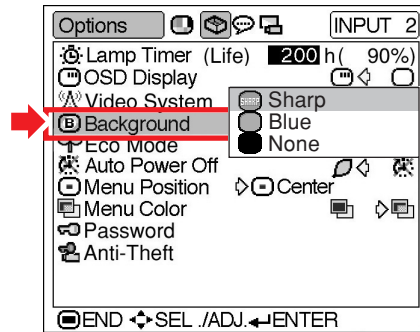



### Description of Background Images

Selectable settings	Description
Sharp	SHARP default image
Blue	Blue screen
None	Black screen

#### Note

- If the input signal has interference, the screen will be displayed during interference.

## Eco Mode (Setting the Eco Mode)



Select “” (Eco Mode) or “” (Standard Mode) in “Eco Mode” on the “Options” menu.

Setting the menu screen ➡ Page 34

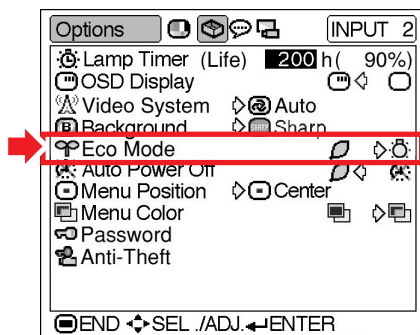

Example: “Options” menu screen for INPUT 2 (S-Video) mode





### Description of Eco Mode



Selectable settings	Brightness	Power consumption (When using AC 100V)	Lamp life
 (Eco mode)	90%	170 W	Approx. 4,000 hours
 (Standard mode)	100%	185 W	Approx. 2,000 hours

#### Note

- Although lamp life and noise are improved when “Eco Mode” is set to “” (Eco mode), brightness decreases by 10%.
- “Eco Mode” is factory preset to “” (Standard mode).

## Auto Power Off (Auto Power Off Function)

When no input signal is detected for more than 15 minutes, the projector will automatically enter the standby mode if set to “” (ON). The Auto Power Off function will be disabled if it has been set to “” (OFF).

Select “” (ON) or “” (OFF) in “Auto Power Off” on the “Options” menu.

Setting the menu screen ➡ Page 34

Example: “Options” menu screen for INPUT 2 (S-Video) mode



#### Note

- When the Auto Power Off function is set to “ON”, 5 minutes before the projector enters the standby mode, the message “Enter STANDBY mode in X min.” will appear on the screen to indicate the remaining minutes.

## ☐ Menu Position (Selecting the Menu Screen Position)

Select “Menu Position” on the “Options” menu and the desired position for the menu screen.

Setting the menu screen ➡ Page 34

Example: “Options” menu screen for INPUT 2 (S-Video) mode

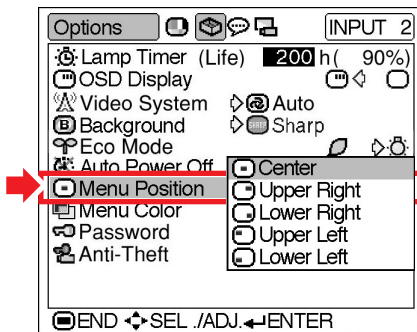

### Description of Menu Positions

Selectable settings	Description
☐ Center	Displayed on the center of the image.
☐ Upper Right	Displayed on the upper right of the image.
☐ Lower Right	Displayed on the lower right of the image.
☐ Upper Left	Displayed on the upper left of the image.
☐ Lower Left	Displayed on the lower left of the image.

## ☐ Menu Color (Selecting the Menu Color)

Select “☐” (Opaque) or “☐” (Translucent) in “Menu Color” on the “Options” menu.

Setting the menu screen ➡ Page 34

Example: “Options” menu screen for INPUT 2 (S-Video) mode

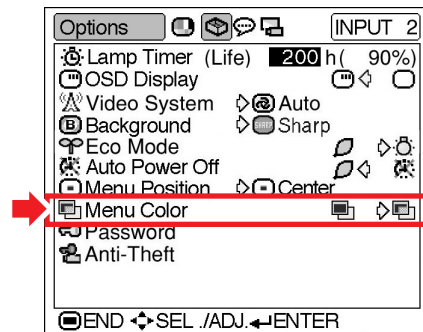

### Description of Menu Colors

Selectable settings	Description
☐ Opaque	The menu is displayed opaquely.
☐ Translucent	The menu is displayed translucently. The part of the menu on the image becomes transparent.







## Password (Setting a Password)

A password must be set to activate the “Anti-Theft” function (Page 46). There is no factory preset for the password or the “Anti-Theft” settings. In this way, anyone can freely set a new password and “Anti-Theft” settings. It is therefore recommended that even if you do not want to use the “Anti-Theft” function, you at least set a password to prevent others from setting the “Anti-Theft” function.

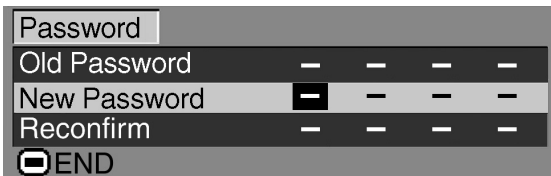
Select “Password” on the “Options” menu, then press  and follow the procedure below to enter the password.

Setting the menu screen  Page 34



**1** Press  or  to select the desired number and then press .

**2** Enter the 3 remaining digits and press .

**3** Enter the password again in “Reconfirm” and press .







### Note

- When a password is set, you need to enter the password to change the “Anti-Theft” setting.

## If You Forget Your Password

If you forget the password, delete it using the following procedure and set a new password.

### Note

Press  →  (VOL) →  (VOL) →  →  (VOL) →  (VOL) → .

- If  is held down for more than 3 seconds, the operation buttons on the projector will be locked. (See page 29.)
- You can only use the buttons on the projector to delete the password.
- The password cannot be deleted using the above described procedures while the “Anti-Theft” function is set. If you forget your password while the “Anti-Theft” function is activated, you will need to contact your nearest Sharp Authorized Projector Dealer or Service Center (see page 73). You may need to bring your projector to them to restore the projector to original factory condition (password and keycode reset).

If you want to change the password, follow the procedure below.





**1** Press ,  and  to enter the password in “Old Password” and press .

**2** Press ,  and  to set the new password and press .

**3** Enter the new 4-digit password again in “Reconfirm” and press .

### Note

- If you do not want to set a password, leave the fields in steps 2 and 3 blank and press .
- To cancel the password settings, press .

## **Anti-Theft (Setting the Anti-Theft)**

The anti-theft function prevents unauthorized use of the projector. You can choose to use this function or not. If you do not want to use this function, just do not enter the keycode. Once the anti-theft function is activated, users will need to enter the correct keycode each time the projector is turned on. Failure to enter the correct keycode will cause images to not be projected. The following procedures explain how to use this function.

Setting the menu screen ➡ Page 34

**Example: “Options” menu screen for INPUT 2 (S-Video) mode**



If you want to set the keycode, follow the procedure below.

**1** Select “Anti-Theft” on the “Options” menu, then press  .

- The password input box will appear.

**Password**  - - -

**2** Press ,  and  to enter the password.

- The keycode input box will appear.
- ▼ On-screen display (keycode)



**3** Press any button you like on the remote control or projector to set the first digit in “New Code”.

### Note

- The following buttons on the remote control and projector cannot be set as keycodes:
  - ON button
  - STANDBY button
  - ENTER button
  - UNDO button
  - MENU button
  - FORWARD button
  - BACK button

**4** Enter the remaining 3 digits by pressing any buttons you like.

**5** Enter the same keycode once more in “Reconfirm”.

### Note

**When “Anti-Theft” is set, the keycode inputting box appears after the power is turned on. When it appears, enter the right keycode.**

- Press the buttons on the remote control if the buttons on the remote control are used for setting the keycode. In the same manner, press the buttons on the projector if the buttons on the projector are used for setting the keycode.
- “Anti-Theft” cannot be selected unless “Password” is set. (See page 45.)
- When “Anti-Theft” is selected, the password input box will appear. Enter the keycode after the right password is entered.

### Info

- Once the function is activated, you must remember the correct keycode. We suggest you record the keycode in a safe place where only authorized users have access. If you lose or forget your keycode, you will need to contact your nearest Sharp Authorized Projector Dealer or Service Center (see page 73). You may need to bring your projector to them to restore the projector to original factory condition (password and keycode reset).

If you want to change the keycode, follow the procedure below.

Anti-Theft				
Old Code	-	-	-	-
New Code	-	-	-	-
Reconfirm	-	-	-	-
 END				

 Note

- When “Anti-Theft” is selected, the password input box will appear. After the password has been entered, you can change the keycode.

**1** Press the buttons on the remote control or the projector to enter the preset 4-digit keycode in “Old Code”.

**2** Press any button you like on the remote control or the projector to enter the new keycode.

**3** Enter the same 4-digit keycode in “Reconfirm”.

 Note

- If you do not want to set a keycode, leave the keycode field blank in steps 2 and 3 and press





If you want to clear the keycode input box, follow the procedure below.

▼Keycode input box

Anti-Theft	-	-	-	-
------------	---	---	---	---

 Note

- When “Anti-Theft” is selected, the keycode input box will appear.
- If no keycode is entered, the image will not be displayed, even if the projector receives the input signal.

**1** Press  on the remote control or  on the projector to turn on the projector.

**2** Enter the keycode you set when the keycode input box is displayed.

 Note

- When entering the keycode, press the buttons previously set on the projector or the remote control.

# Using the “Language” Menu





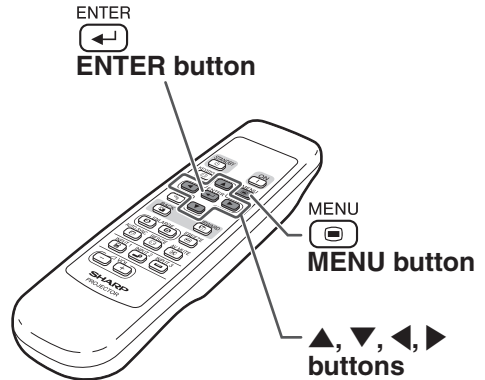

## Selecting the On-screen Display Language

The on-screen display language of the projector can be set to English, German, Spanish, Dutch, French, Italian, Swedish, Portuguese, Chinese, Korean or Japanese.

Display the “Language” menu and select the desired language as the on-screen display.

Example: “Language” menu screen for INPUT 1 (RGB) mode



- 1 Press  on the remote control.**
  - The “Picture” menu will be displayed.
- 2 Press  or  to select the “Language” menu icon.**
  - The “Language” menu will be displayed.
- 3 Press  or  to select the desired language, and then press .**
  - The language you selected will be set as the on-screen display.
- 4 Press .**
  - The “Language” menu will disappear.

### Note

- This procedure can also be performed by using the buttons on the projector.

# Using the “PRJ Mode” Menu

## Reversing the Projected Image

You can reverse the projected image for various applications using the “PRJ Mode” menu.

Display the “PRJ Mode” menu and select the desired projection mode.

Example: “PRJ Mode” menu screen for INPUT 1 (RGB) mode

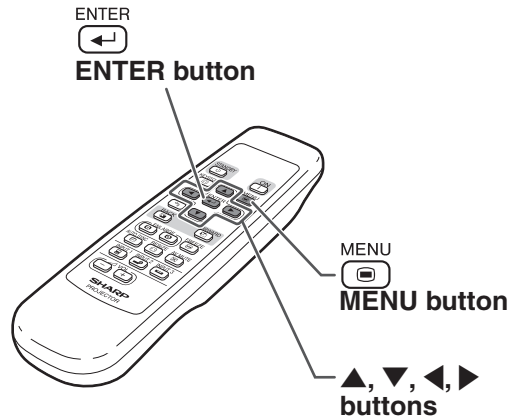
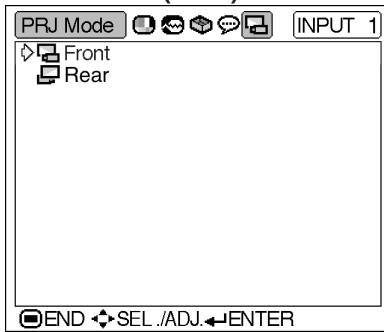



**1** Press <sup>MENU</sup>  on the remote control.  
• The “Picture” menu will be displayed.

**2** Press ◀ or ▶ to select the “PRJ Mode” menu icon.  
• The “PRJ Mode” menu will be displayed.

**3** Press ▲ or ▼ to select “Rear”, and then press <sup>ENTER</sup> .

• The projected image will be reversed.

### Description of Projection Modes

Selectable settings	Description
 Front	Normal image
 Rear	Reversed image

**4** Press <sup>MENU</sup> .

• The “PRJ Mode” menu will disappear.

### Note

- This function is used for the reversed image setup. See page 58 for this setup.
- This procedure can also be performed by using the buttons on the projector.

# Connecting the Projector to Other Devices

## Before Connecting



Note

- Before connecting, be sure to unplug the power cord of the projector from the AC outlet and turn off the devices to be connected. After making all connections, turn on the projector and then the other devices. When connecting a computer, be sure that it is the last device to be turned on after all the connections are made.
- Be sure to read the operation manuals of the devices to be connected before making connections.

### This projector can be connected to:

#### A computer using:

- An RGB cable and a  $\phi$ 3.5 mm stereo or mono audio cable (commercially available) (See page 51.)
- A DIN-D-sub RS-232C adaptor (AN-A1RS) (sold separately) and an RS-232C serial control cable (AN-C10RS) (sold separately) (See page 54.)

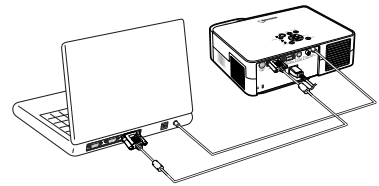

#### Component video or audio-visual equipment:

- A VCR, Laser disc player or other audio-visual equipment (See page 52.)
- A DVD player or DTV\* decoder (See page 53.)

\*DTV is the umbrella term used to describe the new digital television system in the United States.

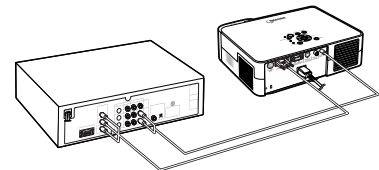
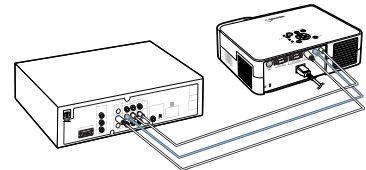

#### A monitor using :

- Two RGB cables (One is supplied, the other is sold separately) (See page 55.)

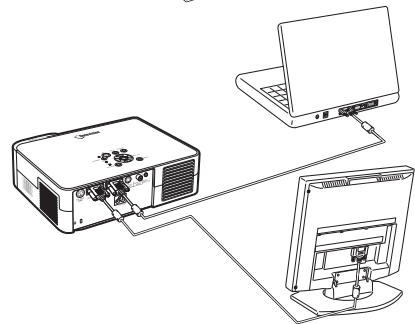

## Connecting the thumbscrew cables

- Connect the thumbscrew cable making sure that it fits correctly into the terminal. Then, firmly secure the connectors by tightening the screws on both sides of the plug.
- Do not remove ferrite cores attached to the RGB cable.

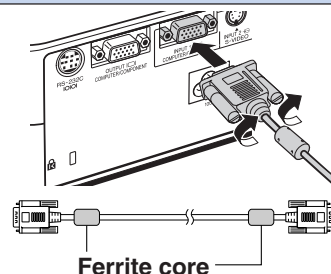

# Connecting the Projector to a Computer

## Connecting to a Computer Using the RGB Cable

- 1 Connect the projector to the computer using the supplied RGB cable.
  - Secure the connectors by tightening the thumbscrews.
- 2 To input an audio signal, connect the projector to the computer using a  $\varnothing 3.5$  mm stereo or mono audio cable (commercially available or available as Sharp service part QCNWGA038WJPZ).

### Note

- If the projector does not automatically detect a RGB signal, the projected image will appear distorted. To correct, change the menu setting from “Auto” to “RGB”. The menu setting can be found in the “Picture” menu. See page 38.
- See page 70 “Computer Compatibility Chart” for a list of computer signals compatible with the projector. Use with computer signals other than those listed may cause some of the functions to not work.
- A Macintosh adaptor may be required for use with some Macintosh computers. Contact your nearest Sharp Authorized Projector Dealer or Service Center.
- Depending on the computer you are using, an image may not be projected unless the signal output setting of the computer is switched to the external output. Refer to the computer operation manual for switching the computer signal output settings.
- When using the  $\varnothing 3.5$  mm mono audio cable, the volume level will be half of when using the  $\varnothing 3.5$  mm stereo audio cable.

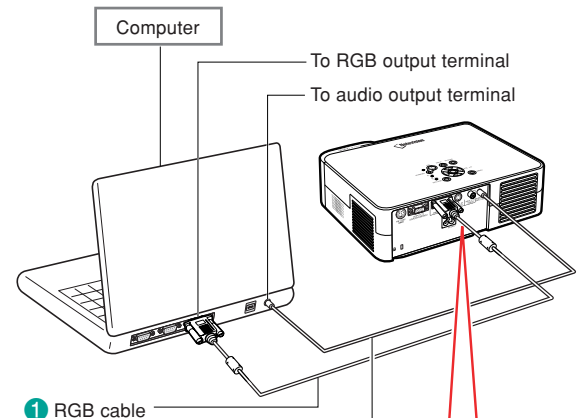
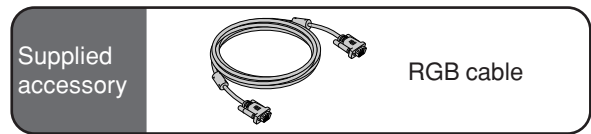

- 1 RGB cable
- 2  $\varnothing 3.5$  mm stereo or mono audio cable (commercially available or available as Sharp service part QCNWGA038WJPZ)

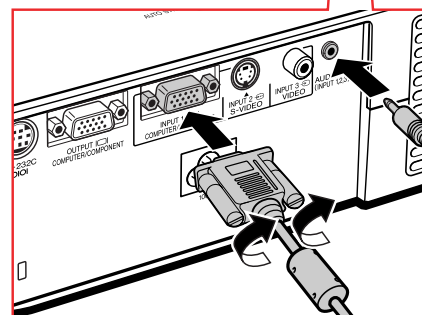

## “Plug and Play” function (when connecting to a 15-pin terminal)

- This projector is compatible with VESA-standard DDC 1/DDC 2B. The projector and a VESA DDC compatible computer will communicate their setting requirements, allowing for quick and easy setup.
- Before using the “Plug and Play” function, be sure to turn on the projector first and the connected computer last.

### Note

- The DDC “Plug and Play” function of this projector operates only when used in conjunction with a VESA DDC compatible computer.

### Connecting to Video Equipment

#### Connecting to Video Equipment Using an S-video, a Composite Video or an Audio Cable

Using an S-video, video, or audio cable, a VCR, laser disc player or other audio-visual equipment can be connected to INPUT 2, INPUT 3 and AUDIO input terminals.

**1** Connect the projector to the video equipment using an S-video cable or a composite video cable (both commercially available).

**2** Connect the projector to the video equipment using a  $\varnothing 3.5$  mm minijack to RCA audio cable (commercially available).

#### Note

- The INPUT 2 (S-VIDEO) terminal uses a video signal system in which the picture is separated into color and luminance signals to realize a higher-quality image. To view a higher-quality image, use a commercially available S-video cable to connect the INPUT 2 terminal on the projector and the S-video output terminal on the video equipment.
- A  $\varnothing 3.5$  mm minijack to RCA audio cable (commercially available) is required for audio input.

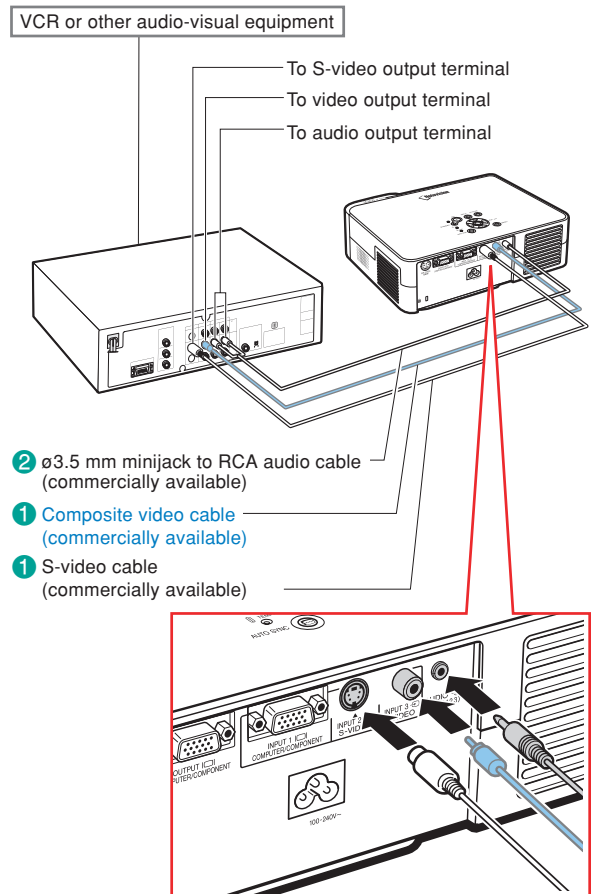



## Connecting to Component Video Equipment

Use a 3 RCA to 15-pin D-sub cable when connecting to the INPUT 1 terminal, component video equipment such as DVD players and DTV\* decoders.

\*DTV is the umbrella term used to describe the new digital television system in the United States.

**1** Connect the projector to the video equipment using the 3 RCA to 15-pin D-sub cable.

- Secure the connectors by tightening the thumbscrews.

**2** Connect the projector to the video equipment using a  $\varnothing 3.5$  mm minijack to RCA audio cable (commercially available).

### Note

- If the projector does not automatically detect a COMPONENT signal, the projected image will appear distorted. To correct, change the menu setting from "Auto" to "Component". The menu setting can be found in the "Picture" menu. See page 38.
- A  $\varnothing 3.5$  mm minijack to RCA audio cable (commercially available) is required for audio input.

Optional cable

3RCA to 15-pin D-sub cable  
AN-C3CP  
(9'10" (3.0 m))

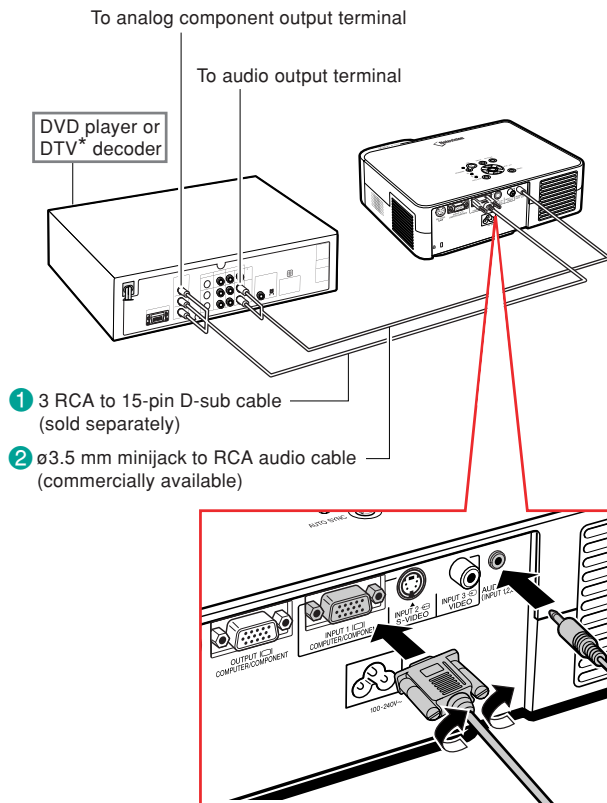

# Controlling the Projector Using a Computer

## Connecting to a Computer Using a DIN-D-sub RS-232C Adaptor and an RS-232C Serial Control Cable

When the RS-232C terminal on the projector is connected to a computer with a DIN-D-sub RS-232C adaptor (sold separately) and an RS-232C serial control cable (cross type, sold separately), the computer can be used to control the projector and check the status of the projector. See page 69 for details.

- 1 Connect a DIN-D-sub RS-232C adaptor (sold separately) to an RS-232C serial control cable (sold separately).
- 2 Use the above cables to connect the projector and the computer.

### Note

- Do not connect the RS-232C cable to a port other than the RS-232C terminal on the computer. This may damage your computer or projector.
- Do not connect or disconnect an RS-232C serial control cable to or from the computer while it is on. This may damage your computer.
- The RS-232C function may not operate if your computer terminal is not correctly set up. Refer to the operation manual of the computer for details.
- See page 68 for connection of an RS-232C serial control cable.

Optional cables	DIN-D-sub RS-232C adaptor AN-A1RS (5 57/64" (15 cm))
	RS-232C serial control cable AN-C10RS (32'10" (10.0 m))

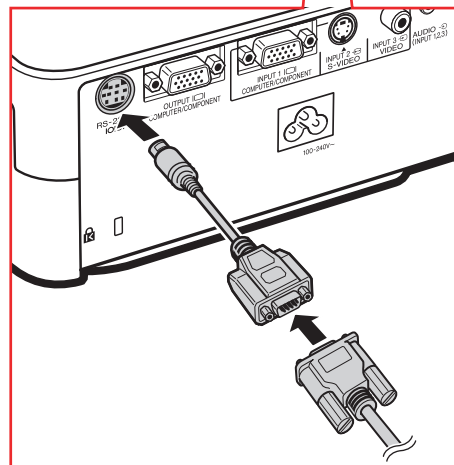
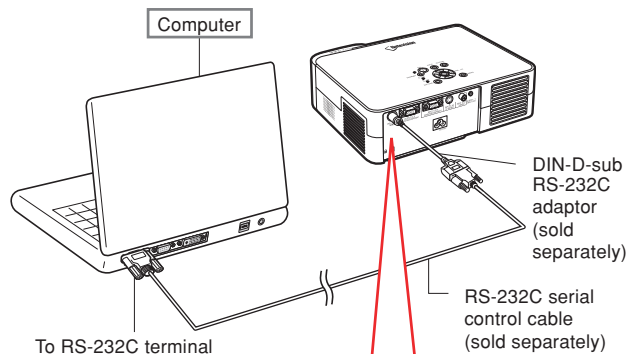

## Connecting to a Monitor

### Watching Images on Both the Projector and a Monitor

You can display computer images on both the projector and a separate monitor using RGB cables.

#### 1 Connect the projector to the computer using the supplied RGB cable.

- Secure the connectors by tightening the thumbscrews.

#### 2 Connect the projector to the monitor using the computer RGB cable (sold separately).

- Secure the connectors by tightening the thumbscrews.

#### Note

- Analog RGB signals as well as Component signals can be output to the monitor.
- For this connection, computer RGB cable (sold separately) is required.

Supplied accessory



RGB cable

Optional cable

Computer RGB cable  
AN-C10BM  
(32'10" (10.0 m))

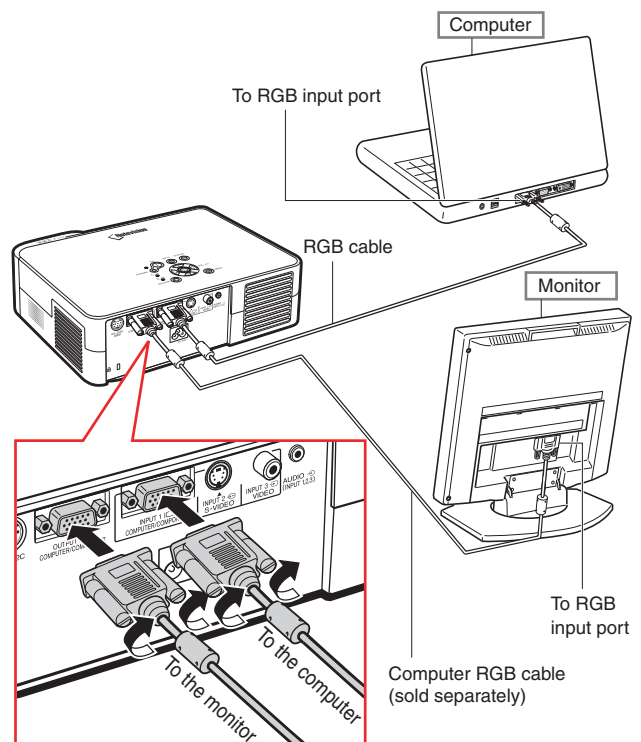

## Connecting the Power Cord to the Projector

### Connecting the Power Cord

Plug the supplied power cord into the AC socket on the rear of the projector.

Supplied accessory

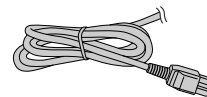

Power cord

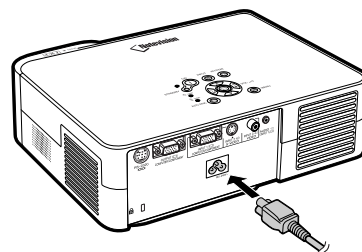

# Setting up the Screen

Position the projector perpendicular to the screen with all feet flat and level to achieve an optimal image.

## Note

- The projector lens should be centered in the middle of the screen. If the horizontal line passing through the lens center is not perpendicular to the screen, the image will be distorted, making viewing difficult.
- For an optimal image, position the screen so that it is not in direct sunlight or room light. Light falling directly on the screen washes out the colors, making viewing difficult. Close the curtains and dim the lights when setting up the screen in a sunny or bright room.
- A polarizing screen cannot be used with this projector.

## Standard Setup (Front Projection)

- Place the projector at the required distance from the screen according to the desired picture size. (See page 57.)

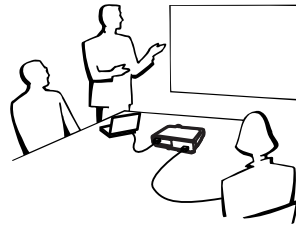

## Example of standard setup

Screen size : 100 inch (254 cm) STRETCH Mode : 16:9

### Side View

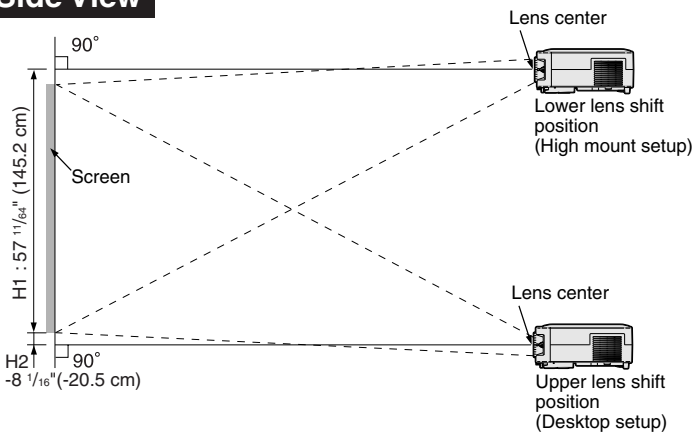

- The distance from the screen to the projector may vary depending on the size of the screen. [P.57](#)

- The default setting can be used, when placing the projector in front of the screen. If the projected image is reversed, readjust the setting to "Front" in the "PRJ Mode" menu. [P.49](#)

### Top View

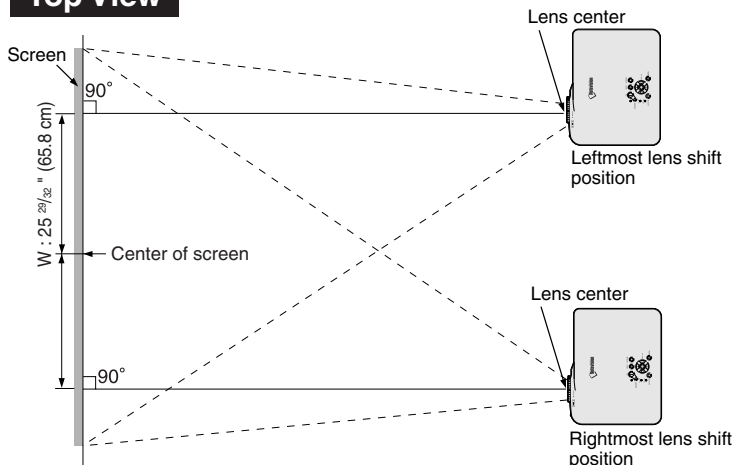

- Place the projector so that an imaginary horizontal line that passes through the center of the lens is perpendicular to the screen.

# Screen Size and Projection Distance

## NORMAL Mode (4:3)

Picture (Screen) size			Projection distance [L]		Distance from the lens center to the bottom of the image [H]		Distance from the lens center to the center of the image [W]
Diag. [χ]	Width	Height	Minimum [L1]	Maximum [L2]	Lower [H1]	Upper [H2]	
300" (762 cm)	610 cm (240")	457 cm (180")	9.0 m (29' 6")	11.3 m (37' 1")	458.1 cm (180 <sup>23</sup> / <sub>64</sub> "	0 cm (0")	±181.1 cm (±71 <sup>19</sup> / <sub>64</sub> "
250" (635 cm)	508 cm (200")	381 cm (150")	7.5 m (24' 7")	9.4 m (30' 10")	381.8 cm (150 <sup>5</sup> / <sub>16</sub> "	0 cm (0")	±150.9 cm (±59 <sup>13</sup> / <sub>32</sub> "
200" (508 cm)	406 cm (160")	305 cm (120")	6.0 m (19' 8")	7.5 m (24' 7")	305.4 cm (120 <sup>15</sup> / <sub>64</sub> "	0 cm (0")	±120.7 cm (±47 <sup>33</sup> / <sub>64</sub> "
150" (381 cm)	305 cm (120")	229 cm (90")	4.5 m (14' 9")	5.6 m (18' 4")	229.1 cm (90 <sup>13</sup> / <sub>64</sub> "	0 cm (0")	±90.5 cm (±35 <sup>5</sup> / <sub>8</sub> "
100" (254 cm)	203 cm (80")	152 cm (60")	3.0 m (9' 10")	3.7 m (12' 2")	152.7 cm (60 <sup>1</sup> / <sub>8</sub> "	0 cm (0")	±60.4 cm (±23 <sup>25</sup> / <sub>32</sub> "
84" (213 cm)	171 cm (67")	128 cm (50")	2.5 m (8' 2")	3.1 m (10' 2")	128.3 cm (50 <sup>33</sup> / <sub>64</sub> "	0 cm (0")	±50.7 cm (±19 <sup>61</sup> / <sub>64</sub> "
72" (183 cm)	146 cm (58")	110 cm (43")	2.1 m (6' 11")	2.7 m (8' 10")	109.9 cm (43 <sup>17</sup> / <sub>64</sub> "	0 cm (0")	±43.5 cm (±17 <sup>1</sup> / <sub>8</sub> "
60" (152 cm)	122 cm (48")	91 cm (36")	1.8 m (5' 11")	2.2 m (7' 3")	91.6 cm (36 <sup>1</sup> / <sub>16</sub> "	0 cm (0")	±36.2 cm (±14 <sup>1</sup> / <sub>4</sub> "
40" (102 cm)	81 cm (32")	61 cm (24")	1.2 m (3' 11")	1.5 m (4' 11")	61.1 cm (24 <sup>1</sup> / <sub>16</sub> "	0 cm (0")	±24.1 cm (±9 <sup>31</sup> / <sub>64</sub> "

χ: Picture size (diag.) (in/cm)

L: Projection distance(m/ft)

L1: Minimum projection distance (m/ft)

L2: Maximum projection distance (m/ft)

H: Distance from the lens center to the bottom of the image (cm/in)

H1: Lower distance from the lens center to the bottom of the image (cm/in)

H2: Upper distance from the lens center to the bottom of the image (cm/in)

W: Distance from the lens center to the center of the image (cm/in)

The formula for picture size and projection distance

[m/cm]

L1 (m) = 0.0302χ - 0.035

L2 (m) = 0.0377χ - 0.035

H1 (cm) = 1.5271χ

H2 (cm) = 0

W (cm) = ±0.6036χ

[Feet/inches]

L1 (ft) = (0.0302χ - 0.035) / 0.3048

L2 (ft) = (0.0377χ - 0.035) / 0.3048

H1 (in) = 1.5271χ / 2.54

H2 (in) = 0

W (in) = ±0.6036χ / 2.54

## STRETCH Mode (16:9)

Picture (Screen) size			Projection distance [L]		Distance from the lens center to the bottom of the image [H]		Distance from the lens center to the center of the image [W]
Diag. [χ]	Width	Height	Minimum [L1]	Maximum [L2]	Lower [H1]	Upper [H2]	
300" (762 cm)	664 cm (261")	374 cm (147")	9.8 m (32' 2")	12.3 m (40' 4")	435.6 cm (171 <sup>1</sup> / <sub>2</sub> "	-61.4 cm (-24 <sup>11</sup> / <sub>64</sub> "	±197.4 cm (±77 <sup>23</sup> / <sub>32</sub> "
250" (635 cm)	553 cm (218")	311 cm (123")	8.2 m (26' 11")	10.2 m (33' 6")	363.0 cm (142 <sup>29</sup> / <sub>32</sub> "	-51.2 cm (-20 <sup>5</sup> / <sub>32</sub> "	±164.5 cm (±64 <sup>49</sup> / <sub>64</sub> "
225" (572 cm)	498 cm (196")	280 cm (110")	7.4 m (24' 3")	9.2 m (30' 2")	326.7 cm (128 <sup>5</sup> / <sub>8</sub> "	-46.1 cm (-18 <sup>5</sup> / <sub>32</sub> "	±148.0 cm (±58 <sup>17</sup> / <sub>64</sub> "
200" (508 cm)	443 cm (174")	249 cm (98")	6.5 m (21' 4")	8.2 m (26' 11")	290.4 cm (114 <sup>21</sup> / <sub>64</sub> "	-40.9 cm (-16 <sup>7</sup> / <sub>64</sub> "	±131.6 cm (±51 <sup>13</sup> / <sub>16</sub> "
150" (381 cm)	332 cm (131")	187 cm (74")	4.9 m (16' 1")	6.1 m (20' )	217.8 cm (85 <sup>3</sup> / <sub>4</sub> "	-30.7 cm (-12 <sup>3</sup> / <sub>32</sub> "	±98.7 cm (±38 <sup>55</sup> / <sub>64</sub> "
133" (338 cm)	294 cm (116")	166 cm (65")	4.3 m (14' 1")	5.4 m (17' 9")	193.1 cm (76 <sup>1</sup> / <sub>32</sub> "	-27.2 cm (-10 <sup>45</sup> / <sub>64</sub> "	±87.5 cm (±34 <sup>29</sup> / <sub>64</sub> "
106" (269 cm)	235 cm (92")	132 cm (52")	3.5 m (11' 6")	4.3 m (14' 1")	153.9 cm (60 <sup>19</sup> / <sub>32</sub> "	-21.7 cm (-8 <sup>35</sup> / <sub>64</sub> "	±69.7 cm (±27 <sup>7</sup> / <sub>16</sub> "
100" (254 cm)	221 cm (87")	125 cm (49")	3.3 m (10' 10")	4.1 m (13' 5")	145.2 cm (57 <sup>11</sup> / <sub>64</sub> "	-20.5 cm (-8 <sup>5</sup> / <sub>64</sub> "	±65.8 cm (±25 <sup>29</sup> / <sub>32</sub> "
92" (234 cm)	204 cm (80")	115 cm (45")	3.0 m (9' 10")	3.7 m (12' 2")	133.6 cm (52 <sup>19</sup> / <sub>32</sub> "	-18.8 cm (-7 <sup>13</sup> / <sub>32</sub> "	±60.5 cm (±23 <sup>13</sup> / <sub>16</sub> "
84" (213 cm)	186 cm (73")	105 cm (41")	2.7 m (8' 10")	3.4 m (11' 2")	122.0 cm (48 <sup>1</sup> / <sub>32</sub> "	-17.2 cm (-6 <sup>49</sup> / <sub>64</sub> "	±55.3 cm (±21 <sup>49</sup> / <sub>64</sub> "
72" (183 cm)	159 cm (63")	90 cm (35")	2.3 m (7' 7")	2.9 m (9' 6")	104.6 cm (41 <sup>3</sup> / <sub>16</sub> "	-14.7 cm (-5 <sup>25</sup> / <sub>32</sub> "	±47.4 cm (±18 <sup>21</sup> / <sub>32</sub> "
60" (152 cm)	133 cm (52")	75 cm (29")	1.9 m (6' 3")	2.4 m (7' 10")	87.1 cm (34 <sup>19</sup> / <sub>64</sub> "	-12.3 cm (-4 <sup>27</sup> / <sub>32</sub> "	±39.5 cm (±15 <sup>35</sup> / <sub>64</sub> "
40" (102 cm)	89 cm (35")	50 cm (20")	1.3 m (4' 3")	1.6 m (5' 3")	58.1 cm (22 <sup>7</sup> / <sub>8</sub> "	-8.2 cm (-3 <sup>15</sup> / <sub>64</sub> "	±26.3 cm (±10 <sup>23</sup> / <sub>64</sub> "

χ: Picture size (diag.) (in/cm)

L: Projection distance(m/ft)

L1: Minimum projection distance (m/ft)

L2: Maximum projection distance (m/ft)

H: Distance from the lens center to the bottom of the image (cm/in)

H1: Lower distance from the lens center to the bottom of the image (cm/in)

H2: Upper distance from the lens center to the bottom of the image (cm/in)

W: Distance from the lens center to the center of the image (cm/in)

The formula for picture size and projection distance

[m/cm]

L1 (m) = 0.0329χ - 0.035

L2 (m) = 0.041χ - 0.035

H1 (cm) = 1.452χ

H2 (cm) = -0.2047χ

W (cm) = ±0.6579χ

[Feet/inches]

L1 (ft) = (0.0329χ - 0.035) / 0.3048

L2 (ft) = (0.041χ - 0.035) / 0.3048

H1 (in) = 1.452χ / 2.54

H2 (in) = -0.2047χ / 2.54

W (in) = ±0.6579χ / 2.54



Note

- There may be an error of ± 3% in the above values.
- Values with a minus (-) sign indicate the distance from the lens center below the bottom of the image.

### Projecting a Reversed Image

#### Projection from behind the Screen

- Place a translucent screen between the projector and the audience.
- Reverse the image by setting "Rear" in the "PRJ Mode" menu. (See page 49.)

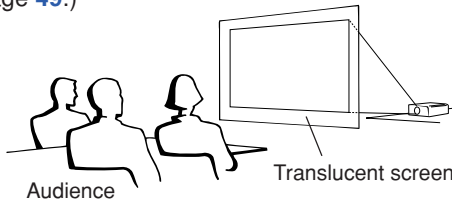

#### Projection Using a Mirror

- Place a mirror (normal flat type) in front of the lens.
- When the translucent screen is placed on between the mirror and audience, set to "Front" in the "PRJ Mode" menu. (See page 49.)
- When the mirror is placed on the audience side, set to "Rear" in the "PRJ Mode" menu. (See page 49.)

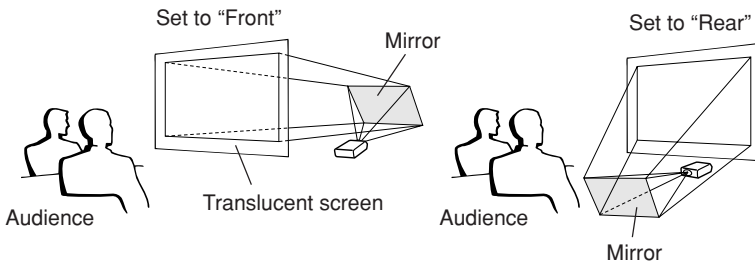

#### Info

- When using a mirror, be sure to carefully position both the projector and the mirror so the light does not shine into the eyes of the audience.

#### Ceiling-mount Setup

- It is recommended that you use the optional Sharp ceiling-mount bracket for this installation. Before mounting the projector, contact your nearest Sharp Authorized Projector Dealer or Service Center to obtain the recommended ceiling-mount bracket (sold separately).
  - AN-B10T ceiling-mount bracket, its AN-TK201 and AN-TK202 extension tubes (for countries other than the U.S.A.).
- Be sure to adjust the position of the projector to match the distance (H) from the lens center position (see page 57) to the lower edge of the image, when mounting the projector on the ceiling.
- Do not mount the projector upside down.

When the image is projected from behind the screen using the default setting.

#### ▼ On-screen Display

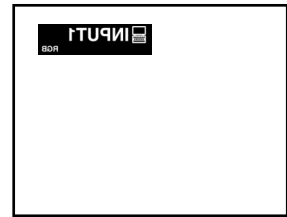

Set to "Rear".



#### ▼ On-screen Display

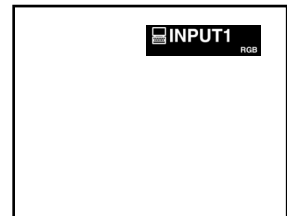

The image is reversed.

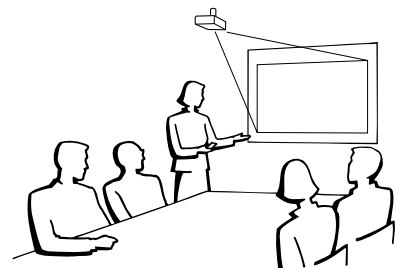

# Carrying the Projector

## How to Use the Carrying Case

When carrying the projector, attach the lens cap and the lens shipping block to the lens, and place it in the supplied carrying case.

**1** Open the cover of the carrying case.

**2** Remove the inner padding from the carrying case, and fold it in the direction of the arrows.

**3** Reinsert the inner padding into the carrying case.

### Info

- Be sure to insert the inner padding to protect the lens and the projector.

**4** Place the projector and the accessories in the carrying case.

### Info

- Be sure to attach the lens cap and the lens shipping block to protect the lens. (See pages 10 and 11.)
- Be sure the projector has cooled down sufficiently before placing it in the case.

### Info

- This carrying case is only for storing and carrying the projector.
- Sending the projector in the carrying case as a parcel may cause damage to the projector. If you send the projector in the carrying case as a parcel, be sure to place it in a sturdy case and with enough shock absorbing material to avoid any damage.
- Do not expose the carrying case or projector to direct sunlight, near heat sources, or leave them in a car. The carrying case or projector may change color or become deformed.

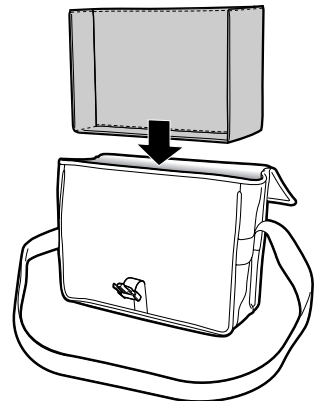
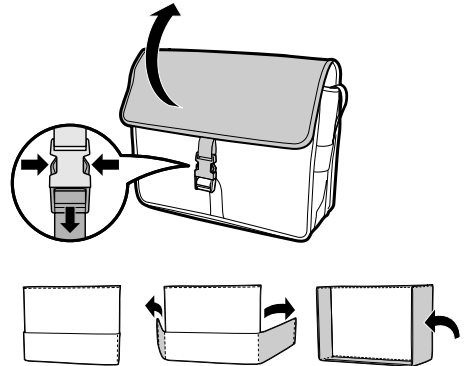

Lens cap    Lens shipping block

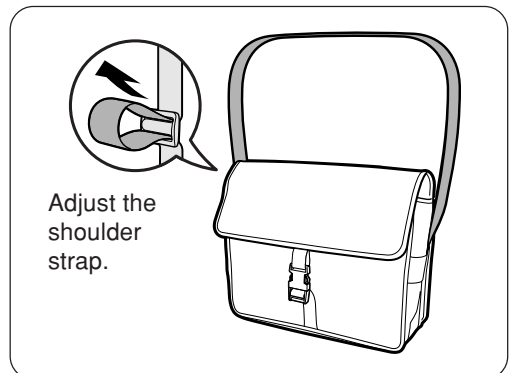
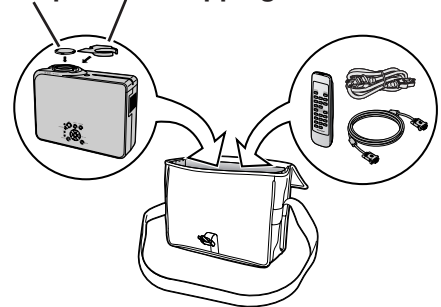

# Maintenance

## Cleaning the projector

- Be sure to unplug the power cord before cleaning the projector.
- The cabinet as well as the operation panel is made of plastic. Avoid using benzene or thinner, as these can damage the finish on the cabinet.
- Do not use volatile agents such as insecticides on the projector.

Do not attach rubber or plastic items to the projector for a long time.

The effects of some of the agents in the plastic may cause damage to the quality or finish of the projector.



- Wipe off dirt gently with a soft flannel cloth.

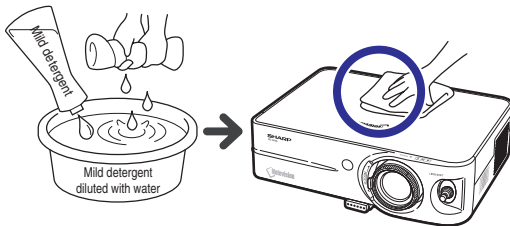

- When the dirt is hard to remove, soak a cloth in a mild detergent diluted with water, wring the cloth well and then wipe the projector. Strong cleaning detergents may discolor, warp or damage the coating on the projector. Make sure to test on a small, inconspicuous area on the projector before use.

## Cleaning the lens

- Use a commercially available blower or lens cleaning paper (for glasses and camera lenses) for cleaning the lens. Do not use any liquid type cleaning agents, as they may wear off the coating film on the surface of the lens.
- As the surface of the lens can easily get damaged, be sure not to scrape or hit the lens.

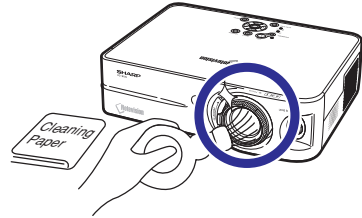

## Cleaning the exhaust and intake vents

- Use a vacuum cleaner to clean dust from the exhaust vent and the intake vent.

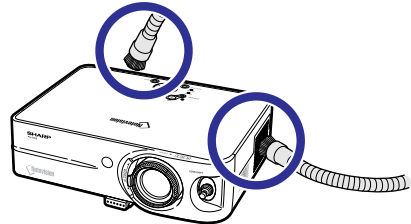



# Replacing the Air Filter

- This projector is equipped with air filters to ensure the optimal operating condition of the projector.
- The air filters should be cleaned every 100 hours of use. Clean the filters more often when the projector is used in a dusty or smoky location.
- Ask your nearest Sharp Authorized Projector Dealer or Service Center to exchange the filter (PFILDA010WJZZ) when it is no longer possible to clean.

## Cleaning and Replacing the Air Filter

- 1** Press **STANDBY**  on the projector or **STANDBY**  on the remote control to put the projector into the standby mode.

- Wait until the cooling fan stops.

- 2** Disconnect the power cord.

- Unplug the power cord from the AC socket.

- 3** Remove the filter cover.

- Turn the projector over. Loosen the user service screw (①) that secures the filter cover. Pressing the tab, remove the filter cover (②).

▼ Bottom view

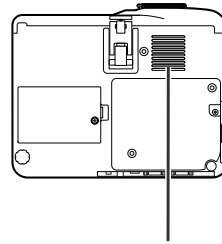

Air filter (not removable)

▼ Front view



Air filter (removable)

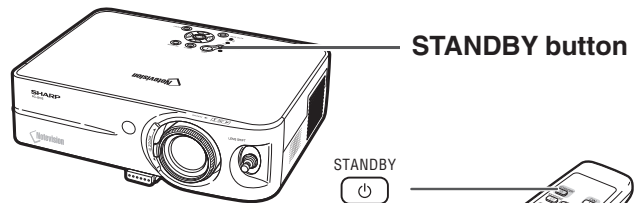

STANDBY

 STANDBY button

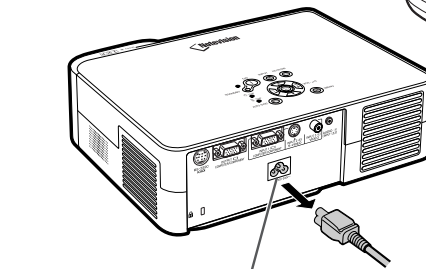

AC socket

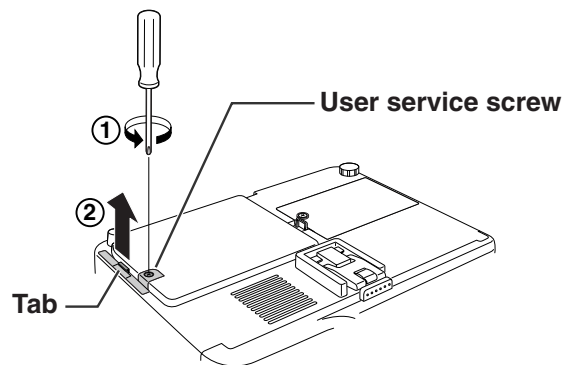

User service screw

①

②

Tab

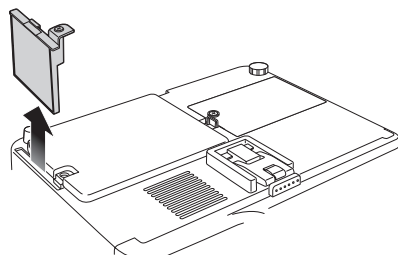

## Replacing the Air Filter

### 4 Remove the air filter.

- Pick the air filter up with your fingers and lift it out of the filter cover.

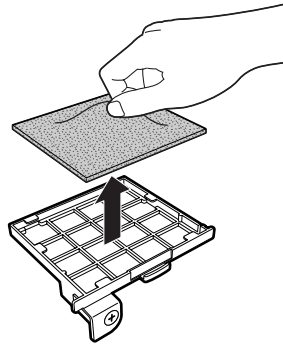

### 5 Clean the air filter.

- Clean the dust off the air filter and cover with a vacuum cleaner extension hose.



### 6 Replace the air filter.

- Place the air filter underneath the tabs on the filter cover.

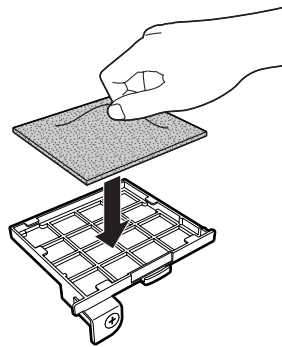

### 7 Replace the filter cover.

- Align the tab on the filter cover and place it while pressing the tab to close it (1). Then tighten the user service screw (2) to secure the filter cover.

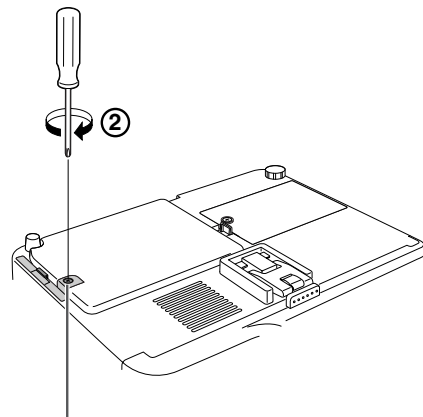
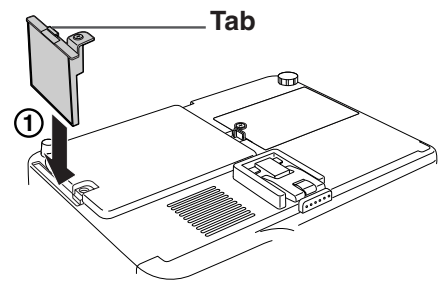

#### Note

- Be sure the filter cover is securely installed. The power will not turn on unless it is correctly installed.
- If dust or dirt has collected inside the rear and bottom air filters (not removable), clean the filter with a vacuum cleaner extension hose.

User service screw

# Maintenance Indicators

- The warning lights on the projector indicate problems inside the projector.
- If a problem occurs, either the temperature warning indicator or the lamp indicator will illuminate red, and the projector will enter the standby mode. After the projector has entered the standby mode, follow the procedures given below.

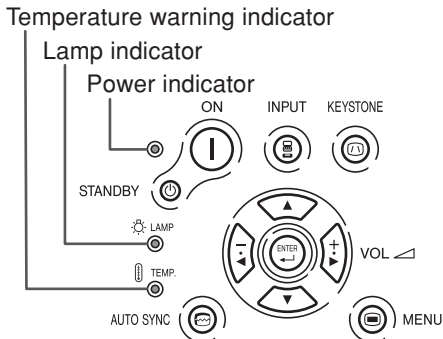

## About the temperature warning indicator

If the temperature inside the projector increases, due to blockage of the air vents, or the setting location, "TEMP." will illuminate in the lower left corner of the picture. If the temperature keeps on rising, the lamp will turn off and the temperature warning indicator will blink, the cooling fan will run for a further 90 seconds, and then the projector will enter the standby mode. After "TEMP." appears, be sure to perform the following measures.



## About the lamp indicator



- The lamp life becomes 0%, when used for approximately 4,000 hours with "Eco Mode" or when used for approximately 2,000 hours with "Standard Mode" (see page 43).
- When the remaining lamp life becomes 5% or less, "TEMP." (yellow) will be displayed on the screen. When the percentage becomes 0%, "TEMP." will change to "LAMP." (red), the lamp will automatically turn off and then the projector will automatically enter the standby mode. At this time, the lamp indicator will illuminate in red.
- If you try to turn on the projector a fourth time without replacing the lamp, the projector will not turn on.

Maintenance indicator	Condition		Problem	Possible Solution
	Normal	Abnormal		
Temperature warning indicator	Off	Red on/ Standby	<ul style="list-style-type: none"> <li>Blocked air intake</li> <li>Cooling fan breakdown</li> <li>Internal circuit failure</li> <li>Clogged air intake</li> </ul>	<ul style="list-style-type: none"> <li>Relocate the projector to an area with proper ventilation.</li> <li>Clean the air filter of the projector. (See page 61.)</li> <li>Take the projector to your nearest Sharp Authorized Projector Dealer or Service Center (see page 73) for repair.</li> </ul>
Lamp indicator	Green on (Green blinks when the lamp is warming up.)	Red on/ Standby	<ul style="list-style-type: none"> <li>Remaining lamp life becomes 5% or less.</li> <li>Burnt-out lamp</li> <li>Lamp circuit failure</li> </ul>	<ul style="list-style-type: none"> <li>Carefully replace the lamp. (See page 66.)</li> <li>Take the projector to your nearest Sharp Authorized Projector Dealer or Service Center (see page 73) for repair.</li> <li>Please exercise care when replacing the lamp.</li> </ul>
Power indicator	Green on/ Red on	Red blinks	<ul style="list-style-type: none"> <li>The filter cover or lamp unit cover is open.</li> </ul>	<ul style="list-style-type: none"> <li>Securely install the cover.</li> <li>If the power indicator blinks in red even when the filter cover and lamp unit cover is securely installed, contact your nearest Sharp Authorized Projector Dealer or Service Center for advice.</li> </ul>

### Info

- If the temperature warning indicator illuminates, and the projector enters the standby mode, follow the possible solutions on the previous page and then wait until the projector has cooled down completely before plugging in the power cord and turning the power back on. (At least 5 minutes.)
- If the power is turned off for a brief moment due to power outage or some other cause while using the projector, and the power supply recovers immediately after that, the lamp indicator will illuminate in red and the lamp may not be lit. In this case, unplug the power cord from the AC outlet, replace the power cord in the AC outlet and then turn the power on again.
- If you want to clean the air vents during projector operation, be sure to put the projector into the standby mode. After the cooling fan has stopped, clean the vents.
- The cooling fan keeps the internal temperatures of the projector constant and this function is controlled automatically. The sound of the cooling fan may change during operation because the fan speed may change and this is not a malfunction.
- Do not unplug the power cord after the projector has entered the standby mode and while the cooling fan is running. The cooling fan runs for about 90 seconds.

# Regarding the Lamp

## Lamp

- It is recommended that the lamp (sold separately) be replaced when the remaining lamp life becomes 5% or less, or when you notice a significant deterioration in the picture and color quality. The lamp life (percentage) can be checked with the on-screen display. See page 41.
- For lamp replacement, please consult your nearest Sharp Authorized Projector Dealer or Service Center.

### IMPORTANT NOTE TO U.S. CUSTOMERS:

The lamp included with this projector is backed by a 90-day parts and labor limited warranty. All service of this projector under warranty, including lamp replacement, must be obtained through a Sharp Authorized Projector Dealer or Service Center. For the name of the nearest Sharp Authorized Projector Dealer or Service Center, please call toll-free: 1-888-GO-SHARP (1-888-467-4277). U.S.A. ONLY

## Caution Concerning the Lamp

- This projector utilizes a pressurized mercury lamp. A loud sound may indicate lamp failure. Lamp failure can be attributed to numerous sources such as: excessive shock, improper cooling, surface scratches or deterioration of the lamp due to a lapse of usage time. The period of time up to failure largely varies depending on the individual lamp and/or the condition and the frequency of use. It is important to note that failure can often result in the bulb cracking.
- When the lamp replacement indicator and on-screen display icon are illuminated, it is recommended that the lamp be replaced with a new one immediately, even if the lamp appears to be operating normally.
- Should the lamp break, the glass particles may spread inside the lamp cage or gas contained in the lamp may be vented into the room from the exhaust vent. Because the gas in this lamp includes mercury, ventilate the room well if the lamp breaks and avoid all exposure to the released gas. In case of exposure to the gas, consult a doctor as soon as possible.
- Should the lamp break, there is also a possibility that glass particles may spread inside of the projector. In such a case, it is recommended you contact your nearest Sharp Authorized Projector Dealer or Service Center to remove the damaged lamp and assure safe operation.

## Replacing the Lamp

### Caution

- Do not remove the lamp unit immediately after operation of the projector. The lamp will be hot and touching it can lead to burn or injury.
- Wait at least one hour after the power cord is disconnected to allow the surface of the lamp unit to fully cool before removing the lamp unit.
- If the new lamp does not light after replacement, take your projector to the nearest Sharp Authorized Projector Dealer or Service Center for repair. Purchase a replacement lamp unit of type BQC-PGB10S//1 from your nearest Sharp Authorized Projector Dealer or Service Center. Then carefully change the lamp by following the instructions described in this section. If you wish, you may have the lamp replaced at your nearest Sharp Authorized Projector Dealer or Service Center.

# Removing and Installing the Lamp Unit

### Info

- Be sure to remove the lamp unit using the handle. Be sure not to touch the glass surface of the lamp unit or the inside of the projector.
- To avoid injury to yourself and damage to the lamp, be sure to carefully follow the steps below.
- Do not loosen other screws except for the lamp unit cover and lamp unit.
- Please refer to the installation manual included with the lamp unit.

- 1 Press  on the projector or  on the remote control to put the projector into the standby mode.**

- Wait until the cooling fan stops.

### Warning!

- Do not remove the lamp unit from the projector right after use. The lamp will be very hot and may cause burn or injury.

- 2 Disconnect the power cord.**

- Unplug the power cord from the AC socket.
- Leave the lamp until it has fully cooled down (about 1 hour).

- 3 Change the air filter.**

- Change the air filter whenever you install the lamp unit (see pages 61 and 62).

- 4 Remove the lamp unit cover.**

- Turn the projector over. Loosen the user service screw (①) that secures the lamp unit cover. Pressing the tab, remove the lamp unit cover (②).

Lamp unit

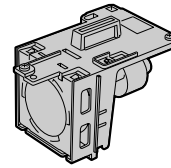

BQC-PGB10S//1

### STANDBY button

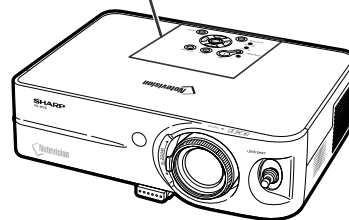
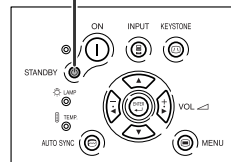

STANDBY

 **STANDBY button**

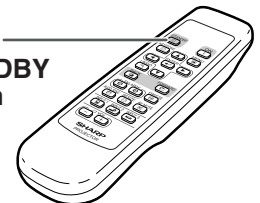

AC socket

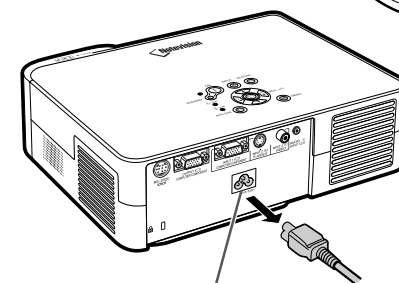

User service screw

Tab

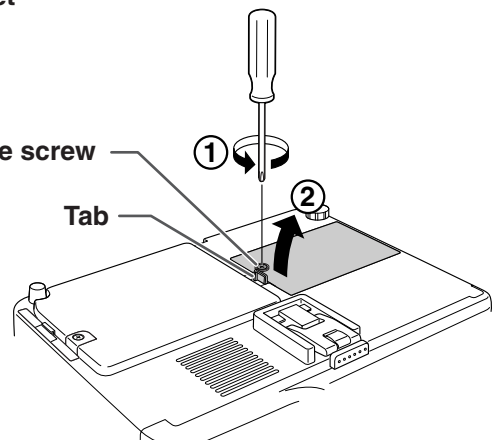

## 5 Remove the lamp unit.

- Loosen the securing screws from the lamp unit. Hold the lamp unit by the handle and pull it in the direction of the arrow. At this time, keep the lamp unit horizontal and do not tilt it.

## 6 Insert the new lamp unit.

- Press the lamp unit firmly into the lamp unit compartment. Fasten the securing screws.

## 7 Replace the lamp unit cover.

- Align the tab on the lamp unit cover (①) and place it while pressing the tab (②) to close it. Then tighten the user service screw (③) to secure the lamp unit cover.

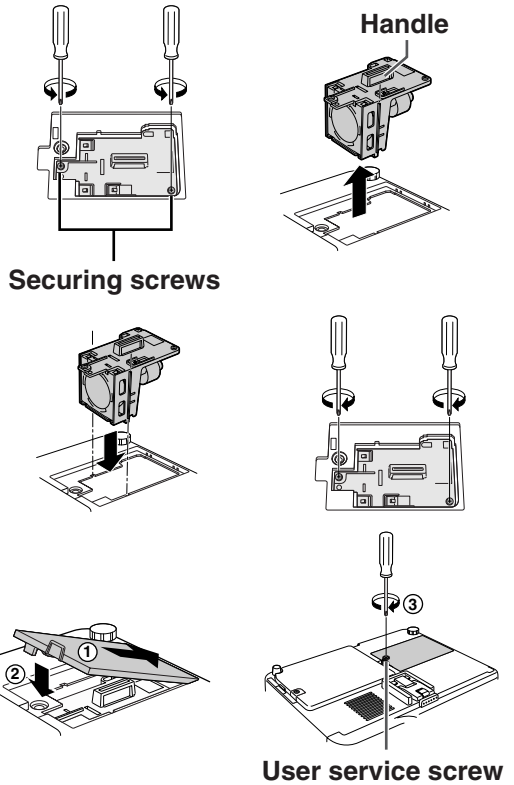

### Info

- If the lamp unit and lamp unit cover are not correctly installed, the power will not turn on, even if the power cord is connected to the projector.





## Resetting the Lamp Timer

Reset the lamp timer after replacing the lamp.

### 1 Connect the power cord.

- Plug the power cord into the AC socket of the projector.

### 2 Reset the lamp timer.

- While simultaneously holding down  and  on the projector, press  and  on the projector.
- "LAMP 0000H" is displayed, indicating that the lamp timer is reset.

### Info

- Make sure to reset the lamp timer only when replacing the lamp. If you reset the lamp timer and continue to use the same lamp, this may cause the lamp to become damaged or explode.

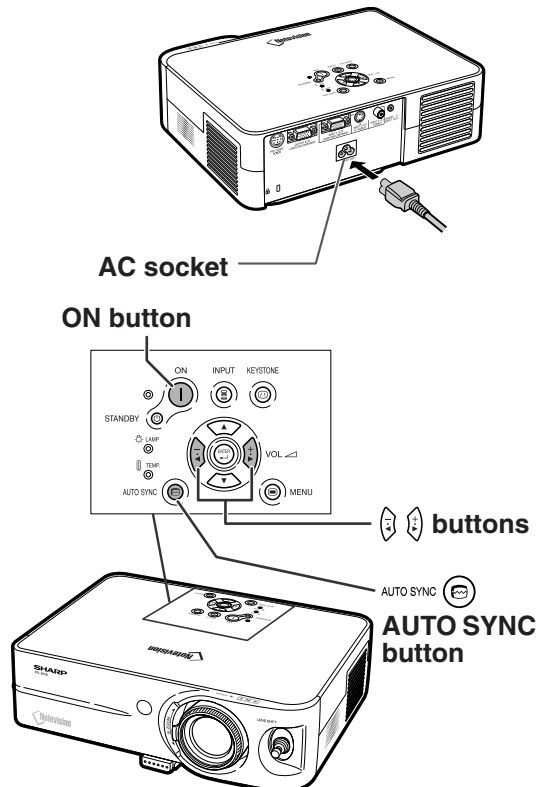

# Connecting Pin Assignments

## INPUT 1 and OUTPUT RGB Signal Terminal: 15-pin Mini D-sub female connector

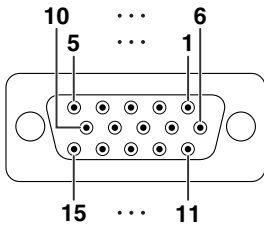

### RGB Input

1. Video input (red)
2. Video input (green/sync on green)
3. Video input (blue)
4. Not connected
5. Not connected
6. Earth (red)
7. Earth (green/sync on green)
8. Earth (blue)
9. Not connected
10. GND
11. Not connected
12. Bi-directional data
13. Horizontal sync signal: TTL level
14. Vertical sync signal: TTL level
15. Data clock

### Component Input

1. P<sub>R</sub> (C<sub>R</sub>)
2. Y
3. P<sub>B</sub> (C<sub>B</sub>)
4. Not connected
5. Not connected
6. Earth (P<sub>R</sub>)
7. Earth (Y)
8. Earth (P<sub>B</sub>)
9. Not connected
10. Not connected
11. Not connected
12. Not connected
13. Not connected
14. Not connected
15. Not connected

## RS-232C Terminal: 9-pin Mini DIN female connector

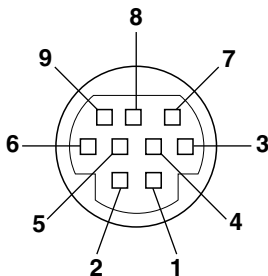

Pin No.	Signal	Name	I/O	Reference
1				Not connected
2	RD	Receive Data	Input	Connected to internal circuit
3	SD	Send Data	Output	Connected to internal circuit
4				Not connected
5	SG	Signal Ground		Connected to internal circuit
6				Not connected
7	RS			Connected to Pin 8
8	CS			Connected to Pin 7
9				Not connected

## DIN-D-sub RS-232C adaptor: 9-pin D-sub male connector

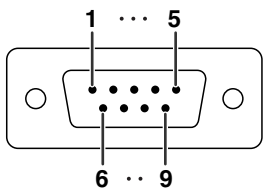

Pin No.	Signal	Name	I/O	Reference
1				Not connected
2	RD	Receive Data	Input	Connected to internal circuit
3	SD	Send Data	Output	Connected to internal circuit
4				Not connected
5	SG	Signal Ground		Connected to internal circuit
6				Not connected
7	RS			Connected to internal circuit
8	CS			Connected to internal circuit
9				Not connected

### Note

- Pin 8 (CS) and Pin 7 (RS) are short circuited inside the projector.

## RS-232C Cable recommended connection: 9-pin D-sub female connector

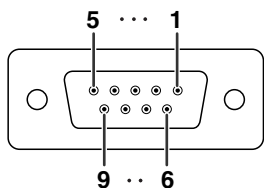

Pin No.	Signal	Pin No.	Signal
1	CD	1	CD
2	RD	2	RD
3	SD	3	SD
4	ER	4	ER
5	SG	5	SG
6	DR	6	DR
7	RS	7	RS
8	CS	8	CS
9	CI	9	CI

### Note

- Depending on the controlling device used, it may be necessary to connect Pin 4 and Pin 6 on the controlling device (e.g. PC).

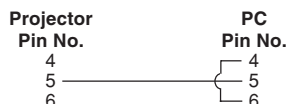



# RS-232C Specifications and Command Settings

## PC control

A computer can be used to control the projector by connecting an RS-232C serial control cable (cross type, sold separately) to the projector. (See page 54 for connection.)

## Communication conditions

Set the serial port settings of the computer to match that of the table.

Signal format: Conforms to RS-232C standard.

Parity bit: None

Baud rate: 9,600 bps

Stop bit: 1 bit

Data length: 8 bits

Flow control: None

## Basic format

Commands from the computer are sent in the following order: command, parameter, and return code. After the projector processes the command from the computer, it sends a response code to the computer.

Command format

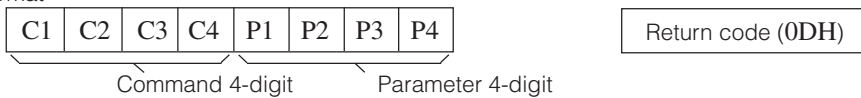

Response code format

Normal response

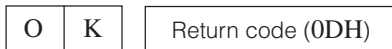

Problem response (communication error or incorrect command)



- When controlling the projector using RS-232C commands from a computer, wait for at least 30 seconds after the power has been turned on, and then transmit the commands.
- When more than one code is being sent, send each command only after the response code for the previous command from the projector is verified.

## Commands

**Example:** When turning on the projector, make the following setting.

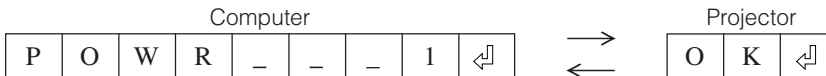

CONTROL CONTENTS	COMMAND	PARAMETER	RETURN
Standby	P O W R	_ _ _	0 OK or ERR
Power On	P O W R	_ _ _	1 OK or ERR
INPUT1	I R G B	_ _ _	1 OK or ERR
INPUT2	I V E D	_ _ _	1 OK or ERR
INPUT3	I V E D	_ _ _	2 OK or ERR
INPUT1 SIGNAL TYPE : AUTO	I A S I	_ _ _	0 OK or ERR
INPUT1 SIGNAL TYPE : RGB	I A S I	_ _ _	1 OK or ERR
INPUT1 SIGNAL TYPE : COMPONENT	I A S I	_ _ _	2 OK or ERR
Lamp Usage Time (hour)	T L T T	_ _ _	1 0-9999
Remaining Lamp Life (Percentage)	T L T L	_ _ _	1 0-100
Lamp Status	T L T S	_ _ _	1 0:Off, 1:On, 2:Retry, 3:Waiting, 4:Lamp Error
Unit Status	T A B N	_ _ _	1 0:Normal, 1:Temp High, 2:Fan Err, 4:Filter or lamp Cover Err, 8:Lamp Life 5% or less, 16:Lamp Burnt-out, 32:Lamp Not Lit, 64:Temp Abnormally High
Model Name Check	T N A M	_ _ _	1 PROJECTOR NAME
AV Mute Off	I M B K	_ _ _	0 OK or ERR
AV Mute On	I M B K	_ _ _	1 OK or ERR
Auto Sync Start	A D J S	_ _ _	1 OK or ERR



- If an underbar ( \_ ) appears in the parameter column, enter a space. If an asterisk ( \* ) appears, enter a value in the range indicated in brackets under CONTROL CONTENTS.

# Computer Compatibility Chart

## Computer

- Multiple signal support  
Horizontal Frequency: 15–70 kHz, Vertical Frequency: 43–85 Hz, Pixel Clock: 12–108 MHz
- Compatible with sync on green signal
- SXGA+, SXGA and XGA compatible in [intelligent compression](#)
- Intelligent Compression and Expansion System resizing technology

The following is a list of modes that conform to VESA. However, this projector supports other signals that are not VESA standards.

PC/MAC/WS	Resolution	Horizontal Frequency (kHz)	Vertical Frequency (Hz)	VESA Standard	Display		
PC	VGA	640 × 350	27.0	60		Upscale	
			31.5	70			
			37.5	85	✓		
		640 × 400	27.0	60			
			31.5	70			
			37.9	85	✓		
		720 × 350	27.0	60			
			31.5	70			
			27.0	60			
		640 × 480	720 × 400	31.5	70		
				27.0	60		
				37.9	85		✓
	800 × 600		SVGA	26.2	50		
				31.5	60	✓	
				34.7	70		
		XGA	1,024 × 768	37.9	72	✓	
				37.5	75	✓	
				43.3	85	✓	
			1,152 × 864	SXGA	31.4	50	
					35.1	56	✓
					37.9	60	✓
	Intelligent Compression	800 × 600	46.6	70			
			48.1	72	✓		
			46.9	75	✓		
			53.7	85	✓		
			1,024 × 768	XGA	35.5	43	
					40.3	50	
		48.4			60	✓	
		56.5			70	✓	
		60.0			75	✓	
68.7		85			✓		
1,152 × 864		SXGA	55.0	60			
			66.2	70			
	67.5		75	✓			
	1,280 × 1,024	SXGA+	64.0	60	✓		
			64.0	60			
			64.0	60			
MAC 13"	VGA	640 × 480	34.9	67	Upscale		
MAC 16"	SVGA	832 × 624	49.7	75			
MAC 19"	XGA	1,024 × 768	60.2	75			
MAC 21"	SXGA	1,152 × 870	68.7	75	Intelligent Compression		





## Note

- This projector may not be able to display images from notebook computers in simultaneous (CRT/LCD) mode. Should this occur, turn off the LCD display on the notebook computer and output the display data in "CRT only" mode. Details on how to change display modes can be found in your notebook computer's operation manual.
- When this projector receives 640 × 350 VESA format VGA signals, "640 × 400" appears on the screen.
- When projecting the RGB interlace signal using INPUT 1 with "Signal Type" set to "Auto" or "RGB", the image may not be projected as desired. In this case, select either INPUT 2 (S-Video) or INPUT 3 (Video).

## DTV

Signal	Horizontal Frequency (kHz)	Vertical Frequency (Hz)
480I	15.7	60
480P	31.5	60
540P	33.8	60
580I	15.6	50
580P	31.3	50
720P	45.0	60
1035I	28.1	50
1035I	33.8	60
1080I	28.1	50
1080I	33.8	60

# Troubleshooting

Problem	Check	Page
 <p>No picture and no sound or projector does not start.</p>	<ul style="list-style-type: none"> <li>• Projector power cord is not plugged into the wall outlet.</li> </ul>	55
	<ul style="list-style-type: none"> <li>• Power to the external connected devices is off.</li> </ul>	—
	<ul style="list-style-type: none"> <li>• The selected input mode is wrong.</li> </ul>	19
	<ul style="list-style-type: none"> <li>• The AV MUTE function is working.</li> </ul>	20
	<ul style="list-style-type: none"> <li>• Cables incorrectly connected to rear panel of the projector.</li> </ul>	51-55
	<ul style="list-style-type: none"> <li>• Remote control batteries have run out.</li> </ul>	15
	<ul style="list-style-type: none"> <li>• External output has not been set when connecting notebook computer.</li> </ul>	51
	<ul style="list-style-type: none"> <li>• The filter cover or the lamp unit cover is not installed correctly.</li> </ul>	61,66
	<ul style="list-style-type: none"> <li>• Cables incorrectly connected to the rear panel of the projector.</li> <li>• “Bright” is set to minimum position.</li> </ul>	51-55 36
 <p>Sound is heard but no picture appears.</p>	<ul style="list-style-type: none"> <li>• Picture adjustments are incorrectly set.</li> </ul>	36
	(Video Input only) <ul style="list-style-type: none"> <li>• Video input system is incorrectly set.</li> </ul>	42
	(INPUT 1 only) <ul style="list-style-type: none"> <li>• Input signal type (RGB/Component) is incorrectly set.</li> </ul>	38
 <p>Color is faded or poor.</p>	<ul style="list-style-type: none"> <li>• Adjust the focus.</li> </ul>	22
	<ul style="list-style-type: none"> <li>• The projection distance exceeds the focus range.</li> </ul>	57
 <p>Picture is blurred; noise appears.</p>	(Computer Input only) <ul style="list-style-type: none"> <li>• Perform “Fine Sync” Adjustments (“Clock” Adjustment)</li> <li>• Perform “Fine Sync” Adjustments (“Phase” Adjustment)</li> <li>• Noise may appear depending on the computer.</li> </ul>	39 39 —
	<ul style="list-style-type: none"> <li>• Cables incorrectly connected to rear panel of projector.</li> </ul>	51-55
	<ul style="list-style-type: none"> <li>• Volume is set to minimum.</li> </ul>	19
<p>An unusual sound is occasionally heard from the cabinet.</p>	<ul style="list-style-type: none"> <li>• If the picture is normal, the sound is due to cabinet shrinkage caused by room temperature changes. This will not affect operation or performance.</li> </ul>	—
<p>Maintenance indicator illuminates.</p>	<ul style="list-style-type: none"> <li>• See “Maintenance Indicators”.</li> </ul>	63
<p>The projector cannot be turned on or put into the standby mode using the ON or STANDBY button on the projector.</p>	<ul style="list-style-type: none"> <li>• The keylock is set. If the keylock is set to ON, all the buttons are locked.</li> </ul>	29



## Troubleshooting

Problem	Check	Page
Picture is green on INPUT 1 COMPONENT.	• Change the input signal type setting.	38
Picture is pink (no green) on INPUT 1 RGB.		
Picture is dark.	• The lamp indicator is illuminating in red. Replace the lamp.	63
Picture is too bright and whitish.	• Picture adjustments are incorrectly set.	36

# For SHARP Assistance

If you encounter any problems during setup or operation of this projector, first refer to the “Troubleshooting” section on pages 71 and 72. If this operation manual does not answer your question, please contact the SHARP Service departments listed below.

<b>U.S.A.</b>	<b>Sharp Electronics Corporation</b> 1-888-GO-SHARP (1-888-467-4277) lcdsupport@sharpsec.com <a href="http://www.sharplcd.com">http://www.sharplcd.com</a>	<b>Benelux</b>	<b>SHARP Electronics Benelux BV</b> 0900-SHARPC (0900-7427723) Nederland 9900-0159 Belgium <a href="http://www.sharp.nl">http://www.sharp.nl</a> <a href="http://www.sharp.be">http://www.sharp.be</a> <a href="http://www.sharp.lu">http://www.sharp.lu</a>
<b>Canada</b>	<b>Sharp Electronics of Canada Ltd.</b> (905) 568-7140 <a href="http://www.sharp.ca">http://www.sharp.ca</a>	<b>Australia</b>	<b>Sharp Corporation of Australia Pty. Ltd.</b> 1300-135-022 <a href="http://www.sharp.net.au">http://www.sharp.net.au</a>
<b>Mexico</b>	<b>Sharp Electronics Corporation Mexico Branch</b> (525) 716-9000 <a href="http://www.sharp.com.mx">http://www.sharp.com.mx</a>	<b>New Zealand</b>	<b>Sharp Corporation of New Zealand</b> (09) 634-2059, (09) 636-6972 <a href="http://www.sharpnz.co.nz">http://www.sharpnz.co.nz</a>
<b>Latin America</b>	<b>Sharp Electronics Corp. Latin American Group</b> (305) 264-2277 <a href="http://www.servicio@sharpsec.com">www.servicio@sharpsec.com</a> <a href="http://www.siemprisharp.com">http://www.siemprisharp.com</a>	<b>Singapore</b>	<b>Sharp-Roxy Sales (S) Pte. Ltd.</b> 65-226-6556 <a href="mailto:ckng@srs.global.sharp.co.jp">ckng@srs.global.sharp.co.jp</a> <a href="http://www.sharp.com.sg">http://www.sharp.com.sg</a>
<b>Germany</b>	<b>Sharp Electronics (Europe) GMBH</b> 01805-234675 <a href="http://www.sharp.de">http://www.sharp.de</a>	<b>Hong Kong</b>	<b>Sharp-Roxy (HK) Ltd.</b> (852) 2410-2623 <a href="mailto:dcmktg@srh.global.sharp.co.jp">dcmktg@srh.global.sharp.co.jp</a> <a href="http://www.sharp.com.hk">http://www.sharp.com.hk</a>
<b>U.K.</b>	<b>Sharp Electronics (U.K.) Ltd.</b> 0161-205-2333 <a href="mailto:custinfo@sharp-uk.co.uk">custinfo@sharp-uk.co.uk</a> <a href="http://www.sharp.co.uk">http://www.sharp.co.uk</a>	<b>Taiwan</b>	<b>Sharp Corporation (Taiwan)</b> 0800-025111 <a href="http://www.sharp-scot.com.tw">http://www.sharp-scot.com.tw</a>
<b>Italy</b>	<b>Sharp Electronics (Italy) S.P.A.</b> (39) 02-89595-1 <a href="http://www.sharp.it">http://www.sharp.it</a>	<b>Malaysia</b>	<b>Sharp-Roxy Sales &amp; Service Co.</b> (60) 3-5125678
<b>France</b>	<b>Sharp Electronics France</b> 01 49 90 35 40 <a href="mailto:hotlinecd@sef.sharp-eu.com">hotlinecd@sef.sharp-eu.com</a> <a href="http://www.sharp.fr">http://www.sharp.fr</a>	<b>U.A.E.</b>	<b>Sharp Middle East Fze</b> 971-4-81-5311 <a href="mailto:helpdesk@smef.global.sharp.co.jp">helpdesk@smef.global.sharp.co.jp</a>
<b>Spain</b>	<b>Sharp Electronica Espana, S.A.</b> 93 5819700 <a href="mailto:sharplcd@sees.sharp-eu.com">sharplcd@sees.sharp-eu.com</a> <a href="http://www.sharp.es">http://www.sharp.es</a>	<b>Thailand</b>	<b>Sharp Thebnakorn Co. Ltd.</b> 02-236-0170 <a href="mailto:svc@stcl.global.sharp.co.jp">svc@stcl.global.sharp.co.jp</a> <a href="http://www.sharp-th.com">http://www.sharp-th.com</a>
<b>Switzerland</b>	<b>Sharp Electronics (Schweiz) AG</b> 0041 1 846 63 11 <a href="mailto:cattaneo@sez.sharp-eu.com">cattaneo@sez.sharp-eu.com</a> <a href="http://www.sharp.ch">http://www.sharp.ch</a>	<b>Korea</b>	<b>Sharp Electronics Incorporated of Korea</b> (82) 2-3660-2002 <a href="mailto:lcd@sharp-korea.co.kr">lcd@sharp-korea.co.kr</a> <a href="http://www.sharpkorea.co.kr">http://www.sharpkorea.co.kr</a>
<b>Sweden</b>	<b>Sharp Electronics (Nordic) AB</b> (46) 8 6343600 <a href="mailto:vision.support@sen.sharp-eu.com">vision.support@sen.sharp-eu.com</a> <a href="http://www.sharp.se">http://www.sharp.se</a>	<b>India</b>	<b>Sharp Business Systems (India) Limited</b> (91) 11- 6431313 <a href="mailto:service@sharp-oa.com">service@sharp-oa.com</a>
<b>Austria</b>	<b>Sharp Electronics Austria (Ges.m.b.H.)</b> 0043 1 727 19 123 <a href="mailto:pogats@sea.sharp-eu.com">pogats@sea.sharp-eu.com</a> <a href="http://www.sharp.at">http://www.sharp.at</a>		

# Specifications

Product type	LCD Projector
Model	PG-B10S
Video system	NTSC3.58/NTSC4.43/PAL/PAL-M/PAL-N/PAL-60/SECAM/ DTV480I/DTV480P/DTV540P/DTV580I/DTV580P/DTV720P/DTV1035I/DTV1080I/ DTV1080I-50
Display method	LCD panel × 3, RGB optical shutter method
LCD panel	Panel size: 0.55" (14.0 mm) (8.5 [H] × 11.2 [W] mm) No. of dots: 480,000 dots (800 [H] × 600 [V])
Lens	1–1.25 × zoom lens, F1.6–1.9, f = 16.8–20.9 mm
Projection lamp	130 W AC lamp
Component input/output signal (INPUT1)	15-pin mini D-sub connector Y: 1.0 Vp-p, sync negative, 75 Ω terminated P <sub>B</sub> : 0.7 Vp-p, 75 Ω terminated P <sub>R</sub> : 0.7 Vp-p, 75 Ω terminated
Horizontal resolution	520 TV lines (DTV720P)
Computer RGB input/output signal (INPUT 1)	15-pin mini D-sub connector RGB separate/sync on green type analog input: 0–0.7 Vp-p, positive, 75 Ω terminated HORIZONTAL SYNC. SIGNAL: TTL level (positive/negative) VERTICAL SYNC. SIGNAL: Same as above
S-video input signal (INPUT 2)	4-pin mini DIN connector Y (luminance signal): 1.0 Vp-p, sync negative, 75 Ω terminated C (chrominance signal): Burst 0.286 Vp-p, 75 Ω terminated
Video input signal (INPUT 3)	RCA connector: VIDEO, composite video, 1.0 Vp-p, sync negative, 75 Ω terminated
Computer control signal (RS-232C)	9-pin mini DIN connector
Pixel clock	12–108 MHz
Vertical frequency	43–85 Hz
Horizontal frequency	15–70 kHz
Audio input signal	ø3.5 mm minijack: AUDIO, 0.5 Vrms, more than 22 kΩ (stereo)
Audio output	1.0 W (monaural)
Speaker system	2.8 cm round × 1
Rated voltage	AC 100–240 V
Input current	1.9 A
Rated frequency	50/60 Hz
Power consumption	185 W (Standard mode)/170 W (Eco mode) with AC 100 V 175 W (Standard mode)/160 W (Eco mode) with AC 240 V
Power consumption (standby)	4 W (AC 100 V) – 6 W (AC 240 V)
Heat dissipation	695 BTU/hour (Standard mode)/640 BTU/hour (Eco mode) with AC 100 V 660 BTU/hour (Standard mode)/600 BTU/hour (Eco mode) with AC 240 V
Operating temperature	41°F to 95°F (+5°C to +35°C)
Storage temperature	–4°F to 140°F (–20°C to +60°C)
Cabinet	Plastic
I/R carrier frequency	38 kHz
Dimensions (approx.)	11 <sup>37</sup> / <sub>64</sub> " × 3 <sup>5</sup> / <sub>8</sub> " × 8 <sup>3</sup> / <sub>4</sub> " (294 (W) × 92 (H) × 222 (D) mm) (main body only) 11 <sup>39</sup> / <sub>64</sub> " × 4 <sup>11</sup> / <sub>64</sub> " × 9 <sup>11</sup> / <sub>32</sub> " (294.5 (W) × 105.8 (H) × 237 (D) mm) (including adjustment foot and projecting parts)
Weight (approx.)	6.0 lbs. (2.7 kg)
Supplied accessories	Remote control, Two R-6 batteries, Power cord for U.S., Canada etc. (6', 1.8 m), Power cord for Europe, except U.K. (6', 1.8 m), Power cord for U.K., Hong Kong and Singapore (6', 1.8 m), Power cord for Australia, New Zealand and Oceania (6', 1.8 m), RGB cable (9'10", 3.0 m), Carrying case, Lens cap (attached), Extra air filter, Lens shipping block (attached), Projector manual and technical reference CD-ROM, "QUICK GUIDE" label, Operation manual
Replacement parts	Lamp unit (Lamp/cage module) (BQC-PGB10S//1), Remote control (RRMCGA187WJSA), Two R-6 batteries ("AA" size, UM/SUM-3, HP-7, or similar), Power cord for U.S., Canada etc. (QACCDAA016WJPZ), Power cord for Europe, except U.K. (QACCVAA006WJPZ), Power cord for U.K., Hong Kong and Singapore (QACCBAA015WJPZ), Power cord for Australia, New Zealand and Oceania (QACCLA005WJPZ), RGB cable (QCNWGA012WJPZ), Carrying case (GCASNA009WJSA), Lens cap (CCAPHA004WJ01), Air filter (PFILDA010WJZZ), Lens shipping block (SPAKXA333WJZZ), Projector manual and technical reference CD-ROM (UDSKAA039WJZZ), "QUICK GUIDE" label (TLABZA439WJZZ), Operation manual (TINS-A917WJZZ)

*As a part of policy of continuous improvement, SHARP reserves the right to make design and specification changes for product improvement without prior notice. The performance specification figures indicated are nominal values of production units. There may be some deviations from these values in individual units.*

# Dimensions

Units: inches (mm)

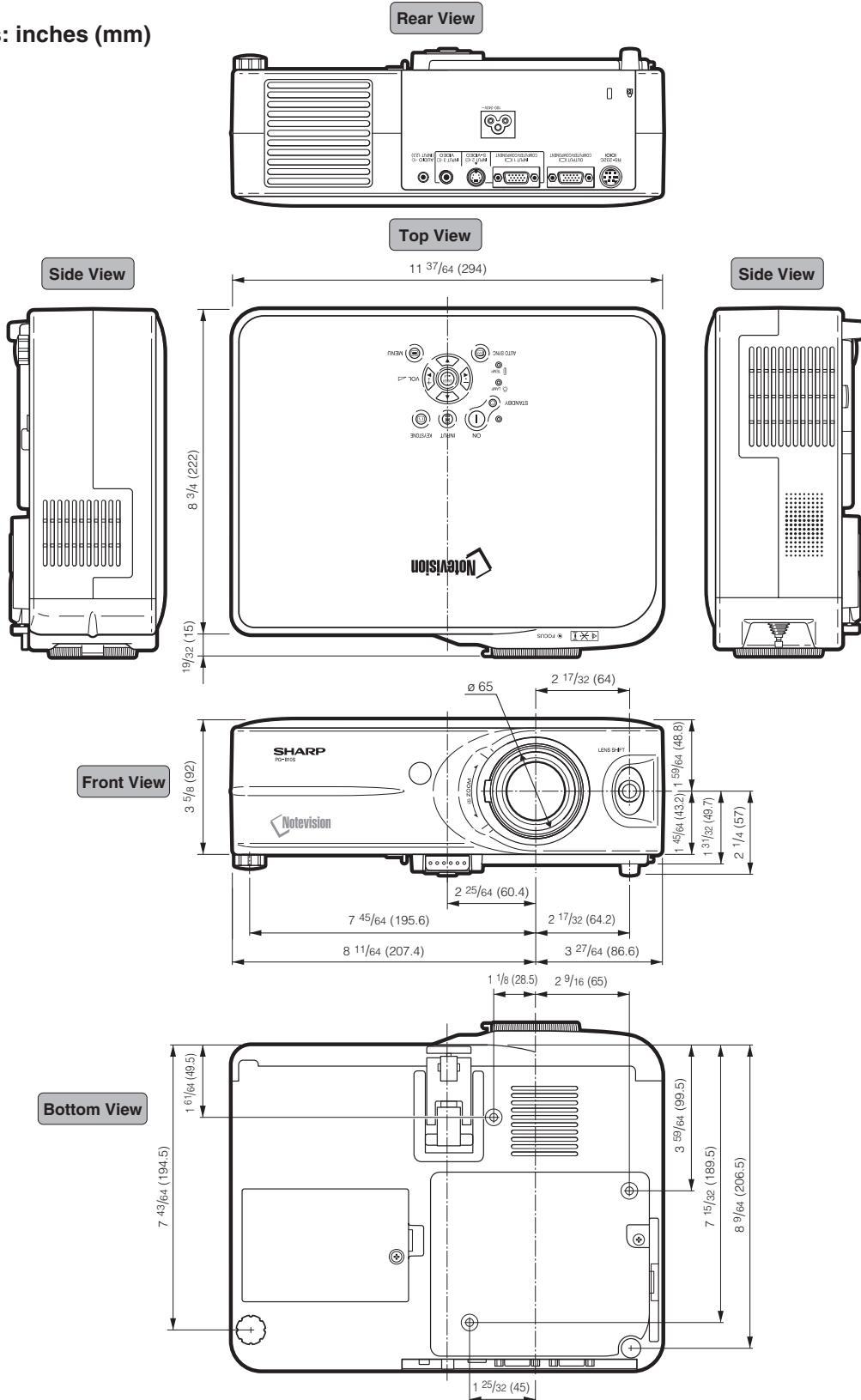

# Glossary

## Anti-Theft

If the "Keycode" set in the projector is not correctly entered, the projector will not operate even if signals are entered.

## Aspect Ratio

Width and height ratio of an image. The normal aspect ratio of a computer and video image is 4:3. There are also wide images with an aspect ratio of 16:9 and 21:9.

## Auto Sync

Optimizes projected computer images by automatically adjusting certain characteristics.

## Background

Initial setting image projected when no signal is being output.

## Border

Projects a 4:3 image fully within a 16:9 screen by keeping the aspect ratio at 4:3.

## Clock

Clock adjustment is used to adjust vertical noise when clock level is incorrect.

## CLR Temp (Color temperature)

Function that can be used to adjust the color temperature to suit the type of image input to the projector. Decrease the color temperature to create warmer, reddish images for natural flesh tones, or increase to create cooler, bluish images for a brighter picture.

## Dot by dot

Mode that projects images in their native resolution.

## Gamma

Image quality enhancement function that offers a richer image by brightening the darker portions of the image without altering the brightness of the brighter portions. You can select four different modes: STANDARD, PRESENTATION, CINEMA and GAME.

## Intelligent compression

High quality resizing of lower and higher resolution images to fit the projector's native resolution.

## Keylock

Mode that can lock the operation of projector buttons to prevent unauthorized adjustment.

## Keystone Correction

Function to digitally correct a distorted image when the projector is set up at an angle, smoothens out jaggies on keystone images and compresses the image not only horizontally but vertically keeping the 4:3 aspect ratio.

## Lens shift

Function to adjust the position of the projection image by using the lens shift lever to move the lens from side to side and up and down (360°).

## Password

A password is set so that changes cannot be made in the "Anti-Theft" setting.

## Phase

Phase shift is a timing shift between isomorphic signals with the same resolution. When phase level is incorrect, the projected image typically displays horizontal flicker.

## Resize

Allows you to modify or customize the picture display mode to enhance the input image. You can select four different modes: NORMAL, DOT BY DOT, BORDER and STRETCH.

## sRGB

An international standard of color reproduction regulated by the IEC (International Electrotechnical Commission). As the fixed color area has been decided by the IEC, the color changes according to LCD features, so that the images are displayed in a natural tint based on an original image, when "sRGB" is set to "ON".

## Stretch

Mode that stretches the 4:3 image horizontally to display it fully on a 16:9 screen.



AC socket .....	55	Lamp Timer (Life) .....	41
Adjustment buttons .....	32	Language (on-screen display language) .....	48
Air filter .....	61	Lens cap .....	10
Anti-Theft .....	46	Lens shift .....	24
Aspect ratio .....	26	Lens shift lever .....	24
AUDIO INPUT terminal .....	51	Lens shipping block .....	11
Auto Power Off .....	43	Memory .....	38
Auto Sync (Auto Sync adjustment) .....	40	MENU button .....	32
AUTO SYNC button .....	40	Menu Color .....	44
AV MUTE button .....	20	Menu Position .....	44
BACK button .....	14	NORMAL .....	26
Background .....	42	ON button .....	18
Batteries .....	15	Optional accessories .....	9
Blue .....	36	Options .....	41
BORDER .....	26	OSD Display .....	41
Bright .....	36	Password .....	45
Carrying case .....	59	PDF .....	8
Clock .....	39	Phase .....	39
CLR Temp (Color Temperature) .....	36	Picture Adjustment .....	36
Color .....	36	Power cord .....	55
Computer Image Adjustment .....	39	Power indicator .....	63
Contrast .....	36	PRJ mode (Reversing Projected Images) .....	49
DIN-D-sub RS-232C adaptor .....	54	Rear adjustment foot .....	23
DOT BY DOT .....	26	Red .....	36
Eco Mode .....	43	Remote control .....	14
ENLARGE buttons .....	28	Remote control sensor .....	15
ENTER button .....	33	Replacing the lamp .....	65
Exhaust vent .....	60	RESIZE button .....	26
Fine Sync .....	39	RGB cable .....	51
Focus ring .....	22	RGB OUTPUT terminal .....	55
FORWARD button .....	14	RS-232C terminal .....	54
FREEZE button .....	28	Sharp .....	36
Front adjustment foot .....	23	Signal Info .....	40
Gamma .....	37	Signal Type .....	38
H-Pos .....	39	Special Modes .....	39
HEIGHT ADJUST button .....	23	sRGB .....	37
INPUT 1 terminal .....	51	STANDBY button .....	21
INPUT 1 – 3 modes .....	19	STRETCH .....	26
INPUT 2 terminal .....	52	Supplied accessories .....	9
INPUT 3 terminal .....	52	Temperature warning indicator .....	63
INPUT button .....	19	Tint .....	36
Intake vent .....	60	UNDO button .....	21
Kensington Security Standard connector .....	12	Video System .....	42
Keycode .....	46	Volume buttons .....	19
Keylock .....	29	V-Pos .....	39
KEYSTONE button .....	20	Zoom knob .....	22
Keystone Correction .....	20		
Lamp .....	65		
Lamp indicator .....	63		

**SHARP®**  
**SHARP CORPORATION**

## Free Manuals Download Website

<http://myh66.com>

<http://usermanuals.us>

<http://www.somanuals.com>

<http://www.4manuals.cc>

<http://www.manual-lib.com>

<http://www.404manual.com>

<http://www.luxmanual.com>

<http://aubethermostatmanual.com>

Golf course search by state

<http://golfingnear.com>

Email search by domain

<http://emailbydomain.com>

Auto manuals search

<http://auto.somanuals.com>

TV manuals search

<http://tv.somanuals.com>