

# SHARP®



## AIR-TO-AIR HEAT PUMP OPERATION MANUAL

**INDOOR UNIT**

**AY-ZP48LZ**

**OUTDOOR UNIT**

**AE-Z48LZ**

*Uses Refrigerant R410A*



\* Plasmacluster is a trademark of SHARP Corporation.



This manual explains the proper use of your new heat pump. Please read this manual carefully before using the product. This manual should be kept in a safe place for handy reference.

## CONTENTS

•IMPORTANT SAFETY INSTRUCTIONS.....	1
•PART NAMES.....	2
•USING THE REMOTE CONTROL.....	4
•SETTING AIR PURIFYING FILTER.....	5
•TIPS ON SAVING ENERGY.....	5
•AUXILIARY MODE.....	5
•BASIC OPERATION.....	6
•ADJUSTING THE AIR FLOW DIRECTION.....	7
•COANDA AIRFLOW.....	8
•SPOT AIR.....	8
•FULL POWER OPERATION.....	9
•ENERGY SAVING OPERATION.....	9
•1.2.3.5h OFF TIMER.....	10
•TIMER OPERATION.....	10
•PLASMACLUSTER OPERATION.....	12
•SELF CLEAN OPERATION.....	12
•VACANCY OPERATION.....	13
•ADDITIONAL NOTES ON OPERATION.....	13
•MAINTENANCE.....	14
•BEFORE CALLING FOR SERVICE.....	15
•SPECIFICATIONS.....	15

## IMPORTANT SAFETY INSTRUCTIONS

### WARNINGS FOR USE

- 1** This model should be installed with a fixed power cord to the meter box.
- 2** Be careful not to expose your body to the outlet air for prolonged periods. It may affect your physical condition.
- 3** When using the unit for infants, children, elderly, bedridden or disabled people make sure the room temperature is suitable for those in the room.
- 4** Never insert objects into the unit. Inserting objects can result in injury due to the high speed rotation of the internal fans.
- 5** If anything abnormal is noticed with the air conditioner (eg burning smell), stop the operation immediately and turn the circuit breaker off.
- 6** This unit should be installed by a licensed heat pump contractor in accordance with AS/NZS 3000 and your electricity suppliers service rules.
- 7** There are local council rules regarding maximum allowable noise levels emitted by heat pump, your licensed heat pump contractor will advise you on the correct location of your outdoor unit.
- 8** If the supply cord is damaged, it must be replaced by the manufacturer or its service agent or a similarly qualified person in order to avoid a hazard. Use only the manufacture-specified power cord for replacement.
- 9** Do not pour water directly on the unit. Water can cause electrical shock or equipment failure.

## IMPORTANT SAFETY INSTRUCTIONS

### WARNINGS FOR INSTALLATION/REMOVAL/REPAIR

For your safety, ensure that your new heat pump is installed by a licensed heat pump contractor in accordance with the AUSTRALIAN/NEW ZEALAND WIRING RULES.

- Do not attempt to install/remove/repair the unit by yourself. Incorrect installation could cause electric shock, water leak, fire etc. Consult a licensed heat pump contractor for the installation/removal/repair of the unit.

### CAUTIONS FOR USE

- 1** If a gas appliance is used in the same room as the heat pump, ventilate the room periodically to prevent oxygen depletion.
- 2** For safety, do not touch the unit with wet hands, it may cause an electric shock.
- 3** For safety, turn the circuit breaker off when not using the unit for an extended period of time.
- 4** For safety, do not place anything on top of the outdoor unit or step on it.
- 5** This unit is designed for residential use. Do not use for other applications such as in a kennel or greenhouse to raise animals or grow plants.
- 6** Do not block the air inlets or outlets of the unit. It may result in degraded performance or unit damage/failure.
- 7** For safety, be sure to turn the unit off at the circuit breaker before performing any maintenance or cleaning.
- 8** This appliance is not intended for use by young children or infirm persons unless they have been adequately supervised by a responsible person to ensure that they can use the appliance safely.  
Young children should be supervised to ensure that they do not play with the appliance.

### CAUTIONS FOR LOCATION/INSTALLATION

To ensure that your warranty is not affected, both the indoor/outdoor units and supply/interconnecting cables must be installed by a licensed heat pump contractor.

- The unit is designed to operate on 220-240 VAC, 50Hz.
- Do not install the unit where flammable gas may leak. It may cause a fire.

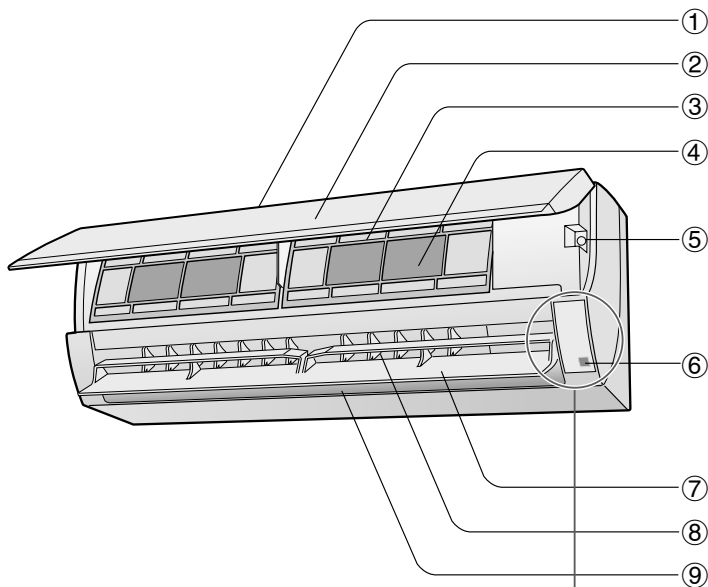

## PART NAMES

### INDOOR UNIT

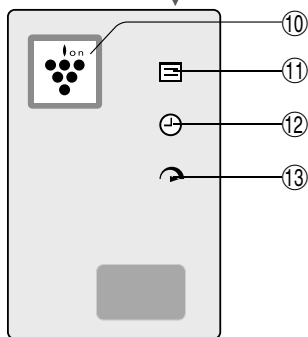

- ① Inlet (Air)
- ② Open Panel
- ③ Air Filter
- ④ Air purifying filter
- ⑤ AUX Button
- ⑥ Receiver Window
- ⑦ Vertical airflow Louvre
- ⑧ Horizontal airflow Louvre
- ⑨ Outlet (Air)



- ⑩ PLASMACLUSTER Lamp (blue)
- ⑪ OPERATION Lamp (red )
- ⑫ TIMER Lamp (orange )
- ⑬ FULL POWER Lamp (green )

### OUTDOOR UNIT

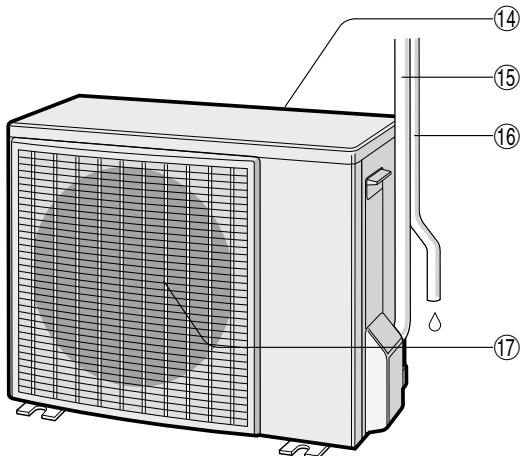

- ⑭ Inlet (Air)
- ⑮ Refrigerant Pipe and Cable
- ⑯ Drainage Hose
- ⑰ Outlet (Air)

#### **NOTE:**

Actual units might vary slightly from those shown above.

## REMOTE CONTROL

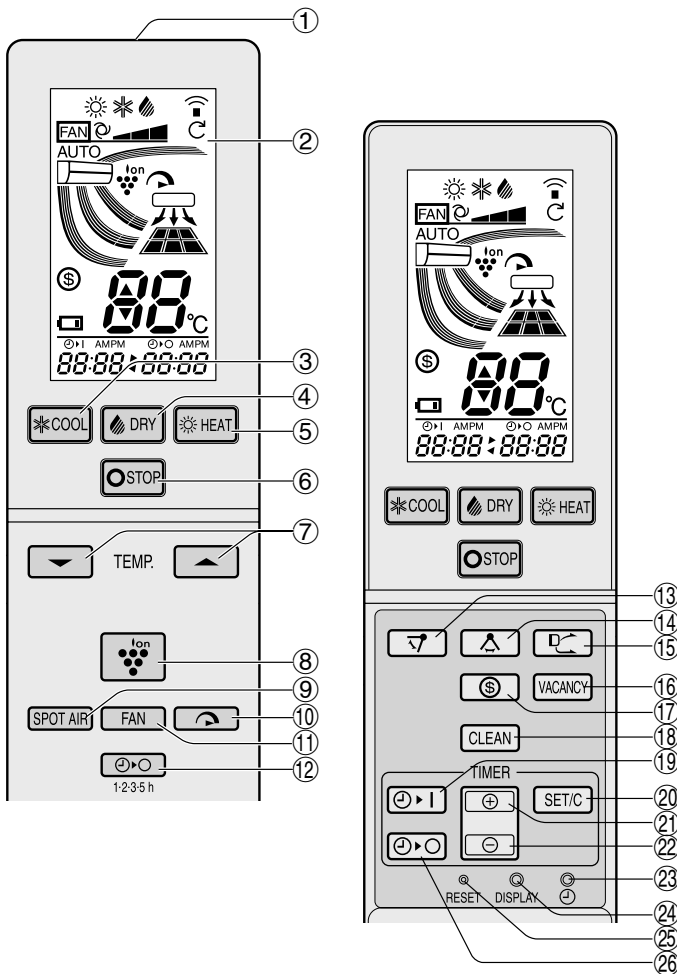

- ① TRANSMITTER
- ② DISPLAY
- ③ COOL Button
- ④ DRY Button
- ⑤ HEAT Button
- ⑥ STOP Button
- ⑦ THERMOSTAT Button
- ⑧ PLASMACLUSTER Button
- ⑨ SPOT AIR Button
- ⑩ FULL POWER Button
- ⑪ FAN Button
- ⑫ 1.2.3.5h OFF TIMER Button
- ⑬ SWING Button ( ▽ : vertical direction)
- ⑭ SWING Button ( △ : horizontal direction)
- ⑮ COANDA AIRFLOW Button
- ⑯ VACANCY Button
- ⑰ ENERGY SAVE Button
- ⑱ SELF CLEAN Button
- ⑲ TIMER ON Button
- ⑳ TIMER SET/CANCEL Button
- ㉑ TIME ADVANCE Button
- ㉒ TIME REVERSE Button
- ㉓ CLOCK Button
- ㉔ DISPLAY Button
- ㉕ RESET Button
- ㉖ TIMER OFF Button

## REMOTE CONTROL DISPLAY

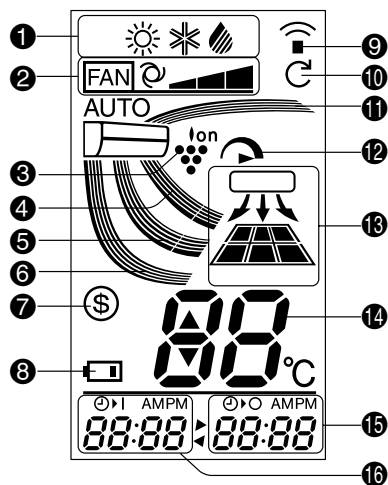

- ① MODE Symbols
- ② FAN SPEED Symbols
- ③ PLASMACLUSTER Symbol
- ④ AIR FLOW Symbol (COOL/DRY)
- ⑤ AIRFLOW Symbol (HEAT)
- ⑥ COANDA AIRFLOW Symbol (HEAT)
- ⑦ ENERGY SAVE Symbol
- ⑧ BATTERY Symbol
- ⑨ TRANSMITTING Symbol
- ⑩ SELF CLEAN Symbol
- ⑪ COANDA AIRFLOW Symbol (COOL/DRY)
- ⑫ FULL POWER Symbol
- ⑬ SPOT AIR Symbol
- ⑭ TEMPERATURE Indicator
- ⑮ TIMER OFF Indicator
- ⑯ TIMER ON Indicator / CLOCK

# USING THE REMOTE CONTROL

## LOADING BATTERIES

Use two size-AAA (R03) batteries.

- 1 Remove the remote control cover.
- 2 Insert batteries, making sure the (+) and (-) polarities are correctly aligned.
- 3 Replace the cover.

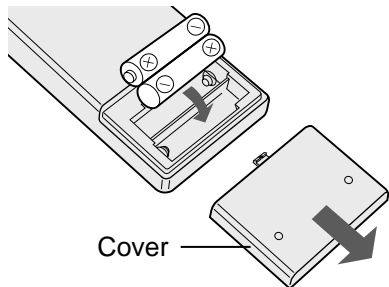

- 4 Press the RESET Button.
  - The display indicates "AM 6:00" when batteries are properly installed.

### NOTE:

- The battery life is approximately one year in normal use.
- Replace the batteries when the remote control displays "  ".
- When you replace the batteries, always change both batteries, and make sure they are the same type.
- If the remote control does not operate properly after replacing the batteries, press the RESET button.
- If you will not be using the unit for a long time, remove the batteries from the remote control.

## HOW TO USE THE REMOTE CONTROL

Point the remote control towards the unit's signal receiver window and press the desired button. The unit generates a beep when it receives the signal.

- Make sure there is no object between the remote control and the unit.
- The signal effective distance is 7m.

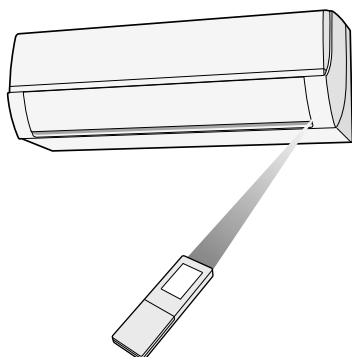

### CAUTION:

- Do not expose the receiver window to direct sunlight. This may adversely affect its operation.
- Use of certain fluorescent lamp in the same room may interfere with transmission of the signal.
- Do not leave the remote control in direct sunlight or near a heater. Protect the unit and remote control from moisture and shock.

## SET CURRENT CLOCK TIME

There are two clock modes: 12-hour mode and 24-hour mode.

Example: 5 o'clock in the afternoon

Clock	Display
12-hour mode	PM 5:00
24-hour mode	17:00

- 1 To set to the 12-hour mode, press the **CLOCK** button once.  
To set to the 24-hour mode, press the **CLOCK** button twice.
- 2 Press the **TIME ADVANCE** or **REVERSE** button to set the current time.
  - Keep the button pressed to advance or reverse the time display quickly.
- 3 Press the **SET/C** button.
  - The colon (:) blinks to indicate that the clock is functioning.

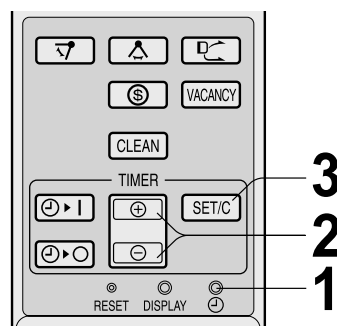

### NOTE:

- The current time cannot be set when the timer is operating.

## SETTING AIR PURIFYING FILTER

The air purifying filters are packed as accessory of this unit. During operation, the filters remove dust and tobacco smoke from the air and discharges clean air.

### 1 Take out the air filters.

- ① Open the open panel.
- ② Push the air filters up slightly to unlock them.
- ③ Pull the air filters down to remove them.

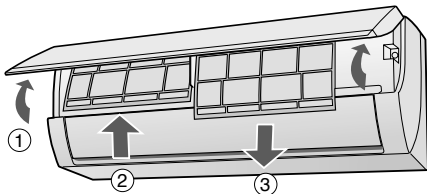

### 2 Set the air purifying filter under the filter stoppers located on the air filter.

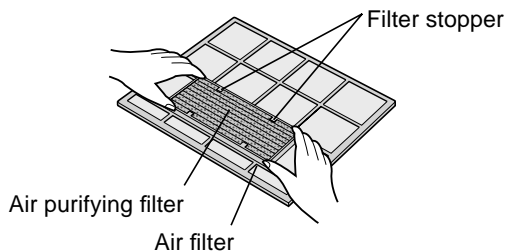

### 3 Reinstall the air filters.

- ① Reinstall the air filters in the original positions.
- ② Close the open panel.

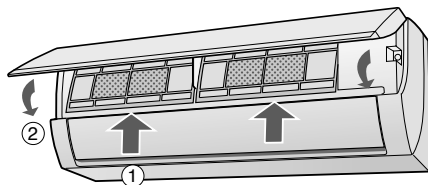

#### Precautions:

- The filters are sealed in a plastic bag to keep their dust collection effect. Do not open the bag until using the filters. (Otherwise the filters life may be reduced.)
- Do not expose the filters to direct sunlight. (Otherwise they may deteriorate.)

## TIPS ON SAVING ENERGY

Below are some simple ways to save energy.

### SET THE PROPER TEMPERATURE

- Setting to higher or lower than necessary temperature point will result in increased power consumption.

### BLOCK DIRECT SUNLIGHT AND PREVENT DRAFTS

- Blocking direct sunlight during cooling operation will reduce power consumption.
- Close the windows and doors during cooling and heating operations.

### SET PROPER AIR FLOW DIRECTION TO OBTAIN THE BEST AIR CIRCULATION

### KEEP THE FILTER CLEAN TO ENSURE THE MOST EFFICIENT OPERATION

### USE THE TIMER OFF FUNCTION WHEN POSSIBLE

### TURN OFF THE CIRCUIT BREAKER WHEN THE UNIT IS NOT USED FOR AN EXTENDED PERIOD OF TIME

- The indoor unit still consumes a small amount of power when it is not operating.

## AUXILIARY MODE

Use this mode when the remote control is not available.

### TO TURN ON

Lift the open panel of the indoor unit and press the AUX button.

- The red OPERATION lamp (  ) on the unit will light and the unit will start operating in the AUTO mode.
- The fan speed and temperature setting are set to AUTO.

### TO TURN OFF

Press the AUX button again.

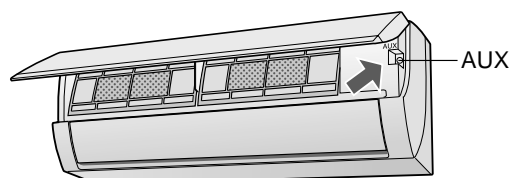

- The red OPERATION lamp (  ) on the unit will turn off.

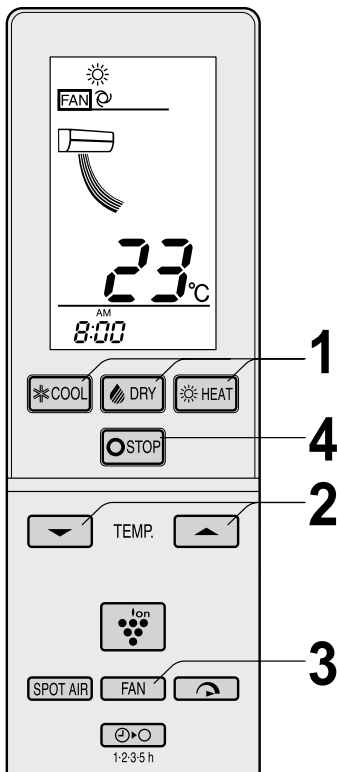

# BASIC OPERATION



## 1 Press the COOL, DRY or HEAT button .

-  : HEAT
-  : COOL
-  : DRY

- The red OPERATION lamp (  ) on the unit will light.

## 2 To change the temperature setting, press the THERMOSTAT button.

### HEAT/COOL MODE

- The temperature can be set within the range of 18°C to 32°C.

### DRY MODE

- The temperature can be changed up to 2°C above or below the temperature automatically determined by the unit.

(Example: 1°C higher)



(Example: 2°C lower)



## 3 To change the fan speed, press the FAN button.

AUTO    SOFT    LOW    HIGH



- In the DRY mode, the fan speed is preset to AUTO and cannot be changed.

## 4 To turn off the unit, press the STOP button.

- The red OPERATION lamp (  ) on the unit will turn off.



# ADJUSTING THE AIR FLOW DIRECTION

## VERTICAL AIR FLOW DIRECTION

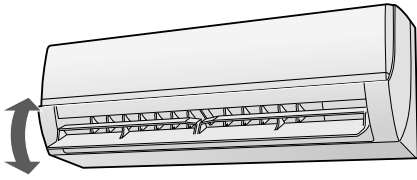

- 1 Press the SWING button( ▾ ).**
  - The vertical airflow louvre will swing.
- 2 Press the SWING button( ▾ ) again when the vertical airflow louvre is at the desired position.**

## HORIZONTAL AIR FLOW DIRECTION

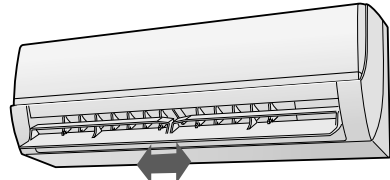

- 1 Press the SWING button( △ ).**
  - The horizontal airflow louvres will swing.
- 2 Press the SWING button( △ ) again when the horizontal airflow louvres are at the desired position.**

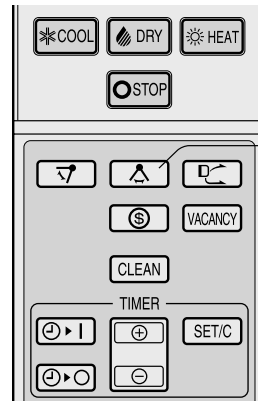
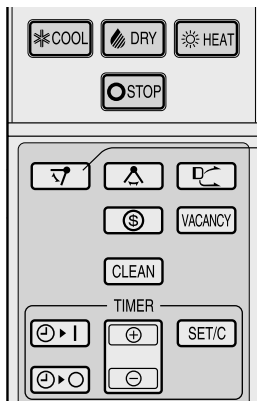

### NOTE:

- The adjusted position will be memorized and will be automatically set to the same position when operated the next time.
- The adjustment range is narrower than the SWING range in order to prevent condensation from dripping.

### CAUTION:

- Never attempt to adjust the louvres manually.
- Manual adjustment of the louvres can cause the unit to malfunction.
- When the vertical airflow louvre is positioned at the lowest position in the COOL or DRY mode for an extended period of time, condensation may result.

## COANDA AIRFLOW

In cool or dry mode, the vertical airflow louvre is set obliquely upward to deliver cool air to the ceiling in order to avoid direct airflow.

In heat mode, the vertical airflow louvre is set downward to deliver warm air down to the floor.

### 1 During operation, press the COANDA AIRFLOW button.

(HEAT mode)

- The remote control will display “”.

(COOL / DRY mode)

- The remote control will display “”.

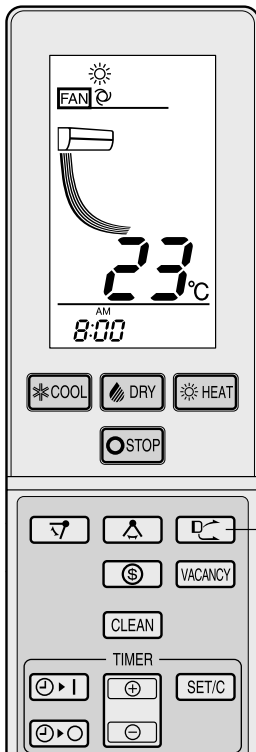

## SPOT AIR

The louvres are adjusted so that air flow is delivered to the desired area.

### 1 Press the SPOT AIR button to select the desired air flow direction.

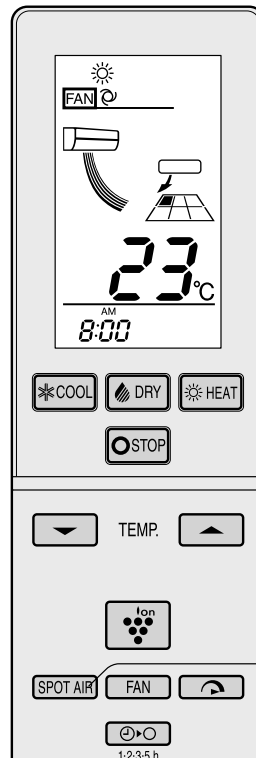
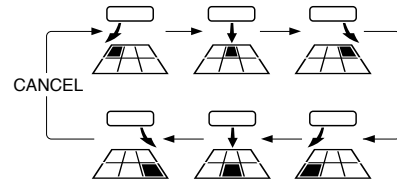

## TO CANCEL

Press the COANDA AIRFLOW button again.

### NOTE:

- If you want the COANDA AIRFLOW setting in the FULL POWER mode, press the COANDA AIRFLOW button during the FULL POWER operation.
- The COANDA AIRFLOW setting and the SPOT AIR setting can not be used together.



### NOTE:

- If you want the SPOT AIR setting in the FULL POWER mode, press the SPOT AIR button during the FULL POWER operation.
- The COANDA AIRFLOW setting and the SPOT AIR setting can not be used together.

## FULL POWER OPERATION

The unit works at the maximum power and optimum louvre direction to quickly cool or warm the room.

### 1 During operation, press the FULL POWER button.

- The remote control will display “” and AIR FLOW symbol will get longer.
- The temperature display will go off.
- The green FULL POWER lamp (  ) on the unit will light up.
- The vertical airflow louvre will be set obliquely downward.

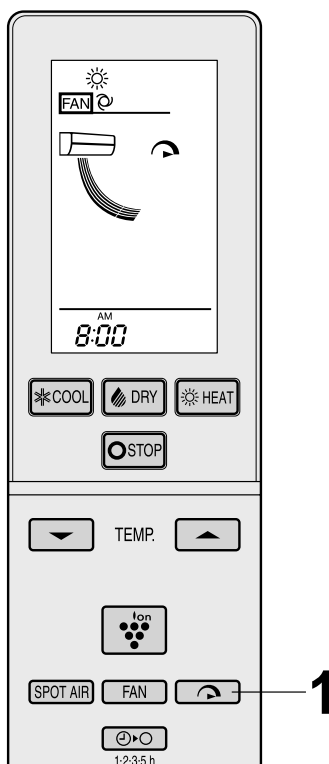

### TO CANCEL

Press the FULL POWER button again.

- The green FULL POWER lamp (  ) on the unit will turn off.
- The vertical airflow louvre will return to the original direction.

### NOTE:

- The unit will operate at “Extra HIGH” fan speed for 5 minutes, and then shift to “HIGH” fan speed.
- You can not set the temperature or fan speed during the FULL POWER operation.
- To turn off the FULL POWER lamp, press the DISPLAY button.
- The ENERGY SAVING operation and the FULL POWER operation can not be used together.

## ENERGY SAVING OPERATION

The temperature set point is automatically controlled to save energy.

### 1 During operation, press the ENERGY SAVE button.

- The remote control will display “”.
- The fan speed will be set to AUTO.

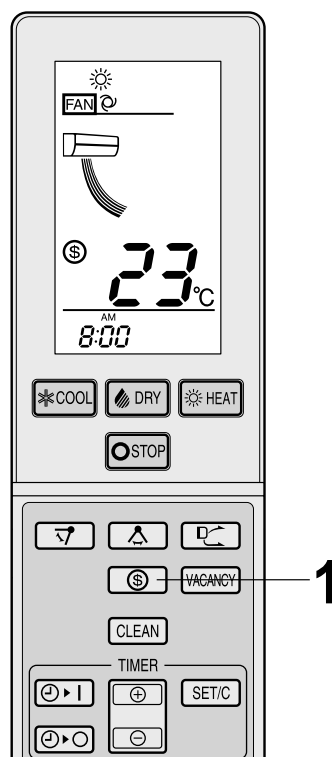

### TO CANCEL

Press the ENERGY SAVE button again.

### NOTE:

- In HEAT mode, the temperature set point will be automatically fluctuated between 0 - 2 °C lower than the original temperature setting.  
In COOL or DRY mode, the temperature set point will be automatically fluctuated between 0 - 1 °C higher than the original temperature setting.
- The ENERGY SAVING operation and the FULL POWER operation can not be used together.

## 1·2·3·5h OFF TIMER

When the 1·2·3·5h OFF TIMER is set, the unit will automatically turn off after the set time (hours).

### 1 Press the 1·2·3·5h OFF TIMER button to set the desired time.

- The time setting will change as you press the button as follows.

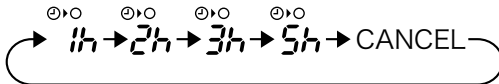

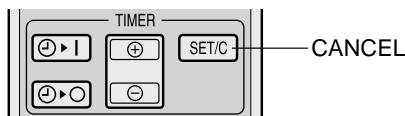
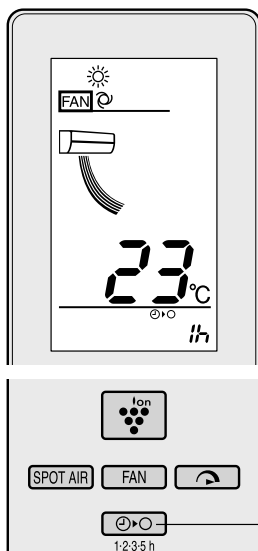

- The orange TIMER lamp (  ) on the unit will light up.
- The remaining operation time will be indicated on the remote control in 1-hour increments.



## TIMER OPERATION

### TIMER OFF

- Press the TIMER OFF (  ) button.
- The TIMER OFF indicator will blink; press the TIME ADVANCE or REVERSE button to set the desired time.  
(The time can be set in 10-minute increments.)
- Press the TIMER SET (SET/C) button.
  - The orange TIMER lamp (  ) on the unit will light.

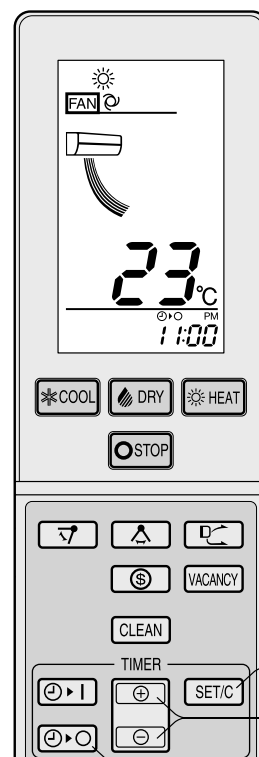

### TO CANCEL

Press the TIMER CANCEL (SET/C) button.  
Alternatively, press the 1·2·3·5h OFF TIMER button.

- The orange TIMER lamp (  ) on the unit will turn off.

### NOTE:

- The 1·2·3·5h OFF TIMER operation has priority over TIMER ON and TIMER OFF operations.
- If the 1·2·3·5h OFF TIMER is set while the unit is not operating, the unit will operate at the formerly set condition.
- If TIMER ON and/or TIMER OFF are set, TIMER CANCEL button cancels every setting.

### TIPS ABOUT TIMER OFF OPERATION

When the TIMER OFF mode is set, the temperature setting is automatically adjusted to prevent the room from becoming excessively warm or cool, for example while you sleep. (Auto Sleep function)

#### HEAT mode



- One hour after the timer operation begins, the temperature setting drops 3°C lower than the original temperature setting.

#### COOL/DRY mode

- One hour after the timer operation begins, the temperature setting rises 1°C higher than the original temperature setting.

Before setting the timer, make sure the clock is properly set with the current time.

## TIMER ON

- 1 Press the **TIMER ON** (  ) button.
- 2 The **TIMER ON** indicator will blink; press the **TIME ADVANCE** or **REVERSE** button to set the desired time.  
(The time can be set in 10-minute increments.)
- 3 Press the **TIMER SET (SET/C)** button.
  - The orange **TIMER** lamp (  ) on the unit will light.
- 4 Select the operation condition.

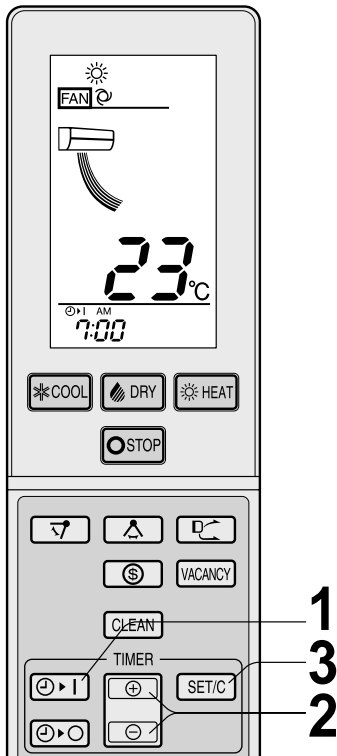

### **NOTE:**

- The unit will turn on prior to the set time to allow the room to reach the desired temperature by the programmed time. (Awaking function)

## TO CANCEL TIMER MODE

Press the **TIMER CANCEL (SET/C)** button.

- The orange **TIMER** lamp (  ) on the unit will turn off.
- The current clock time will be displayed on the remote control.

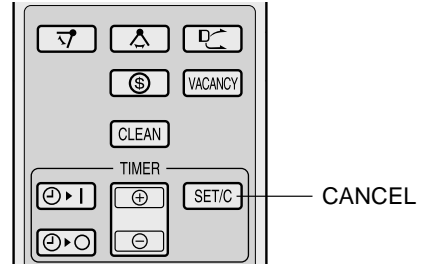

### **NOTE:**

- If any **TIMER ON**, **TIMER OFF** and **ONE-HOUR OFF TIMER** are set, the **TIMER CANCEL** button cancels all settings.

## TO CHANGE TIME SETTING



Cancel the **TIMER** setting first, then set it again

## COMBINED USE OF ON AND OFF TIMERS

You can use the **ON** and **OFF** timers in combination.

### **Example:**

To stop operation at 11:00 p.m. and resume operation to bring the room temperature to the desired level by 7:00 a.m.

- 1 Set the **TIMER OFF** to 11:00 p.m. during operation.
- 2 Set the **TIMER ON** to 7:00 a.m.  
The arrow (  or  ) between the **TIMER ON** indicator and the **TIMER OFF** indicator shows which timer will activate first.



### **NOTE:**

- You cannot programme the **ON-TIMER** and **OFF-TIMER** to operate the unit at different temperatures or other settings.
- Either timer can be programmed to activate prior to the other.

## PLASMACLUSTER OPERATION

Plasmacluster ions released into the room will reduce some airborne mold and viruses.

### 1 During operation, press the PLASMACLUSTER button.

- The remote control will display “”.
- The blue PLASMACLUSTER lamp on the unit will light up.

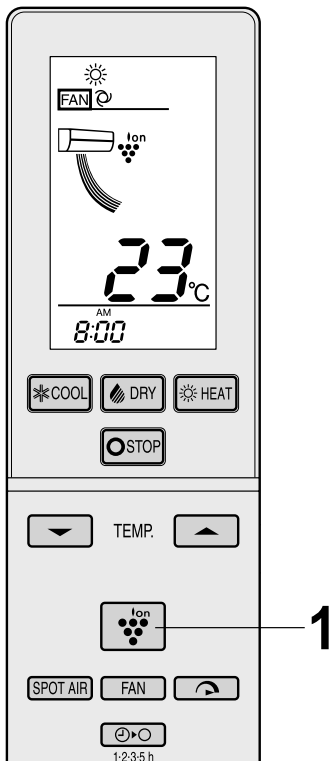

## SELF CLEAN OPERATION

SELF CLEAN operation using Plasmacluster ions helps to reduce the growth mold fungus and dry inside of the unit. It is recommended to utilize the operation at seasonal change over.

### 1 Press the SELF CLEAN button when the unit is not operating.

- The remote control displays “”.
- The blue PLASMACLUSTER lamp on the unit will light up.
- The unit will stop operation after 40 minutes.

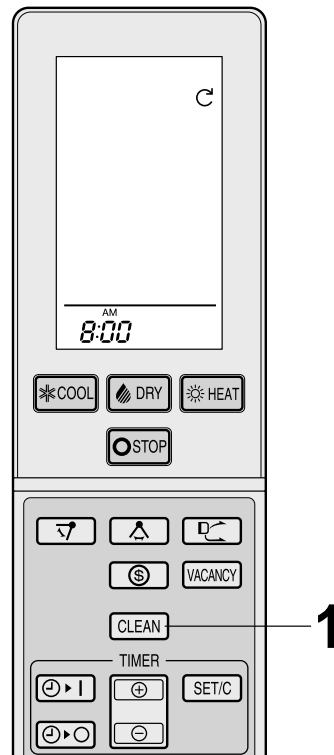

### TO CANCEL

Press the PLASMACLUSTER button again.

- The PLASMACLUSTER lamp on the unit will turn off.

### NOTE:

- Use of the PLASMACLUSTER operation will be memorized, and it will be activated the next time you turn on the unit.
- To turn off the PLASMACLUSTER lamp, press the DISPLAY button.
- To perform Plasmacluster operation in FAN only mode, press the PLASMACLUSTER button when the unit is not operating. The mode symbol of the remote control will go off and the fan speed cannot be set to AUTO.

### TO CANCEL

Press the SELF CLEAN button.

- The blue PLASMACLUSTER lamp on the unit will turn off.

### NOTE:

- You cannot set the temperature, fan speed, air flow direction or timer setting during the SELF CLEAN operation.
- Mold fungus already in existence can not be eliminated by this operation.

## VACANCY OPERATION

Heating operation with 10°C set temperature will be performed to protect your home and furniture from frost damage, even when you are out.

**1** Press the HEAT button.

**2** Press the VACANCY button.  
• The remote control will display “10°C”.

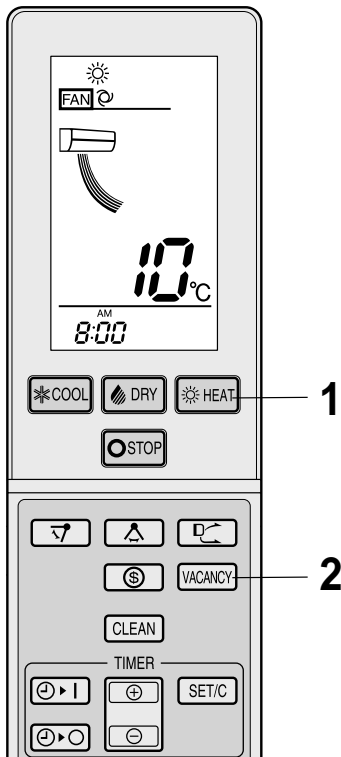

### TO CANCEL

Press the VACANCY button again.

## ADDITIONAL NOTES ON OPERATION

### OPERATING TEMPERATURE RANGE

		INDOOR TEMP.	OUTDOOR TEMP.
HEATING	upper limit	27°C	24°C
	lower limit	–	-20°C
COOLING	upper limit	32°C	43°C
	lower limit	21°C	-10°C

- The built-in protective device may prevent the unit from operating when used out of this range.
- Condensation may form on the air outlet if the unit operates continuously in the COOL or DRY mode when humidity is over 80 percent.

### WHEN POWER FAILURE OCCURS

This unit has a memory function to store settings when a power failure occurs.

After power recovery, the unit will automatically restart in the same settings which were active before the power failure, except for timer settings.

If the timers were set before a power failure, they will need to be re-set after power recovery.

### PREHEATING FUNCTION

In the HEAT operation, the indoor fan may not start for two to five minutes after the unit is turned on to prevent cold air from blowing out of the unit.

### DE-ICING FUNCTION

- When ice forms on the heat exchanger in the outdoor unit during the HEAT operation, an automatic de-icer provides heat for about 5 to 10 minutes to remove the ice. During de-icing, the inside and outside fans stop operating.
- After de-icing is completed, the unit automatically resumes operation in the HEAT mode.

### HEATING EFFICIENCY

- The unit employs a heat pump that draws heat from the outside air and releases it into the room. The outside air temperature therefore greatly affects the heating efficiency.
- If the heating efficiency is reduced due to low outside temperatures, use an additional heater.
- It takes time to warm up and heat the entire room because of the forced air circulation system.

## MAINTENANCE

Be sure to stop the operation and turn off the circuit breaker before performing any maintenance.

### CLEANING THE FILTERS

The air filters should be cleaned every two weeks.

- 1 Turn off the unit.
- 2 Remove the filters.
  - ① Lift the open panel.
  - ② Push the air filters up slightly to unlock them.
  - ③ Pull the air filters down to remove them.

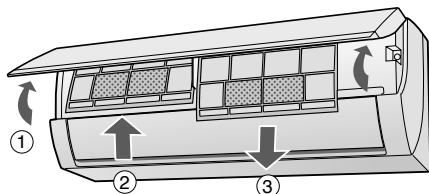

- 3 Take off the air purifying filters from the air filters.

- 4 Clean the filters.

Use a vacuum cleaner to remove dust. If the filters are dirty, wash them with warm water and a mild detergent. Dry filters in the shade before reinstalling.

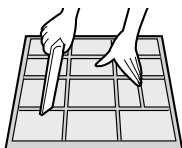

- 5 Reinstall the air purifying filters.

- 6 Reinstall the filters.

- ① Reinstall the filters in the original positions.
- ② Close the open panel.

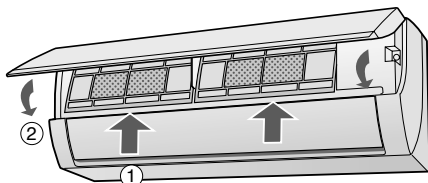

### CLEANING THE UNIT AND THE REMOTE CONTROL

- Wipe them with a soft cloth.
- Do not directly splash or pour water on them. It can cause electrical shock or equipment damage.
- Do not use hot water, thinner, abrasive powders or strong solvents.

### MAINTENANCE AFTER HEAT PUMP SEASON

- 1 Operate the unit in the SELF CLEAN operation to allow the mechanism to thoroughly dry.
- 2 Stop the operation and turn off the circuit breaker.
- 3 Clean the filters, then reinstall them.

### MAINTENANCE BEFORE HEAT PUMP SEASON

- 1 Make sure that the air filters are not dirty.
- 2 Make sure that nothing obstructs the air inlet or outlet.

### CHANGING THE AIR PURIFYING FILTER

The air purifying filters should be changed every 3 ~ 6 months

- 1 Remove the air filters.
- 2 Change the air purifying filters.
  - ① Take off the old air purifying filters from the air filters.
  - ② Set the new air purifying filters, under the filter stoppers located on the air filters.

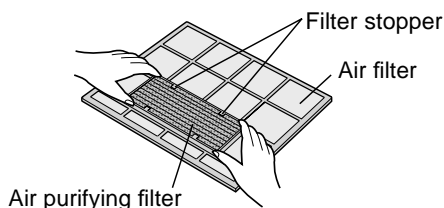

- 3 Reinstall the air filters.

#### NOTE:

- The dirty air purifying filters are not washable for reuse. The new filters are available at your nearest dealer.

#### Disposal of Filters

Please dispose of replaced filters according to the local disposal laws and regulations.

AIR PURIFYING filter materials  
Filter: Polypropylene  
Frame: Polyester



## BEFORE CALLING FOR SERVICE

The following conditions do not denote equipment malfunctions

### UNIT DOES NOT OPERATE

The unit will not operate if it is turned on immediately after it is turned off. The unit will not operate immediately after the mode is changed. This is to protect the unit. Wait 3 minutes before operating the unit.

### UNIT DOES NOT SEND OUT WARM AIR

The unit is preheating or de-icing.

### ODORS

Carpet and furniture odors that entered into the unit may be recirculated by the unit.

### CRACKING NOISE

This sound is generated by the friction of the unit expanding or connecting due to a temperature change.

### A LOW BUZZING NOISE

This is a sound of the unit generating Plasmacluster ions.

### SWISHING NOISE

The soft, swishing noise is the sound of the refrigerant flowing inside the unit.

### MIST SEEN AT INDOOR AIR OUTLET

In cooling operation, this is caused by the difference between the room air temperature and the air discharged.

### WATER VAPOUR

In heating operation, water vapour may flow out of the outdoor unit during de-icing.

### THE OUTDOOR UNIT DOES NOT STOP

After stopping the operation, the outdoor unit will rotate its fan for about a minute to cool down the unit.

### ODOR EMITTED FROM THE PLASMACLUSTER AIR OUTLET

This is the smell of ozone generated from the Plasmacluster Ion generator. The ozone concentration is very small, posing no adverse effect on your health. The ozone discharged into the air rapidly decomposes, and its density in the room will not increase.

Check the following points before calling for service.

### IF THE UNIT FAILS TO OPERATE

Check if the circuit breaker has tripped or the fuse has blown.

### IF THE UNIT FAILS TO HEAT (OR COOL) THE ROOM EFFECTIVELY

- Check the filters. If dirty, clean them.
- Check the outdoor unit to make sure nothing is blocking the air inlet or outlet.
- Check the thermostat is properly set.
- Make sure windows and doors are closed tightly.

### IF THE UNIT FAILS TO RECEIVE THE REMOTE CONTROL SIGNAL

- Check whether the remote control batteries have become old and weak.
- Try to send the signal again with the remote control pointed properly towards the unit's signal receiver window.
- Check whether the remote control batteries are installed properly.

Please call for service when OPERATION lamp, TIMER lamp and/or PLASMACLUSTER lamp on the unit blink.

## SPECIFICATIONS

Indoor unit	AY-ZP48LZ	
Outdoor unit	AE-Z48LZ	
Rated A.C. voltage (V)	220-240	
Rated frequency (Hz)	50	
Capacity (kW)	Cooling	3.6
	Heating	4.8
Rated input (W)	Cooling	990
	Heating	1260

When tested in accordance with AS/NZS3823.1.1





**SHARP**<sup>®</sup>

SHARP CORPORATION

Printed in Thailand

TINSEA629JBRZ 09K- (TH) ①

## Free Manuals Download Website

<http://myh66.com>

<http://usermanuals.us>

<http://www.somanuals.com>

<http://www.4manuals.cc>

<http://www.manual-lib.com>

<http://www.404manual.com>

<http://www.luxmanual.com>

<http://aubethermostatmanual.com>

Golf course search by state

<http://golfingnear.com>

Email search by domain

<http://emailbydomain.com>

Auto manuals search

<http://auto.somanuals.com>

TV manuals search

<http://tv.somanuals.com>