

SHARP®

ENGLISH

FRANÇAIS

PN-525U

**LCD MONITOR
MONITEUR LCD**

**OPERATION MANUAL
MODE D'EMPLOI**

ENGLISH E1
FRANÇAIS F1

PN-525U

LCD MONITOR

ENGLISH

IMPORTANT:

To aid reporting in case of loss or theft, please record the product's model and serial numbers in the space provided. The numbers are located in the rear of the product.





Model No.:

Serial No.:

U.S.A. ONLY

IMPORTANT INFORMATION

WARNING: TO REDUCE THE RISK OF FIRE OR ELECTRIC SHOCK, DO NOT EXPOSE THIS PRODUCT TO RAIN OR MOISTURE.

 <div style="text-align: center;"> <p>CAUTION</p> <p>RISK OF ELECTRIC SHOCK DO NOT OPEN</p> </div> 	 <p>The lightning flash with arrowhead symbol, within an equilateral triangle, is intended to alert the user to the presence of uninsulated "dangerous voltage" within the product's enclosure that may be of sufficient magnitude to constitute a risk of electric shock to persons.</p>
<p>CAUTION: TO REDUCE THE RISK OF ELECTRIC SHOCK, DO NOT REMOVE COVER. NO USER-SERVICEABLE PARTS INSIDE. REFER SERVICING TO QUALIFIED SERVICE PERSONNEL.</p>	 <p>The exclamation point within a triangle is intended to alert the user to the presence of important operating and maintenance (servicing) instructions in the literature accompanying the product.</p>

CAUTION: The AC outlet shall be installed near the equipment and shall be easily accessible.

IMPORTANT INFORMATION (Continued)

WARNING: FCC Regulations state that any unauthorized changes or modifications to this equipment not expressly approved by the manufacturer could void the user's authority to operate this equipment.

U.S.A. ONLY

CAUTION: Use the supplied power cord as it is.

NOTE:

This equipment has been tested and found to comply with the limits for Class A digital device, pursuant to Part 15 of the FCC Rules. These limits are designed to provide reasonable protection against harmful interference when the equipment is operated in a commercial environment. This equipment generates, uses, and can radiate radio frequency energy and, if not installed and used in accordance with the instruction manual, may cause harmful interference to radio communications. Operation of this equipment in a residential area is likely to cause harmful interference in which case the user will be required to correct the interference at his own expense.

U.S.A. ONLY

This product utilizes fluorescent tubes containing a small amount of mercury. Disposal of these materials may be regulated due to environmental considerations. For disposal or recycling information, please contact your local authorities or the Electronic Industries Alliance: www.eia.org

DEAR SHARP CUSTOMER

Thank you for your purchase of a SHARP LCD product. To ensure safety and many years of trouble-free operation of your product, please read the Safety Precautions carefully before using this product.

SAFETY PRECAUTIONS

Electricity is used to perform many useful functions, but it can also cause personal injuries and property damage if improperly handled. This product has been engineered and manufactured with the highest priority on safety. However, improper use can result in electric shock and/or fire. In order to prevent potential danger, please observe the following instructions when installing, operating and cleaning the product. To ensure your safety and prolong the service life of your LCD product, please read the following precautions carefully before using the product.

1. Read instructions — All operating instructions must be read and understood before the product is operated.
2. Keep this manual in a safe place — These safety and operating instructions must be kept in a safe place for future reference.
3. Observe warnings — All warnings on the product and in the instructions must be observed closely.
4. Follow instructions — All operating instructions must be followed.
5. Cleaning — Unplug the power cord from the AC outlet before cleaning the product. Use a dry cloth to clean the product. Do not use liquid cleaners or aerosol cleaners.
6. Attachments — Do not use attachments not recommended by the manufacturer. Use of inadequate attachments can result in accidents.
7. Water and moisture — Do not use the product near water.
8. Ventilation — The vents and other openings in the cabinet are designed for ventilation. Do not cover or block these vents and openings since insufficient ventilation can cause overheating and/or shorten the life of the product. Do not place the product on a sofa, rug or other similar surface, since they can block ventilation openings. Do not place the product in an enclosed place such as a bookcase or rack, unless proper ventilation is provided or the manufacturer's instructions are followed.
9. Power cord protection — The power cords must be routed properly to prevent people from stepping on them or objects from resting on them.
10. The LCD panel used in this product is made of glass. Therefore, it can break when the product is dropped or applied with impact. Be careful not to be injured by broken glass pieces in case the LCD panel breaks.
11. Overloading — Do not overload AC outlets or extension cords. Overloading can cause fire or electric shock.
12. Entering of objects and liquids — Never insert an object into the product through vents or openings. High voltage flows in the product, and inserting an object can cause electric shock and/or short internal parts. For the same reason, do not spill water or liquid on the product.
13. Servicing — Do not attempt to service the product yourself. Removing covers can expose you to high voltage and other dangerous conditions. Request a qualified service person to perform servicing.
14. Repair — If any of the following conditions occurs, unplug the power cord from the AC outlet, and request a qualified service person to perform repairs.
 - a. When the power cord or plug is damaged.
 - b. When a liquid was spilled on the product or when objects have fallen into the product.
 - c. When the product has been exposed to rain or water.
 - d. When the product does not operate properly as described in the operating instructions. Do not touch the controls other than those described in the operating instructions. Improper adjustment of controls not described in the instructions can cause damage, which often requires extensive adjustment work by a qualified technician.
 - e. When the product has been dropped or damaged.
 - f. When the product displays an abnormal condition. Any noticeable abnormality in the product indicates that the product needs servicing.

SAFETY PRECAUTIONS (Continued)

15. Replacement parts — In case the product needs replacement parts, make sure that the service person uses replacement parts specified by the manufacturer, or those with the same characteristics and performance as the original parts. Use of unauthorized parts can result in fire, electric shock and/or other danger.
16. Safety checks — Upon completion of service or repair work, request the service technician to perform safety checks to ensure that the product is in proper operating condition.
17. Wall mounting — When mounting the product on a wall, be sure to install the product according to the method recommended by the manufacturer.
18. Heat sources — Keep the product away from heat sources such as radiators, heaters, stoves and other heat-generating products (including amplifiers).
19. Usage of the monitor must not be accompanied by fatal risks or dangers that, could lead directly to death, personal injury, severe physical damage or other loss, including nuclear reaction control in nuclear facility, medical life support system, and missile launch control in a weapon system.

WARNING:

This is a class A product. In a domestic environment this product may cause radio interference in which case the user may be required to take adequate counter measures.

TIPS AND SAFETY INSTRUCTIONS

- The TFT color LCD panel used in this monitor is made with the application of high precision technology. However, there may be minute points on the screen where pixels never light or are permanently lit. Also, if the screen is viewed from an acute angle there may be uneven colors or brightness. Please note that these are not malfunctions but common phenomena of LCDs and will not affect the performance of the monitor.
- Do not display a still picture for a long period, as this could cause a residual image.
- Never rub or tap the monitor with hard objects.
- Please understand that Sharp Corporation bears no responsibility for errors made during use by the customer or a third party, nor for any other malfunctions or damage to this product arising during use, except where indemnity liability is recognized under law.
- This monitor and its accessories may be upgraded without advance notice.
- Do not use the monitor where there is a lot of dust, where humidity is high, or where the monitor may come into contact with oil or steam, as this could lead to fire.
- Ensure that the monitor does not come into contact with water or other fluids. Ensure that no objects such as paper clips or pins enter the monitor as this could lead to fire or electric shock.
- Do not place the monitor on top of unstable objects or in unsafe places. Do not allow the monitor to receive strong shocks or to strongly vibrate. Causing the monitor to fall or topple over may damage it.
- Do not use the monitor near heating equipment or in places where there is likelihood of high temperature, as this may lead to generation of excessive heat and outbreak of fire.

The Power Cord

- Do not damage the power cord nor place heavy objects on it, stretch it or over bend it. Also, do not add extension cords. Damage to the cord may result in fire or electric shock.
- Use only the power cord supplied with the monitor.
- Insert the power plug directly into the AC outlet. Adding an extension cord may lead to fire as a result of overheating.
- Do not remove or insert the power plug with wet hands. Doing so could result in electric shock.
- Unplug the power cord if it is not used for a long time.
- Do not attempt to repair the power cord if it is broken or malfunctioning. Refer the servicing to the service representative.

Manual Scope

- Microsoft and Windows are registered trademarks of Microsoft Corporation.
- This product comes with RICOH Bitmap Fonts produced and sold by RICOH COMPANY, LTD.
- All other brand and product names are trademarks or registered trademarks of their respective holders.
- Language of OSD menu used in this manual is English by way of example.
- Illustrations in this manual may not exactly represent the actual product or display.
- This manual assumes use in horizontal orientation, except where specifically noted.

Fluorescent Tubes

- The fluorescent tubes in this product have a limited lifetime.
 - * If the screen gets dark, flashes, or does not turn on, change the fluorescent tubes with new exclusive ones.
 - * For more information, please contact your product dealer.
- Because of the property of fluorescent tubes, the screen may flash during the initial period of use. If this happens, please turn off the main power switch of the monitor and turn on again to confirm operation.

Contents

Introduction

IMPORTANT INFORMATION	1
DEAR SHARP CUSTOMER	3
SAFETY PRECAUTIONS	3
TIPS AND SAFETY INSTRUCTIONS	5
Supplied Accessories	7
Part Names	7
Front view.....	7
Rear view	8
Remote control unit.....	8

Connection and Installation

How to Install the Monitor	9
Mounting precautions.....	9
Connecting Peripheral Equipment	10
Connection with a PC.....	10
Connection with AV equipment	10
Other terminals.....	11
Connecting external speakers.....	11
Connecting multiple monitors.....	11
Connecting the Power Cord	12
Mounting the Temporary Stands	12
Binding Cables	13
Preparing the Remote Control Unit	13
Installing the batteries	13
Remote control operation range.....	13

Basic Operation

Turning Power On/Off	14
Turning on the main power	14
Turning power on/off	14
Disabling power on/off operations.....	14
Basic Operation	15
Menu Items	17
Displaying the menu screen.....	17
Menu item details	18
Adjustments for PC screen display	22
Initialization (Reset)/ Functional Restriction Setting	23

PC Operation

Controlling the Monitor with a PC	24
PC connection	24
Communication conditions	24
Communication procedure	24
RS-232C command table.....	28

Troubleshooting and Specifications

Troubleshooting	32
Specifications	33

Supplied Accessories

If any component should be missing, please contact your dealer.

Liquid Crystal Display: 1

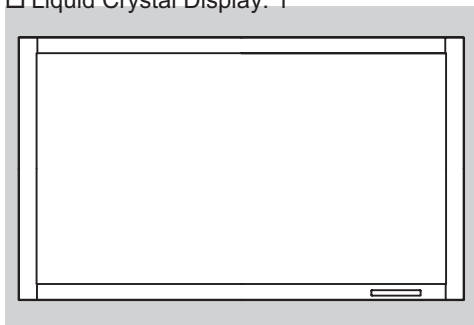

- Power cord (Approx. 13.1 feet [4 m]): 1
- "AA" size battery: 2
- CD-ROM (Utility Disk for Windows): 1
- Operation manual: 1
- Blank sticker: 1
Place a blank sticker onto the SHARP logo to cover the logo.

Remote control unit: 1



Vertical logo sticker: 2

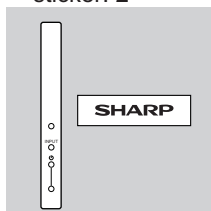

Temporary stand: 2

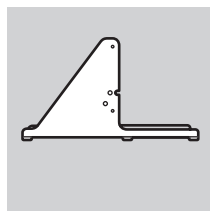

Cable clamp: 2

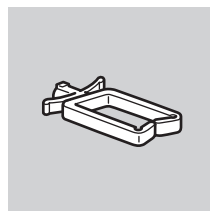

Power cord clamp: 1

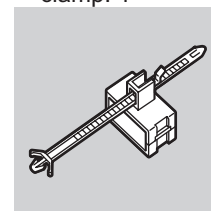

- * Sharp Corporation holds authorship rights to the Utility Disk program. Do not reproduce it without permission.
- * For environmental protection!
Do not dispose of batteries in household waste. Follow the disposal instructions for your area.

Part Names

■ Front view

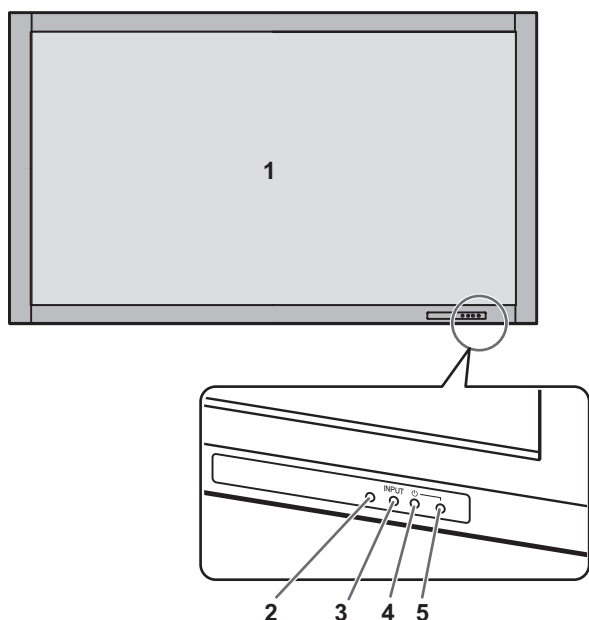

1. LCD panel
2. Remote control sensor (See page 13.)
3. Input switch (See page 15.)
4. Power switch (See page 14.)
5. Power LED (See page 14.)

TIPS

- Use a pointed object such as a pen tip to press the switches at the front of the monitor.

Part Names

■Rear view

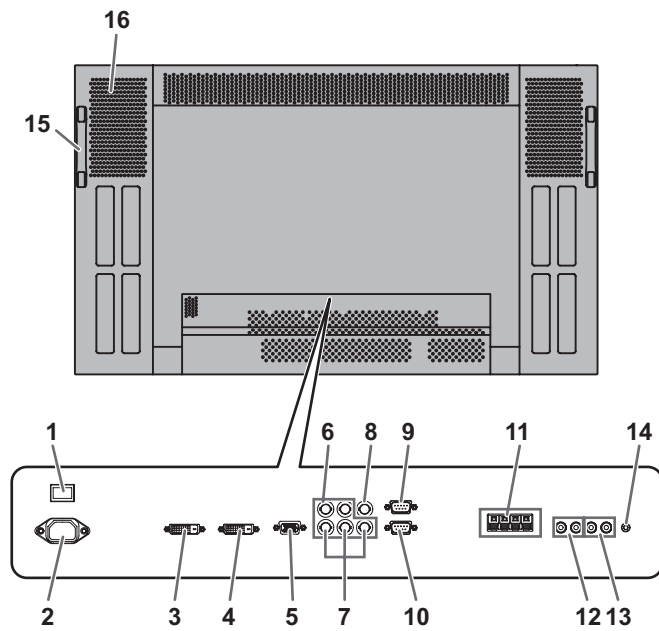

1. Main power switch (See page 14.)
2. AC input terminal (See page 12.)
3. PC/AV output terminal (DVI-D) (See page 11.)
4. PC1 input terminal (DVI-D) (See page 10.)
AV1 input terminal (DVI-D) (See page 10.)
5. PC2 input terminal (Mini D-sub 15 pin) (See page 10.)
6. PC3 input terminals (BNC) (See page 10.)
7. AV2 input terminals (BNC) (See page 10.)
8. AV3 input terminal (BNC) (See page 10.)
9. RS-232C output terminal (D-sub 9 pin) (See page 24.)
10. RS-232C input terminal (D-sub 9 pin) (See page 24.)
11. External speaker terminals (See page 11.)
12. PC/AV audio output terminals (See page 11.)
13. AV audio input terminals (See page 10.)
14. PC audio input terminal (See page 10.)
15. Handles
16. Vents

■Remote control unit

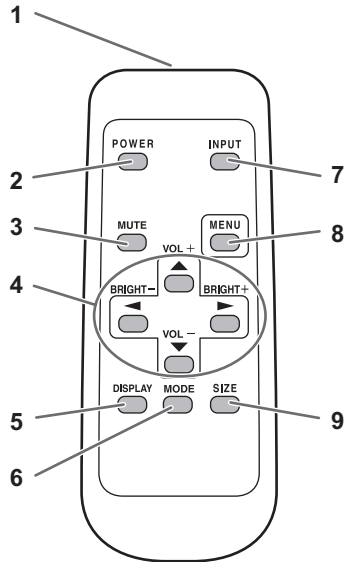

1. Signal transmitter
2. POWER button (See page 14.)
3. MUTE button (See page 15.)
4. VOL +/- buttons (See page 15.)
BRIGHT +/- buttons (See page 15.)
Cursor control (▲ / ▼ / ◀ / ▶) buttons
5. DISPLAY button (See page 15.)
6. MODE button (See page 15.)
7. INPUT button (See page 15.)
8. MENU button (See page 17.)
9. SIZE button (See page 15.)

How to Install the Monitor

Mounting precautions

- Since the monitor is heavy, consult your dealer before installation.
- When installing or moving the monitor, ensure that this is carried out by at least 2 people.
- A stand and mounting bracket compliant with VESA specifications is required. Do not use any screw holes other than VESA holes for installation.
- When moving the monitor, be sure to hold it with the handles both on the rear and the unit bottom. Do not hold the LCD panel. This may cause product damage, failure, or injury.
- Install the monitor with the surface perpendicular to a level surface. If necessary, limit the tilt between 0 and 20 degrees downward.
- Mounting the monitor on the wall requires special expertise and the work must be performed by an authorized SHARP dealer. You should never attempt to perform any of this work yourself. Our company will bear no responsibility for accidents or injuries caused by improper mounting or mishandling.
- This monitor should be used at an ambient temperature between 32°F (0°C) and 104°F (40°C). Provide enough space around the monitor to prevent heat from accumulating inside.

For the monitor in horizontal orientation

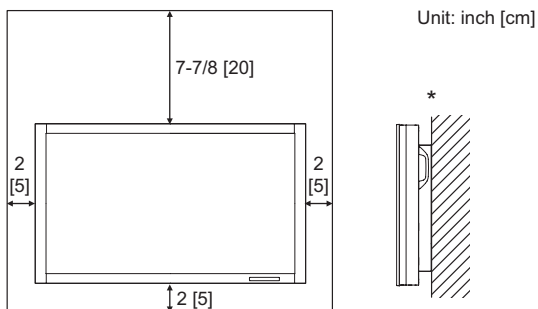

For the monitor in vertical orientation

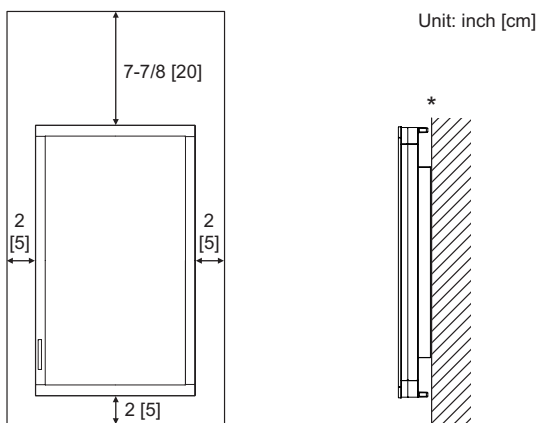

- * The monitor can be installed close to a wall, etc. However, the monitor emits heat during operation. Be aware that heat emitted from the monitor may discolour or alter the wall.

If it is difficult to provide such space because the monitor is installed inside a housing or for other reasons, take other measures to keep the ambient temperature between 32°F (0°C) and 104°F (40°C) such as installing a fan in the housing.

- Adhere to the following when installing the monitor in the vertical orientation. Failing to adhere to the following may cause malfunctions.
 - Install the monitor such that the power LED is located on the downside.
 - Set the MONITOR on the SETUP menu to PORTRAIT. (See page 19.)
- Do not block any ventilation openings. If the temperature inside the monitor rises, this could lead to a malfunction.
- After mounting, it is recommended to take some measures to prevent the monitor from falling down.
- Do not place the monitor on a device which generates heat.
- Be sure to use a stand or a wall-mount/ceiling-mount bracket designed or designated for mounting the monitor.
- This monitor is designed to be installed on a concrete wall/ceiling or pillar. Reinforced work might be necessary for some materials such as plaster / thin plastic board / wood before starting installation. This monitor and bracket must be installed on a wall which can endure at least 3 times or more the weight of the monitor. Install by the most suitable method for the material and the structure.
- Use the supplied vertical logo sticker when you install the monitor in vertical orientation.

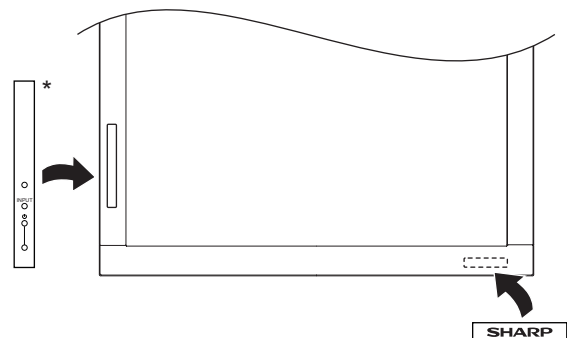

- * Do not remove the factory-affixed sticker but affix the logo sticker over it. Be careful not to cover the remote control sensor or buttons.

Connecting Peripheral Equipment

! Caution

- Be sure to turn off the main power switch and disconnect the plug from the power outlet before connecting/disconnecting cables. Also, read the manual of the equipment to be connected.
- Be careful not to mix up the input terminal with the output terminal when connecting cables. Mixing up the input and output terminals may cause malfunctions and the other problems.

Connection with a PC

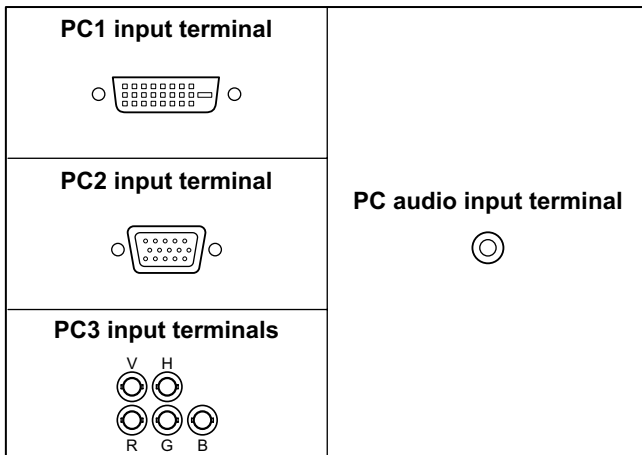

- Use a commercially available signal cable (DVI-D 24 pin) for the PC1 input terminal. Set DVI SELECT on the OPTION menu to PC (DIGITAL) when using the PC1 input terminal. (See page 19.)
- Use a commercially available signal cable (Mini D-sub 15 pin) for the PC2 input terminal.
- Use a commercially available signal cable (BNC) for the PC3 input terminals. Set BNC SELECT on the OPTION menu to PC (ANALOG) when using the PC3 input terminals. (See page 19.)
- Use a commercially available audio cable (mini stereo jack) for the PC audio input terminal. Use an audio cable without resistance.

TIPS

- Images may not be displayed properly depending on the computer (graphics board) to be connected.
- A screen with 1920 x 1080 resolution may not be displayed correctly on PC3 (BNC). In this case, check the settings of your computer (graphics board) to verify that input signals conform to specifications of this monitor (Hsync: 66.3 kHz, Vsync: 60 Hz, and Dot frequency: 148.5 MHz). (See page 34.)
- If there is a check box to disable EDID in display control panel, check it when using PC3 (BNC).
- Use the automatic screen adjustment when a PC screen is displayed for the first time using PC2 or PC3, or when the setting of the PC is changed. (See page 22.)
- The screen is adjusted automatically when SELF ADJUST in the OPTION menu is set to "ON". (See page 19.)

Connection with AV equipment

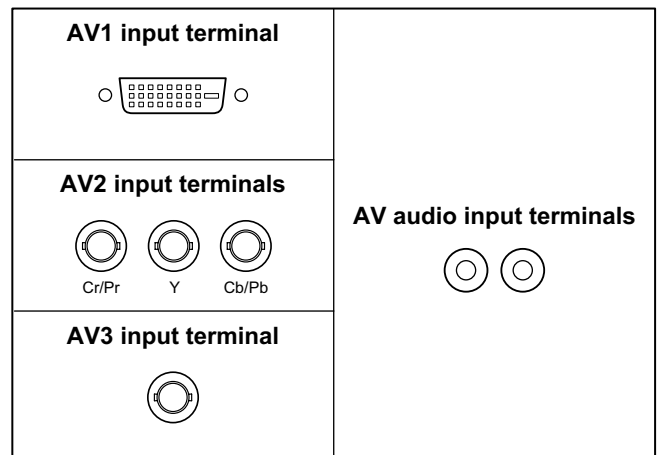

- Use a commercially available signal cable (DVI-D 24 pin) for the AV1 input terminal. Set DVI SELECT on the OPTION menu to AV (DIGITAL) when using the AV1 input terminal. (See page 19.)
- Use a commercially available component cable (BNC) for the AV2 input terminals. Set BNC SELECT on the OPTION menu to AV (COMPONENT) when using the AV2 input terminals. (See page 19.)
- Use a commercially available video cable (BNC) for the AV3 input terminal.
- Use a commercially available audio cable (RCA) for the AV audio input terminals.
- The AV1 input terminal is compatible with the video signals below:
 - 1920 x 1080 p @ 50/59.94/60 Hz
 - 1920 x 1080 i @ 50/59.94/60 Hz
 - 1280 x 720 p @ 50/59.94/60 Hz
 - 720 x 576 p @ 50 Hz
 - 720 x 480 p @ 59.94/60 Hz
 - 640 x 480 p @ 59.94/60 Hz
- The AV2 input terminals are compatible with the video signals below:
 - 1080i(1125i)/50, 1080i(1125i)/60, 720p(750p)/50, 720p(750p)/60, 576p(625p), 576i(625i), 480p(525p), 480i(525i)

Other terminals

PC/AV audio output terminals

- Audio from the equipment connected to the AV audio input terminals or PC audio input terminal is output. Connect to the audio input terminals of the connected equipment using a commercially available audio cable (RCA).
- The audio output varies depending on the input mode selection. (See page 15.)
- The volume level can be adjusted using the volume adjustment. (See page 15.)
- Selecting FIXED of "AUDIO OUTPUT" from the OPTION menu fixes the volume of sound output from the audio output terminals. (See page 19.)
- Audio signals output from the PC/AV audio output terminals cannot be adjusted using the AUDIO menu.

PC/AV output terminals

Video signals from PC1 and AV1 can be output to HDCP-compatible external device. Use this terminal when you connect multiple monitors in a daisy chain via DVI cable (commercially available). (See the description on the right.)
Images cannot be output to device that is not HDCP-compatible.

RS-232C input/output terminals

You can control the monitor from a PC by connecting a commercially available RS-232 straight cable between this terminal and the PC. (See page 24.)

Connecting external speakers

Be sure to use external speakers with an impedance of 6 Ω and a rated input of at least 7 W.

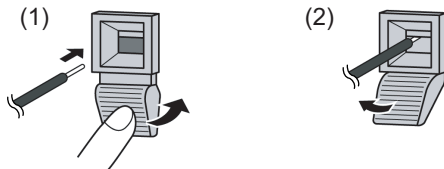

1. While pushing the tab, insert the tip of the cable.
2. Release the tab.

TIPS

- Be sure to connect the + and - terminals and the left and right speakers properly.
- Avoid short circuiting the + and - terminals.

Connecting multiple monitors

You can connect multiple monitors (up to 5 monitors) in a daisy chain by using the PC1/AV1 input terminals and PC/AV output terminals of this monitor.

Connection example

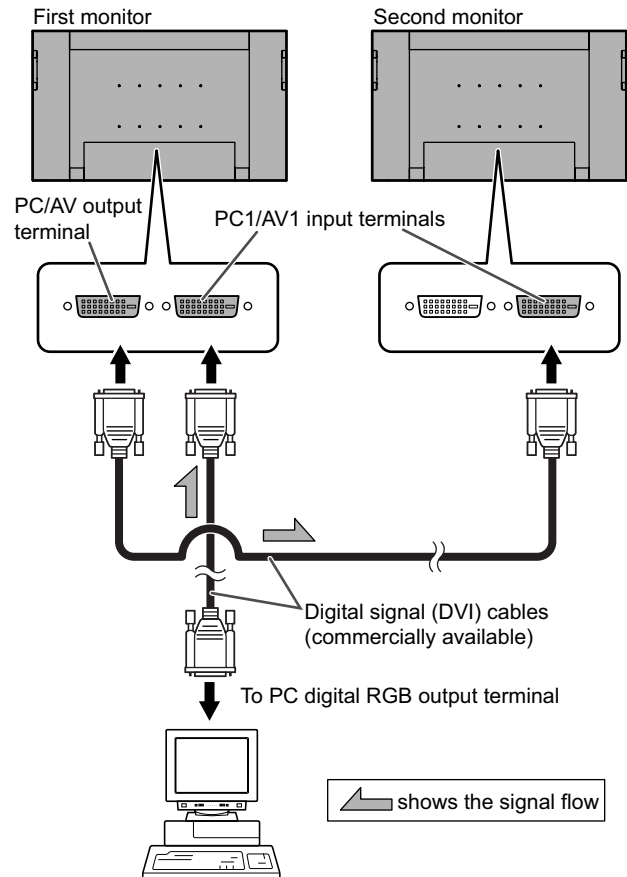

TIPS

- The length of the signal cables or surrounding environment may affect the image quality.
- The screen may not display properly when using terminals other than PC1/AV1 for the input mode. In this case, turn off the power to all the monitors connected in a daisy chain and then turn the power on again.

Connecting the Power Cord

! Caution

- Do not use a power cord other than the one supplied with the monitor.



Be sure to use a power outlet of AC 120 V (60 Hz).

Using power supply other than the one specified may cause fire.

1. Turn off the main power switch.
2. Plug the power cord (supplied) into the AC input terminal.
3. Plug the power cord (supplied) into the AC power outlet.

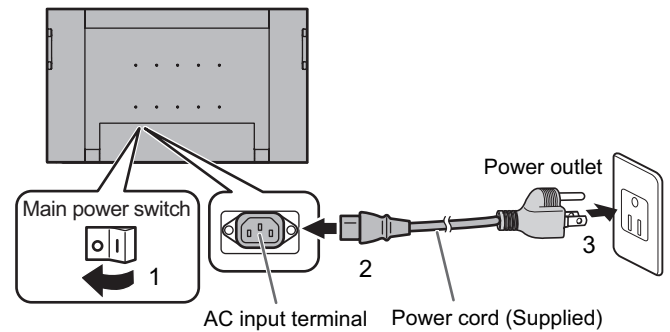

Mounting the Temporary Stands

! Caution

- The monitor is heavy. Make sure to handle the monitor with at least 2 people.
- Please note that the temporary stands are for temporary use only until the monitor is properly mounted.

The temporary stand can be mounted at a position shown in the illustration.

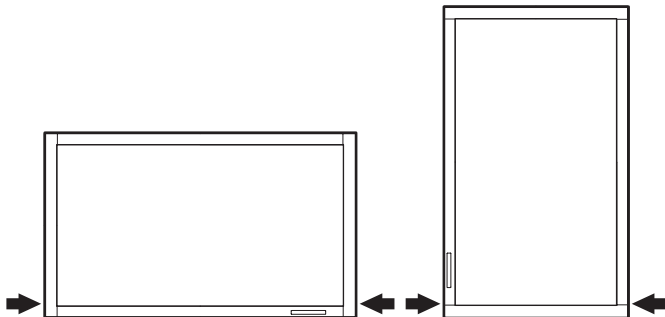

Remove the screws from the monitor and mount the temporary stand using the screws.

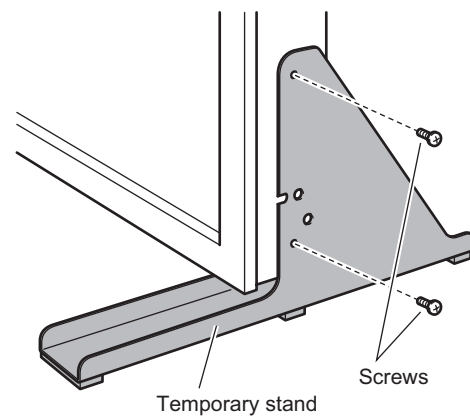

! Caution

- After detaching the temporary stand, be sure to re-mount the removed screws on the monitor.

Binding Cables

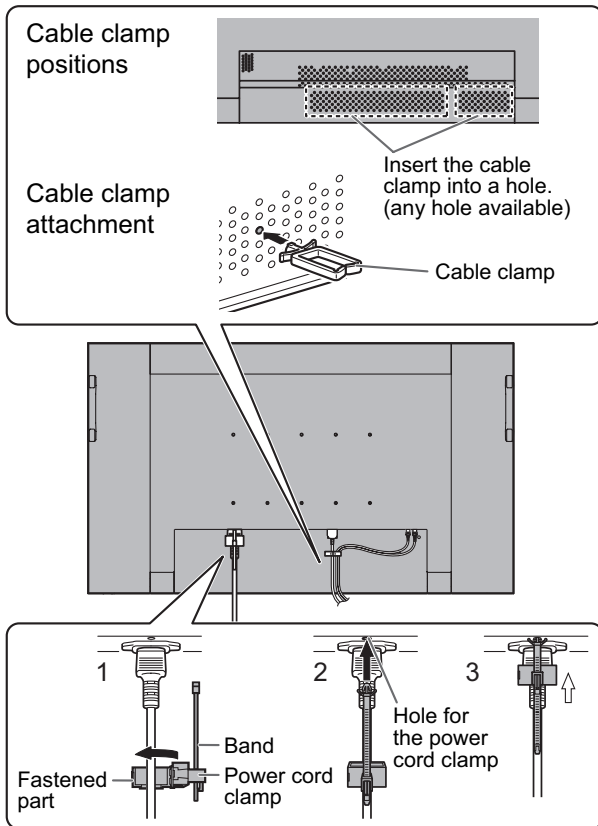

■Attaching the cable clamp

The cables connected to the terminals on the back of the monitor can be neatly bundled using the supplied cable clamps as shown in the illustration.

! Caution

- Verify the position for attaching a cable clamp in advance. A cable clamp cannot be removed once it is attached.

■Fastening the power cord

The power cord can be fastened using the supplied power cord clamp. This will prevent the power cord from being disconnected accidentally.

1. Attach the supplied power cord clamp to the power cord, making sure the power cord clamp is circular hole-sided down.
2. Insert the tip of the band into the hole for the power cord clamp.
3. While holding the tail of the band, slide the fastened part toward the AC input terminal.

Preparing the Remote Control Unit

Installing the batteries

1. Press the cover gently and slide it in the direction of the arrow.

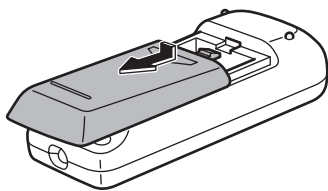

2. See the instructions in the compartment and put in the supplied batteries (2 "AA" size batteries) with their plus (+) and minus (-) sides oriented correctly.
3. Close the cover.

TIPS

- The supplied batteries (2 "AA" size batteries) may become exhausted faster depending on the storage condition. It is recommended that you replace them with new batteries (commercially available) earlier than specified.
- If you will not use the remote control for a long time, remove the batteries.
- Use manganese or alkaline batteries only.

Remote control operation range

The operation range of the remote control unit is approx. 16.4 feet (5 m) at an angle of approx 10° from the center to the top/bottom/right/left of the remote control sensor.

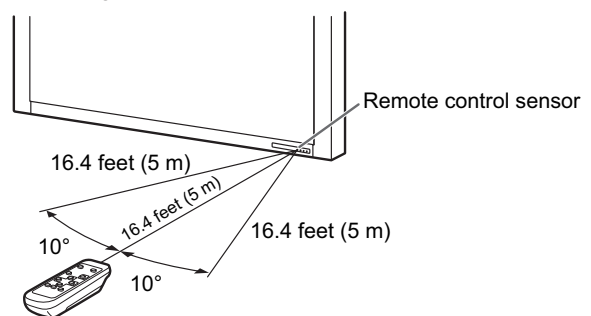

TIPS

- Do not expose the remote control unit to shock by dropping or stepping on it. This could lead to a malfunction.
- Do not expose the remote control unit to liquids, and do not place it in an area with high humidity.
- The remote control unit may not work properly if the remote control sensor is under direct sunlight or strong lighting.
- Objects between the remote control unit and the remote control sensor may prevent proper operation.
- Replace the batteries when they run low as this may shorten the remote control's operation range.
- If a fluorescent light is illuminated near the remote control unit, it may interfere with proper operation.
- Do not use it with the remote control of other equipment such as air conditioner, stereo components, etc.

Turning Power On/Off

! Caution

- Turn on the monitor first before turning on the PC or playback device.

Turning on the main power

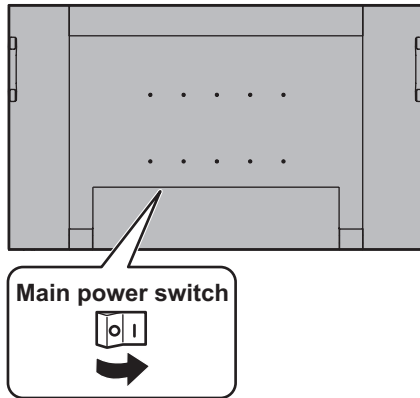

When the main power switch is off, the monitor cannot be turned on using the POWER button on the remote control unit.

Turning power on/off

Press the POWER button to turn the power ON/OFF.

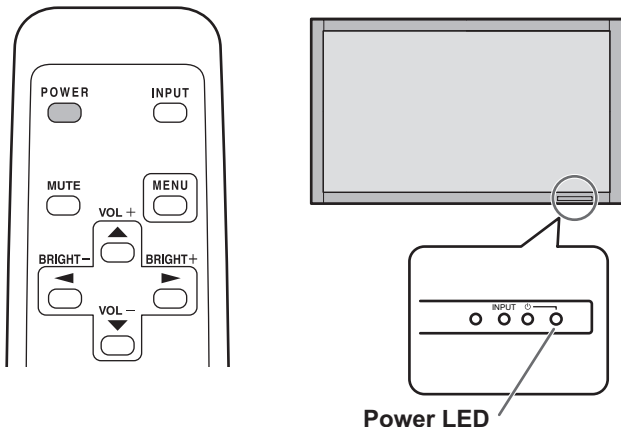

Status of a power LED	Status of the monitor
Green lighting	Power "On"
Orange lighting	Power "Off" (Standby mode)
Green flashing	Input signal standby mode (input using a PC)

! Caution

- When switching the main power switch or the POWER button off and back on, always wait for at least 5 seconds. A short interval may result in a malfunction.

TIPS

- If the monitor is in the input signal standby mode and you press the POWER button on the remote control unit, the monitor enters standby mode.
- You can turn on/off the monitor by pressing the power switch of the monitor.
- Setting the SCHEDULE flashes the power LED alternately in red and orange in standby mode.

■ Date/time setting

- If the time has yet to be set when the monitor is first turned on, the date/time setting screen appears. Set the date and time.

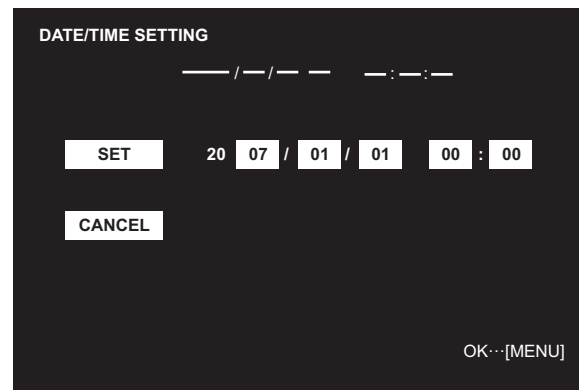

1. Press , , or to select the date and time, and press or to change the numerical values.
 2. Select SET and then press .
- Be sure to set the date and time.
 - The date/time setting screen will close automatically if no operation is performed for about 15 seconds. The date and time can be set using DATE/TIME SETTING from the OPTION menu when the date/time setting screen disappears.

TIPS

- Set the date in "Year/Month/Day" order.
- Set the time on a 24-hour basis.
- The clock stops after the power-off status continues for approximately 1 week.* The date/time setting screen appears at power-on. Be sure to set the date and time. (* This is a guide. The power-off status that stops the clock depends on the status of the monitor.)

Disabling power on/off operations

Power on/power off operations can be disabled in order to protect the monitor from an accidental power off. Set the ADJUSTMENT LOCK in FUNCTION menu to "2". (See page 23.)

Basic Operation

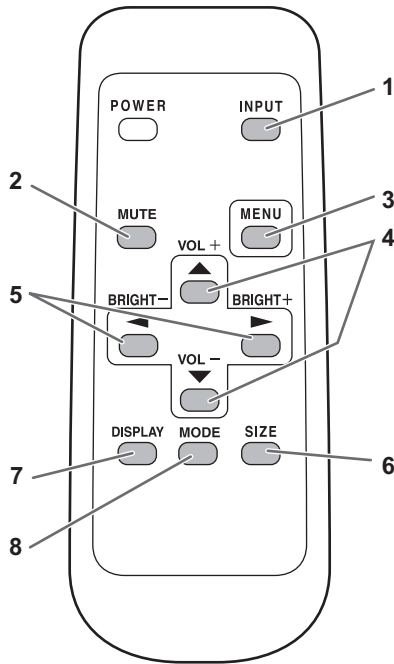

1. INPUT (Input mode selection)

The menu is displayed. Press or to select the input mode, and press to enter.
* You can select the input terminal by pressing the input switch of the monitor.

Input mode	Video	Audio
PC1 DIGITAL ^{*1}	PC1 input terminal	PC audio input terminal
PC2 ANALOG	PC2 input terminal	
PC3 ANALOG ^{*2}	PC3 input terminals	
AV1 DIGITAL ^{*1}	AV1 input terminal	AV audio input terminals
AV2 COMPONENT ^{*2}	AV2 input terminals	
AV3 VIDEO	AV3 input terminal	

^{*1} Select the terminal for DVI SELECT. (See page 19.)
^{*2} Select the terminal for BNC SELECT. (See page 19.)

TIPS

- With the AUTO INPUT CHANGE function set upon shipping from the factory, the input mode automatically switches over to an input to which a video signal is input. (See page 19.)

2. MUTE

Turns off the volume temporarily.
Press the MUTE button again to turn the sound back to the previous level.

3. MENU

Displays and turns off the menu screen (see page 17).

4. VOL +/- (Volume adjustment)

Pressing or displays the VOLUME menu when the menu screen is not displayed.



Press or to adjust the volume of the sound.
* If you do not press any buttons for about 4 seconds, the VOLUME menu automatically disappears.

5. BRIGHT +/- (Backlight adjustment)

Pressing or displays the BRIGHT menu when the menu screen is not displayed.



Press or to adjust the brightness.
* If you do not press any buttons for about 4 seconds, the BRIGHT menu automatically disappears.

6. SIZE (Screen size selection)

The menu is displayed.
Press or to select the screen size. (See page 16.)

7. DISPLAY

Displays monitor information. The display disappears when this button is pressed again or disappears automatically after approximately 15 seconds.

INFORMATION	XXXX/XX/XX XXX	XX:XX:XX
INPUT MODE	: PC2 ANALOG	
SIZE	: WIDE	
COLOR MODE	: STD	
BRIGHT	: 15	
VOLUME	: 15	
ID No.	: 0	
MODEL	: PN-525U	
S/N	:	
1024 x 768		V: 60 Hz H: 48.4 kHz

8. MODE (Color mode selection)

Each time you press this button, the color mode changes in the following order:

STD (Standard) → VIVID → sRGB → STD...

- sRGB applies to PC input only.
sRGB is international standard of color representation specified by IEC (International Electrotechnical Commission). Color conversion is made in taking account of liquid crystal's characteristics and represents color tone close to its original image.

Basic Operation

■Switching the screen size

Even when the screen size is changed, the display may remain the same depending on the input signal.

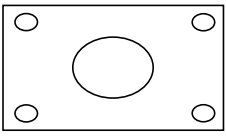
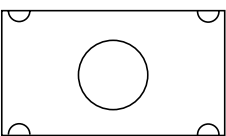
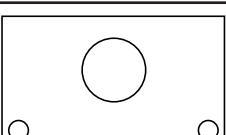
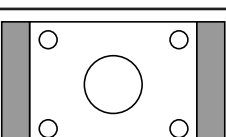
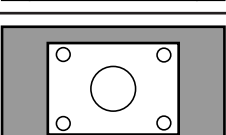
WIDE		PC input	Displays image so it fills the entire screen.
		AV input	An image with a 4:3 aspect ratio is stretched to fill the entire screen.
ZOOM 1		PC input	An image with a 4:3 aspect ratio is enlarged to fill the entire screen without changing the aspect ratio. The edges of the image may be cut off.
		AV input	
ZOOM 2		PC input	Use this size if ZOOM 1 cuts off the subtitles.
		AV input	
NORMAL		PC input	Displays image so it fills the screen without changing the aspect ratio of the input signals.
		AV input	Displays the entire image of the aspect ratio of 4:3 without changing the aspect ratio.
DotbyDot		PC input	Displays the dots of the signals input from the connected PC as the corresponding dots on the screen. *
		AV input	Displays the dots of the input signals as the corresponding dots on the screen.

*: With a monitor with a screen resolution of 1600 x 1200, selecting DotbyDot displays the NORMAL screen.

TIPS

- Using this monitor's screen-size switching or dual-screen display functions to compress or expand the screen for commercial or public viewing in establishments like cafes or hotels may infringe on the rights of the creators, as protected by Copyright Law, so please be careful.
- When "Enlarge" is set, the screen size is fixed to "WIDE" mode.
- When dual-screen display is selected, the screen size cannot be changed.
- The appearance of the original video may change if you select a screen size with a different aspect ratio than the original image (e.g. TV broadcast or video input from external equipment).
- When an ordinary non-wide image (4:3) is viewed with the whole screen using the screen-size switching function of this monitor, the edge of the image may be lost or appear distorted. If you wish to respect the creator's intentions, set the screen size to "NORMAL".
- When playing commercial software, parts of the image (like subtitles) may be cropped. In this case select the optimal screen size using the screen-size switching function of this monitor. With some software, there may be noise or distortion at the edges of the screen. This is due to the characteristics of the software, and is not a malfunction.
- Depending on the original image size, black bands may remain at the edges of the screen.

Menu Items

Displaying the menu screen

Video and audio adjustment and settings of various functions are enabled. This section describes how to use the menu items. See pages 18 to 20 for details of each menu items.

Example of operation

(Adjusting CONTRAST in the PICTURE menu)

1. Press to display the menu screen.

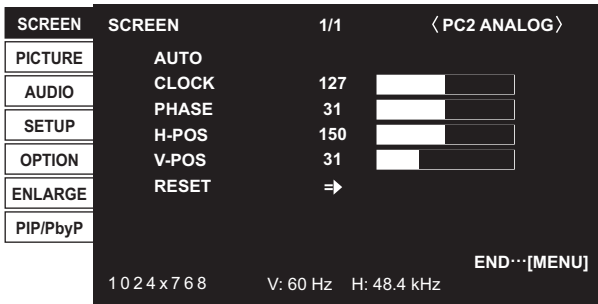

2. Press or to select PICTURE, and press . PICTURE menu is displayed.

3. Press or to select CONTRAST.

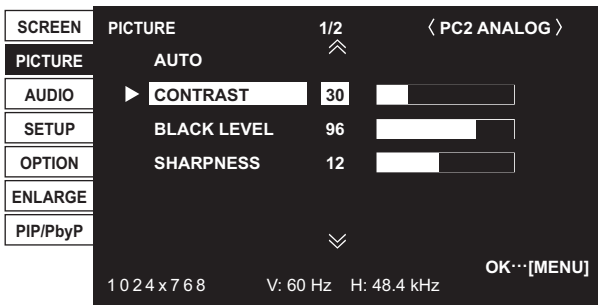

4. Press or to adjust the setting.

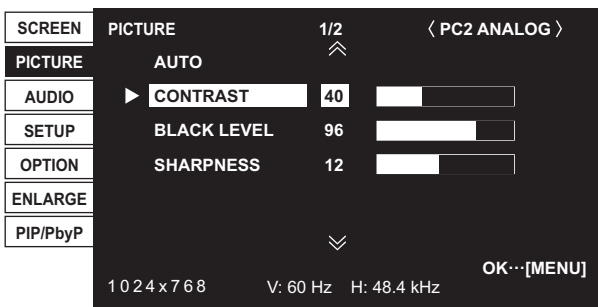

For items that have , press , make settings and then press .

5. Press twice to close the menu screen.

TIPS

- The menu will differ depending on the input mode.
- The menu screen will close automatically if no operation is performed for about 15 seconds. (DATE/TIME SETTING and SCHEDULE screens will close in about 4 minutes.)

Menu screen display

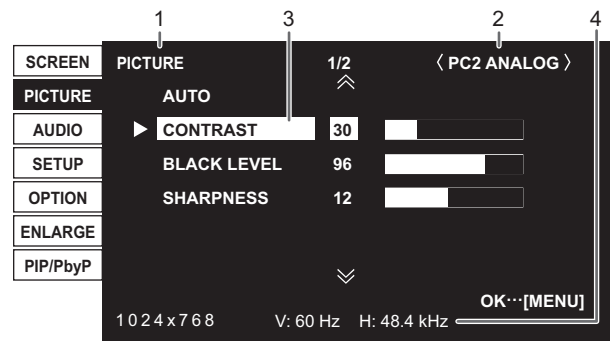

- 1 Name of the menu
- 2 Input mode
- 3 An item being selected (highlighted)
- 4 Screen resolution of input signal, and other data.

TIPS

- Items that cannot be selected appear in gray. (e.g. Function not supported by the current input signal)

Menu Items

Menu item details

The menu will differ depending on the input mode.

■SCREEN (PC2/PC3)

AUTO

The CLOCK, PHASE, H-POS, and V-POS are automatically adjusted.

Pressing  performs adjustment.

Use this automatic adjustment when you use the PC2 input terminal or PC3 input terminals to display a PC screen for the first time or when you change the setting of the PC. (See page 22.)

CLOCK

Adjusts frequency for sampling clock for applicable video. Adjust when there is flickering in the form of vertical stripes. When using the adjustment pattern (see page 22), make adjustments so that no vertical stripe noise appears in it.

PHASE

Adjusts sampling clock phase for applicable video. Useful when small characters appear with low contrast and/or there are flickers at corners. When using the adjustment pattern (see page 22), make adjustments so that no horizontal stripe noise appears in it.
* Adjustments to PHASE should be made only after CLOCK has been correctly set.

H-POS

Adjust the horizontal position of the image.

V-POS

Adjust the vertical position of the image.

RESET

Resets the values of the SCREEN menu items to the factory preset values.

Select "ON" and then press .

■PICTURE

AUTO (PC2/PC3)

The CONTRAST and BLACK LEVEL are automatically adjusted.

Pressing  performs adjustment.

CONTRAST

Adjusts the brightness of the image.

BLACK LEVEL

Adjusts the entire brightness of the video signals.

TINT (AV input)

Adjusts the hue. Selecting + changes the color towards green, and selecting - changes it towards magenta.

COLORS (AV input)

Adjusts the color intensity.

SHARPNESS

Adjusts the sharpness of the image.

ADVANCED (AV input)

You can adjust more specifically. (See page 22.)

COLOR MODE

Changes the color mode on the screen. The color mode on the screen can also be changed using a remote control unit. (See page 15.)

* sRGB is PC input only. See page 15 for details.

WHITE BALANCE

THRU..... Displays the input signal level as is. (for PC1 only)

PRESET Selects the color temperature using PRESET.

USER..... Used for adjusting R-CONTRAST, G-CONTRAST, and B-CONTRAST respectively.

PRESET

Selects the color temperature when the WHITE BALANCE is set to PRESET.

R-CONTRAST

Adjusts red component when the WHITE BALANCE is set to USER.

G-CONTRAST

Adjusts green component when the WHITE BALANCE is set to USER.

B-CONTRAST

Adjusts blue component when the WHITE BALANCE is set to USER.

COPY TO USER

Copies the value set for PRESET to the USER setting.

Select "ON" and then press .

GAMMA

Select a gamma value.

RESET

Resets the values of the PICTURE menu items to the factory preset values.

Select "ON" and then press .

■AUDIO

TREBLE

Adjusts the volume of treble-level sound.

BASS

Adjusts the volume of bass-level sound.

BALANCE

Adjusts the balance of the audio sound between right and left.

RESET

Resets the values of the AUDIO menu items to the factory preset values.

Select "ON" and then press .

■SETUP

OSD H-POSITION

Adjusts the horizontal display position of menu screen.

OSD V-POSITION

Adjusts the vertical display position of menu screen.

SCREEN MOTION

Residual images are reduced by moving the screen.

PATTERN 1 The whole screen moves vertically and horizontally.

PATTERN 2 A black screen spreads from the bottom of the screen and then shrinks to the bottom of the screen.

If the monitor is installed in the vertical orientation, a black screen spreads from the left end of the screen and then shrinks to the left end of the screen.

PATTERN 3 A black bar moves from the left end to the right end of the screen.

If the monitor is installed in the vertical orientation, a black bar moves from the top to the bottom of the screen.

PATTERN 4 Black screens appear from both the top and bottom of the screen, and the displayed image is compressed into the central field. If the monitor is installed in the vertical orientation, the screen is compressed from the left and right ends.

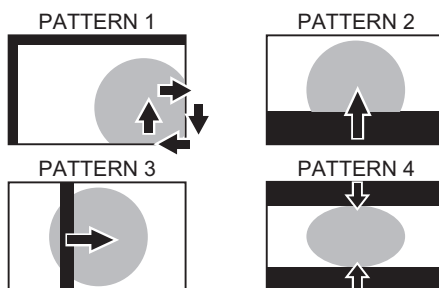
**MOTION TIME 1**

Specify a time period (operating interval) until SCREEN MOTION starts.

MOTION TIME 2

Specify a time period during which SCREEN MOTION operates (time period during which the screen will move).

MONITOR

Select the installation direction of the monitor.

LANDSCAPE Horizontal orientation

PORTRAIT Vertical orientation

LANGUAGE

Sets the display language for the menu screen.

ID No. SET

Assigns ID numbers to monitors connected in a daisy chain (see page 25), using RS-232 cables.

The numbers 1 to 255 are available for ID numbers.

If "0" is set, the system regards this as the state where no ID number is set.

PICTURE FLIP

A picture flips to appear.

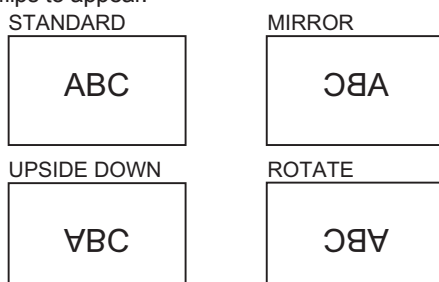
**POWER ON DELAY**

You can delay the screen display after the monitor is turned on. The period can be set up to 60 seconds in units of one second. When this function is activated, the power LED flashes (at approx. 1 second interval) in orange. This function is disabled when 0 is specified.

OPTION**DATE/TIME SETTING**

Set the date and time. Press or to select the date and time, and press or to change the numerical values.

Set the date in "Year/Month/Day" order.

Set the time on a 24-hour basis.

SCHEDULE (See page 21.)

You can set the time to switch the monitor on and off.

DVI SELECT

Selects equipment that is to be connected to the PC1/AV1 input terminal.

BNC SELECT

Selects equipment that is to be connected to the PC3/AV2 input terminals.

QUICK SHOOT

Reduces the visual lag inherent in fast-motion scenes.

COLOR SYSTEM

Select the color system of the AV equipment which is connected to AV3 input terminal. (AUTO / PAL / PAL-60 / SECAM / NTSC3.58 / NTSC4.43)

When AUTO is selected, the color system is automatically set according to the input signal.

AUDIO OUTPUT

Sets the volume of sound output from the PC/AV audio output terminals.

VARIABLE You can adjust the volume using VOLUME.

FIXED Fixes the sounds.

480LINES (PC2/PC3)

If a computer connected to the PC2/PC3 input terminal has a resolution of 640 x 480 or 848 x 480, make a selection according to the resolution.

768LINES (PC2/PC3)

If a computer connected to the PC2/PC3 input terminal has a resolution of 1024 x 768, 1280 x 768 or 1360 x 768, make a selection according to the resolution.

SELF ADJUST

On a PC2/PC3 screen with a resolution of 800 x 600 or higher, specify whether to perform screen adjustment automatically or not. When ON is selected, the screen is automatically adjusted when the timing of input signals varies. "ADJUSTING" appears on the screen during the adjustment.

POWER MANAGEMENT

POWER MANAGEMENT determines whether or not to switch modes from no signal to the input signal standby mode when the PC screen is displayed.

AUTO INPUT CHANGE

Specify whether to change inputs automatically. When ON is selected and no signal is present in the selected input mode, AUTO INPUT CHANGE automatically changes the selected mode to another mode where a video signal is present.

When video signals exist in multiple input modes, the switching priority is as follows:

PC1, PC2, PC3, AV1, AV2 and AV3.

Menu Items

■ENLARGE (PC input)

ENLARGE MODE

Sets the number of screen splits used for the enlargement. (See page 21.)

ENLARGE POS

Specify the split screen to be displayed when the enlargement function is used. (See page 21.)

BEZEL H / BEZEL V

Sets the frame width of the display when the enlargement function is used.

H-POS

Adjust the horizontal position of the enlarged screen.

V-POS

Adjust the vertical position of the enlarged screen.

■PIP/PbyP

PIP MODES

Sets the display method.

OFFDisplays one screen.

PIP.....Displays a sub screen inside a main screen.

PbyPDisplays a main screen and a sub screen in a line.

PbyP2.....Displays a main screen which measures 1280 pixels in the longest direction and a sub screen in a line.

PIP SIZE

Sets the size of the sub screen in PIP mode.

PIP H-POS

Adjusts the horizontal position of the sub screen in PIP mode.

PIP V-POS

Adjusts the vertical position of the sub screen in PIP mode.

PIP BLEND

In PIP mode, use this menu item to display the sub screen transparently.

PIP SOURCE

Selects the input signal of the sub screen in PIP, PbyP, or PbyP2 mode.

SOUND CHANGE

Sets the sound which is output in PIP, PbyP, or PbyP2 mode. If the main screen is displayed as a full screen by the AUTO OFF function, the sound for the main screen is output even when the sound for the sub screen is specified.

MAIN POS

Sets the position of the main screen in PbyP or PbyP2 mode.

PbyP2 POS

Sets the position of the sub screen in PbyP2 mode.

AUTO OFF

Sets the display method when no signals for the sub screen are input in PIP, PbyP, or PbyP2 mode.

MANUAL..... Displays a main screen and a black sub screen.

AUTO..... Displays the main screen as a full screen.

TIPS

- When WHITE BALANCE is set to THRU, BLACK LEVEL, CONTRAST and GAMMA cannot be set.
- If COLOR MODE is set to sRGB or VIVID, the following items cannot be set.
WHITE BALANCE, PRESET, R-/G-/B-CONTRAST, COPY TO USER, and GAMMA

■Dual screen display

You can display the screens of the PC input signal and AV input signal simultaneously.

Set this function with "PIP MODES" in the PIP/PbyP menu.

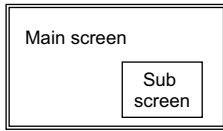
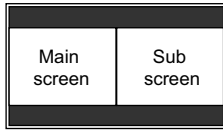
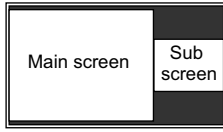
PIP		A sub screen is displayed inside a main screen.
PbyP		A main screen and a sub screen are displayed in a line.
PbyP2		Displays a main screen which measures 1280 pixels in the longest direction and a sub screen in a line.

- * The currently selected input signal is displayed on the main screen.
- * You cannot simultaneously display the screens of signals of the same type, such as two types of PC input signals or two types of AV input signals.

TIPS

- You might infringe on a copyright of the author which is protected by copyright law when you display the images of the computer screen and television/VCR simultaneously for profit-making or to show the image to the public.
- The screen size for dual-screen display is the same as the screen size for single-screen display. The DotbyDot screen is displayed in NORMAL size except when it is set as the PIP main screen.
- When dual-screen display is selected, the SCREEN MOTION function is disabled.
- When dual-screen display is selected, the AUTO INPUT CHANGE function is disabled.
- When dual-screen display is selected, the screen cannot be enlarged.
- When dual-screen display is selected, the following adjustments of ADVANCED are invalid and adjusting is disabled.
3D-NR, MPEG-NR and 3D-Y/C

■Enlarge

You can align 4, 9, 16, or 25 monitors and integrate them into a single large screen to display. Enlarged views of separated images are displayed in each monitor.

In horizontal orientation

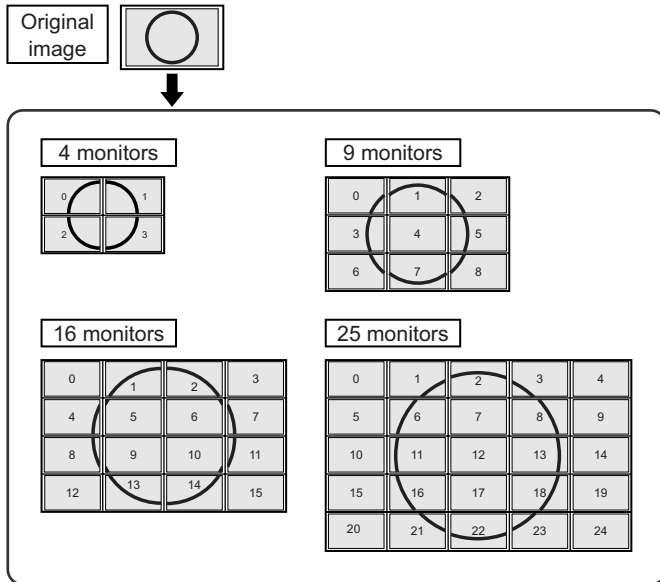

In vertical orientation

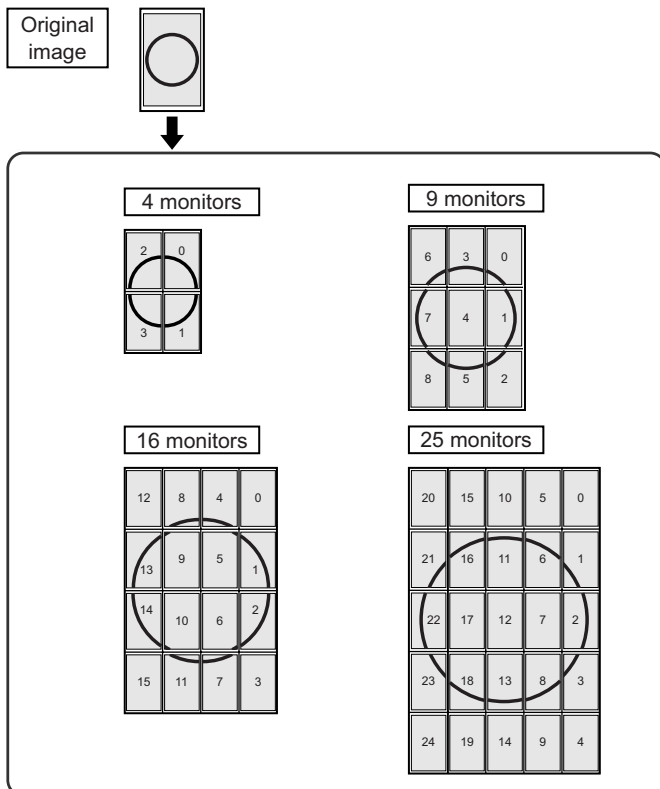

TIPS

- AV input signals cannot be used for the Enlarge function.
- To integrate 9 or more monitors using PC1 signals, a splitter for the video signal (commercially available) is required.
- When connected in PC2/PC3, a splitter for the video signal (commercially available) is required.
- When Enlarge is used, the SCREEN MOTION function is disabled.
- When Enlarge is used, the AUTO INPUT CHANGE function is disabled.

■SCHEDULE

You can set the time to switch the monitor on and off. Set this function with "SCHEDULE" in the OPTION menu. (See page 19.)

SCHEDULE		< PC2 ANALOG >				
XXXX/XX/XX XXX XX:XX:XX						
No.	(1)	POWER (2)	DAY OF THE WEEK (3)		TIME (4)	INPUT (5)
1	---	---	---	---	---	---
2	---	---	---	---	---	---
3	---	---	---	---	---	---
4	---	---	---	---	---	---
5	---	---	---	---	---	---
6	---	---	---	---	---	---
7	---	---	---	---	---	---
8	---	---	---	---	---	---

1 0 2 4 x 7 6 8 V: 60 Hz H: 48.4 kHz OK...[MENU]

1. Press or to select the SCHEDULE number, and press .
2. Set the SCHEDULE. (See the description below.)
Press or to select items, and press or to change the setting.
3. Press .
SCHEDULE becomes effective.

(1)

- : SCHEDULE effective
- : SCHEDULE not effective

(2) POWER

ON : Switches the monitor on at the specified time.
OFF : Switches the monitor off at the specified time and puts the monitor in standby mode.

(3) DAY OF THE WEEK

Specifies the day of the week to execute the SCHEDULE.
ONLY ONCE:

Executes the SCHEDULE once on the specified day.
Specify the day of the week to execute the SCHEDULE.

EVERY WEEK:

Executes the SCHEDULE on the specified day of the week every week. Specify the day of the week to execute the SCHEDULE.

Periodic setting such as "Monday through Friday" is also possible.

EVERY DAY:

Executes the SCHEDULE every day regardless of the day of the week.

(4) TIME

Specifies the time to execute the SCHEDULE.
Set the time on a 24-hour basis.

(5) INPUT

Specifies the input mode at power-on. When not specifying, the screen at the previous power-off appears.

Input modes displayed on "PC1/AV1" depend on DVI SELECT settings.

Input modes displayed on "PC3/AV2" depend on BNC SELECT settings.

Menu Items

! Caution

- Do not switch off the main power after setting the SCHEDULE.
- Specify the correct date and time. (See pages 14 and 19.) SCHEDULE does not function unless the date and time are specified.
- Check regularly that the set date and time are correct.

TIPS

- Up to 8 SCHEDULE items can be registered.
- Setting the SCHEDULE flashes the power LED alternately in red and orange in standby mode.
- A SCHEDULE that has a large number has precedence over that of a small number when schedules overlap.

■ADVANCED items (AV input) (See page 18.)

FLESH TONE

Adjust the hue control.

3D-NR

Reduce the noise of playback images on video. Setting a higher level reduces more noise. However, it may cause blurring on an image.

MPEG-NR

Reduce block noise caused by digital compression.







3D-Y/C (AV3)

Specify whether to perform 3-dimension Y/C separation. If dot interference or cross-color is occurring in fast-motion scenes, selecting "OFF" may improve the image quality.

Adjustments for PC screen display

■Automatic adjustment

When you use the PC2 input terminal or PC3 input terminals to display a PC screen for the first time, or when you change the setting of the PC, use the automatic screen adjustment.

1. **Switch the input to PC2 or to PC3 and display the adjustment pattern.** (See the description below.)
2. Press  and use  or  to display the SCREEN menu.
3. Press  and select "AUTO".
4. Press .
5. Press  twice to close the menu screen.

TIPS

- If the screen cannot be adjusted properly with one automatic adjustment, repeat the automatic adjustment two or three times. Try manual adjustment if necessary.

■Screen display for adjustment

Before making adjustments in the SCREEN menu or PICTURE menu, display an image to brighten the entire screen. If you are using a Windows PC, use the adjustment pattern on the supplied CD-ROM.

Opening the adjustment pattern

1. **Load the supplied CD-ROM into the computer's CD-ROM drive.**
2. **Open the CD-ROM in [My Computer].**
3. **Double-click [Adj_uty.exe].**
The adjustment pattern will appear.
Adjust the screen automatically or manually.

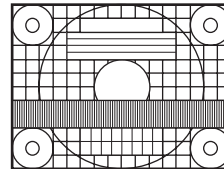

4. **When adjustment is finished, press the [Esc] on the computer's keyboard to quit the adjustment program.**
5. **Eject the CD-ROM from the CD-ROM drive.**

TIPS

- If the display mode on the computer you are using is 65,000 colors, the color levels in the color pattern may appear differently or grayscale may appear to be colored. (This is due to the specifications of the input signal and is not a malfunction.)

Initialization (Reset)/Functional Restriction Setting

You can return the settings to their factory-preset values and restrict operations.

1. After pressing **SIZE** for about 5 seconds, press **▲**, **▶**, **▼**, and **◀** in that order.

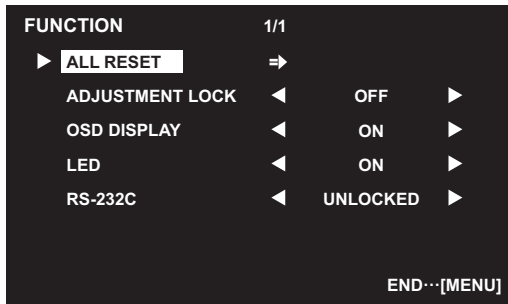

2. Select and set the items.

ALL RESET

Resets the settings to the factory default settings.

Press **▶**, select "ON" and then press **MENU**.

After initialization, turn the main power switch off and then back on.

ADJUSTMENT LOCK

You can disable operations on the monitor and the remote control unit that use buttons.

OFF ... Enables operation.

1 Disables all operations other than turning power on/off and FUNCTION.

2 Only the FUNCTION operation is enabled.
Disables all operations other than FUNCTION (not even power on/off).

OSD DISPLAY

Hides/shows menus.

The FUNCTION screen cannot be hidden.

ON Displays the menus.

OFF Hides the menus.

LED

Specifies whether to light power LEDs.

ON Lights power LEDs.

OFF Does not light power LEDs.

RS-232C

Specifies whether to allow control via RS-232C (see page 24).

LOCKED Disables control via RS-232C.

UNLOCKED Enables control via RS-232C.

3. Press **MENU** to return to the normal screen.

Controlling the Monitor with a PC

You can control this monitor from a PC via RS-232C (COM port) on the PC.

You can also connect multiple monitors via a daisy chain by using a PC. By assigning ID numbers to each monitor (see page 25), you can make input mode selection/adjustment or can check the status of a specific monitor.

PC connection

■ One-to-one connection with a PC

Connect with RS-232C straight cable between the PC's COM port (RS-232C connector) and the RS-232C input terminal on the monitor.

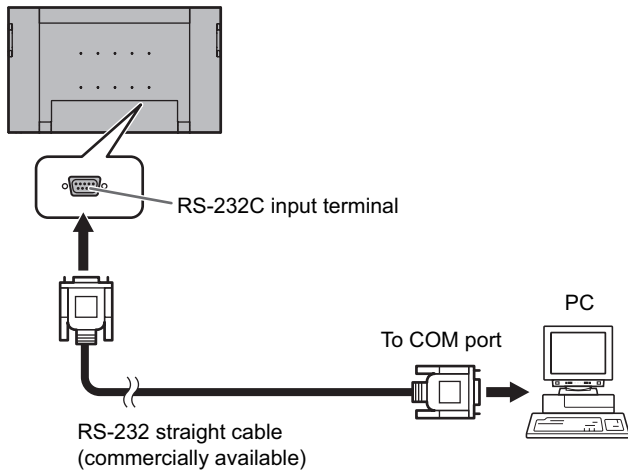

■ Daisy chain connection... Advanced operation

Connect with RS-232C straight cable between the PC's COM port (RS-232C connector) and the RS-232C input terminal on the first monitor.

Next, connect RS-232C straight cable to the first monitor's RS-232C output terminal and to the second monitor's RS-232C input terminal. Connect in the same way to the third and subsequent monitors.

Up to 25 monitors can be connected. (Depending on the length of the cable used and the surrounding environment.)

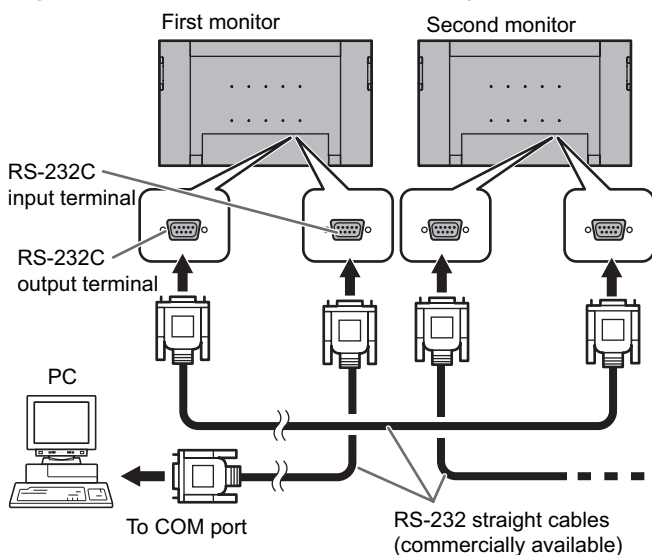

Communication conditions

Set the RS-232C communication settings on the PC to match the monitor's communication settings as follows:

Baud rate	9600 bps	Stop bit	1 bit
Data length	8 bits	Flow control	None
Parity bit	None		

Communication procedure

■ Command format

When a command is sent from the PC to the monitor, the monitor operates according to the received command and sends a response message to the PC.

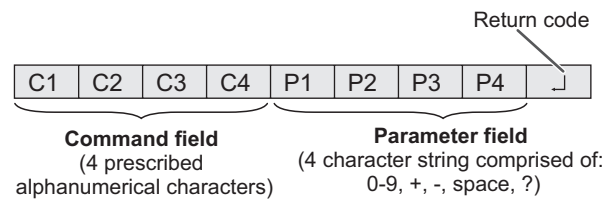

Example: VOLM0030
VOLM 30

- * Be sure to input 4 characters for the parameter. Pad with spaces (" ") if necessary.
(" " is a return code (0DH, 0AH or 0DH))
Wrong : VOLM30
Right : VOLM 30

When inputting a negative value, specify a numerical value in three digits.

Example: AUTR-009

Do not use spaces for MPOS, DATE, and SC01 through SC08. Specify parameters using a specified number of characters.

Example: MPOS010097

If a command has "R" listed for "DIRECTION" in the "RS-232C command table" on page 28, the current value can be returned by using "?" as the parameter.

Example:

VOLM ? ? ? ? ← From PC to monitor (How much is current volume setting?)

30 ← From monitor to PC (Current volume setting: 30)

- * If an ID number (see page 25) has been assigned (For example, ID number = 1)
VOLM ? ← From PC to monitor
30 001 ← From monitor to PC

Response code format

When a command has been executed correctly

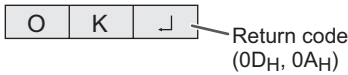

A response is returned after a command is executed.

- * If an ID number has been assigned

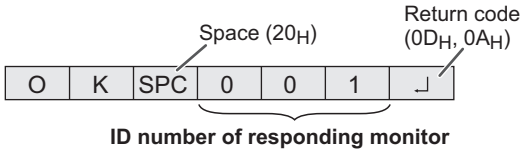

When a command has not been executed

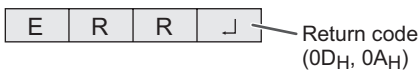

- * If an ID number has been assigned

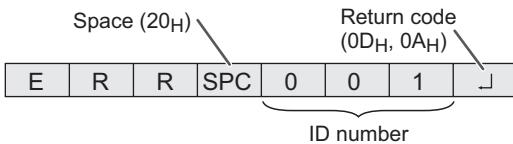

TIPS

- "ERR" is returned when there is no relevant command or when the command cannot be used in the current state of the monitor.
- If communication has not been established for reasons such as a bad connection between the PC and monitor, nothing is returned (not even ERR).
- If no monitor has been assigned the designated ID number (e.g. if the command IDSL0002 [↵] is used, but no monitor with ID number: 2 is found), no response is returned.

If execution of the command is taking some time

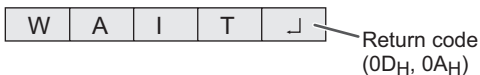

When the following commands are used, "WAIT" is returned. In this case, a value will be returned if you wait a while. Do not send any command during this period.

No ID number is attached to WAIT response.

- Commands which return WAIT:
 1. When repeater control is used
 2. When an IDSL or IDLK command is used
 3. When one of the following commands is used: RSET, INPS, ASNC, WIDE, EMAG, EPOS, PXSL, POWR, AGIN, MWIN, MWIP, MWPP, ESTG

When control via RS-232C is locked (to prevent use) using the operation lock function (see page 23)



Communication interval

- After OK or ERR is returned, you must send the following commands.
To set a timeout for the command response, specify 10 seconds or longer.
- Provide an interval of 100 ms or more between the command response and the transmission of the next command.

VOLM0020
OK

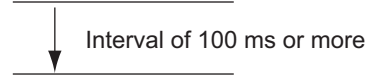

INPS0001
WAIT
OK

Advanced operation

This section explains commands for daisy chain connection. The basic communication procedure is the same as in the "One-to-one connection with a PC" section.

ID numbers

You can assign a unique ID number to each monitor (see page 19). This allows you to control a particular monitor in a daisy chain of monitors.

You can assign ID numbers either from the menu screen (using the remote control) or from the PC using RS-232 cable.

[Example]

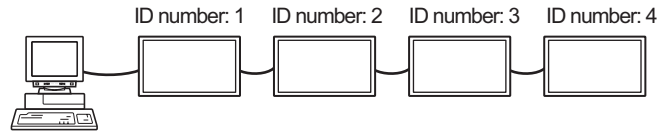

If monitors are connected as shown above, you can execute commands like "Set the volume of the monitor with ID 4 to 20".

When controlling monitors linked in a daisy chain by designating ID numbers, you should basically avoid any duplication of ID numbers.

ID numbers do not have to be assigned in ascending order starting from the PC. They can also be connected as shown below.

[Example]

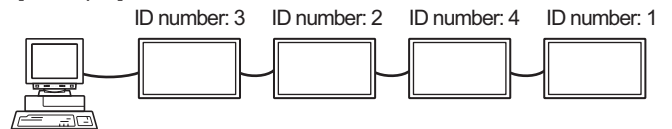

Controlling the Monitor with a PC

■ Commands for ID control

The command examples shown on this page assume the following connection and ID number set up.

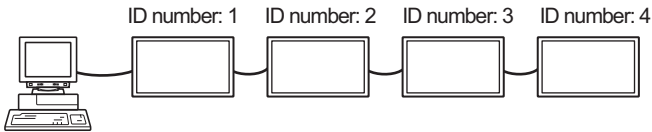

IDSTA monitor receiving this command sets its own ID number in the parameter field.

Example:

```
IDST001
OK _ 001 ← The ID number of this monitor is set to 1.
```

TIPS

You can automatically assign ID numbers by using the IDST command with the Repeater control (see "Repeater control" on page 27).

For example, using the command "IDST001+" automatically sets the ID numbers, as shown below.

[Example]

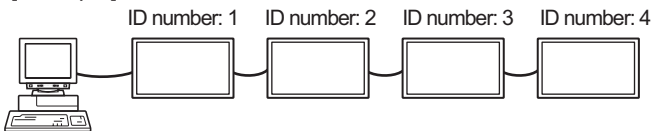

```
IDST001 + ← ID setting command with repeater control
WAIT
OK _ 001 ← "OK" response from ID number: 1
OK _ 002 ← "OK" response from ID number: 2
OK _ 003 ← "OK" response from ID number: 3
OK _ 004 ← "OK" response from ID number: 4 (End)
```

IDSLThe parameter of this command sets the ID number of the monitor. The monitor is subject to the next command.

Example:

```
IDSL0002 ← The next command is for the monitor with
           ID number: 2.
WAIT ← Searching for monitor with ID number: 2
OK _ 002 ← Found monitor with ID number: 2
VOLM0030 ← Sets volume of monitor with ID number:
           2 to 30.
WAIT ← Processing
OK _ 002 ← OK response from monitor with ID
           number: 2
VOLM0020 ← Sets volume to 20.
OK _ 001 ← The volume of the monitor with ID
           number: 1 (the one directly connected
           to the PC) is set to 20.*
```

* The IDSL command is effective only once, for the immediately succeeding command.

IDLKThe parameter of this command sets the ID number of the monitor. The monitor is subject to all subsequent commands.

Example:

```
IDLK0002 ← Following commands are for the monitor
           with ID number: 2.
WAIT ← Searching for monitor with ID number: 2
OK _ 002 ← Found monitor with ID number: 2
VOLM0030 ← Sets volume of monitor with ID number:
           2 to 30.*
WAIT ← Processing
OK _ 002
VOLM0020 ← Sets volume of monitor with ID number:
           2 to 20.*
WAIT
OK _ 002
IDLK0000 ← Canceling fixed ID number setting
WAIT ← Canceling IDLK
OK _ 002 ← Cancellation complete
VOLM0010
OK _ 001 ← The volume of the monitor with ID number: 1
           (the one directly connected to the PC) is set
           to 10. (IDLK is canceled.)
```

* The IDLK command remains effective until it is canceled, or power is shut off.

IDCKProvides screen display of the ID number currently assigned to a monitor, and the ID number currently set for IDLK (if any).

Example:

```
(After executing IDLK0002)
IDCK0000 ← (Parameter has no meaning.)
           Returned response. The ID
           number is also displayed on the
           monitor screen.
ID : 001 IDLK : 002 ←
IDCK0000 + ← Repeater control (If a command
WAIT is used with repeater control, ID
ID : 001 IDLK : 000 designation using IDSL or IDLK is
ID : 002 IDLK : 000 canceled.)
ID : 003 IDLK : 000
ID : 004 IDLK : 000
```

■ Repeater control

This system has a function to allow setting of multiple monitors connected in a daisy chain using a single command. This function is called repeater control. You can use Repeater control function without assigning ID numbers.

[Example]

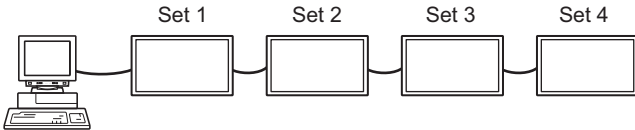

* If monitors are connected as shown above, you can execute a command like "Set all monitors' input settings to PC1 DIGITAL".

■ Repeater control command

Repeater control is achieved by setting the FOURTH CHARACTER of the parameter to "+".

Example:

VOLM030 + ← Sets volume of all monitors to 30.

In repeater control, responses are returned by all the connected monitors.

If you want to determine that a value has been returned by a specific set, assign ID numbers to each monitor in advance. When some monitors do not return their responses, the probable cause is that the monitors could not receive the command or command processing is not complete. Do not send a new command.

Example: (When 4 monitors are connected, and assigned ID numbers: 1 through 4)

```
VOLM030 +
WAIT
OK _ 001
OK _ 002
OK _ 003
OK _ 004 ← If 4 monitors are connected in
           a chain, reliable operation can
           be ensured by sending a new
           command only after a reply
           has been returned by 4th (last)
           monitor.
```

Repeater control can also be used for reading settings.

Example:

```
VOLM ??? +
WAIT
10 _ 001
20 _ 002
30 _ 003
30 _ 004
```

Volume settings for all monitors are returned.

TIPS

- If repeater control is used during ID designation (IDSL, IDLK), the ID designation is canceled.
- Commands that use parameters consisting of more than four characters can not be controlled by repeater control.

Controlling the Monitor with a PC

RS-232C command table

How to read the command table

- Command: Command field (See page 24.)
 Direction: W When the "Parameter" is set in the parameter field (see page 24), the command functions as described under "Control/Response Contents".
 R The returned value indicated under "Reply" can be obtained by setting "????", "____?" or "???" (repeater control) in the parameter field (see page 24).
 Parameter: Parameter field (See page 24.)
 Reply: Response (Returned value)
 *: "Yes" indicates commands which can be used in power standby mode.

TIPS

- To specify the horizontal/vertical positions for vertical orientation, specify the values for horizontal orientation.

Power control/Input mode selection

Function	Command	Direction	Parameter	Reply	Control/Response contents	*
POWER CONTROL	POWR	W	0		Switches to standby mode.	Yes
			1		Returns from standby mode.	
		R		0	Standby mode	
				1	Normal mode	
				2	Input signal waiting mode	
INPUT MODE SELECTION	INPS	W	0		Toggle change for input mode Terminals not selected in DVI SELECT/BNC SELECT cannot be selected.	Yes
			1		PC1 DIGITAL "ERR" when AV (DIGITAL) is selected for DVI SELECT.	
			2		PC2 ANALOG	
			3		AV2 COMPONENT "ERR" when PC (ANALOG) is selected for BNC SELECT.	
			4		AV3 VIDEO	
			6		PC3 ANALOG "ERR" when AV (COMPONENT) is selected for BNC SELECT.	
			7		AV1 DIGITAL "ERR" when PC (DIGITAL) is selected for DVI SELECT.	
			R		1	
				2	PC2 ANALOG	
				3	AV2 COMPONENT	
				4	AV3 VIDEO	
				6	PC3 ANALOG	
				7	AV1 DIGITAL	

SCREEN menu (PC2/PC3)

Function	Command	Direction	Parameter	Reply	Control/Response contents	*
AUTO	ASNC	W	1			No
CLOCK	CLCK	WR	0-255	0-255		No
PHASE	PHSE	WR	0-63	0-63		
POSITIONING	POSITION OF THE LONGEST DIRECTION	HPOS	WR	0-500	0-500	
	POSITION OF THE SHORTEST DIRECTION	VPOS	WR	0-100	0-100	
RESET	ARST	W	1			No

PICTURE menu

Function	Command	Direction	Parameter	Reply	Control/Response contents	*	
AUTO	AGIN	W	1		When the input mode is PC2, PC3.	No	
CONTRAST	CONT	WR	0-60	0-60	0-127 on PC2/PC3.	Yes	
BLACK LEVEL	BLVL	WR	0-60	0-60	0-127 on PC2/PC3.		
TINT	TINT	WR	0-60	0-60	When the input mode is AV.		
COLORS	COLR	WR	0-60	0-60			
SHARPNESS	SHRP	WR	0-24	0-24			
ADVANCED	FLESH TONE	FLES	WR	0-2	0-2	0: OFF, 1: LOW, 2: HIGH	Yes
	3D-NR	TDNR	WR	0-2	0-2	0: OFF, 1: LOW, 2: HIGH	
	MPEG-NR	MPNR	WR	0-1	0-1	0: OFF, 1: ON	
	3D-Y/C	YCSP	WR	0-1	0-1	0: OFF, 1: ON	
COLOR MODE	BMOD	WR	0	0	STD	Yes	
			2	2	VIVID		
			3	3	sRGB (When the input mode is PC)		
WHITE BALANCE	THRU	CTMP	WR	0	0	When the input mode is PC1.	Yes
	PRESET			1-15	1-15	From 1: approximately 3,000K to 15: approximately 10,000K (500K steps)	
	USER			99	99		
	R-CONTRAST	CRTR	WR	0-512	0-512	"ERR" when CTMP is not set to 99.	
	G-CONTRAST	CRTG	WR	0-512	0-512		
B-CONTRAST	CRTB	WR	0-512	0-512			
GAMMA	GAMM	WR	0-2	0-2	0: 1.8, 1: 2.2, 2: 2.4	Yes	
RESET	ARST	W	2			No	

AUDIO menu

Function	Command	Direction	Parameter	Reply	Control/Response contents	*
TREBLE	AUTR	WR	-10-10	-10-10		Yes
BASS	AUBS	WR	-10-10	-10-10		
BALANCE	AUBL	WR	-10-10	-10-10		
RESET	ARST	W	3			No

SETUP menu

Function	Command	Direction	Parameter	Reply	Control/Response contents	*	
SCREEN MOTION	SCSV	WR	0-4	0-4	0: OFF, 1-4: PATTERN 1-4	Yes	
MOTION TIME 1	MTIM	WR	0-20	0-20		Yes	
MOTION TIME 2	PATTERN 1	MINT	WR	10-990	10-990	Per 10 seconds	Yes
	PATTERN 2-4	MINT	WR	5-20	5-20	Per second	
MONITOR	STDR	WR	0-1	0-1	0: LANDSCAPE, 1: PORTRAIT	Yes	
LANGUAGE	LANG	WR	14	14	ENGLISH	Yes	
			1	1	DEUTSCH		
			2	2	FRANÇAIS		
			3	3	ITALIANO		
			4	4	ESPAÑOL		
			5	5	РУССКИЙ		
ID NUMBER	ID NO. SETTING	IDST	W	0-255		Sets the monitor's ID number. ("0" means "no ID number".)	Yes
					0-255	Returns the monitor's ID number.	
	ID NO. SETTING (ONCE)	IDSL	W	1-255		Sets a monitor ID number. This ID number is only effective for the command immediately after this command.	Yes
				0		Clears the ID number if one has been designated.	
	ID NO. SETTING (SUBSEQUENT)	IDLK	W	1-255		Sets a monitor ID number. This ID number is effective for the next and all subsequent commands after this command.	Yes
0					Clears the ID number if one has been designated.		
ID CHECK	IDCK	W	0	ID : xxx IDLK : yyy	Displays monitor's own ID number and the selected ID number on the screen.	Yes	
PICTURE FLIP	PFIL	WR	0-3	0-3	0: OFF, 1: MIRROR, 2: UPSIDE DOWN, 3: ROTATE	Yes	
Power On Delay	PWOD	WR	0	0	OFF	Yes	
			1-60	1-60	ON		

Controlling the Monitor with a PC

OPTION menu

Function	Command	Direction	Parameter	Reply	Control/Response contents	*	
DATE/TIME SETTING	DATE	WR	AABBCCDDEE	AABBCCDDEE	AA: Year, BB: Month, CC: Day, DD: Time, EE: Minute	Yes	
SCHEDULE	SC01-SC08	WR	ABCDEFEGGH	ABCDEFEGGH	Schedule of a specified number A: Schedule 0 = Not effective, 1 = Effective B: Power 0 = OFF, 1 = ON C: Day of the week 1 0 = Only once, 1 = Every week, 2 = Every day D: Day of the week 2 0 = Sunday, 1 = Monday through 6 = Saturday, 9 = Not exist E: Day of the week 3 0 = Sunday, 1 = Monday through 6 = Saturday, 9 = Not exist F: Time 00-23 G: Minute 00-59 H: Input 0 = Not specified, 1 = PC1/AV1, 2 = PC2, 3 = PC3/AV2, 4 = AV3	Yes	
DVI SELECT	DVSL	WR	0-1	0-1	0: PC (DIGITAL), 1: AV (DIGITAL)	Yes	
BNC SELECT	BNSL	WR	0-1	0-1	0: PC (ANALOG), 1: AV (COMPONENT)	Yes	
QUICK SHOOT (PC)	QSPC	WR	0-1	0-1	0: OFF, 1: ON	Yes	
QUICK SHOOT (AV)	QSAV	WR	0-1	0-1	0: OFF, 1: ON	Yes	
COLOR SYSTEM	CSYS	WR	0-5	0-5	0: AUTO, 1: PAL, 2: PAL-60, 3: SECAM, 4: NTSC 3.58, 5: NTSC 4.43	Yes	
AUDIO OUTPUT	AOUT	WR	0-1	0-1	0: VARIABLE, 1: FIXED	Yes	
INPUT RESOLUTION (PC)	RESOLUTION CHECK PIXEL SETTING (PC2, PC3)	PXCK	R		-	Returns current resolution in the form of hhh, vvv.	No
				1	1	V: 768) 1360 x 768	
				2	2	V: 768) 1280 x 768	
				3	3	V: 768) 1024 x 768	
				5	5	V: 480) 848 x 480	
6	6	V: 480) 640 x 480					
INPUT RESOLUTION (AV)	RESOLUTION CHECK	RESO	R		- 480i, 480p, 1080i, 720p, 1080p, VGA, etc.	No	
SELF ADJUST	AADJ	WR	0-1	0-1	0: OFF, 1: ON	Yes	
POWER MANAGEMENT	PMNG	WR	0-1	0-1	0: OFF, 1: ON	Yes	
AUTO INPUT CHANGE	AINC	WR	0-1	0-1	0: OFF, 1: ON	Yes	

ENLARGE menu (When the input mode is PC)

Function	Command	Direction	Parameter	Reply	Control/Response contents	*	
ENLARGE MODE	EMAG	WR	0-4	0-4	0: OFF, 1: 2 x 2, 2: 3 x 3, 3: 4 x 4, 4: 5 x 5	No	
BEZEL WIDTH	WIDTH OF THE SHORTER SIDE	BEZH	WR	0-100	0-100		
	WIDTH OF THE LONGER SIDE	BEZV	WR	0-100	0-100		
IMAGE POSITION (2 x 2)	EPOS	WR	0-3	0-3	See page 21.		
IMAGE POSITION (3 x 3)	EPOS	WR	0-8	0-8			
IMAGE POSITION (4 x 4)	EPOS	WR	0-15	0-15			
IMAGE POSITION (5 x 5)	EPOS	WR	0-24	0-24			
ENLARGED SCREEN POSITIONING	THE LONGEST DIRECTION	EPSH	WR	-999-999	-999-999		The setting range depends on the ENLARGE MODE setting and the IMAGE POSITION.
	THE SHORTEST DIRECTION	EPSV	WR	-999-999	-999-999		
ENLARGE/IMAGE POSITION SETTING	ESTG	WR	XXYY	XXYY	XX: ENLARGE MODE (Same as EMAG), YY: IMAGE POSITION (Same as EPOS)		

PIP/PbyP menu

Function	Command	Direction	Parameter	Reply	Control/Response contents	*
PIP MODES	MWIN	WR	0-3	0-3	0: OFF, 1: PIP, 2: PbyP, 3: PbyP2	Yes
PIP SIZE	MPSZ	WR	1-12	1-12		Yes
PIP POS	THE LONGEST DIRECTION	MHPS	W	0-100		Yes
		R		0-100		Yes
	THE SHORTEST DIRECTION	MVPS	W	0-100		Yes
		R			0-100	
PIP V/H-POS	MPOS	W	0-100,0-100		Specify the position in MPOSxxxxyy format. (xxx: Longer side, yyy: Shorter side position)	Yes
		R		0-100,0-100	Returns a response in (xxx,yyy) format. (xxx: Longer side, yyy: Shorter side position)	Yes
PIP BLEND	MWBL	WR	0-15	0-15		Yes
PIP SOURCE	MWIP	WR	1	1	PC1 DIGITAL	Yes
			2	2	PC2 ANALOG	
			3	3	AV2 COMPONENT	
			4	4	AV3 VIDEO	
			6	6	PC3 ANALOG	
7	7	AV1 DIGITAL				
SOUND CHANGE	MWAD	WR	1-2	1-2	1: MAIN, 2: SUB	Yes
MAIN POS (Main screen)	MWPP	WR	0-1	0-1	0: POS1, 1: POS2	Yes
PbyP2 POS (Sub screen)	MW2P	WR	0-2	0-2	0: POS1, 1: POS2, 2: POS3	Yes
AUTO OFF	MOFF	WR	0-1	0-1	0: MANUAL, 1: AUTO	Yes

Initialization/Functional Restriction Setting (FUNCTION) menu

Funcio	Command	Direction	Parameter	Reply	Control/Response contents	*
ALL RESET	RSET	W	0			No
ADJUSTMENT LOCK	ALCK	WR	0-2	0-2	0: OFF	Yes
OSD DISPLAY	LOSD	WR	0-1	0-1	0: ON, 1: OFF	Yes
LED	OFLD	WR	0-1	0-1	0: ON, 1: OFF	Yes

Others

Function	Command	Direction	Parameter	Reply	Control/Response contents	*
SCREEN SIZE (PC)	WIDE	WR	1-5	1-5	1: WIDE, 2: NORMAL, 3: DotbyDot, 4: ZOOM1, 5: ZOOM2	Yes
SCREEN SIZE (AV)	WIDE	WR	1-5	1-5	1: WIDE, 2: ZOOM1, 3: ZOOM2, 4: NORMAL, 5: DotbyDot	Yes
VOLUME	VOLM	WR	0-31	0-31		Yes
MUTE	MUTE	WR	0-1	0-1	0: OFF, 1: ON	No
INFORMATION	MODEL	INF1		Value		Yes
	SERIAL NO	SRNO		Value		
BRIGHT	VLMP	WR	0-31	0-31	Brightness	Yes
TEMPERATURE SENSOR	DSTA	R		0	Internal temperature normal	Yes
				1	Internal temperature abnormal (Standby mode)	
				2	Internal temperature abnormal (Temperature is normal now, but it was abnormal during operation.)	
				3	Internal temperature abnormal (Brightness of the backlight decreases.)	
				4	Temperature sensor abnormal	
TEMPERATURE ACQUISITION	ERRT	R		Value	Temperature at temperature sensors 1 through 3 are returned in the following forms: [Sensor 1], [Sensor 2], [Sensor 3]	Yes
CAUSE OF LAST STANDBY MODE	STCA	W	0		Initialization	Yes
		R	0	No detectable error has occurred		
			1	Standby mode by POWER button		
			2	Main power "OFF" by the main power switch		
			3	Standby mode by RS-232C		
			4	Waiting mode by No Signal (Incl: VESA DPMS/DMPM)		
			6	Standby mode by abnormal temperature		
			8	Standby mode by SCHEDULE setting		

Troubleshooting

Before calling for repair services, make sure following checks for possible remedies to the encountered symptoms.

There is no picture or sound.

- Is the power cord disconnected? (See page 12.)
- Is the main power switch set to "OFF"? (See page 14.)
- Is the monitor in standby mode (the power LED illuminating in orange)? (See page 14.)
- Make sure correct input mode is selected. (See page 15.)
- If any external equipment is connected, make sure the equipment is operating (playing back).

Remote control does not work.

- Are the batteries inserted with polarity (+,-) aligned? (See page 13.)
- Are the batteries exhausted? (See page 13.)
- Point the remote control unit toward the monitor's remote control sensor. (See page 13.)
- Is the menu display hidden or is operation disabled? (See page 23.)

Sound from left and right speakers is reversed.

Sound is heard from only one side.

- Are audio cables connected properly? (See pages 10 and 11.)
- Make sure audio cables for external speakers are connected properly: left and right cables may be reversed or one of the two cables may not be connected. (See page 11.)
- Check the setting of BALANCE for AUDIO menu. (See page 18.)

There is a picture but no sound.

- Is the sound muted? (See page 15.)
- Make sure the volume is not set to minimum. (See page 15.)
- Is the PC audio cable (commercially available) connected? (See page 10.)
- Are audio cables connected properly? (See page 10.)
- Is the audio signal input properly to the audio input terminal corresponding to the selected video input terminal? (See page 15.)

Unstable video.

- The signal may be incompatible. (See pages 10 and 34.)
- Try the automatic screen adjustment when the PC2 input terminal or PC3 input terminals is used. (See page 22.)

PC1 or AV1 does not appear properly.

- Is the setting of DVI SELECT correct? (See page 19.)
- Is the input signal compatible with this monitor? (See pages 10 and 34.)
- Turn off the power to the connected equipment and then turn the power on again.
- If the monitors are connected in a daisy chain, turn off the power to all the monitors connected in a daisy chain and then turn the power on again.

PC3 or AV2 does not appear properly.

- Is the setting of BNC SELECT correct? (See page 19.)
- Is the input signal compatible with this monitor? (See page 34.)

Control buttons do not work.

There is no picture.

- Some kind of load noises from outside might interfere with normal operation. Turn off the power and turn it on after waiting at least 5 seconds, and then check the operation.

The input mode changes automatically.

- When the AUTO INPUT CHANGE is ON and no signal is present in a selected input mode, the AUTO INPUT CHANGE automatically changes the selected mode to a mode where a video signal is present. (See page 19.)
The input mode may change in the following cases:
 - When a computer is in standby mode.
 - When video play is stopped with a playback device.

Power LED flashes red.

"SERVICE CALL" appears in the corner of the screen.

- Hardware has a problem. Turn off the monitor and request repair from your SHARP dealer.

When "TEMPERATURE" is displayed.

- When the internal temperature of the monitor rises excessively, the brightness of the backlight decreases in order to prevent high-temperature-related problems. Remove the cause of the excessive rise in temperature. (See the description below.)

The monitor sometimes makes a cracking sound.

- You may hear cracking sound from the monitor. This happens when the cabinet slightly expands and contracts according to change in temperature. This does not affect the monitor's performance.

■ **Warning when temperature rises**

- When the internal temperature of the monitor rises excessively, the brightness of the backlight decreases automatically in order to prevent high-temperature-related problems. When this occurs, "TEMPERATURE" is displayed on the screen and the Power LED flashes red and green alternately.
- If the internal temperature rises further, the monitor automatically enters standby mode. (The Power LED continues flashing red and green alternately.)

Solution:

- If the monitor enters standby mode due to a rise in temperature, to return to normal display, turn the main power switch off and then back on again. The monitor, however, will enter standby mode again if the cause of the temperature rise is not eliminated. (See page 9.)
- Check whether the monitor is placed at a location where a quick rise in temperature is likely. Internal temperature rises quickly if the vents on the monitor are blocked.
- Internal temperature rises quickly if dust accumulates inside the monitor or around the vents. Remove dust if possible. Ask Sharp dealer about removing internal dust.

Specifications

■Product Specifications

Model	PN-525U		
LCD element	52" wide (132.2 cm diagonal) ASV low-reflection black TFT LCD		
Max. resolution (pixels)	1920 x 1080		
Max. colors	16.77 M colors (8 bits/color)		
Pixel pitch	0.600 mm (H) x 0.600 mm (V)		
Viewing angle	176° right/left/up/down (contrast ratio ≥ 10)		
Screen active area inch (mm)	45-3/8 x 25-1/2 (1152.0 x 648.0)		
Computer input signal	Digital (DVI 1.0 standard-compliant), Analog RGB (0.7Vp-p) [75 Ω]		
	Sync signal	Horizontal/vertical separate (TTL: positive/negative), Sync-on-green, Composite sync (TTL: positive/negative)	
Video color system	PAL, PAL-60, SECAM, NTSC (3.58 MHz), NTSC (4.43 MHz)		
Plug and play	VESA DDC2B		
Power management	VESA DPMS, DVI DMPM		
Input terminals	PC/AV	Digital	DVI-D 24 pin (HDCP compatible) x 1
	PC	Analog	Mini D-sub 15 pin, 3 rows x 1, BNC ^{**2} x 1
		Audio	3.5 mm mini stereo jack x 1
	AV	Composite video	BNC x 1
		Component	BNC (Y, Cb/Pb, Cr/Pr) ^{*1} x 1
		Audio	RCA pin (L/R) x 1
	Serial (RS-232C)		D-sub 9 pin x 1
Output terminals	PC/AV	Digital	DVI-D 24 pin x 1 ^{*3}
	Audio		RCA pin (L/R) x 1
	Serial (RS-232C)		D-sub 9 pin x 1
	Speaker		7 W + 7 W [6 Ω]
	Power requirement	AC 120 V, 60 Hz	
Operating temperature	32°F to 104°F (0°C to 40°C)		
Operating humidity	20% to 80% (no condensation)		
Power consumption	325 W (Input signal waiting mode: 11.5 W ^{*4} , Standby mode: 3.5 W)		
Dimensions inch (mm)	Approx. 49-3/8 x 5-7/8 x 29-3/16 (1,254 x 149 x 742) (excluding protrusions)		
Weight lbs. (kg)	Approx. 97.0 (44) (excluding the temporary stand)		

*1 Cannot be used simultaneously.

*2 Does not support plug and play.

*3 Connection is allowed with an HDCP-compatible device only. Does not support Repeater control function.

*4 When AUTO INPUT CHANGE is ON. 7.5 W when it is OFF.

As a part of our policy of continuous improvement, SHARP reserves the right to make design and specification changes for product improvement without prior notice. The performance specification figures indicated are nominal values of production units. There may be some deviations from these values in individual units.

Specifications

■ Dimensional Drawings

Note that the values shown are approximate values.

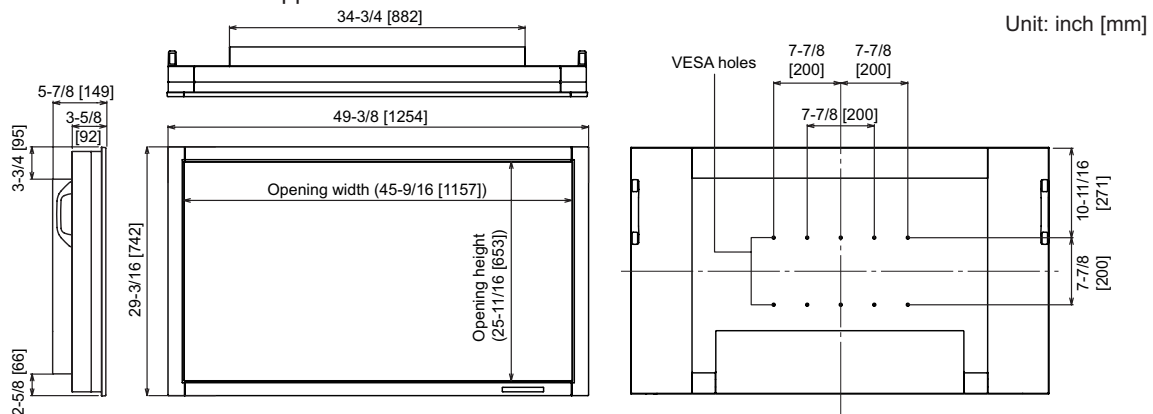

When mounting the monitor, be sure to use a wall-mount / ceiling-mount bracket they comply with the VESA-compatible mounting method. SHARP recommends using M6 screws and tighten the screws.

Note that screw hole depth of the monitor is 3/8 inch (10 mm). Loose holding may cause the product to fall, resulting in serious personal injuries as well as damage to the product. The screw and hole should come together with over 5/16 inch (8 mm) length of thread. Use the bracket which applied UL1678 standard, and which can endure at least 3 times or more the weight of the monitor.

■ Compatible signal timing (PC)

Screen resolution		Hsync	Vsync	Dot frequency	Analog signal	Digital signal	
VESA	640 x 480	31.5 kHz	60 Hz	25.175 MHz	Yes	Yes	
		37.9 kHz	72 Hz	31.5 MHz	Yes	Yes	
		37.5 kHz	75 Hz	31.5 MHz	Yes	Yes	
	800 x 600	35.1 kHz	56 Hz	36.0 MHz	Yes	–	
		37.9 kHz	60 Hz	40.0 MHz	Yes	Yes	
		48.1 kHz	72 Hz	50.0 MHz	Yes	Yes	
	848 x 480	46.9 kHz	75 Hz	49.5 MHz	Yes	Yes	
		31.0 kHz	60 Hz	33.75 MHz	Yes	Yes	
		1024 x 768	48.4 kHz	60 Hz	65.0 MHz	Yes	Yes
	56.5 kHz		70 Hz	75.0 MHz	Yes	Yes	
	60.0 kHz		75 Hz	78.75 MHz	Yes	Yes	
	1152 x 864	67.5 kHz	75 Hz	108.0 MHz	Yes	Yes	
		1280 x 768	47.8 kHz	60 Hz	79.5 MHz	Yes	Yes
			60.3 kHz	75 Hz	102.25 MHz	Yes	Yes
	1280 x 960		60.0 kHz	60 Hz	108.0 MHz	Yes	Yes
1280 x 1024	64.0 kHz	60 Hz	108.0 MHz	Yes	Yes		
	80.0 kHz	75 Hz	135.0 MHz	Yes	Yes		
	1360 x 768	47.7 kHz	60 Hz	85.5 MHz	Yes	Yes	
1600 x 1200*1	75.0 kHz	60 Hz	162.0 MHz	Yes	Yes		
	Wide	1280 x 720	44.7 kHz	60 Hz	74.4 MHz	Yes	Yes
1920 x 1080		66.3 kHz	60 Hz	148.5 MHz	Yes	Yes	
US TEXT	720 x 400	31.5 kHz	70 Hz	28.3 MHz	Yes	Yes	
Sun	1024 x 768	48.3 kHz	60 Hz	64.13 MHz	Yes	–	
		53.6 kHz	66 Hz	70.4 MHz	Yes	–	
		56.6 kHz	70 Hz	74.25 MHz	Yes	–	
	1152 x 900	61.8 kHz	66 Hz	94.88 MHz	Yes	–	
		71.8 kHz	76.2 Hz	108.23 MHz	Yes	–	
	1280 x 1024	71.7 kHz	67.2 Hz	117.01 MHz	Yes	–	
81.1 kHz		76 Hz	134.99 MHz	Yes	–		
1600 x 1000	68.6 kHz	66 Hz	135.76 MHz	Yes	–		

*1 Displays a reduced image.

- * All are compliant only with non-interlaced.
- * Depending on the connected PC, images may not be displayed properly even if the compatible signal described above is input.
- * The frequency values for the Sun are reference values. A separate conversion adapter (commercially available) may be required for connecting the monitor to the Sun.

Power management

This monitor conforms to VESA DPMS and DVI DMPM. Both your video card and computer must support the same standard in order for the monitor's power management function to work.

DPMS: Display Power Management Signaling

DPMS	Screen	Power consumption	Hsync	Vsync
ON STATE	Display	325 W	Yes	Yes
STANDBY	No display	11.5 W*	No	Yes
SUSPEND			Yes	No
OFF STATE			No	No

DMPM: Digital Monitor Power Management

DMPM	Screen	Power consumption
Monitor ON	Display	325 W
Active OFF	No display	11.5 W*

* When AUTO INPUT CHANGE is ON. 7.5 W when it is OFF.

DDC (plug and play)

The monitor supports the VESA DDC (Display Data Channel) standard.

DDC is a signal standard for plug and play between monitors and computers. Information about resolution and other parameters is exchanged between the two. This function can be used if the computer supports DDC and it has been configured to detect plug-and-play monitors.

There are several types of DDC, depending on the communication method used. This monitor supports DDC2B.

PC1/AV1 input terminal pins

(DVI-D24 pin)

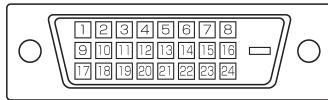

No.	Function	No.	Function
1	TMDS data 2-	13	N.C.
2	TMDS data 2+	14	+5 V
3	TMDS data 2/4 shield	15	GND
4	N.C.	16	Hot-plug detection
5	N.C.	17	TMDS data 0-
6	DDC clock	18	TMDS data 0+
7	DDC data	19	TMDS data 0/5 shield
8	N.C.	20	N.C.
9	TMDS data 1-	21	N.C.
10	TMDS data 1+	22	TMDS clock shield
11	TMDS data 1/3 shield	23	TMDS clock+
12	N.C.	24	TMDS clock-

PC2 input terminal pins

(Mini D-sub 15 pin)

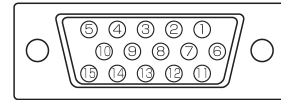

No.	Function	No.	Function
1	Red video signal input	9	+5 V
2	Green video signal input	10	GND
3	Blue video signal input	11	N.C.
4	N.C.	12	DDC data
5	GND	13	Hsync signal input
6	GND for red video signal	14	Vsync signal input
7	GND for green video signal	15	DDC clock
8	GND for blue video signal		

PC/AV output terminal pins

(DVI-D24 pin)

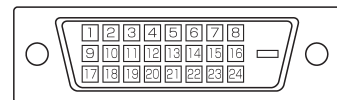

No.	Function	No.	Function
1	TMDS data 2-	13	N.C.
2	TMDS data 2+	14	+5 V
3	TMDS data 2/4 shield	15	GND
4	N.C.	16	Hot-plug detection
5	N.C.	17	TMDS data 0-
6	DDC clock	18	TMDS data 0+
7	DDC data	19	TMDS data 0/5 shield
8	N.C.	20	N.C.
9	TMDS data 1-	21	N.C.
10	TMDS data 1+	22	TMDS clock shield
11	TMDS data 1/3 shield	23	TMDS clock+
12	N.C.	24	TMDS clock-

RS-232C input terminal pins

(D-sub 9 pin)

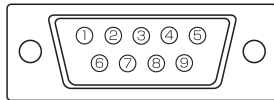

No.	Function	No.	Function
1	N.C.	6	N.C.
2	Transmitted data	7	N.C.
3	Received data	8	N.C.
4	N.C.	9	N.C.
5	GND		

RS-232C output terminal pins

(D-sub 9 pin)

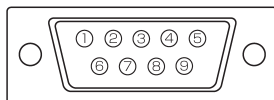

No.	Function	No.	Function
1	N.C.	6	N.C.
2	Received data	7	N.C.
3	Transmitted data	8	N.C.
4	N.C.	9	N.C.
5	GND		

MEMO

Free Manuals Download Website

<http://myh66.com>

<http://usermanuals.us>

<http://www.somanuals.com>

<http://www.4manuals.cc>

<http://www.manual-lib.com>

<http://www.404manual.com>

<http://www.luxmanual.com>

<http://aubethermostatmanual.com>

Golf course search by state

<http://golfingnear.com>

Email search by domain

<http://emailbydomain.com>

Auto manuals search

<http://auto.somanuals.com>

TV manuals search

<http://tv.somanuals.com>