

SHARP®

MODEL: MX-2300G MX-3500N
MX-2300N MX-3501N
MX-2700G MX-4500N
MX-2700N MX-4501N

Copier Guide



TABLE OF CONTENTS

ABOUT THIS MANUAL	3
• MANUALS PROVIDED WITH THE MACHINE . . .	3

1 BASIC PROCEDURE FOR MAKING COPIES

BASE SCREEN OF COPY MODE	5
COPYING SEQUENCE	8
MAKING COPIES	11
• USING THE AUTOMATIC DOCUMENT FEEDER TO MAKE COPIES	11
• MAKING A COPY USING THE DOCUMENT GLASS	12
AUTOMATIC 2-SIDED COPYING	15
• USING THE AUTOMATIC DOCUMENT FEEDER TO MAKE 2-SIDED COPIES	15
• AUTOMATIC 2-SIDED COPYING USING THE DOCUMENT GLASS	18
COPY COLOUR MODES	21
• SELECTING THE COLOUR MODE	21
CHANGING THE EXPOSURE AND EXPOSURE MODE	23
• AUTOMATIC ADJUSTMENT OF THE EXPOSURE AND EXPOSURE MODE	23
• SELECTING THE EXPOSURE MODE AND MANUALLY ADJUSTING THE EXPOSURE LEVEL	23
REDUCTION/ENLARGEMENT/ZOOM	26
• AUTOMATIC RATIO SELECTION (Auto Image)	26
• MANUALLY SELECTING THE RATIO (Preset ratios/Zoom)	27
• ENLARGING/REDUCING THE LENGTH AND WIDTH SEPARATELY (XY Zoom)	30
ORIGINAL SIZES	33
• CHECKING THE ORIGINAL SIZE	33
• SPECIFYING THE ORIGINAL SIZE	35
• STORING FREQUENTLY USED ORIGINAL SIZES	36
OUTPUT	42
• OUTPUT MODES	43
MAKING COPIES USING THE BYPASS TRAY (Copying on special papers)	46
INTERRUPTING A COPY RUN (Interrupt copy) . . .	48

JOB STATUS SCREEN	49
• JOB QUEUE SCREEN AND COMPLETED JOB SCREEN	49
• WHEN THE DOCUMENT FILING FUNCTION IS USED	53

2 CONVENIENT COPY FUNCTIONS

SPECIAL MODES	54
• [Image Edit] KEY AND [Colour Adjustments] KEY . .	57
ADDING MARGINS (Margin Shift)	59
ERASING PERIPHERAL SHADOWS (Erase)	61
COPYING EACH FACING PAGE OF A BOUND DOCUMENT (Dual Page Copy)	63
MAKING COPIES IN PAMPHLET FORMAT (Pamphlet Copy)	65
COPYING A LARGE NUMBER OF ORIGINALS AT ONCE (Job Build)	69
USING TWO MACHINES TO COPY A LARGE NUMBER OF ORIGINALS (Tandem Copy)	71
USING A DIFFERENT PAPER TYPE FOR COVERS (Covers/Inserts)	74
• INSERTING COVERS IN COPIES (Cover Settings)	75
• INSERTING INSERT SHEETS IN COPIES (Insert Settings)	78
• CHANGING COVER/INSERT SETTINGS (Page Layout)	81
ADDING INSERTS WHEN COPYING ON TRANSPARENCY FILM (Transparency Inserts) . . .	85
COPYING MULTIPLE PAGES ONTO ONE SHEET OF PAPER (Multi Shot)	88
COPYING A PAMPHLET (Book Copy)	91
COPYING CAPTIONS ONTO TAB PAPER (Tab Copy)	95
• RELATION BETWEEN THE ORIGINALS AND THE TAB PAPER	95
COPYING BOTH SIDES OF A CARD ON ONE SHEET OF PAPER (Card Shot)	99
PRINTING THE DATE AND A STAMP ON COPIES (Stamp)	102
• ADDING THE DATE TO COPIES (Date)	103
• STAMPING COPIES (Stamp)	107
• PRINTING PAGE NUMBERS ON COPIES (Page Numbering)	110
• PRINTING TEXT ON COPIES (Text)	116

CHECKING THE STAMP LAYOUT (Layout)	122
REPEATING PHOTOS ON A COPY (Photo Repeat)	124
CREATING A LARGE POSTER (Multi-Page Enlargement)	127
REVERSING THE IMAGE (Mirror Image)	130
COPYING A3 (11" x 17") SIZE ORIGINAL WITHOUT CUTTING OFF THE EDGES (A3 (11x17) Full Bleed)	132
COPYING IN THE CENTRE OF THE PAPER (Centring)	135
REVERSING BLACK AND WHITE IN A COPY (B/W Reverse)	137
ADJUSTING RED/GREEN/BLUE IN COPIES (RGB Adjust)	139
ADJUSTING THE SHARPNESS OF AN IMAGE (Sharpness)	141
WHITENING FAINT COLOURS IN COPIES (Suppress Background)	143
ADJUSTING THE COLOUR (Colour Balance)	145
ADJUSTING THE BRIGHTNESS OF A COPY (Brightness)	147
ADJUSTING THE INTENSITY OF A COPY (Intensity)	149
CHECKING COPIES BEFORE PRINTING (Proof Copy)	151
COPYING ORIGINALS OF DIFFERENT SIZES (Mixed Size Original)	154
COPYING THIN ORIGINALS (Slow Scan Mode)	157
STORING COPY OPERATIONS (Job Programs)	159
• STORING A JOB PROGRAM	160
• DELETING A JOB PROGRAM	161
APPENDIX	163

ABOUT THIS MANUAL

Please note

- Where this manual shows the "MX-2300/2700 series" or the "MX-3500/4500 series", the following models are indicated:
MX-2300/2700 series: MX-2300G, MX-2300N, MX-2700G, MX-2700N
MX-3500/4500 series: MX-3500N, MX-3501N, MX-4500N, MX-4501N
- This manual contains references to the fax function. However, please note that the fax function is not available in some countries and regions.
- Considerable care has been taken in preparing this manual. If you have any comments or concerns about the manual, please contact your dealer or nearest authorised service representative.
- This product has undergone strict quality control and inspection procedures. In the unlikely event that a defect or other problem is discovered, please contact your dealer or nearest authorised service representative.
- Aside from instances provided for by law, SHARP is not responsible for failures occurring during the use of the product or its options, or failures due to incorrect operation of the product and its options, or other failures, or for any damage that occurs due to use of the product.

Warning

- Reproduction, adaptation or translation of the contents of the manual without prior written permission is prohibited, except as allowed under copyright laws.
- All information in this manual is subject to change without notice.

Illustrations and the operation panel and touch panel shown in this manual

The peripheral devices are generally optional, however, some models include certain peripheral devices as standard equipment. The explanations in this manual assume that a right tray and stand/2 x 500 sheet paper drawer are installed on the MX-2700N (equipped standard with an automatic document feeder).

To further explain certain functions and uses, some explanations assume that additional peripheral devices are installed.

The display screens, messages, and key names shown in the manual may differ from those on the actual machine due to product improvements and modifications.

MANUALS PROVIDED WITH THE MACHINE

Printed manuals and manuals stored in PDF format on the machine's hard drive are provided with the machine. When using the machine, read the appropriate manual for the feature you are using.

Printed manuals

Manual name	Contents
Safety Guide	This manual contains instructions for using the machine safely and lists the specifications of the machine and its peripheral devices.
Software Setup Guide	This manual explains how to install the software and configure settings to use the machine as a printer or scanner.
Quick Start Guide	This manual provides easy-to-understand explanations of all the functions of the machine in a single volume. Detailed explanations of each of the functions can be found in the manuals in PDF format.
Troubleshooting	This manual explains how to remove paper misfeeds and provides answers to frequently asked questions regarding the operation of the machine in each mode. Refer to this manual when you have difficulty using the machine.
Facsimile Quick Reference Guide	This manual explains the basic procedures for using the fax function of the machine, and provides an overview of the features of the fax function, troubleshooting procedures, and specifications. For detailed information on using the fax function and the system settings for fax, see the "Facsimile Guide" in PDF format.





Operation manuals in PDF format

The manuals in PDF format provide detailed explanations of the procedures for using the machine in each mode. To view the PDF manuals, download them from the hard drive in the machine. The procedure for downloading the manuals is explained in "How to download the manuals in PDF format" in the Quick Start Guide.

Manual name	Contents
User's Guide	This manual provides information, such as basic operation procedures, how to load paper, and machine maintenance.
Copier Guide (This manual)	This manual provides detailed explanations of the procedures for using the copy function.
Printer Guide	This manual provides detailed explanations of the procedures for using the printer function.
Facsimile Guide	This manual provides detailed explanations of the procedures for using the fax function and the "System Settings" that are related to fax.
Scanner Guide	This manual provides detailed explanations of the procedures for using the scanner function and the Internet fax function.
Document Filing Guide	This manual provides detailed explanations of the procedures for using the document filing function. The document filing function allows you to save the document data of a copy or fax job, or the data of a print job, as a file on the machine's hard drive. The file can be called up as needed.
System Settings Guide	This manual explains the "System Settings", which are used to configure a variety of parameters to suit the aims and the needs of your workplace. Current settings can be displayed or printed out from the "System Settings".

Icons used in the manuals

The icons in the manuals indicate the following types of information:

	This alerts you to a situation where there is a risk of machine damage or failure.		This indicates the name of a system setting and a provides a brief explanation of the setting. For detailed information on each system setting, see the System Settings Guide. When "System Settings:" appears: A general setting is explained. When "System Settings (Administrator):" appears: A setting that can only be configured by an administrator is explained.
	This provides a supplemental explanation of a function or procedure.		
	This explains how to cancel or correct an operation.		

1

BASIC PROCEDURE FOR MAKING COPIES

This chapter explains the basic procedures for making copies, including selection of the copy ratio and other copy settings.

BASE SCREEN OF COPY MODE

When the [COPY] key is pressed on the operation panel, the base screen of copy mode appears. The base screen shows messages and keys necessary for copying, and settings that have been selected. Selections are made by touching the displayed keys.

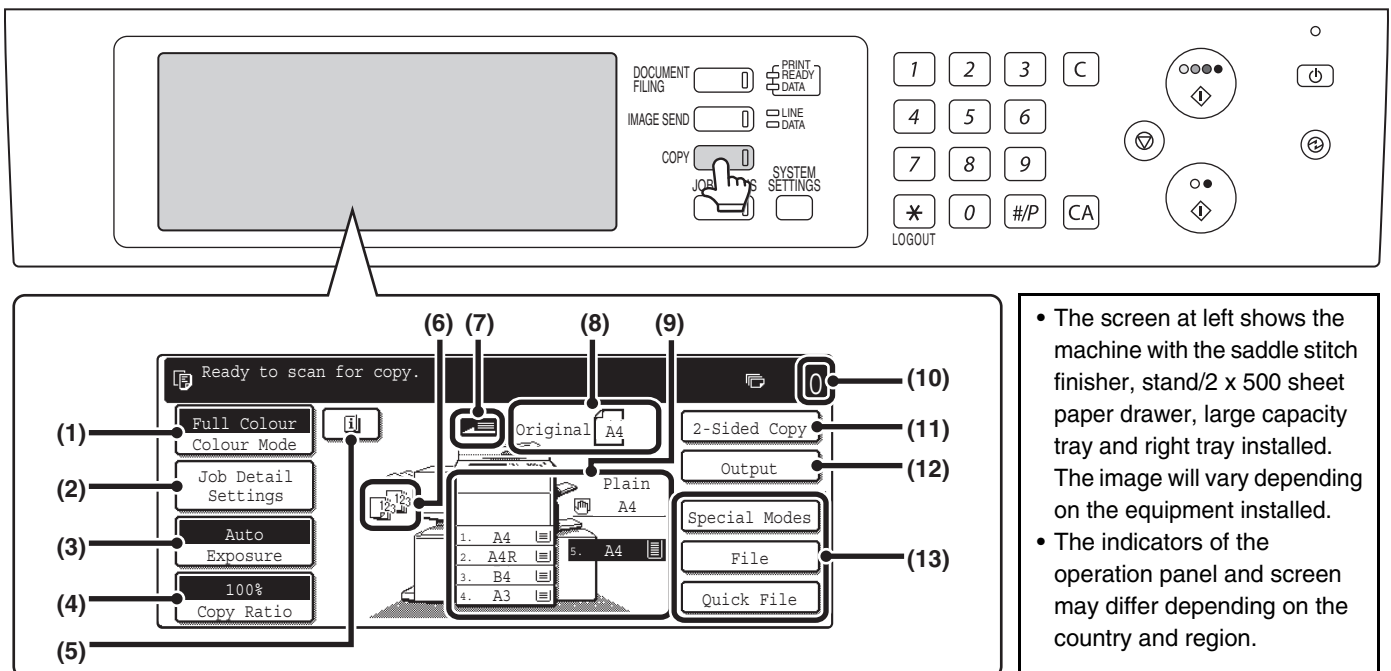

(1) [Colour Mode] key

Touch this to change the colour mode.
➤ [COPY COLOUR MODES](#) (page 21)

(2) [Job Detail Settings] key

Touch this key to select original settings, paper settings, and special modes.
➤ [\[Job Detail Settings\] key](#) (page 6)

(3) [Exposure] key

This shows the current copy exposure and exposure mode settings. Touch this key to change the exposure or exposure mode setting.
➤ [CHANGING THE EXPOSURE AND EXPOSURE MODE](#) (page 23)

(4) [Copy Ratio] key

This shows the current copy ratio. Touch this key to adjust the copy ratio.
➤ [REDUCTION/ENLARGEMENT/ZOOM](#) (page 26)

(5) [Special Modes] key

This key appears when a special mode is selected. Touch this key to display a list of the selected modes and settings.
➤ [Checking which special modes are selected](#) (page 58)

(6) Output display

When one or more output functions such as sort, group, staple sort, or saddle stitch have been selected, this shows the icons of the selected functions.
➤ [OUTPUT](#) (page 42)

(7) Original feed display

This appears when an original has been inserted in the document feeder tray.

(8) Original size display

This shows the size of the original. When the original size is set manually, the display shows "Manual". When an original is not placed, nothing appears.
➤ [ORIGINAL SIZES](#) (page 33)

(9) Paper select display

This shows the size of paper loaded in each tray. In the bypass tray area, the paper type appears above the paper size.

The selected tray is highlighted.

The approximate amount of paper in each tray is indicated by [≡]. To display the paper tray selection screen for a tray, touch the tray.

(10) Number of copies display

This shows the number of copies set.

(11) [2-Sided Copy] key

Touch this to make 2-sided copies.

☞ AUTOMATIC 2-SIDED COPYING (page 15)

(12) [Output] key

Touch this to select an output function such as sort, group, offset, staple sort, saddle stitch, or punch.

☞ OUTPUT (page 42)

(13) Customized keys

These 3 keys can be changed to show any 3 settings or functions that you like. The keys are changed in "Customize Key Setting" in the system settings (administrator). Normally the following keys appear:

☞ Customizing displayed keys (page 7)

• **[Special Modes] key**

This is the same [Special Modes] key that appears when the [Job Detail Settings] key is touched.

☞ SPECIAL MODES (page 54)

• **[File] key, [Quick File] key**

Touch either key to use the Quick File or File of the document filing functions. These are the same [File] and [Quick File] keys that appear when the [Special Modes] key is touched. For information on the document filing function, see the Document Filing Guide.

 When the system settings screen is displayed, the base screen of copy mode will not appear even if the [COPY] key is pressed.

[Job Detail Settings] key

When the [Job Detail Settings] key is touched, keys for selecting the original size and paper settings appear. The [Special Modes] key also appears to allow the selection of special modes. To close the job detail settings screen and return to the base screen, touch the [Job Detail Settings] key once again.

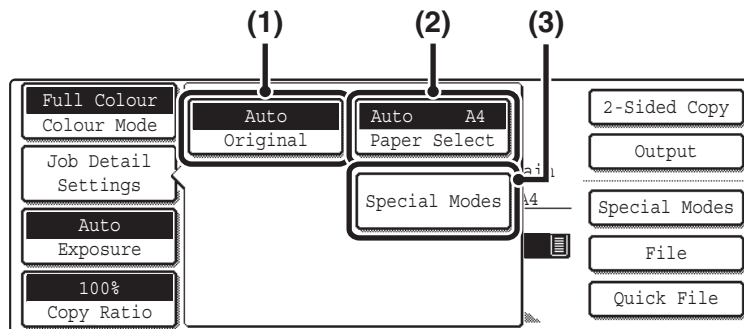

(1) [Original] key

Touch this key to select the original size setting.

☞ ORIGINAL SIZES (page 33)

(2) [Paper Select] key

Touch this key to change the paper (tray) that is used. When the key is touched, each tray and the size and type of paper in that tray will appear. Touch the key of the paper tray that you wish to use and then touch the [OK] key.

The paper size and paper type settings for trays 1 to 5 are configured in the system settings.

☞ System Settings Guide "Paper Tray Settings"

For information on the paper size and paper type settings for the bypass tray, see the "MAKING COPIES USING THE BYPASS TRAY (Copying on special papers)" (page 46).

(3) [Special Modes] key

Touch this key to select special modes such as Margin Shift, Edge Erase, and Dual Page Copy.

☞ SPECIAL MODES (page 54)

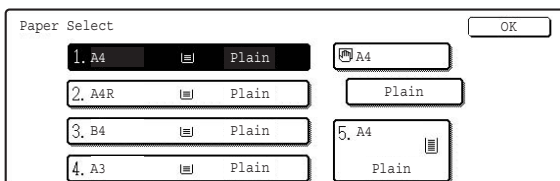

Customizing displayed keys

Keys of convenient functions (such as special modes) can be displayed in the lower right corner of the screen. Set these keys to functions that you frequently use to access the functions with a single touch. The functions that are shown in the keys are selected with "Customize Key Setting" in the system settings (administrator).

The screen when the customized keys are set to [Special Modes], [Margin Shift], and [Brightness]

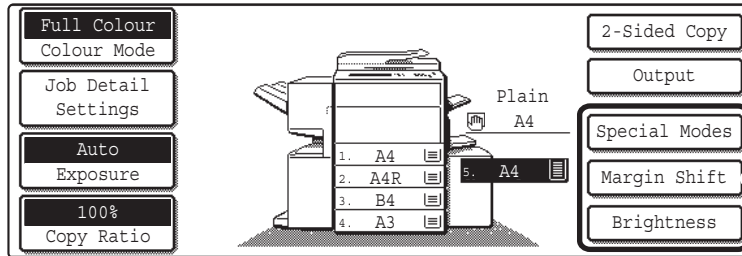

These 3 keys can be changed as desired.



System Settings (Administrator): Customize Key Setting

This is used to select the customized keys that appear in the base screen.

For the procedure for configuring "Customize Key Setting", see the System Settings Guide.

COPYING SEQUENCE

Select settings in the order shown below to ensure that the copy operation takes place smoothly. For detailed procedures for selecting the settings, see the explanation of each setting in this guide.

Place the original.

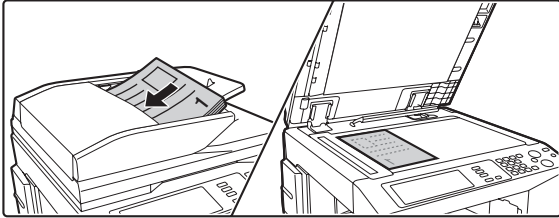

Place the original in the document feeder tray of the automatic document feeder, or on the document glass.



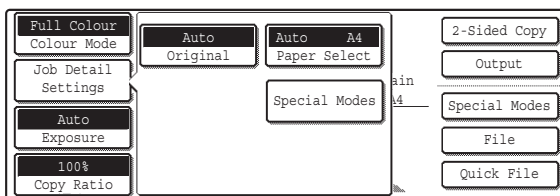

* Depending on the copy functions used, there are also cases where functions are selected before the original is placed.

Basic copy settings



Select the basic copy settings.

The main settings are as follows:

- Colour mode  [COPY COLOUR MODES](#) (page 21)
- Exposure and exposure mode  [CHANGING THE EXPOSURE AND EXPOSURE MODE](#) (page 23)
- Copy ratio  [REDUCTION/ENLARGEMENT/ZOOM](#) (page 26)
- Original size  [ORIGINAL SIZES](#) (page 33)
- Paper settings

2-sided copy settings

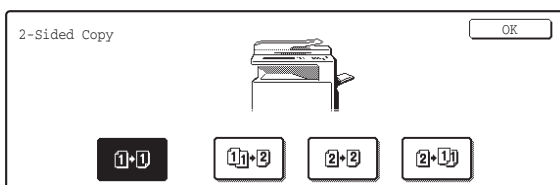

Select settings as needed for 2-sided copying and 2-sided scanning of the original.

-  [AUTOMATIC 2-SIDED COPYING](#) (page 15)

Output settings

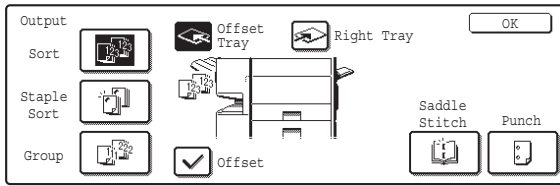

Select copy output settings.

The main settings are as follows:

- Sort mode [Sort mode](#) (page 43)
- Group mode [Group mode](#) (page 43)
- Offset mode [Offset function](#) (page 43)
- Staple sort mode
 - [Staple sort function / Saddle stitch function](#) (page 44)
- Punch function [Punch function](#) (page 45)
- Pamphlet staple function
 - [Staple sort function / Saddle stitch function](#) (page 44)



Special mode settings

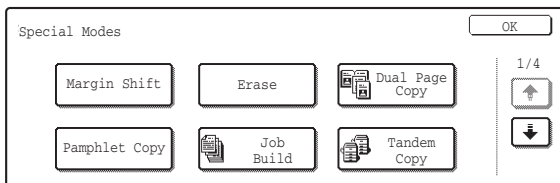

Select special modes such as "Margin Shift" and "Erase".

- [SPECIAL MODES](#) (page 54)



Number of copies (sets) setting

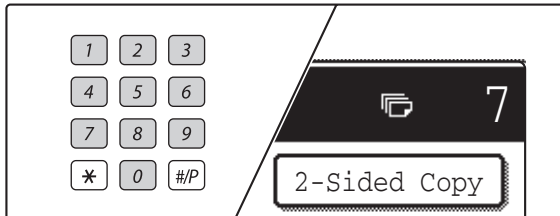

Set the number of copies (number of sets).



Document filing settings

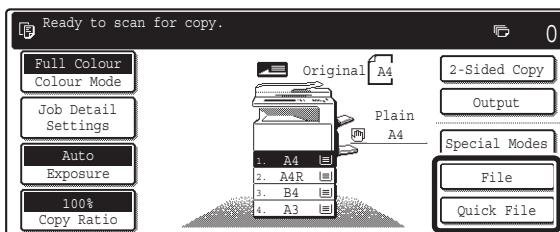

Select document filing settings.

For more information on the document filing function, see the Document Filing Guide.



Start copying.

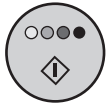



Start colour copying.



Start black and white copying.

Start scanning the original(s) and making copies.





When one or more special modes are selected, the  key appears in the base screen. Touch the  key to display a list of the selected special modes. This lets you check what special modes are selected and the settings of each mode.



To cancel all settings, press the [CLEAR ALL] key ().

When the [CLEAR ALL] key () is pressed, all settings selected to that point are cleared and you will return to the base screen.

To stop scanning of the original and copying, press the [STOP] key ().

When the [STOP] key () is pressed, a message will appear asking you if you want to cancel the job. Touch the [Yes] key in the message screen.

MAKING COPIES

USING THE AUTOMATIC DOCUMENT FEEDER TO MAKE COPIES

This section explains how to make copies (1-sided copies of 1-sided originals) using the automatic document feeder.

1

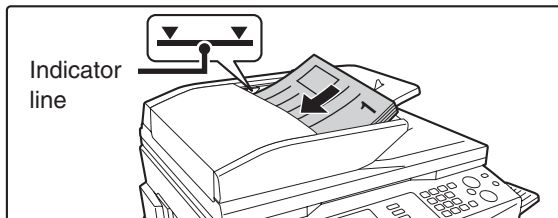

Place the originals face up in the document feeder tray with the edges aligned evenly.

Place the originals face up. Insert the originals all the way into the document feeder tray. The stack must not be higher than the indicator line.

2



- Depending on the size of the placed original, there may be cases where the same size of paper as the original is not selected automatically. In this event, change the paper size manually.
- To change the paper size selection, touch the [Job Detail Settings] key and then the [Paper Select] key, or touch the paper size display (A).

The following screen appears when the [Paper Select] key or the paper size display (A) is touched. Touch the tray key that has the desired paper size and then touch the [OK] key.

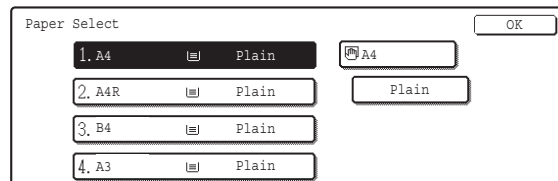

Make sure that the automatically selected paper size is the same size as the original.

The selected tray is highlighted. You can also copy onto paper that is a different size than the original.

3

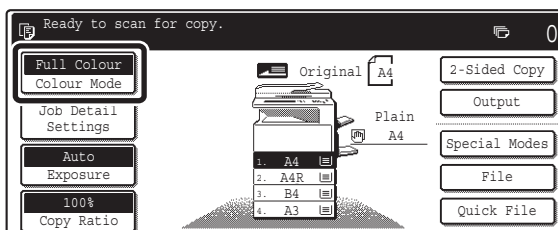

Check the colour mode.

The currently selected colour mode appears.

To change the colour mode, touch the [Colour Mode] key, touch the [Full Colour] key, [Auto] key, [Single Colour] key or [2 Colour] key, and touch the [OK] key.

➡ [COPY COLOUR MODES](#) (page 21)

Full Colour: The original is copied in full colour.

Auto: Colour or black and white is automatically selected when the original is scanned.

Single Colour: The original is copied in the selected colour only.

2 Colour: Only the red areas of the original are changed to the selected colour; colours other than red are scanned in black.

4

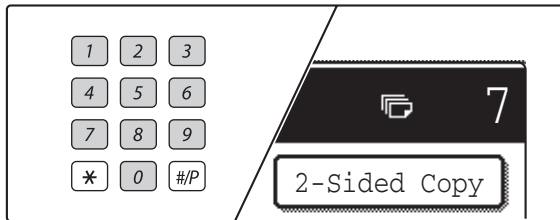

Set the number of copies (sets) with the numeric keys.



- Up to 999 can be set.
- A single copy can be made even if "0" appears for the number of copies.



If an incorrect number of copies is set...
Press the [CLEAR] key (C) and then enter the correct number.

5

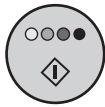

or

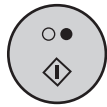

Press the [COLOUR START] key (●●●●) or the [BLACK & WHITE START] key (●●).



Even if a colour mode is selected, copying will take place in black and white if the [BLACK & WHITE START] key (●●) is pressed.



To cancel scanning of the original and copying...
Press the [STOP] key (⊞).

MAKING A COPY USING THE DOCUMENT GLASS

To make a copy of a book or other thick original that cannot be fed through the automatic document feeder, open the automatic document feeder and place the original on the document glass. This section explains how to make a copy (1-sided copy of a 1-sided original) using the document glass.

1

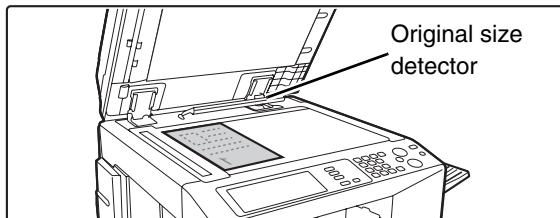

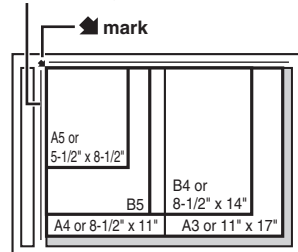

Open the automatic document feeder, place the original face down on the document glass, and then gently close the automatic document feeder.

Document glass scale

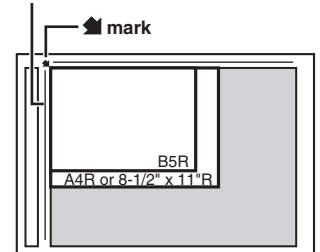

Document glass scale



- Align the corner of the original with the tip of the arrow mark  on the document glass scale.
- Place the original in the appropriate position for its size as shown above.



Do not place any objects under the original size detector. Closing the automatic document feeder with an object underneath may damage the original size detector plate and prevent correct detection of the document size.

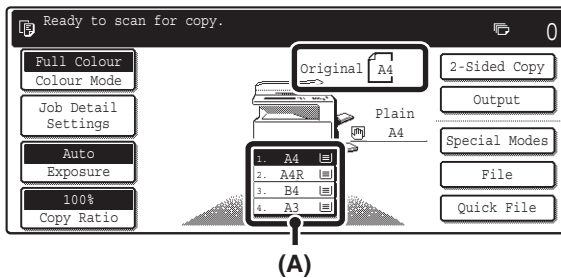

Make sure that the automatically selected paper size is the same size as the original.

The selected tray is highlighted. You can also copy onto paper that is a different size than the original.

2



- Depending on the size of the placed original, there may be cases where the same size of paper as the original is not selected automatically. In this event, change the paper size manually.
- To change the paper size selection, touch the [Job Detail Settings] key and then the [Paper Select] key, or touch the paper size display (A).

The following screen appears when the [Paper Select] key or the paper size display (A) is touched. Touch the tray key that has the desired paper size and then touch the [OK] key.

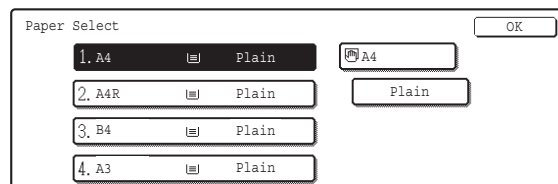

3

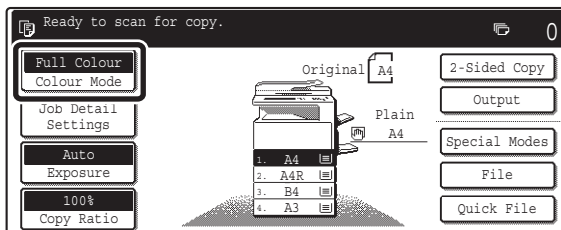

Check the colour mode.

The currently selected colour mode appears.

To change the colour mode, touch the [Colour Mode] key, touch the [Full Colour] key, [Auto] key, [Single Colour] key or [2 Colour] key, and touch the [OK] key.

➔ [COPY COLOUR MODES](#) (page 21)

Full Colour: The original is copied in full colour.

Auto: Colour or black and white is automatically selected when the original is scanned.

Single Colour: The original is copied in the selected colour only.

2 Colour: Only the red areas of the original are changed to the selected colour; colours other than red are scanned in black.

4

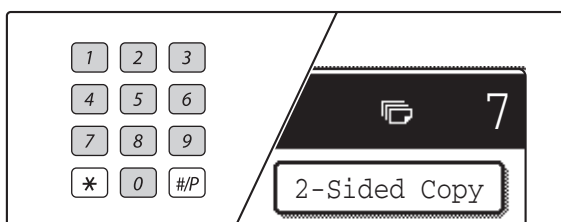

Set the number of copies (sets) with the numeric keys.



- Up to 999 can be set.
- A single copy can be made even if "0" appears for the number of copies.



If an incorrect number of copies is set...

Press the [CLEAR] key (C) and then enter the correct number.

5

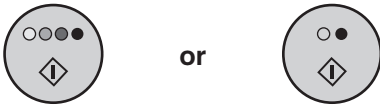

Press the [COLOUR START] key (○●●●) or the [BLACK & WHITE START] key (○●).

Scanning begins.

If group copy is selected, copying begins.

If you are using the sort function or other function that requires all originals to be scanned before the copies are printed, you must use the same [START] key that you used to scan the first original to scan each of the remaining originals.



Even if a colour mode is selected, copying will take place in black and white if the [BLACK & WHITE START] key (○●) is pressed.

6

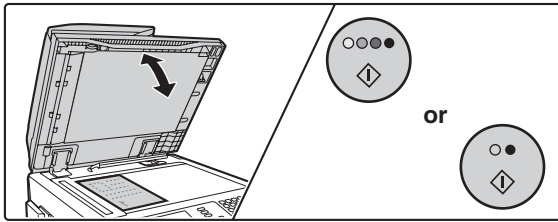

Remove the original and place the next original, and then press the [COLOUR START] key (○●●●) or the [BLACK & WHITE START] key (○●).

If you are using the sort function or other function that requires all originals to be scanned before the copies are printed, you must use the same [START] key that you used to scan the first original to scan each of the remaining originals.

Repeat this step until all originals have been scanned.

7

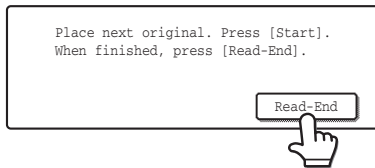

Touch the [Read-End] key.



To cancel scanning of the original and copying...

Press the [STOP] key (⊘).

AUTOMATIC 2-SIDED COPYING

USING THE AUTOMATIC DOCUMENT FEEDER TO MAKE 2-SIDED COPIES

The following 2-sided copying can be performed automatically. The originals and paper are turned over automatically, allowing easy 2-sided copying.

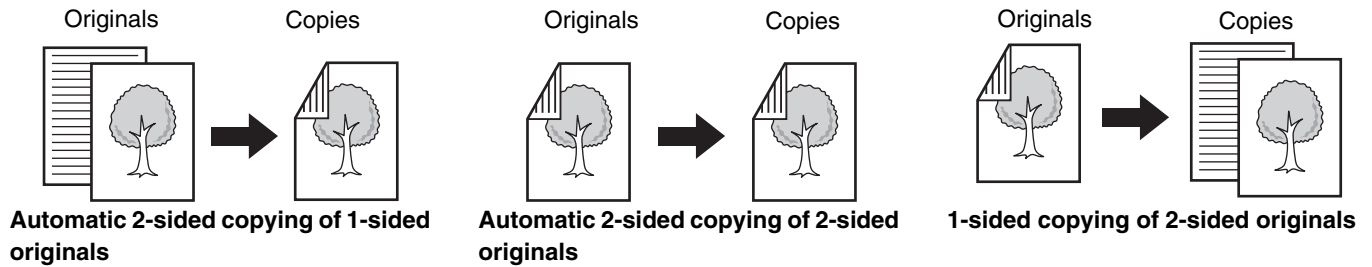

1

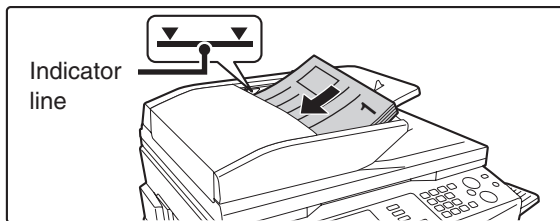

Place the originals face up in the document feeder tray with the edges aligned evenly.

Place the originals face up. Insert the originals all the way into the document feeder tray. The stack must not be higher than the indicator line.

2

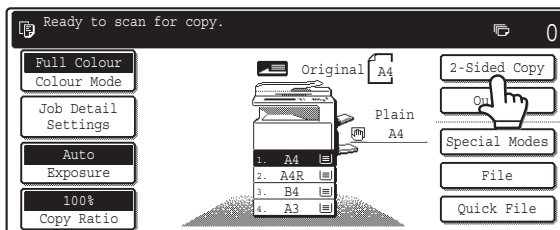

Touch the [2-Sided Copy] key.

3

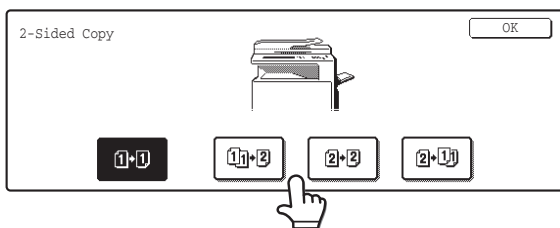

Select the 2-sided copy mode.

Touch the key of the 2-sided copy mode that you wish to use.

: Automatic 2-sided copying of 1-sided originals

: Automatic 2-sided copying of 2-sided originals

: 1-sided copying of 2-sided originals



When making automatic 2-sided copies of a 1-sided A3 (11" x 17") or B4 (8-1/2" x 14") size portrait original, or when you wish to vertically invert the reverse side of a 2-sided original, touch the [Binding Change] key.

Using the [Binding Change] key (page 17)

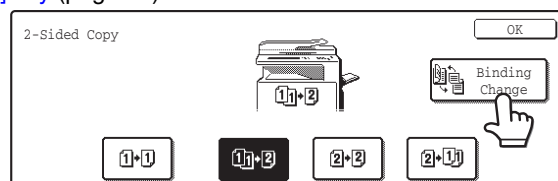

4

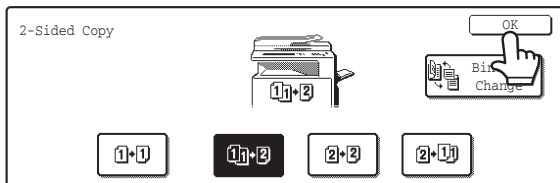

Touch the [OK] key.

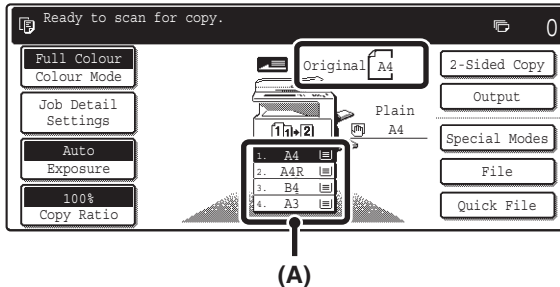

Make sure that the automatically selected paper size is the same size as the original.

The selected tray is highlighted. You can also copy onto paper that is a different size than the original.

5



- The 2-sided copy setting appears at the top of the paper size display (A).
- Depending on the size of the placed original, there may be cases where the same size of paper as the original is not selected automatically. In this event, change the paper size manually.
- To change the paper size selection, touch the [Job Detail Settings] key and then the [Paper Select] key, or touch the paper size display (A).

The following screen appears when the [Paper Select] key or the paper size display (A) is touched. Touch the key of the tray that has the desired paper size and then touch the [OK] key.

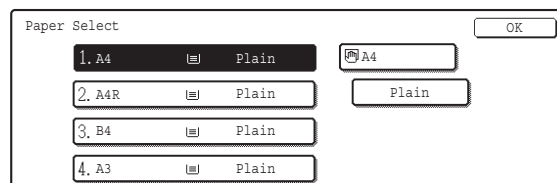

6

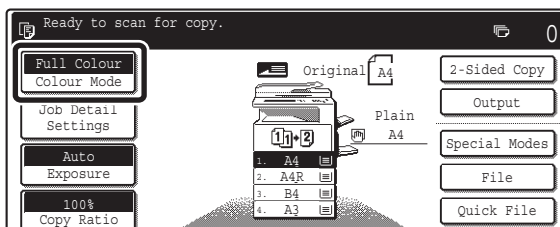

Check the colour mode.

The currently selected colour mode appears.

To change the colour mode, touch the [Colour Mode] key, touch the [Full Colour] key, [Auto] key, [Single Colour] key or [2 Colour] key, and touch the [OK] key.

➤ [COPY COLOUR MODES](#) (page 21)

Full Colour: The original is copied in full colour.

Auto: Colour or black and white is automatically selected when the original is scanned.

Single Colour: The original is copied in the selected colour only.

2 Colour: Only the red areas of the original are changed to the selected colour; colours other than red are scanned in black.

7

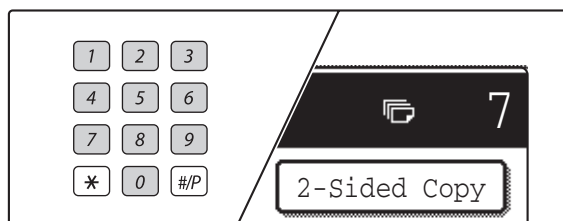

Set the number of copies (sets) with the numeric keys.



- Up to 999 can be set.
- If you are only making a single copy, the copy can be made with the copy number display showing "0".



If an incorrect number of copies is set...

Press the [CLEAR] key (C) and then enter the correct number.

8

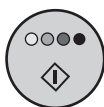

or



Press the [COLOUR START] key (○●●●) or the [BLACK & WHITE START] key (○●).



To cancel scanning of the original and copying...

Press the [STOP] key (⊘).

Using the [Binding Change] key

Originals	Binding Change is used	Binding Change is not used
	<p>The reverse side is upside down.</p> <p>Select this when the pages will be bound into a tablet.</p>	<p>The reverse side is not upside down.</p> <p>Select this when the pages will be bound into a booklet.</p>

AUTOMATIC 2-SIDED COPYING USING THE DOCUMENT GLASS

The following 2-sided copying can be performed automatically. The paper is turned over automatically, allowing easy 2-sided copying.

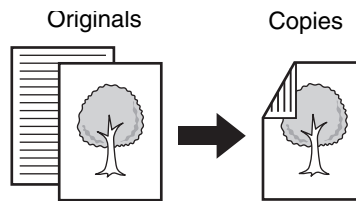

Automatic 2-sided copying of 1-sided originals

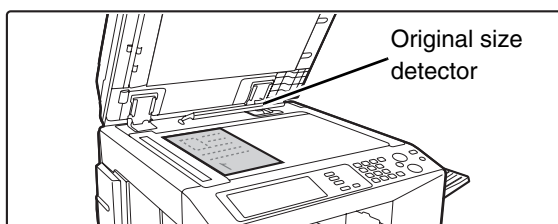

Open the automatic document feeder, place the original face down on the document glass, and then gently close the automatic document feeder.

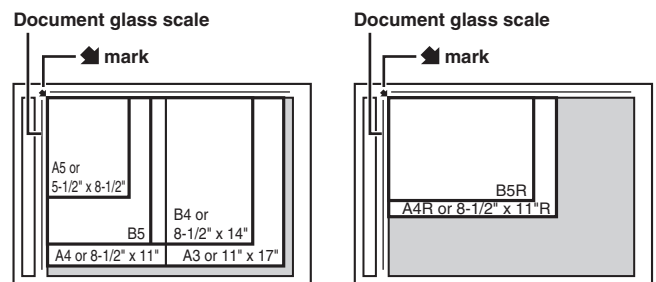

- Align the corner of the original with the tip of the arrow mark on the document glass scale.
- Place the original in the appropriate position for its size as shown above.



Do not place any objects under the original size detector. Closing the automatic document feeder with an object underneath may damage the original size detector plate and prevent correct detection of the document size.

1

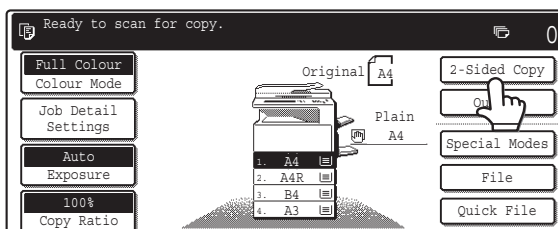

Touch the [2-Sided Copy] key.

2

3

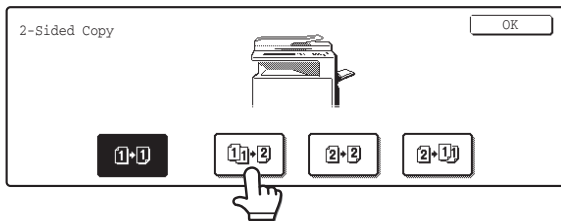

Touch the [1-Sided to 2-Sided] key.



The [2-Sided to 2-Sided] key and [2-Sided to 1-Sided] key cannot be used when copying from the document glass.

4

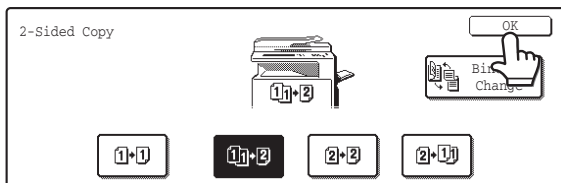

Touch the [OK] key.

5



- The "1-Sided to 2-Sided" copy setting appears at the top of the paper size display (A).
- Depending on the size of the placed original, there may be cases where the same size of paper as the original is not selected automatically. In this event, change the paper size manually.
- To change the paper size selection, touch the [Job Detail Settings] key and then the [Paper Select] key, or touch the paper size display (A).

The following screen appears when the [Paper Select] key or the paper size display (A) is touched. Touch the tray key that has the desired paper size and then touch the [OK] key.

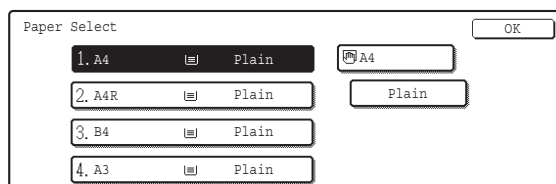

6

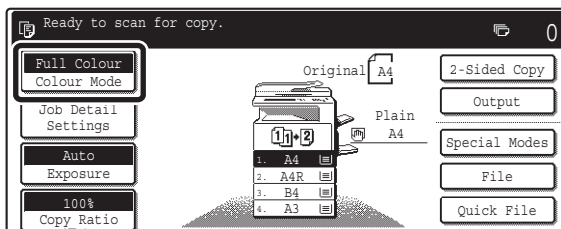

Check the colour mode.

The currently selected colour mode appears.

To change the colour mode, touch the [Colour Mode] key, touch the [Full Colour] key, [Auto] key, [Single Colour] key or [2 Colour] key, and touch the [OK] key.

[COPY COLOUR MODES](#) (page 21)

Full Colour: The original is copied in full colour.

Auto: Colour or black and white is automatically selected when the original is scanned.

Single Colour: The original is copied in the selected colour only.

2 Colour: Only the red areas of the original are changed to the selected colour; colours other than red are scanned in black.

7

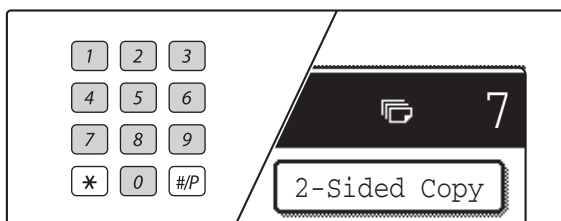

Set the number of copies (sets) with the numeric keys.



- Up to 999 can be set.
- A single copy can be made even if "0" appears for the number of copies.



If an incorrect number of copies is set...

Press the [CLEAR] key (C) and then enter the correct number.

8

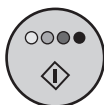

or



Press the [COLOUR START] key (○●●●) or the [BLACK & WHITE START] key (○●).

Scanning begins.

If you are using the sort function or other function that requires all originals to be scanned before the copies are printed, you must use the same [START] key that you used to scan the first original to scan each of the remaining originals.

9

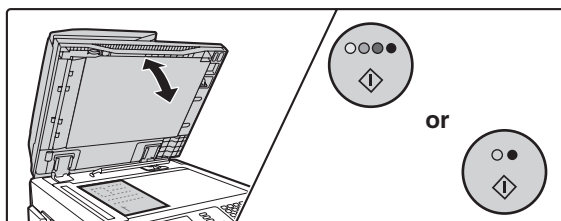

Remove the original and place the next original, and then press the [COLOUR START] key (○●●●) or the [BLACK & WHITE START] key (○●).

If you are using the sort function or other function that requires all originals to be scanned before the copies are printed, you must use the same [START] key that you used to scan the first original to scan each of the remaining originals.

Repeat this step until all originals have been scanned.

10

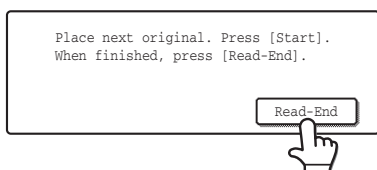

Touch the [Read-End] key.



To cancel scanning of the original and copying...

Press the [STOP] key (⊘).

COPY COLOUR MODES

This section explains how to select the colour mode.

For a colour original, set the colour mode to Full Colour.

If colour originals and black and white originals are mixed together, set the colour mode to Auto.

Full Colour	The original is copied in full colour.
Single Colour	The original is copied in the selected colour only. All colours in the original are changed to the selected colour, which can be selected from red, green, blue, cyan, magenta, or yellow.
2 Colour	Only the red areas of the original are changed to the selected colour; colours other than red are copied in black. This lets you make copies that are more expressive than black and white copies. Red, green, blue, cyan, magenta, or yellow can be selected.
Auto	A colour original is normally copied in Full Colour mode when the [COLOUR START] key (○●●●) is pressed. However, if colour originals and black and white originals are mixed together, follow the steps below to set the colour mode to [Auto]. The discrimination point for detecting whether originals are colour or black and white can be set using "Detect Standard in Auto Colour Mode" in the system settings (administrator).

SELECTING THE COLOUR MODE

1

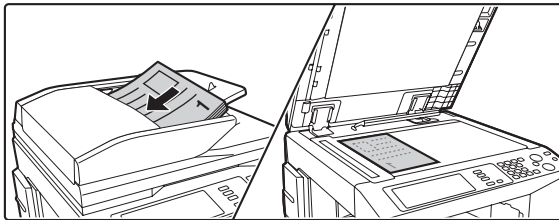

Place the original.

Place the original face up in the document feeder tray, or face down on the document glass.

2

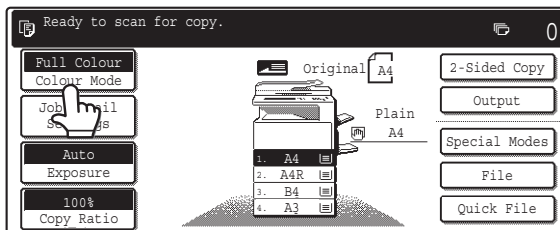

Touch the [Colour Mode] key.

3

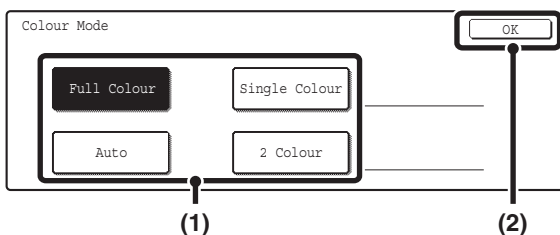

Set the colour mode.

- (1) Select the colour mode.
- (2) Touch the [OK] key.



When auto mode is used, there may be some originals for which the mode is not correctly switched between full colour mode and black and white mode. In this event, press the [COLOUR START] key (○●●●) or the [BLACK & WHITE START] key (○●) as appropriate to manually switch between colour copying and black and white copying.

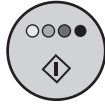

Press the [COLOUR START] key (○●●●).

Scanning begins.

- If the originals were placed in the document feeder tray, the originals are copied.
- If you are using the document glass, copy each page one page at a time.



To cancel scanning of the original and copying...

Press the [STOP] key (⏏).



Even if a colour mode is selected, copying will take place in black and white if the [BLACK & WHITE START] key (○●) is pressed.



System Settings (Administrator): Detect Standard in Auto Colour Mode

When the colour mode is set to auto, the discrimination point for detecting whether originals are colour or black and white can be set to one of 5 levels.

Selecting single colour copying

When [Single Colour] is selected for the colour mode, the following screen appears. Touch the desired colour and touch the [OK] key.

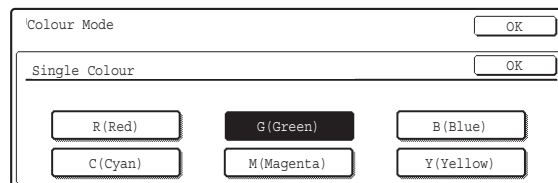

Selecting 2 colour copying

When [2 Colour] is selected for the colour mode, the following screen appears. Touch the desired colours and touch the [OK] key.

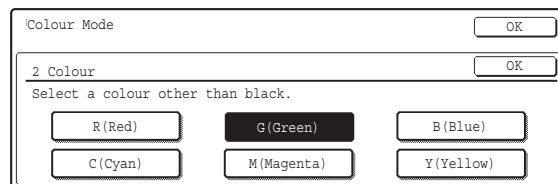

CHANGING THE EXPOSURE AND EXPOSURE MODE

The exposure level and exposure mode can be selected to obtain a clear copy.

AUTOMATIC ADJUSTMENT OF THE EXPOSURE AND EXPOSURE MODE

Automatic exposure adjustment operates by default to automatically adjust the exposure level and mode as appropriate for the original being copied. ("Auto" is displayed.)

When a black and white or full colour copy is made, the exposure is automatically adjusted to obtain the best image quality.

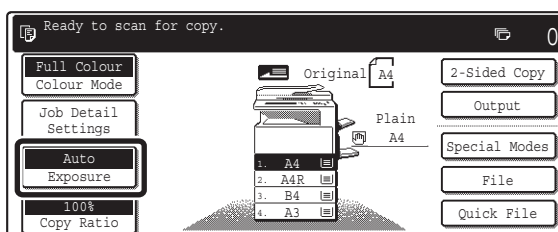

SELECTING THE EXPOSURE MODE AND MANUALLY ADJUSTING THE EXPOSURE LEVEL

To select the exposure mode, or to manually adjust the exposure level, follow the steps below.

1

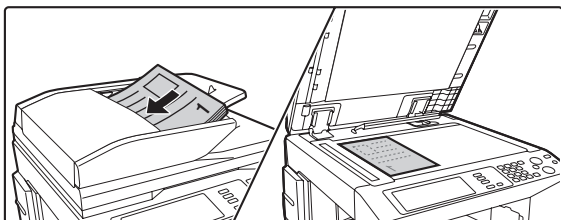

Place the original.

Place the original face up in the document feeder tray, or face down on the document glass.

2

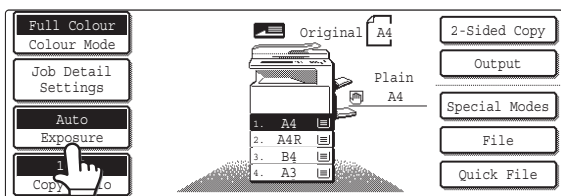

Touch the [Exposure] key.

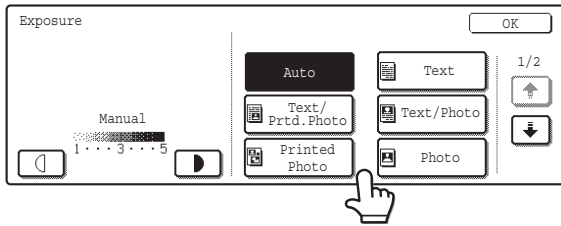

Select the exposure mode.

Touch the appropriate original type key to select the exposure mode.

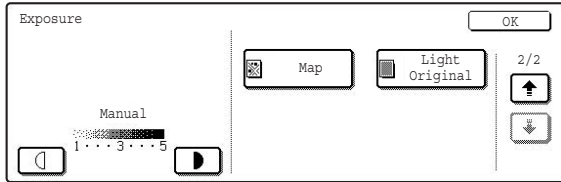

● Selecting the exposure mode

Mode	Description
Auto	Normally this setting is selected. When a black and white or full colour copy is made, the exposure is automatically adjusted to obtain the best image quality.
Text	Use this mode for regular text documents.
Text/Prt'd. Photo	This mode provides the best balance for copying an original which contains both text and printed photographs, such as a magazine or catalogue.
Text/Photo	This mode provides the best balance for copying an original which contains both text and photographs, such as a text document with a photo pasted on.
Printed photo	This mode is best for copying printed photographs, such as photos in a magazine or catalogue.
Photo	Use this mode to copy photos.
Map	This mode is best for copying the light colour shading and fine text found on most maps.
Light Original	Use this mode for originals with light pencil writing.



If [Auto] is selected but the darkness or lightness of the image does not seem quite right...

If the image seems too light or too dark when [Auto] is selected, the exposure level can be adjusted using "Copy Exposure Adjustment" in the system settings (administrator).

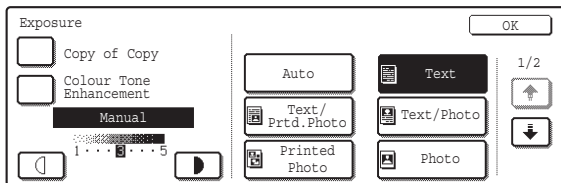

Adjust the exposure level.

Touch the key to make the copy darker.

Touch the key to make the copy lighter.

- **Using a copy or printed page as an original**

When using a copy or printed page from the machine as an original, touch the [Copy of Copy] checkbox so that a checkmark appears.

When [Copy of Copy] is selected, only [Text], [Printed Photo], or [Text/Prtd.Photo] can be selected for the exposure mode.

- **To enhance the colour of a colour copy...**

Touch the [Colour Tone Enhancement] checkbox so that a checkmark appears.



- **Exposure levels when [Text] is selected:**

1 to 2: Dark originals such as a newspaper

3: Normal density originals

4 to 5: Originals written in pencil or light coloured text

- **Restrictions when Colour Tone Enhancement is selected**

When [Colour Tone Enhancement] is selected in step 4, the following functions cannot be used:

- [Copy of Copy]
- [Auto] or [Light Original] exposure
- [Intensity] in the special modes
- [2 colour] or [Single Colour] in the colour mode

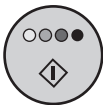

or



Press the [COLOUR START] key (○●●●) or the [BLACK & WHITE START] key (○●).

Scanning begins.

- If the originals were placed in the document feeder tray, the originals are copied.
- If you placed the original on the document glass, scan each page one page at a time. If you are using the sort function or other function that requires all originals to be scanned before the copies are printed, you must use the same [START] key that you used to scan the first original to scan each of the remaining originals.



- **To cancel scanning of the original and copying...**

Press the [STOP] key (◻).



System Settings (Administrator): Copy Exposure Adjustment

The exposure level used for automatic exposure adjustment can be adjusted.

REDUCTION/ENLARGEMENT/ZOOM

AUTOMATIC RATIO SELECTION (Auto Image)

This section explains the automatic ratio selection function (Auto Image), which automatically selects the ratio to match the paper size.

The reduction or enlargement ratio is selected automatically based on the original size and the selected paper size.

1

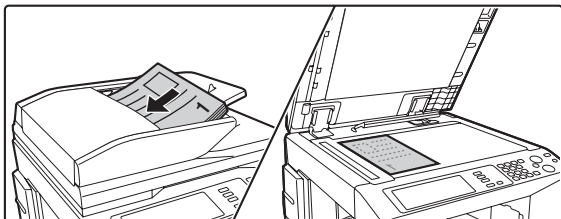

Place the original.

Place the original face up in the document feeder tray, or face down on the document glass.



Automatic ratio selection cannot be used if the original size or paper size is a non-standard size. If the original size is a non-standard size, automatic ratio selection cannot be used unless the original size is entered manually.

2

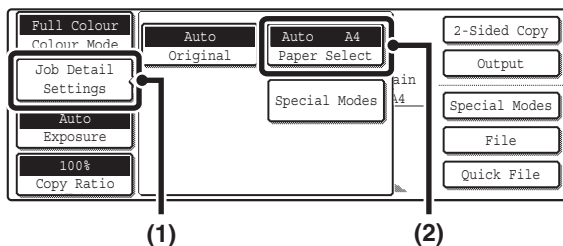

Open the paper settings screen.

- (1) Touch the [Job Detail Settings] key.
- (2) Touch the [Paper Select] key.

3

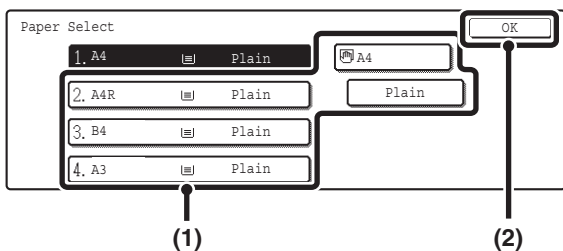

Set the paper size.

- (1) Touch the tray that has the desired paper size.
- (2) Touch the [OK] key.

When the [OK] key is touched, you will return to the job detail setting screen. Touch the [Job Detail Settings] key to return to the base screen of copy mode.

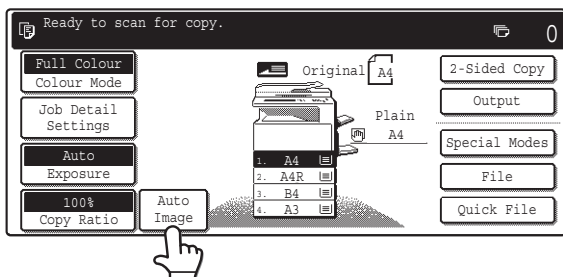

4



Touch the [Auto Image] key.

A suitable ratio for the original size and the selected paper size will be selected. (The selected ratio will appear in the ratio display.)



If the message "Rotate original from  to 

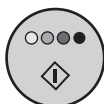

or



Press the [COLOUR START] key (○●●●) or the [BLACK & WHITE START] key (○●).

Scanning begins.

- If the originals were placed in the document feeder tray, the originals are copied.
- If you placed the original on the document glass, scan each page one page at a time. If you are using the sort function or other function that requires all originals to be scanned before the copies are printed, you must use the same [START] key that you used to scan the first original to scan each of the remaining originals.



To cancel scanning of the original and copying...

Press the [STOP] key (⏹).



To cancel automatic ratio selection...

Touch the [Auto Image] key so that it is no longer highlighted.

To return the ratio to 100%...

To return the ratio setting to 100%, touch the [Copy Ratio] key to display the ratio menu and then touch the [100%] key.

MANUALLY SELECTING THE RATIO (Preset ratios/Zoom)

The enlargement and reduction keys can be used to select five preset ratios each (from a maximum of 400% to a minimum of 25%).

In addition, the zoom keys can be used to select any ratio from 25% to 400% in increments of 1%.

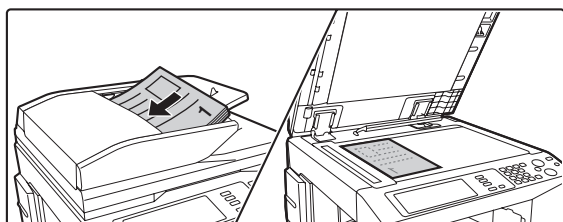

Place the original.

Place the original face up in the document feeder tray, or face down on the document glass.



When the automatic document feeder is used, the ratio selection range is 25% to 200%.

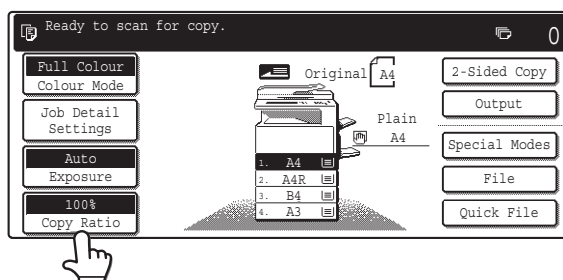

Touch the [Copy Ratio] key.

Touch the [Menu] key to select copy ratio menu "1" or "2".

● Menu 1

- Enlarge keys: 115%, 122% and 141% (for the AB system). 121% and 129% (for the inch system).
- Reduction keys: 70%, 81% and 86% (for the AB system). 77% and 64% (for the inch system).
- Full size key: 100%

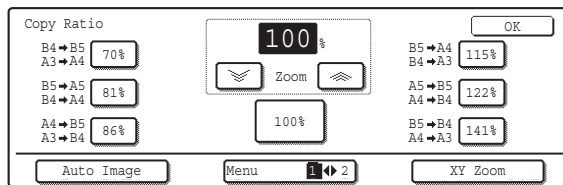

● Menu 2

- Enlargement keys (2 to 4 ratios) 200%, 400%, any ratio (max. of two)
- Reduction keys (2 to 4 ratios) 25%, 50%, any ratio (max. of two)
- Full size key 100%

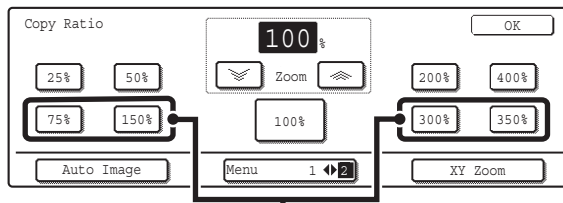

(A)



Keys marked (A)

The keys marked (A) can be set to show any ratio using "Add or Change Extra Preset Ratios" in the system settings (administrator).

3

Touch a preset ratio key and zoom key to select the desired ratio and touch the [OK] key.

After touching the [OK] key, make sure that a paper size suitable for the ratio is selected.

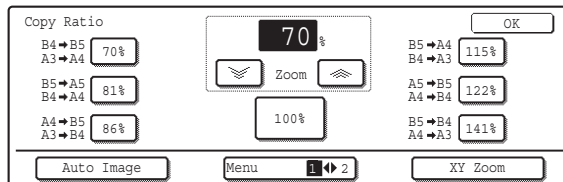

- To quickly select a ratio, touch a reduction or enlargement key to select a ratio close to the desired ratio and then use the zoom keys for fine adjustment.
- The zoom keys can be used to select any ratio from 25% to 400% in increments of 1%.
- Touch the key to increase the ratio, or the key to decrease the ratio. (If you continue to touch the key, the ratio will change automatically. After 3 seconds, the ratio will change rapidly.)
- If the message "Image is larger than the copy paper." appears when an enlargement ratio is selected, the image may not fit on the paper.

4

Touch the [Job Detail Settings] key and make sure that a suitable paper size is selected for the ratio.

If "Auto" appears in the [Paper Select] key (B), auto paper selection is enabled. If auto paper selection is not enabled, select the paper size manually.

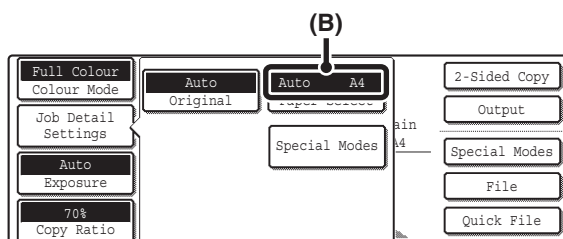

5

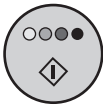

or



Press the [COLOUR START] key (○●●●) or the [BLACK & WHITE START] key (○●).

Scanning begins.

- If the originals were placed in the document feeder tray, the originals are copied.
- If you placed the original on the document glass, scan each page one page at a time. If you are using the sort function or other function that requires all originals to be scanned before the copies are printed, you must use the same [START] key that you used to scan the first original to scan each of the remaining originals.



To cancel scanning of the original and copying...

Press the [STOP] key (⏹).



To return the ratio to 100%...

To return the ratio setting to 100%, touch the [Copy Ratio] key to display the ratio menu and then touch the [100%] key.



System Settings (Administrator): Add or Change Extra Preset Ratios

Two enlargement preset ratios (101% to 400%) and two reduction preset ratios (25% to 99%) can be added. An added preset ratio can also be changed.

ENLARGING/REDUCING THE LENGTH AND WIDTH SEPARATELY (XY Zoom)

The XY Zoom feature allows the horizontal and vertical copy ratios to be changed separately. Both the horizontal and vertical ratios can be set from 25% to 400% in increments of 1%.

When 50% is selected for the horizontal ratio and 70% is selected for the vertical ratio

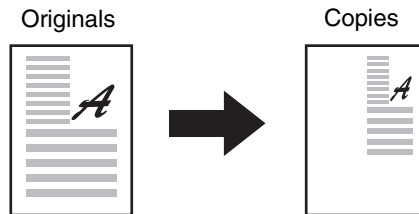

1

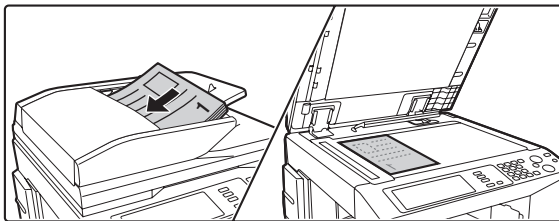

Place the original.

Place the original face up in the document feeder tray, or face down on the document glass.

2

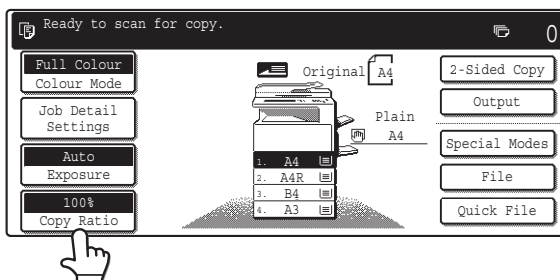

Touch the [Copy Ratio] key.

3

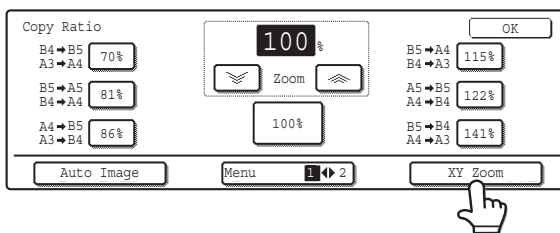

Touch the [XY Zoom] key.

4

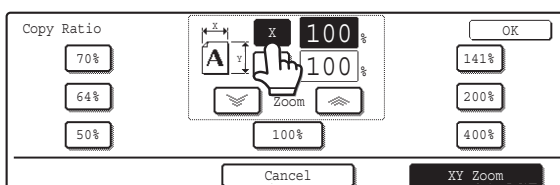

Touch the [X] key.

The initial state of the [X] key is selected (highlighted), so this step is normally not necessary. Touch the [X] key only if it is not highlighted.

5

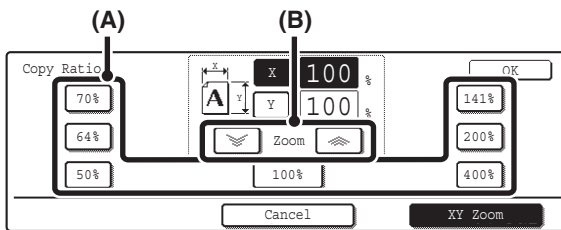

Touch one of the preset ratio keys (A) and the zoom keys (B) to set the horizontal (X) ratio.

(A) A preset ratio key will not become highlighted when touched.

(B) The zoom keys can be touched to set the ratio from 25% to 400% in increments of 1%.



To quickly select a ratio, touch a preset ratio key (A) to select a ratio close to the desired ratio and then use the zoom keys (B) for fine adjustment.

6

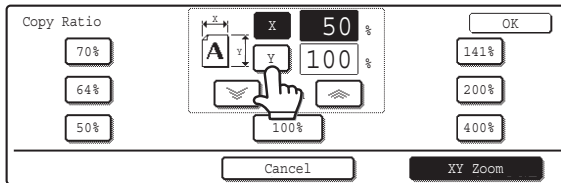

Touch the [Y] key.

7

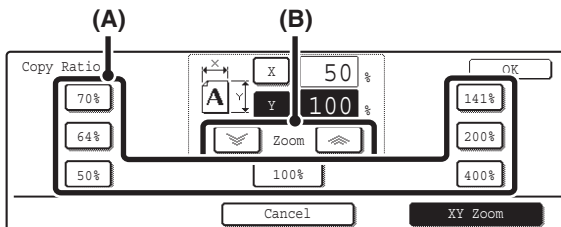

Touch one of the preset ratio keys (A) and the zoom keys (B) to set the vertical (Y) ratio.

(A) A preset ratio key will not become highlighted when touched.

(B) The zoom keys can be touched to set the ratio from 25% to 400% in increments of 1%.



If needed, you can touch the [X] key once again to readjust the X zoom.

8

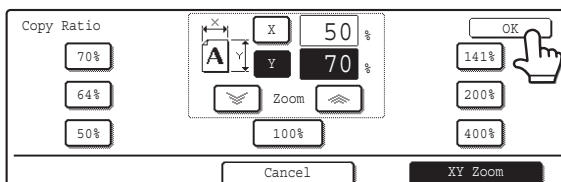

Touch the [OK] key.

9

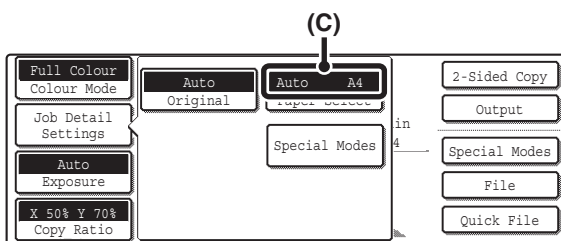

Touch the [Job Detail Settings] key and make sure that a suitable paper size is selected for the ratio.

If "Auto" appears in the [Paper Select] key (C), auto paper selection is enabled. If auto paper selection is not enabled, select the paper size manually.

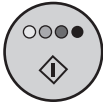

or



Press the [COLOUR START] key (○●●●) or the [BLACK & WHITE START] key (○●).

Scanning begins.

- If the originals were placed in the document feeder tray, the originals are copied.
- If you placed the original on the document glass, scan each page one page at a time. If you are using the sort function or other function that requires all originals to be scanned before the copies are printed, you must use the same [START] key that you used to scan the first original to scan each of the remaining originals.



To cancel scanning of the original and copying...

Press the [STOP] key (⊘).



When the automatic document feeder is used, the vertical and horizontal ratio selection ranges are both 25% to 200%.



To cancel an XY zoom setting...

To cancel an XY Zoom setting, touch the [XY Zoom] key or the [Cancel] key.

ORIGINAL SIZES

CHECKING THE ORIGINAL SIZE

When the original is placed, the original size is automatically detected and displayed in the base screen. If [Auto] appears in the [Original] key that is displayed when the [Job Detail Settings] key is touched, the size of the placed original is automatically detected. (Automatic original detection function)

Example of base screen

The original size is displayed. An icon shows the orientation of the original.

If the original size is not a standard size, it will not be automatically detected. In this case, specify the original size.

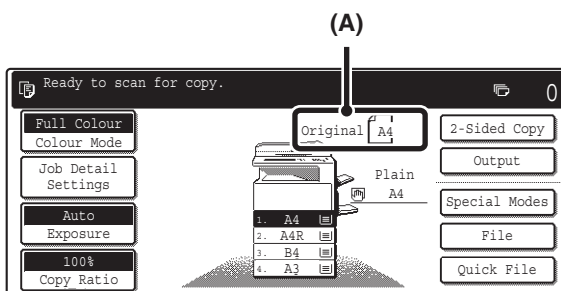

Example of the [Original] key display

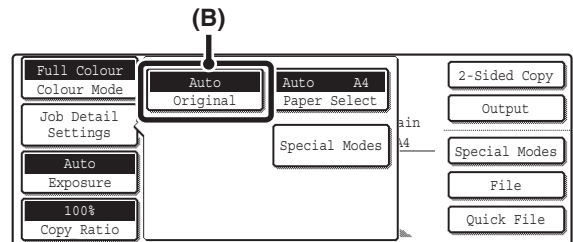

(A) The original size is displayed.

(B) "Auto" appears when the automatic original detection function is operating.

List of original size detector settings

The standard sizes are set in "Original Size Detector Setting" in the system settings (administrator). The factory default setting is "AB-1 (Inch-1)".

Selections	Detectable original sizes	
	Document glass	Document feeder tray (automatic document feeder)
AB-1	A3, A4, A4R, A5, B4, B5, B5R	A3, A4, A4R, A5, B4, B5, B5R, 8-1/2" x 11", 8-1/2" x 14", 11" x 17"
AB-2	A3, A4, A4R, A5, B5, B5R, 216 mm x 330 mm (8-1/2" x 13")	A3, A4, A4R, A5, B4, B5, B5R, 8-1/2" x 11", 11" x 17", 216 mm x 330 mm (8-1/2" x 13")
AB-3	A4, A4R, A5, B4, 8K, 16K, 16KR	A3, A4, A4R, A5, B4, 8K, 16K, 16KR, 8-1/2" x 11", 11" x 17", 216 mm x 330 mm (8-1/2" x 13")
Inch-1	11" x 17", 8-1/2" x 14", 8-1/2" x 11", 8-1/2" x 11"R, 5-1/2" x 8-1/2"	11" x 17", 8-1/2" x 14", 8-1/2" x 11", 8-1/2" x 11"R, 5-1/2" x 8-1/2", A4, A3
Inch-2	11" x 17", 8-1/2" x 13" (216 mm x 330 mm), 8-1/2" x 11", 8-1/2" x 11"R, 5-1/2" x 8-1/2"	11" x 17", 8-1/2" x 13" (216 mm x 330 mm), 8-1/2" x 11", 8-1/2" x 11"R, 5-1/2" x 8-1/2", A4, A3

- When the automatic original detection function is operating and the original is a non-standard size (an inch size or special size), the closest standard size may be displayed or the original size may not appear. In this event, manually set the correct original size.
[SPECIFYING THE ORIGINAL SIZE](#) (page 35)
- When placing a non-standard size original on the document glass, you can make it easier for the size to be detected by placing a blank sheet of A4, B5 (8-1/2" x 11", 5-1/2" x 8-1/2"), or other standard size of paper on top of the original.

Standard original placement orientations

Place originals in the document feeder tray or on the document glass so that the top and bottom of the original are oriented as shown below. If originals are placed in the wrong orientation, staples will be incorrectly positioned and some special features may not give the expected result. For more information on placing the original, see "3. ORIGINAL" in the User's Guide.

[Example 1]

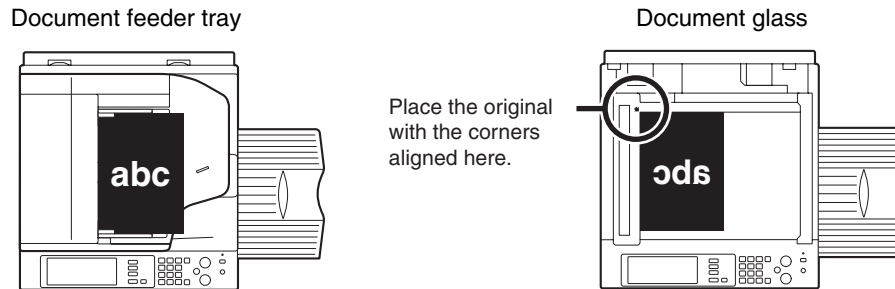

[Example 2]

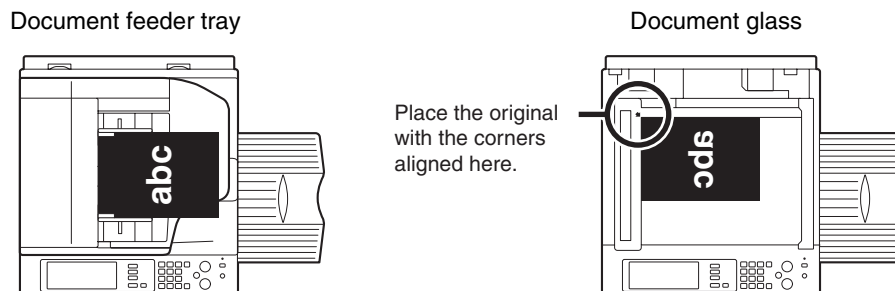

Automatic copy image rotation (Rotation Copy)

If the orientation of the original and paper are different, the original image will be automatically rotated 90° to match the paper. (When an image is rotated, a message will be displayed.)

[Example]

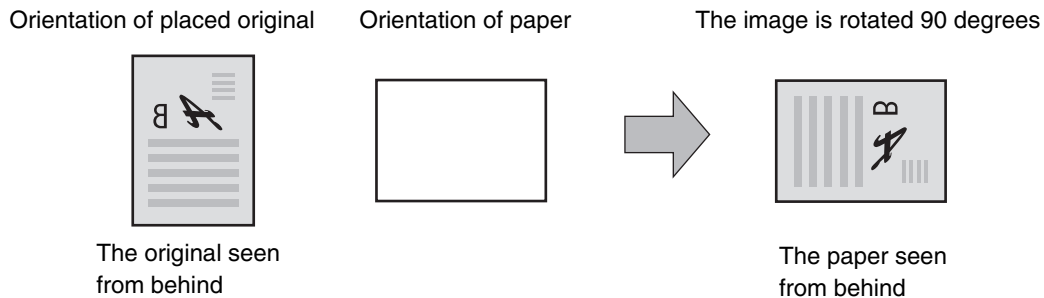

This function operates in either auto paper selection mode or auto image mode. Rotation can be disabled using "Rotation Copy Setting" in the system settings (administrator).

SPECIFYING THE ORIGINAL SIZE

When the original size is a non-standard size or is not detected correctly, manually specify the original size.

1

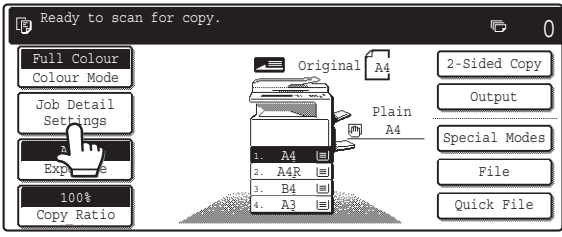

Touch the [Job Detail Settings] key.

2

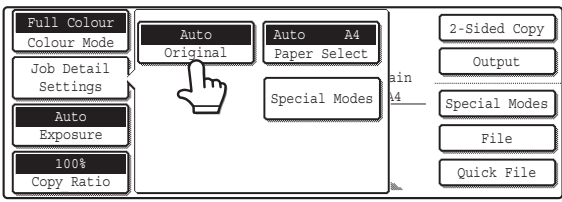

Touch the [Original] key.

3

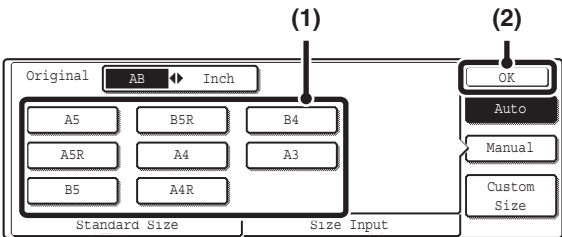

Specify the original size.

- Specifying an AB original size

- (1) Touch the appropriate original size key.
- (2) Touch the [OK] key.

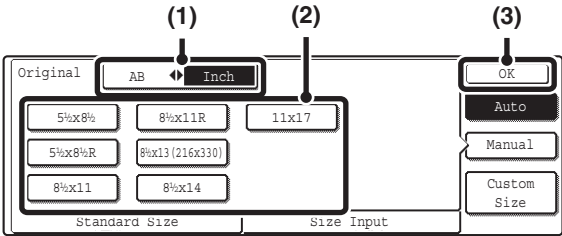

- Specifying an inch original size

- (1) Touch the [AB \leftrightarrow Inch] key.
- (2) Touch the appropriate original size key.
- (3) Touch the [OK] key.

● Specifying a non-standard original size

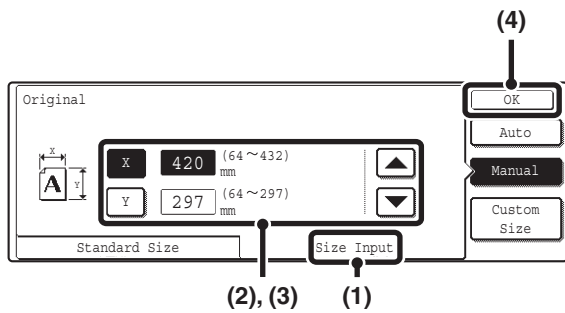

(1) Touch the [Size Input] tab.

(2) Enter the X (horizontal) dimension of the original.

With the [X] key highlighted, enter the X (horizontal) dimension of the original with the \blacktriangledown \blacktriangle keys. When the document glass is used, a dimension from 64 mm to 432 mm (2-1/2" to 17") can be entered.

When an automatic document feeder is installed, a dimension from 140 mm to 432 mm (5-1/2" to 17") can be entered.

If the length or width of the original is less than 140 mm (5-1/2"), use the document glass.

(3) Enter the Y (vertical) dimension of the original.

Touch the [Y] key and enter the Y (vertical) dimension of the original with the \blacktriangledown \blacktriangle keys. When the document glass is used, a dimension from 64 mm to 297 mm (2-1/2" to 11-5/8") can be entered.

When an automatic document feeder is installed, a dimension from 131 mm to 297 mm (5-1/8" to 11-5/8") can be entered.

If the length or width of the original is less than 131 mm (5-1/8"), use the document glass.

(4) Touch the [OK] key.

When the [OK] key is touched, you will return to the job detail setting screen. Touch the [Job Detail Settings] key to return to the base screen of copy mode.

4

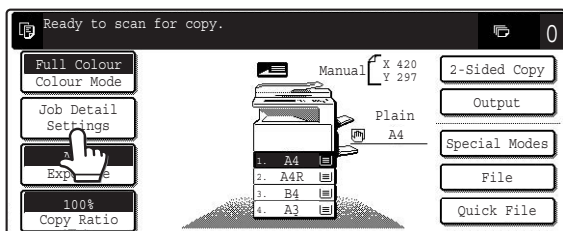

Verify that the correct original size is entered.

- Make sure that the entered numbers appear in the [Original] key. If the numbers are not correct, touch the [Original] key again and enter the correct numbers.
- If the correct numbers appear, touch the [Job Detail Settings] key to return to the base screen of copy mode. The original size display in the base screen will show "Manual".

STORING FREQUENTLY USED ORIGINAL SIZES

You can save special original sizes that you frequently use. This section explains how to store, call up, change, and delete special original sizes.

Storing original sizes

Up to 9 special original sizes can be stored.

1

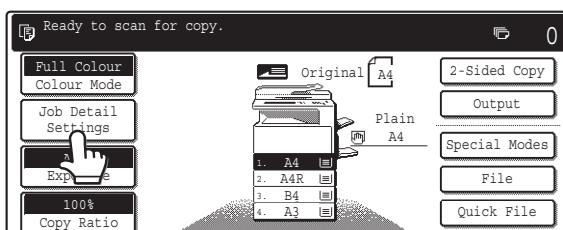

Touch the [Job Detail Settings] key.

2

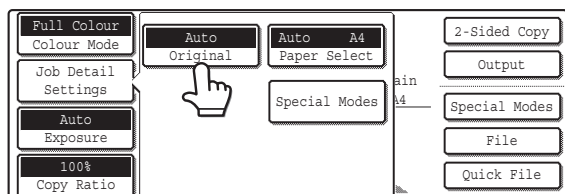

Touch the [Original] key.

3

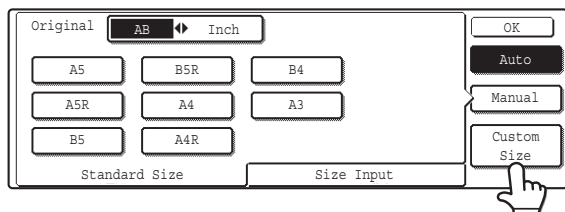

Touch the [Custom Size] key.

4

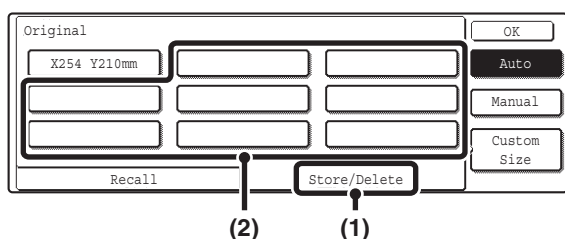

Select a key for storing a custom original size.

- (1) Touch the [Store/Delete] tab.
- (2) Touch a key for storing a custom original size.

Touch a key that does not show a size ().

5

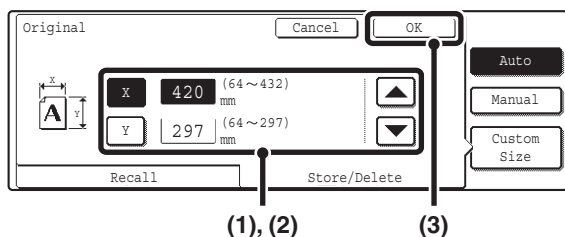

Enter the original size.

- (1) Enter the X (horizontal) dimension of the original.

With the [X] key highlighted, enter the X (horizontal) dimension of the original with the keys. A dimension from 64 mm to 432 mm (2-1/2" to 17") can be entered.

- (2) Enter the Y (vertical) dimension of the original.

Touch the [Y] key and enter the Y (vertical) dimension of the original with the keys. A dimension from 64 mm to 297 mm (2-1/2" to 11-5/8") can be entered.

- (3) Touch the [OK] key.

6

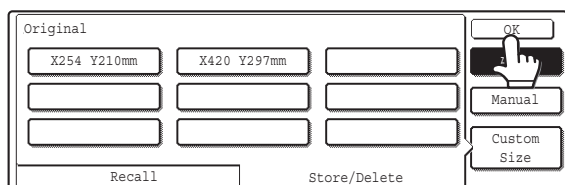

Touch the [OK] key.



The stored original size will be retained even if an interruption in the power supply occurs.



To cancel the operation...

Press the [CLEAR ALL] key ().

Using a stored original size

1

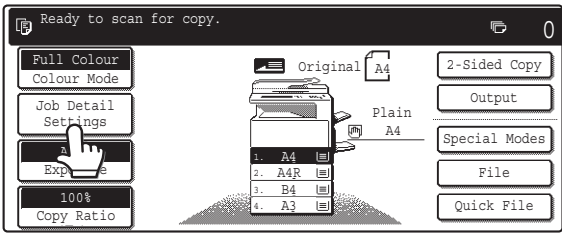

Ready to scan for copy.

Full Colour Colour Mode

Job Detail Settings

Exposure

100% Copy Ratio

Original A4

Plain A4

2-Sided Copy

Output

Special Modes

File

Quick File

1. A4

2. A4R

3. B4

4. A3

Touch the [Job Detail Settings] key.

2

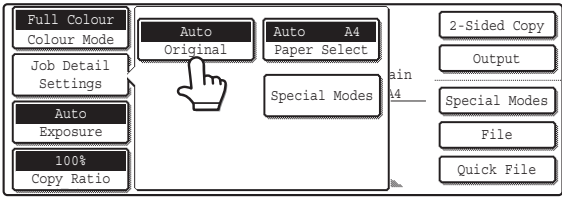

Full Colour Colour Mode

Job Detail Settings

Auto Exposure

100% Copy Ratio

Auto Original

Auto A4 Paper Select

Special Modes

Plain A4

2-Sided Copy

Output

Special Modes

File

Quick File

Touch the [Original] key.

3

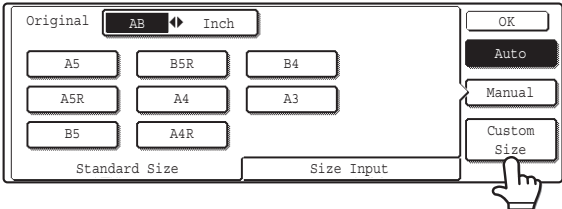

Original AB Inch

A5 B5R B4

A5R A4 A3

B5 A4R

Standard Size Size Input

OK

Auto

Manual

Custom Size

Touch the [Custom Size] key.

4

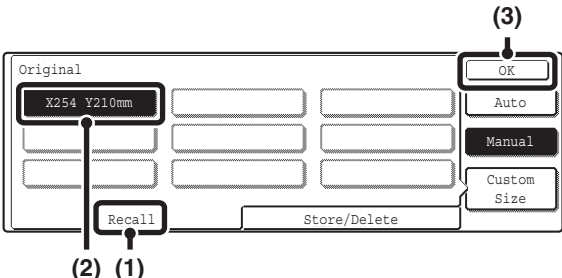

Original

X254 Y210mm

Recall

Store/Delete

OK

Auto

Manual

Custom Size

(1)

(2)

(3)

Call up the stored original size.

- (1) Touch the [Recall] tab.
- (2) Touch the key of the original size that you wish to call up.
- (3) Touch the [OK] key.



To cancel the operation...

Press the [CLEAR ALL] key (CA).

Changing a stored original size

1

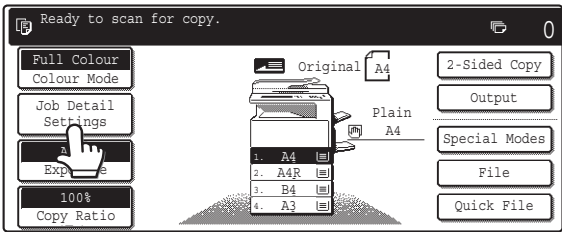

Ready to scan for copy.

Full Colour Colour Mode

Job Detail Settings

Exposure

100% Copy Ratio

Original A4

Plain A4

2-Sided Copy

Output

Special Modes

File

Quick File

1. A4

2. A4R

3. B4

4. A3

Touch the [Job Detail Settings] key.

2

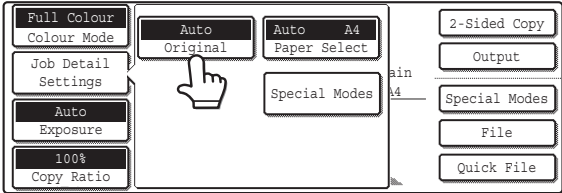

Full Colour Colour Mode

Job Detail Settings

Auto Exposure

100% Copy Ratio

Auto Original

Auto A4 Paper Select

Special Modes

2-Sided Copy

Output

Special Modes

File

Quick File

Touch the [Original] key.

3

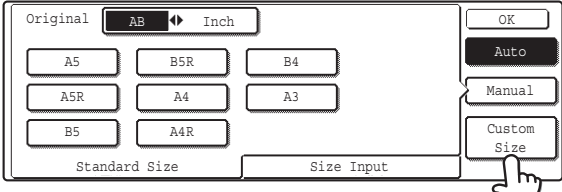

Original AB Inch

A5 B5R B4

A5R A4 A3

B5 A4R

Standard Size Size Input

OK

Auto

Manual

Custom Size

Touch the [Custom Size] key.

4

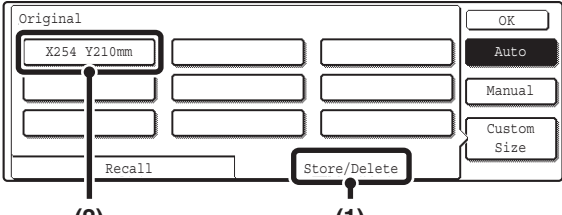

Original

X254 Y210mm

Recall

Store/Delete

OK

Auto

Manual

Custom Size

(2)

(1)

Select the original size key that you wish to change.

- (1) Touch the [Store/Delete] tab.
- (2) Touch the original size key that you wish to change.

Touch the key (X254 Y210mm) that shows the original size that you wish to change.

5



A custom size has already been stored in this location.

Cancel Delete Amend

Touch the [Amend] key.

6

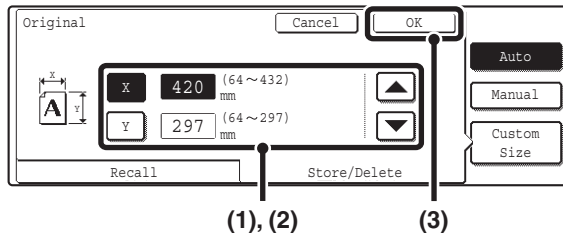

Change the original size.

- (1) Enter the X (horizontal) dimension of the original.

With the [X] key highlighted, enter the X (horizontal) dimension of the original with the keys. A dimension from 64 mm to 432 mm (2-1/2" to 17") can be entered.

- (2) Enter the Y (vertical) dimension of the original.

Touch the [Y] key and enter the Y (vertical) dimension of the original with the keys. A dimension from 64 mm to 297 mm (2-1/2" to 11-5/8") can be entered.

- (3) Touch the [OK] key.

7

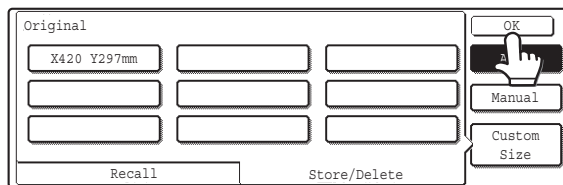

Touch the [OK] key.



To cancel the operation...

Press the [CLEAR ALL] key ().

Deleting a stored original size

1

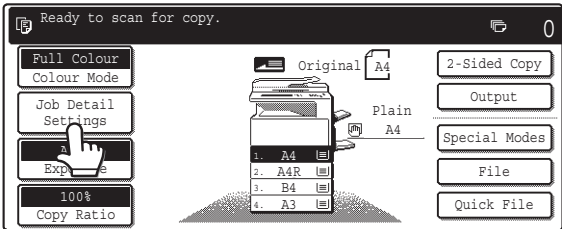

Ready to scan for copy.

Full Colour
Colour Mode

Job Detail Settings

EXPOSURE

100%
Copy Ratio

Original A4

Plain A4

1. A4
2. A4R
3. B4
4. A3

2-Sided Copy

Output

Special Modes

File

Quick File

Touch the [Job Detail Settings] key.

2

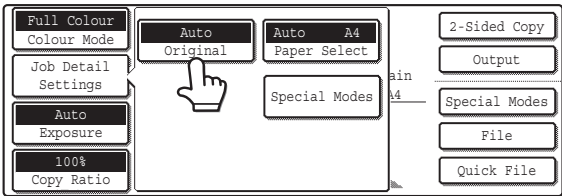

Full Colour
Colour Mode

Job Detail Settings

Auto Exposure

100%
Copy Ratio

Auto Original

Auto A4 Paper Select

Plain A4

Special Modes

2-Sided Copy

Output

Special Modes

File

Quick File

Touch the [Original] key.

3

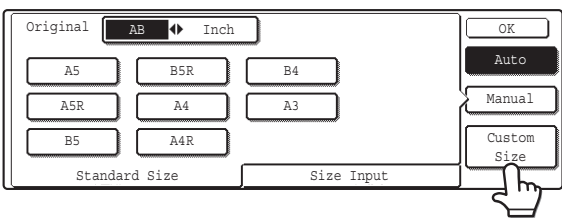

Original AB Inch

A5 B5R B4

A5R A4 A3

B5 A4R

Standard Size

Size Input

OK

Auto

Manual

Custom Size

Touch the [Custom Size] key.

4

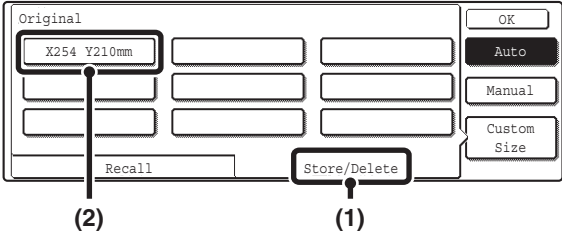

Original

X254 Y210mm

Recall

Store/Delete

OK

Auto

Manual

Custom Size

(2) (1)

Select the original size key that you wish to delete.

(1) Touch the [Store/Delete] tab.

(2) Touch the original size key that you wish to delete.

Touch the key (X254 Y210mm) that shows the original size that you wish to delete.

5



A custom size has already been stored in this location.

Cancel Delete Amend

Touch the [Delete] key.

6

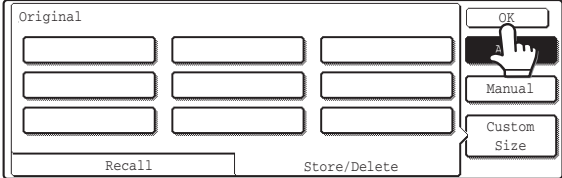

Original

Recall

Store/Delete

OK

Manual

Custom Size

Touch the [OK] key.



To cancel the operation...

Press the [CLEAR ALL] key (CA).

OUTPUT

To select output functions and the output tray, touch the [Output] key in the base screen of copy mode. Output functions that can be selected are sort, group, offset, staple sort, saddle stitch, and punch. All settings are explained in this section based on the assumption that a saddle stitch finisher, punch module and right tray are installed.

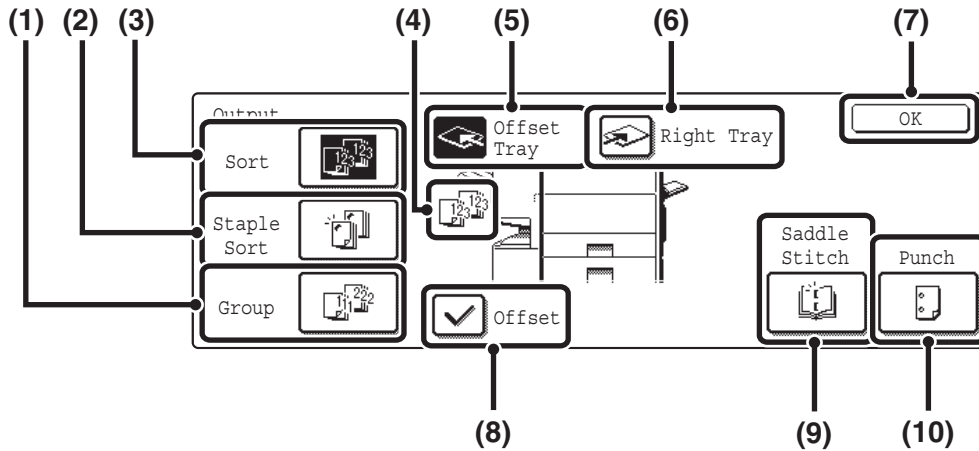

- (1) **[Group] key**
This is used to group copies by page.
➤ [Group mode](#) (page 43)
- (2) **[Staple Sort] key**
This is used to sort the output into sets, staple each set, and deliver the sets to the tray. (Note that the sets will not be offset in the output tray.) When this function is selected, three keys will appear for selecting the staple position.
➤ [Staple sort function / Saddle stitch function](#) (page 44)
- (3) **[Sort] key**
This is used to sort (collate) output into sets.
➤ [Sort mode](#) (page 43)
- (4) **Output display**
An icon will appear to indicate the output mode.
- (5) **[Offset Tray] key ([Centre Tray] key*)**
This is used to offset each set of output from the previous set in the offset tray (centre tray). The [Offset Tray] key is automatically selected when the [Staple Sort] key is selected.
* When only a right tray is installed, this appears as the "Centre tray".
- (6) **[Right Tray] key**
Select this key to have output delivered to the right tray. When the right tray is selected, offset, staple sort, saddle stitch, and punch cannot be selected.
- (7) **[OK] key**
Touch this key to close the output screen and return to the base screen.
- (8) **[Offset] key**
This is used to offset each set of output from the previous set. The offset function operates when the checkbox is selected and does not operate when the checkbox is not selected . (The offset checkmark is automatically cleared when the staple sort function is selected.)
➤ [Offset function](#) (page 43)
- (9) **[Saddle Stitch] key**
This is used to staple and fold each set of copies at the centreline.
➤ [Staple sort function / Saddle stitch function](#) (page 44)
When this key is touched, the saddle stitch setting screen appears. (Only when "Automatic Saddle Stitch" is enabled in the system settings (administrator).)
- (10) **[Punch] key**
This is used to punch holes in the output.
➤ [Punch function](#) (page 45)

 The keys that appear and that can be selected will vary depending on what peripheral devices are installed. Depending on what peripheral devices are installed, it may not be possible to select certain keys. If your screen is different from the above screen, see the screens below.

Display example 1

The screen when a right tray, finisher, and saddle stitch finisher are not installed.



Display example 2

The screen when a right tray is installed.

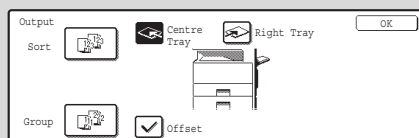

Display example 3

The screen when a right tray, finisher and punch module are installed.

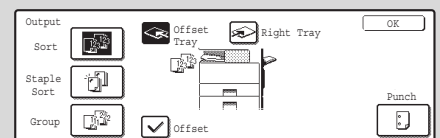

OUTPUT MODES

This section explains the output functions.

Sort mode

This is used to sort (collate) output into sets.

Example: Sorting the originals into 5 sets

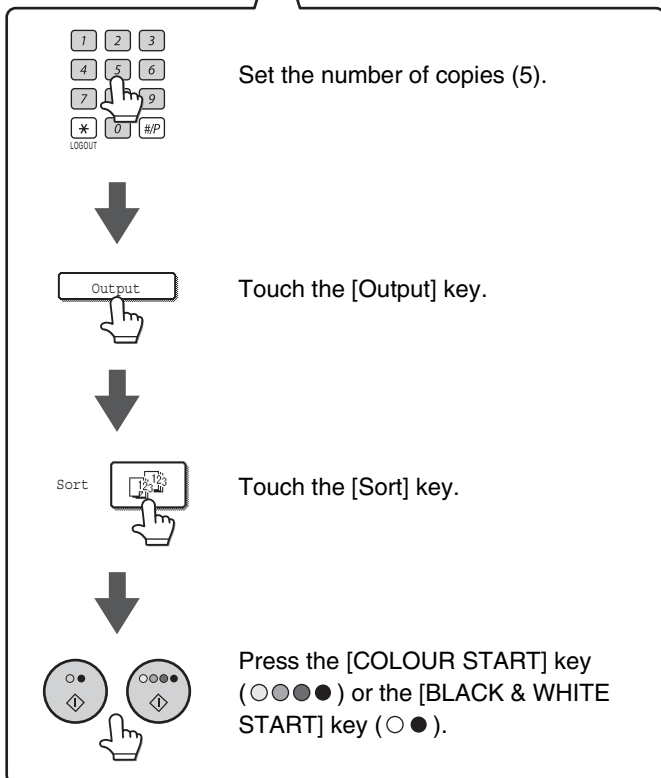
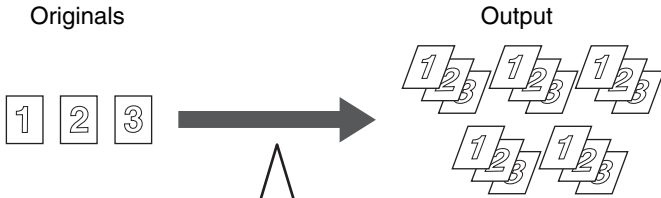

- The sort function is automatically selected when originals are placed in the automatic document feeder.
- When the Quick File Folder for document filing is full, copying of a large number of originals using the sort function will be affected. Delete unneeded files from the Quick File Folder.

Group mode

This function groups copies by page.

Example: Groups of 5 copies of each page

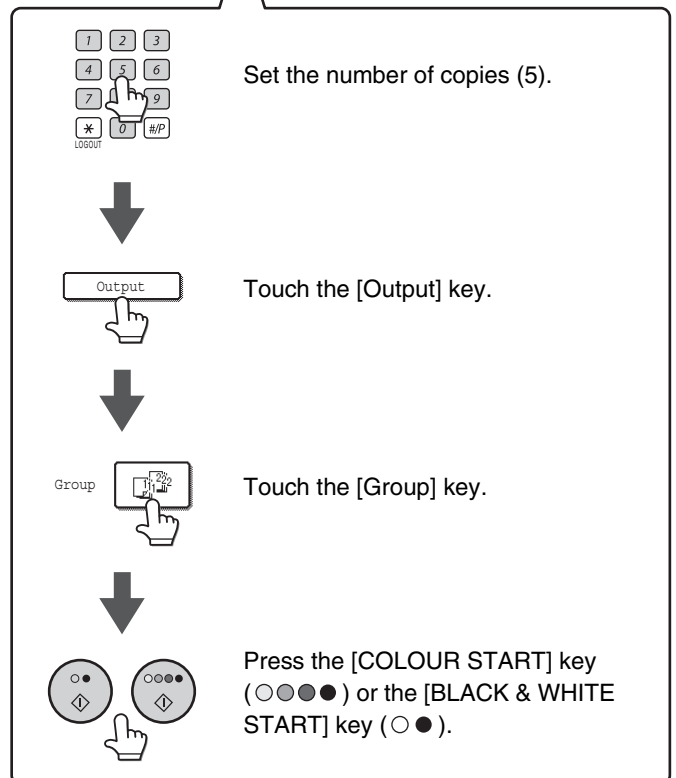
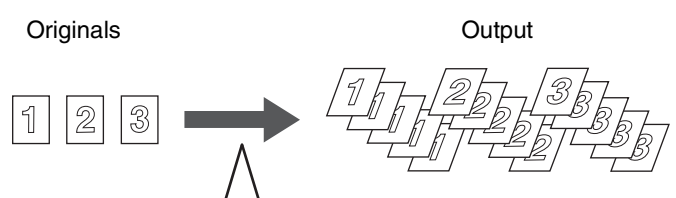

- The group function is automatically selected when an original is placed on the document glass.

Offset function

This function offsets each set of copies from the previous set in the output tray, making it easy to separate sets of copies.

Offset function "ON"

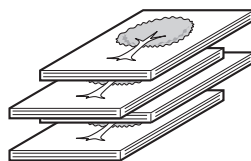

Offset function "OFF"

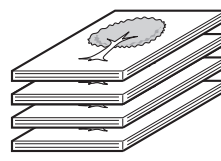

- The offset function cannot be used in the right tray.
- The offset function cannot be selected when the staple sort function is selected.









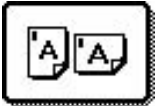

Staple sort function / Saddle stitch function

The staple sort function sorts output into sets, staples each set, and delivers the sets to the tray. The saddle stitch function staples each set in 2 places at the centreline and folds the stapled set.

The relations between the stapling positions, paper orientation, permitted paper sizes for stapling, and number of sheets that can be stapled are shown below.

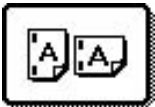
For original placement orientations, see "[Original placement orientation \(for the staple sort and punch functions\)](#)" (page 45).

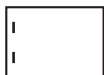
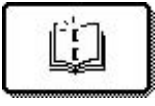
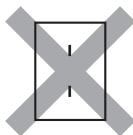

Stapling positions	Vertically-oriented paper	Horizontally-oriented paper
One staple at top left corner 		
One staple at bottom left corner 		
Two staples at left edge 		
Saddle stitch (only with saddle stitch finisher) 		

* Two 209 g/m² (56 lbs.) sheets can be inserted as covers and stapled (only 1 sheet when saddle stitch is used). When this is done, the number of sheets that can be used is two less (one less for saddle stitch) than the stated maximum.

- When Mixed Size Original in the special modes is used with the "Same Width" setting, the maximum number of sheets that can be stapled is 25 for a saddle stitch finisher or 30 for a finisher regardless of the paper size.
- The saddle stitch function can only be used when a saddle stitch finisher is installed.

Punch function

If an optional punch module is installed, holes can be punched in output.

Paper that can be punched is A3 to B5R (60 to 209 g/m²) (11" x 17" to 8-1/2" x 11" (16 lbs. to 56 lbs.)).

A3W (12" x 18") sized paper, transparency film, tab paper and other special types of paper cannot be used.

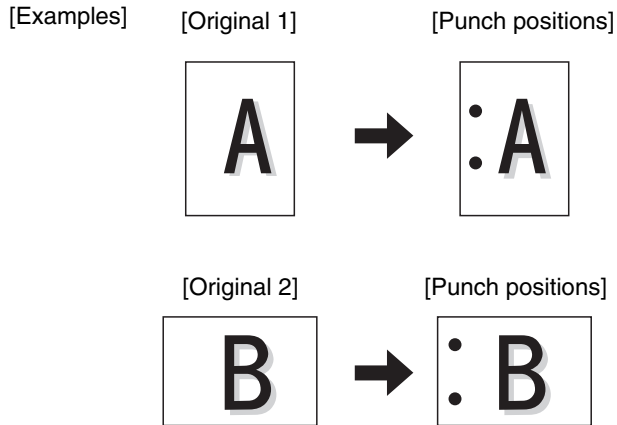

The saddle stitch and hole punch functions cannot be selected at the same time.

Original placement orientation (for the staple sort and punch functions)

When using the staple sort function or the punch function, the original must be placed as shown below to enable stapling or punching in the desired position on the paper.

Staple sort		Punch	
Document feeder tray	Document glass	Document feeder tray	Document glass
		/	

MAKING COPIES USING THE BYPASS TRAY (Copying on special papers)

In addition to plain paper, the bypass tray allows you to make copies on transparency film, tab paper, and other special papers.

For detailed information on paper that can be loaded in the bypass tray, see the Safety Guide. For precautions and other important information when loading paper in the bypass tray, see "LOADING PAPER IN THE BYPASS TRAY" in the User's Guide.

1

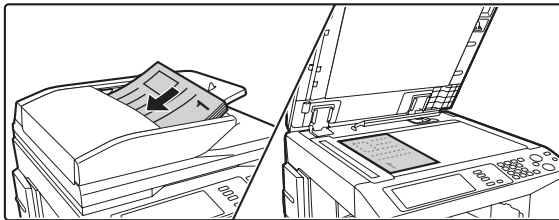

Place the original.

Place the original face up in the document feeder tray, or face down on the document glass.

2

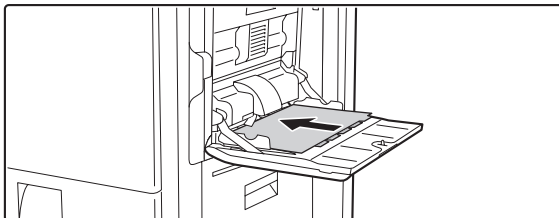

Place paper in the bypass tray.

Insert the paper with print side face down.

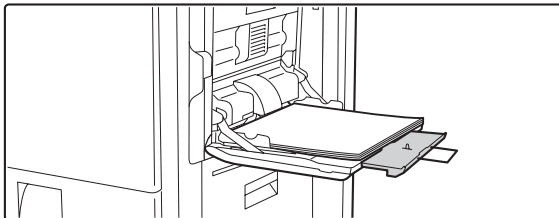

When loading paper larger than A4R or 8-1/2" x 11"R, be sure to pull out the bypass tray extension. Pull the bypass tray extension all the way out. If the bypass tray extension is not pulled all the way out, the size of the loaded paper will not be correctly displayed.

3

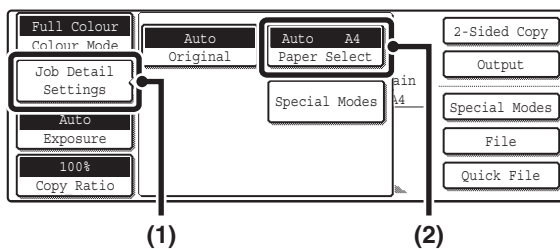

Open the paper settings screen.

- (1) Touch the [Job Detail Settings] key.
- (2) Touch the [Paper Select] key.

4

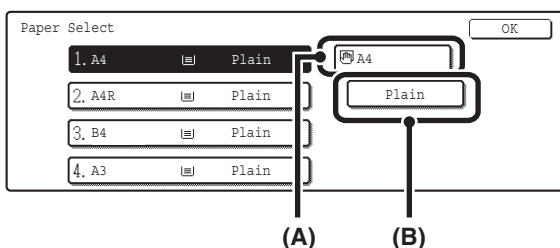

Set the type and size of paper loaded in the bypass tray.

- (A) Shows the size of paper loaded in the bypass tray.
(B) The currently selected paper type will be displayed.

If you wish to use the paper size and paper type shown in (A) and (B), touch (A) and touch the [OK] key. Go to step 8. To change the paper size or paper type, touch (B) and go to the next step.

5

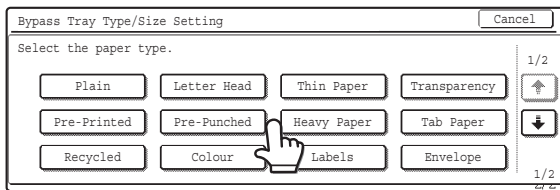

Select the type of paper used in the bypass tray.

Select the paper type used.

6

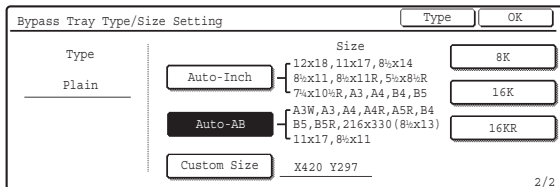

Set the paper size.

To use a paper size used in China on the MX-2300/2700 series, touch the [8K], [16K], or [16KR] key to select the paper size.

On the MX-3500/4500 series, touch the [Manual] key, touch the [8K], [16K], or [16KR] key in the screen that appears, and then touch the [OK] key.

[Auto-Inch] key

Touch this key when the loaded paper is an inch size (8-1/2" x 11", etc.). When the paper placed in the bypass tray is an inch size, the paper size will be detected automatically and an appropriate size set.

[Auto-AB] key

Touch this key when the loaded paper is an AB size (A4, etc.). When the paper inserted in the bypass tray is an AB size, the paper size will be detected automatically and an appropriate size set.

[Custom Size] key

Touch this key when you know the size of the inserted paper but it is not one of the inch or AB sizes.

When the key is touched, the paper size entry screen appears.

To set a paper size in millimetres, touch the [AB] tab.

To set a paper size in inches, touch the [Inch] tab.

Touch the [X] key and enter the horizontal dimension of the paper with the \downarrow \uparrow keys, and then touch the [Y] key and enter the vertical dimension. When finished, touch the [OK] key.

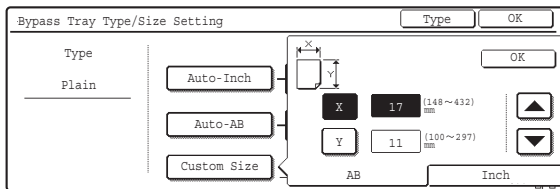

7

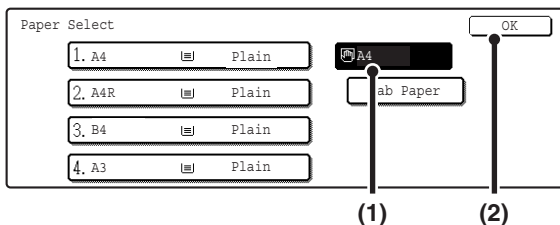

Select the bypass tray.

(1) Touch the paper size key of the bypass tray.

(2) Touch the [OK] key.

When the [OK] key is touched, you will return to the job detail setting screen. Touch the [Job Detail Settings] key to return to the base screen of copy mode.

8

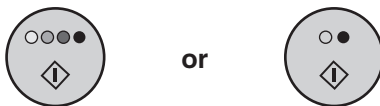

Press the [COLOUR START] key (○●●●) or the [BLACK & WHITE START] key (○●).

Scanning begins.

- If the originals were placed in the document feeder tray, the originals are copied.
- If you placed the original on the document glass, scan each page one page at a time. If you are using the sort function or other function that requires all originals to be scanned before the copies are printed, you must use the same [START] key that you used to scan the first original to scan each of the remaining originals.



To cancel scanning of the original and copying...

Press the [STOP] key (⏏).

INTERRUPTING A COPY RUN (Interrupt copy)

When you need to make an urgent copy and the machine is busy with a long copy run or other job, use interrupt copy. Interrupt copy temporarily stops the job in progress and lets you perform the interrupt copy job.

1

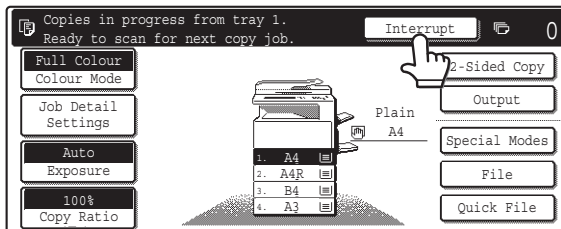

Touch the [Interrupt] key.

2

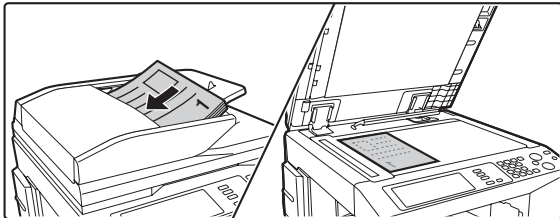

Place the original.

Place the original face up in the document feeder tray, or face down on the document glass.

3

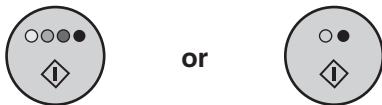

Select copy settings for the interrupt copy job and start copying.

The interrupt copy job begins.

4

 To cancel scanning of the original and copying...
Press the [STOP] key (⏏).

After the interrupt copy job is printed, the job that was interrupted resumes.

- If user authentication is enabled, the login screen will appear when the [Interrupt] key is pressed. Enter your user name and password to log in. The number of copies made will be added to the count of the user that logged in.
- Depending on the settings of the job in progress, the [Interrupt] key may not appear.
- Depending on the settings of the job in progress, the [Reserve] key may appear instead of the [Interrupt] key. Unlike interrupt copy, reserve copy does not temporarily stop the job in progress. Instead, the reserve copy job begins when the job in progress is finished.
- Interrupt copy cannot be used in combination with the following special modes:
Job Build, Tandem Copy, Book Copy, Card Shot, Multi-Page Enlargement, Proof Copy
- If the document glass is used for an interrupt copy job, 2-sided copying, sort copying, and staple sort copying cannot be selected. If any of these functions are necessary, use the automatic document feeder.

JOB STATUS SCREEN

The job status screen is displayed when the [JOB STATUS] key on the operation panel is pressed. The job status screen shows the status of jobs by mode. When the [JOB STATUS] key is pressed, the job status screen of the mode that was being used before the key was pressed appears.

Example: Pressing the key in copy mode

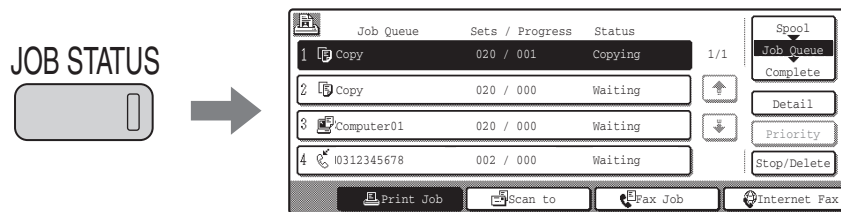

The left edge of the job status screen appears at the left edge of the touch panel screen. The left edge of the job status screen can be touched to display the job status screen.

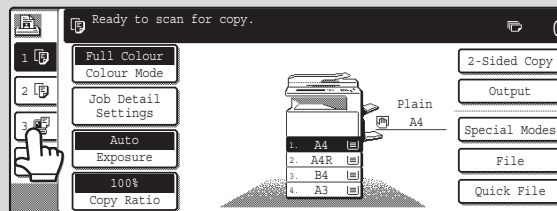

JOB QUEUE SCREEN AND COMPLETED JOB SCREEN

The job status screen consists of the job queue screen that shows copy and print jobs waiting to be printed and the job currently in progress, the completed job screen that shows jobs that have been completed, and the spool screen that shows print jobs that have been spooled and encrypted PDF jobs that are waiting to be printed. This section explains the job queue screen and the completed jobs screen, which are related to copy mode. The job status screen switches between the job queue screen and the completed jobs screen each time the job status screen selector key is touched.

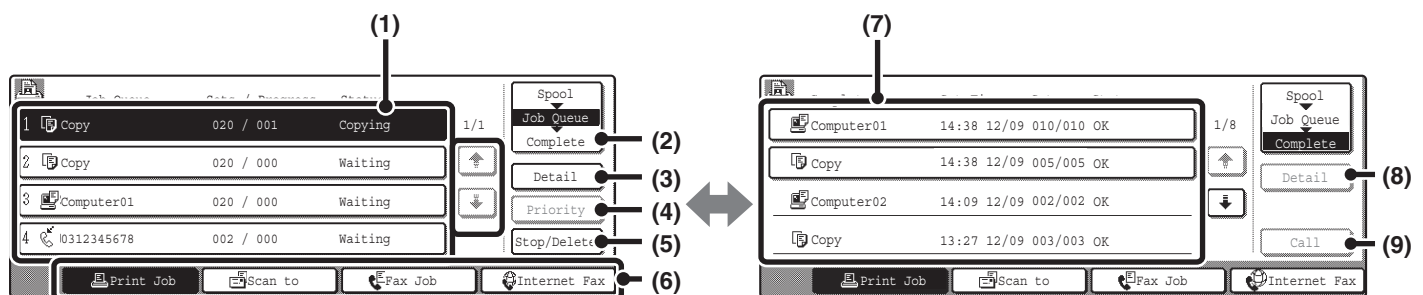

(1) Job list (job queue screen)

This shows the jobs that are waiting to be printed and the job in progress as keys (job keys). The jobs are printed in order from the job at the top of the queue. Each job key shows information on the job and the current status of the job.

(2) Job status screen selector key

Touch this key to switch through the job queue screen, the completed jobs screen, and the spool screen.

(3) [Detail] key (job queue screen)

Touch this key to display detailed information on a job.

(4) [Priority] key

Touch this key to give priority to a selected job.

(5) [Stop/Delete] key

Touch this key to stop or delete a selected job.

(6) Mode switch keys

Use these keys to select the mode that is shown in the job status screen.
The status of copy jobs can be checked by touching the [Print Job] key.

(7) Job list (completed jobs screen)

This shows up to 99 completed jobs. The result (status) of each completed job is shown. Copy jobs that used the document filing function are indicated as keys.

(8) [Detail] key (completed jobs screen)

When a job is shown as a key in the job list, the [Detail] key can be touched to show detailed information on the job.

(9) [Call] key

Touch this key to call up and use a copy job stored using the document filing function.



For information on the spool screen, see the Printer Guide.

Job key display

Each job key shows the position of the job in the job queue and the current status of the job.

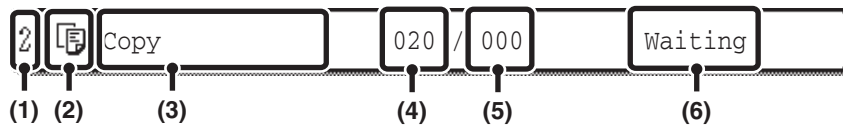

(1) Indicates the number (position) of the job in the job queue.

When the job currently being printed is finished, the job moves up 1 position in the job queue.

(2) Mode icon

The  icon appears when the job is a copy job.

(3) Job name

"Copy" appears for a copy job.
When user authentication is enabled, the name of the user that performed the job appears.

(4) Number of copies (sets) entered

This shows the number of copies (sets) specified.

(5) Number of completed copies

This shows the number of copies (sets) completed.
"000" appears while the job is waiting in the job queue.

(6) Job Status

Shows the job status.

Message	Status
"Copying"	Copying is in progress.
"Waiting"	The job is waiting to be printed.
"Paper Empty"	The paper used for the job has run out. Add paper or change to a different paper tray.
"Error"	An error occurred while the job was being executed. Clear the error condition.

Canceling a job that is waiting in the queue

To cancel a job that is waiting in the queue, touch the job key and then the [Stop/Delete] key. The following screen will appear. Touch the [Yes] key.

The job will be deleted from the queue.

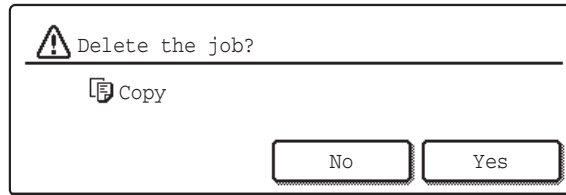

If the job in progress is a copy job, you can also press the [STOP] key (⏹) to display the above screen. To cancel, touch the [Yes] key.

Giving priority to a job in the queue

If a copy job is performed when there are already multiple jobs in the queue, the copy job will appear at the end of the queue. However, if you have an urgent copy job, you can give priority to the job and have it executed first.

Touch the key of the urgent job and then touch the [Priority] key. The job will move to the top of the queue and copying will begin.

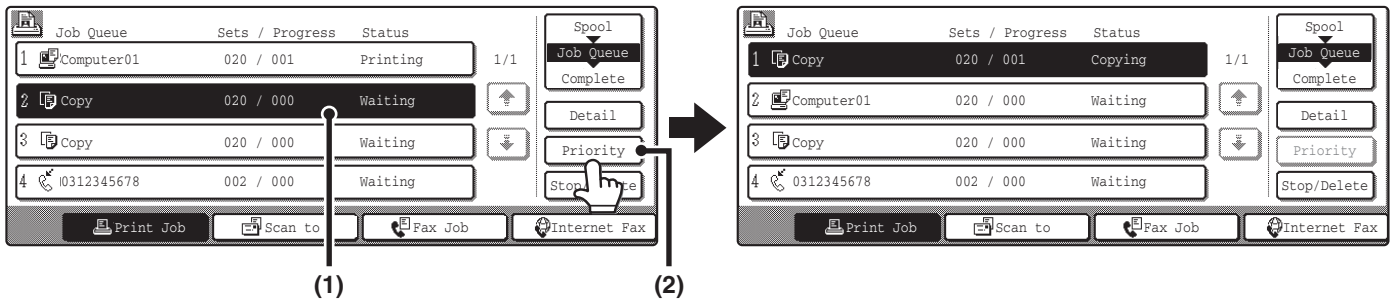

The job that was in progress will be moved to the second position in the queue and will wait. The job will resume when the priority job is finished.

Checking information on a copy job waiting in the queue

Detailed information can be displayed on a copy job waiting in the queue.

Touch the key of the job that you wish to check and then touch the [Detail] key. The job information screen will appear.

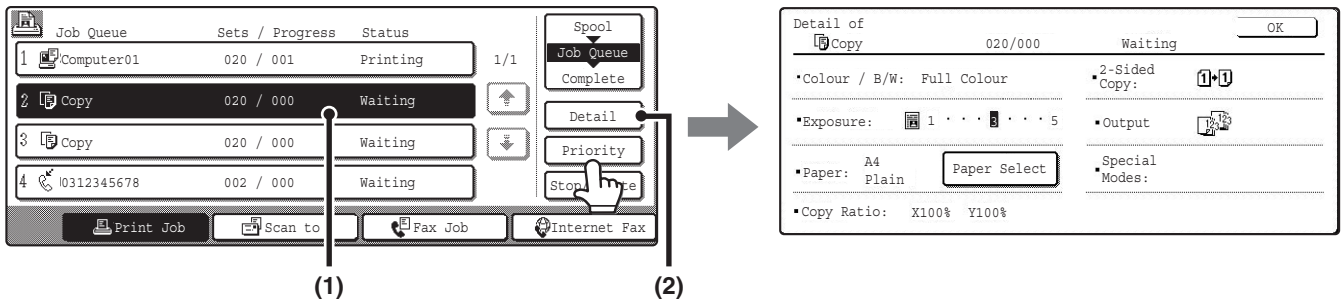

[Paper Select] key

If a copy job is stopped because the paper ran out, the [Paper Select] key can be pressed to change to a different paper tray.

When the [Paper Select] key is pressed, the paper tray selection screen appears.

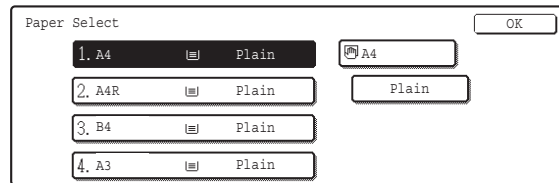

Touch the tray that has the size of paper that you wish to use and then touch the [OK] key. The stopped copy job will resume.

WHEN THE DOCUMENT FILING FUNCTION IS USED

When a copy job has been saved using the [Quick File] key or [File] key of the document filing function, the job can be called up and reused from the job status screen.

Touch the job status screen selector key to display the completed jobs screen.

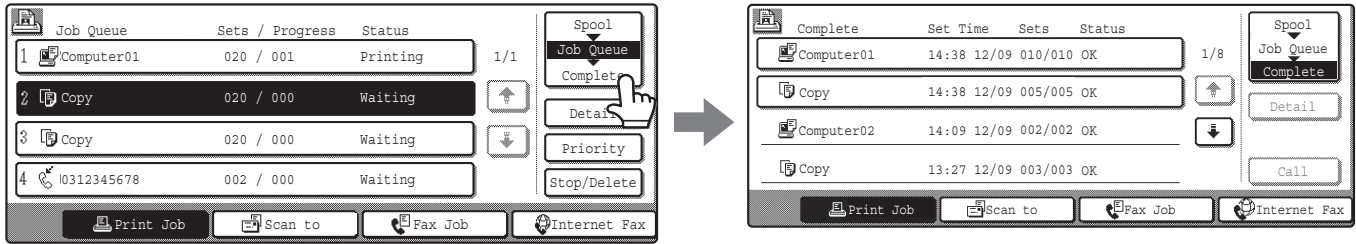

Copy jobs saved with the document filing function will appear as keys. To call up and reuse a job, touch the job key and then the [Call] key. The job selection screen of the document filing function will appear.

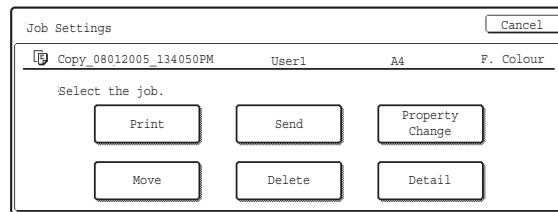

Manipulate the job from this screen. For more information on manipulating called up jobs, see the Document Filing Guide.



If you touch a key in the job list followed by the [Detail] key, the following screen will appear.

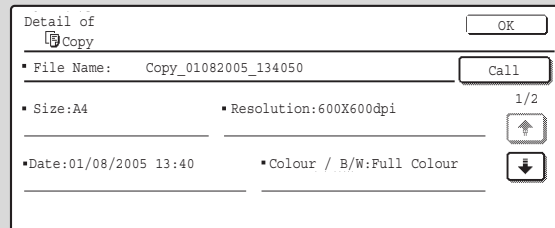

The [Call] key can be touched in this screen to open the job selection screen of the document filing function.

2

CONVENIENT COPY FUNCTIONS

This chapter explains special-purpose functions, storing of copy settings, and other convenient functions.

SPECIAL MODES

There are 2 ways to open the special modes screen from the base screen of copy mode.

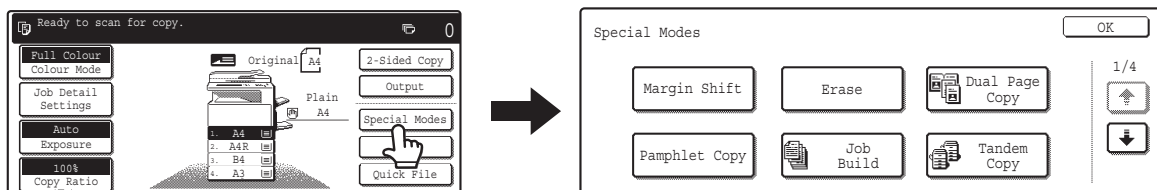

1. Touch the [Special Modes] key in the base screen of copy mode.

The explanations in this guide generally assume that this method is used.

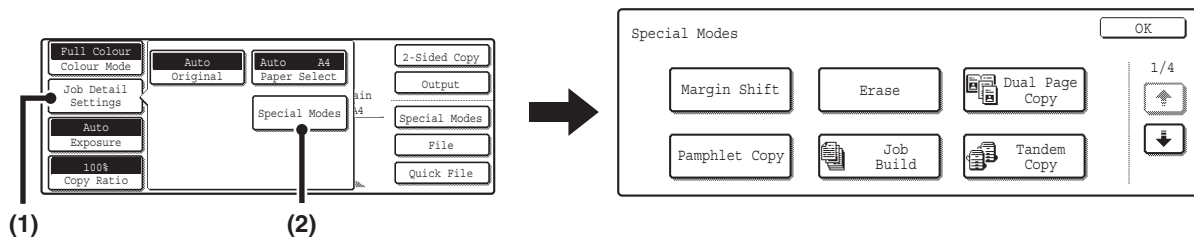

2. Touch the [Job Detail Settings] key in the base screen of copy mode and then touch the [Special Modes] key in the job detail settings screen.



Use either method to open the special modes screen. The same screen appears regardless of which method is used. The special modes screen consists of four screens. Use the   keys to switch through the screens.



- The displayed menu will vary depending on the country and regions.
- The displayed menu will vary depending on the equipment installed.

1st screen

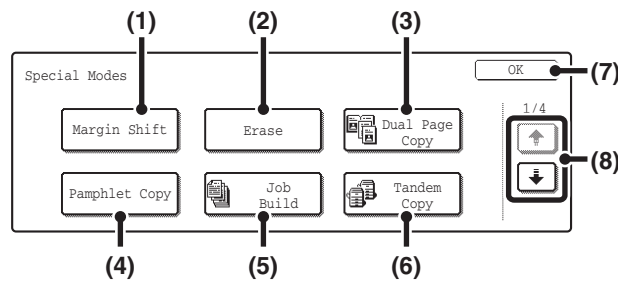

(1) [Margin Shift] key

Use this to shift the image on the paper to create binding margins.

➤ [ADDING MARGINS \(Margin Shift\)](#) (page 59)

(2) [Erase] key

This is used to erase peripheral shadows that occur when making copies of books and thick originals.

➤ [ERASING PERIPHERAL SHADOWS \(Erase\)](#) (page 61)

(3) [Dual Page Copy] key

This is used to make separate copies of the left and right pages of a book or other bound document.

➤ [COPYING EACH FACING PAGE OF A BOUND DOCUMENT \(Dual Page Copy\)](#) (page 63)

(4) [Pamphlet Copy] key

This is used to make pamphlet-style copies of 1-sided or 2-sided originals.

➤ [MAKING COPIES IN PAMPHLET FORMAT \(Pamphlet Copy\)](#) (page 65)

(5) [Job Build] key

When you have a very large number of originals, this can be used to scan the originals in separate sets.

➤ [COPYING A LARGE NUMBER OF ORIGINALS AT ONCE \(Job Build\)](#) (page 69)

(6) [Tandem Copy] key

Two machines connected to the same network can be used to run a large copy job in parallel.

➤ [USING TWO MACHINES TO COPY A LARGE NUMBER OF ORIGINALS \(Tandem Copy\)](#) (page 71)

(7) [OK] key

Touch this to close the special modes screen.

(8) [Up/Down] keys

Touch these to switch through the special modes screens.

2nd screen

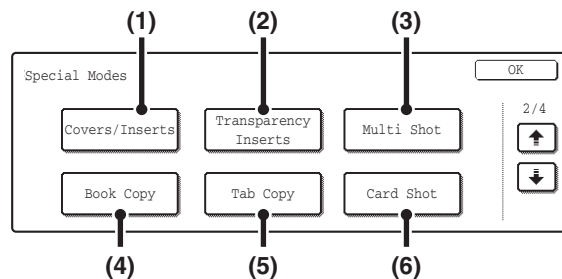

(1) [Covers/Inserts] key

Front covers, back covers, and inserts can be added. The covers and inserts can be copied on.

➤ [USING A DIFFERENT PAPER TYPE FOR COVERS \(Covers/Inserts\)](#) (page 74)

(2) [Transparency Inserts] key

Inserts can be automatically inserted between sheets of transparency film.

➤ [ADDING INSERTS WHEN COPYING ON TRANSPARENCY FILM \(Transparency Inserts\)](#) (page 85)

(3) [Multi Shot] key

Multiple original pages can be copied onto a single sheet of paper in a uniform layout.

➤ [COPYING MULTIPLE PAGES ONTO ONE SHEET OF PAPER \(Multi Shot\)](#) (page 88)

(4) [Book Copy] key

Books and other bound originals can be copied pamphlet style.

➤ [COPYING A PAMPHLET \(Book Copy\)](#) (page 91)

(5) [Tab Copy] key

Use this to copy onto the tabs of tab paper.

➤ [COPYING CAPTIONS ONTO TAB PAPER \(Tab Copy\)](#) (page 95)

(6) [Card Shot] key

The front and reverse sides of a card can be copied onto one sheet of paper.

➤ [COPYING BOTH SIDES OF A CARD ON ONE SHEET OF PAPER \(Card Shot\)](#) (page 99)

3rd screen

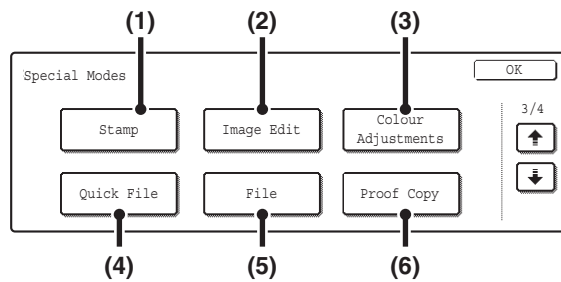

(1) [Stamp] key

Use this to print the date, a stamp, the page number and/or text on copies.

➤ [PRINTING THE DATE AND A STAMP ON COPIES \(Stamp\)](#) (page 102)

(2) [Image Edit] key

Touch this key to display the image edit menu screen. This allows you to select special image editing functions.

➤ [\[Image Edit\] KEY AND \[Colour Adjustments\] KEY](#) (page 57)

(3) [Colour Adjustments] key

Touch this key to display the colour adjustment menu screen. This allows you to select special colour adjustment functions when making colour copies.

➤ [\[Image Edit\] KEY AND \[Colour Adjustments\] KEY](#) (page 57)

(4) [Quick File] key

This saves a job in the Quick File folder of the document filing function. For more information on Quick File, see the Document Filing Guide.

(5) [File] key

This saves a job in a folder of the document filing function. For more information on File, see the Document Filing Guide.

(6) [Proof Copy] key

This feature prints only one set of copies, regardless of how many sets have been specified. After the first set is checked for errors, the remaining sets can be printed.

➤ [CHECKING COPIES BEFORE PRINTING \(Proof Copy\)](#) (page 151)

4th screen

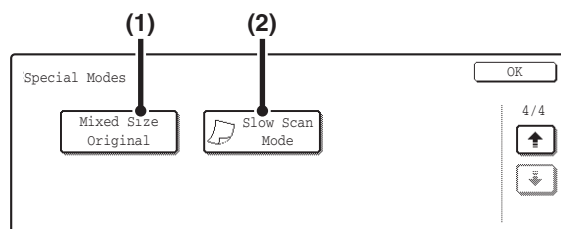

(1) [Mixed Size Original] key

This is used to make copies of mixed size originals. The mixed size originals can be inserted together in the automatic document feeder.

➤ [COPYING ORIGINALS OF DIFFERENT SIZES \(Mixed Size Original\)](#) (page 154)

(2) [Slow Scan Mode] key

This is used to copy thin-paper originals using the automatic document feeder.

➤ [COPYING THIN ORIGINALS \(Slow Scan Mode\)](#) (page 157)

 Special modes can generally be combined with other special modes, however, there are some combinations that are not possible. If a prohibited combination of special modes is selected, a message will appear on the touch panel.

[Image Edit] KEY AND [Colour Adjustments] KEY

A menu screen appears when the [Image Edit] key or [Colour Adjustments] key is touched in the 3rd special modes screen.

Image edit menu screen

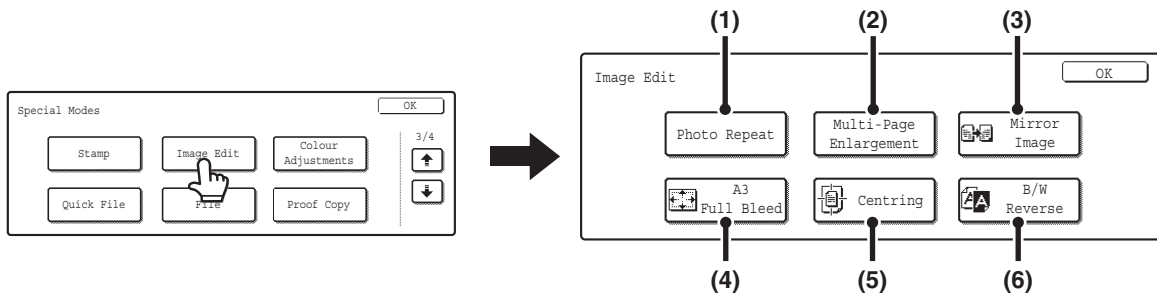

(1) [Photo Repeat] key

This prints repeated copies of a photo on a single sheet of paper.

🔗 [REPEATING PHOTOS ON A COPY \(Photo Repeat\)](#) (page 124)

(2) [Multi-Page Enlargement] key

This enlarges an original image and prints it as a composite image using multiple sheets of paper.

🔗 [CREATING A LARGE POSTER \(Multi-Page Enlargement\)](#) (page 127)

(3) [Mirror Image] key

This is used to print a mirror image of the original.

🔗 [REVERSING THE IMAGE \(Mirror Image\)](#) (page 130)

(4) [A3 Full Bleed] key ([11x17 Full Bleed] key)

This is used to copy an entire A3 (11" x 17") original at full size without the cutting off the edges.

🔗 [COPYING A3 \(11" x 17"\) SIZE ORIGINAL WITHOUT CUTTING OFF THE EDGES \(A3 \(11x17\) Full Bleed\)](#) (page 132)

(5) [Centring] key

This is used to centre the copied image on the paper.

🔗 [COPYING IN THE CENTRE OF THE PAPER \(Centring\)](#) (page 135)

(6) [B/W Reverse] key

This is used to reverse black and white in a copy to create a negative image. This function can only be used for black and white copying.

🔗 [REVERSING BLACK AND WHITE IN A COPY \(B/W Reverse\)](#) (page 137)

Colour adjustments menu screen

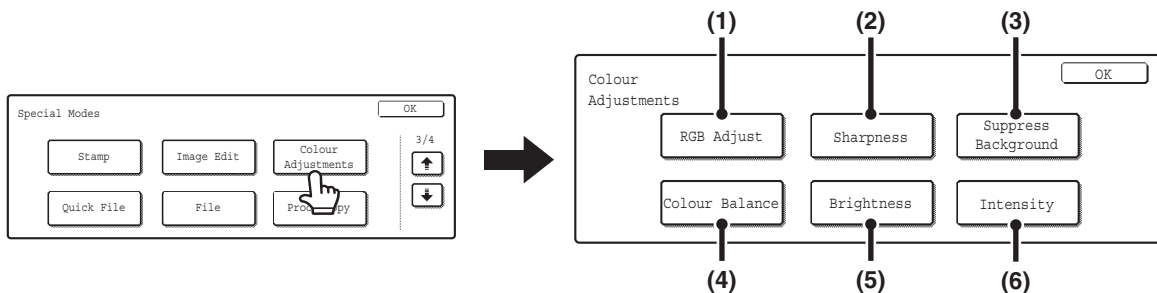

(1) [RGB Adjust] key

This is used to strengthen or weaken one of the three primary colours, red (R), green (G), or blue (B).

🔗 [ADJUSTING RED/GREEN/BLUE IN COPIES \(RGB Adjust\)](#) (page 139)

(2) [Sharpness] key

This is used to sharpen an image or make it softer.

🔗 [ADJUSTING THE SHARPNESS OF AN IMAGE \(Sharpness\)](#) (page 141)

(3) [Suppress background] key

This is used to suppress unwanted light background areas on copies.

🔗 [WHITENING FAINT COLOURS IN COPIES \(Suppress Background\)](#) (page 143)

(4) [Colour Balance] key

The colour, tone, and density of colour copies can be adjusted.

🔗 [ADJUSTING THE COLOUR \(Colour Balance\)](#) (page 145)

(5) [Brightness] key

This is used to adjust the brightness of colour images.

🔗 [ADJUSTING THE BRIGHTNESS OF A COPY \(Brightness\)](#) (page 147)

(6) [Intensity] key

This is used to adjust the intensity (saturation) of colour images.

🔗 [ADJUSTING THE INTENSITY OF A COPY \(Intensity\)](#) (page 149)

[OK] keys in the special modes screen

Two [OK] keys may appear in the special modes screen. The [OK] keys are used as follows:

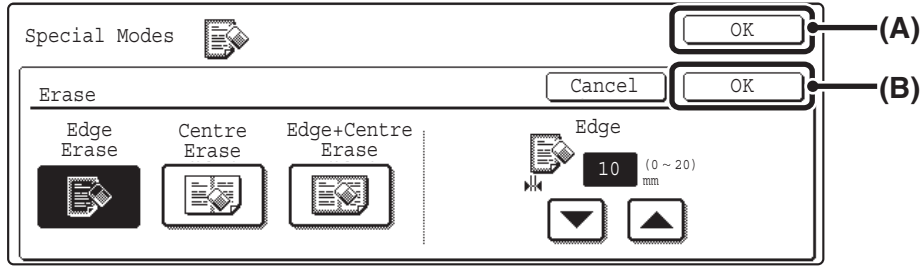

- (A) Enter the selected special mode settings and return to the base screen of copy mode or to the job detail settings screen.
- (B) Enter the selected special mode settings and return to the special modes menu screen. Touch this key when you wish to continue selecting other special mode settings.

Checking which special modes are selected

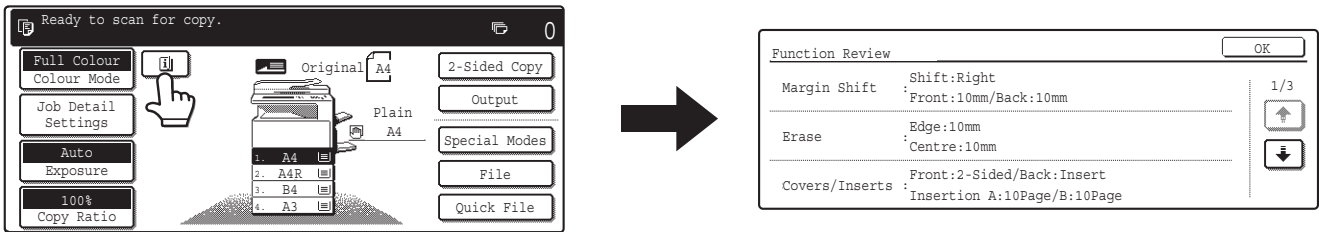

When one or more special modes are selected, the  key appears in the base screen.

The  key can be touched to display a list of the selected special modes.

ADDING MARGINS (Margin Shift)

This function is used to shift the copy image right, left or down to adjust the margin. This is convenient when you wish to bind the copies with a string or in a binder.

Shifting the image to the right so the copies can be bound at the left edge with a string

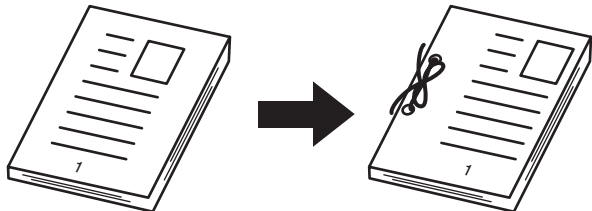

Not using margin shift	Using margin shift
<p>The punch holes cut off part of the image</p>	<p>The image is shifted to the right to allow space for the string holes so the image is not cut off.</p>

Margin shift positions

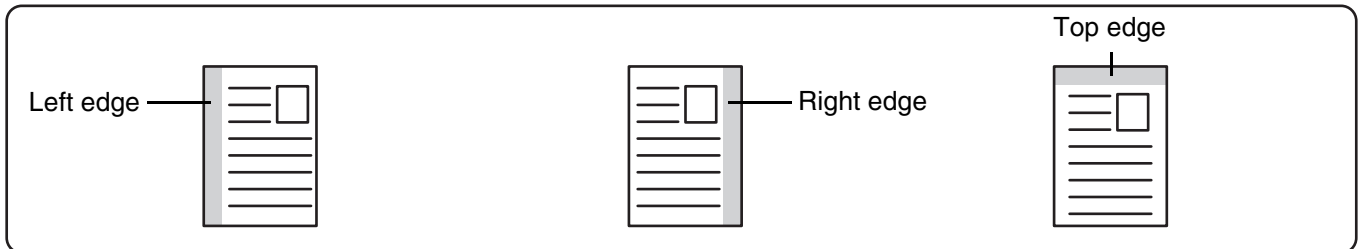

1

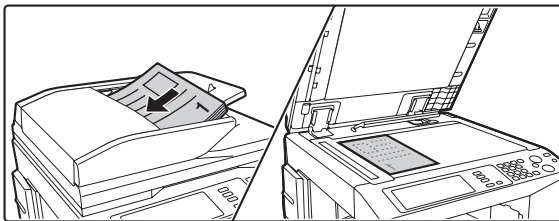

Place the original.

Place the original face up in the document feeder tray, or face down on the document glass.

2

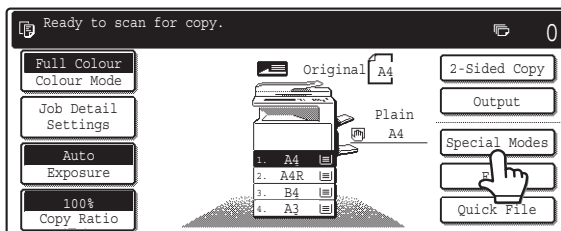

Touch the [Special Modes] key.

3

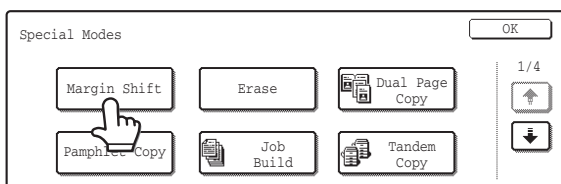

Touch the [Margin Shift] key.

4

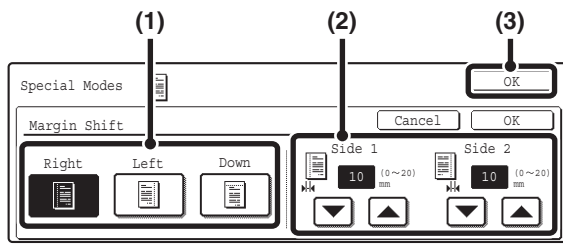

Set the margin shift.

(1) Touch the margin shift position.

Select one of the three positions.

(2) Set the amount of the margin shift with



0 mm to 20 mm (0" to 1") can be entered.

(3) Touch the [OK] key.

You will return to the base screen of copy mode.

5

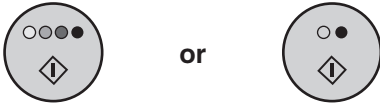

or

Press the [COLOUR START] key (○●●●) or the [BLACK & WHITE START] key (○●).

Copying will begin.

- If the originals were placed in the document feeder tray, the originals are copied.
- If you are using the document glass, copy each page one page at a time. If you are using the sort function or other function that requires all originals to be scanned before the copies are printed, you must use the same [START] key that you used to scan the first original to scan each of the remaining originals.



To cancel scanning of the original and copying...

Press the [STOP] key (⊘).



Rotation copy cannot be used in combination with margin shift.



To cancel the margin shift setting...

Touch the [Cancel] key in the screen of step 4.



System Settings (Administrator): Initial Margin Shift Setting

The default margin shift setting can be set from 0 mm to 20 mm (0" to 1"). The factory default setting is 10 mm ("1/2").

ERASING PERIPHERAL SHADOWS (Erase)

The erase function is used to erase shadows around the edges of copies that occur when copying thick originals or books.

When a thick book is copied...

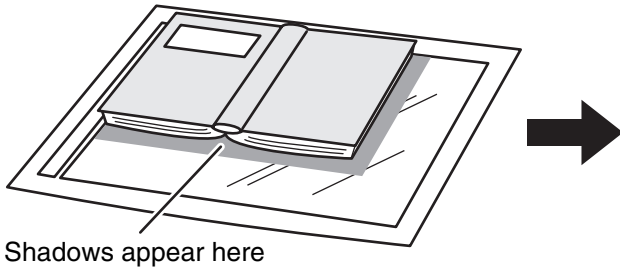

Not using the erase function	Using the erase function
Shadows appear on the copy.	Shadows do not appear on the copy.

Erase modes

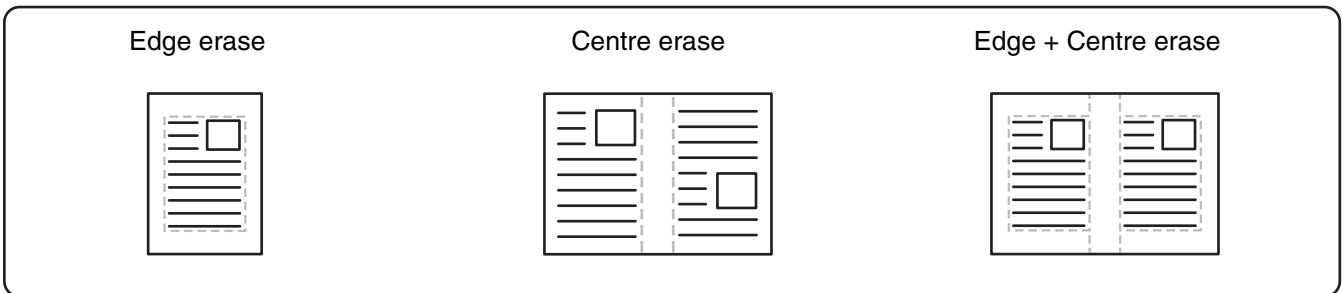

1

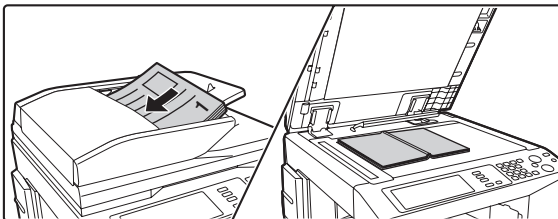

Place the original.

Place the original face up in the document feeder tray, or face down on the document glass.

2

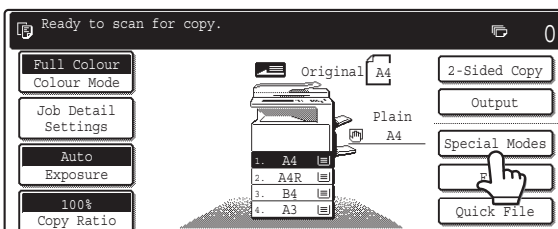

Touch the [Special Modes] key.

3

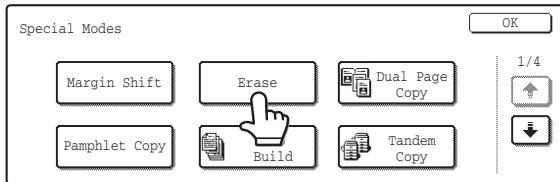

Touch the [Erase] key.

4

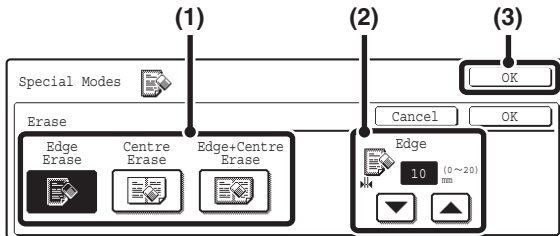

Select the erase settings.

(1) Touch the desired erase mode.

Select one of the three positions.

(2) Set the erasure width with .

0 mm to 20 mm (0" to 1") can be entered.

(3) Touch the [OK] key.

You will return to the base screen of copy mode.

5

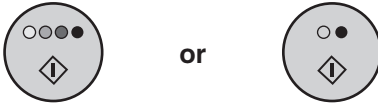

Press the [COLOUR START] key (●●●●) or the [BLACK & WHITE START] key (●●).

Copying will begin.

- If the originals were placed in the document feeder tray, the originals are copied.
- If you are using the document glass, copy each page one page at a time. If you are using the sort function or other function that requires all originals to be scanned before the copies are printed, you must use the same [START] key that you used to scan the first original to scan each of the remaining originals.



To cancel scanning of the original and copying...

Press the [STOP] key (⊘).



When the erase function is used, erase takes place at the edges of the original image. If you also use a ratio setting, the erase width will change according to the selected ratio. For example, if the erase width setting is 20 mm (1") and the copy is reduced to 50%, the erase width will be 10 mm (1/2").



To cancel the erase setting...

Touch the [Cancel] key in the screen of step 4.



System Settings (Administrator): Erase Width Adjustment

The default erase width can be set from 0 mm to 20 mm (0" to 1"). The factory default setting is "10 mm (1/2)".

COPYING EACH FACING PAGE OF A BOUND DOCUMENT (Dual Page Copy)

The dual page copy function produces separate copies of 2 document pages placed side by side on the document glass. This function is useful when making copies of the facing pages of a book or other bound document.

Copying the facing pages of a book or bound document

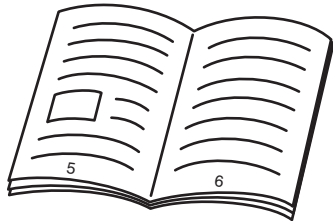

Book or bound document

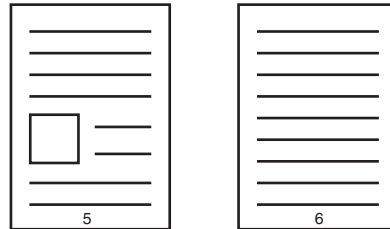

The facing pages are separated into 2 copy pages.

1

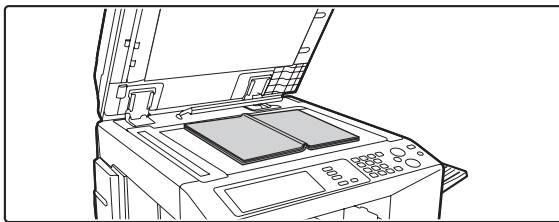

Place the original on the document glass.

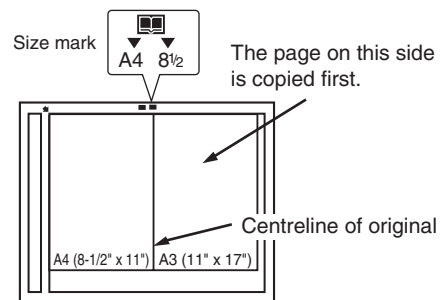

Place the original with the page that you wish to copy first on the right. Align the centreline of the original with the size mark.

2

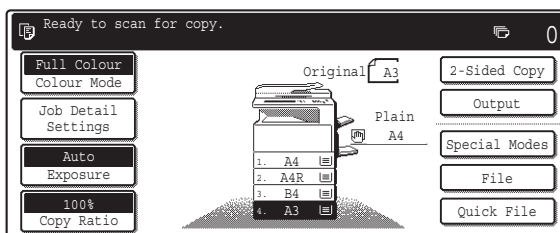

Select A4 (8-1/2" x 11") size paper.

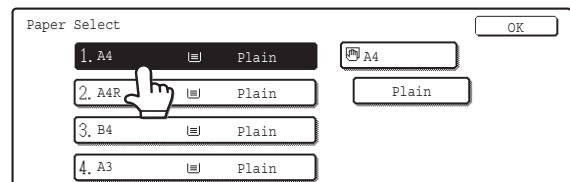

3

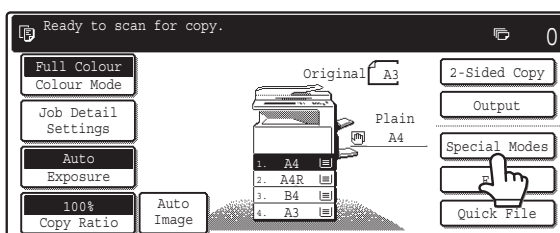

Touch the [Special Modes] key.

4

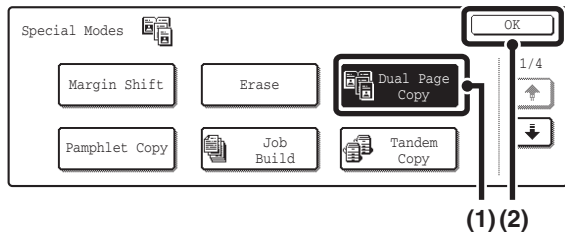

Select Dual Page Copy.

(1) Touch the [Dual Page Copy] key so that it is highlighted.

(2) Touch the [OK] key.

You will return to the base screen of copy mode.

5



or



Press the [COLOUR START] key (○●●●) or the [BLACK & WHITE START] key (○●).

Copying will begin.

If you are using the document glass, copy each page one page at a time. If you are using the sort function or other function that requires all originals to be scanned before the copies are printed, you must use the same [START] key that you used to scan the first original to scan each of the remaining originals.



To cancel scanning of the original and copying...

Press the [STOP] key (⊘).



- When using dual page copy, the original must be placed on the document glass.
- Only A4 (8-1/2" x 11") paper can be used.
- To erase shadows caused by the binding of a book or other bound document, use the erase function.
Note that the centre erase and edge + centre erase modes of the erase function cannot be used with dual page copy.



To cancel dual page copy...

Touch the [Dual Page Copy] key in the screen of step 4 so that it is not highlighted.

MAKING COPIES IN PAMPHLET FORMAT (Pamphlet Copy)

This function copies 2 original pages onto the front side and 2 original pages onto the reverse side of each sheet of paper so that the copies can be folded at the centreline to form a pamphlet.

This function is convenient for arranging copies into an attractive booklet or pamphlet.

Pamphlet copy using 8 original pages

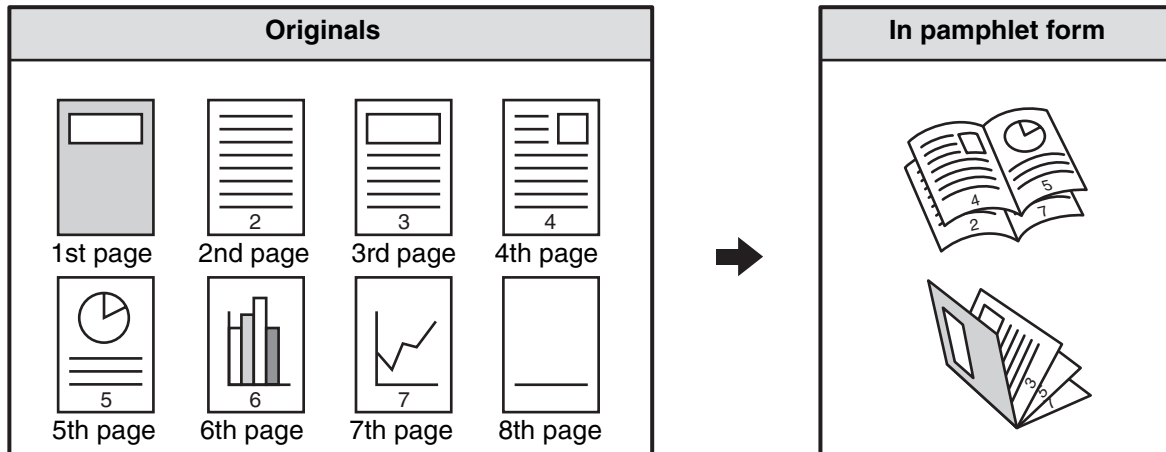

Binding side

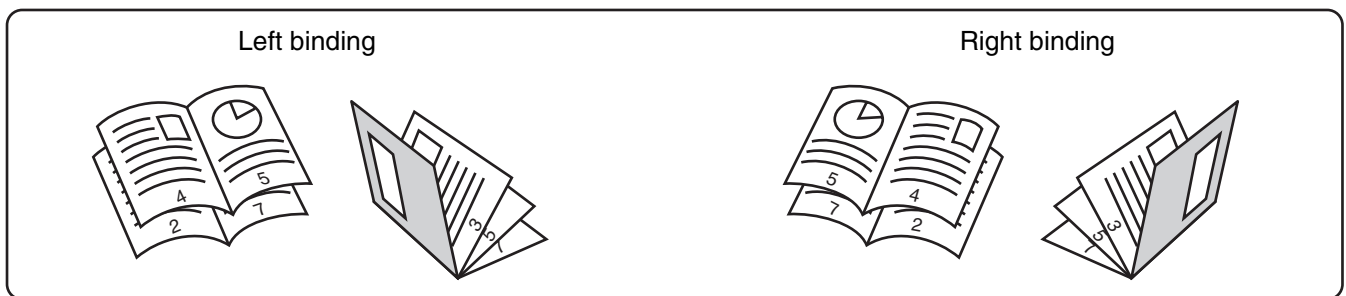

1

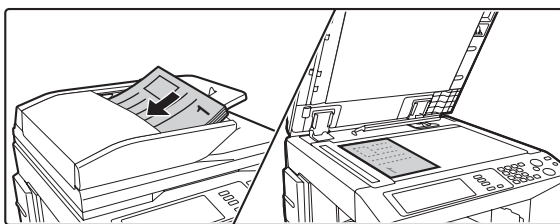

Place the original.

Place the original face up in the document feeder tray, or face down on the document glass.



If the originals are 2-sided, place them in the document feeder tray.

2

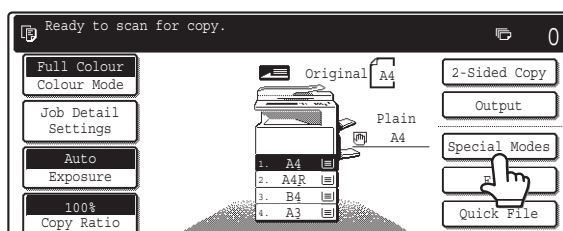

Touch the [Special Modes] key.

3

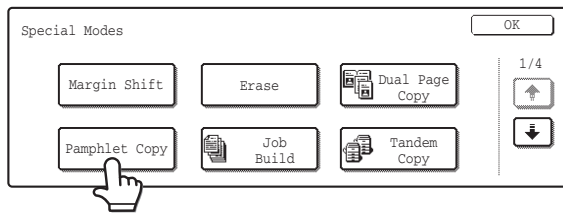

Touch the [Pamphlet Copy] key.

4

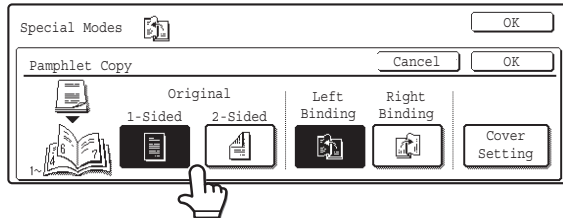

Specify whether the original is a 1-sided or 2-sided original.

5

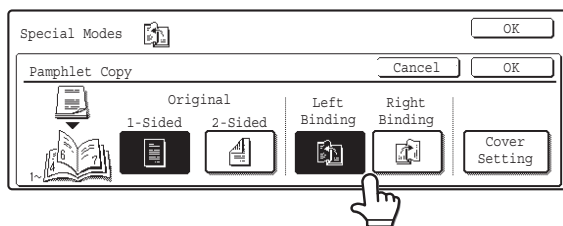

Select the binding edge ([Left Binding] or [Right Binding]).

6

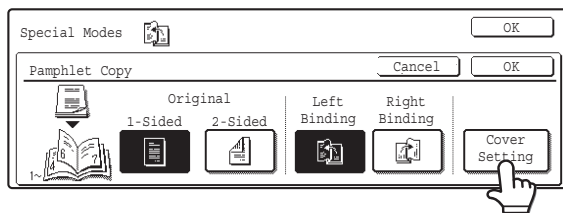

Specify whether or not a cover will be added.

If a different type of paper will be used for the cover, touch the [Cover Setting] key.

If a cover will not be added, go to step 10.

7

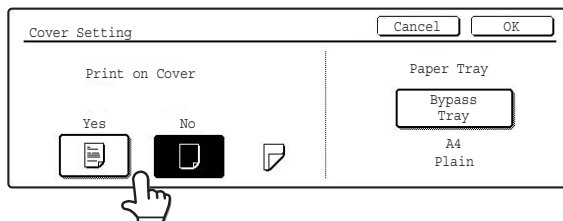

If the cover sheet will be copied on, touch the [Yes] key. Otherwise, touch the [No] key.

8

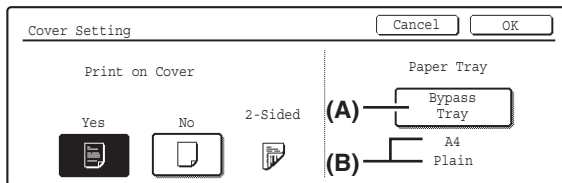

Select the paper tray for the cover.

(A) The currently selected paper tray for the cover is displayed.
 (B) The size and type of paper in the currently selected tray is displayed.

In the example screen, A4 (8-1/2" x 11") size plain paper is loaded in the bypass tray.

To change the paper tray for the cover, touch the tray selection key. (In the screen example, the "Bypass Tray" display is the tray selection key.)

The tray selection screen appears when the tray selection key is touched. Select the paper tray for the cover in the tray selection screen and touch the [OK] key.

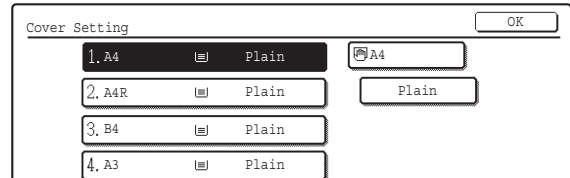

If the cover will be copied on, label sheets, transparency film, and tab paper cannot be used.

9

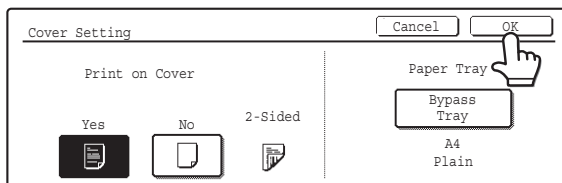

Touch the [OK] key.



To cancel cover settings...
 Touch the [Cancel] key.

10

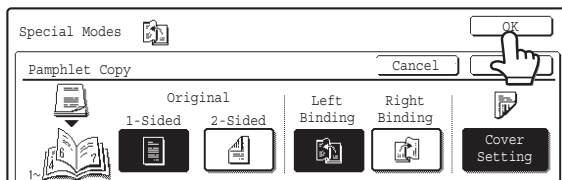

Touch the [OK] key.

You will return to the base screen of copy mode.



or

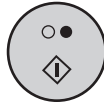

Press the [COLOUR START] key (○●●●) or the [BLACK & WHITE START] key (○●).

Copying will begin.

- If the originals were placed in the document feeder tray, the originals are copied.
- If you are using the document glass, copy each page one page at a time. If you are using the sort function or other function that requires all originals to be scanned before the copies are printed, you must use the same [START] key that you used to scan the first original to scan each of the remaining originals.



To cancel scanning of the original and copying...

Press the [STOP] key (⏹).



- To make pamphlet copies of a book or other bound original, use the book copy function.
- When the pamphlet copy function is selected, 2-sided copying mode is automatically selected. When settings are selected that prevent 2-sided copying, the pamphlet copy function cannot be used.
- Scan the originals in order from the first page to the last page. The order of copying will be automatically adjusted by the machine. Four original pages will be copied onto each sheet of paper. Blank pages may be automatically produced at the end depending on the number of original pages.
- When a saddle stitch finisher is installed, saddle stitch can be used. When pamphlet copy is used in combination with the saddle stitch function and the number of originals is greater than the number of sheets that can be stapled, a message will appear showing the [Cancel] key, the [Continue] key, and the [Divide] key. To cancel the job, touch the [Cancel] key. To make pamphlet copies without stapling, touch the [Continue] key. To divide the pages into sets that can be stapled, touch the [Divide] key.
If you selected settings for adding a cover, it will not be possible to select "Divide". You can either continue pamphlet copying without stapling, or cancel the job.



To cancel pamphlet copy...

Touch the [Cancel] key in the screen of step 4.



System Settings (Administrator): Automatic Saddle Stitch

When a saddle stitch finisher is installed, this setting can be enabled to have saddle stitch take place automatically when the pamphlet copy function is selected.

COPYING A LARGE NUMBER OF ORIGINALS AT ONCE (Job Build)

When copying a very large number of originals, this function allows you to divide the originals into sets and feed each set through the automatic document feeder one set at a time.

Use this function when you wish to copy all of the originals as a single job but the number of originals exceeds the maximum number that can be inserted.

This function is convenient when you wish to sort copies of a large number of originals into multiple sets because all originals are copied as a single job, which saves you the trouble of sorting the copies that would be required if the originals were divided into separate copy jobs.

When scanning the original in sets, divide the sheets so that no set has more than the number of paper that can be loaded and then scan from the set with the first page. The settings that you select for the first set can be used for all remaining sets.

Sorting the copies of a large number of originals into 2 sets

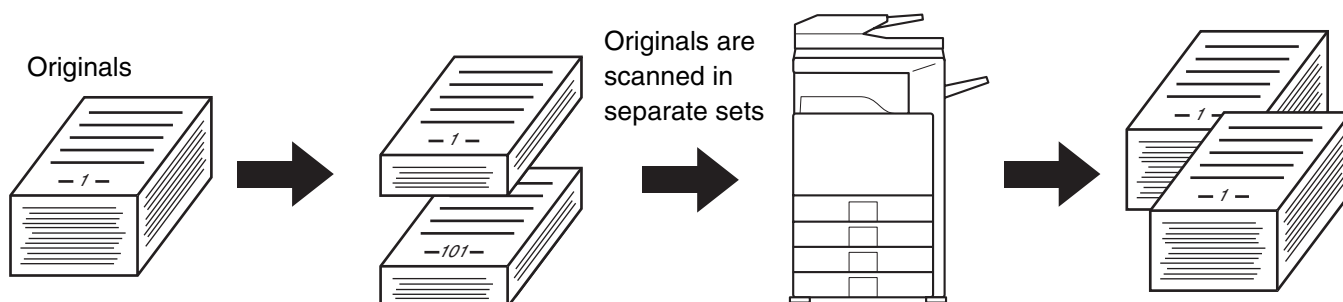

1

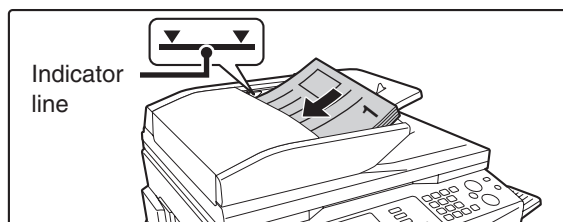

Place the originals face up in the document feeder tray with the edges aligned evenly.

Place the originals face up. Insert the originals all the way into the document feeder tray. The stack must not be higher than the indicator line.

2

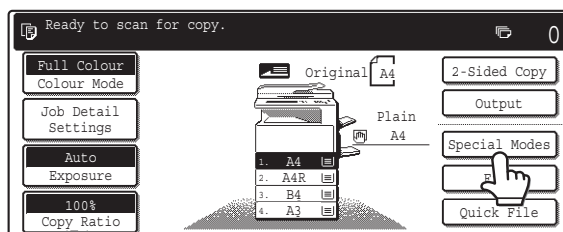

Touch the [Special Modes] key.

3

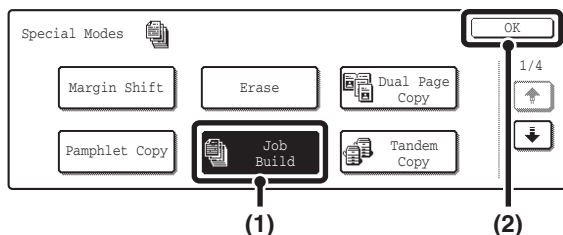

Select Job Build.

(1) Touch the [Job Build] key so that it is highlighted.

(2) Touch the [OK] key.

You will return to the base screen of copy mode.

4

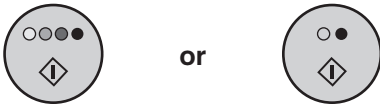

Press the [COLOUR START] key (○●●●) or the [BLACK & WHITE START] key (○●) to scan the first set of originals.

Scanning begins.



To cancel scanning...

Press the [STOP] key (⏏).

5

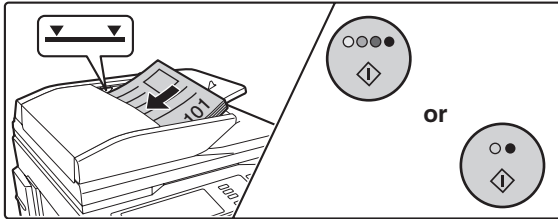

Insert the next set of originals and press the [COLOUR START] key (○●●●) or the [BLACK & WHITE START] key (○●).

You must use the same [START] key that you used to scan the first set of originals to scan each of the remaining sets. Repeat this step until all originals have been scanned.



To cancel scanning...

Press the [STOP] key (⏏).

6

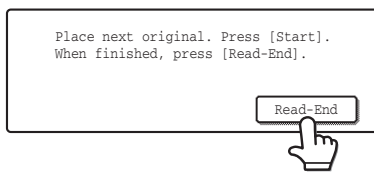

Touch the [Read-End] key.



To cancel copying...

Press the [STOP] key (⏏).



If the Quick File Folder of the document filing function is full, copying in job build mode will be affected. Delete unneeded files from the Quick File Folder.



To cancel the job build setting....

Touch the [Job Build] key in the screen of step 3 so that it is not highlighted.

USING TWO MACHINES TO COPY A LARGE NUMBER OF ORIGINALS (Tandem Copy)

Two machines connected to the same network can be used to run a large copy job in parallel. Each machine prints half of the copies, reducing the time required to complete the job.

Master machine and slave machine

In the following explanation, the master machine is the machine that is used to scan the originals. The slave machine is another machine specified in the master machine that only helps print the copies; it is not used to scan the originals.

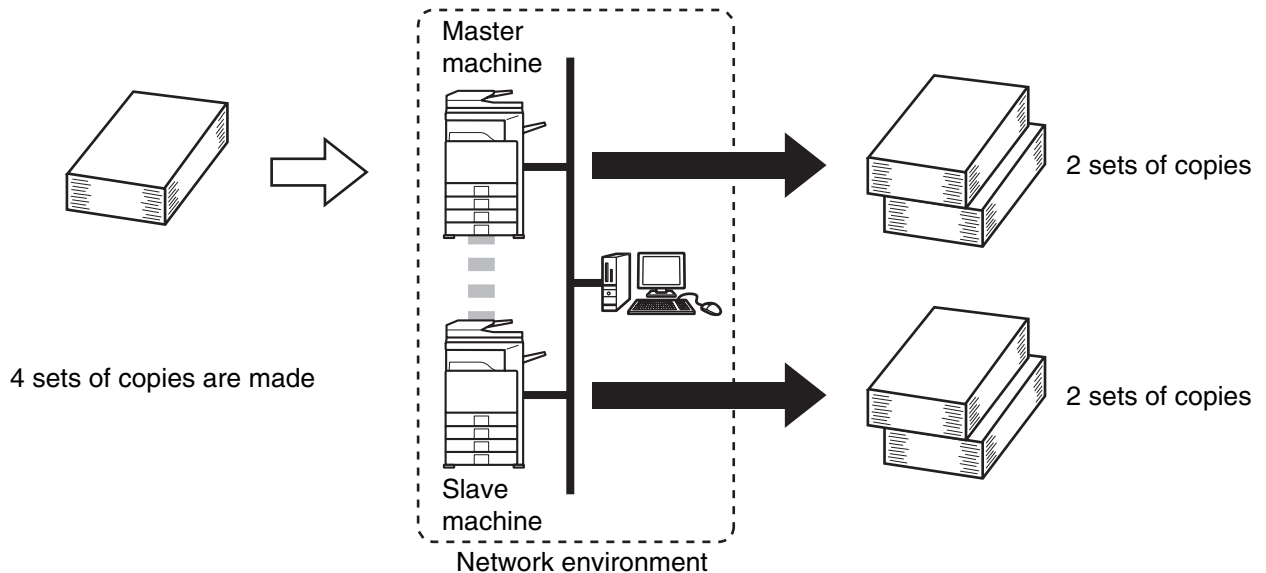

Before using tandem copy

- To use this function, two machines must be connected to your network. Even if more machines are connected to the network, this function can only be used to have one other machine share a job.
- To use the tandem copy function, "Tandem Connection Setting" must be configured in the system settings (administrator).
- When configuring the system settings in the master machine, the IP address of the slave machine is required. For the port number, it is best to use the initial setting (50001). Unless you experience difficulty with this setting, do not change the port number. The tandem settings should be configured by your network administrator. If the master machine and slave machine will change roles, configure the IP address information of the master machine in the slave machine. Both machines can use the same port number.

1

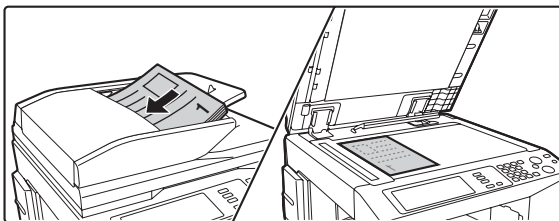

Place the original.

Place the original face up in the document feeder tray, or face down on the document glass.

2

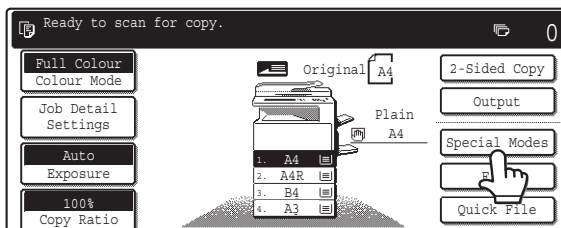

Touch the [Special Modes] key.

3

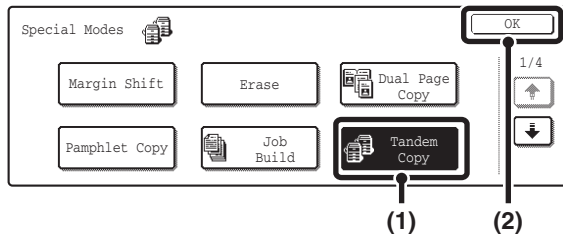

Select tandem copy.

- (1) Touch the [Tandem Copy] key so that it is highlighted.
- (2) Touch the [OK] key.

You will return to the base screen of copy mode.

4

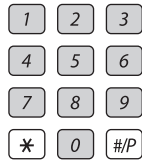

Set the number of copies with the numeric keys.

Up to 999 can be set. When the [COLOUR START] key (○●●●) or the [BLACK & WHITE START] key (○●) is pressed, the copies will automatically be divided between the master and slave machines.

If an odd number of copies is set, the master machine will print the extra set.



If an incorrect number of copies is set...

Press the [CLEAR] key (□) and then enter the correct number.

5

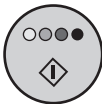

or



Press the [COLOUR START] key (○●●●) or the [BLACK & WHITE START] key (○●).

Copying will begin.

- If the originals were placed in the document feeder tray, the originals are copied.
- If you are using the document glass, copy each page one page at a time. If you are using the sort function or other function that requires all originals to be scanned before the copies are printed, you must use the same [START] key that you used to scan the first original to scan each of the remaining originals.

The following screen appears when the [START] key is pressed.

Starting tandem operation.
Please wait.

After the message appears, tandem copying begins.

If tandem copying is not possible, the following screen appears.

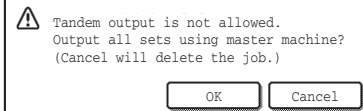

To have the master machine make all copies, touch the [OK] key. To cancel the job, touch the [Cancel] key.



To cancel scanning...

Press the [STOP] key (⊗).

To cancel tandem copying...

Touch the [STOP] keys (⊗) on both the master machine and the slave machine.



In this situation...

A saddle stitch finisher is installed on the master machine but not on the slave machine.

- Copying without stapling: tandem copy is possible.
- Copying with stapling: tandem copy is not possible.

In this way, if tandem copying is executed using a function that the slave machine does not have, a message will appear. To have the master machine make all copies, touch the [OK] key. To cancel the job, touch the [Cancel] key.

If a machine runs out of paper

If either the master machine or the slave machine run out of paper, the machine that ran out of paper will hold the job while the machine that still has paper continues the job. When paper is added to the machine that ran out, the job resumes.

When user authentication is enabled

User authentication is enabled in the master machine: tandem copying is possible.

User authentication is enabled in the slave machine but not in the master machine: tandem copying is not possible.



To cancel tandem copy...

Touch the [Tandem Copy] key in the screen of step 3 so that it is not highlighted.



System Settings (Administrator): Tandem Connection Setting

This must be configured to use the tandem function. This can also be used to disable the tandem function.

USING A DIFFERENT PAPER TYPE FOR COVERS (Covers/Inserts)

A different type of paper can be inserted in positions corresponding to front and back covers of a copy job when the automatic document feeder is used. A different type of paper can also be automatically added as an insert at specified pages.

Example of adding covers

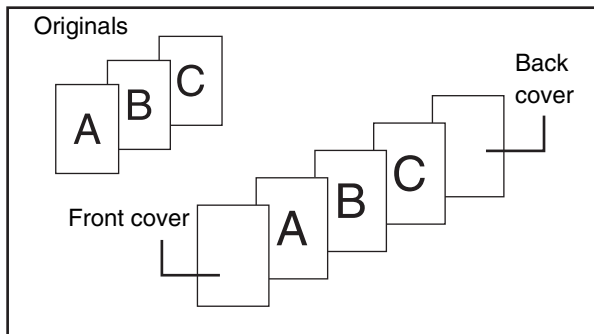

Example of adding inserts

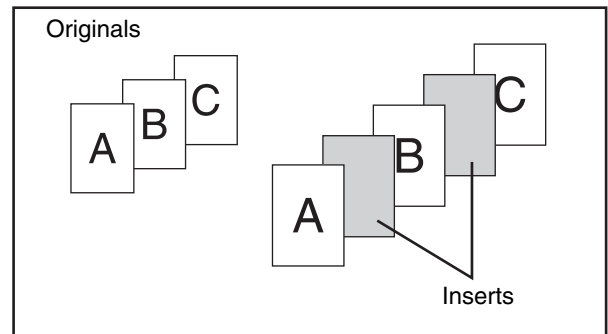

Example of adding covers/inserts

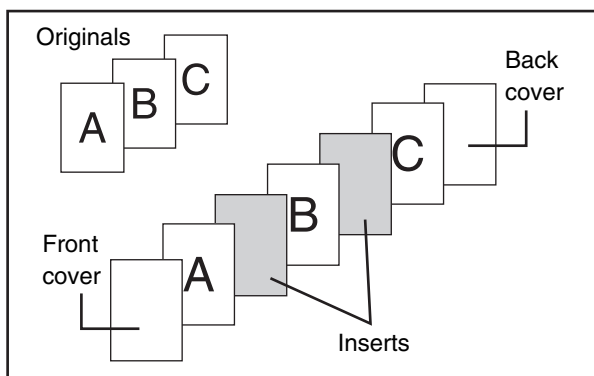

About the explanations of covers and inserts

There are various ways of using covers and inserts. To keep the explanations simple, covers and inserts are explained separately. Refer to "[Examples of covers and inserts](#)" (page 163) as needed.

Preparations for using covers and inserts

- Load the cover/insert paper in the tray before using the cover/insert function.
- Before selecting the cover/insert function, place the originals in the document feeder tray, select 1-sided or 2-sided copying, and select the number of copies and any other desired copy settings. When these settings have been completed, perform the procedure to select covers/inserts.
- The originals must be scanned using the automatic document feeder. The document glass cannot be used.
- Up to 100 cover/insert sheets can be inserted. Note that two insert sheets cannot be inserted between the same pages.
- This function cannot be used in combination with the saddle stitch function.
- When performing 2-sided copying of 2-sided originals, an insert cannot be added between the front and reverse sides of an original page.

INSERTING COVERS IN COPIES (Cover Settings)

A different type of paper can be inserted at the positions corresponding to the front and back covers of a copy job. This is useful for arranging documents in an attractive format and for using a different type of paper as a cover on an estimate sheet.

Covers can be used in combination with inserts.

Copying on a front cover and inserting together with a back cover

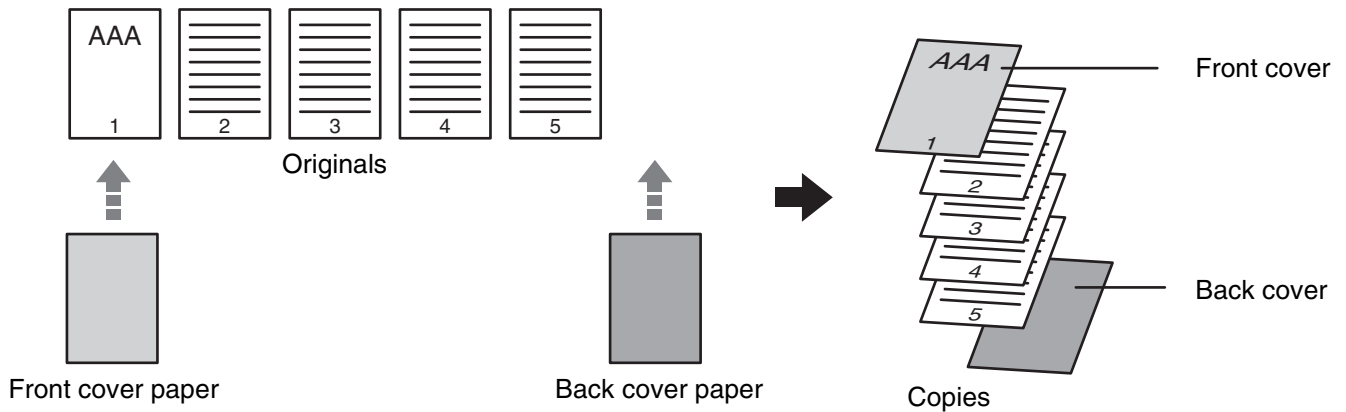

1

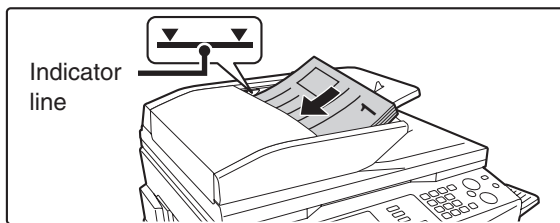

Place the originals face up in the document feeder tray with the edges aligned evenly.

Place the originals face up. Insert the originals all the way into the document feeder tray. The stack must not be higher than the indicator line.



The document glass cannot be used.

2

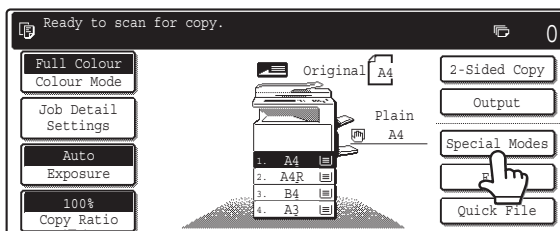

Touch the [Special Modes] key.

3

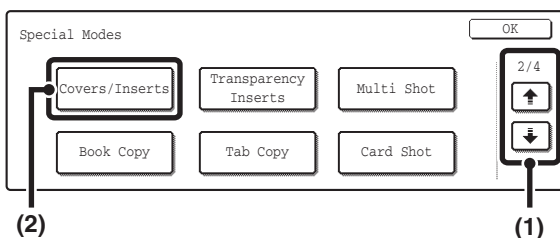

Select Covers/Inserts.

(1) Touch the keys to switch through the screens.

(2) Touch the [Covers/Inserts] key.

4

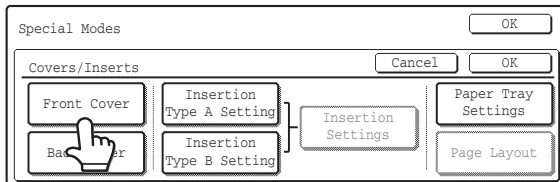

Touch the [Front Cover] key.

5

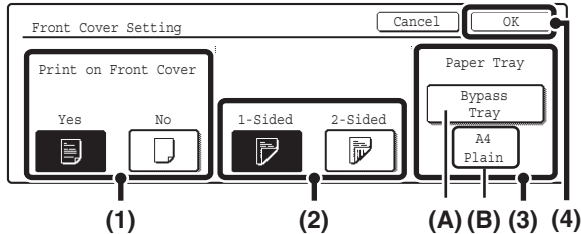

Select front cover settings.

In the example screen, A4 (8-1/2" x 11") size plain paper in the bypass tray is selected.

- (1) If you wish to copy on the front cover, touch the [Yes] key.
- (2) If you touched [Yes] in (1), touch the [1-Sided] key if copying will be 1-sided or the [2-Sided] key if copying will be 2-sided.
- (3) To change the paper tray used for the front cover, touch the tray select key.

(A) The currently selected paper tray for the cover is displayed.

(B) The size and type of paper in the currently selected tray is displayed.

In the example screen, A4 (8-1/2" x 11") size plain paper is loaded in the bypass tray.

To change the paper tray for the cover, touch the tray selection key. (In the screen example, the "Bypass Tray" display is the tray selection key.)

The tray selection screen appears when the tray selection key is touched. Select the paper tray for the cover in the tray selection screen and touch the [OK] key.

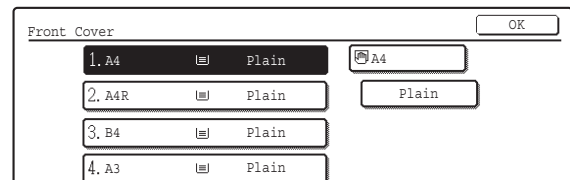

- (4) Touch the [OK] key.



If both sides of the cover will be copied on, label sheets, transparency film, and tab paper cannot be used. Tab paper can only be inserted.

6

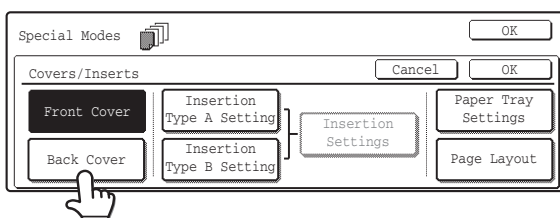

If you wish to insert a back cover, touch the [Back Cover] key.

The screen of step 5 appears. The procedures are the same as for the front cover. Follow the procedures in step 5.

When following the procedures, substitute "Back Cover" for "Front Cover".

7

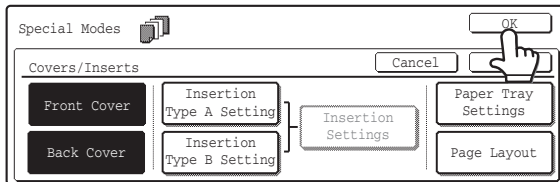

Touch the [OK] key.

You will return to the base screen of copy mode.
To check your settings, touch the [Page Layout] key.

➔ [CHANGING COVER/INSERT SETTINGS \(Page Layout\)](#)
(page 81)

8



or



Press the [COLOUR START] key (○●●●) or the [BLACK & WHITE START] key (○●).

Copying of the originals in the document feeder tray begins.



To cancel scanning of the original and copying...

Press the [STOP] key (⊞).



- This function cannot be used in combination with the saddle stitch function.
- The document glass cannot be used.
- Cover settings cannot be selected if insertion of covers and inserts is disabled in the System Settings (Administrator).



To cancel cover sheet insertion...

Touch the [Cancel] key in the screen of step 4.

INSERTING INSERT SHEETS IN COPIES (Insert Settings)

You can have different paper automatically inserted as an insert at specified pages of copies. Two types of paper can be used as inserts, and the insertion positions can be specified separately for each.

Covers can be used in combination with inserts.

Example: Insert A after page 3 and insert B after page 5.

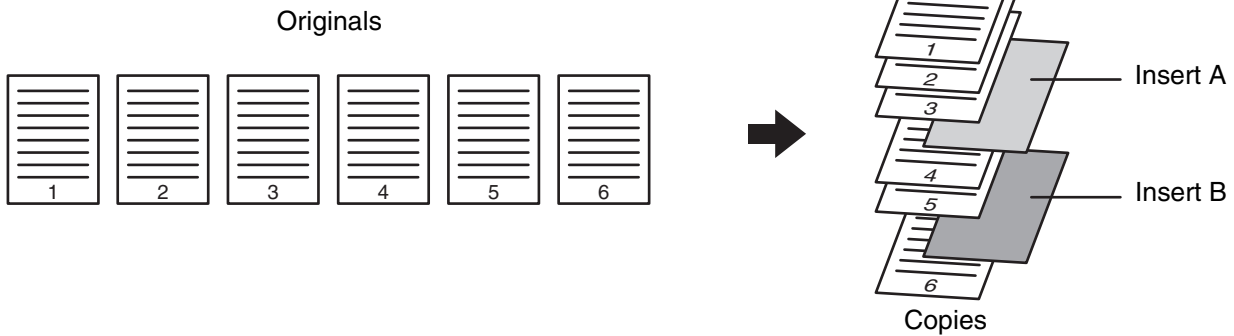

1

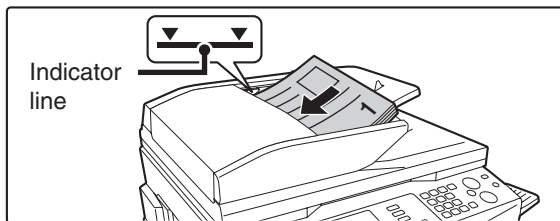

Place the originals face up in the document feeder tray with the edges aligned evenly.

Place the originals face up. Insert the originals all the way into the document feeder tray. The stack must not be higher than the indicator line.



The document glass cannot be used.

2

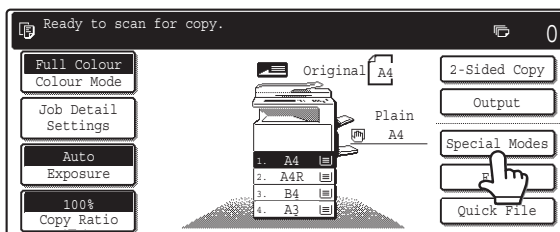

Touch the [Special Modes] key.

3

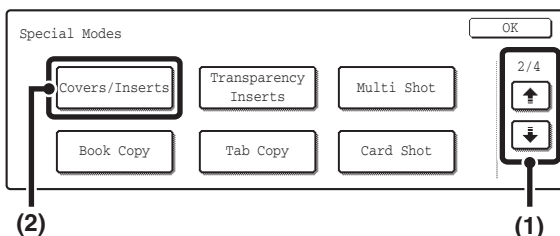

Select Covers/Inserts.

(1) Touch the keys to switch through the screens.

(2) Touch the [Covers/Inserts] key.

4

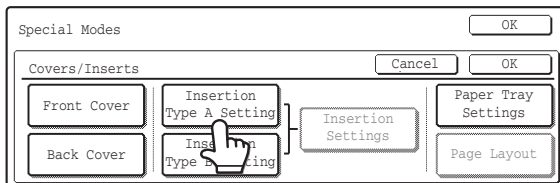

Touch the [Insertion Type A Setting] key.

5

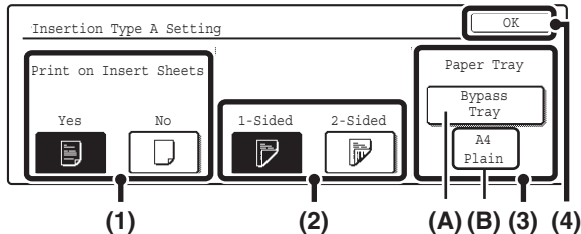

Select settings for insert type A.

In the example screen, A4 (8-1/2" x 11") size plain paper in the bypass tray is selected.

- (1) If you wish to copy on insert type A, touch the [Yes] key.
- (2) If you selected [Yes] in (1), touch the [1-Sided] key if copying will be 1-sided or the [2-Sided] key if copying will be 2-sided.
- (3) To change the paper tray used for insert type A, touch the tray select key.

(A) The currently selected paper tray for the insert is displayed.

(B) The size and type of paper in the currently selected tray is displayed.

In the example screen, A4 (8-1/2" x 11") size plain paper is loaded in the bypass tray.

To change the paper tray for the inserts, touch the tray selection key. (In the screen example, the "Bypass Tray" display is the tray selection key.)

The tray selection screen appears when the tray selection key is touched. Select the paper tray for the inserts in the tray selection screen and touch the [OK] key.

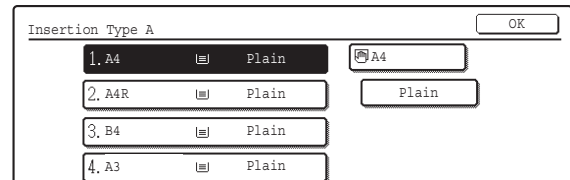

- (4) Touch the [OK] key.



If both sides of the insert will be copied on, label sheets, transparency film, and tab paper cannot be used. Tab paper can only be inserted.

6

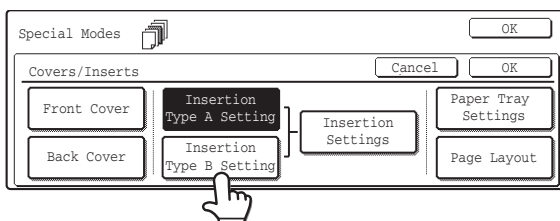

If you wish to insert a different type of insert sheet, touch the [Insertion Type B Setting] key.

The screen of step 5 appears. Settings are selected in the same way as for insert type A. Follow the procedures in step 5. When following the procedures, substitute "Insert Type B" for "Insert Type A".

7

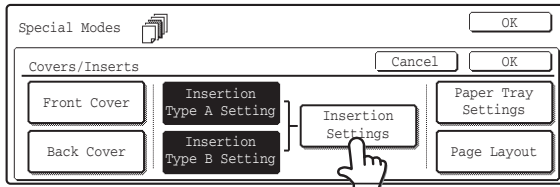

Touch the [Insertion Settings] key.

8

● Insertion settings screen

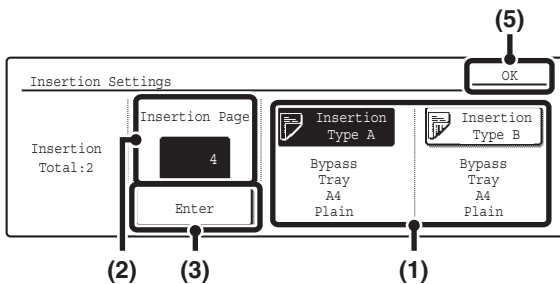

Specify the pages where inserts A and B will be inserted.

- (1) Touch the [Insertion Type A] key or the [Insertion Type B] key.
Specify the page where the highlighted insert will be inserted.
- (2) Enter the page number where the insert sheet will be inserted with the numeric keys.
- (3) Touch the [Enter] key.
- (4) To insert another insert sheet, repeat steps (1) to (3).
- (5) Touch the [OK] key.

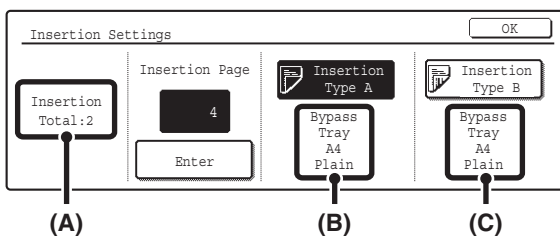

- (A) This shows the total number of inserts. Up to 100 insert sheets can be inserted. To insert multiple inserts, touch the [Enter] key after entering each insertion page number (insertion position) with the numeric keys.
- (B) This shows the tray selected for insert type A and the paper size and type.
- (C) This shows the tray selected for insert type B and the paper size and type.

When the [Insertion Type A] key is highlighted, the insert settings are applied to [Insertion Type A Setting]. When the [Insertion Type B] key is highlighted, the insert settings are applied to [Insertion Type B Setting].



If both sides of the insert will be copied on, label sheets, transparency film, and tab paper cannot be used. Tab paper can only be inserted.

9

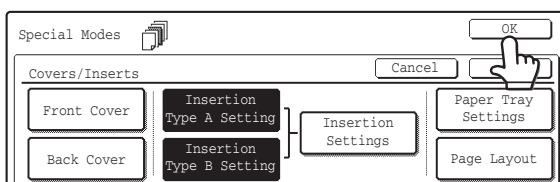

Touch the [OK] key.

You will return to the base screen of copy mode.

To check your settings, touch the [Page Layout] key.

- [CHANGING COVER/INSERT SETTINGS \(Page Layout\)](#) (page 81)



or



Press the [COLOUR START] key (○●●●) or the [BLACK & WHITE START] key (○●).

Copying of the originals in the document feeder tray begins.



To cancel scanning of the original and copying...

Press the [STOP] key (⊘).



- Use the same size of paper for the inserts as for the copies.
- Up to 100 insert sheets can be added. Note that two insert sheets cannot be inserted between the same pages.
- When performing 2-sided copying of 2-sided originals, an insert cannot be added between the front and reverse sides of an original page.
- This function cannot be used in combination with the saddle stitch function.
- Insert settings cannot be selected if insertion of covers and inserts is disabled in the system settings (administrator).



To cancel insert sheet insertion...

Touch the [Cancel] key in the screen of step 4.

CHANGING COVER/INSERT SETTINGS (Page Layout)

Cover settings and insert settings can be combined.

This section explains how to check cover and insert insertion pages, and change or delete insertion pages.

Changing insert A from page 4 to page 5

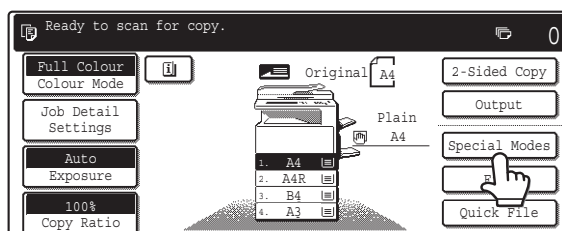
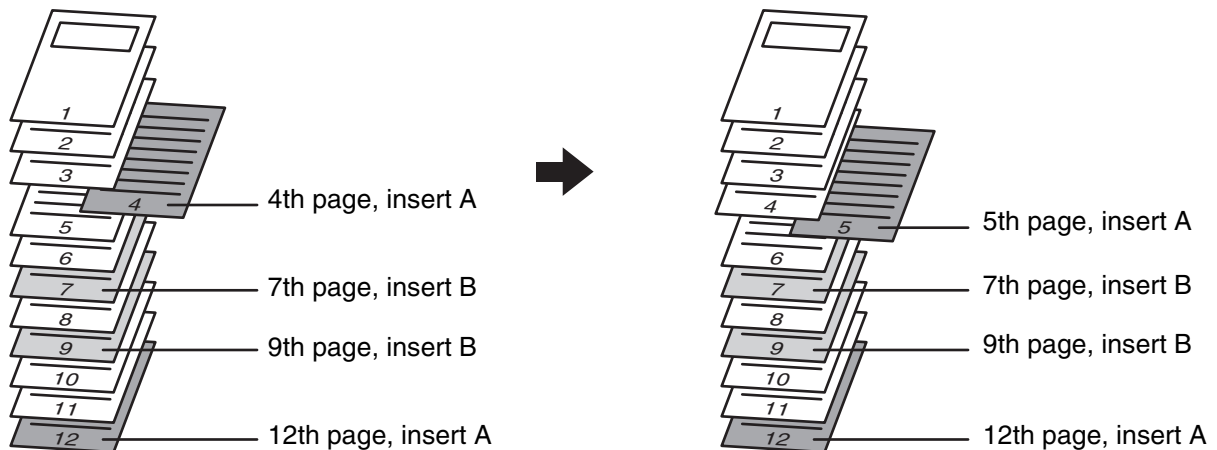

Touch the [Special Modes] key.

2

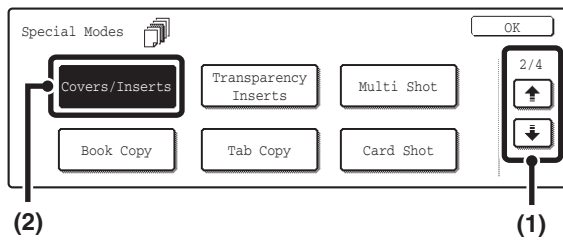

Select Covers/Inserts.

- (1) Touch the keys to switch through the screens.
- (2) Touch the [Covers/Inserts] key.

3

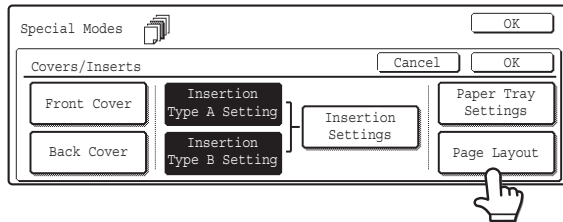

Touch the [Page Layout] key.

4

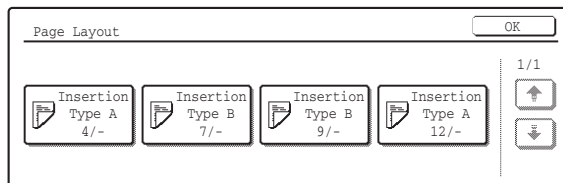

Check the currently specified cover/insert page layout.

Each key shows a print image icon and the insertion page. If there are multiple screens, touch the keys to change screens.

If you are only checking the layout, touch the [OK] key and go to step 8.

● Icons

- : Copy on front side only
- : Copy on reverse side only
- : 2-sided copy
- : Do not copy

For inserts, the insertion page also appears.

* represents a page number.

- */-: Copy only on front side at page *
- */*: Two-sided copy at page */*
- <*: Insert without copying at page *

5

Example: Touch insert A at page 4

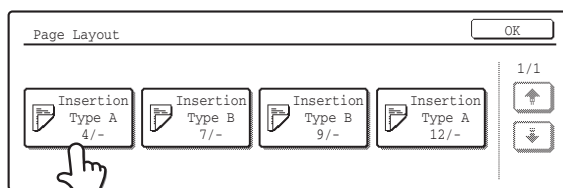

Touch the key of the page that you wish to delete or change.

The following screen will appear.

- To delete the page, touch the [Delete] key. After deleting the key, touch the [OK] key and go to step 8.
- To change the page, touch the [Amend] key. To edit a cover, touch the [Front Cover] key or the [Back Cover] key and go to step 6. To edit an insert, touch the [Insertion Type A] key or the [Insertion Type B] key and go to step 7.
- To cancel, touch the [Cancel] key.

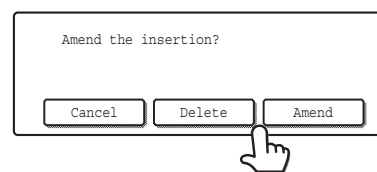

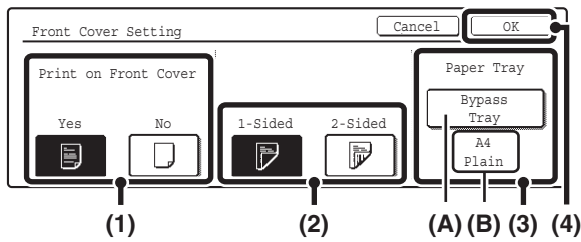

Change the cover settings.

The procedure for changing a front cover is explained below. A back cover is changed in the same way.

- (1) If you wish to copy on the front cover, touch the [Yes] key.
- (2) If you touched [Yes] in (1), touch the [1-Sided] key if copying will be 1-sided or the [2-Sided] key if copying will be 2-sided.
- (3) To change the paper tray used for the front cover, touch the tray select key.

(A) The currently selected paper tray for the cover is displayed.

(B) The size and type of paper in the currently selected tray is displayed.

In the example screen, A4 (8-1/2" x 11") size plain paper is loaded in the bypass tray.

To change the paper tray for the cover, touch the tray selection key. (In the screen example, the "Bypass Tray" display is the tray selection key.)

The tray selection screen appears when the tray selection key is touched. Select the paper tray for the cover in the tray selection screen and touch the [OK] key.

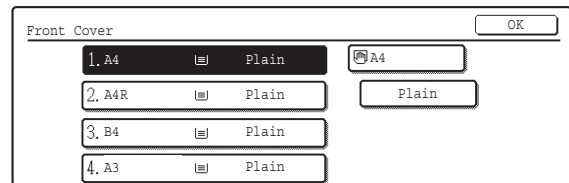

- (4) Touch the [OK] key.

You will return to the screen of step 5.



If both sides of the cover will be copied on, label sheets, transparency film, and tab paper cannot be used. Tab paper can only be inserted.

Example: Changing the insertion page from page 4 to page 5

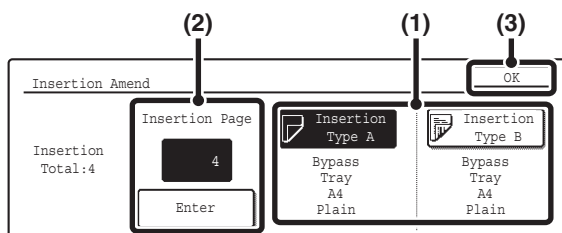

Change the insert settings

- (1) If you wish to change to the other insert type, touch the [Insertion Type A] key or the [Insertion Type B] key.

The paper setting for insert A and insert B cannot be changed.

- (2) If you wish to change the insertion page of the insert, enter the desired page number with the numeric keys and touch the [Enter] key.

- (3) Touch the [OK] key.

You will return to the screen of step 5.

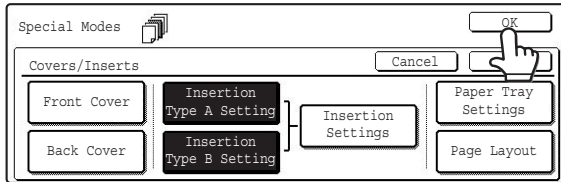

Touch the [OK] key.

You will return to the base screen of copy mode.

ADDING INSERTS WHEN COPYING ON TRANSPARENCY FILM (Transparency Inserts)

When copying on transparency film, the sheets may stick together due to static electricity. The transparency inserts function can be used to automatically insert a sheet of paper between each sheet of transparency film, making the sheets easy to handle.

It is also possible to copy on the inserts.

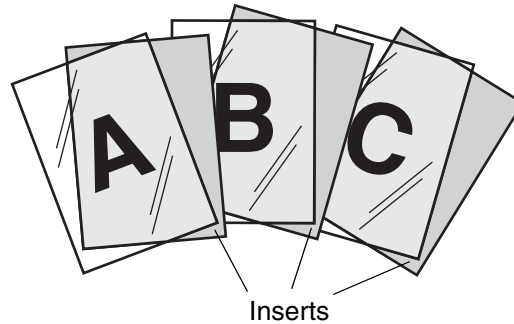

1

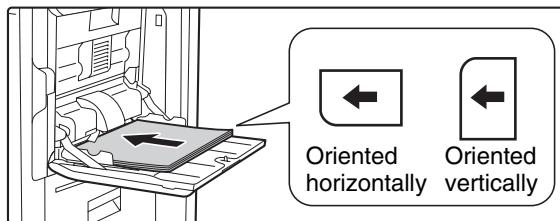

Place the transparency film in the bypass tray.

Place the transparency film face down on the bypass tray. Transparency film can only be placed in the bypass tray. When transparency film is oriented horizontally, the rounded corner should be at the front left. When oriented vertically, the round corner should be at the rear left.

2

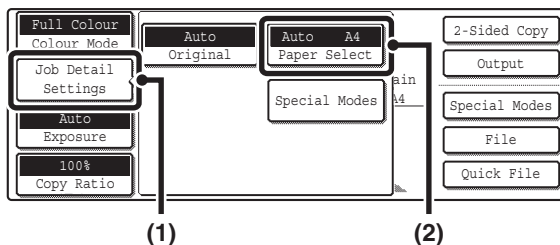

Open the paper settings screen.

- (1) Touch the [Job Detail Settings] key.
- (2) Touch the [Paper Select] key.

3

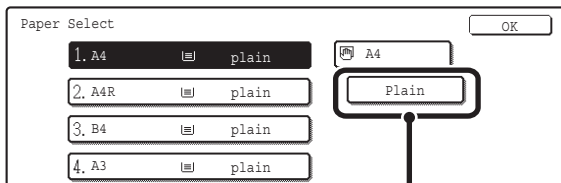

(1)

Select the settings for using transparency film.

- (1) Touch the appropriate paper type key.
- (2) Touch the [Transparency] key.

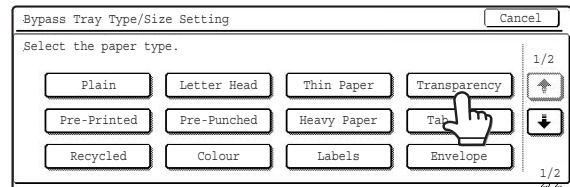

- (3) Specify the size of the transparency film.

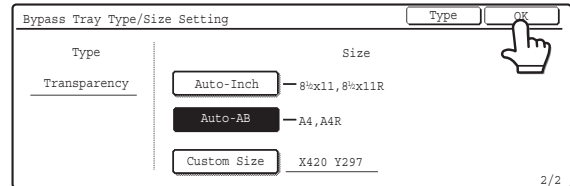

4

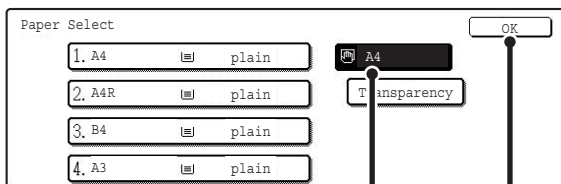

(1)

(2)

Select the bypass tray.

- (1) Touch the paper size key of the bypass tray.
- (2) Touch the [OK] key.

When the [OK] key is touched, you will return to the job detail setting screen. Touch the [Job Detail Settings] key to return to the base screen of copy mode.

5

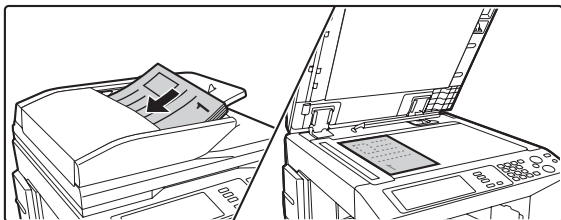

Place the original.

Place the original face up in the document feeder tray, or face down on the document glass.

6

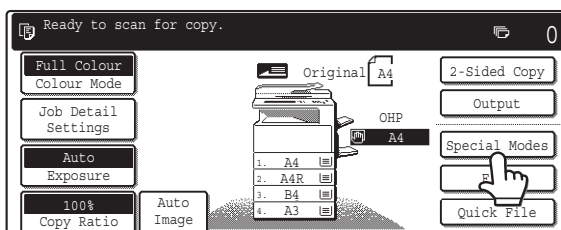

Touch the [Special Modes] key.

7

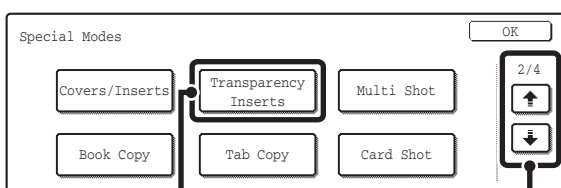

(2)

(1)

Select Transparency Inserts.

- (1) Touch the keys to switch through the screens.
- (2) Touch the [Transparency Inserts] key.

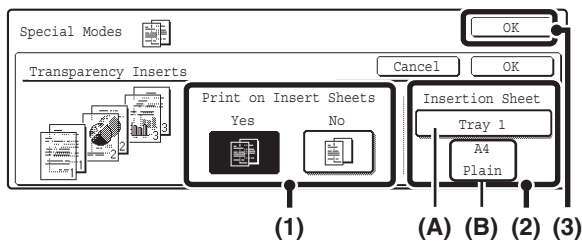

Set the insertion conditions for the inserts.

- (1) Select whether or not the insert paper will be copied on ([Yes] or [No]).
- (2) Specify the tray name (tray position) selected for the inserts, the paper size, and the paper type.

(A) The currently selected paper tray for the insert is displayed.

(B) The size and type of paper in the currently selected tray is displayed.

In the example screen, A4 (8-1/2" x 11") size plain paper is loaded in tray 1.

To change the paper tray for the inserts, touch the tray selection key. (In the screen example, the "Tray 1" display is the tray selection key.)

The tray selection screen appears when the tray selection key is touched. Select the paper tray for the inserts in the tray selection screen and touch the [OK] key.

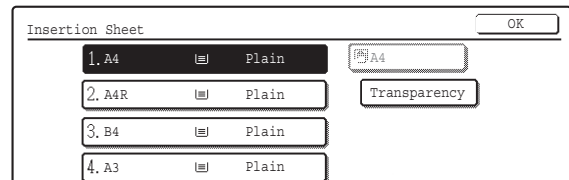

- (3) Touch the [OK] key.

You will return to the base screen of copy mode.



Select insert paper that is the same size as the transparency film.

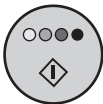

or



Press the [COLOUR START] key (○●●●) or the [BLACK & WHITE START] key (○●).

Copying will begin.

- If the originals were placed in the document feeder tray, the originals are copied.
- If you are using the document glass, copy each page one page at a time. If you are using the sort function or other function that requires all originals to be scanned before the copies are printed, you must use the same [START] key that you used to scan the first original to scan each of the remaining originals.



To cancel scanning of the original and copying...

Press the [STOP] key (⏏).



- The number of copies cannot be selected in this mode.
- When performing 2-sided copying, only "2-sided to 1-sided" mode can be used.



To cancel the transparency inserts setting...

Touch the [Cancel] key in the screen of step 8.

COPYING MULTIPLE PAGES ONTO ONE SHEET OF PAPER (Multi Shot)

Multiple original pages can be copied onto a single sheet of paper in a uniform layout. Select 2in1 to copy two original pages onto one sheet, or 4in1 to copy four original pages onto one sheet. This function is convenient when you wish to present multiple pages in a compact format, or show a view of all pages in a document. This function can also be used with 2-sided originals.

2in1 copying

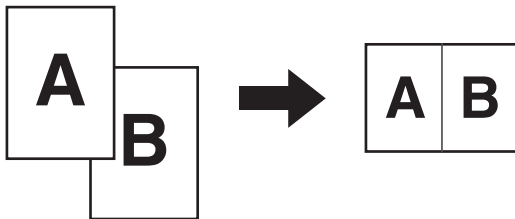

4in1 copying

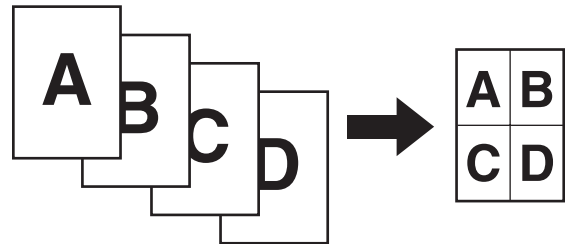

1

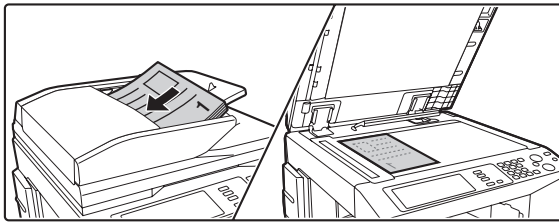

Place the original.

Place the original face up in the document feeder tray, or face down on the document glass.

2

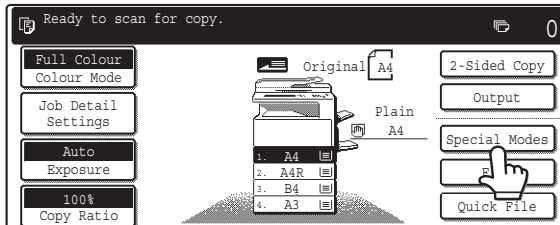

Touch the [Special Modes] key.

3

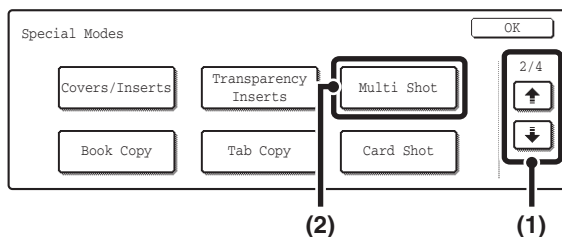

Select Multi Shot.

- (1) Touch the keys to switch through the screens.
- (2) Touch the [Multi Shot] key.

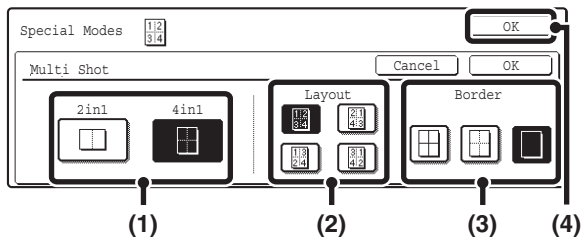

Select the number of originals to be copied onto one sheet of paper, the layout, and the border.

(1) Touch the [2in1] or the [4in1] key.

If needed, the images will be rotated.

(2) Select the layout.

Select the order in which the originals will be arranged on the copy.

Shot number	Layout
2in1	
4in1	

The arrows in the above diagram indicate how the images are arranged.

(3) Select the border.

Solid lines, broken lines, or no lines can be selected.

(4) Touch the [OK] key.

You will return to the base screen of copy mode.

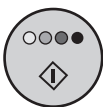

or



Press the [COLOUR START] key (●●●●) or the [BLACK & WHITE START] key (●●).

Copying will begin.

- If the originals were placed in the document feeder tray, the originals are copied.
- If you are using the document glass, copy each page one page at a time. If you are using the sort function or other function that requires all originals to be scanned before the copies are printed, you must use the same [START] key that you used to scan the first original to scan each of the remaining originals.



To cancel scanning of the original and copying...

Press the [STOP] key (◻).



When using the multi shot function, the appropriate copy ratio will be automatically set based on the original size, paper size, and the number of originals to be copied onto one sheet. The minimum possible reduction ratio is 25%. The original size, paper size, and selected number of original pages may require that the ratio be less than 25%. As copying will take place at 25% in this case, part of the original images may be cut off.



To cancel the multi shot setting...

Touch the [Cancel] key in the screen of step 4.

COPYING A PAMPHLET (Book Copy)

This function is used to make a copy of the two facing pages of an open book or other bound document. Copies made with this function can be folded at the centre to create a booklet. This function is convenient for arranging copies into an attractive booklet or pamphlet.

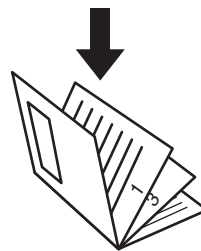
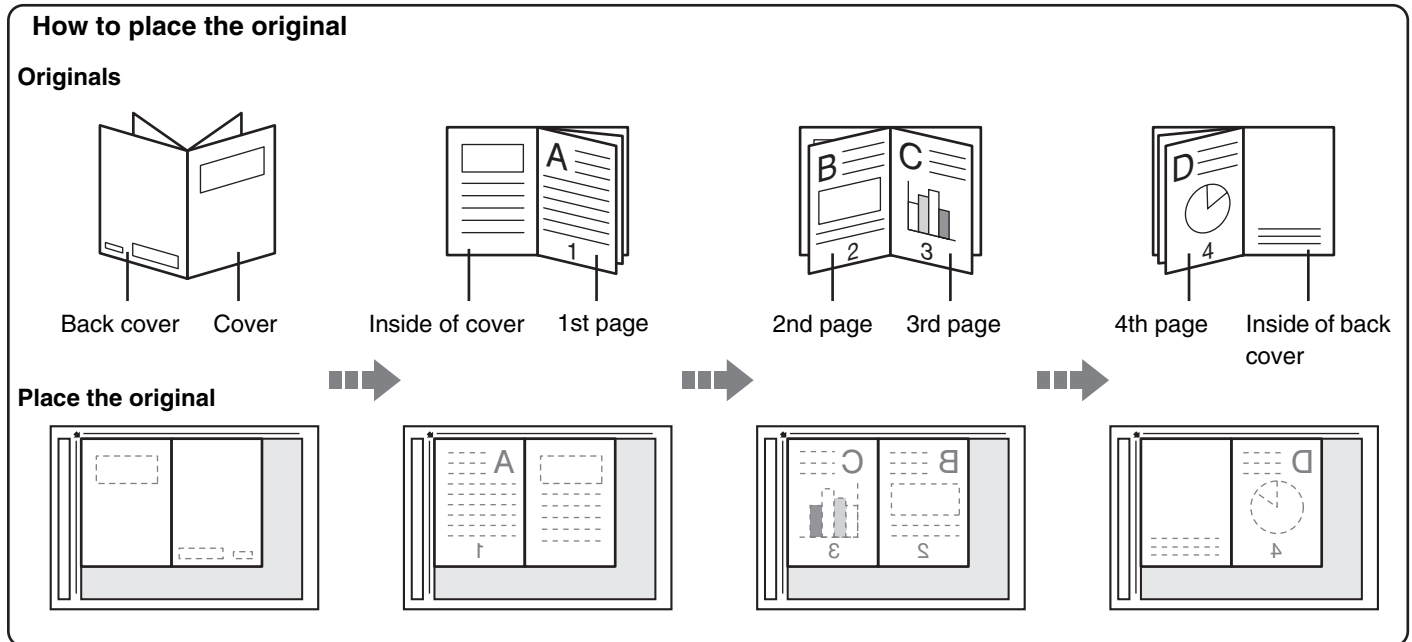

The copies are in the same layout as the original.

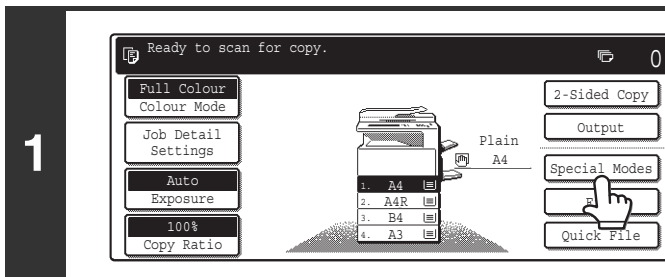

Touch the [Special Modes] key.

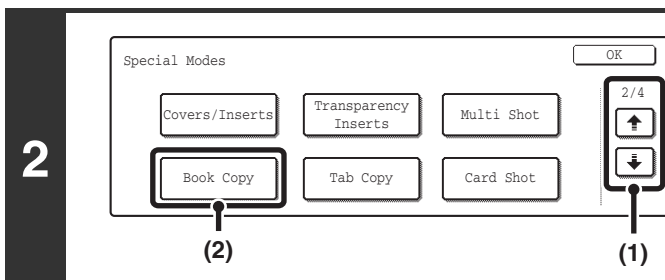

Select Book Copy.

- (1) Touch the keys to switch through the screens.
- (2) Touch the [Book Copy] key.

3

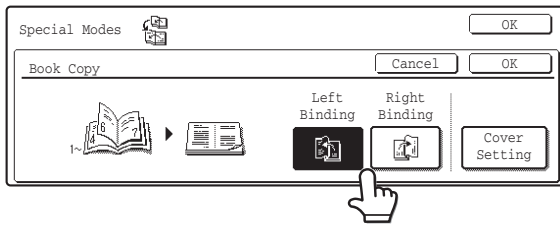

Select the binding position ([Left Binding] or [Right Binding]).

4

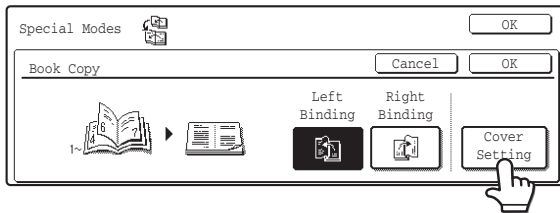

Select cover settings if needed.

If a different type of paper will be used for the cover, touch the [Cover Setting] key. If a cover will not be added, go to step 8.



Cover settings cannot be selected if insertion of covers and inserts is disabled in the system settings (administrator).

5

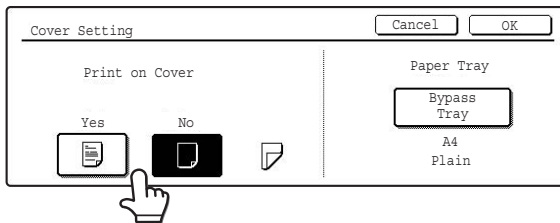

If the cover sheet will be copied on, touch the [Yes] key. Otherwise, touch the [No] key.

6

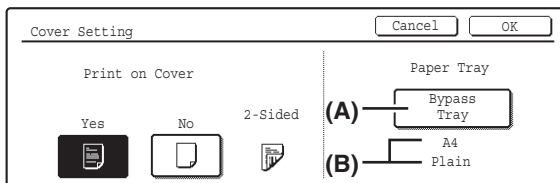

Select the paper tray for the cover.

(A) The currently selected paper tray for the cover is displayed.
(B) The size and type of paper in the currently selected tray is displayed.

In the example screen, A4 (8-1/2" x 11") size plain paper is loaded in the bypass tray.

To change the paper tray for the cover, touch the tray selection key. (In the screen example, the "Bypass Tray" display is the tray selection key.)

The tray selection screen appears when the tray selection key is touched. Select the paper tray for the cover in the tray selection screen and touch the [OK] key.

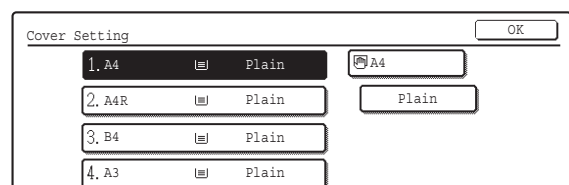

If the cover will be copied on, label sheets, transparency film, and tab paper cannot be used.

7



Touch the [OK] key.



To cancel cover settings...

Touch the [Cancel] key.

8

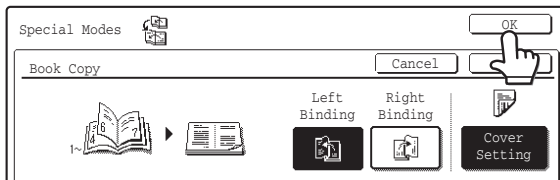

Touch the [OK] key.

You will return to the base screen of copy mode.

9

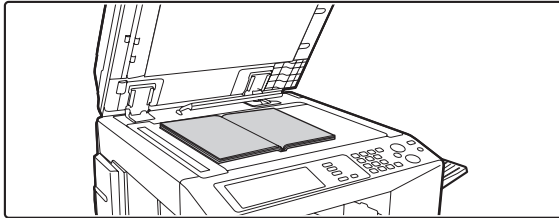

Place the original face down on the document glass.

Place the opened front cover and back cover face down.

10

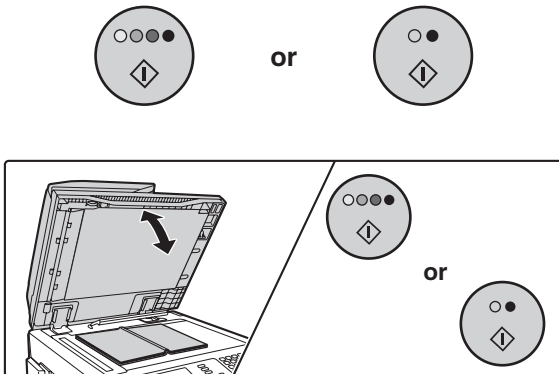

Scan the original.

- (1) Press the [COLOUR START] key (●●●●) or the [BLACK & WHITE START] key (●●).
- (2) Place the next opened pages and press the [COLOUR START] key (●●●●) or the [BLACK & WHITE START] key (●●).

You must use the same [START] key that you used to scan the first set of originals to scan each of the remaining sets. Repeat this step until all original pages have been scanned.

Scan the original pages in the following order:

Opened inside of front cover and 1st page

Opened 2nd and 3rd page

⋮

Opened last page and inside of back cover

Place next original. Press [Start].
When finished, press [Read-End].

Read-End



Touch the [Read-End] key.

Copying will begin.



To cancel scanning of the original and copying...

Press the [STOP] key (⏹).



- Scan the originals from the first page to the last page. The order of copying will be automatically adjusted by the machine.
- Four original pages will be copied onto each sheet of paper. Blank pages may be automatically added at the end depending on the number of original pages.
- If a saddle stitch finisher is installed, the book copy function can be used in combination with the saddle stitch function.
- When book copy is selected, 2-sided copying is automatically selected. When settings that prevent 2-sided copying are selected, the book copy function cannot be used.



To cancel book copy...

Touch the [Cancel] key in the screen of step 3.

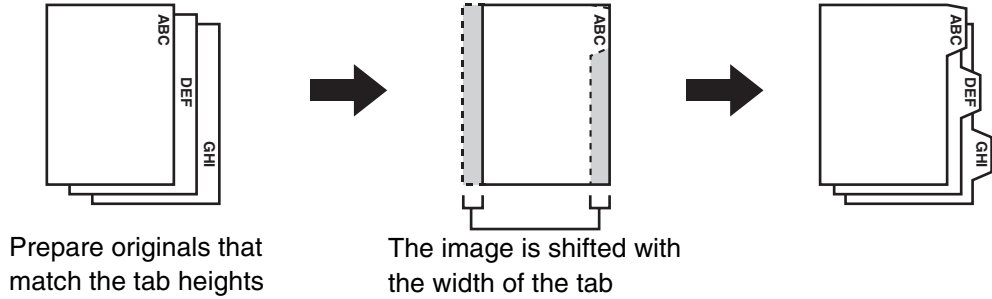

COPYING CAPTIONS ONTO TAB PAPER (Tab Copy)

Captions can be copied onto the tabs of tab paper. Prepare appropriate originals for the tab captions.

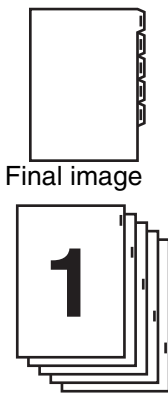
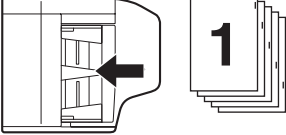

RELATION BETWEEN THE ORIGINALS AND THE TAB PAPER

Tab copying with a left binding

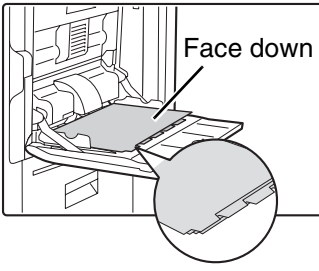
Originals	Placing the originals	Loading tab paper
 <p>Final image</p> <p>Originals</p>	<ul style="list-style-type: none"> Document feeder tray  <p>Insert the originals so that the side with no tab text enters first</p> <ul style="list-style-type: none"> Document glass  <p>Place so that the side with the tab text is on the left</p>	 <p>Face down</p> <p>Load the tab paper so that the tab on the first sheet is toward you.</p>

Tab copying with a right binding

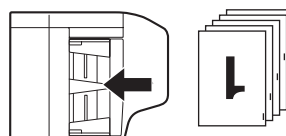
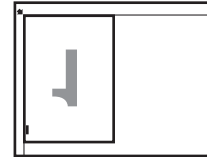
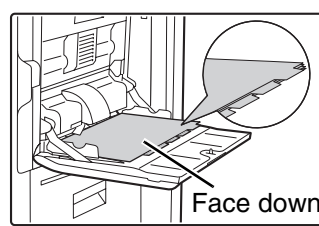
Originals	Placing the originals	Loading tab paper
 <p>Final image</p> <p>Originals</p>	<ul style="list-style-type: none"> Document feeder tray  <p>Insert the originals so that the side with no tab text enters first</p> Document glass  <p>Place so that the side with the tab text is on the left</p> 	 <p>Face down</p> <p>Load the tab paper so that the tab on the first sheet is away from you.</p>

1

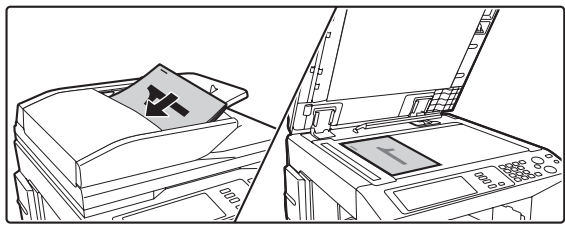

Place the original.

Place the original face up in the document feeder tray, or face down on the document glass.

2

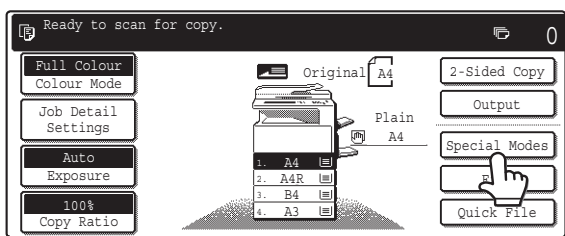

Touch the [Special Modes] key.

3

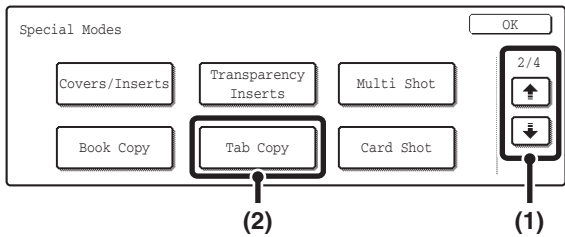

Select Tab Copy.

(1) Touch the key.

(2) Touch the [Tab Copy] key.

4

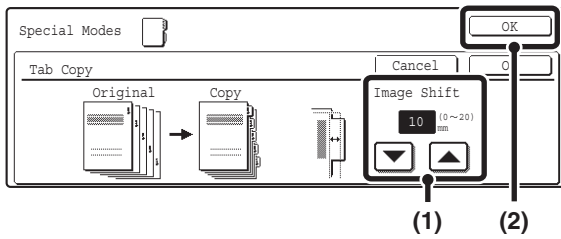

Set the tab width.

- (1) Set the image shift width (tab width) with the keys.

0 mm to 20 mm (0" to 5/8") can be entered.

- (2) Touch the [OK] key.

You will return to the base screen of copy mode.

5

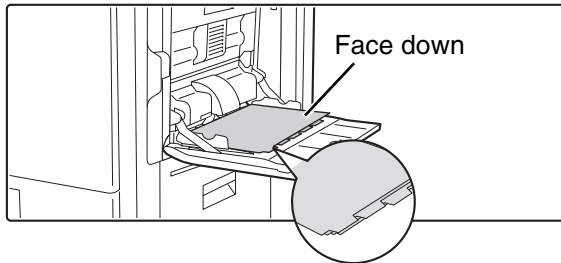

Place tab paper in the bypass tray.

Place tab paper face down on the bypass tray.

Tab paper can only be placed in the bypass tray. Place the paper so that the sides with the tabs enter the machine last.



The width of the tab paper can be up to the width of A4 width (210 mm) plus 20 mm (or 8-1/2" x 11" paper (8-1/2") plus 5/8").

6

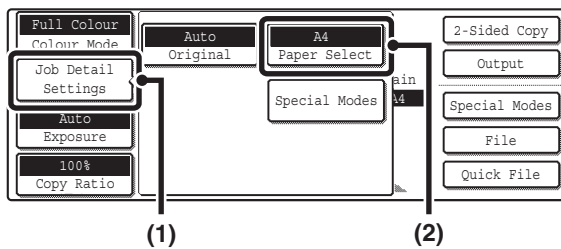

Open the paper settings screen.

- (1) Touch the [Job Detail Settings] key.

- (2) Touch the [Paper Select] key.

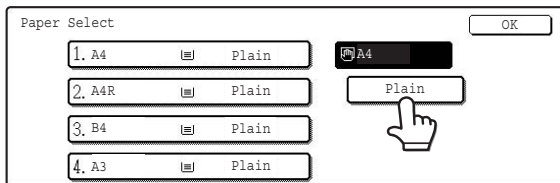

Select settings for using tab paper.

- (1) Touch the appropriate paper type key.
- (2) Touch the [Tab Paper] key.

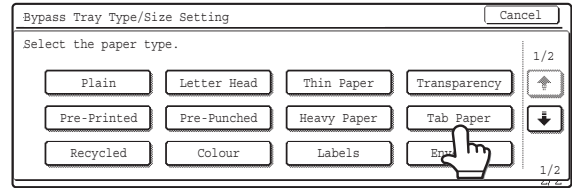

- (3) Touch the [OK] key.

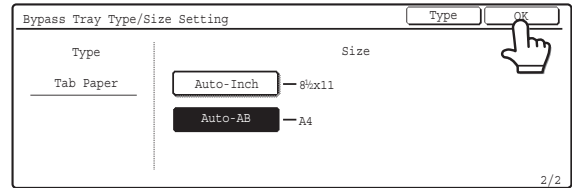

- (4) Touch the [OK] key.

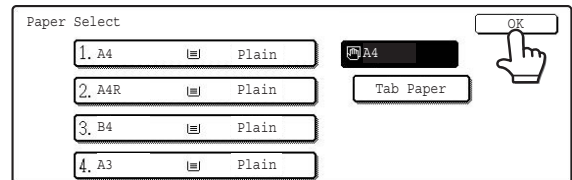

When the [OK] key is touched, you will return to the job detail setting screen. Touch the [Job Detail Settings] key to return to the base screen of copy mode.

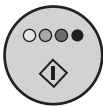

or



Press the [COLOUR START] key (●●●●) or the [BLACK & WHITE START] key (●●).

Copying will begin.

- If the originals were placed in the document feeder tray, the originals are copied.
- If you are using the document glass, copy each page one page at a time.

If you are using the sort function or other function that requires all originals to be scanned before the copies are printed, you must use the same [START] key that you used to scan the first original to scan each of the remaining originals.



To cancel scanning of the original and copying...

Press the [STOP] key (⊘).



To cancel tab copy...

Touch the [Cancel] key in the screen of step 4.



System Settings (Administrator): Initial Tab Copy Setting

The default image shift width can be set from 0 mm to 20 mm (0" to 5/8"). The factory default setting is "10 mm (1/2)".

COPYING BOTH SIDES OF A CARD ON ONE SHEET OF PAPER (Card Shot)

When copying a card, this function allows you to copy the front and reverse sides together onto a single sheet of paper. This function is convenient for making copies for identification purposes and helps save paper.

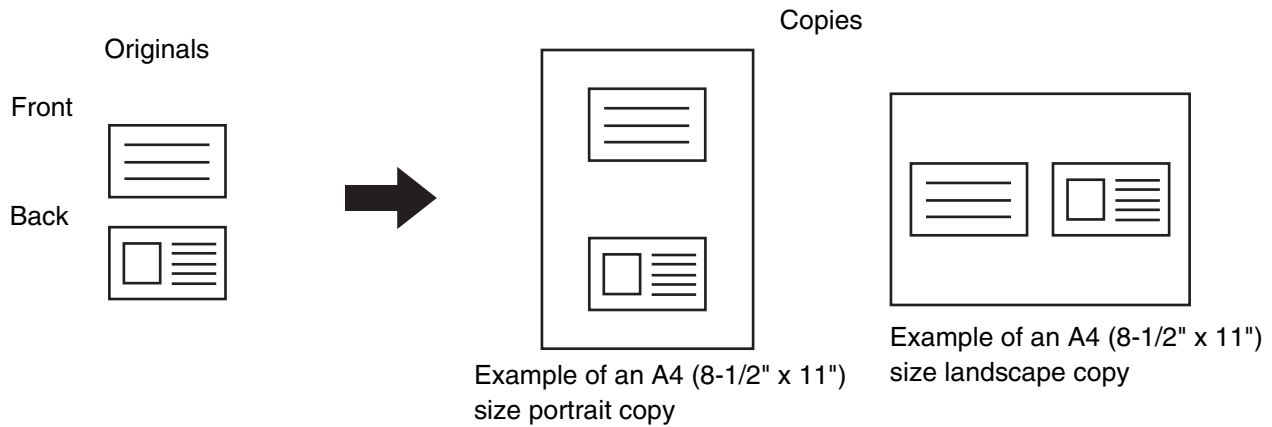

1

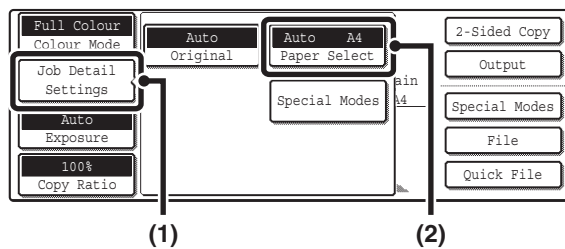

Open the paper settings screen.

- (1) Touch the [Job Detail Settings] key.
- (2) Touch the [Paper Select] key.

2

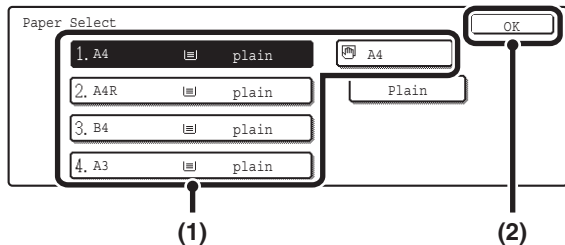

Select the paper to be used.

- (1) Touch the key of the desired paper size.
- (2) Touch the [OK] key.

When the [OK] key is touched, you will return to the job detail setting screen. Touch the [Job Detail Settings] key to return to the base screen of copy mode.

3

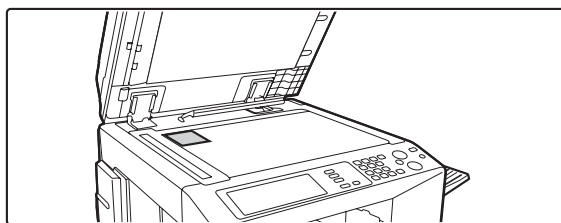

Place the original face down on the document glass.

4

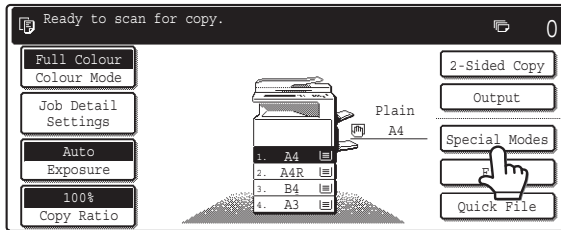

Touch the [Special Modes] key.

5

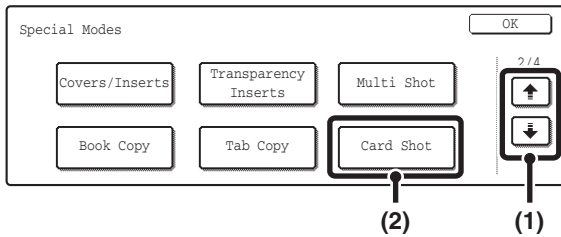

Select Card Shot.

- (1) Touch the keys to switch through the screens.
- (2) Touch the [Card Shot] key.

6

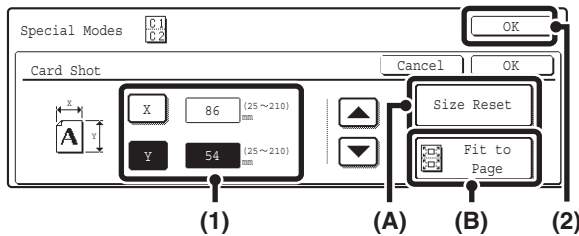

Specify the original size.

- (1) Enter the original size.

With the [X] key highlighted, enter the X (horizontal) dimension of the original with the keys. Touch the [Y] key and enter the Y (vertical) dimension of the original with the keys.

- (A) The [Size Reset] key can be pressed to return the horizontal and vertical dimensions to the values set in "Card Shot Settings" in the system settings (administrator).
- (B) To enlarge or reduce the images to fit the paper based on the entered original size, touch the [Fit to Page] key.

- (2) Touch the [OK] key.

You will return to the base screen of copy mode. "Extra" will appear in the original size display in the base screen.

7

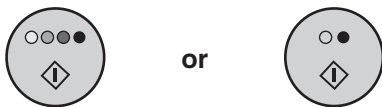

Press the [COLOUR START] key (●●●●) or the [BLACK & WHITE START] key (○●) to scan the front of the card.



To cancel scanning...

Press the [STOP] key (⏹).

8

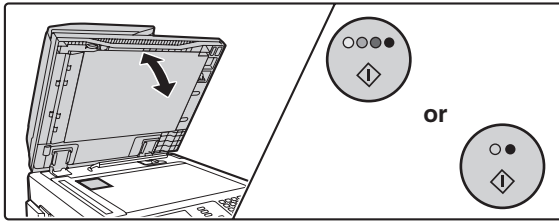

Press the [COLOUR START] key (○●●●) or the [BLACK & WHITE START] key (○●) to scan the back of the card.

Use the same [START] key that you used for the front side of the card.



To cancel scanning...

Press the [STOP] key (⊘).

9

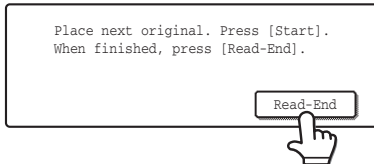

Touch the [Read-End] key.

Copying will begin.



To cancel copying...

Press the [STOP] key (⊘).



- The original must be placed on the document glass.
- Copying is only possible on standard size paper.
- XY Zoom cannot be used when using this function.
- The image cannot be rotated when using this function.



To cancel card shot...

Touch the [Cancel] key in the screen of step 6.



System Settings (Administrator): Card Shot Settings

This is used to set the values to which the size returns when the [Size Reset] key is pressed. 25 mm to 210 mm (1" to 8-1/2") can be entered for both the horizontal and vertical dimensions.

The factory default settings are 86 mm (3-3/8") for X (the width) and 54 mm (2-1/8") for Y (the height).

PRINTING THE DATE AND A STAMP ON COPIES (Stamp)

Use this function to print the date, a stamp, the page number, and text on copies.

Six printing positions are available: top left, top centre, top right, bottom left, bottom centre, and bottom right.

The printing positions are separated into areas that are used for the date, page number and text (A below), and areas that are used for a stamp (B below).

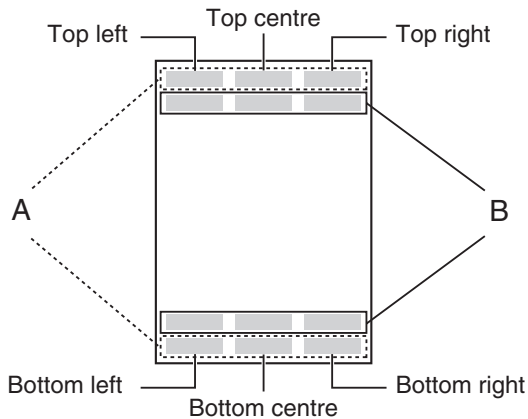

Stamp	Print area	Maximum number of positions
Date	A	1 position only
Stamp	B	6 positions
Page Numbering	A	1 position only
Text	A	6 positions

- In the event that one print item overlaps another print item, the order of placement will be as follows: item on the right side at the front, item on the left side behind the right item, item at the centre behind the left item. Only the content that is at the front will be printed. Content that is hidden due to overlapping will not be printed.
- Text will be printed at the preset size regardless of the copy ratio or paper size setting.
- Text will be printed at the preset exposure regardless of the exposure setting.
- Depending on the size of the paper, some printed content may be cut off or shifted out of position.

When used in combination with other special modes

When the Stamp is used in combination with other special modes, the special modes are reflected in the printed items.

Special Modes	Printing
Margin Shift	The printed item is shifted the amount of the margin width along with the image.
Dual Page Copy	The item is printed on each copy sheet.
Pamphlet Copy Book Copy	The item is printed on each page of the resulting pamphlet or book.
Multi Shot Card Shot	The item is printed on each copy sheet.
Covers/Inserts	Use the Stamp to select whether or not the item is printed on inserted covers/inserts.

- When used in combination with "Erase", "Job Build", "Mirror Image", or "B/W Reverse", the item is printed in the set position as usual.

ADDING THE DATE TO COPIES (Date)

The date can be printed on copies. The position of the date, colour, format, and page (first page only or all pages) can be selected.

Example: Printing AUG/01/2005 in the top right corner of the paper.

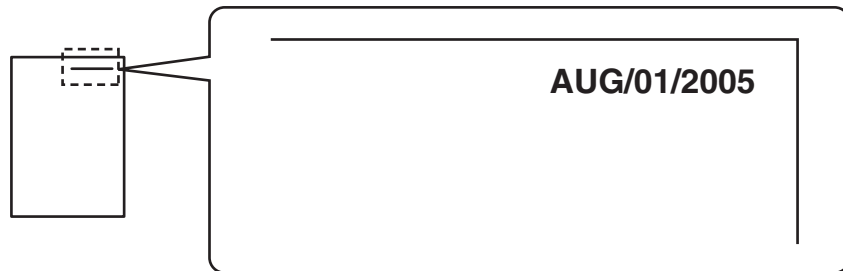

1

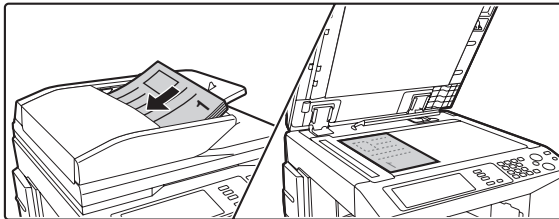

Place the original.

Place the original face up in the document feeder tray, or face down on the document glass.

2

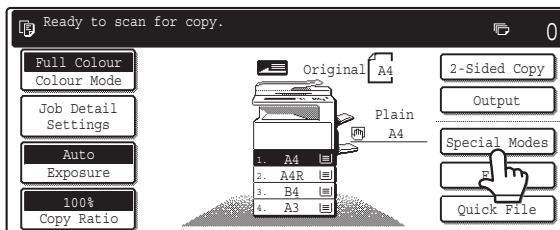

Touch the [Special Modes] key.

3

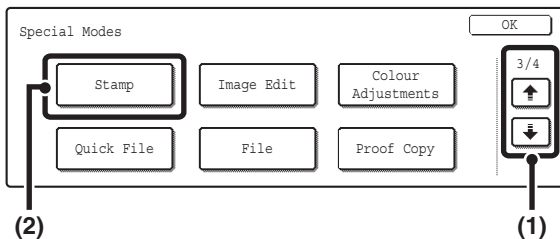

Select Stamp.

(1) Touch the   keys to switch through the screens.

(2) Touch the [Stamp] key.

4

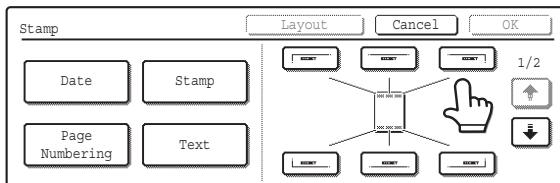

Select the print position.

Select from 6 positions: top left, top centre, top right, bottom left, bottom centre, bottom right.

The keys that show the print positions will appear as follows depending on the state of the settings.

	Not selected, stamp setting has not been selected.
	Selected during selection of the stamp setting.
	Not available, stamp setting has already been allocated.

The above key is the top left key. The appearance of the keys varies by position.



- The "Date" cannot be set in a position that already has "Page Numbering" and "Text" settings.
- The "Date" cannot be set in multiple positions. If the "Date" has already been set and the [Date] key is touched at a different position, a message will appear asking you if you wish to move the date to the selected position. If you wish to move the date, touch the [Yes] key. If not, press the [No] key.
- If the "Date" is set without selecting a position, the date will be printed in the top right position.

5

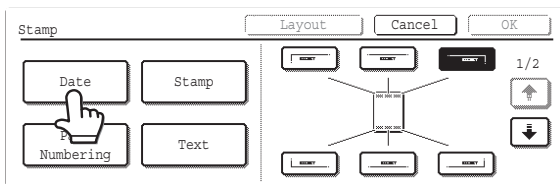

Touch the [Date] key.

6

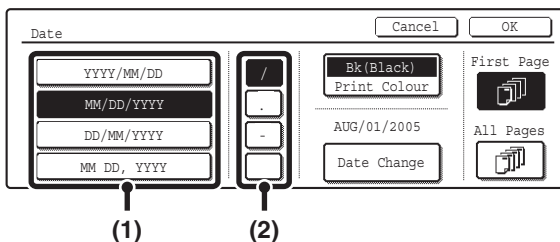

Set the date format.

- (1) Touch the key that shows the desired date format.
- (2) If you selected [YYYY/MM/DD], [MM/DD/YYYY], or [DD/MM/YYYY], touch the [/], [.), [-], or [] key to select the separator.

7

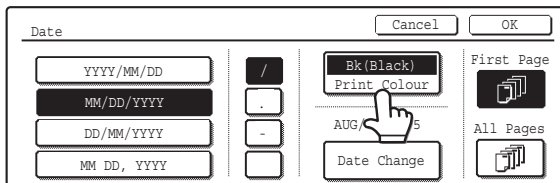

Touch the [Print Colour] key and select the print colour.

Touch the desired colour and touch the [OK] key.

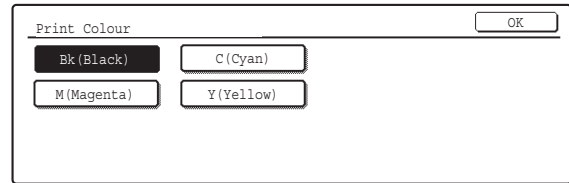

If you selected a colour other than [Bk (Black)], press the [COLOUR START] key (○●●●). Pressing the [BLACK & WHITE START] key (○●) will print the date in black and white.

8

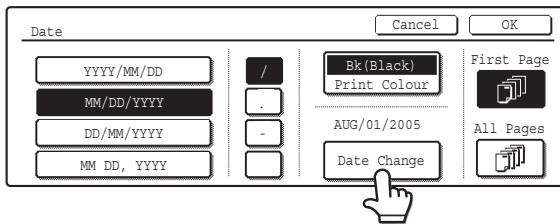

Check the displayed date. If you need to change the date, touch the [Date Change] key.

Set the date that you wish to use and touch the [OK] key.

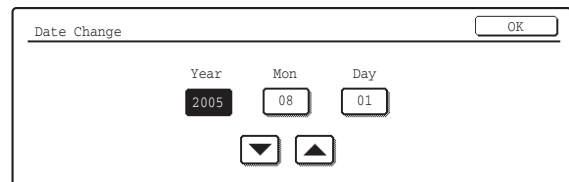

- If you select a date that does not exist (such as Feb. 30), the [OK] key will be greyed out to prevent entry.
- Changing the date here will not change the date that is set in the machine using "Clock" in the system settings.

9

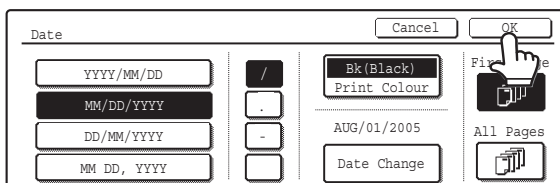

Select the pages that the date will be printed on and touch the [OK] key.

Select printing on the first page only, or printing on all pages.

10

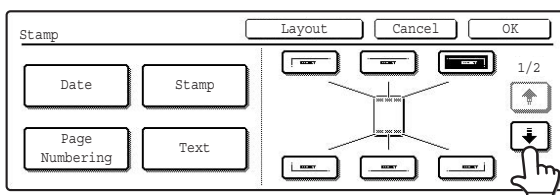

Touch the [Layout] key.

11

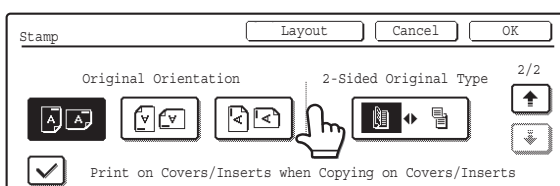

Touch the [Original Orientation] key and specify the orientation of the placed original.

If 2-sided originals have been placed, touch the [2-Sided Original Type] key and specify the binding position (booklet binding or tablet binding) of the originals.

12

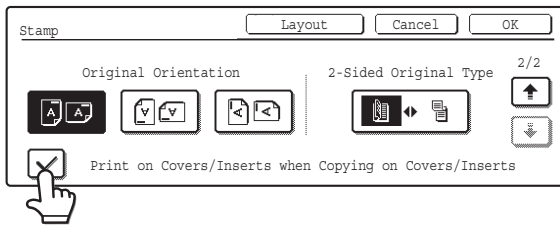

If covers/inserts will be inserted, select whether or not you want the stamp printed on the covers/inserts.

If not, touch the checkbox to remove the checkmark .



- When copying on covers/inserts is not selected, printing will not take place even if a checkmark appears.
- This setting cannot be selected if insertion of covers and inserts is disabled in the system settings (administrator).

13

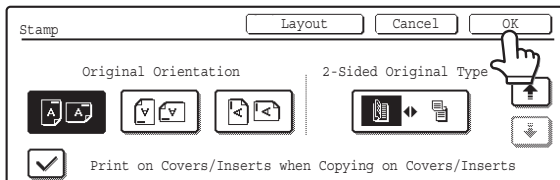

Touch the [OK] key.

You will return to the base screen of copy mode.

14

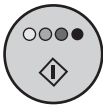

or



Press the [COLOUR START] key (○●●●) or the [BLACK & WHITE START] key (○●).

Copying will begin.

- If the originals were placed in the document feeder tray, the originals are copied.
- If you are using the document glass, copy each page one page at a time.

If you are using the sort function or other function that requires all originals to be scanned before the copies are printed, you must use the same [START] key that you used to scan the first original to scan each of the remaining originals.



- If you selected printing in colour, press the [COLOUR START] key (○●●●). Even if colour is selected, pressing the [BLACK & WHITE START] key (○●) will print the date in black and white.
- If the date is printed in colour on a black and white copy, the copy will be included in the full colour count.



To cancel scanning of the original and copying...

Press the [STOP] key (⏏).



To cancel the stamp...

Touch the [Cancel] key in the screen of step 4.

To cancel the date print setting...

Touch the [Cancel] key in the screen of step 6.

STAMPING COPIES (Stamp)

Text such as "CONFIDENTIAL" can be printed in white on a dark background as a "Stamp" on copies. The position, colour, size, density, and pages (first page only or all pages) can be selected for a stamp.

Printing "CONFIDENTIAL" in the top left corner of a copy

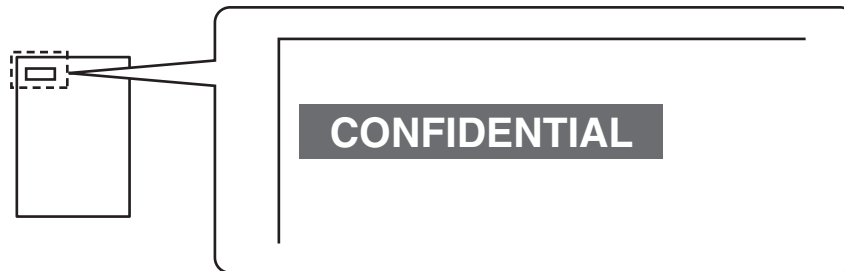

The following 12 selections are available for the stamp text.

CONFIDENTIAL	PRIORITY	PRELIMINARY	FINAL
FOR YOUR INFO.	DO NOT COPY	IMPORTANT	COPY
URGENT	DRAFT	TOP SECRET	PLEASE REPLY

3 levels can be selected for the density of the stamp background.

4 colours can be selected for the stamp colour.

2 stamp sizes can be selected.

1

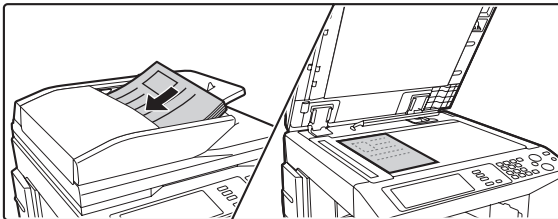

Place the original.

Place the original face up in the document feeder tray, or face down on the document glass.

2

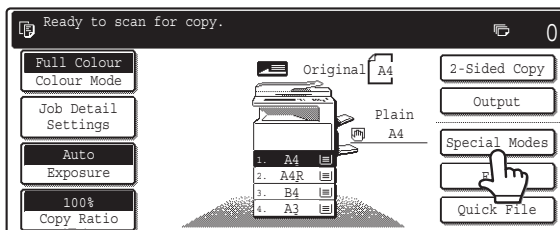

Touch the [Special Modes] key.

3

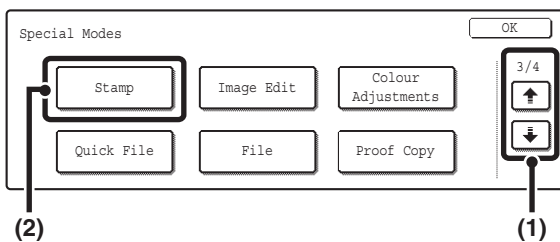

Select Stamp.

(1) Touch the keys to switch through the screens.

(2) Touch the [Stamp] key.

4

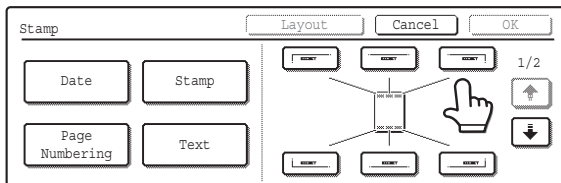

Select the print position.

Select from 6 positions: top left, top centre, top right, bottom left, bottom centre, bottom right.

The keys that show the print positions will appear as follows depending on the state of the settings.

	Not selected, stamp setting has not been selected.
	Selected during selection of the stamp setting.
	Not available, stamp setting has already been allocated.

The above key is the top left key. The appearance of the keys varies by position.



If a "Stamp" is set without selecting a position, the stamp will be printed in the top left position.

5

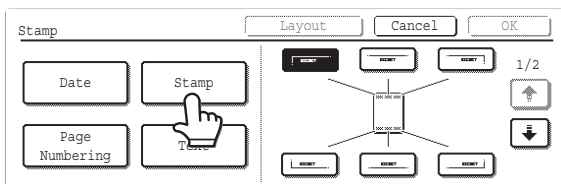

Touch the [Stamp] key.

6

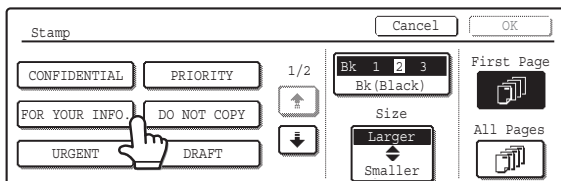

Touch the key of the stamp that you wish to use.

7

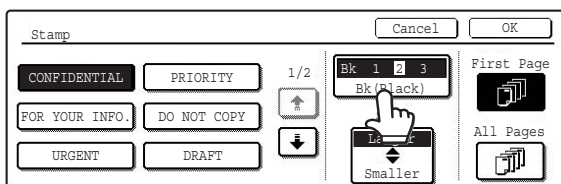

Touch the [Print Colour] key and set the colour and density.

Touch the colour that you wish to use.

If you wish to darken the selected colour, touch the key.

If you wish to lighten the selected colour, touch the key.

When you have finished the settings, touch the [OK] key.

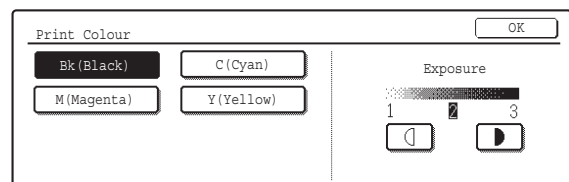

If you selected a colour other than [Bk (Black)], press the [COLOUR START] key (○●●●). Pressing the [BLACK & WHITE START] key (○●) will print the stamp in black and white.

8

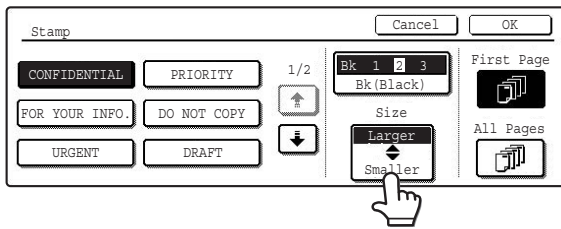

Touch the [Larger ◀ Smaller] key to select the size of the stamp.

9

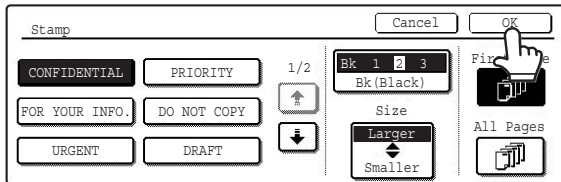

Select the pages that the stamp will be printed on and touch the [OK] key.
Select printing on the first page only, or printing on all pages.

10

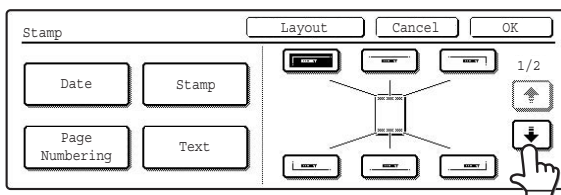

Touch the [↓] key.

11

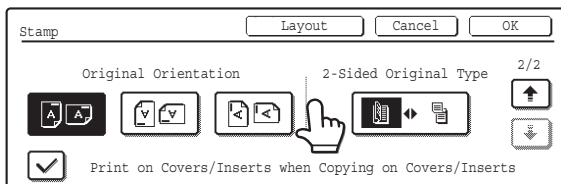

Touch the [Original Orientation] key and specify the orientation of the placed original.

If 2-sided originals have been placed, touch the [2-Sided Original Type] key and specify the binding position (booklet binding or tablet binding) of the originals.

12

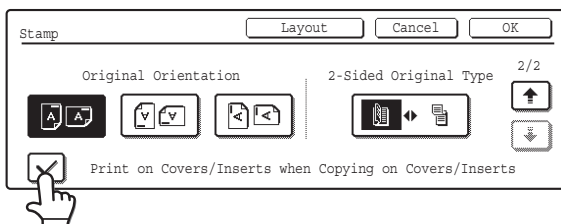

If covers/inserts will be inserted, select whether or not you want the stamp printed on the covers/inserts.

If not, touch the checkbox to remove the checkmark .



- When copying on covers/inserts is not selected, printing will not take place even if a checkmark appears.
- This setting cannot be selected if insertion of covers and inserts is disabled in the system settings (administrator).

13

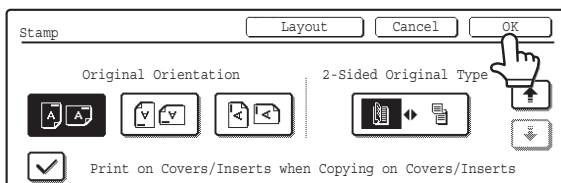

Touch the [OK] key.

You will return to the base screen of copy mode.

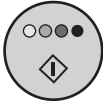

or



Press the [COLOUR START] key (○●●●) or the [BLACK & WHITE START] key (○●).

Copying will begin.

- If the originals were placed in the document feeder tray, the originals are copied.
- If you are using the document glass, copy each page one page at a time.

If you are using the sort function or other function that requires all originals to be scanned before the copies are printed, you must use the same [START] key that you used to scan the first original to scan each of the remaining originals.



- If you selected printing in colour, press the [COLOUR START] key (○●●●). Even if colour is selected, pressing the [BLACK & WHITE START] key (○●) will print the stamp in black and white.
- If the stamp is printed in colour on a black and white copy, the copy will be included in the full colour count.



To cancel scanning of the original and copying...
Press the [STOP] key (⏹).



The stamp text cannot be edited.



- **To cancel the stamp...**
Touch the [Cancel] key in the screen of step 4.
- **To cancel the stamp setting...**
Touch the [Cancel] key in the screen of step 6.

PRINTING PAGE NUMBERS ON COPIES (Page Numbering)

Page numbers can be printed on copies.

The position, colour, format, and page number can be selected for page numbering.

Printing the page number at the bottom centre of the paper.

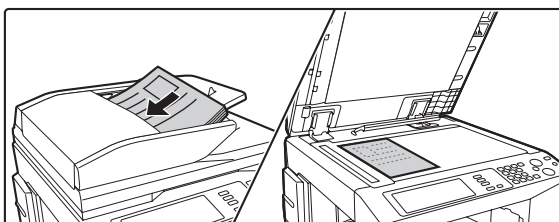
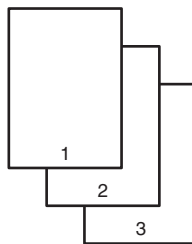

Place the original.

Place the original face up in the document feeder tray, or face down on the document glass.

2

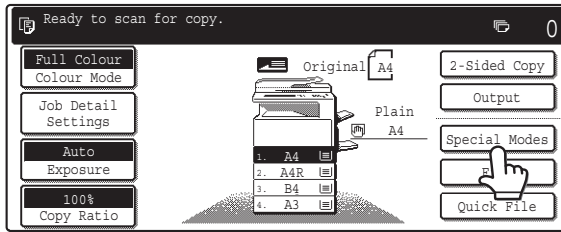

Touch the [Special Modes] key.

3

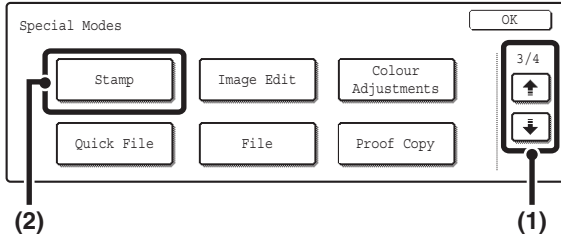

Select Stamp.

- (1) Touch the keys to switch through the screens.
- (2) Touch the [Stamp] key.

4

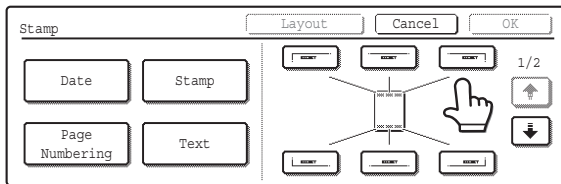

Select the print position.

Select from six positions: top left, top centre, top right, bottom left, bottom centre, bottom right.

The keys that show the print positions will appear as follows depending on the state of the settings.

	Not selected, stamp setting has not been selected.
	Selected during selection of the stamp setting.
	Not available, stamp setting has already been allocated.

The above key is the top left key. The appearance of the keys varies by position.



- "Page Numbering" cannot be configured in a position that already has "Date" and "Text" settings.
- "Page Numbering" cannot be selected in multiple positions. If the [Page Numbering] key is touched when Page Numbering has already been set, a message will appear asking you if you wish to move the page numbers to the selected position. If you wish to move the page numbers, touch the [Yes] key. If not, press the [No] key.
- If "Page Numbering" is set without selecting a position, the page numbers will be printed in the bottom centre position.

5

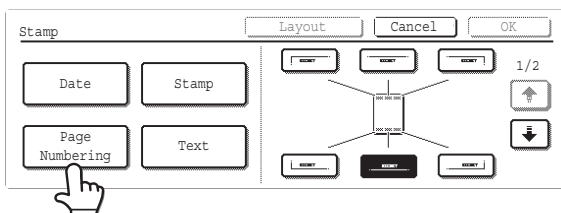

Touch the [Page Numbering] key.

6

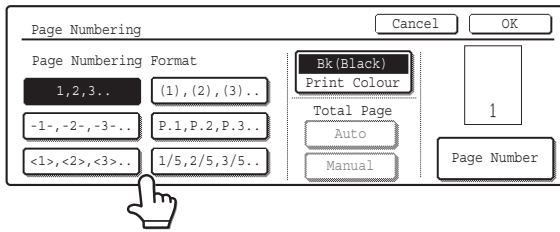

Select a format for the page number.

If "1/5, 2/5, 3/5" is selected,

"Page number / Total pages" will be printed. "Auto" is initially selected for the total pages, which means that the number of scanned original pages is automatically set as the total pages. If you need to set the total pages manually, such as when a large number of originals are divided into sets for scanning, touch the [Manual] key to display the total pages entry screen.

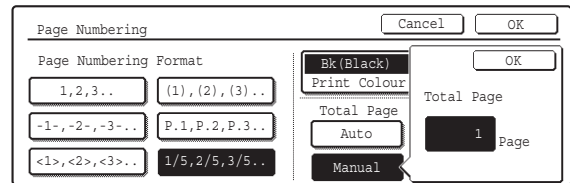

Enter the total pages (1 to 999) with the numeric keys and touch the [OK] key.



- When 2-sided copying is performed, the total pages is the total number of sides of the paper. If the final page is blank, it is not counted. However, if a back cover will be added and the [Count Back Cover] checkbox is selected , the final page is counted. (See step 11.)
- When used in combination with "Dual Page Copy", "Multi Shot", or "Card Shot", the number of sides of the paper copied on is the total pages.
- When used in combination with "Pamphlet Copy" or "Book Copy", the total number of pages in the resulting pamphlet or booklet is the total pages.

7

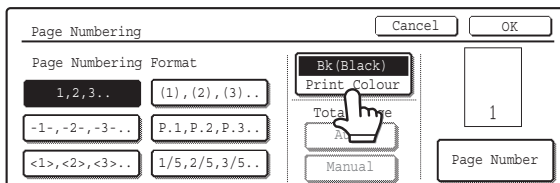

Touch the [Print Colour] key.

Touch the colour that you wish to use.
Touch the [OK] key.

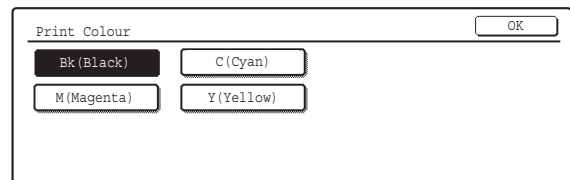

If you selected a colour other than [Bk (Black)], press the [COLOUR START] key (○●●●). Pressing the [BLACK & WHITE START] key (○●) will print the page numbers in black and white.

8

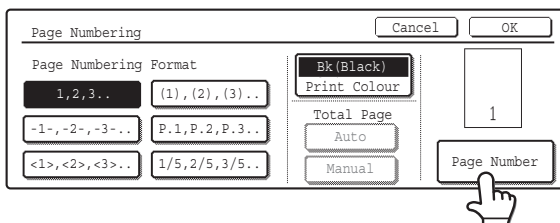

To change the first number or last number of page numbering, the page from which printing begins, or the insert printing setting, touch the [Page Number] key.

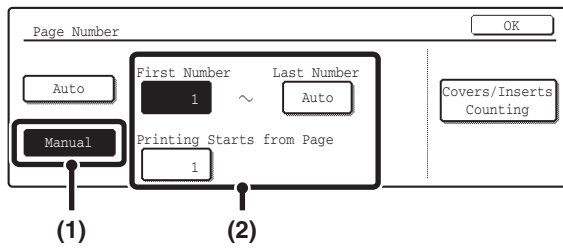

Select page number settings.

- (1) Touch the [Manual] key.
- (2) Set the first number, the last number, and the "Printing Starts from Page" number.

Touch each key and enter a number with the numeric keys. (1 to 999)

The [CLEAR] key (\square) can be pressed to return the setting of the selected item to the default value. If you make a mistake, press the [CLEAR] key (\square) and then enter the correct number.



- A last number smaller than the first number cannot be set.
- The "Last Number" is initially set to "Auto", which means that page numbers are automatically printed through the last page based on the "First Number" and "Printing Start from Page" settings.
- If the last number is set to a smaller number than the total pages, page numbers are not printed on pages after the page set as the last number.
- Set a page number in "Printing Starts from Page". For example, if "3" is set and one-sided copying is being performed, page numbers will be printed beginning from the 3rd copy sheet (the 3rd original page). If two-sided copying is being performed, page numbers will be printed beginning from the front side of the 2nd copy sheet (the 3rd original page).

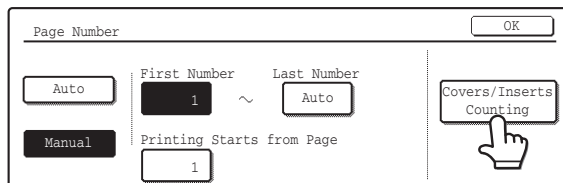

If covers/inserts will be inserted, touch the [Covers/Inserts Counting] key if you want the covers/inserts to be counted in the page numbers.

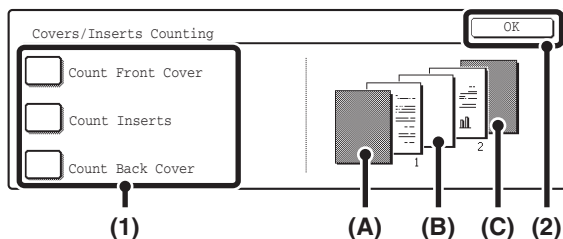

Touch each item that you want counted in the page numbers so that a checkmark appears , and then touch the [OK] key.

Items with a checkmark will be reflected in the print image on the right side of the screen.

- (A): Front cover image
 (B): Insert image
 (C): Back cover image



- When the checkboxes are selected , each inserted sheet of paper (front cover, insert, or back cover) will be counted as one page in the case of 1-sided copying, or two pages in the case of 2-sided copying. However, when the body sheets are 1-sided copies and the inserted sheets are 2-sided copies, each body sheet is counted as one page and each inserted sheet is counted as two pages.
- Page numbers are printed on covers/inserts if the covers/inserts are counted and if they are copied on.

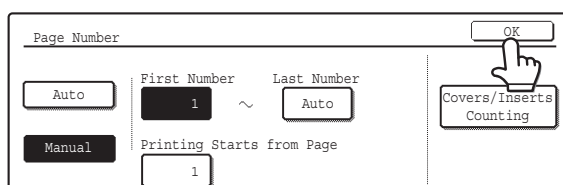

Touch the [OK] key.

13

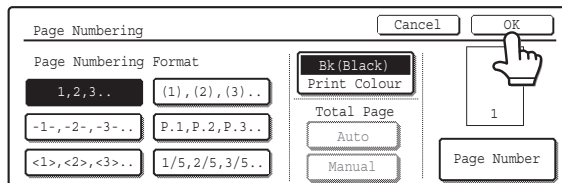

Touch the [OK] key.

14

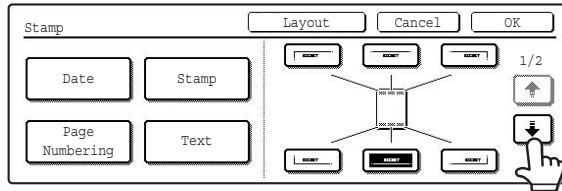

Touch the  key.

15

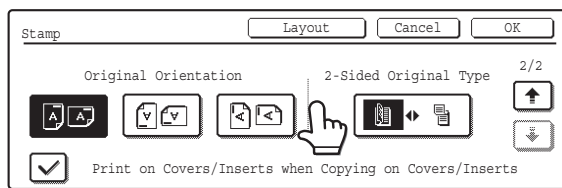

Touch the [Original Orientation] key and specify the orientation of the placed original.

If two-sided originals have been placed, touch the  key and specify the binding position (booklet binding or tablet binding) of the originals.

16

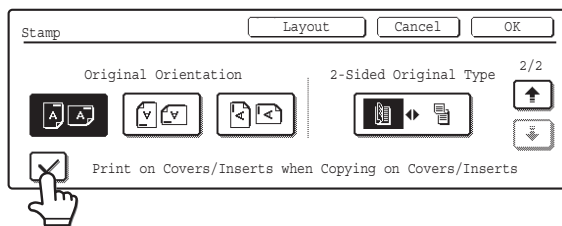

If covers/inserts will be inserted, select whether or not you want the text printed on the covers/inserts.

If not, touch the checkbox to remove the checkmark .



- When copying on covers/inserts is not selected, printing will not take place even if a checkmark appears.
- Page numbers are printed on covers/inserts if the covers/inserts are counted and if they are copied on.
- This setting cannot be selected if insertion of covers and inserts is disabled in the system settings (administrator).

17

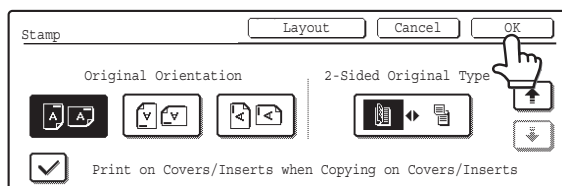

Touch the [OK] key.

You will return to the base screen of copy mode.

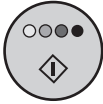

or



Press the [COLOUR START] key (○●●●) or the [BLACK & WHITE START] key (○●).

Copying will begin.

- If the originals were placed in the document feeder tray, the originals are copied.
- If you are using the document glass, copy each page one page at a time.

If you are using the sort function or other function that requires all originals to be scanned before the copies are printed, you must use the same [START] key that you used to scan the first original to scan each of the remaining originals.



- If you selected printing in colour, press the [COLOUR START] key (○●●●). Even if colour is selected, pressing the [BLACK & WHITE START] key (○●) will print the page numbers in black and white.
- If page numbers are printed in colour on black and white copies, the copies will be included in the full colour count.



To cancel scanning of the original and copying...

Press the [STOP] key (⏹).



- When "Page Numbering" is selected, copying in group mode is not possible. The mode automatically changes to sort mode.
- When the page number printing position is set to the right side or left side and pamphlet copy or book copy is used, the print position is changed so that the page numbers always appear on the outer side of each opened page (the left and right sides of the opened pages). If a stamp is set in the area where page numbering is set, the position of the stamp changes together with the page number.

If another print item is set in this changing position, the page numbers will alternate sides with the stamp.

A stamp item that is in a position not affected by the changing page number position will be printed in its set position.

Example: When four pages are copied using pamphlet copy and the page number format is "1, 2, 3...", the result is as follows:

In this example, the page number is set at the bottom of the page and the date is set at the top, and thus the date does not move.

Print settings

Date	
Stamp No.	Text



Side 1

AUG/01/2005	AUG/01/2005
CONFIDENTIAL 4	AAA AAA CONFIDENTIAL 1

Side 2

AUG/01/2005	AUG/01/2005
CONFIDENTIAL 2	AAA AAA CONFIDENTIAL 3



- **To cancel the stamp...**
Touch the [Cancel] key in the screen of step 4.
- **To cancel the page numbering setting...**
Touch the [Cancel] key in the screen of step 6.

PRINTING TEXT ON COPIES (Text)

Entered text can be printed on copies. Up to 30 frequently used text strings can be stored.

Example: Printing "August 2005 Planning Meeting" in the top left corner of the paper

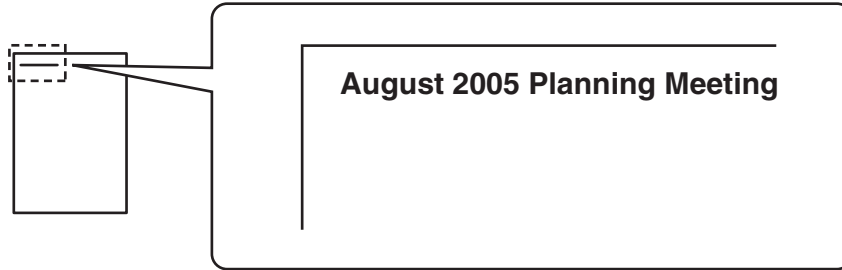

1

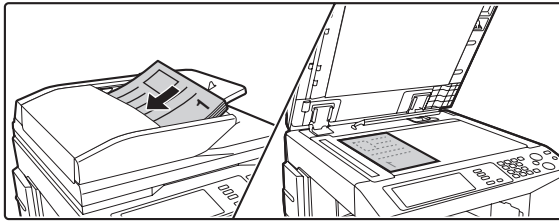

Place the original.

Place the original face up in the document feeder tray, or face down on the document glass.

2

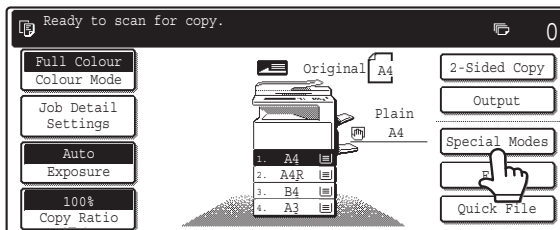

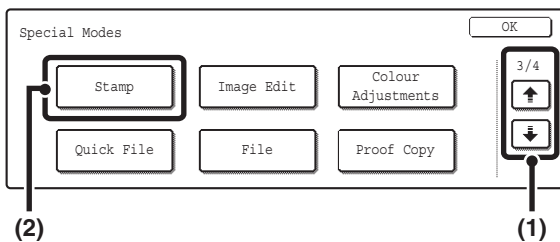

Touch the [Special Modes] key.

3



Select Stamp.

- (1) Touch the   keys to switch through the screens.
- (2) Touch the [Stamp] key.

4

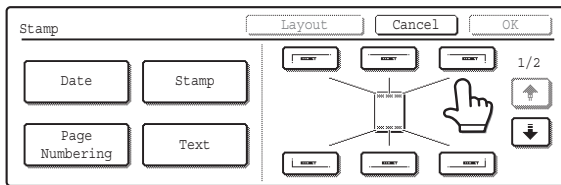

Select the print position.

Select from 6 positions: top left, top centre, top right, bottom left, bottom centre, bottom right.

The keys that show the print positions will appear as follows depending on the state of the settings.

	Not selected, stamp setting has not been selected.
	Selected during selection of the stamp setting.
	Not available, stamp setting has already been allocated.

The above key is the top left key. The appearance of the keys varies by position.



- "Text" cannot be configured in a position that already has "Date" and "Page Numbering" settings.
- If "Text" is configured without selecting a position, the text will be printed in the top left position.

5

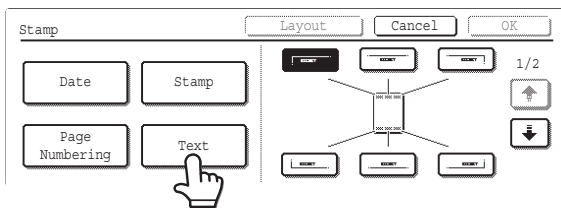

Touch the [Text] key.

6

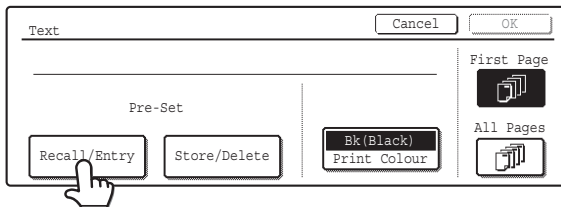

Touch the [Recall/Entry] key.

To store or delete a text string, touch the [Store/Delete] key.

[Storing, editing, and deleting text strings](#) (page 120)

7

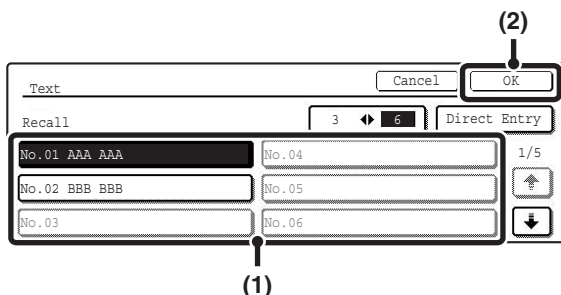

Specify the text to be printed.

The [Direct Entry] key can be touched to display the text entry screen. To enter text, see "6. ENTERING TEXT" in the User's Guide. When all characters have been entered, touch the [OK] key.

(1) Touch the text string that you wish to select.

The [3 ◀ 6] key can be touched to switch between 3-item display and 6-item display. When 3-item display is selected, the entire text string appears in each key.

(2) Touch the [OK] key.

8



Touch the [Print Colour] key.

Touch the colour that you wish to use. Touch the [OK] key.

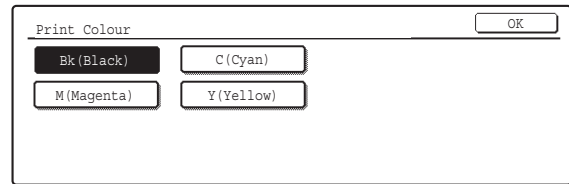

If you selected a colour other than [Bk (Black)], press the [COLOUR START] key (○●●●). Pressing the [BLACK & WHITE START] key (○●) will print the text in black and white.

9

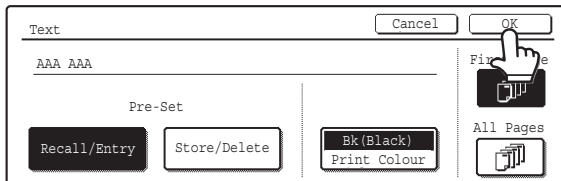

Select the pages that the text will be printed on and touch the [OK] key.

Select printing on the first page only, or printing on all pages.

10

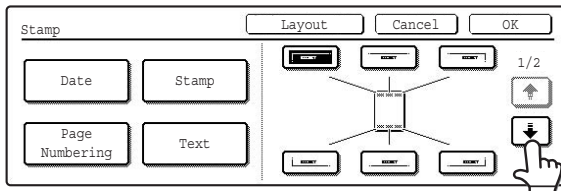

Touch the key.

11

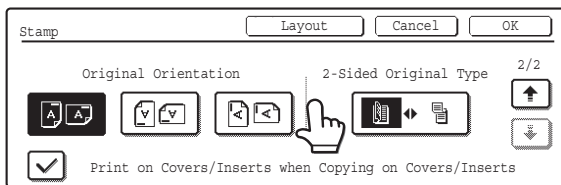

Touch the [Original Orientation] key and specify the orientation of the placed original.

If 2-sided originals have been placed, touch the  key and specify the binding position (booklet binding or tablet binding) of the originals.

12

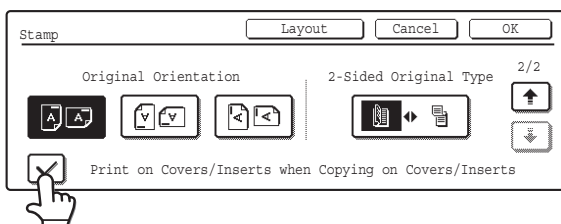

If covers/inserts will be inserted, select whether or not you want the text printed on the covers/inserts.

If not, touch the checkbox to remove the checkmark .



- When copying on covers/inserts is not selected, printing will not take place even if a checkmark appears.
- This setting cannot be selected if insertion of covers and inserts is disabled in the system settings (administrator).

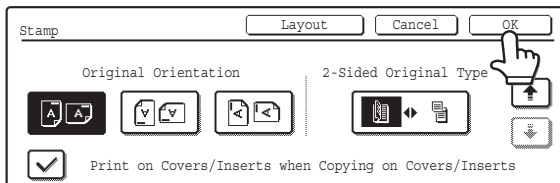

Touch the [OK] key.

You will return to the base screen of copy mode.



or



Press the [COLOUR START] key (○●●●) or the [BLACK & WHITE START] key (○●).

Copying will begin.

- If the originals were placed in the document feeder tray, the originals are copied.
- If you are using the document glass, copy each page one page at a time.

If you are using the sort function or other function that requires all originals to be scanned before the copies are printed, you must use the same [START] key that you used to scan the first original to scan each of the remaining originals.



- If you selected printing in colour, press the [COLOUR START] key (○●●●). Even if colour is selected, pressing the [BLACK & WHITE START] key (○●) will print the text in black and white.
- If the text is printed in colour on a black and white copies, the copies will be included in the full colour count.



To cancel scanning of the original and copying...

Press the [STOP] key (⏏).



Text settings can also be configured in the Web pages. Click [Application Settings], [Copy Settings] and then [Text Settings (Stamp)] in the Web page menu.



• To cancel the stamp...

Touch the [Cancel] key in the screen of step 4.

• To cancel the text setting...

Touch the [Cancel] key in the screen of step 6.

Storing, editing, and deleting text strings

1

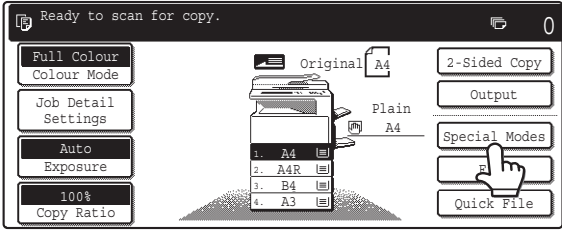

Ready to scan for copy.

Full Colour Colour Mode

Job Detail Settings

Auto Exposure

100% Copy Ratio

Original A4

Plain A4

2-Sided Copy

Output

Special Modes

Quick File

1. A4

2. A4R

3. B4

4. A3

Touch the [Special Modes] key.

2

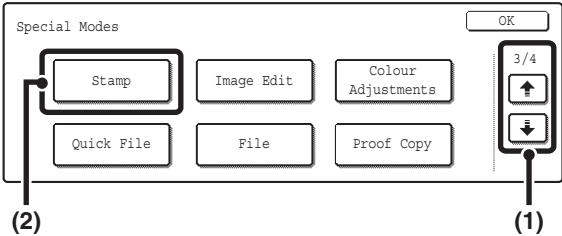

Special Modes

Stamp

Image Edit

Colour Adjustments

Quick File

File

Proof Copy

3/4

(2)

(1)

Select Stamp.

(1) Touch the   keys to switch through the screens.

(2) Touch the [Stamp] key.

3

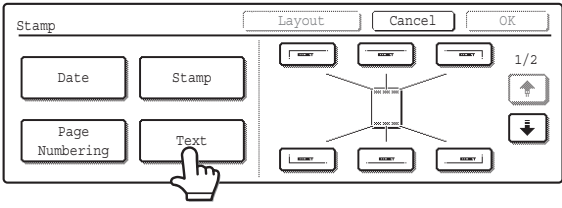

Stamp

Date

Stamp

Page Numbering

Text

Layout

Cancel

OK

1/2

Touch the [Text] key.

4

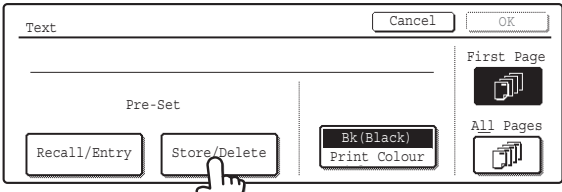

Text

Recall/Entry

Store/Delete

Bk (Black) Print Colour

First Page

All Pages

Touch the [Store/Delete] key.

Store a text string, or edit/delete a stored text string.

● Storing a text string

(1) Touch a key that has not been stored.

A text entry screen appears. Enter the text string (maximum of 50 characters). To enter text, see "6. ENTERING TEXT" in the User's Guide. When you have finished entering the text, touch the [OK] key. The text entry screen will close.

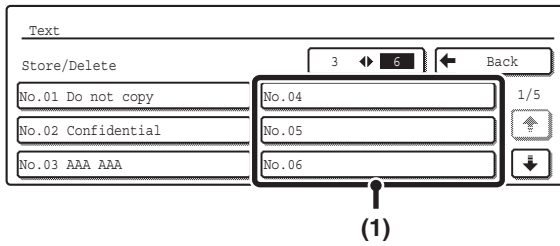

● Editing/deleting a text string

(1) Touch the key that has the text that you wish to edit or delete.

(2) To edit the text, touch the [Amend] key. To delete the text, touch the [Delete] key.

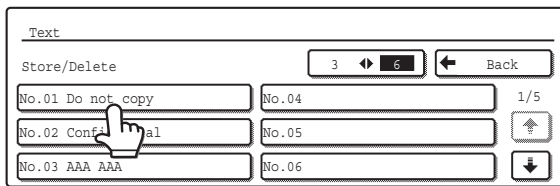

When the [Amend] key is touched, a text entry screen appears. The selected text string is entered in the screen. To enter text, see "6. ENTERING TEXT" in the User's Guide. When you have finished editing the text, touch the [OK] key. The text entry screen will close.



Text Settings can also be configured in the Web pages. Click [Application Settings], [Copy Settings] and then [Text Settings (Stamp)] in the Web page menu.

CHECKING THE STAMP LAYOUT (Layout)

After stamp items have been selected, you can check the print layout, change the print position, and delete print items.

1

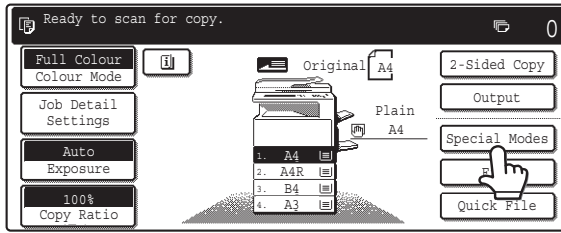

Touch the [Special Modes] key.

2

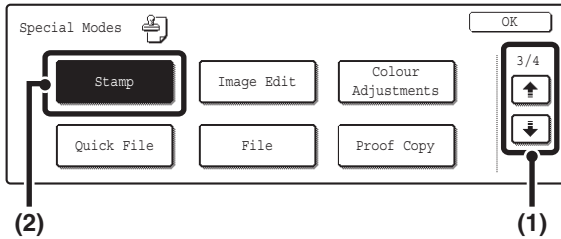

Select Stamp.

(1) Touch the keys to switch through the screens.

(2) Touch the [Stamp] key.

3

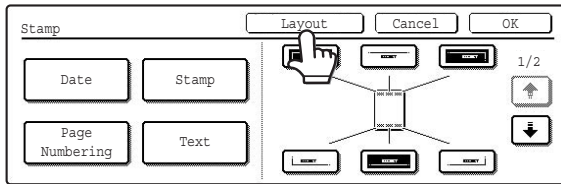

Touch the [Layout] key.

If the layout is correct, touch the [OK] key.



The [Layout] key can only be touched when stamp items have been selected.

4

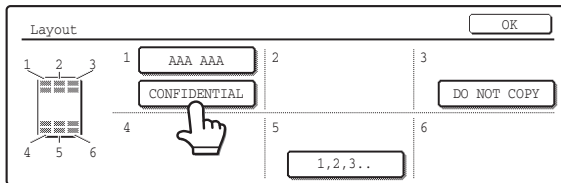

Touch the key of the print item that you want to delete or whose position you want to change.



A maximum of 14 characters appear in each key.

5



To change the position of the print item, touch the [Move] key. To delete the item, touch the [Delete] key.

If the [Move] key is touched, a screen for selecting the destination position appears.

If the [Delete] key is touched, the print item is deleted. (Go to step 8.)

6

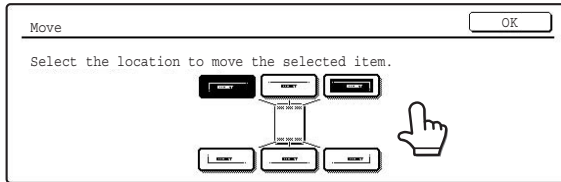

Touch the key of the desired destination position.

The touched position key is highlighted and the print position changes.

The keys that show the print positions will appear as follows depending on the state of the settings.

	Not selected, stamp setting has not been selected.
	Selected during selection of the stamp setting.
	Not available, stamp setting has already been allocated.

The above key is the top left key. The appearance of the keys varies by position.



If you wish to swap the position of the selected print item with the position of another print item, temporarily move either one of the print items to an unoccupied position and then switch the print positions.

7

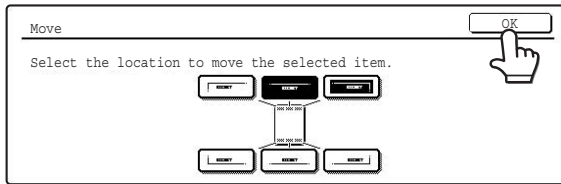

Touch the [OK] key.

If you attempt to move the print item to a position that is already occupied by another print item, a message will appear asking you if you wish to overwrite the other print item. To overwrite the other print item, touch the [Yes] key. To cancel the move, touch the [No] key.

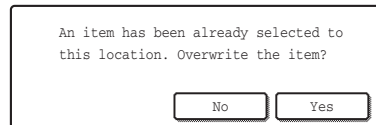

8

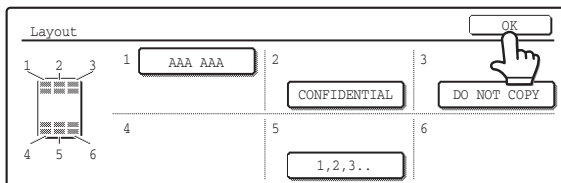

Touch the [OK] key.

9

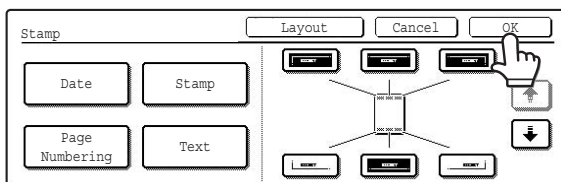

Touch the [OK] key.

REPEATING PHOTOS ON A COPY (Photo Repeat)

Photo Repeat is used to create repeated images of a photo-size original (130 x 90 mm size, 100 x 150 mm size, 70 x 100 mm size, 65 x 70 mm size or 57 x 100 mm size (3" x 5" size, 5" x 7" size, 2-1/2" x 4" size or 2-1/2" x 2-1/2" size or 2-1/8" x 3-5/8" size)) on a single sheet of copy paper as shown below. Up to 24 images (when the image is 65 x 70 mm size (2-1/2" x 2-1/2" size)) can be repeated on a single sheet of paper.

• **Original size (to 130 x 90 mm (3" x 5"))**

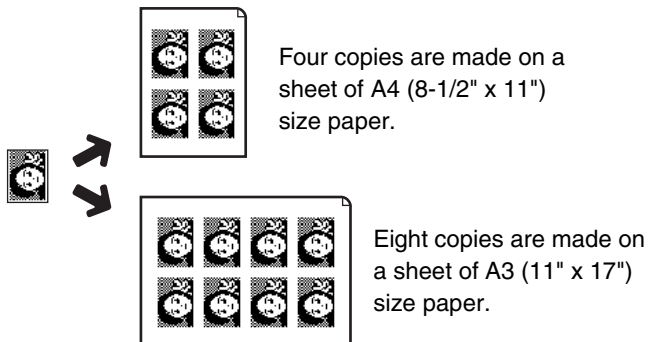

• **Original size (to 100 x 150 mm (5" x 7"))**

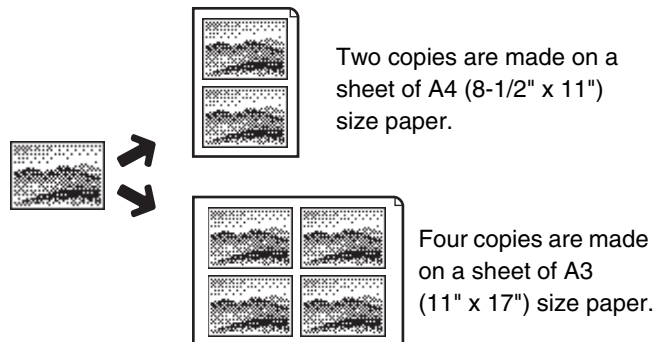

• **Original size (to 70 x 100 mm (2-1/2" x 4"))**

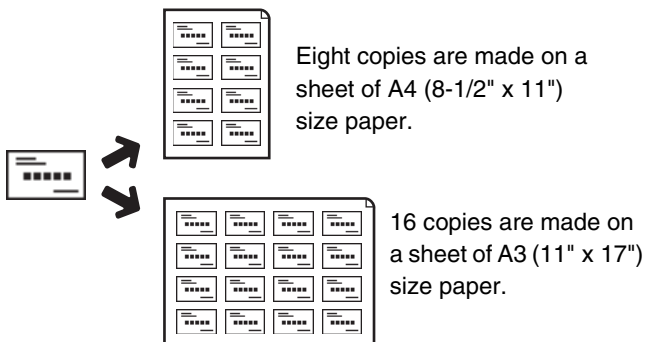

• **Original size (to 65 x 70 mm (2-1/2" x 2-1/2"))**

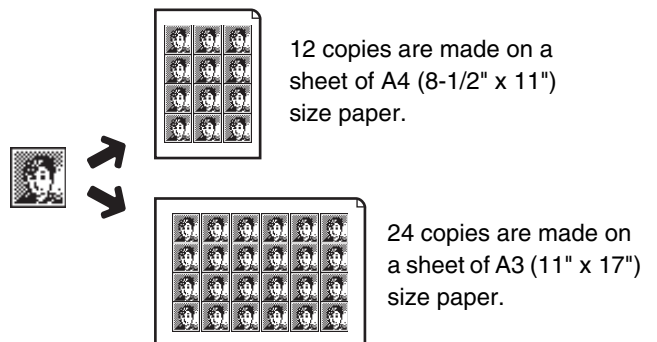

• **Original size (to 57 x 100 mm (2-1/8" x 3-5/8"))**

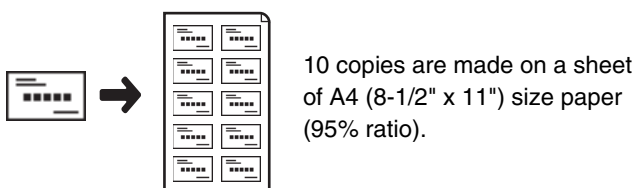

1

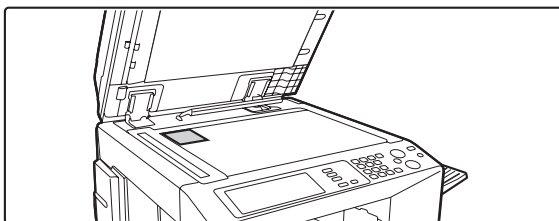

Place the original face down on the document glass.

- When placing an 130 x 90 mm, 100 x 150 mm, 70 x 100 mm, 65 x 70 mm or 57 x 100 mm (3" x 5", 5" x 7", 2-1/2" x 4", 2-1/2" x 2-1/2" or 2-1/8" x 3-5/8") photo size original, place the original with the long side aligned against the left side of the document glass.
- When placing a business card size original, place the original with the long side aligned against the far side of the document glass.

2

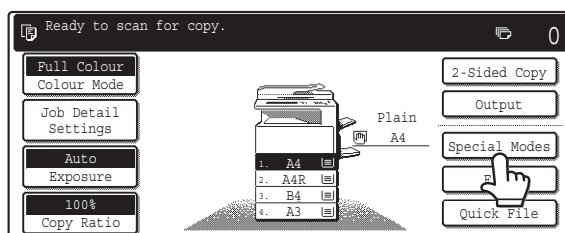

Touch the [Special Modes] key.

3

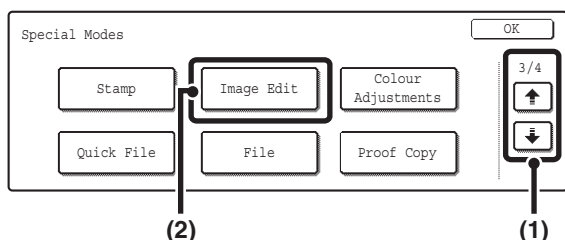

Select Image Edit.

- (1) Touch the keys to switch through the screens.
- (2) Touch the [Image Edit] key.

4

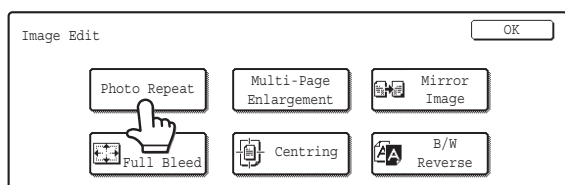

Touch the [Photo Repeat] key.

5

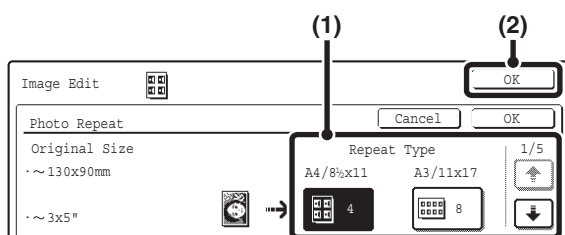

(1) Touch the key showing the original type and paper size combination that you wish use.

Touch the keys to switch through the screens and touch the desired repeat type key (A4 or A3) (8-1/2" x 11" or 11" x 17").

(2) Touch the [OK] key.

When the [OK] key is touched, you will return to the special mode screen. Touch the [OK] key to return to the base screen of the copy mode.



When making repeat copies of a business card size original (up to 57 x 100 mm (2-1/8" x 3-5/8")), only A4 (8-1/2" x 11") can be selected for the paper size.

6



or



Press the [COLOUR START] key (●●●●) or the [BLACK & WHITE START] key (●●).

Copying of the original on the document glass begins.

If you are using the sort function or other function that requires all originals to be scanned before the copies are printed, you must use the same [START] key that you used to scan the first original to scan each of the remaining originals.



To cancel scanning of the original and copying...

Press the [STOP] key (⊘).



- The original must be placed on the document glass.
- Only A4 (8-1/2" x 11") or A3 (11" x 17") size paper can be used.
- The copy ratio is 100% when this function is used. (The ratio cannot be changed.) However, for a business card size original (up to 57 x 100 mm (2-1/8" x 3-5/8")), the images are reduced to 95%.



To cancel the photo repeat setting...

Touch the [Cancel] key in the screen of step 5.

CREATING A LARGE POSTER (Multi-Page Enlargement)

This function is used to enlarge an image of an original and print it as a composite image using multiple sheets of paper.

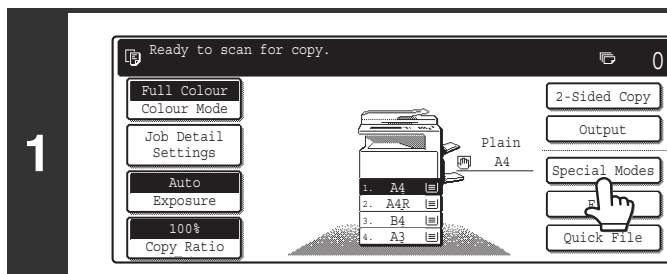
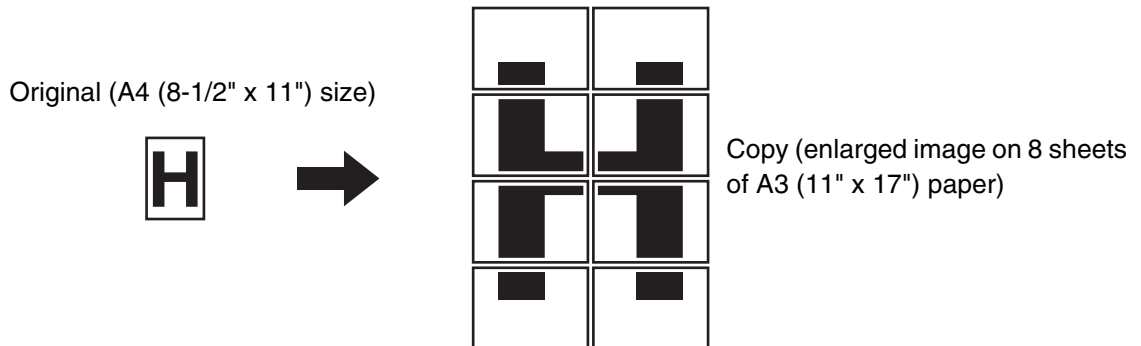

Touch the [Special Modes] key.

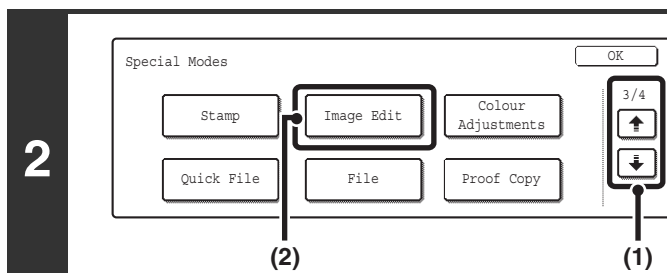

Select Image Edit.

- (1) Touch the keys to switch through the screens.
- (2) Touch the [Image Edit] key.

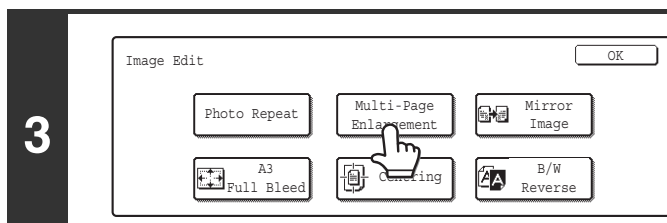

Touch the [Multi-Page Enlargement] key.

A sizes

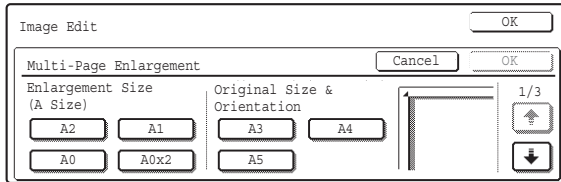

B sizes

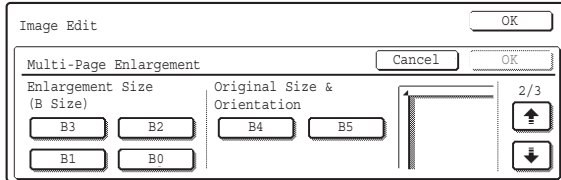

Inch sizes

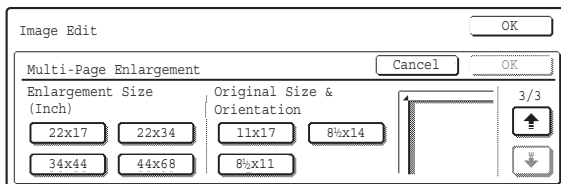

Select the size system that you wish to use for multi-page enlargement.

Touch the keys to display the screen that shows the desired group of sizes.

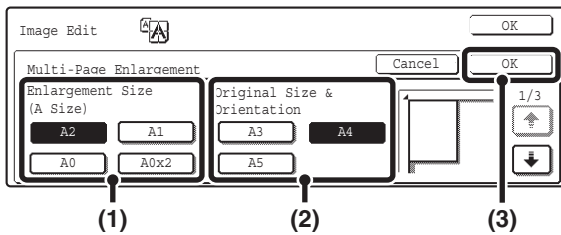

Set the enlargement size and the original size.

- (1) Select the enlargement size.
- (2) Select the size of the original to be used.

A suitable original placement orientation and the number of sheets of paper required for the enlarged image are displayed based on the selected original size and enlargement size. Check the placement orientation and the number of sheets of paper to be used for the enlarged image. The following combinations of original sizes and enlargement sizes are possible for multi-page enlargement.

Enlargement size ↔ Original size	
A system	A2 ↔ A3, A4, A5
	A1 ↔ A3, A4, A5
	A0 ↔ A3, A4
	A0 x 2* ↔ A3
B system	B3 ↔ B4, B5
	B2 ↔ B4, B5
	B1 ↔ B4, B5
	B0 ↔ B4
Inch system	22" x 17" ↔ 11" x 17", 8-1/2" x 14", 8-1/2" x 11"
	22" x 34" ↔ 11" x 17", 8-1/2" x 14", 8-1/2" x 11"
	34" x 44" ↔ 11" x 17", 8-1/2" x 14", 8-1/2" x 11"
	44" x 68" ↔ 11" x 17"

* The size that is twice A0 size.



An A size original cannot be enlarged to a B size, and a B size original cannot be enlarged to an A size.

6

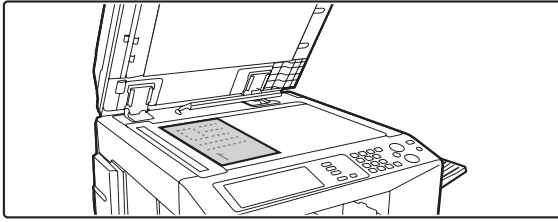

Place the original face down on the document glass in the orientation indicated in the screen.

7

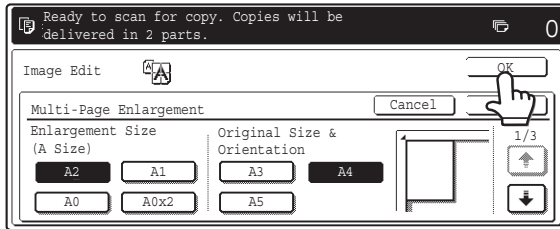

Touch the [OK] key.

When the [OK] key is touched, you will return to the special mode screen. Touch the [OK] key to return to the base screen of the copy mode.

8

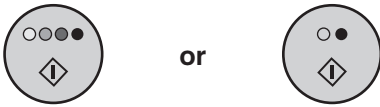

Press the [COLOUR START] key (○●●●) or the [BLACK & WHITE START] key (○●).

Copying of the original on the document glass begins.

If you are using the sort function or other function that requires all originals to be scanned before the copies are printed, you must use the same [START] key that you used to scan the first original to scan each of the remaining originals.



To cancel scanning of the original and copying...

Press the [STOP] key (⏹).



- Overlap of sections of image
- There will be a margin around the edges of each copy.
- Areas for overlapping the copies will be created at the leading and trailing edges of each copy.
- If an original size is selected first, a message will appear indicating the enlargement sizes that can be selected. If an enlargement size is selected first, a message will appear indicating the original sizes that can be selected.
- If a combination of settings is selected for which multi-page enlargement is not possible, invalid selection beeps will sound.
- The paper size, number of sheets required for the enlarged image, and the ratio are automatically selected based on the selected original size and enlargement size. (The paper size and ratio cannot be selected manually.)
- If no paper trays have the size of paper that was automatically selected, "Load XXX paper" will appear. Change the paper in one of the trays or the bypass tray to the indicated size of paper.
- The original must be placed on the document glass.



To cancel the multi-page enlargement setting...

Touch the [Cancel] key in the screen of step 5.

REVERSING THE IMAGE (Mirror Image)

This feature is used to make a copy that is a mirror image of the original.

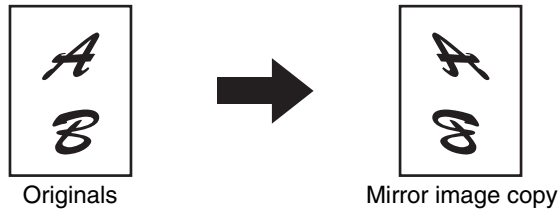

1

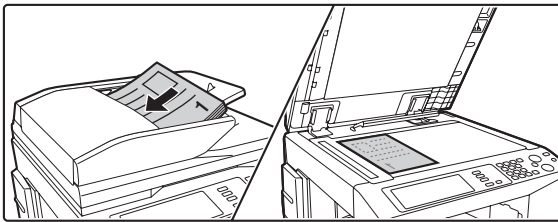

Place the original.

Place the original face up in the document feeder tray, or face down on the document glass.

2

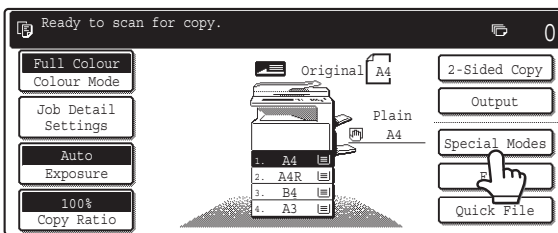

Touch the [Special Modes] key.

3

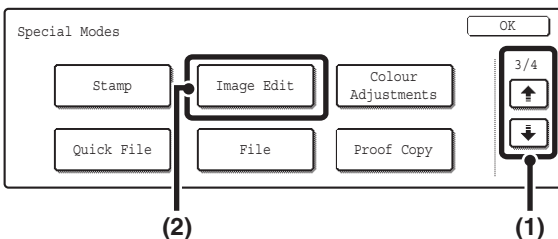

Select Image Edit.

- (1) Touch the keys to switch through the screens.
- (2) Touch the [Image Edit] key.

4

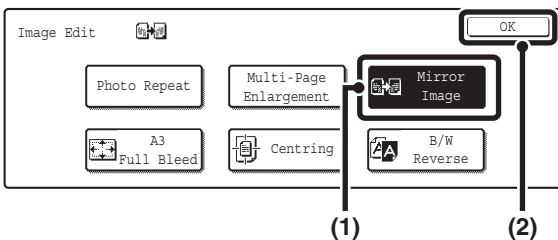

Select Mirror Image.

- (1) Touch the [Mirror Image] key so that it is highlighted.
- (2) Touch the [OK] key.

When the [OK] key is touched, you will return to the special mode screen. Touch the [OK] key to return to the base screen of the copy mode.



or



Press the [COLOUR START] key (○●●●) or the [BLACK & WHITE START] key (○●).

Copying will begin.

- If the originals were placed in the document feeder tray, the originals are copied.
- If you are using the document glass, copy each page one page at a time.

If you are using the sort function or other function that requires all originals to be scanned before the copies are printed, you must use the same [START] key that you used to scan the first original to scan each of the remaining originals.



To cancel scanning of the original and copying...

Press the [STOP] key (⏏).



To cancel the mirror image setting...

Touch the [Mirror Image] key in the screen of step 4 so that it is not highlighted.

COPYING A3 (11" x 17") SIZE ORIGINAL WITHOUT CUTTING OFF THE EDGES (A3 (11x17) Full Bleed)

This feature lets you copy an entire A3 (11" x 17") size original at full size with no image cut-off at the edges. A3W (12" x 18") size is used, which is slightly larger than A3 (11" x 17") size.

A3 (11" x 17") size original

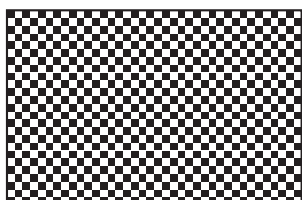

A3 (12" x 18") full bleed copy

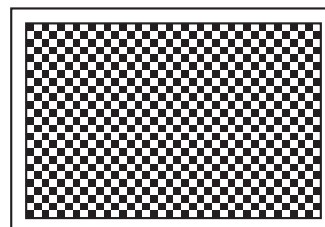

1

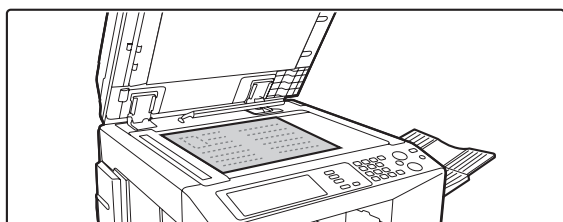

Place the original face down on the document glass.

2

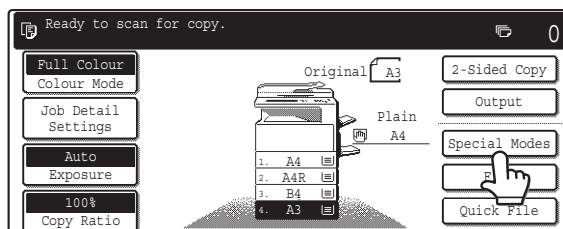

Touch the [Special Modes] key.

3

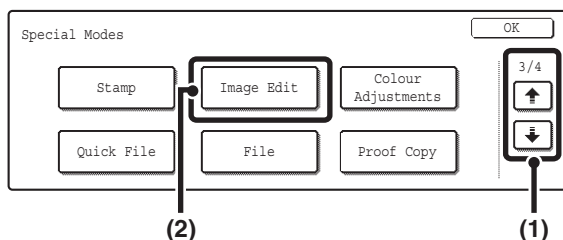

Select Image Edit.

- (1) Touch the keys to switch through the screens.
- (2) Touch the [Image Edit] key.

4

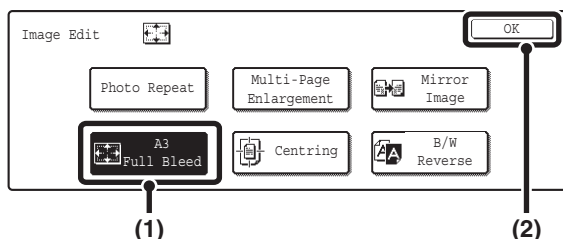

Select A3 Full Bleed (11x17 Full Bleed).

- (1) Touch the [A3 Full Bleed] key ([11x17 Full Bleed] key) so that it is highlighted.
- (2) Touch the [OK] key.

When the [OK] key is touched, you will return to the special mode screen. Touch the [OK] key to return to the base screen of the copy mode.

5

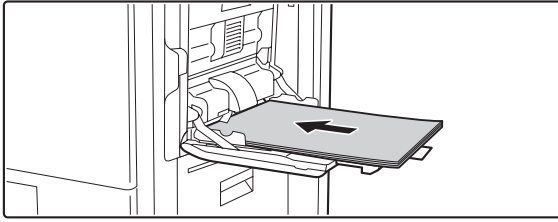

Place A3W (12" x 18") paper in the bypass tray.

Pull out the extension tray, adjust the guides to the width of A3W (12" x 18") paper, and place the paper in the bypass tray.

6

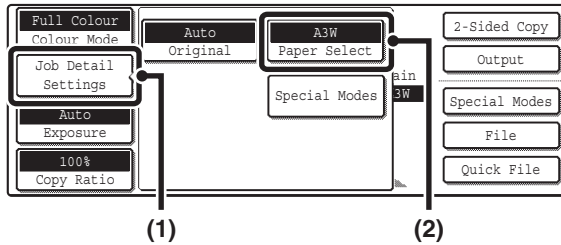

Open the paper settings screen.

- (1) Touch the [Job Detail Settings] key.
- (2) Touch the [Paper Select] key.

7

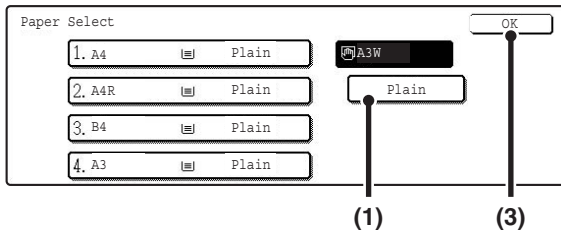

Select settings for A3W (12" x 18") paper.

- (1) Touch the appropriate paper type key.

Touch the key that shows the type of A3W (12" x 18") paper you loaded.

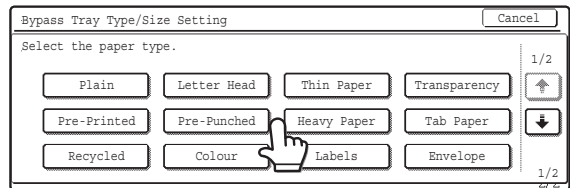

- (2) Touch the [OK] key.

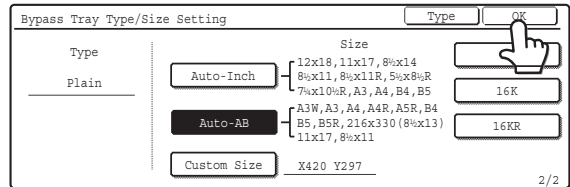

- (3) Touch the [OK] key.

When the [OK] key is touched, you will return to the job detail setting screen. Touch the [Job Detail Settings] key to return to the base screen of copy mode.

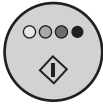

or



Press the **[COLOUR START]** key (○●●●) or the **[BLACK & WHITE START]** key (○●).

Copying of the original on the document glass begins.

If you are using the sort function or other function that requires all originals to be scanned before the copies are printed, you must use the same [START] key that you used to scan the first original to scan each of the remaining originals.



To cancel scanning of the original and copying...

Press the [STOP] key (⏏).



- This function can be used when a right tray, a finisher, or a saddle stitch finisher is installed.
- The copy ratio is 100% when this function is used. The ratio cannot be changed.
- Automatic 2-sided copying is not possible.
- The punch function cannot be used.
- The original must be placed on the document glass.



To cancel A3 Full Bleed (11x17 Full Bleed)...

Touch the [A3 Full Bleed] key ([11x17 Full Bleed] key) in the screen of step 4 so that it is not highlighted.

COPYING IN THE CENTRE OF THE PAPER (Centring)

This is used to centre the copied image on the paper.

This lets you place the image in the centre of the paper when the original size is smaller than the paper size or when the image is reduced.

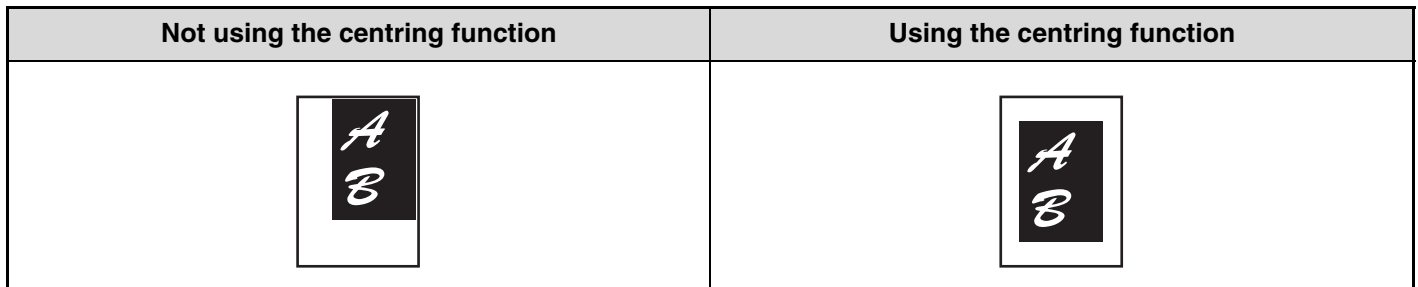

1

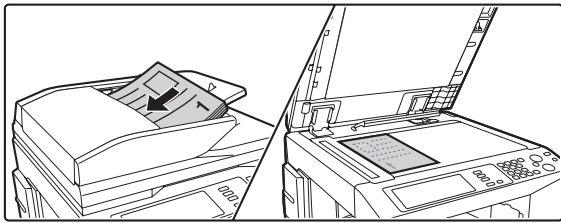

Place the original.

Place the original face up in the document feeder tray, or face down on the document glass.

2

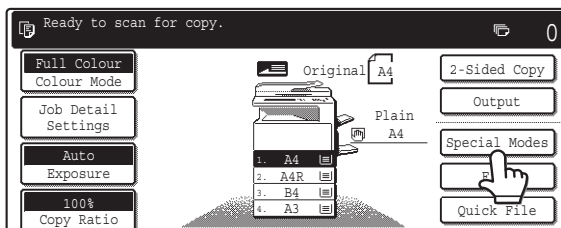

Touch the [Special Modes] key.

3

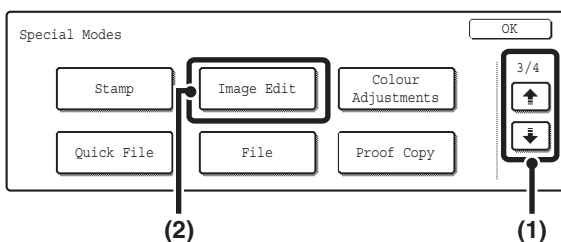

Select Image Edit.

- (1) Touch the   keys to switch through the screens.
- (2) Touch the [Image Edit] key.

4

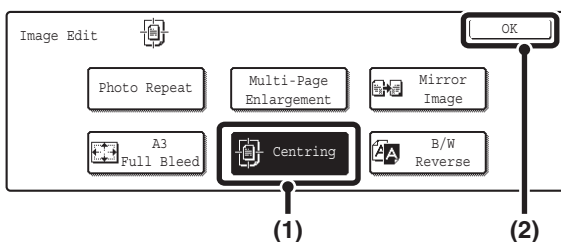

Select Centring.

- (1) Touch the [Centring] key so that it is highlighted.
- (2) Touch the [OK] key.

When the [OK] key is touched, you will return to the special mode screen. Touch the [OK] key to return to the base screen of the copy mode.

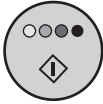

or



Press the [COLOUR START] key (○●●●) or the [BLACK & WHITE START] key (○●).

Copying will begin.

- If the originals were placed in the document feeder tray, the originals are copied.
- If you are using the document glass, copy each page one page at a time.

If you are using the sort function or other function that requires all originals to be scanned before the copies are printed, you must use the same [START] key that you used to scan the first original to scan each of the remaining originals.



To cancel scanning of the original and copying...

Press the [STOP] key (⊘).



- The image can be reduced when using the Centring function, but not enlarged.
- When the original size or the paper size is displayed as a special size, this function cannot be used.



To cancel centring...

Touch the [Centring] key in the screen of step 4 so that it is not highlighted.

REVERSING BLACK AND WHITE IN A COPY (B/W Reverse)

This is used to reverse black and white in a copy to create a negative image. This function can only be used for black and white copying.

Originals with large black areas (which use a large amount of toner) can be copied using Black/White Reverse to reduce toner consumption.

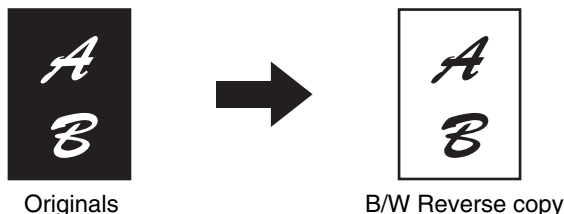

1

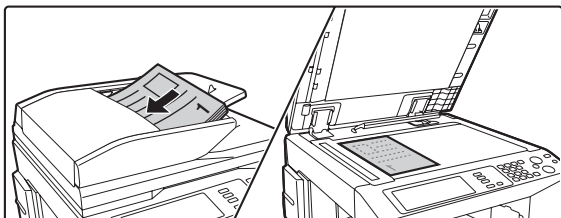

Place the original.

Place the original face up in the document feeder tray, or face down on the document glass.

2

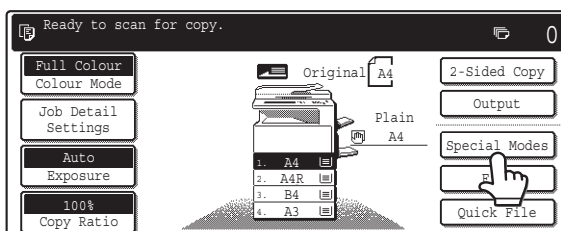

Touch the [Special Modes] key.

3

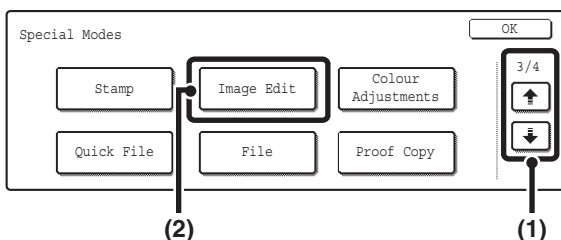

Select Image Edit.

(1) Touch the keys to switch through the screens.

(2) Touch the [Image Edit] key.

4

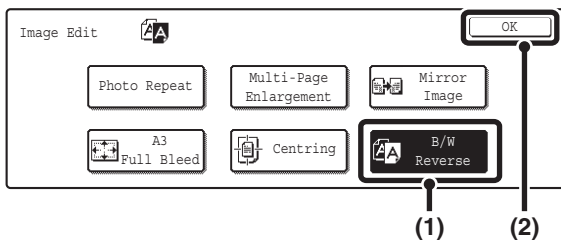

Select B/W Reverse.

(1) Touch the [B/W Reverse] key so that it is highlighted.

(2) Touch the [OK] key.

When the [OK] key is touched, you will return to the special mode screen. Touch the [OK] key to return to the base screen of the copy mode.



Press the [BLACK & WHITE START] key (○●).

Copying will begin.

- If the originals were placed in the document feeder tray, the originals are copied.
- If you are using the document glass, copy each page one page at a time.



When using this function, the [COLOUR START] key (○●●●) cannot be used.



To cancel scanning of the original and copying...

Press the [STOP] key (⊘).



- When this function is selected, the exposure mode setting automatically changes to "Text".
- This function is not available in some countries and regions.



To cancel B/W reverse...

Touch the [B/W Reverse] key in the screen of step 4 so that it is not highlighted.

ADJUSTING RED/GREEN/BLUE IN COPIES (RGB Adjust)

This feature is used to strengthen or weaken any one of the three colour components R (red), G (green), or B (blue). For an image adjustment example, see "Adjusting red/green/blue in copies (RGB Adjust)" in the Quick Start Guide.

1

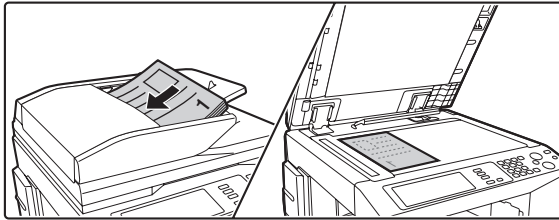

Place the original.

Place the original face up in the document feeder tray, or face down on the document glass.

2

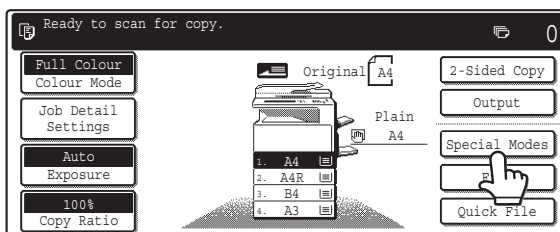

Touch the [Special Modes] key.

3

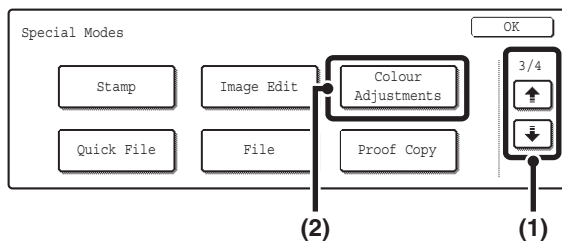

Select Colour Adjustments.

- (1) Touch the   keys to switch through the screens.
- (2) Touch the [Colour Adjustments] key.

4

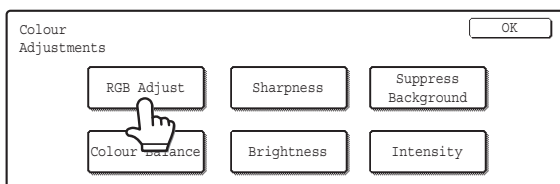

Touch the [RGB Adjust] key.

5

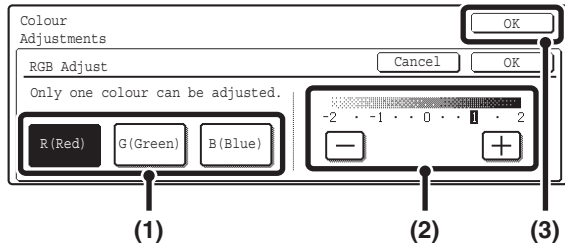

Adjust red, green, or blue.

- (1) Touch the key of the colour that you wish to adjust: [R (Red)], [G (Green)], or [B (Blue)].

Only one colour can be adjusted. (If you adjust one colour and then adjust another colour, the adjustment of the first colour is cancelled.)

- (2) Adjust the selected colour.

Touch the [+] key to strengthen the selected colour, or touch the [-] key to weaken the colour.

- (3) Touch the [OK] key.

When the [OK] key is touched, you will return to the special mode screen. Touch the [OK] key to return to the base screen of the copy mode.

6

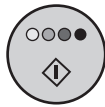

Press the [COLOUR START] key

(○●●●).

Copying will begin.

- If the originals were placed in the document feeder tray, the originals are copied.
- If you are using the document glass, copy each page one page at a time.



To cancel scanning of the original and copying...

Press the [STOP] key (⏹).



To cancel the RGB adjust setting...

Touch the [Cancel] key in the screen of step 5.

ADJUSTING THE SHARPNESS OF AN IMAGE (Sharpness)

This is used to sharpen an image or make it softer.

For an image adjustment example, see "Adjusting the sharpness of an image (Sharpness)" in the Quick Start Guide.

1

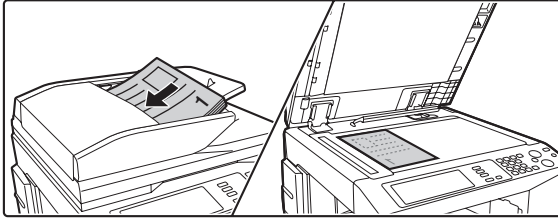

Place the original.

Place the original face up in the document feeder tray, or face down on the document glass.

2

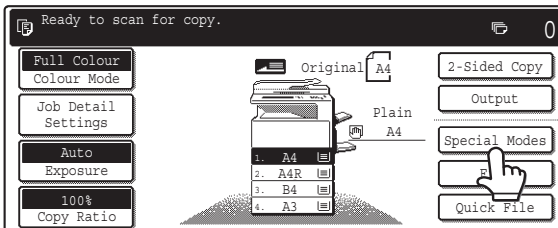

Touch the [Special Modes] key.

3

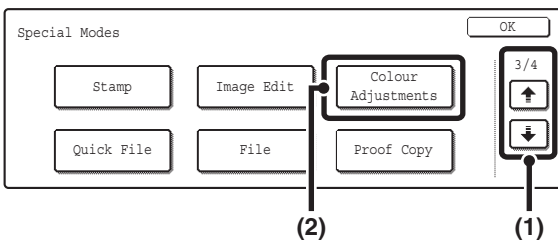

Select Colour Adjustments.

(1) Touch the   keys to switch through the screens.

(2) Touch the [Colour Adjustments] key.

4

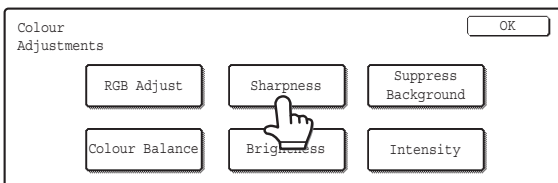

Touch the [Sharpness] key.

5

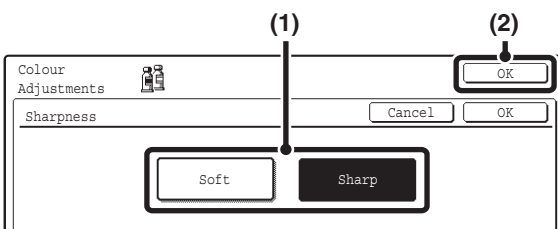

Adjust the image.

(1) Touch the [Soft] key or the [Sharp] key.

(2) Touch the [OK] key.

When the [OK] key is touched, you will return to the special mode screen. Touch the [OK] key to return to the base screen of the copy mode.

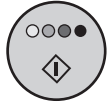

**Press the [COLOUR START] key
(○●●●).**

Copying will begin.

- If the originals were placed in the document feeder tray, the originals are copied.
- If you are using the document glass, copy each page one page at a time.



To cancel scanning of the original and copying...

Press the [STOP] key (⏹).



To cancel the sharpness setting...

Touch the [Cancel] key in the screen of step 5.

WHITENING FAINT COLOURS IN COPIES (Suppress Background)

This feature is used to suppress light background areas.



1

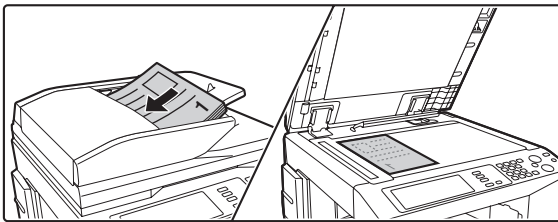

Place the original.

Place the original face up in the document feeder tray, or face down on the document glass.

2

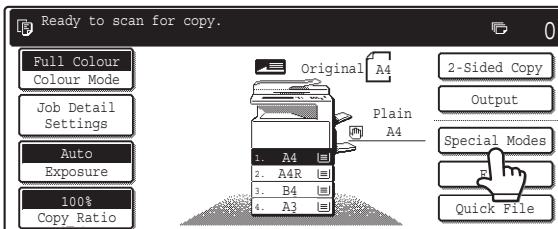

Touch the [Special Modes] key.

3

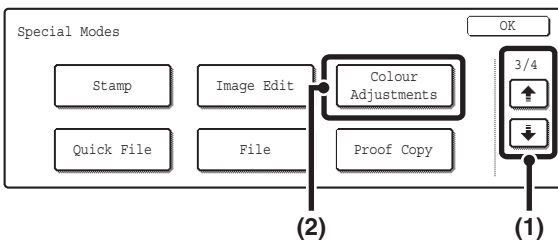

Select Colour Adjustments.

- (1) Touch the keys to switch through the screens.
- (2) Touch the [Colour Adjustments] key.

4

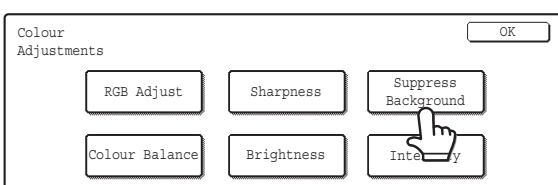

Touch the [Suppress Background] key.

5

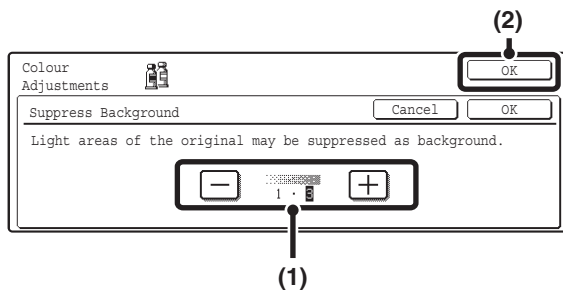

Select suppress background settings.

(1) Adjust the background suppression level.

To strengthen the background suppression level (suppress darker backgrounds), touch the [-] key. To weaken the level (suppress only light backgrounds), touch the [+] key.

(2) Touch the [OK] key.

When the [OK] key is touched, you will return to the special mode screen. Touch the [OK] key to return to the base screen of the copy mode.

6

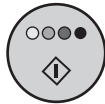

Press the [COLOUR START] key

(○●●●).

Copying will begin.

- If the originals were placed in the document feeder tray, the originals are copied.
- If you are using the document glass, copy each page one page at a time.



To cancel scanning of the original and copying...

Press the [STOP] key (⏹).



To cancel the suppress background settings...

Touch the [Cancel] key in the screen of step 5.

ADJUSTING THE COLOUR (Colour Balance)

The colour, tone, and density of colour copies can be adjusted.

For an image adjustment example, see "Adjusting the colour (Colour Balance)" in the Quick Start Guide.

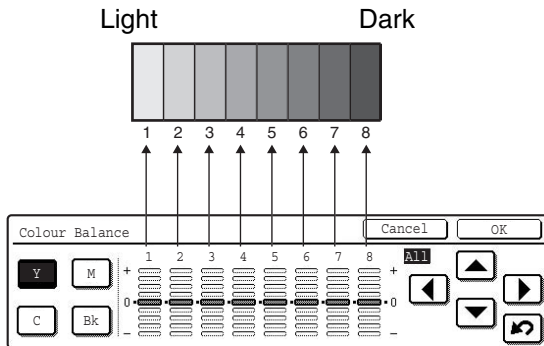

Each of the colours yellow, cyan, magenta, and black are divided into 8 gradations from light to dark, and the average density of each gradation can be adjusted, Each of the 8 gradations can be adjusted separately, or all eight gradations can be adjusted at once.

1

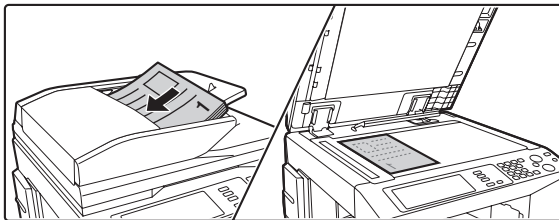

Place the original.

Place the original face up in the document feeder tray, or face down on the document glass.

2

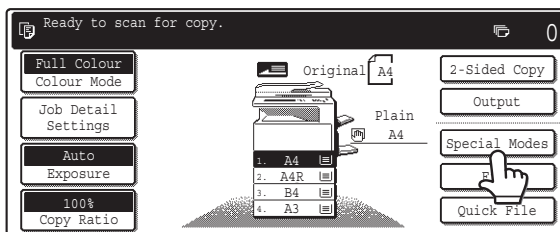

Touch the [Special Modes] key.

3

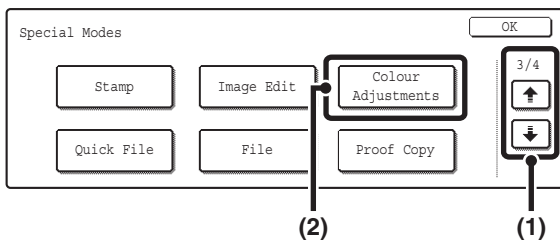

Select Colour Adjustments.

(1) Touch the \downarrow \uparrow keys to switch through the screens.

(2) Touch the [Colour Adjustments] key.

4

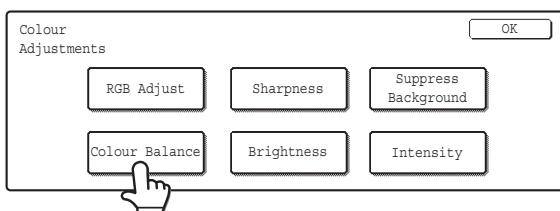

Touch the [Colour Balance] key.

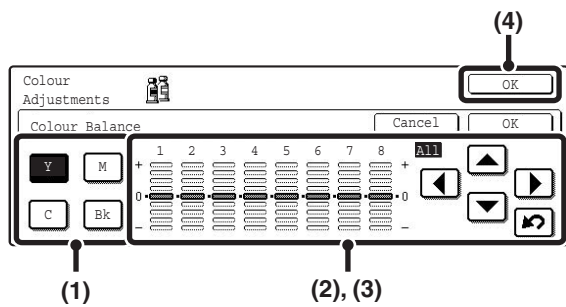

Adjust the colour balance.

Examples of colour balance adjustment

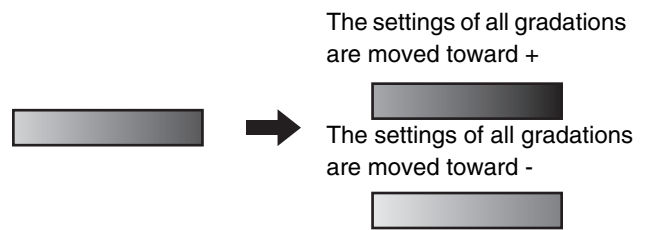

(1) Select the colour to be adjusted.

Select [Y] (yellow), [M] (magenta), [C] (cyan), or [Bk] (black).

If only the rectangular area around the letter in a key is highlighted, the settings have been changed from the factory default settings.

(2) Select the gradation to be adjusted.

Select the gradation with the keys.

Touch the keys to move the highlighting to one of gradations "1" to "8" or "All".

To adjust all eight gradations at once, move the highlighting to "All".

(3) Adjust the density.

To darken the density of the selected gradation, touch the key. To lighten the density, touch the key. Each time one of the keys is touched, the indicator frame moves up or down one level.

(4) Touch the [OK] key.

When the [OK] key is touched, you will return to the special mode screen. Touch the [OK] key to return to the base screen of the copy mode.



To return the colour balance values to the default settings...

Touch the key. The values of all 8 gradations return to the default colour balance values.

The default colour balance values are set in "Initial Colour Balance Setting" in the system settings (administrator).

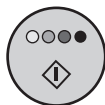

Press the [COLOUR START] key (○●●●).

Copying will begin.

- If the originals were placed in the document feeder tray, the originals are copied.
- If you are using the document glass, copy each page one page at a time.



To cancel scanning of the original and copying...

Press the [STOP] key ().



To cancel the colour balance setting...

Touch the [Cancel] key in the screen of step 5.



System Settings (Administrator): Initial Colour Balance Setting

This is used to set the default values to which the colour balance values return when the key is pressed.

ADJUSTING THE BRIGHTNESS OF A COPY (Brightness)

The brightness of colour images can be adjusted.

For an image adjustment example, see "Adjusting the brightness of a copy (Brightness)" in the Quick Start Guide.

1

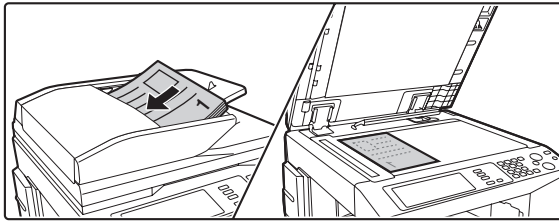

Place the original.

Place the original face up in the document feeder tray, or face down on the document glass.

2

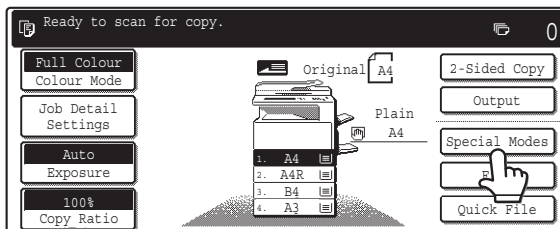

Touch the [Special Modes] key.

3

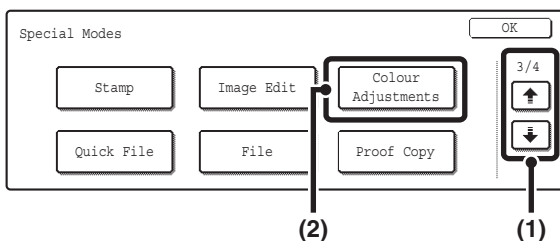

Select Colour Adjustments.

(1) Touch the keys to switch through the screens.

(2) Touch the [Colour Adjustments] key.

4

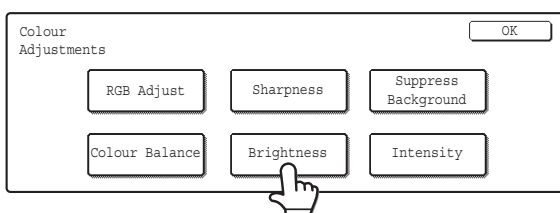

Touch the [Brightness] key.

5

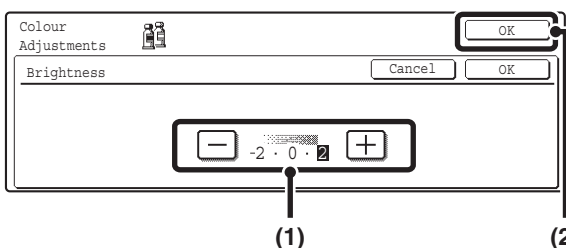

Adjust the brightness.

(1) Adjust the brightness.

Touch the [+] key to make the image brighter, or the [-] key to make the image darker.

(2) Touch the [OK] key.

When the [OK] key is touched, you will return to the special mode screen. Touch the [OK] key to return to the base screen of the copy mode.

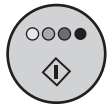

Press the [COLOUR START] key
(○●●●).

Copying will begin.

- If the originals were placed in the document feeder tray, the originals are copied.
- If you are using the document glass, copy each page one page at a time.



To cancel scanning of the original and copying...

Press the [STOP] key (⏹).



To cancel the brightness setting...

Touch the [Cancel] key in the screen of step 5.

ADJUSTING THE INTENSITY OF A COPY (Intensity)

This is used to adjust the intensity (saturation) of colour images.

For an image adjustment example, see "Adjusting the intensity of a copy (Intensity)" in the Quick Start Guide.

1

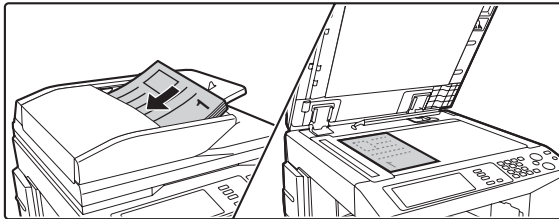

Place the original.

Place the original face up in the document feeder tray, or face down on the document glass.

2

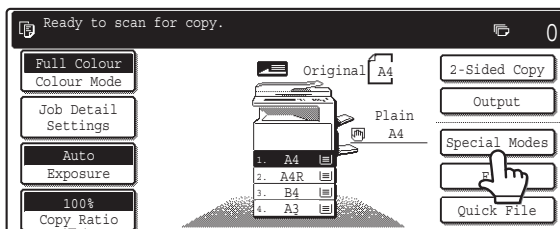

Touch the [Special Modes] key.

3

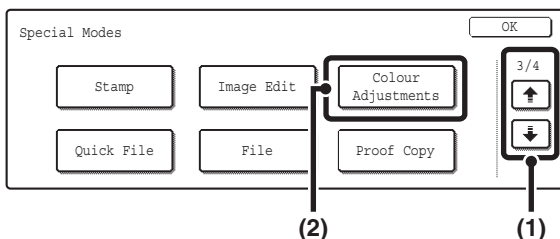

Select Colour Adjustments.

(1) Touch the   keys to switch through the screens.

(2) Touch the [Colour Adjustments] key.

4

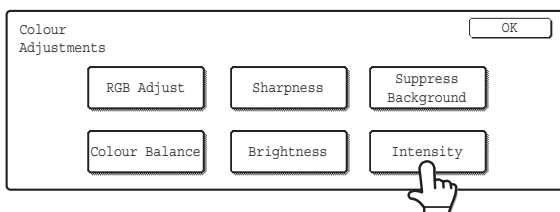

Touch the [Intensity] key.

5

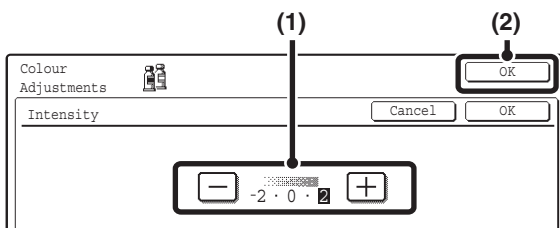

Adjust the intensity.

(1) Adjust the intensity.

Touch the [+] key to strengthen the intensity, or the [-] key to weaken the intensity.

(2) Touch the [OK] key.

You will return to the base screen of copy mode.

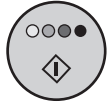

Press the [COLOUR START] key
(○●●●).

Copying will begin.

- If the originals were placed in the document feeder tray, the originals are copied.
- If you are using the document glass, copy each page one page at a time.



To cancel scanning of the original and copying...

Press the [STOP] key (◀).



This function cannot be used in combination with "Colour Tone Enhancement" in the copy exposure settings.



To cancel the intensity setting...

Touch the [Cancel] key in the screen of step 5.

CHECKING COPIES BEFORE PRINTING (Proof Copy)

This feature prints only one set of copies, regardless of how many sets have been specified. After the first set is checked for errors, the remaining sets can be printed. Normally it is necessary to re-scan the original each time changes to settings are required. However, this feature makes it possible to change settings for the scanned original without scanning it again, allowing you perform copying more efficiently.

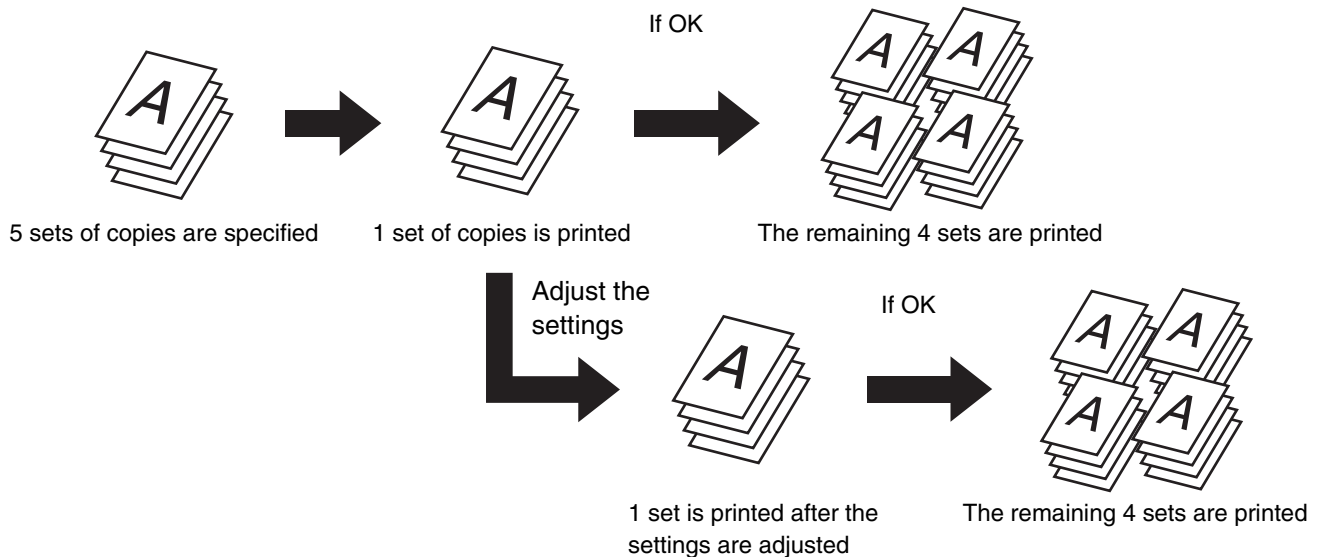

1

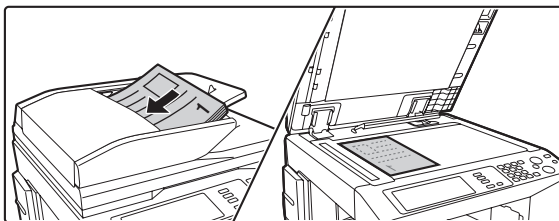

Place the original.

Place the original face up in the document feeder tray, or face down on the document glass.

2

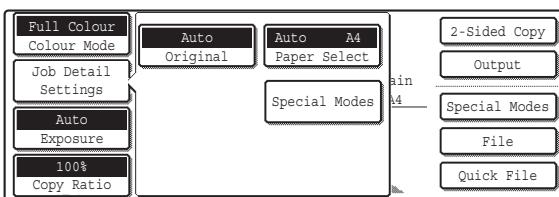

Select copy settings.

3

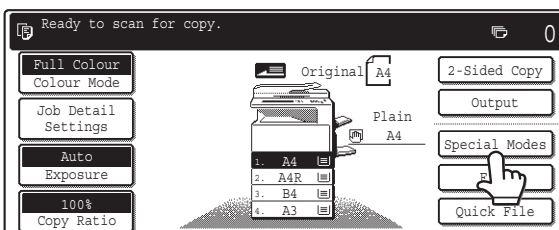

Touch the [Special Modes] key.

4

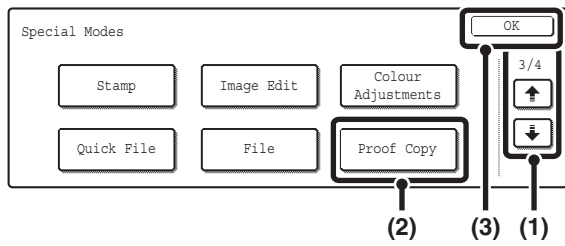

Select Proof Copy.

- (1) Touch the keys to switch through the screens.
- (2) Touch the [Proof Copy] key.
- (3) Touch the [OK] key.

5

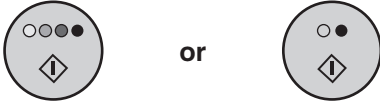

Press the [COLOUR START] key (●●●●) or the [BLACK & WHITE START] key (●●).



To cancel copying...

Press the [STOP] key (⊘).

6

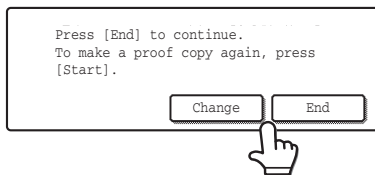

If there are no problems with the first set that is printed, touch the [End] key. If you need to make changes, touch the [Change] key.

If the [End] key is touched, the remaining sets are printed. If you touched the [Change] key, go to the next step.



To cancel copying...

Press the [STOP] key (⊘).

7

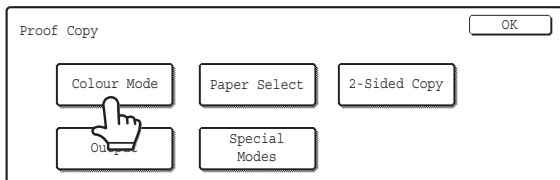

Select the settings that you wish to change.

After changing a setting, touch the [OK] key in that screen. You will return to this screen.

- Special modes that can be adjusted are margin shift, pamphlet copy, tandem copy, covers/inserts, transparency inserts, multi shot, and stamp.
- For pamphlet copy, covers/inserts and multi shot, only changes to the settings of those functions can be made; neither of these functions can be newly added or deleted.
- For the transparency insert function, settings can be changed and the function can be newly added when changes are made to the settings; however, if the transparency insert function has been previously selected, it cannot be cancelled.

8

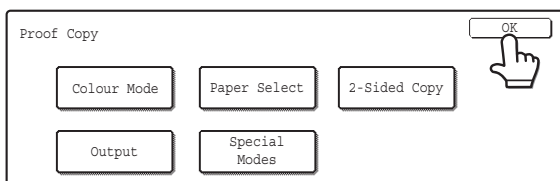

Touch the [OK] key.

9



or



Press the [COLOUR START] key (○●●●) or the [BLACK & WHITE START] key (○●).

One set of copies is printed again using the adjusted settings. The number of sets does not change at this time.

If settings must be adjusted again, repeat steps 6 through 9 until there are no problems.

When you are ready to print the remaining sets, go to the next step.

10

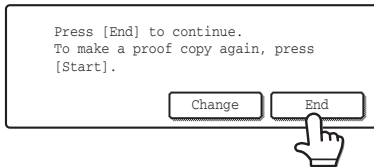

Touch the [End] key.

You will return to the base screen of copy mode and the remaining sets will be printed.



To cancel scanning of the original and copying...

Press the [STOP] key (⏹).



If proof copy is performed when the machine is already printing a copy job or other job, the job in progress will stop temporarily and the set of proof copies will be printed. The previous job will resume after the proof copies are printed. When the [End] key is touched, printing of the remaining sets will start after the copy job in progress is completed.

COPYING ORIGINALS OF DIFFERENT SIZES (Mixed Size Original)

Originals of mixed sizes can be copied together, such as A3 (11" x 17") originals mixed in with B4 (8-1/2" x 14") originals. When scanning the originals, the machine automatically detects the size of each original and uses paper appropriate for that size.

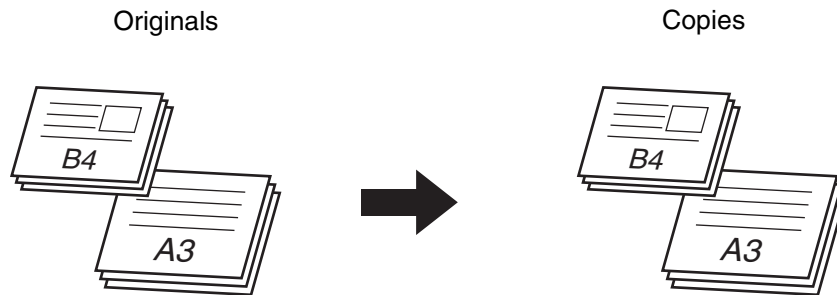

There are two settings for mixed size originals.

Same Width	<p>Use this setting for originals that are different sizes but have sides that are the same length. The originals are inserted in the document feeder tray with the sides that are the same length aligned together on the left.</p> <p>A3 and A4, B4 and B5, A4R and A5 (11" x 17" and 8-1/2" x 11", 8-1/2" x 14" and 8-1/2" x 11"R, 8-1/2" x 14" and 5-1/2" x 8-1/2", 8-1/2" x 13" and 8-1/2" x 11"R, 8-1/2" x 13" and 5-1/2" x 8-1/2", 8-1/2" x 11"R and 5-1/2" x 8-1/2")</p>
Different Width	<p>Use this setting when the originals are different sizes and do not have sides that are the same length. This setting can only be used for the following combinations of sizes:</p> <p>A3 and B4, B4 and A4R, A4 and B5, B5 and A5 (11" x 17" and 8-1/2" x 14", 11" x 17" and 8-1/2" x 13", 11" x 17" and 5-1/2" x 8-1/2")</p>

Insert the originals face up in the document feeder tray.

● When "Same Width" is used

Place the originals with the sides that are the same length aligned on the left.

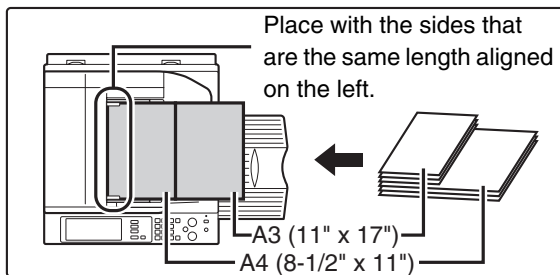

● When "Different Width" is used

Place the originals with the corners aligned in the far left corner of the document feeder tray.

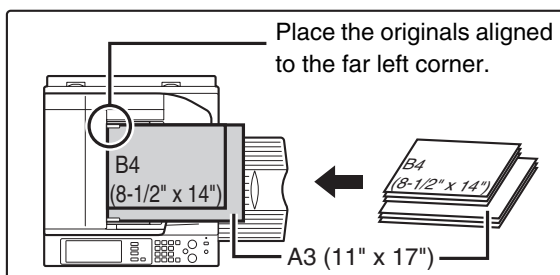

Touch the [Special Modes] key.

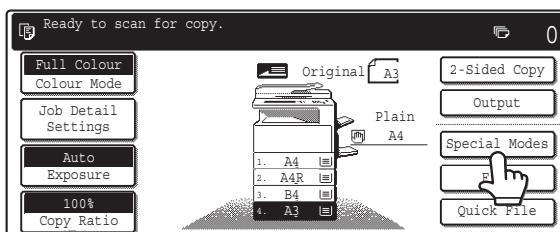

Select Mixed Size Original.

(1) Touch the keys to switch through the screens.

(2) Touch the [Mixed Size Original] key.

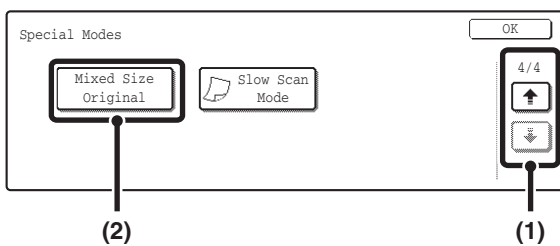

4

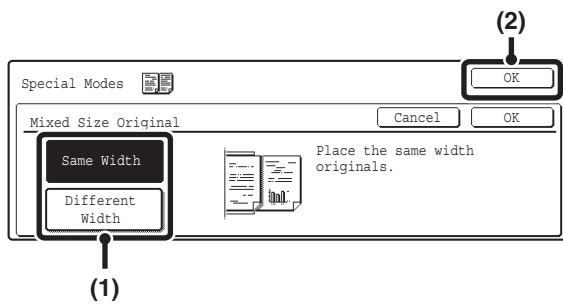

Select Mixed Size Original settings.

(1) Touch the [Same Width] key or the [Different Width] key as appropriate for the originals.

(2) Touch the [OK] key.

You will return to the base screen of copy mode.

5

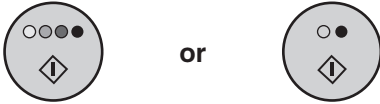

Press the [COLOUR START] key (○●●●) or the [BLACK & WHITE START] key (○●).

Copying of the originals in the document feeder tray begins.



To cancel scanning of the original and copying...

Press the [STOP] key (⊘).



- When "Different Width" is used on the MX-3501N/4501N, "2-Sided to 2-Sided" and "2-Sided to 1-Sided" of automatic two-sided copying can be used.
On other models, automatic two-sided copying cannot be used.
- When "Different Width" is used, the staple function cannot be used.
- "Different Width" cannot be used to place the same size of originals in different orientations.



To cancel the mixed size original setting...

Touch the [Cancel] key in the screen of step 4.

COPYING THIN ORIGINALS (Slow Scan Mode)

Use this function when you wish to scan thin originals using the automatic document feeder. This function helps prevent thin originals from misfeeding.

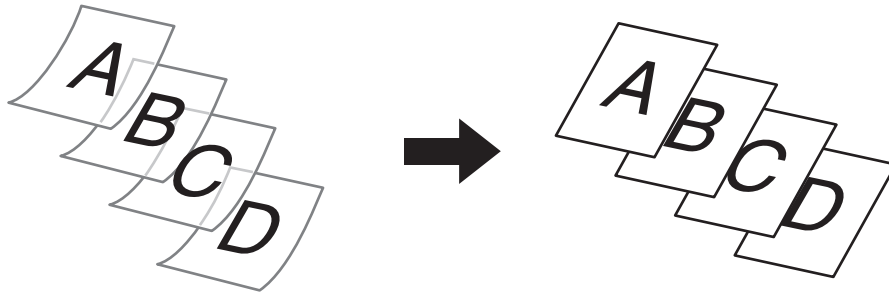

1

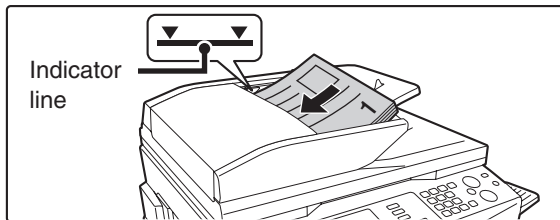

Place the originals face up in the document feeder tray with the edges aligned evenly.

Place the originals face up. Insert the originals all the way into the document feeder tray. The stack must not be higher than the indicator line.



If the originals are inserted with too much force, they may crumple and misfeed.

2

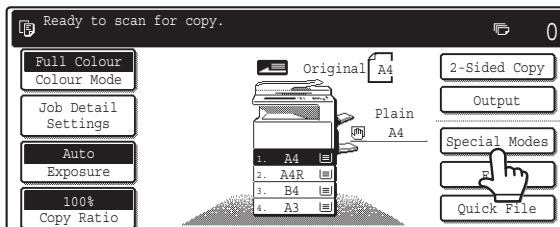

Touch the [Special Modes] key.

3

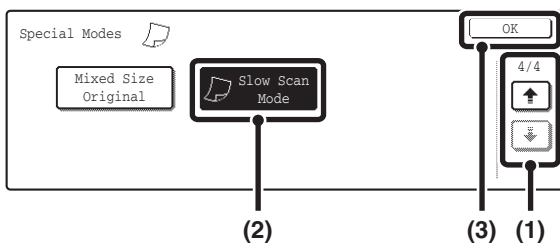

Select Slow Scan Mode.

- (1) Touch the keys to switch through the screens.
- (2) Touch the [Slow Scan Mode] key so that it is highlighted.
- (3) Touch the [OK] key.

You will return to the base screen of copy mode.

4



or



Press the [COLOUR START] key (○●●●) or the [BLACK & WHITE START] key (○●).

Copying of the originals in the document feeder tray begins.



To cancel scanning of the original and copying...

Press the [STOP] key (⏹).



The "2-Sided to 2-Sided" and "2-Sided to 1-Sided" modes of automatic two-sided copying cannot be used.



To cancel the slow scan mode setting...

Touch the [Slow Scan Mode] key in the screen of step 3 so that it is not highlighted.

STORING COPY OPERATIONS (Job Programs)

A job program is a group of copy settings stored together. When copy settings are stored in a job program, the settings can be called up and used for a copy job by means of a simple operation.

For example, suppose A3 (11" x 17") size CAD drawings are copied once a month for archive purposes using the following settings:

- (1) The A3 (11" x 17") size CAD drawings are reduced to A4 (8-1/2" x 11") size.
- (2) The drawings have fine lines that do not show clearly, and thus a dark exposure setting (level 4) is used.
- (3) To reduce paper use by a half, 2-sided copying is used.
- (4) Margin shift is used so that holes can be punched for filing.

A3 (11" x 17") size CAD drawings

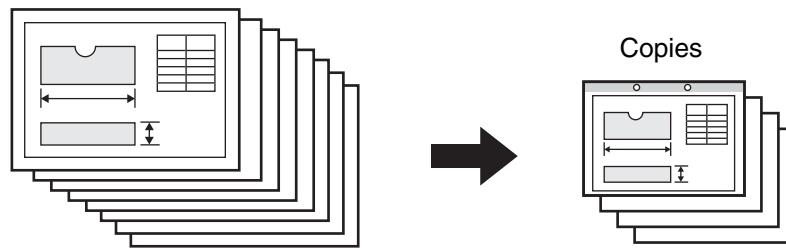

When a job program is not stored	When a job program is stored
<p>Set A3 (11" x 17") to A4 (8-1/2" x 11") reduction</p> <p style="text-align: center;">↓</p> <p>Change the exposure setting</p> <p style="text-align: center;">↓</p> <p>Select 2-sided copying</p> <p style="text-align: center;">↓</p> <p>Select margin shift</p> <p style="text-align: center;">↓</p> <p>Select punch hole settings</p> <p style="text-align: center;">↓</p> <div style="display: flex; justify-content: center; align-items: center;"> or </div> <p>Press the [COLOUR START] key or the [BLACK & WHITE START] key.</p>	<p style="text-align: center;"></p> <p style="text-align: center;">Press the [Program] key () .</p> <p style="text-align: center;">↓</p> <div style="border: 1px solid black; padding: 5px; width: fit-content; margin: 0 auto;"> <p style="text-align: right; margin: 0;">Exit</p> <p style="margin: 0;">Job Programs</p> <p style="margin: 0;">Press program number.</p> <div style="display: flex; justify-content: space-between; align-items: flex-start;"> <div style="display: flex; flex-wrap: wrap;"> <div style="margin: 2px;">1</div> <div style="margin: 2px;">2</div> <div style="margin: 2px;">3</div> <div style="margin: 2px;">4</div> <div style="margin: 2px;">5</div> <div style="margin: 2px;">6</div> <div style="margin: 2px;">7</div> <div style="margin: 2px;">8</div> </div> <div style="text-align: right; margin-top: 5px;"> <p>1/6</p> <p>↑</p> <p>↓</p> </div> </div> <p style="margin: 0; text-align: center;">Recall Store/Delete</p> </div> <p style="text-align: center;">Touch the stored program key.</p> <p style="text-align: center;">↓</p> <div style="display: flex; justify-content: center; align-items: center;"> or </div> <p>Press the [COLOUR START] key or the [BLACK & WHITE START] key.</p>
<p>Considerable time is required to copy the drawings each month because the above settings must be selected. In addition, mistakes are occasionally made when selecting the settings, so some copies must be redone.</p>	<p>The settings are stored in a job program, so they can be selected by the touch of a key. This is simple and takes no time. In addition, the settings are all stored so there are no chances for mistakes, and thus no need to redo copies due to setting mistakes.</p>

- Up to 48 job programs can be stored. The job programs are retained even if an interruption occurs in the power supply.
- Job programs can also be stored in the Web pages. Click [Job Program Registration] and then [Copier] in the Web page menu to store a job program.

STORING A JOB PROGRAM

The procedure for storing copy settings in a job program is explained below.

1

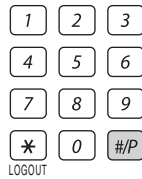

Press the [PROGRAM] key ().

2

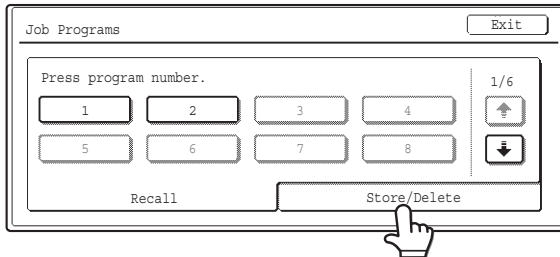

Touch the [Store/Delete] tab.

3

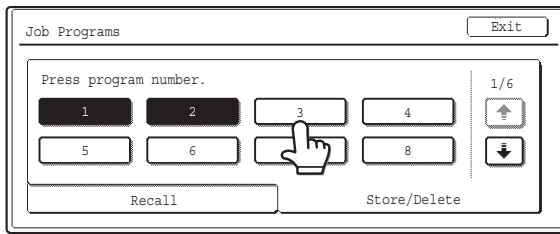

Touch a numeric key that is not highlighted.

Numeric keys in which job programs are already stored are highlighted.



If a highlighted numeric key is touched, the following screen appears. The [Store] key can be touched to delete the stored settings and store new settings.

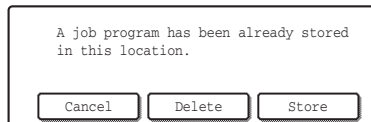

When "Disabling Deletion of Job Programs" is enabled in the system settings (administrator), this function cannot be used.

4

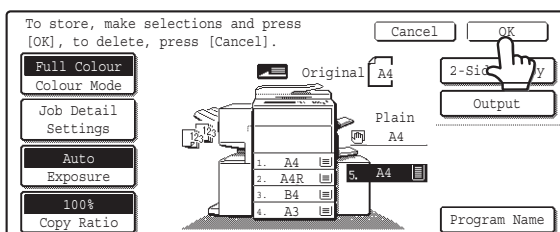

Select the copy settings that you wish to store in the job program and touch the [OK] key.

To assign a name to the program, touch the [Program Name] key. A text entry screen will appear.

Up to 10 characters can be entered for the name.

To enter text, see "6. ENTERING TEXT" in the User's Guide.

When you have finished entering the name, touch the [OK] key.



The number of copies cannot be stored.

5

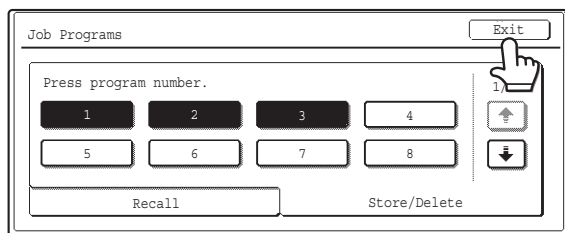

Touch the [Exit] key.

DELETING A JOB PROGRAM

The procedure for deleting a job program is explained below.

1



Press the [PROGRAM] key ($\boxed{\#/P}$).

2

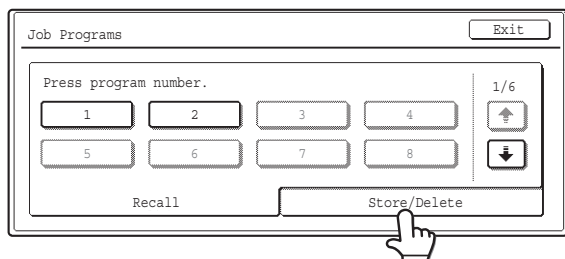

Touch the [Store/Delete] tab.

3

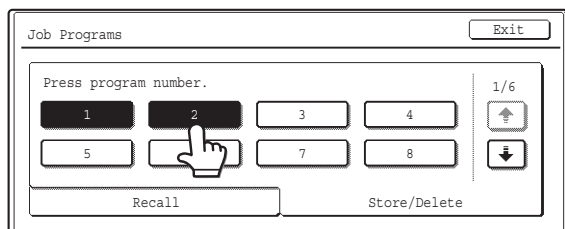

Touch the numeric key in which the job program that you wish to delete is stored.

4

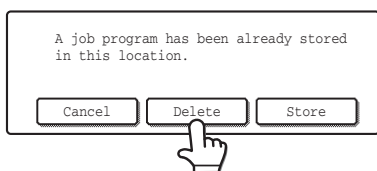

Touch the [Delete] key.

5

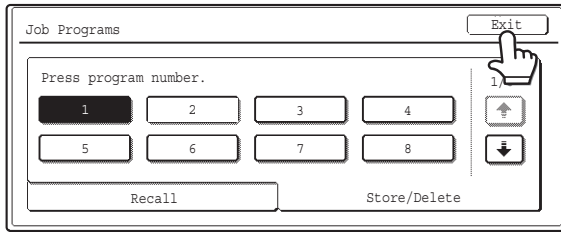

Touch the [Exit] key.



When "Disabling Deletion of Job Programs" is enabled in the system settings (administrator), this function cannot be used.

APPENDIX

Examples of covers and inserts

The relations between the originals and finished copies when covers or inserts are inserted are shown on the following pages.

Covers

- 1-sided copying of 1-sided originals
- 1-sided copying of 2-sided originals
- 2-sided copying of 1-sided originals
- 2-sided copying of 2-sided originals

Inserts

- 1-sided copying of 1-sided originals
- 1-sided copying of 2-sided originals
- 2-sided copying of 1-sided originals
- 2-sided copying of 2-sided originals

Symbols used for covers and inserts

The following symbols are used to make the explanations easier to understand.



















The numbers that appear indicate what original a copy corresponds to, and will vary depending on the settings.

Type	Symbol	Meaning	Icon appearing in display	Type	Symbol	Meaning	Icon appearing in display
Front cover		Front cover when not copied on.		Inserts		Insert when not copied on.	
		Front cover when 1 side is copied on.				Insert when 1 side is copied on.	
		Front cover when a 2-sided original is copied on 1 side of the cover. (One page is not copied.)				Insert when a 2-sided original is copied on 1 side of the insert. (One page is not copied.)	
		Front cover when both sides are copied on.				Insert when both sides are copied on.	
Back cover		Back cover when not copied on.		Other symbols		1-sided original or output page of regular 1-sided copying.	
		Back cover when a 1-sided original is copied on 1 side of the back cover.				2-sided original or output page of regular 2-sided copying.	
		Back cover when a 2-sided original is copied on 1 side of the back cover. (One page is not copied.)				1-sided original or output page of regular 1-sided copying.	
		Back cover when both sides are copied on.				Output page of 2-sided copying when only 1 side is copied on due to lack of originals.	

Covers (1-sided copying of 1-sided originals)

1-sided copies are made of the following 1-sided originals.

1st page	2nd page	3rd page	4th page	5th page	6th page
1	2	3	4	5	6

Cover copying condition		Resulting copies							
Front cover	Back cover								
No copying	No copying		1	2	3	4	5	6	
1-sided copying	No copying		2	3	4	5	6		
2-sided copying	No copying		3	4	5	6			
No copying	1-sided copying		1	2	3	4	5		
No copying	2-sided copying		1	2	3	4			
1-sided copying	1-sided copying		2	3	4	5			
1-sided copying	2-sided copying		2	3	4				
2-sided copying	1-sided copying		3	4	5				
2-sided copying	2-sided copying		3	4					

Covers (2-sided copying of 1-sided originals)



2-sided copies are made of the following 1-sided originals.

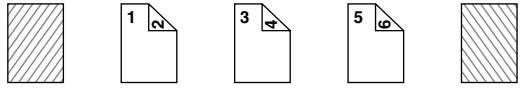
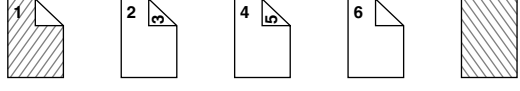
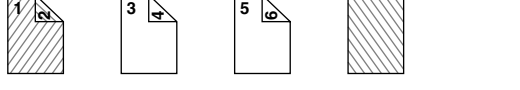
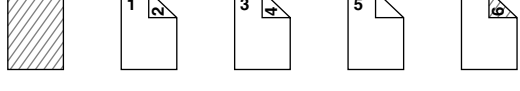
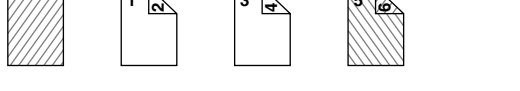
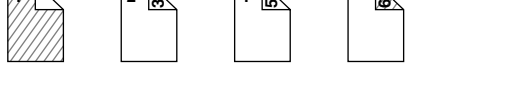
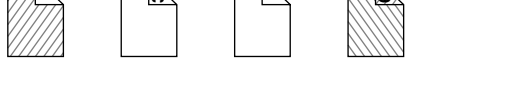
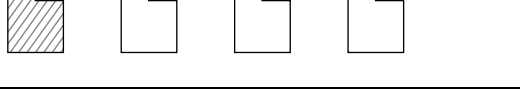
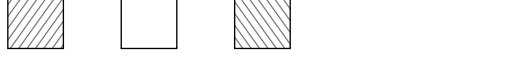





















































1st page	2nd page	3rd page	4th page	5th page	6th page
1	2	3	4	5	6

Cover copying condition		Resulting copies
Front cover	Back cover	
No copying	No copying	
1-sided copying	No copying	
2-sided copying	No copying	
No copying	1-sided copying	
No copying	2-sided copying	
1-sided copying	1-sided copying	
1-sided copying	2-sided copying	
2-sided copying	1-sided copying	
2-sided copying	2-sided copying	

Covers (1-sided copying of 2-sided originals)



1-sided copies are made of the following 2-sided originals.

































1st page	2nd page	3rd page
		

Cover copying condition		Resulting copies							
Front cover	Back cover								
No copying	No copying								
1-sided copying	No copying								
2-sided copying	No copying								
No copying	1-sided copying								
No copying	2-sided copying								
1-sided copying	1-sided copying								
1-sided copying	2-sided copying								
2-sided copying	1-sided copying								
2-sided copying	2-sided copying								

Covers (2-sided copying of 2-sided originals)







2-sided copies are made of the following 2-sided originals.































1st page	2nd page	3rd page
		

Cover copying condition		Resulting copies
Front cover	Back cover	
No copying	No copying	    
1-sided copying	No copying	   
2-sided copying	No copying	   
No copying	1-sided copying	   
No copying	2-sided copying	   
1-sided copying	1-sided copying	  
1-sided copying	2-sided copying	  
2-sided copying	1-sided copying	  
2-sided copying	2-sided copying	  

Inserts (copying of 1-sided originals)



1-sided and 2-sided copying is performed using the following 1-sided originals. The insert is added as the third page.





























1st page	2nd page	3rd page	4th page	5th page	6th page
					

Insert copying condition	Resulting copies (one-sided copying)							Resulting copies (Two-sided copying)				
No copying												
1-sided copying												
2-sided copying												

Inserts (copying of 2-sided originals)

1-sided and 2-sided copying is performed using the following 2-sided originals.

1st page	2nd page	3rd page
		

Insert copying condition	Resulting copies (one-sided copying)							Resulting copies (Two-sided copying)				
No copying												
1-sided copying												
2-sided copying												

Copier Guide

MODEL: MX-2300G MX-3500N
MX-2300N MX-3501N
MX-2700G MX-4500N
MX-2700N MX-4501N



SHARP®

MX4500-EX-CPY-Z1

Free Manuals Download Website

<http://myh66.com>

<http://usermanuals.us>

<http://www.somanuals.com>

<http://www.4manuals.cc>

<http://www.manual-lib.com>

<http://www.404manual.com>

<http://www.luxmanual.com>

<http://aubethermostatmanual.com>

Golf course search by state

<http://golfingnear.com>

Email search by domain

<http://emailbydomain.com>

Auto manuals search

<http://auto.somanuals.com>

TV manuals search

<http://tv.somanuals.com>