

SHARP®

LIQUID CRYSTAL DISPLAY CAMCORDER

MODEL

VL-A10H

■ OPERATION MANUAL ■

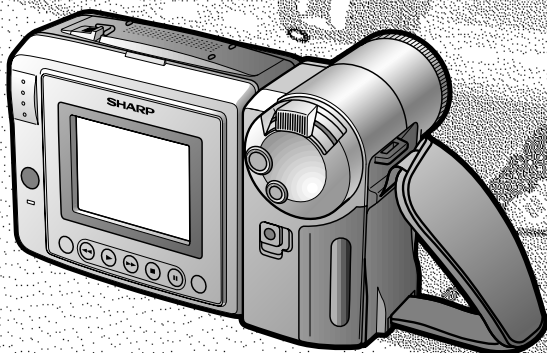

SHARP

VIEW•CAM

8

PAL

Please read this operation manual carefully before using the VIEWCAM.

If you require any advice or assistance regarding your Sharp product, please visit our web-site www.sharp.co.uk/support. Customers without Internet access may telephone 08705 274277 during office hours (or (01)676 0648 if telephoning from Ireland) .

Operation Summary

Preparation

Basic Operations
Camera Recording

Basic Operations
Playback

Useful Features

Advanced Features

References

This equipment complies with the requirements of Directives 89/336/EEC and 73/23/EEC as amended by 93/68/EEC.

Dieses Gerät entspricht den Anforderungen der EG-Richtlinien 89/336/EWG und 73/23/EWG mit Änderung 93/68/EWG.

Ce matériel répond aux exigences contenues dans les directives 89/336/CEE et 73/23/CEE modifiées par la directive 93/68/CEE.

Dit apparaat voldoet aan de eisen van de richtlijnen 89/336/EEG en 73/23/EEG, gewijzigd door 93/68/EEG.

Dette udstyr overholder kravene i direktiv nr. 89/336/EEC og 73/23/EEC med tillæg nr. 93/68/EEC.

Quest' apparecchio è conforme ai requisiti delle direttive 89/336/EEC e 73/23/EEC, come emendata dalla direttiva 93/68/EEC.

Η εγκατάσταση αυτή ανταποκρίνεται στις απαιτήσεις των οδηγιών της Ευρωπαϊκής Ένωσης 89/336/ΕΟΚ και 73/23/ΕΟΚ, όπως οι κανονισμοί αυτοί συμπληρώθηκαν από την οδηγία 93/68/ΕΟΚ.

Este equipamento obedece às exigências das directivas 89/336/CEE e 73/23/CEE, na sua versão corrigida pela directiva 93/68/CEE.

Este aparato satisface las exigencias de las Directivas 89/336/CEE y 73/23/CEE, modificadas por medio de la 93/68/CEE.

Denna utrustning uppfyller kraven enligt riktlinjerna 89/336/EEC och 73/23/EEC så som kompletteras av 93/68/EEC.

Dette produktet oppfyller betingelsene i direktivene 89/336/EEC og 73/23/EEC i endringen 93/68/EEC.

Tämä laite täyttää direktiivien 89/336/EEC ja 73/23/EEC vaatimukset, joita on muutettu direktiivillä 93/68/EEC.

WARNING

TO PREVENT SHOCK HAZARD, DO NOT EXPOSE THIS APPLIANCE TO RAIN OR MOISTURE.

This equipment should be used with the recommended AC adapter or battery pack.

CAUTION

To prevent electric shocks and fire hazards, do NOT use any other power source.

Important:

Recording and playback of any material may require consent. Please refer particularly to the provisions of the Copyright Act 1956, the Dramatic and Musical Performers Protection Act 1958, the Performers Protection Acts 1963 and 1972 and to any subsequent statutory enactments and orders.

CAUTION



To prevent shock, do not open the cabinet. No user serviceable parts inside. Refer servicing to a qualified dealer or service centre.

Power supply:

WARNING: THIS AC ADAPTER IS NOT FOR USE WITH TOYS. THIS AC ADAPTER IS FOR USE WITH SHARP VIEWCAM MODEL VL-A10H ONLY.

This unit can be operated by connecting it to either the AC adapter or battery pack. The AC adapter incorporates the AUTO VOLTAGE (AC 110–240 V, 50/60 Hz) function.

SPECIAL NOTE FOR USERS IN THE U.K.

The mains lead of this product is fitted with a non-rewireable (moulded) plug incorporating a 3A fuse. Should the fuse need to be replaced, a BSI or ASTA approved BS 1362 fuse marked  or  and of the same rating as above, which is also indicated on the pin face of the plug, must be used.

Always refit the fuse cover after replacing the fuse. Never use the plug without the fuse cover fitted.

In the unlikely event of the socket outlet in your home not being compatible with the plug supplied, cut-off the mains plug and fit an appropriate type.

DANGER: The fuse from the cut-off plug should be removed and the cut-off plug destroyed immediately and disposed of in a safe manner.

Under no circumstances should the cut-off plug be inserted elsewhere into a 13A socket outlet, as a serious electric shock may occur.

To fit an appropriate plug to the mains lead, follow the instructions below:

IMPORTANT: The wires in the mains lead are coloured in accordance with the following code:

Blue: Neutral

Brown: Live

As the colours of the wires in the mains lead of this product may not correspond with the coloured markings identifying the terminals in your plug, proceed as follows:

- The wire which is coloured blue must be connected to the plug terminal which is marked N or coloured black.
- The wire which is coloured brown must be connected to the plug terminal which is marked L or coloured red.

Ensure that neither the brown nor the blue wire is connected to the earth terminal in your three-pin plug.

Before replacing the plug cover make sure that:

- If the new fitted plug contains a fuse, its value is the same as that removed from the cut-off plug.
- The cord grip is clamped over the sheath of the mains lead and not simply over the lead wires.

IF YOU HAVE ANY DOUBT, CONSULT A QUALIFIED ELECTRICIAN.

Your VIEWCAM is designed to record in SP mode only. It will not perform normal playback for programmes prerecorded in LP mode.

This VIEWCAM does not have a PCM recording or playback function. PCM recordings made using other VCRs or audio dubbing cannot be played back on this unit.

If you record on a tape on which PCM sound has already been recorded, the audio track of the new VIEWCAM recording may not come out if the tape is played back on a PCM-capable VCR. If this occurs, set the VCR's audio monitor select switch to the "Standard" position.

NOTE:

The VIEWCAM's LCD panel is a very high technology product with close to 90,000 thin-film transistors*, giving you fine picture detail. Occasionally, a pixel may appear on the screen as a fixed point of blue, green, red, or black. Please note that this does not affect your VIEWCAM's performance.

*Specifications are subject to change without notice.

Precautions

- **When the VIEWCAM is not in use, remember to remove the cassette tape, turn off the power, and disconnect the VIEWCAM from the power source.**

- **Do not aim the lens at the sun.**

Do not allow direct sunlight to strike the VIEWCAM lens or LCD monitor screen, whether or not recording is in progress, as it may damage the CCD sensor or LCD screen surface. Be particularly careful when recording outside.

- When shooting in dark places, avoid sudden brightly lit objects or light sources, such as the sun. Otherwise, the image may white out. Should this happen, point the lens in a different direction until the picture returns to normal.

- **Avoid magnetic sources.**

Using the VIEWCAM near strong fluorescent lights, motors, televisions, or other magnetic sources may adversely affect recorded images.

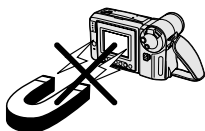

- **Using the VIEWCAM near a broadcasting station or other powerful transmission source may cause buzzing or picture deterioration.**

- **Avoid shocks and dropping.**

Do not drop or otherwise subject the VIEWCAM to hard shocks or strong vibrations. Bumping or striking the unit during recording will generate noise in the recorded image.

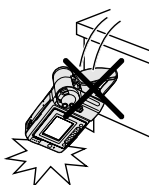

- **Avoid placing the VIEWCAM in close proximity to lighting equipment.**

The heat from incandescent lights may deform the VIEWCAM, or cause it to malfunction.



- **Always respect prohibitions or restrictions on the use of electronic equipment on commercial flights or in other sensitive areas.**

- **Be aware of the temperature and humidity.**

You can use your VIEWCAM at 0°C to +40°C, and at 30% to 80% relative humidity. Do not store the unit in an unventilated car in the summer, in direct sunlight, or near strong heat sources; this can result in severe damage to the unit casing and circuitry.



- **Avoid situations where water, sand, dust or other foreign matter could get on or inside the VIEWCAM, and do not use or leave your VIEWCAM in areas with excessive smoke, steam or moisture.**

Such environments can cause malfunctions or cause mildew to form on the lenses. Be sure to keep the unit in a well-ventilated location.

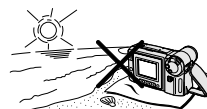

- **Some small, portable tripods may be difficult to attach and may not be sturdy enough to support your VIEWCAM. Be sure to use only a strong, stable tripod.**



- **When using your VIEWCAM in a cold environment, the LCD monitor screen often appears less bright immediately after the power is turned on. This is not a malfunction. To prevent the VIEWCAM from becoming too cold, wrap it in a thick cloth (a blanket, etc.).**

AC Adapter

- The AC adapter may interfere with reception if used near a radio.
- Prevent flammables, liquids, and metal objects from entering the adapter.
- The adapter is a sealed unit. Do not attempt to open or modify it.
- Do not damage, drop, or subject the adapter to vibration.
- Do not leave the adapter in direct sunlight.
- Avoid using the adapter in humid or extremely hot places.

Cleaning

- Many plastic parts are used in the VIEWCAM casing. Do not use thinner, benzene or other strong chemical cleaners. These may cause discoloration and damage to the casing.
- Clean the casing with a soft, dry cloth. If the casing is particularly dirty, wipe the casing with a tightly wrung cloth dampened with a diluted, neutral detergent. Then wipe it again with a soft, dry cloth.
- Use a soft cloth to wipe finger marks and other soiling off the LCD screen.
- Use a soft cloth, or compressed air and lens paper designed for photographic lenses to clean the lens.

LCD Monitor Screen

The VIEWCAM is equipped with a large LCD monitor screen that allows you to record scenes while comfortably holding the camcorder. The LCD monitor screen can be rotated for easy recording at high or low angles. It also functions as a handy playback monitor so you can enjoy what you have just recorded.





Cautions:

- Do not apply pressure to the screen.
- Do not expose the screen to shocks, as it may break.
- Do not place the VIEWCAM with the screen facing down.

Note:

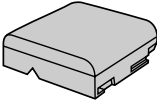
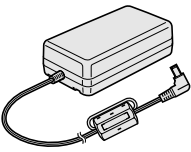
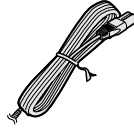
- Use a soft cloth to clean the screen.

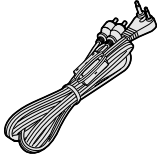
Supplied Accessories

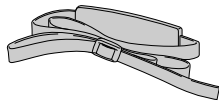
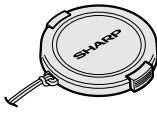
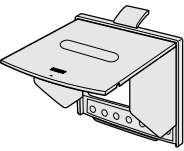
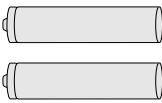
 <p>Battery pack BT-H22</p>	 <p>AC adapter</p>	 <p>Power cord</p>	 <p>Infrared remote control</p>
 <p>Audio/video cable</p>	 <p>CR2025 type lithium battery</p>	 <p>Shoulder strap</p>	 <p>Lens cap</p>
 <p>Sun hood</p>	 <p>AA battery for remote control × 2</p>		

Optional Accessories

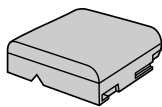

Standard type
battery pack
BT-H22

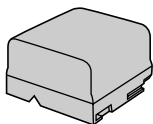

Extended type
battery pack
BT-H32

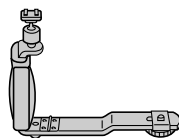

Accessory
shoe adapter
VR-30AD

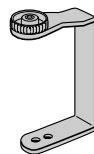

Tripod adapter
for 180° recording
VR-33FA



Soft case

Contents

Operation Summary

Part Names	3
On-screen Display Index	5
Quick Reference Index	6
Warning Indicators	7

Preparation

Inserting and Removing the Battery Pack	8
Charging the Battery Pack	9
Powering the VIEWCAM from an AC Outlet	10
Inserting and Removing a Cassette	11
Installing the Lithium Memory Battery	12
Setting the Date and Time	13
Using the Hand Strap and the Lens Cap	14
Attaching the Shoulder Strap	14
Using the Sun Hood	15

Basic Operations

Camera Recording

Easy Camera Recording with Full Auto Mode ...	16
Zooming	17
Tips on Recording Positions	17
Remaining Recording Time Display	18
Remaining Battery Power Display	18

Playback

Playback	19
Volume Control	19
Watching the Playback on a TV	20
Video Search	21
Still	21

Useful Features

Operations of the On-screen Controls	
Using the Control Buttons	22
Selecting the Mode/Menu Screens	22
Adjusting the Menu Settings	23
Recording the Date and Time	24
Fade In and Fade Out	25
Quick Review	26
Quick Return	27
Edit Search	27
Gamma Brightness Compensation	28
Gain-up (Cat's Eye)	29
Wide Screen (16:9)	30
Macro Shots	30
Removing the Lens Hood	30
Self Recording	31
Setting the VIEWCAM to Full Auto Mode	33
Program Search	34
Tape Counter Feature	35
Using the Remote Control	37

Advanced Features

Digital Picture Effects	38
Scene Menu (Program AE)	39
Superimposing a Title	40
Changing the Preset Titles	41
Auto/Manual Focus	42
White Balance Lock	43
Manual Exposure	44
Picture/Backlight Adjustments	45
Gamma Playback.....	46
Turning Off the LCD Monitor Backlight	46
Editing	47

References

Useful Information	48
Demonstration Mode.....	52
Before Requesting Service	53
Specifications	55

Operation Summary

Part Names

For details on the use of each part, refer to the page number indicated in the brackets.

Front view

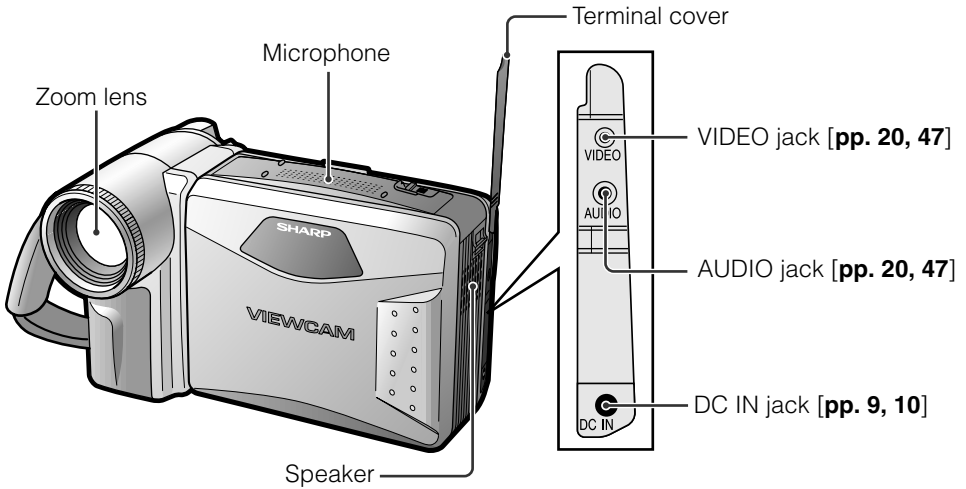

When the cassette compartment door is open

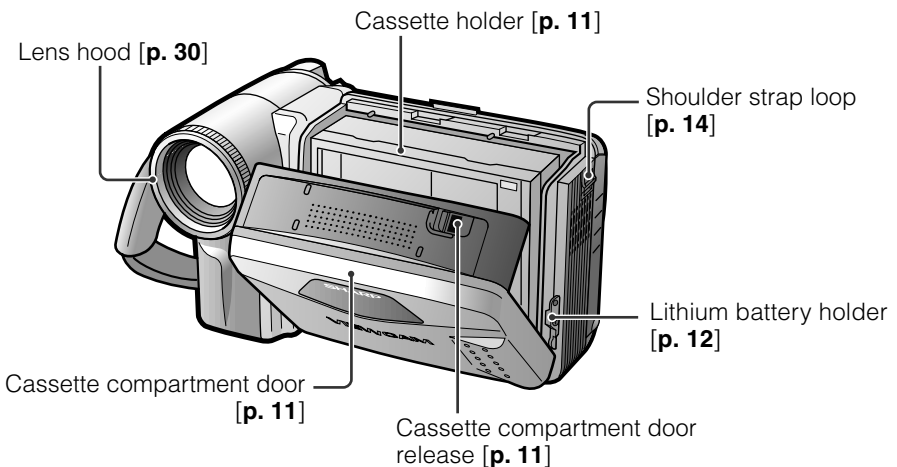

Rear view

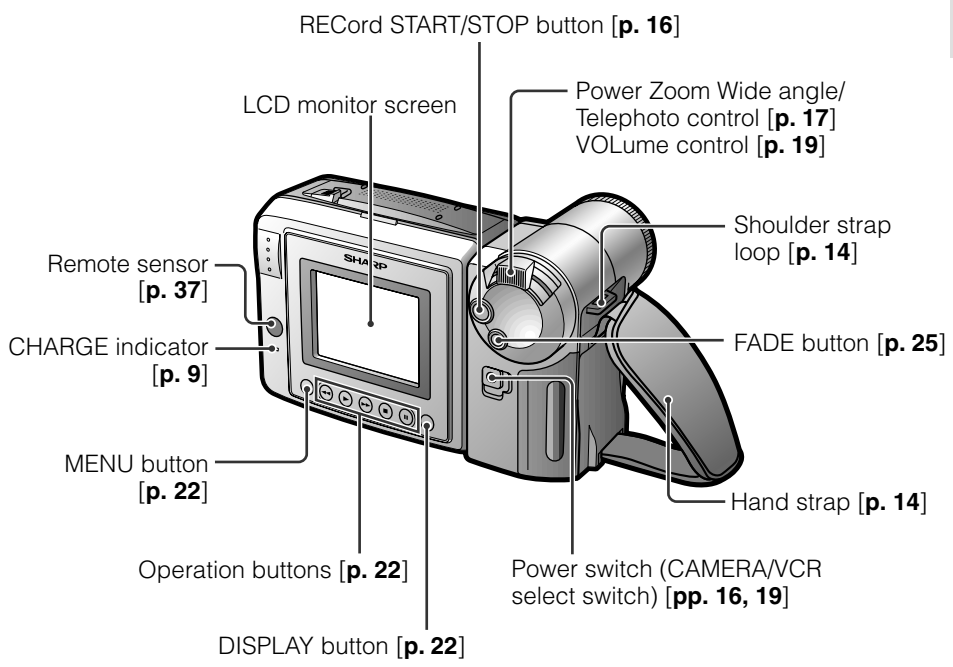

Bottom view

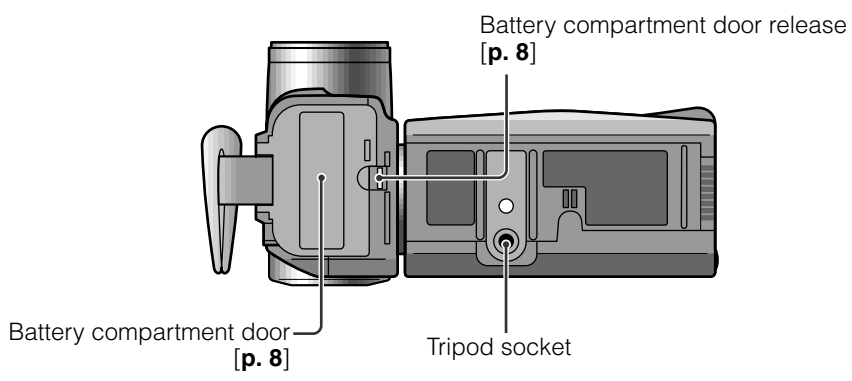

Operation Summary

On-screen Display Index

For details on the use of each function, refer to the page number indicated.

Camera Mode

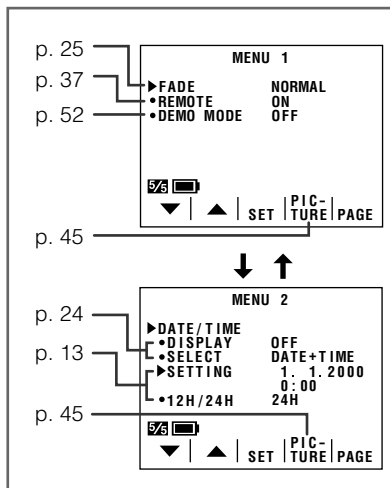
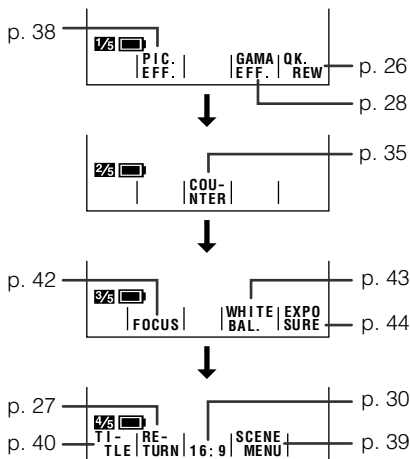
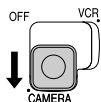

VCR Mode

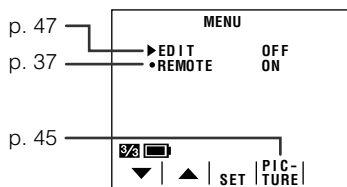
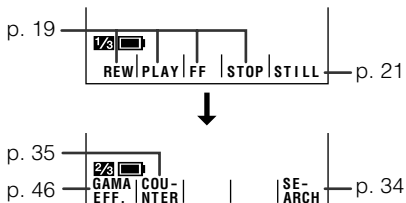
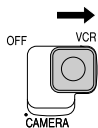

Note: See pages 22 and 23 for the procedure to display the desired screen.

Quick Reference Index

This index lists some example uses of the VIEWCAM's features.

- To quickly check what you have just recorded.
—See **page 26** (Quick Review)
- To quickly return the tape to the end of the last recorded scene after playback.
—See **page 27** (Quick Return)
- To locate the point on the tape where to begin recording while in Camera mode.
—See **page 27** (Edit Search)
- To record a backlit subject.
—See **page 28** (Gamma Brightness Compensation) or **page 44** (Manual Exposure)
- To record in a dark or poorly-illuminated location.
—See **page 29** (Gain-up)
- To record yourself while monitoring the shot.
—See **page 31** (Self Recording)
- To record a short video message for somebody.
—See **page 32** (Self-recording Message)
- To find the beginning of a recorded scene to be played back.
—See **page 34** (Program Search)
- To display the elapsed recording or playback time.
—See **page 35** (Tape Counter Feature)
- To focus on an off-centred subject.
—See **page 42** (Manual Focus)
- To increase the brightness of the subject during playback.
—See **page 46** (Gamma Playback)

Operation Summary

Warning Indicators

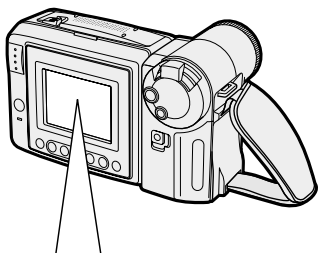

Displayed for the first 3 seconds	Displayed after 3 seconds	Description of warning
EJECT THE CASSETTE.	EJECT THE CASSETTE.	The video cassette is defective and should be removed (see page 11).
DEW	-DEW-	Dew has formed inside the VIEWCAM. Wait for a few hours until the dew disappears (see page 49). About 10 seconds after this warning appears, the VIEWCAM automatically turns off.
BATTERY IS TOO LOW.	-BATTERY-	The battery is almost depleted. Replace it with a fully charged battery pack (see page 8).
✘	✘	The video heads are clogged and should be cleaned (see page 49).
INSERT A CASSETTE.	-CASSETTE-	There is no video cassette in the VIEWCAM. Insert a cassette (see page 11).
CASSETTE NOT RECORDABLE.	-PROTECT. TAB-	The erasure protect tab on the video cassette has been slid to the record-protect position, preventing recording (see page 51).
THE TAPE ENDS SOON.	-TAPE END-	The tape is about to end. Prepare a new cassette (see page 11).
CHANGE THE CASSETTE.	TAPE END	The tape has reached the end. Replace it with a new cassette (see page 11).
◇	◇	In Self Recording mode, all warnings will be indicated by ◇ displayed in the centre of the monitor. To check the type of warning, rotate the monitor back to the normal position.

Note: ✘ indicates a flashing display.

Preparation

Inserting and Removing the Battery Pack

Inserting the Battery Pack

- 1 Make sure that the Power switch is set to OFF.

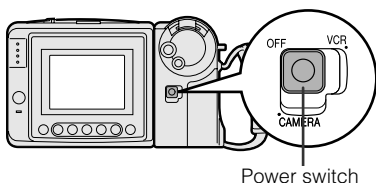

- 2 Slide the battery compartment door release on the bottom of the VIEWCAM in the direction of the arrow to open the battery compartment door.

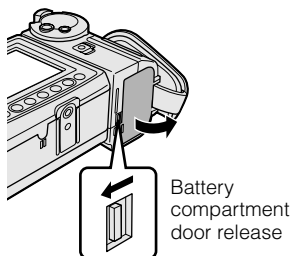

- 3 Insert the battery pack into the compartment as shown, and push it in completely until it locks into place.

Caution:

- Do not force the battery pack into the battery compartment if it does not go in easily.

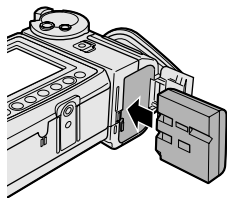

- 4 Close the door, pressing it firmly in the centre until it clicks.

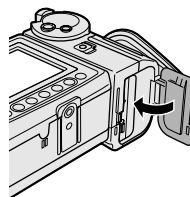

Removing the Battery Pack

- 1 Perform steps 1 and 2 above.
- 2 Press the battery release as shown to remove the battery pack.

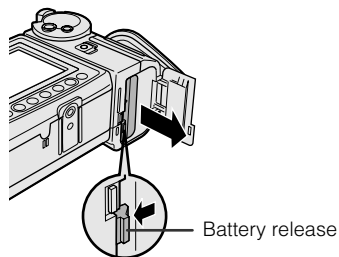

Cautions:

- **BEFORE REMOVING THE BATTERY PACK, ALWAYS STOP THE TAPE AND TURN THE POWER OFF.** If you remove the battery pack during recording or playback, the tape will remain wound around the video head drum, potentially causing damage to the tape.
- Make sure the battery compartment door is closed firmly during operation. If it is not, the battery pack may fall out or VIEWCAM operation may fail because of the poor contact pressure.
- Remove the battery pack from the VIEWCAM if the VIEWCAM will not be used for a long period of time.
- **When removing the battery pack, do not tilt the VIEWCAM so that the battery compartment faces down. The battery pack may fall out.**
- Do not expose the battery compartment door to strong force, as it may come off.
- Use only SHARP model BT-H22 or BT-H32 battery packs with this VIEWCAM. Use of other batteries may present a risk of fire or explosion.

Charging the Battery Pack

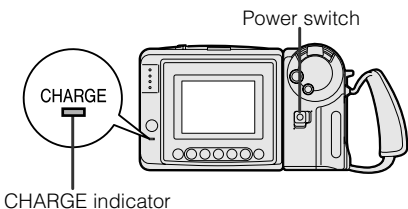

- 1 Insert the battery pack into the VIEWCAM (see page 8). Make sure that the Power switch is set to OFF.
 - The battery pack will not charge when the Power switch is set to CAMERA or VCR.
- 2 Connect the power cord to the AC adapter, then insert the AC plug into a power outlet.
- 3 Open the terminal cover on the VIEWCAM and insert the DC plug of the AC adapter into the DC IN jack on the VIEWCAM.
 - The CHARGE indicator will light up in red.

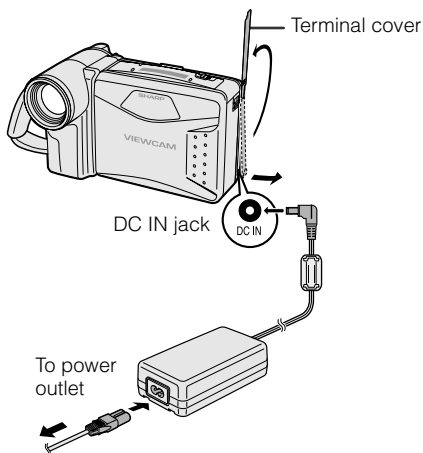

- 4 When the battery is fully charged, the CHARGE indicator will light up in green. Remove the DC plug from the VIEWCAM, and close the terminal cover.

Caution:

- When removing the plugs, grasp the plug, not the cable.

Charging time and maximum continuous recording and playback times

Battery pack	Charging time	Max. continuous recording time	Max. continuous playback time
BT-H22	approx. 3 hr.	approx. 1 hr. 40 min.	approx. 1 hr. 40 min.
BT-H32	approx. 6 hr.	approx. 3 hr. 20 min.	approx. 3 hr. 20 min.

Notes:

- Using the zoom (see page 17) and other functions or turning the power on and off frequently will increase power consumption. This may result in a decrease of more than 50% in the actual recording time compared to the maximum continuous recording time listed above.
- The charging time and recording time may vary depending on the ambient temperature and the condition of the battery pack.
- It is recommended that you have enough battery packs on hand to provide two to three times your estimated recording time.
- See page 50 for more information on using the battery pack.

Caution:

- Charge only SHARP model BT-H22 or BT-H32 battery packs. Other types of battery packs may burst, causing personal injury and damage.

Powering the VIEWCAM from an AC Outlet

Caution:

- The supplied AC adapter is specially designed for use with this VIEWCAM, and should not be used as a power supply for other camcorders.

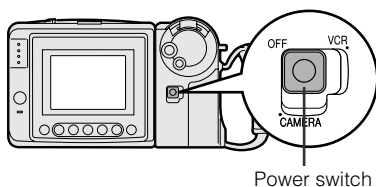

Cautions:

- **BEFORE REMOVING THE DC PLUG, ALWAYS STOP THE TAPE AND TURN THE POWER OFF.** If you remove the DC plug during recording or playback, the tape will remain wound around the video head drum, potentially causing damage to the tape.
- Remove the DC plug from the VIEWCAM if you will not use the VIEWCAM for a long period of time.
- When removing the plugs, grasp the plug, not the cable.

Note:

- Close the terminal cover after use.

- 1 Connect the power cord to the AC adapter, then insert the AC plug into a power outlet.
- 2 Make sure that the Power switch is set to OFF.
- 3 Open the terminal cover and insert the DC plug of the AC adapter into the DC IN jack on the VIEWCAM.

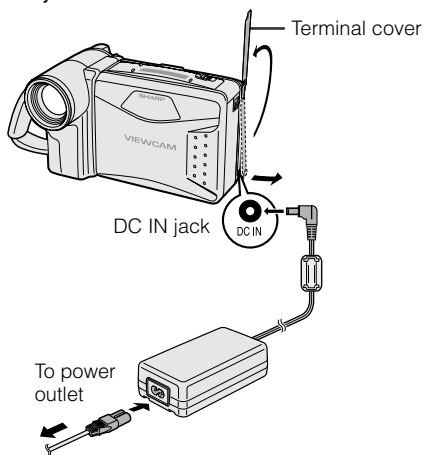

- 4 Hold down the Lock button and slide the Power switch to CAMERA or VCR.

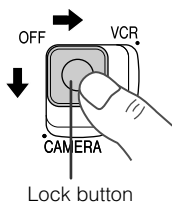

Inserting and Removing a Cassette

Inserting a Cassette

- 1 Supply power to the VIEWCAM, then slide the release and open the cassette compartment door.
 - The cassette holder extends and opens automatically.

Cassette compartment door release

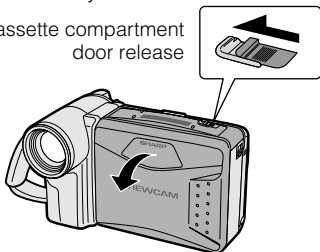

- 2 Insert the cassette fully with the window facing outwards, and with the erasure protect tab facing upwards.

Erasure protect tab

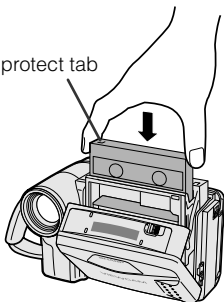

- 3 Press the PUSH mark gently until the cassette holder clicks into place.
 - The cassette holder retracts automatically.

PUSH mark

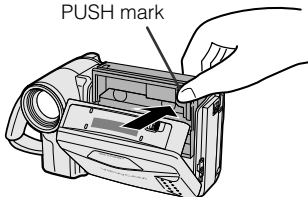

- 4 Wait for the cassette holder to fully retract. Close the compartment door by pressing the centre until it clicks into place.

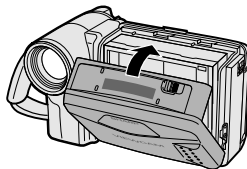

Removing a Cassette

Perform step 1 above, then take out the cassette.

Cautions:

- Do not try to close the cassette compartment door while the cassette holder is extending or retracting.
- Be careful not to get your fingers caught in the cassette holder.
- Do not apply force to the cassette holder except when pressing the PUSH mark to close it.
- Do not tilt the VIEWCAM or hold it upside down when you are inserting or removing a cassette. It may damage the tape.
- Remove the cassette if you will not use the VIEWCAM for a long period of time.
- If you do not correctly close the cassette holder in step 3, the VIEWCAM's cassette protection mechanism might eject the cassette. If this happens, repeat the insertion procedure.
- Do not attempt to pick up the VIEWCAM by the cassette compartment door.

Notes:

- If the battery power is too low, you may not be able to eject the cassette. Replace the battery pack with a fully charged one.
- See page 51 for more information on the video cassette tapes for use with this VIEWCAM.

Installing the Lithium Memory Battery

The supplied lithium battery is used to store the memory of the date and time settings.

- 1 Slide the cassette compartment door release and open the cassette compartment door.

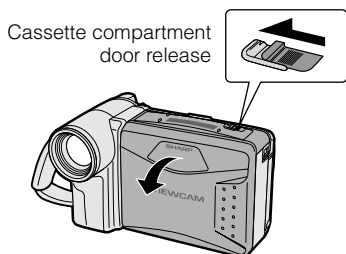

Note: The cassette holder will extend and open when the VIEWCAM is connected to a power source. Be sure to close the cassette holder before proceeding to the next step (see page 11).

- 2 Pull out the lithium battery holder using a pointed object such as the tip of a ballpoint pen.

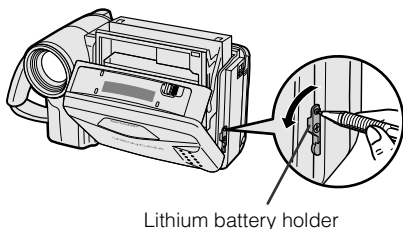

- 3 Insert the lithium battery into the battery holder with the + side of the battery facing the ⊕ side of the holder.

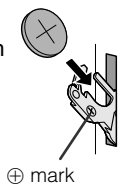

- 4 Push the battery holder back into position.



- 5 Close the cassette compartment door by pressing the centre until it clicks into place.

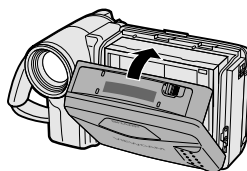

Removing the Lithium Battery

Perform steps 1 and 2 above, then lift out the battery from the battery holder.

Note:

- Replace the battery with a new CR2025 battery when the date and time indicator starts to fall behind the correct time.

Notes on the Use of the Lithium Battery

CAUTION: Danger of explosion if battery is incorrectly replaced. Replace only with the same or equivalent type CR2025 recommended by the equipment manufacturer.

WARNING: KEEP THIS BATTERY AWAY FROM CHILDREN. IF SWALLOWED, CONSULT A PHYSICIAN IMMEDIATELY FOR EMERGENCY TREATMENT.

CAUTION: BATTERY MAY EXPLODE IF MISUSED OR INSTALLED WITH POLARITY REVERSED. DO NOT RECHARGE, DISASSEMBLE OR DISPOSE OF IN FIRE.

- Do not short-circuit, recharge, disassemble, or heat the lithium battery.
- Should the lithium battery leak, wipe the battery compartment and holder clean, and then insert a new battery.
- The lithium battery will last about one year of normal usage.

Setting the Date and Time

Example: Setting the date to 2 June 2001 (2. 6. 2001) and the time to 10:30 am (10:30).

Note:

- Check that the lithium memory battery has been installed before setting the date and time.

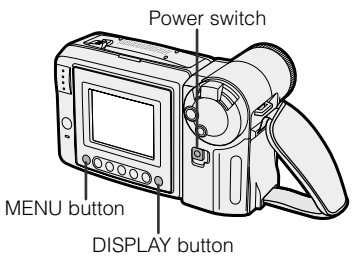

1 Hold down the Lock button and slide the Power switch to CAMERA.

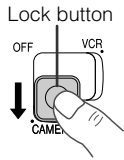

2 Press the MENU button until **5/5** (MENU 2) appears.

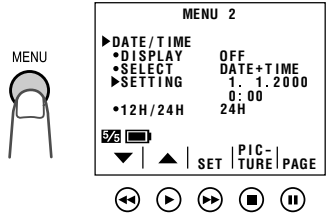

- If MENU 1 appears on the **5/5** screen, press the PAGE button (**⏩**) to display MENU 2.

3 Press the SET button (**▶▶**).

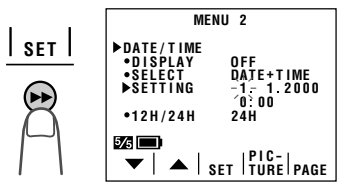

- When changing the date and time settings, press the **▼** or **▲** button (**◀** or **▶**) to select "SETTING", then press the SET button.

4 Press the **▼** or **▲** button (**◀** or **▶**) to select "2" (day), and press the SET button.



5 Press the **▼** or **▲** button to select "6" (month), and press the SET button.



6 Press the **▼** or **▲** button to select "2001" (year), and press the SET button.



7 Press the **▼** or **▲** button to select "10" (hour), and press the SET button.



8 Press the **▼** or **▲** button to select "30" (minute), and press the SET button.
• The internal clock now starts operating.

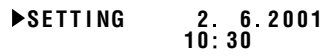

9 Press the DISPLAY button to turn off the menu screen.

Changing to the 12-hour Time Mode

After performing step 8 above, press the **▼** or **▲** button (**①**) to select "12H/24H", then press the SET button (**▶▶**) (**②**) to select "12H".

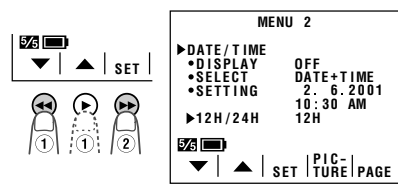

Notes:

- The date and time, once set, are stored in memory.
- The menu screen automatically turns off if no settings are made within 5 minutes.

Using the Hand Strap and the Lens Cap

- 1 Open the hand strap flap (1) and grip strap (2), and pass the grip strap through the loop at the end of the lens cap cord (3).

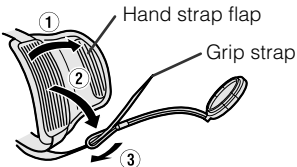

- 2 Pass your hand through the hand strap and put your thumb close to the Power Zoom control. Then pull the grip strap tight until it fits snugly, seal the Velcro® closures (1), and close the hand strap flap (2).

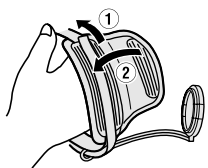

Caution:

- Do not swing the VIEWCAM by the hand strap.

Attaching and Removing the Lens Cap

When attaching or removing the lens cap, press both tabs on the sides of the cap.

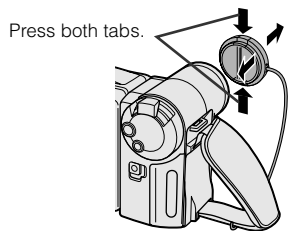

Notes:

- Always replace the lens cap on the lens when the VIEWCAM is not in use.
- Attach the lens cap to the hand strap so it will not get in the way during recording.

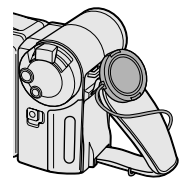

Attaching the Shoulder Strap

- 1 Hold one end of the strap and thread it through the loop on the left side of the LCD screen.
- 2 Loosen the strap in the buckle, then feed the end of the strap through the buckle, as shown.
- 3 Draw the strap in the direction of the arrow to secure.
- 4-6 Use the same procedure to attach the other end of the strap to the loop on the lens side.

LCD screen side		Lens side	
1		4	
2		5	
3		6	

Preparation

Using the Sun Hood

It is recommended that you use the supplied sun hood when recording outdoors on a sunny day or at a brightly illuminated location.

Attaching the Sun Hood

Fit the bottom clip on the sun hood into the slot below the LCD screen (①), and align the top clip with the ridge above the LCD screen (②). Then press the sun hood until it clicks into place.

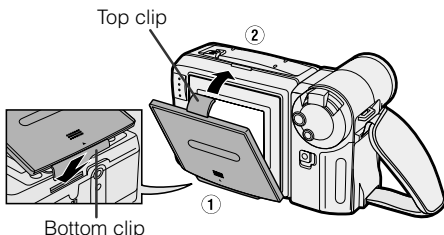

Opening the Sun Hood

Open the sun hood by lifting the top cover in the direction of the arrow. (The side covers will open automatically.)

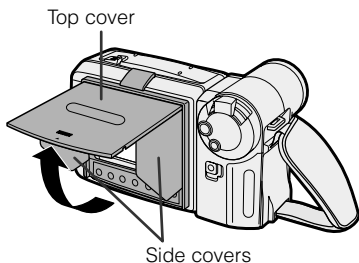

Note:

- You can operate the Operation buttons below the LCD screen with the sun hood attached.

Closing the Sun Hood

- 1 Fold in both side covers while holding the top cover open.

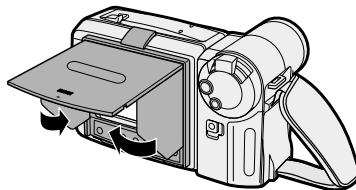

- 2 Close the top cover by gently pressing the textured mark down until the cover clicks into place.

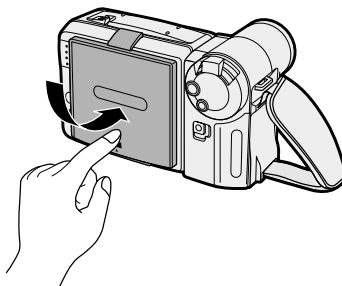

Removing the Sun Hood

Carefully lift the top clip up with your thumb while supporting the sun hood with your hand (①). Then pull the sun hood in the direction of the arrow (②) to release the bottom clip.

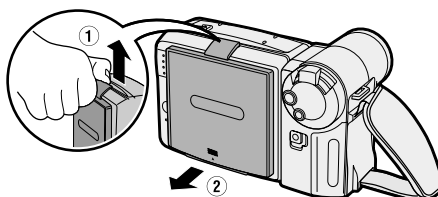

Cautions:

- Be sure to close the sun hood before transporting the VIEWCAM. If the VIEWCAM is transported with the sun hood open, the sun hood may fall off or become damaged.
- Do not leave the sun hood in an unventilated car in direct sunlight. The high temperature may cause a deformation of the casing.

Basic Operations

Camera Recording

Easy Camera Recording with Full Auto Mode

Before you start recording, perform the operations described on pages 8 through 15 to prepare your VIEWCAM for recording.

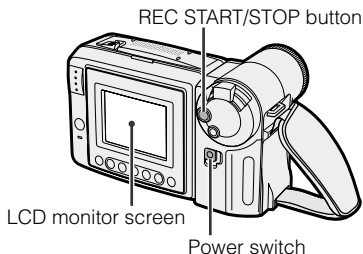

- 1 Remove the lens cap (see page 14).
- 2 Hold down the Lock button and slide the Power switch to CAMERA.
 - The picture from the lens is now displayed on the LCD monitor screen.
 - The VIEWCAM is now ready to record (Recording Standby mode).



Full Auto mode indicator

Note: If, at this time, "AUTO" does not appear, set the VIEWCAM to Full Auto mode by following the procedure described on page 33.

- 3 Press the REC START/STOP button to begin recording.

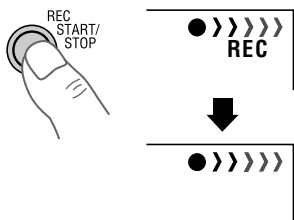

Note:

- When recording at the beginning of a tape, advance the tape about 15 seconds before you begin recording. This will prevent the beginning of the recording being cut off when it is played back.

To Pause Recording

Press the REC START/STOP button again. Recording pauses, and the VIEWCAM enters the Recording Standby mode.

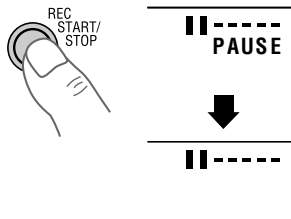

To Turn the Power Off

Slide the Power switch to OFF.

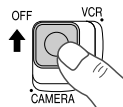

Notes:

- The speaker is off in Camera mode.
- Battery power is consumed in Recording Standby mode. Turn off the power if you will not be recording again soon.
- If the VIEWCAM is kept in Recording Standby mode for more than approximately 5 minutes, the power will automatically turn off to save battery power and to protect the tape from being damaged. To continue recording after this, set the Power switch to OFF, and then back to CAMERA.

Maximum Continuous Recording and Actual Recording Times

Battery pack	Max. continuous recording time	Actual recording time
BT-H22	approx. 1 hr. 40 min.	approx. 50 min.
BT-H32	approx. 3 hr. 20 min.	approx. 1 hr. 40 min.

Note:

- Using the zoom (see page 17) and other functions or turning the power on and off frequently will increase power consumption. This may result in a decrease of more than 50% in the actual recording time compared to the maximum continuous recording time listed above.

Basic Operations

Camera Recording

Zooming

Zooming allows you to move visually closer to or farther from a subject without physically changing your position.

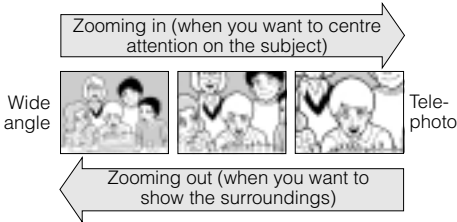

To Zoom In

Push the Power Zoom control to the T (telephoto) side to get a close-up view (①).

To Zoom Out

Push the Power Zoom control to the W (wide angle) side to get a wide field of view (②).

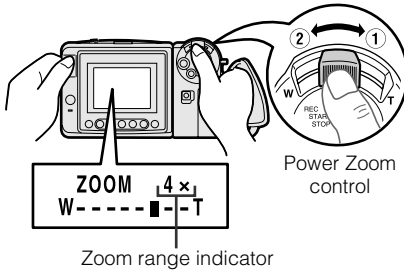

- The on-screen display shows you the current zoom setting.
- The zoom speed changes depending on how far you push the Power Zoom control.

Note:

- The VIEWCAM is unable to focus when zooming in on subjects within 1.5 m. The VIEWCAM will automatically zoom out until it is able to focus on the subject. (See page 30 for recording macro shots.)

Tips on Recording Positions

The rotating LCD monitor screen lets you enjoy easy video recording in a more relaxed posture without having to hold the VIEWCAM up to your eye. The LCD monitor also makes it easier to record high-angle and low-angle shots.

Holding the VIEWCAM

Put the fingers of your right hand through the hand strap, and place your right thumb close to the REC START/STOP button and Power Zoom control. Place your left thumb on the thumb rest on the left side of the LCD monitor.

Basic Posture

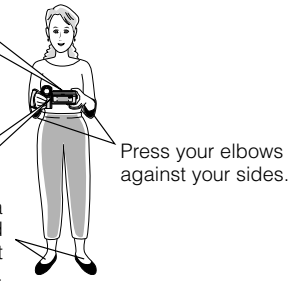
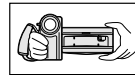
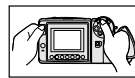

Place your feet at a 45° angle and balance your weight on both legs.

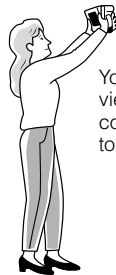

High Angle

You can record while still viewing the screen. This is convenient when you want to record over a crowd.

Low Angle

Put one knee on the ground for the best stability.



Notes:

- In hand-held recording, the VIEWCAM has to be steadied to prevent image shakes. For very stable recording, use a tripod.
- Take care not to touch the microphone with your fingers during recording. It will cause noise on the audio track.

Remaining Recording Time Display

When the VIEWCAM is recording in Camera mode, about 10 minutes before the tape reaches the end, an on-screen indicator displays the approximate remaining recording time.

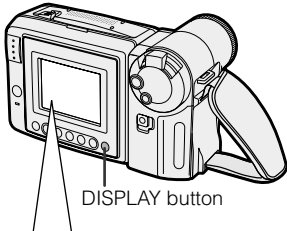

Approx. remaining recording time	On-screen indicator
10 min.–8 min.	TAPE █ █ █ █ █ █
8 min.–6 min.	TAPE █ █ █ █ █ █
6 min.–4 min.	TAPE █ █ █ █ █ █
4 min.–2 min.	TAPE █ █ █ █ █ █
2 min.–1 min.	TAPE █ █ █ █ █ █
1 min.–0 min.	THE TAPE ENDS SOON. ↓ -TAPE END-
0 min. (The tape has reached the end.)	CHANGE THE CASSETTE. ↓ TAPE END

To turn off the remaining recording time display, press the DISPLAY button.

Notes:

- The remaining recording time displays only show the approximate time left. Also, they vary slightly depending on the length of tape used. (This function's design is based on the P5-90 tape standard.)
- If you turn off the remaining recording time display, it will reappear after a short interval to indicate the new time remaining.
- **The remaining recording time display appears 5 seconds after pressing the REC START/STOP button to begin recording.**

Remaining Battery Power Display

When using the VIEWCAM with the battery pack as the power source, you can turn on and off the remaining battery power display by pressing the DISPLAY button.

If the battery power becomes very low, a warning indicator will appear. Replace the battery pack.

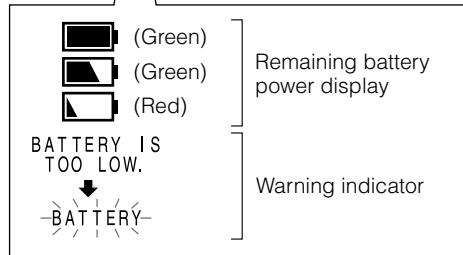
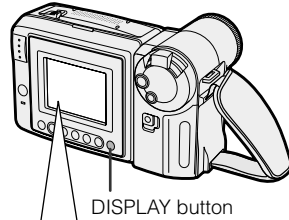

Notes:

- Use the remaining battery power display only as an approximate indication.
- The battery power display may change to either a higher or lower level if you set the Power switch to OFF and then back to CAMERA or VCR.
- In cold environments, the red remaining battery power display may appear sooner. The battery pack, however, can be used until the warning indicator appears. Replace the battery pack at this time.
- Battery consumption may vary depending on the condition of use.
- Use of the zoom function when the warning indicator is displayed may cause the VIEWCAM to suddenly lose power.

Basic Operations

Playback

Playback

The LCD monitor screen makes it possible to play back and see what you have just recorded. Nothing needs to be connected, allowing instant on-screen playback with the sound through the built-in speaker.

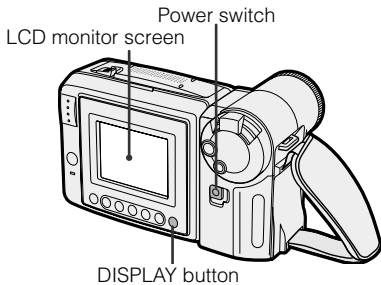

Basic Operations
Playback

- 1 Hold down the Lock button and slide the Power switch to VCR.
 - The screen appears.

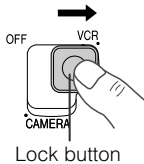

- 2 Press the REW (◀◀) (or FF [▶▶]) button to rewind (or fast forward) the tape to the desired point.



- 3 Press the PLAY button (▶) to begin playback.



To Stop Playback

Press the STOP button (■).



Notes:

- If you wish to turn the Operation button indicators on or off, press the DISPLAY button. The playback operation buttons will still function as indicated even after the indicators are turned off.
- To use the infrared remote control, make sure that the REMOTE menu item is set to "ON" (see page 37).

Auto Tape Rewind

The tape is automatically rewound when playback reaches the end of the tape.

To Turn the Power Off

Slide the Power switch to OFF.

Volume Control

While the VIEWCAM is in VCR mode, push the Volume control to the + or - side to increase (①) or decrease (②) the volume to your preference.

The volume level indicator will appear on the screen during adjustment only. When the Volume control is released, the volume level indicator will disappear shortly afterwards.

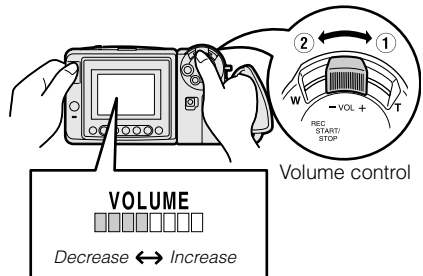

Watching the Playback on a TV

You can also connect the VIEWCAM to a TV to allow a larger audience to enjoy video playback.

- 1 Lift up the terminal cover on the VIEWCAM (①) and rotate it to the right (②).

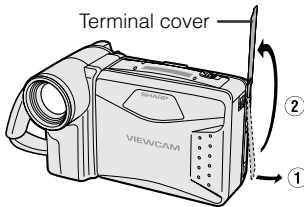

- 2 Connect the VIEWCAM to your TV (or VCR) with the supplied audio/video cable, as shown.

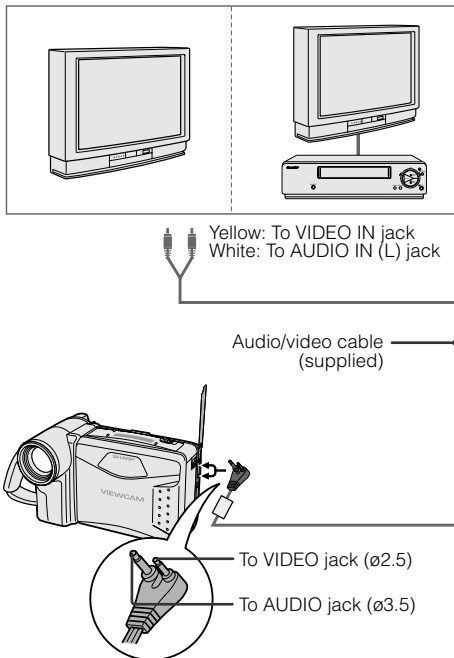

- 3 Turn on the TV and set it to the "AV" or "VIDEO" channel. (See the operation manual of your TV.)
 - When connecting to a TV via a VCR, turn on the VCR and set it to the "AV" or "LINE" input channel. Operate the TV as you normally do to see the signal from the VCR. (See the operation manuals of your TV and VCR.)
- 4 Turn on the VIEWCAM in VCR mode, and begin tape playback (see page 19).

Caution:

- Make sure that the VIEWCAM, TV, VCR and other equipment to be connected have been turned off before you make connections. Making connections with any of the components left turned on may cause picture noise or a malfunction.

Notes:

- **This VIEWCAM does not have an S-video socket.**
- If your TV or VCR has a 21-pin Euro-SCART connector, use the RCA/21-pin Euro-SCART conversion connector (QSOCZ0033TAZZ) available from our main parts distributor detailed on page 53.

21-pin Euro-SCART on TV or VCR

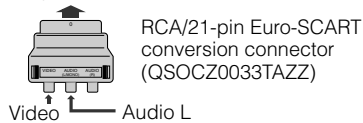

- When the VIEWCAM is connected to a TV for playback, the picture on the TV screen may flicker if the volume on the VIEWCAM is set to maximum. Should this occur, turn the volume down (see page 19).
- Close the terminal cover after use.

Basic Operations

Playback

Video Search

The video search function makes it easy to search for a desired scene on the tape.

Searching for a Scene Near the Current Tape Position

- 1 During playback, press the Forward Search (▶▶) (or Reverse Search [◀◀]) button.
 - The playback picture fast forwards (or reverses).

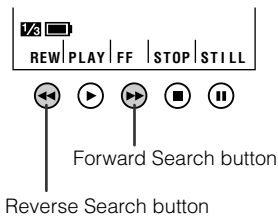

- 2 When you find the desired scene, press the PLAY button (▶) to return to normal playback.

Searching for a Scene Far from the Current Tape Position

- 1 During fast forward (or rewind), press and hold down the Forward Search (▶▶) (or Reverse Search [◀◀]) button.
 - The fast forward (or reverse) playback picture is displayed.
- 2 If the desired scene is still rather far from the current tape position, release the button to return to normal fast forward (or rewind).
- 3 Repeat steps 1 and 2 above until you find the desired scene.
- 4 Press the STOP button (■) and then the PLAY button (▶) to begin normal playback.

Notes:

- The sound is off during search.
- Some picture noise appears during search. This is not a malfunction.

Still

The still function makes it possible to pause playback.

During playback, press the STILL button (||).

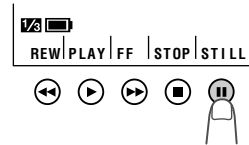

To return to normal playback, press the STILL button again or press the PLAY button (▶).

Notes:

- The sound is off during Still mode.
- To protect the tape, the VIEWCAM automatically returns to normal playback if it is left in Still mode for more than 5 minutes.
- If the still function is used when connected to a TV, noise will appear and distort the playback image.

Useful Features

Operations of the On-screen Controls

Using the Control Buttons

The following buttons on the VIEWCAM can be used to control the various functions, settings and on-screen displays.

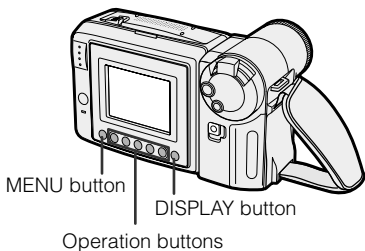

MENU button

Each time you press the MENU button, the mode/menu screen changes from 1/3 to 5/3 in Camera mode and from 1/3 to 3/3 in VCR mode.



DISPLAY button

Press the DISPLAY button to turn the mode/menu screens and on-screen indicators on or off.



Note:

- The warning indicators and some other indicators cannot be turned off by pressing the DISPLAY button.

Operation buttons

Press the Operation button corresponding to the indicator of the desired function displayed on the screen.



Note:

- The Operation button indicators are normally displayed in blue or grey. When a function is selected, its indicator is displayed in yellow.

Selecting the Mode/Menu Screens

You can use the mode screens to select various functions and the menu screens to adjust various settings. Follow the procedure below to display the mode/menu screen with the indicator of the desired function/setting.

- Hold down the Lock button and slide the Power switch to CAMERA (Camera mode) or VCR (VCR mode).

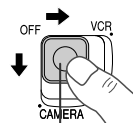

Lock button

- Press the MENU button until the desired screen appears.

Camera mode

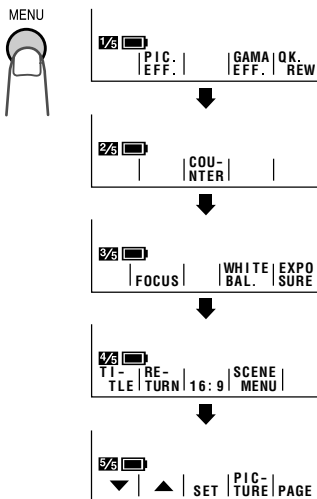

VCR mode

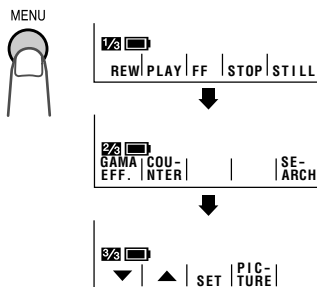

Useful Features

Adjusting the Menu Settings

Follow the procedure below to adjust the desired menu settings.

Camera mode

- 1 Hold down the Lock button and slide the Power switch to CAMERA.
- 2 Press the MENU button until $\frac{5}{6}$ appears.



- 3 Press the PAGE button (||) to display the desired menu screen.
 - Each time you press the PAGE button, the screen changes between MENU 1 and MENU 2.

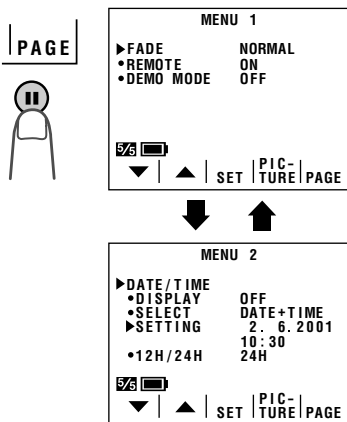

- 4 Press the \blacktriangledown or \blacktriangle button (\blacktriangleleft or \blacktriangleright) to select the desired menu item.

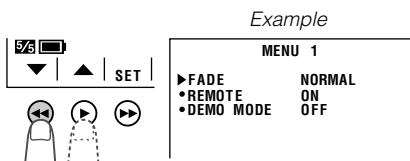

- 5 Press the SET button (\blacktriangleright) to select the desired setting.
 - Each time you press the SET button, the setting changes.

Example

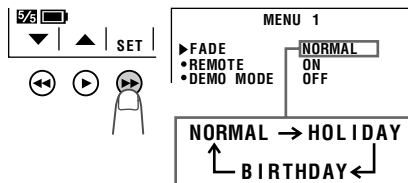

- 6 Press the DISPLAY button to turn off the menu screen.

VCR mode

- 1 Hold down the Lock button and slide the Power switch to VCR.
- 2 Press the MENU button until $\frac{3}{6}$ appears.

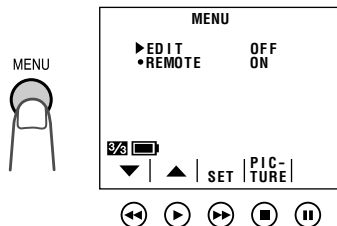

- 3 Perform steps 4 to 6 above.

Notes:

- Certain menu items are common in both Camera and VCR modes. If the REMOTE menu item, for example, is set to "OFF" in Camera mode, it will be automatically set to "OFF" in VCR mode.
- The menu screen automatically turns off if no settings are made within 5 minutes.

Recording the Date and Time

Follow the procedure shown below to record the date and time, or the date only, along with the subject.

Note:

- Before performing the procedure below, make sure that the date and time have been correctly set (see page 13).

1 In Recording Standby mode, press the MENU button until (MENU 1) appears.

2 Press the PAGE button () to display MENU 2.

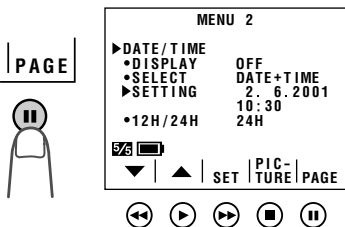

3 Press the or button to select "DISPLAY".

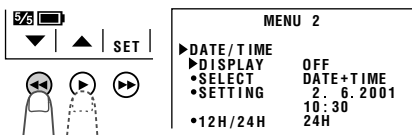

4 Press the SET button () to select "AUTO", "ON", or "OFF".

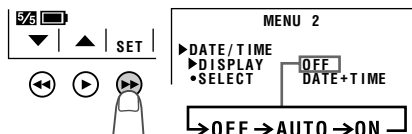

When "AUTO" is selected, the date/time is displayed and recorded for 10 seconds at the beginning of the first recording of each day.

When "ON" is selected, the date/time is continuously displayed and recorded.

When "OFF" is selected, the date/time is neither displayed nor recorded.

Note: In "AUTO", if you wish to record the date/time a second time that day, repeat the procedure above and re-select "AUTO".

5 Press the button to select "SELECT".

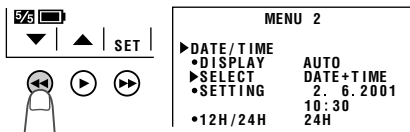

6 Press the SET button () to select "DATE+TIME" or "DATE".

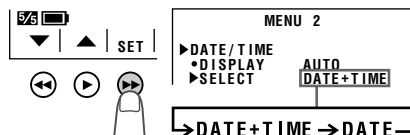

When "DATE+TIME" is selected, both the date and the time are displayed and recorded.

When "DATE" is selected, only the date is displayed and recorded.

7 Press the DISPLAY button to turn off the menu screen, and then press the REC START/STOP button to begin recording.

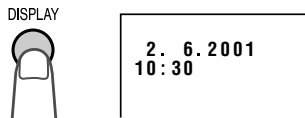

Fade In and Fade Out

The fade function allows you to gradually bring the image and sound in or out at the beginning or end of a scene to create a scene transition. This VIEWCAM features one normal and two animated fade modes.

Type of Fade Modes

NORMAL: The picture fades in from and out to white.

HOLIDAY: The picture fades in from an animated firework sequence with the title "HAPPY HOLIDAYS!", and fades out to white.

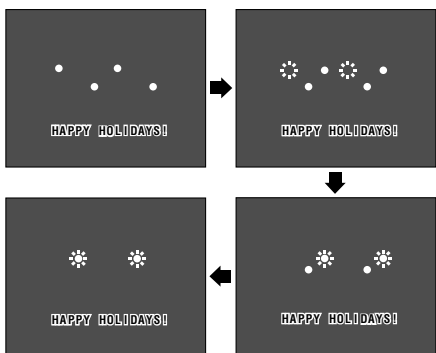

BIRTHDAY: The picture fades in from an animated birthday cake sequence with the title "HAPPY BIRTHDAY!", and fades out to white.

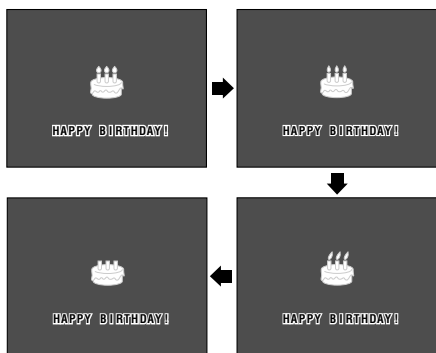

Selecting Fade Mode

- In Recording Standby mode, press the MENU button until (MENU 1) appears.

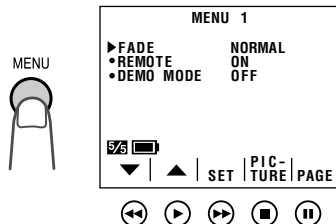

- Press the or button (1) to select "FADE", then press the SET button (2) to select the desired fade mode.

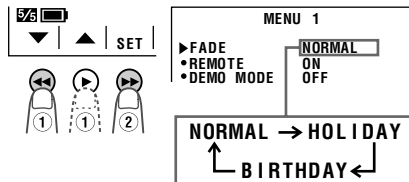

- Press the DISPLAY button to turn off the menu screen.

Using Fade Mode

- In Recording Standby mode, press the FADE button.
 - The selected fade mode indicator appears. ("FADE" is displayed for the NORMAL fade mode indicator.)

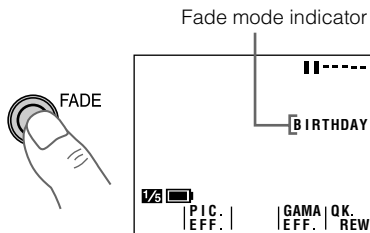

- 2** Press the REC START/STOP button to begin recording.

- The picture and sound fade in with the selected fade mode.



- 3** Press the REC START/STOP button at the point where you wish to stop recording.

- The picture and sound fade out as the screen gradually turns white. The VIEWCAM then returns to Recording Standby mode.

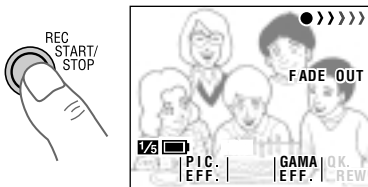

To cancel Fade mode

Press the FADE button.

To use fade out only

- 1** During recording, press the FADE button.
- 2** Press the REC START/STOP button at the point where you wish to stop recording.

Quick Review

The quick review function lets you check the last 5 seconds of tape just recorded without switching to VCR mode, to make sure that the recording has come out right.

- 1** In Recording Standby mode, press the MENU button until $\frac{1}{3}$ appears.



- 2** Press the QK. REW button (||).

 - The tape rewinds to the point of 5 seconds before the current tape position; playback then starts automatically.

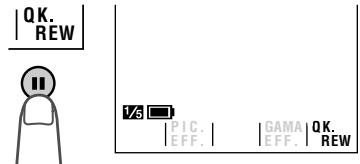

After 5 seconds of playback, the VIEWCAM enters the Recording Standby mode.

Quick Return

When you have been playing back what you have recorded, and wish to quickly return to recording again from the end of the last recorded scene, use the quick return function.

- 1 In Recording Standby mode, press the MENU button until $\frac{4}{5}$ appears.



- 2 Press the RETURN button (▶).
 - "QUICK RETURN" flashes, and the tape will begin fast forwarding or rewinding to the end of the last recorded scene.

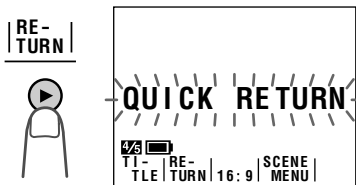

When the tape reaches the end of the last recorded scene, the VIEWCAM enters the Recording Standby mode.

Notes:

- To cancel the quick return function, press the RETURN button again in step 2.
- If the cassette has been removed since the last recording, if no recording has been made since the cassette was loaded, or if the power source has been interrupted, the RETURN button indicator will not appear and the quick return function cannot be used.

Edit Search

The edit search function lets you search, without switching from Camera mode to VCR mode, for the point on the tape where you wish to start recording next.

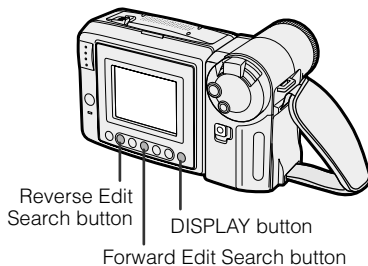

- 1 In Recording Standby mode, make sure that no Operation button indicators are displayed on the monitor.
 - If they are displayed, turn them off by pressing the DISPLAY button.
- 2 Press and hold down the Forward Edit Search button (▶▶) or Reverse Edit Search button (◀◀).

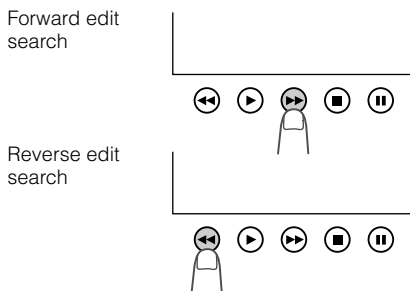



- 3 When you find the point where you want to begin recording, release the button.

Notes:

- The sound is off during search.
- Some picture noise appears during reverse edit search.
- Forward edit search is performed at the same speed as normal playback, and reverse edit search at three times the normal playback speed.

Gamma Brightness Compensation

When the subject is backlit, the image will be darkened if it is recorded normally. The gamma brightness compensation function improves the picture by increasing the brightness of the subject while leaving the brighter portions of the image unaffected.

- 1 Press the MENU button until  appears (Camera mode).
- 2 Press the GAMA EFF. button () once.
 - “GAMMA” appears, indicating that the Gamma Brightness Compensation is now working.

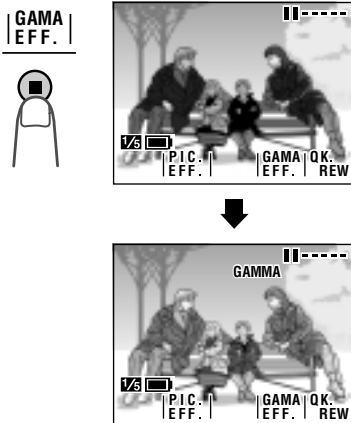

Note:

- The gamma brightness compensation function can also be used during playback. See page 46, “Gamma Playback”.

To obtain a brighter picture

Press the GAMA EFF. button () again.

- The  indicator appears.

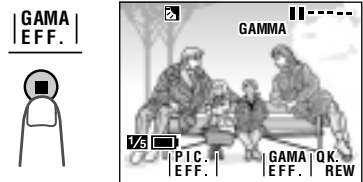

Note:

- When the  indicator is displayed, the background will become slightly brighter.

To cancel Gamma Brightness Compensation

Press the GAMA EFF. button until “GAMMA” disappears.

Gain-up (Cat's Eye)

When you are recording in a dark or poorly illuminated location, "LIGHT" is displayed on the screen. Use the gain-up function to record a brighter picture.

- 1 Press the MENU button until $\frac{1}{2}$ appears (Camera mode).
- 2 Press the GAMA EFF. button (■) once.
 - "GAMMA" appears, indicating that the gain-up function is now working.

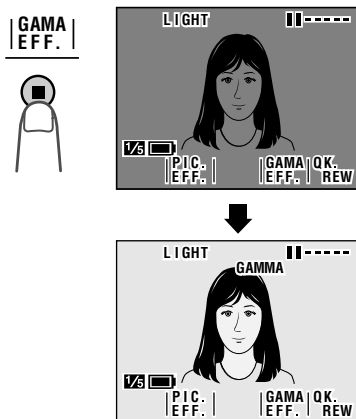

To obtain a brighter picture

Press the GAMA EFF. button (■) again.

- The $\nabla \times \nabla$ indicator appears.

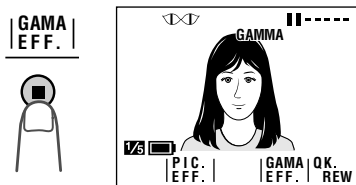

To cancel the gain-up function

Press the GAMA EFF. button until "GAMMA" disappears.

Notes:

- The Gain-up mode will disengage and the $\nabla \times \nabla$ indicator will disappear automatically if the VIEWCAM is moved to a bright location.
- Some picture noise appears in Gain-up mode. The picture noise increases when the $\nabla \times \nabla$ indicator is displayed.

Wide Screen (16:9)

The wide screen function lets you record scenes with the wide-screen feel of a movie shown in a theatre. The top and bottom of the picture are masked with black bands to produce an effective screen aspect ratio of 16:9.

- 1 Press the MENU button until $\frac{4}{5}$ appears (Camera mode).



- 2 Press the 16:9 button (▶▶).
 - The monitor now displays the picture with the top and bottom portions masked.



- 3 Press the DISPLAY button to turn off the Operation button indicators.

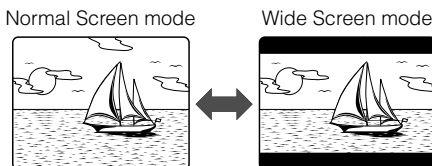

To return to normal picture

Perform step 1 above, and press the 16:9 button.

Note:

- You can only use the wide screen function when the VIEWCAM is in Camera mode.

Macro Shots

This VIEWCAM lets you shoot close-up images of small objects such as flowers and insects, or make title frames for your videos. When you want to record a magnified image of a subject which is within approximately 1.5 m of the VIEWCAM, do not zoom in on it. Instead, zoom out all the way by pushing the Power Zoom control to the W side, and then move the VIEWCAM closer to the subject until you obtain the desired angle of view. The VIEWCAM will automatically focus on the subject when the lens is set for the widest angle.

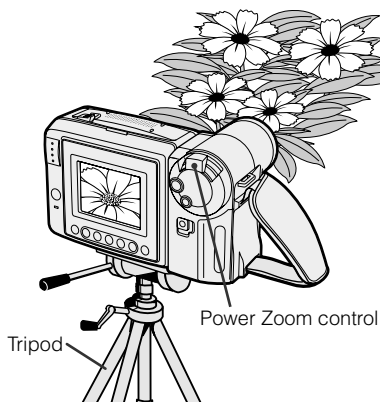

Notes:

- When you are recording a macro shot, be sure that the subject receives sufficient illumination.
- It is recommended that you use a tripod for recording macro shots, to prevent image shakes.

Removing the Lens Hood

The lens hood can be removed (e.g. for cleaning the lens) by rotating it in an anticlockwise direction (①) and then gently pulling it off (②).

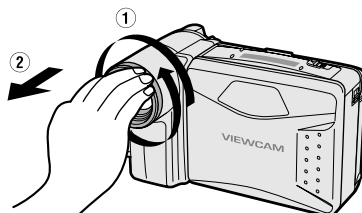

Self Recording

The LCD monitor can be rotated 180° vertically so that the monitor screen faces the subject. This lets you record yourself while watching your image on the screen.

You can enjoy recording a portrait of yourself, or recording yourself and your friends together at a party, using the remote control.

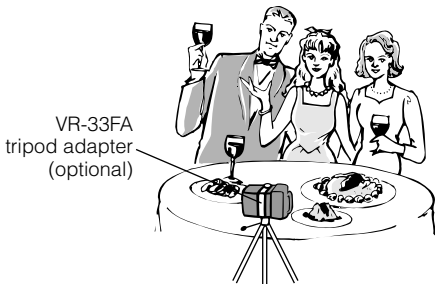

Normal Self Recording

- 1 Set the Power switch to CAMERA.
- 2 Rotate the monitor section 180° vertically.
 - The screen image will be inverted to show a mirror image of the subject, and the self-recording mode screen appears.

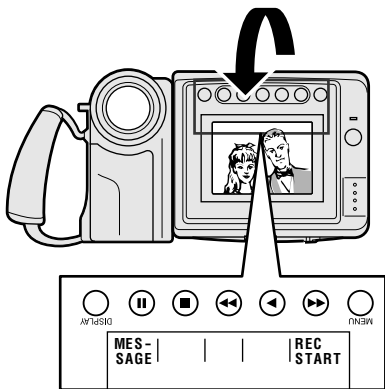

- 3 Push the Power Zoom control to obtain the desired angle of view.

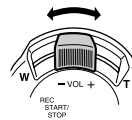

- 4 Press the REC START button (▶▶) to begin recording.

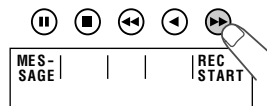

To pause recording, press the REC STOP button (▶▶).

Cautions:

- Do not rotate the monitor to the self recording position during recording or playback.
- For recording in Self Recording mode, be sure to rotate the monitor, NOT the lens. If you hold the VIEWCAM upside down with the lens at the bottom, the subject will be recorded upside down.

Notes:

- You will need the VR-33FA tripod adapter for 180° recording (optional accessory) if you want to use a tripod when recording in Self Recording mode.
- In Self Recording mode, only the REC START/STOP button and the Power Zoom control buttons can be used on the remote control.

More Information on Self Recording

- The screen image is automatically inverted when the monitor rotation is between 135° and 200°. When the monitor is turned back to the normal position, the image returns to normal.
- In Self Recording mode, all standard warning indicators on the screen are replaced by the flashing ⬠ indicator. To check the type of warning, rotate the monitor back to the normal position.
- In Self Recording mode, it is not possible to record using manual recording modes, change picture adjustments, display menus, record the date and time, or use the Quick Return and some of the other functions.
- You can play back images even while the monitor is in the self recording position. Set the Power switch to VCR. The Operation buttons still retain their functions as during normal playback, even though the button indicators are not displayed. (For example, the ◀ button still works as the Play button.)

Self-recording Message

In Self Recording mode, you can record a short video message for somebody. This feature is convenient for editing video letters.

- Complete steps 1 to 3 of "Normal Self Recording" on page 31, then perform the procedure below.

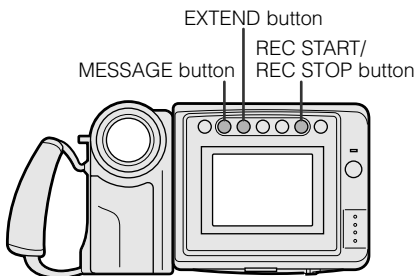

- 1 Press the MESSAGE button (||) to display the self-recording message screen.

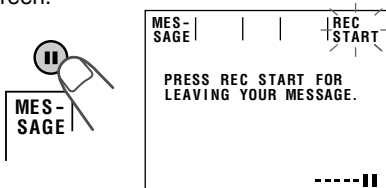

- 2 Press the REC START button (▶▶) to begin recording. Record your message while facing the lens of the VIEWCAM.
 - The recording time is preset for 20 seconds.
 - The bar on the screen indicates the remaining recording time.

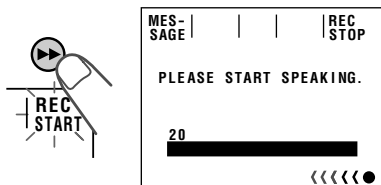

- 3 When the remaining recording time reaches 5 seconds, "EXTEND" will begin flashing.
 - When you want to extend the recording time, press the EXTEND button (■) within 5 seconds. You may record continuously for 10 more seconds.

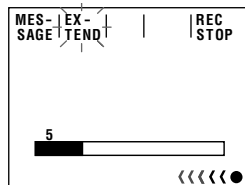

At the end of the recording, the screen fades out, and the VIEWCAM returns to Recording Standby mode.

To turn off the self-recording message screen

Press the MESSAGE button in Recording Standby mode.

Note:

- When you want to stop recording before message recording stops automatically, press the REC STOP button (▶▶).

Setting the VIEWCAM to Full Auto Mode

This VIEWCAM is equipped with auto focus, auto white balance, and auto exposure functions. For easy, high-quality camera-recording, record subjects in Full Auto mode.

If "AUTO" is not displayed even when the DISPLAY button is pressed, perform the procedure below to set the VIEWCAM to Full Auto mode.

- 1 In Recording Standby mode, press the MENU button until **1/6** appears. If "PIC. EFF" is not displayed above the ► button, press this button until "PIC. EFF" appears.

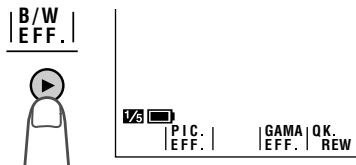

- 2 Press the MENU button until **2/6** appears. If "MAN'L FOCUS" is displayed, press the ► button to change it to "FOCUS".

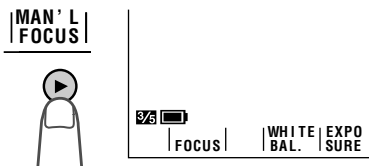

- 3 If "WHITE BAL." is displayed in yellow, press the WHITE BAL. button (■).

 - "WHITE BAL." returns to blue.

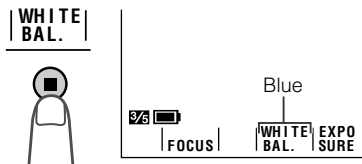

- 4 If "EXPOSURE" is displayed in yellow, press the EXPOSURE button (||) to display the exposure setting screen, then press the AUTO button (▶▶).

 - The exposure setting screen turns off and "EXPOSURE" returns to blue.

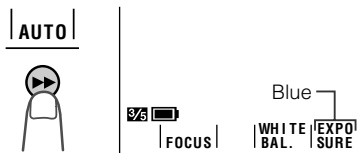
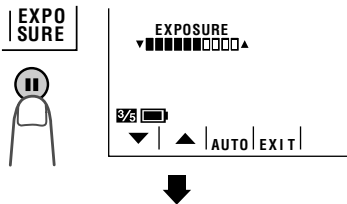

- 5 Press the MENU button until **4/6** appears. If "SCENE MENU" is not displayed above the ■ button, press this button until "SCENE MENU" appears.

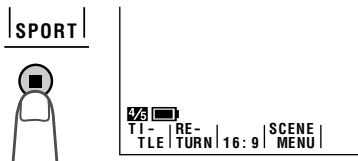

- 6 Press the DISPLAY button.
 - The Operation button indicators disappear, and "AUTO" is displayed on the screen.

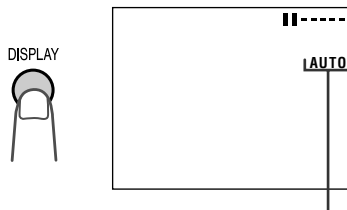

Full Auto mode indicator

Program Search

The program search function automatically finds and plays back the beginning of a number of previously recorded scenes. Up to 10 different scenes can be found on one tape.

Note:

- This function does not work if no recording has been made since the cassette was loaded, if the cassette has been removed after the recordings were made, or if the power source has been interrupted.

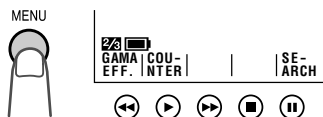

- 1 Press the MENU button until  appears (VCR mode).



- 2 Press the SEARCH button ().
 - "PROG. SEARCH" is displayed and one of or both "REW" and "FF" will start flashing.



- To cancel, press the SEARCH button again.

- 3 Press the REW () (or FF ()) button.

- The tape rewinds (or fast forwards) to the beginning of a scene immediately before (or after) the current tape position; playback then starts automatically.

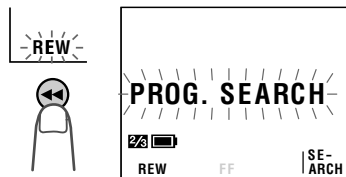



- 4 To continue searching, press the REW (or FF) button while "REW" (or "FF") is still displayed.

Notes:

- Use this function when the tape is stopped or being played back.
- This function finds the beginning of each scene immediately before or after the current tape position. It is not possible to skip a scene.
- This function cannot spot recordings that are shorter than 10 seconds in length.
- In steps 2 and 4, if the tape is at a point ahead of the last (or before the first) recording, the FF (or REW) indicator will not appear.

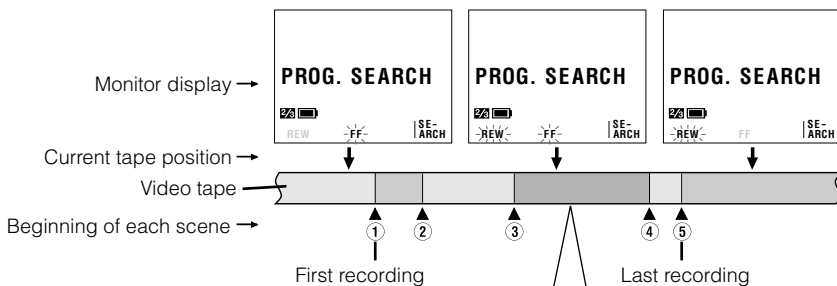
Example: When using a tape with five different scenes.



When you are at this position:
 Press the REW button () to rewind the tape to ③ and begin playback.
 Press the FF button () to forward the tape to ④ and begin playback.

Tape Counter Feature

The tape counter shows elapsed playback or recording time in hours, minutes and seconds. (The counter continues to count internally even while it is not being displayed.) This feature can be set and used in both VCR and Camera modes.

Using the Counter

VCR mode

- 1 Press the MENU button until $\frac{2}{3}$ appears.

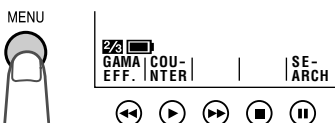

- 2 Press the COUNTER button (▶) to display the tape counter.

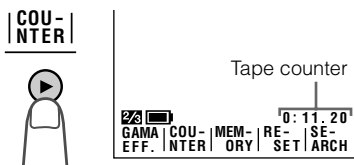

- 3 Press the MENU button until $\frac{1}{3}$ appears, then begin playback.
 - You can check the playback time with the tape counter.



Camera mode

- 1 Press the MENU button until $\frac{2}{5}$ appears.
- 2 Press the COUNTER button (▶▶) to display the tape counter.
- 3 Press the REC START/STOP button to begin recording.
 - You can check the recording time with the tape counter.

Notes:

- The counter reading may differ slightly from the actual time. This is especially noticeable when the tape has been rewound or fast forwarded a number of times, in which case there can be a difference of several seconds.
- The tape counter feature will be cancelled if the power source is interrupted.

To turn off the tape counter

Perform step 1 above, and press the COUNTER button.

To reset the counter to zero

During playback (or recording), perform steps 1 and 2 above, then press the RESET button at the point where you wish to reset the counter to zero. The counter will indicate 0:00.00.

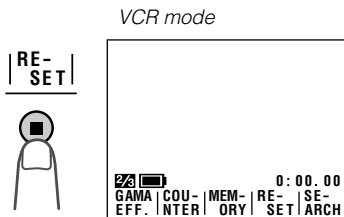

Using the Counter Memory

Use the counter memory feature when you want to return to the beginning of a particular scene. The position where the counter was reset (0:00.00) is stored in memory to make it easier to return to that point on the tape.

VCR mode

- 1 During playback, press the MENU button until **2/3** appears.



- If "MEMORY" is not displayed, press the COUNTER button.

- 2 Press the MEMORY button to set the counter to Counter Memory mode.

- "M" will be displayed to the left of the counter.

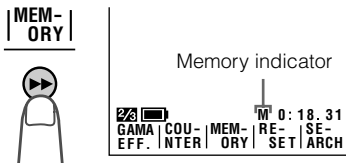

- 3 Press the RESET button to reset the counter to zero at the beginning of the scene that you want to return to later.

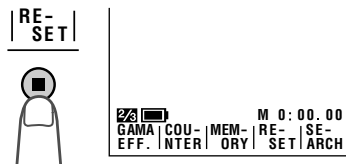

- 4 Press the MENU button until **1/2** appears. When you are ready to finish playback, press the STOP button (■).

- 5 Press the REW button (◀◀).
 - The tape will automatically stop when the counter reaches 0:00.00.

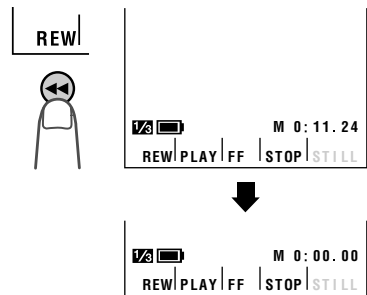

Notes:

- The FF button (▶▶) can be used in the same way.
- The tape may stop slightly ahead or behind the point where you reset the counter to "M 0:00.00".

- 6 Press the PLAY button (▶) to view the desired scene.

Camera mode

- 1 During recording, press the MENU button until **2/3** appears.
 - If "MEMORY" is not displayed, press the COUNTER button.
- 2 Perform steps 2 and 3 above.
- 3 When you are ready to finish recording, press the REC START/STOP button.
- 4 Set the Power switch to VCR, then perform steps 5 and 6 above.

To cancel Counter Memory mode

Perform step 1 above, and press the MEMORY button. "M" will disappear from the screen.

Note:

- This feature does not work during video search.

Useful Features

Using the Remote Control

Use the remote control to operate the VIEWCAM from a distance, such as when you want to record yourself in a scene, or when the VIEWCAM is connected to a TV for use as a VCR.

Installing the Batteries in the Remote Control

- 1 Open the battery compartment cover.
- 2 Insert the two supplied AA (R6 or UM/SUM-3) batteries with the battery poles positioned as indicated.

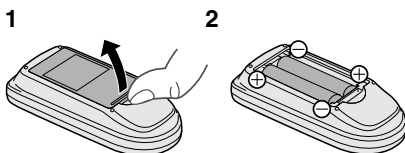

- 3 Replace the cover.

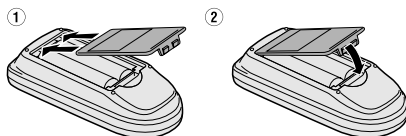

Caution:

- Do not use old and new batteries together or batteries of different brands together.

Turning On the Remote Control Mode

- 1 Press the MENU button until appears (VCR mode).
- 2 Press the or button (1) to select "REMOTE", then press the SET button () (2) to select "ON".

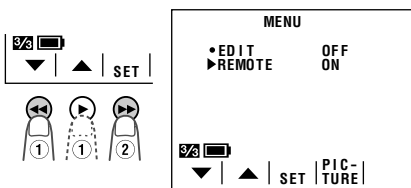

- 3 Press the DISPLAY button to turn off the menu screen.

Operating the Remote Control

Aim the remote control at the remote sensor of the VIEWCAM, and press the control buttons for operation.

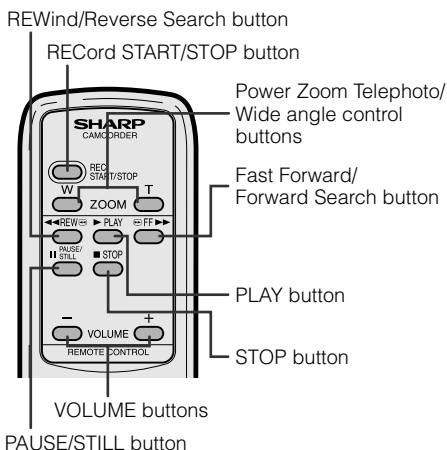
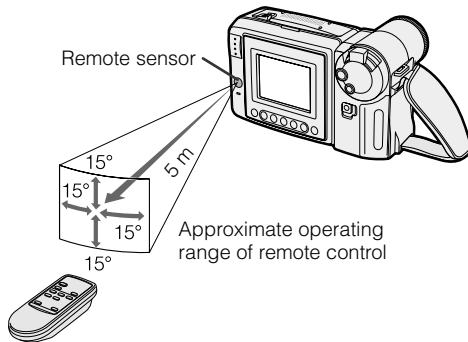

Notes:

- Be careful not to allow direct sunlight or bright light from interior illumination to fall onto the VIEWCAM remote sensor, as this may prevent the remote control from operating properly.
- Be sure that there are no obstacles between the remote control and the VIEWCAM remote sensor.
- The remote control cannot be used to move the pointer, or select or set any of the various functions on the monitor.
- When the batteries are depleted and the remote control does not operate, replace them with new AA (R6 or UM/SUM-3) batteries.
- You can also turn on the Remote Control mode on the (MENU 1) screen in Camera mode.

Advanced Features

Digital Picture Effects

These digital picture effects let you record the subject with a more dramatic effect.

Type of Digital Picture Effects

B/W EFF.: The picture is recorded in black-and-white.

SEPA EFF.: The picture is recorded in sepia colour similar to that of an old photograph.

SOLARI: The contrast of the subject is enhanced, creating a unique artistic image.

NEGA EFF.: The blacks and whites of the image are reversed and colours of the image are inverted.

To cancel the digital picture effect

Select "PIC. EFF." in step 2 above.

Note:

- The digital picture effect will be cancelled if the power source is interrupted.

- 1 In Recording Standby mode, press the MENU button until **1/3** appears.

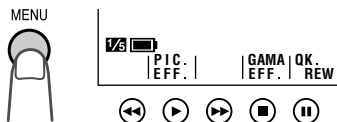

- 2 Press the ► button to select the desired digital picture effect.

- Each time you press the ► button, the digital picture effect changes as shown below.

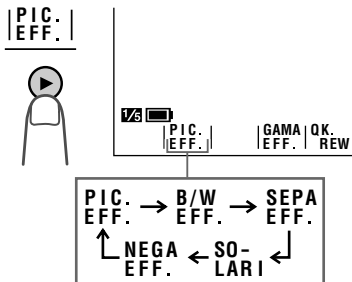

- 3 Press the DISPLAY button to turn off the Operation button indicators.

Scene Menu (Program AE)

You can set the VIEWCAM to the shooting mode that will create the best results for a specific type of shooting situation. Just select one of the four scene settings shown below. The VIEWCAM will automatically set the exposure, white balance, and shutter speed to produce the optimum picture quality for the selected situation.

Type of Scene Settings

SPORT: When you want to record a fast-moving subject.

SUNLIGHT: When the background is very bright.

DUSK: When you want to faithfully record the red of the setting sun, and the surrounding twilight.

PARTY: When the illumination is from a spotlight or candles.

To cancel the scene setting

Select "SCENE MENU" in step 2 above.

Notes:

- Even after you turn off the scene setting indicator, the selected scene setting will remain in effect.
- When "SPORT" is selected, recording under the light of fluorescent lamps, mercury lamps, or sodium lamps may cause colour shifts or fluctuations in picture brightness.
- When "DUSK" is selected, the picture may not be satisfactory if the lighting is very dim.
- It is recommended that you select "SCENE MENU" to record outdoor parties.
- The scene setting will be cancelled if the power source is interrupted.

- 1 In Recording Standby mode, press the MENU button until $\frac{4}{3}$ appears.



- 2 Press the \blacksquare button to select the scene setting that best fits the recording situation.
 - Each time you press the \blacksquare button, the scene setting changes as shown below.

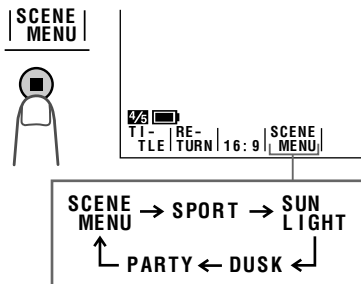

Superimposing a Title

Use the title feature to superimpose titles on your videos when recording. There are eight titles preset for your convenience which you can choose from.

- 1 In Recording Standby mode, press the MENU button until $\frac{4}{5}$ appears.

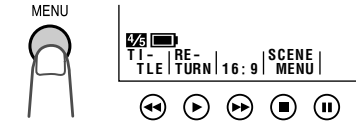

- 2 Press the TITLE button (◀◀) to display the title selection screen.

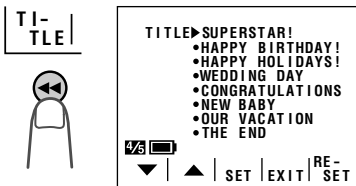

- 3 Press the ▼ or ▲ button (①) to select the desired title, then press the SET button (▶▶) (②) to superimpose it.

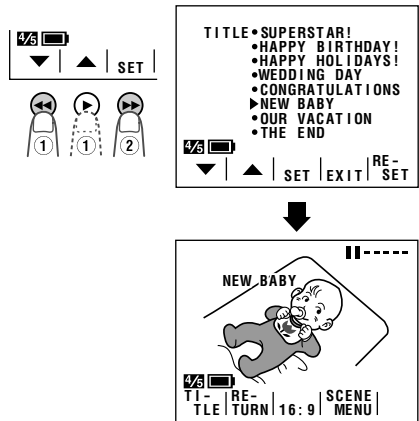

Notes:

- If you wish to cancel the title selection screen without setting the title, press the EXIT button (■) instead of the SET button.
- If you wish to delete the superimposed title from the screen, press the TITLE button.

- 4 Press the REC START/STOP button to begin recording with the title.

- The title will be displayed and recorded for about 10 seconds after recording begins.

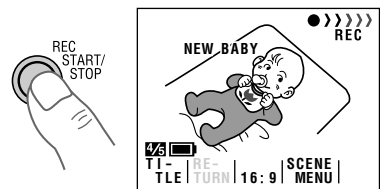

Note:

- When the title is displayed on the screen, the date and time will not be displayed or recorded.

Changing the Preset Titles

You can make a new title of your own by changing any of the eight preset titles. The maximum number of title characters is fifteen.

Example: Changing "WEDDING DAY" to "IN HAWAII".

- 1 Press the MENU button until $\frac{4}{3}$ appears, and then press the TITLE button (\leftarrow) to display the title selection screen.

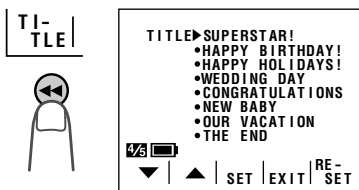

- 2 Press the ∇ or \blacktriangle button to select the title that you wish to change.

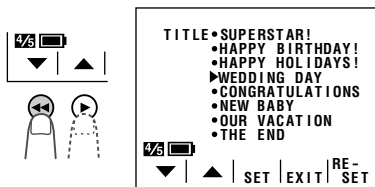

Note: If you want to cancel the title selection screen, press the EXIT button (\blacksquare).

- 3 Press the RESET button (\parallel) to display the title input screen.



- 4 Press the \blacktriangleright or \blacktriangleleft button (1) to select the desired character (or " " for space) and press the SELECT button (\blacksquare) (2).
 - The selected character will appear at the top of the screen and the cursor will automatically move to the right.

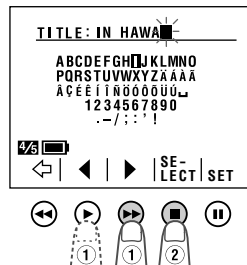

Note: If you input the wrong character, press the \leftarrow button to move the cursor to that character and perform step 4.

- 5 Repeat step 4 until you finish the title, then press the SET button (\parallel). The new title will be displayed on the title selection screen.

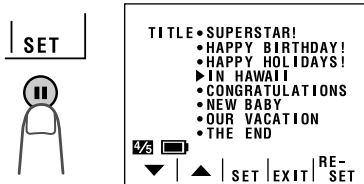

Note: To change another title, perform steps 2 to 5 again.

- 6 If you wish to record the new title immediately, press the SET button (\blacktriangleright). If you wish to record the new title at a later time, press the EXIT button (\blacksquare) to go back to the normal $\frac{4}{3}$ screen.

Auto/Manual Focus

Auto Focus









The auto focus function is designed to focus on most types of subjects. In Auto Focus mode, the VIEWCAM automatically focuses on whatever is in the centre of the scene. Always keep the subject in the centre of the screen.

Notes:

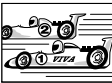
- If no subject is in the centre of the screen, the focus area will expand and the subject nearest the centre will be focused on.
- If no subject is displayed on the screen, the VIEWCAM will automatically zoom out until a subject comes into the frame.

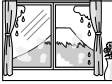
Manual Focus

The Auto Focus may not be able to focus on the subject in the situations shown below. In such situations, set the VIEWCAM to Manual Focus mode and focus manually.

	
Subject is too dark.	Lack of contrast, e.g. snow scene.
	
Fast-moving subject.	Background is too bright.
	
Subject has horizontal stripes.	Subject is being shot through a dirty or wet window.
	
Light reflects off the subject.	Two subjects at different distances overlap in the same scene.
	
Subject has fine, repeated patterns.	Subjects at different distances appear in the centre of the scene at the same time.



- 1 In Recording Standby mode, press the MENU button until  appears.

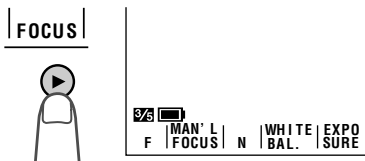

- 2 Press the FOCUS button () to set the VIEWCAM to Manual Focus mode ("MAN'L FOCUS").



- 3 Push the Power Zoom control to frame the subject as you desire.

- 4 Press the F () or N () button to focus on the subject.

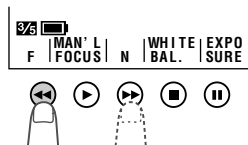

To cancel Manual Focus mode

Perform step 1 above, and press the  button to set the VIEWCAM to Auto Focus mode ("FOCUS").

Notes:

- The VIEWCAM may not be able to focus correctly if the subject is within approximately 1.5 m. Set the zoom control to wide angle, and then try refocusing.
- If the lens is dirty or fogged, the VIEWCAM may not be able to correctly focus.
- The Manual Focus mode will be cancelled if the power source is interrupted.

White Balance Lock

The colour of the subject on the screen tends to look different depending on the lighting condition. The VIEWCAM is preset to Auto White Balance mode, which automatically adjusts the hue of the picture for the current lighting condition.

The auto white balance may not work properly for the following subjects. In this case, use the white balance lock function.

- Subjects with one dominant colour or subjects against background with one dominant colour
- Subjects under very bright light source, e.g. video lights
- Subjects under light source with red hue, e.g. glow of sunset
- Close-up images of small objects

- 1 In Recording Standby mode, press the MENU button until  appears.

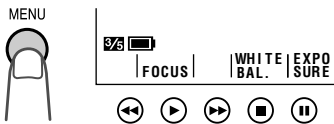

- 2 Aim the lens at a white object.

- Adjust the distance of the object so that the entire screen is white.

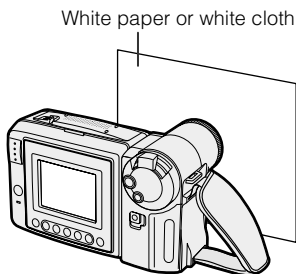

- 3 Press the WHITE BAL. button ().
 - "WHITE BAL." changes from blue to yellow and begins flashing.

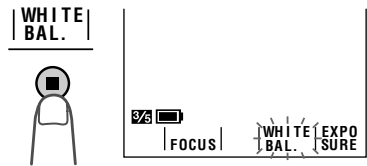

- "WHITE BAL." stops flashing when the locking procedure is completed.

- 4 Aim the lens at the desired subject and press the REC START/STOP button to begin recording.

To cancel White Balance Lock

Press the WHITE BAL. button. "WHITE BAL." returns to blue.

Notes:

- If the light source changes or if you move from indoors to outdoors, or vice versa, when recording with the white balance locked, the white balance may shift. Reset the white balance.
- Even after the white balance has been locked, white balance shifts may occur due to slight changes in illumination or depending on the subject.
- Do not move the VIEWCAM while "WHITE BAL." is flashing in step 3.
- If "WHITE BAL." does not stop flashing in step 3, press the WHITE BAL. button to cancel the locking procedure and repeat step 3.
- The White Balance Lock will be cancelled if the power source is interrupted.
- **The White Balance Lock will be cancelled if a scene setting is selected thereafter.**

Manual Exposure

The VIEWCAM is preset to Auto Exposure mode, which automatically chooses the optimal aperture. When there is too much contrast in brightness between the subject and background, however, you may not be able to record a clear image. In this case, use the manual exposure function to correct the exposure level.

Background is too bright and subject too dark (backlit subject).

- Increase the exposure level to allow more light through the lens.

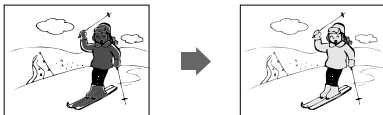

Subject is too bright against background.

- Decrease the exposure level to allow less light through the lens.

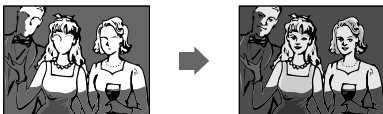

- 1 In Recording Standby mode, press the MENU button until appears.

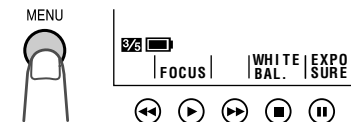

- 2 Press the EXPOSURE button () to display the exposure setting screen.

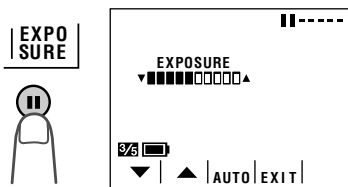

- 3 Press the or button to select the desired exposure level.
 - The bar indicates the selected exposure level.

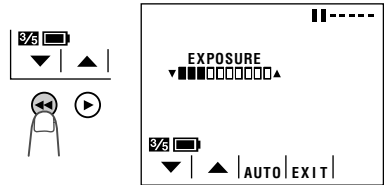

- 4 Press the EXIT button () to turn off the exposure setting screen.

To cancel Manual Exposure mode

Perform steps 1 and 2 above, then press the AUTO button ().

Notes:

- The Manual Exposure mode will be cancelled if the power source is interrupted.
- **The Manual Exposure mode will be cancelled if a scene setting is selected thereafter.**

Picture/Backlight Adjustments

If the monitor picture is difficult to see due to ambient lighting, etc., adjust the picture settings. This feature can be adjusted in both Camera and VCR modes.

- The example screens for this feature are for Camera mode.

- Press the MENU button until $\frac{5}{6}$ (Camera mode) or $\frac{5}{2}$ (VCR mode) appears.

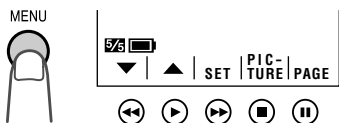

- Press the PICTURE button (■) to display the adjustment screen. Then press the SELECT button (▶▶) until the item you wish to adjust appears.

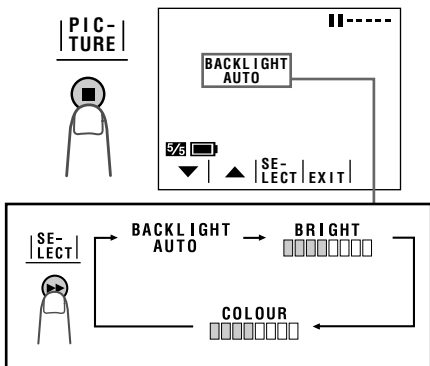

- Press the ▼ or ▲ button to adjust the picture or backlight to the desired setting.

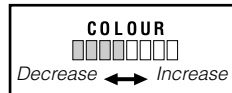
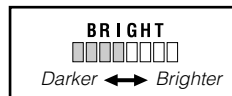
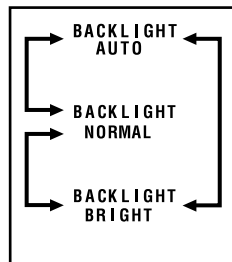

Type of Backlight Modes

AUTO: The VIEWCAM automatically switches between “NORMAL” and “BRIGHT” depending on the ambient lighting. This mode is only available in Camera mode.

NORMAL: For use indoors or under moderate lighting conditions.

BRIGHT: For use outdoors under strong lighting conditions, such as bright daylight.

- Press the EXIT button (■) to turn off the adjustment screen.

Notes:

- If you set the backlight (“BACKLIGHT”) to “AUTO” in Camera mode and then set the VIEWCAM to VCR mode, the backlight mode automatically changes to “NORMAL”.
- When the colour is adjusted, the picture on the screen may differ from the picture actually recorded. Do not change the colour setting unless it is necessary. (This adjustment only affects the monitor picture, not the recorded image.)

Gamma Playback

The gamma playback function improves the picture by increasing the brightness of the subject while leaving the brighter portions of the image unaffected.

- 1 During playback, press the MENU button until **2/3** appears.

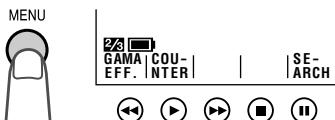

- 2 Press the GAMA EFF. button (◀◀).
 - "GAMMA" appears and the picture becomes brighter.

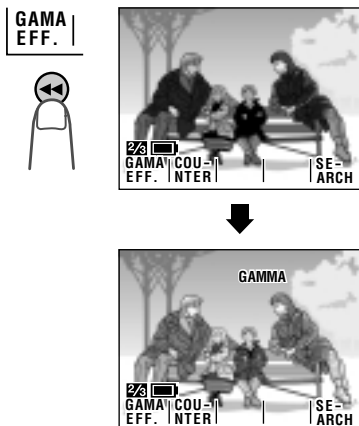

To cancel Gamma Playback

Press the GAMA EFF. button again. "GAMMA" disappears.

Turning Off the LCD Monitor Backlight

The LCD monitor uses a fluorescent lamp for backlighting (see page 50). In order to reduce battery consumption, you can turn off the lamp when backlighting is not necessary (e.g. when you are recording a fixed scene).

Hold down the DISPLAY button. Three seconds later, "LCD LAMP OFF" starts flashing on the monitor. Keep the DISPLAY button down for three more seconds, and the backlight will turn off.

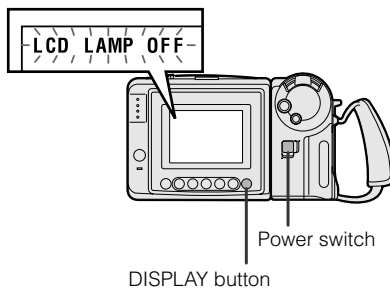

To turn on the backlight again, press the DISPLAY button or set the Power switch to OFF and then back to CAMERA or VCR.

Note:

- Turning the backlight on and off repeatedly may deplete the battery power.

Editing

Video editing lets you refine your videos by removing unwanted sequences from your tape, or transposing one sequence with another. This VIEWCAM lets you monitor the source program on the built-in LCD monitor without having to connect it to an external TV or video monitor.

Connect the VIEWCAM to a VCR with the supplied audio/video cable, as shown.

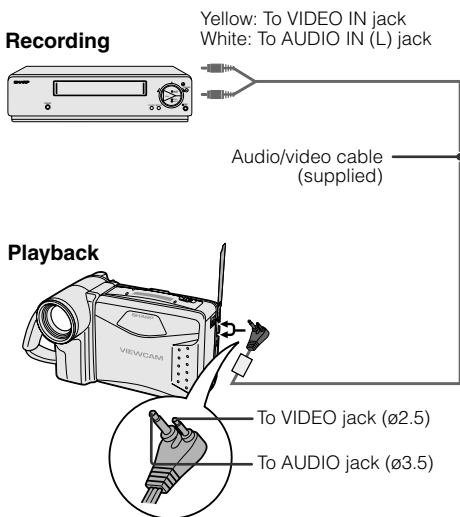

Note:

- If your VCR has a 21-pin Euro-SCART connector, use the RCA/21-pin Euro-SCART conversion connector (QSOCZ0033TAZZ) available from our main parts distributor detailed on page 53.

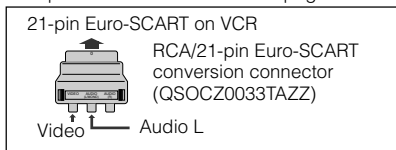

Cutting Unwanted Sequences

- 1 Play back the tape to be edited, and locate the beginning and end of the sequence you wish to cut. Write down the tape counter readings at the beginning and end of that sequence (see page 35). Then rewind the tape to the beginning of the portion that you wish to keep.
- 2 Load a video cassette into the recording VCR.
- 3 Set the Power switch on the VIEWCAM to VCR. Press the PLAY button (▶) on the VIEWCAM and the Record button on the VCR at the same time.
- 4 Press the Pause/Still button on the VCR to pause recording when the source tape reaches the beginning of the sequence to be cut.
- 5 Press the Pause/Still or Record button on the VCR to resume recording when the source tape reaches the end of the sequence to be cut.

To stop editing

Press the Stop buttons on the VIEWCAM and the VCR.

Notes:

- Some of the transitions between edited sequences may be slightly off.
- There may be picture noise during video search or still picture playback. This does not imply a defect in the VIEWCAM.

Setting Edit Mode

Picture quality inevitably decreases when dubbing from the VIEWCAM to a VCR. To minimize the quality reduction, set the VIEWCAM to Edit mode.

- 1 Set the Power switch to VCR, then press the MENU button until  appears.
- 2 Press the ▼ or ▲ button to select "EDIT", then press the SET button (▶▶) to select "ON".

Notes:

- The EDIT mode does not function when the VIEWCAM is recording.
- After you finish editing, set the EDIT menu item back to "OFF".

Useful Information

Hints for Better Shooting

- Position the subject in the centre of the screen. When you are using auto focus, whatever is in the centre of the screen is kept in focus.



Position the subject in the centre.



Focus manually when you need to position the subject off centre (see page 42).

- Avoid backlit subjects. For the best picture, shoot with the light source behind you. When the background is brighter than the subject, the subject often becomes too dark. If you have to record with this lighting, use the Gamma Brightness Compensation or correct the exposure level to improve the picture (see pages 28 and 44).

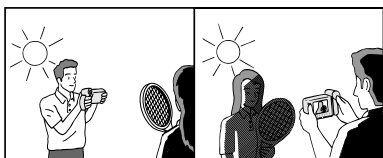

Light from behind Backlighting

- Before zooming, think about how to best frame the shot. Frequent zooming produces unattractive pictures. It also increases the battery power consumption.
- When image shakes are noticeable during zoomed-in telephoto shooting, use a tripod, or push the Power Zoom control to the W side to zoom out.
- Horizontal panning (lateral movement) and tilting (vertical movement) should be done slowly to emphasize the wide expanse of a scene or the height of a building, and to make scenes easy to watch during playback.
- Use a wide-angle setting for fast-moving subjects.

Note:

- It may take longer to focus when zooming and panning are used frequently.

Lighting

For clear, good-quality recording, 500 to 100,000 lux is needed. Recording is possible with less light, but the picture quality may suffer. Adequate lighting is also essential for correct white balance.

Brightness (Lux)	Situation (Lux)
100,000	Blue sky Clear day at noon (100,000)
10,000	Clear day at 10 am (65,000) Clear day at 3 pm (35,000) Cloudy day at noon (32,000) Cloudy day at 10 am (25,000)
1,000	Cloudy day, one hour after sunrise (2,000) Clear day, one hour before sunset (1,000) Fluorescent light near window (1,000)
100	Factory floor (700–800) Sales counter in department store (500–700) Bowling alley (500) Library (400–500) Office with fluorescent lighting (400–500)
	Fluorescent desk lamp (400) Flashlight at 1 m (250) Shop stairway (100)
10	During intermission at movie theatre (15–35) Cigarette lighter at 30 cm (15–20) Candles on birthday cake at 20 cm (10–15) Candlelight

Optimal lighting range

Note: The figures in the chart are approximations.

Tips on Good Lighting

In most outdoor, daytime scenes, natural lighting is adequate for home videos. Indoors, however, artificial lighting is usually required. Video lights with halogen lamps provide the most natural artificial light over a long operating life.

Dew Formation

• What is “dew formation”?

When cold water is poured into a glass, dew drops form on the glass. This clinging of water drops is called dew formation.

• When dew forms in your VIEWCAM.

Dew will gradually form on the head drum of your VIEWCAM and make the video tape stick to the head. This causes damage both to the head and the tape. When dew formation occurs, recording and playback may not function properly.

Dew is likely to form in the following circumstances:

- When moving the VIEWCAM from a cold place to a warm place.
- When placing the VIEWCAM in a cold room which is then heated rapidly.
- When moving the VIEWCAM outdoors from an air conditioned room.
- When placing the VIEWCAM in the direct path of air blowing from an air conditioner.
- When placing the VIEWCAM in a humid room.



• How to prevent trouble due to dew formation.

When using the VIEWCAM in a place where dew formation is likely to occur, allow the VIEWCAM and the video tape to acclimatise to the surroundings for about one hour. For example, when bringing the VIEWCAM indoors after skiing, place it in a plastic bag.

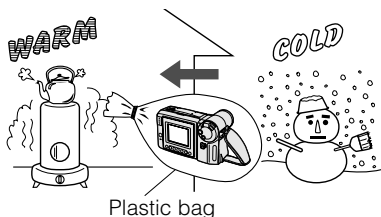

- ① Be sure to tightly seal the plastic bag containing the VIEWCAM.
- ② Remove the bag when the air temperature inside it reaches the temperature of the room.

• “DEW” warning feature

If dew forms, the word “DEW” flashes on the LCD monitor, and the power will automatically turn off in approximately 10 seconds.

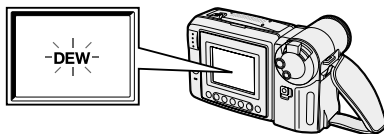

- ① If “DEW” flashes on the LCD monitor, remove the cassette, leave the cassette compartment open, and wait for a few hours to allow the VIEWCAM to acclimatise to the surrounding temperature.
- ② To use the VIEWCAM again, turn on the power after waiting for a few hours. Be sure that “DEW” has disappeared from the monitor.
- ③ Do not insert a cassette while “DEW” is flashing; this may result in damage to the tape.
- ④ Since dew forms gradually, it may take 10 to 15 minutes before the dew warning feature engages.

Dirty Video Heads

Using the VIEWCAM when the video tape is dirty may cause the heads to clog, producing noise on the recorded image or preventing the image from being recorded at all.

If the video heads become clogged, the  indicator appears on the screen. Contact your SHARP dealer for further advice or refer to page 53 “Before Requesting Service”.

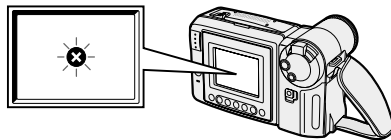

Note:

- Video head cleaning can be done by using a commercially-available cleaning tape. However, excessive use of the cleaning tape may also cause damage to the video heads. Please read the instructions accompanying the cleaning tape carefully, before using it.

Replacing the Fluorescent Lamp

This VIEWCAM uses a fluorescent lamp to backlight the LCD monitor. If the monitor becomes dark or difficult to view, the fluorescent lamp may need to be replaced. Contact the nearest SHARP service centre or your dealer for further advice.

Battery Pack

Battery pack consumption

- Recording with many starts and stops, frequent zooming, and recording in low temperatures will shorten actual recording times. Accordingly, be sure to turn off the power when not recording. Use of an auxiliary battery pack is recommended to prevent undesirable interruptions in your recording.
- Do not use an insufficiently charged or weak battery pack. Use of such battery packs may cause the power to automatically stop during VIEWCAM operation to protect both the battery pack and the unit.

Note:

- This VIEWCAM uses a Ni-MH (nickel-metal hydride) type battery pack. Use only the SHARP BT-H22 or BT-H32 battery packs. They are designed specifically for use with this VIEWCAM.

Battery pack life

The battery pack has a limited service life. If the period of use becomes noticeably shorter with a normal charge, the battery pack is at the end of its service life. Replace it with a new battery pack.

Extending battery pack life

- It is recommended that you use the battery pack until its charge is fully drained and the VIEWCAM is inoperable before recharging the pack.
- Recharge the battery pack right before recording. A battery pack stored for an extended time will naturally wear down, resulting in decreased recording time.
- Do not try to recharge a fully charged battery pack before it has been discharged, as this will cause deterioration of the battery's capacity.
- Store the battery pack in a dry, cool place.

How to use the battery pack cover

- When storing a fully charged battery pack, put the cover on it so that the "CHARGE" mark printed on the label is seen through the window, as shown.

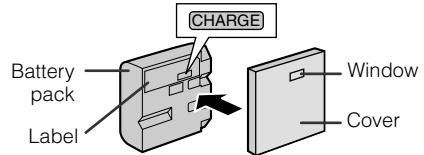

- When storing a battery pack that is not fully charged, put the cover upside down so that only the battery pack casing is seen through the window.

Caution:

- For safety reasons, put the cover on the battery pack when it is not being used. If the metal parts of the battery pack come in contact with other metal items, there is a danger that a short circuit may occur.

Battery power is consumed even when the VIEWCAM's power is turned off. If you are not going to use your VIEWCAM immediately, remove the battery pack (see page 8).

Temperature during charging

- The Ni-MH (nickel-metal hydride) type BT-H22 and BT-H32 battery packs can be charged at a temperature of 15°C to 30°C.

Video Cassette Tapes

Use only tapes with the **8** mark with this VIEWCAM.

To protect recordings against erasure

When a previously recorded cassette is used again for recording, the previously recorded material is erased. To protect a recording against accidental erasure, slide the tab on the cassette to cover the opening. (A red mark will be exposed.) To record, slide the tab to open the opening.

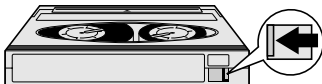

Notes:

- Do not insert anything into the erasure-protection opening in the cassette.
- Do not put anything into the holes on the bottom of the cassette.
- Do not store or place your video tapes in direct sunlight, near heaters, or in places with excessive moisture or dust.
- Do not keep video tapes near magnetic objects as they may erase the recording.
- Do not drop or subject the tapes to excessive shocks.
- Uneven tape winding will damage the tape. If the tape is not properly wound, reinsert it in the VIEWCAM and rewind the tape.
- Store the cassettes in their cases and stand them upright.

Using Your VIEWCAM Abroad

Television signal standards and electrical voltages and frequencies vary substantially from country to country. When you are abroad, check the sections below before using the AC adapter or connecting the VIEWCAM to a TV.

AC Adapter (Supplied Accessory)

The supplied AC adapter is compatible with 50 Hz and 60 Hz electrical systems in the range of 110 V to 240 V AC.

Television Signal Standards

In any country, you can always watch the video picture by using the LCD monitor screen. However, if you want to watch the picture on a TV screen, the TV must be PAL system compatible. PAL is used in the following countries:

Germany, Great Britain, Sweden, Denmark, Austria, Belgium, Switzerland, Italy, Spain, Holland, Finland, Portugal, Norway, Hong Kong, Thailand, Australia, New Zealand, Singapore, Kuwait, China, etc.

Demonstration Mode

You can watch a brief demonstration of the special VIEWCAM features in Demo mode. If the demonstration appears on the screen when you turn on the VIEWCAM for the first time, cancel the Demo mode to use your VIEWCAM.

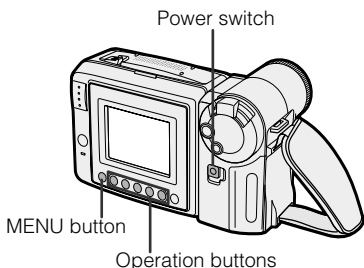

Watching the Demonstration

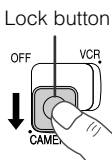
- 1 Make sure that there is no video cassette in the VIEWCAM.
 - If a cassette is in the VIEWCAM, Demo mode does not work. Perform the procedure on page 11 to remove it.
- 2 Hold down the Lock button and slide the Power switch to CAMERA.
 
- 3 Press the MENU button until **5/6** appears.
 - If MENU 2 appears on the **5/6** screen, press the PAGE button (II) to display MENU 1.
- 4 Press \blacktriangledown or \blacktriangle (\blacktriangleleft or \blacktriangleright) button (1) to select "DEMO MODE", then press the SET button ($\blacktriangleright\blacktriangleright$) (2) to select "ON".
 - The demonstration begins.

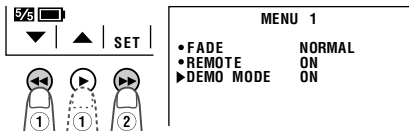

Cancelling Demo Mode

- 1 During the demonstration, perform step 3 above.
- 2 Press \blacktriangledown or \blacktriangle button (1) to select "DEMO MODE", then press the SET button ($\blacktriangleright\blacktriangleright$) (2) to select "OFF".

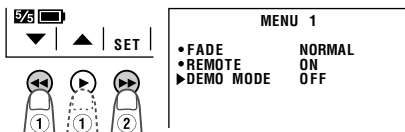

- 3 Press the DISPLAY button to turn off the menu screen.

Note:

- The demonstration will stop if you press the MENU button. If you leave it for 60 seconds, or turn the power off temporarily and then set the Power switch to CAMERA, the demonstration will begin again.

Before Requesting Service

The following conditions do not always denote trouble. Therefore, perform the checks described below before calling for service. If the problem cannot be corrected by the use of this guide, remove the mains plugs from the wall socket, and contact the dealer or supplier from whom the unit was purchased in order to obtain service. Where this is not possible, please visit our web-site www.sharp.co.uk/support. Customers without Internet access may telephone 08705 274277 during office hours (or (01)676 0648 if telephoning from Ireland).

Certain replacement parts and accessories may be obtained from our main parts distributor, who can be contacted on the following numbers:

WILLOW VALE ELECTRONICS LTD.: 0121 766 5414

In the unlikely event of this equipment requiring repair during the guarantee period, you will need to provide proof of the date of purchase to the repairing company. Please keep your invoice or receipt, which is supplied at the time of purchase.

	Symptom	Possible cause	Suggested solution
Power	No power.	Power source is not properly connected.	Connect power source properly (pp. 8, 10).
		Battery pack is not charged.	Charge battery pack sufficiently (p. 9).
		Dew in VIEWCAM.	Wait until dew dries (p. 49).
		Safety function is in effect.	Set Power switch to OFF and remove battery pack; wait for 2 seconds, then reinstall battery pack and turn on power (p. 8).
CAMERA mode	REC START/STOP button does not work.	Erasure-protect tab on video cassette is closed.	Open tab or use a new cassette (p. 51).
	Power suddenly turns off.	VIEWCAM left in Recording Standby mode for 5 minutes.	Set Power switch to OFF and then back to CAMERA.
	Auto focus does not work.	Manual Focus mode is engaged.	Set to Auto Focus mode (p. 42).
		Zoom used on close subject.	Zoom out from subject (p. 17).
		Subject has little contrast in brightness, or is full of horizontal or vertical stripes.	Focus manually (p. 42).
	Bright subject produces wide vertical lines.	Occurs when shooting subject with strong contrast to the background. Does not indicate a malfunction.	—
	Automatically zooms out without operating Zoom control.	VIEWCAM is unable to focus when zooming in on subject within 1.5 m, and automatically zooms out until it focuses on subject.	—
		No subject in the field of view.	Direct lens to some subject, or set zoom to widest angle before shooting (p. 17).
Display automatically changes in Camera mode.	VIEWCAM is in Demo mode.	Set DEMO MODE menu item to "OFF" (p. 52).	

	Symptom	Possible cause	Suggested solution
VCR mode	Tape stops during rewind or fast forward.	Counter is in memory mode.	Disengage the memory mode (p. 36).
	No image appears on connected TV screen.	Video input channel on TV or TV channel is not selected properly.	Select video input channel or TV channel properly (p. 20).
		Audio/video cable is not properly connected.	Connect audio/video cable properly (p. 20).
	Cannot play back, rewind or fast forward tape.	Position at beginning or end of tape.	Rewind or fast forward tape to desired point (p. 19).
	Video noise in image.	Dirty video heads.	Call for service (p. 53).
Old or worn tape.		Use a new cassette.	
General	Cassette will not eject.	Power source is not properly connected.	Connect power source properly (pp. 8, 10).
		Battery pack is not charged.	Charge battery pack sufficiently (p. 9).
		VIEWCAM is recording.	Stop tape and try again (p. 16).
	No image on monitor.	Backlight has been turned off.	Turn on backlight (p. 46).
		Fluorescent lamp is burned out.	Call for service (p. 53).
	Monitor picture is hard to see.	Inappropriate picture adjustments.	Adjust picture (p. 45).
	CHARGE indicator flashes in red when charging battery pack.	AC adapter or battery pack may have malfunctioned.	Call for service (p. 53).
	Cannot edit to connected VCR.	Audio/video cable is not properly connected.	Connect audio/video cable properly (p. 47).
	Lens makes rattling sound when VIEWCAM is moved in VCR mode or with power off.	Does not indicate a malfunction.	—
	Remote control does not function.	REMOTE menu item is set to "OFF".	Set REMOTE menu item to "ON" (p. 37).
		Remote control batteries have run down.	Replace remote control batteries with new ones (p. 37).
Remote control used beyond operating range.		Use remote control within operating range (p. 37).	
Intense daylight falling on VIEWCAM remote sensor.		Protect remote sensor from exposure to intense daylight (p. 37).	
Obstacle between remote control and VIEWCAM remote sensor.		Remove obstacle or use remote control from different angle (p. 37).	

Notes:

- This unit is equipped with a microprocessor. Its performance could be adversely affected by external electrical noise or interference. If this should happen, turn off the power and disconnect the unit from any power sources, including the lithium battery, etc. Then reconnect the power sources to resume operation.
- If the characters displayed on the monitor screen appear to malfunction, disconnect the power source and remove the lithium battery, then reconnect the power source, insert the lithium battery, and turn the power on again. The characters on the monitor should be normal. Set the date and time, then resume operation.

Specifications

VIEWCAM

- Signal System: PAL standard
- Recording System: 2 rotary heads, helical scanning system
- Cassette: 8 mm video tape, MP type
- Recording/Playback Time: 120 minutes (P5-120)
- Tape Speed: 20.051 mm/second
- Pickup Device: 1/4" (6.4 mm, effective size: 4.5 mm) CCD image sensor (with approx. 320,000 pixels including optical black)
- Lens: 16× power zoom lens (F1.4, f=4.0–64.0 mm), and full-range auto focus
- Lens Filter Diameter: 46 mm
- Monitor: 3" (7.5 cm) full-colour LCD screen (TFT active matrix)
- Microphone: Electret monaural microphone
- Colour Temperature Compensation: Auto white balance with white balance lock
- Minimum Illumination: 0.8 lux* (with gain-up, F1.4)
- Video Output Level: 1.0 Vp-p 75-ohm unbalanced
- Audio Output Level: –8 dBs, impedance less than 2.2 kohms
- Speaker Output: 200 mW
- Power Requirement: DC 3.6 V (with battery pack)
DC 7.0 V (with AC adapter)
- Power Consumption: 4.9 W (during camera recording in full auto mode with zoom motor off and backlight in normal mode)
- Operating Temperature: 0°C to +40°C
- Operating Humidity: 30% to 80%
- Storage Temperature: –20°C to +60°C
- Dimensions (approx.): 183 mm (W) × 109 mm (H) × 99 mm (D)
- Weight (approx.): 710 g (without battery pack, lithium battery, video cassette, and lens cap)

AC Adapter (UADP-0313TAZZ)

- Power Requirement: AC 110–240 V, 50/60 Hz
- DC Output: 7.0 V
- Power Consumption: 15 W
- Dimensions (approx.): 68 mm (W) × 37 mm (H) × 130 mm (D)
- Weight (approx.): 233 g

Specifications are subject to change without notice.

*Minimum illumination: Since there is no widely accepted testing procedure for determining minimum illumination capability, lux ratings are comparable only between models from the same manufacturer.

SHARP CORPORATION

SHARP ELECTRONICS (U.K.) LTD.

Sharp House, Thorp Road, Newton Heath
Manchester M40 5BE

Printed in Malaysia
TINSE0377TAZZ(A)
T2437-A
0P06-M-G

Free Manuals Download Website

<http://myh66.com>

<http://usermanuals.us>

<http://www.somanuals.com>

<http://www.4manuals.cc>

<http://www.manual-lib.com>

<http://www.404manual.com>

<http://www.luxmanual.com>

<http://aubethermostatmanual.com>

Golf course search by state

<http://golfingnear.com>

Email search by domain

<http://emailbydomain.com>

Auto manuals search

<http://auto.somanuals.com>

TV manuals search

<http://tv.somanuals.com>