

EZ1010
EZ1010BL
EZ1010RD

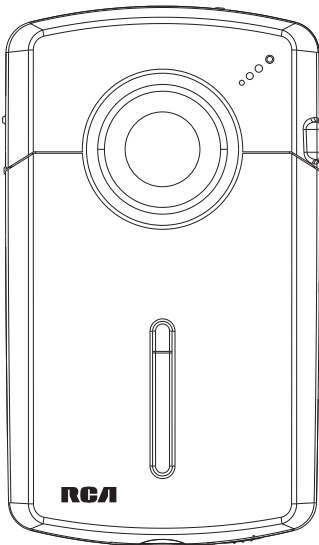



It is important to read this user manual prior to using your new product for the first time.

Important safety instructions

IMPORTANT SAFETY INSTRUCTIONS

PLEASE READ AND SAVE FOR FUTURE REFERENCE

| | | |
|--|---|---|
|  <p>THE LIGHTNING FLASH AND ARROWHEAD WITHIN THE TRIANGLE IS A WARNING SIGN ALERTING YOU OF "DANGEROUS VOLTAGE" INSIDE THE PRODUCT.</p> | CAUTION RISK OF ELECTRIC SHOCK DO NOT OPEN CAUTION: TO REDUCE THE RISK OF ELECTRIC SHOCK, DO NOT REMOVE COVER (OR BACK). NO USER-SERVICEABLE PARTS INSIDE. REFER SERVICING TO QUALIFIED SERVICE PERSONNEL. |  <p>THE EXCLAMATION POINT WITHIN THE TRIANGLE IS A WARNING SIGN ALERTING YOU OF IMPORTANT INSTRUCTIONS ACCOMPANYING THE PRODUCT.</p> |
| SEE MARKING ON BOTTOM / BACK OF PRODUCT | | |

WARNING: TO PREVENT FIRE OR ELECTRICAL SHOCK HAZARD, DO NOT EXPOSE THIS PRODUCT TO RAIN OR MOISTURE.

Some of the following information may not apply to your particular product; however, as with any electronic product, precautions should be observed during handling and use.

- Read these instructions.
- Keep these instructions.
- Heed all warnings.
- Follow all instructions.
- Do not use this apparatus near water.
- Clean only with dry cloth.
- Do not install near any heat sources such as radiators, heat registers, stoves, or other apparatus (including amplifiers) that produce heat.
- Only use attachments/accessories specified by the manufacturer.
- Refer all servicing to qualified service personnel. Servicing is required when the apparatus has been damaged in any way, such as power-supply cord or plug is damaged, liquid has been spilled or objects have fallen into the apparatus, the apparatus has been exposed to rain or moisture, does not operate normally, or has been dropped.

ADDITIONAL SAFETY INFORMATION

- Do not use unauthorized chargers or power adapters. Use only chargers that came with your product or that is listed in the user's guide.
- Apparatus shall not be exposed to dripping or splashing and no objects filled with liquids, such as vases, shall be placed on the apparatus.
- Do not attempt to disassemble the cabinet. This product does not contain customer serviceable components.
- The marking information is located at the bottom of apparatus.
- Connect power cord only to AC power source as marked on the product.
- Care should be taken so that objects do not fall into the product.
- Do not attempt to disassemble the cabinet. This product does not contain customer serviceable components.

Important battery precautions

- Any battery may present a risk of fire, explosion, or chemical burn if abused. Do not try to charge a battery that is not intended to be recharged, do not incinerate, and do not puncture.
- Non-rechargeable batteries, such as alkaline batteries, may leak if left in your product for a long period of time. Remove the batteries from the product if you are not going to use it for a month or more.
- If your product uses more than one battery, do not mix types and make sure they are inserted correctly. Mixing types or inserting incorrectly may cause them to leak.
- Discard any leaky or deformed battery immediately. They may cause skin burns or other personal injury.
- Please help to protect the environment by recycling or disposing of batteries according to federal, state, and local regulations.

WARNING: The battery (battery or batteries or battery pack) shall not be exposed to excessive heat such as sunshine, fire or the like.

Ecology

Help protect the environment - we recommend that you dispose of used batteries by putting them into specially designed receptacles.

Precautions for the unit

- Do not use the unit immediately after transportation from a cold place to a warm place; condensation problems may result.
- Do not store the unit near fire, places with high temperature or in direct sunlight. Exposure to direct sunlight or extreme heat (such as inside a parked car) may cause damage or malfunction.
- Do not expose to rain or moisture.
- Clean the unit with a soft cloth or a damp chamois leather. Never use solvents.
- The unit must only be opened by qualified personnel.

FCC Information

This device complies with Part 15 of the FCC Rules. Operation is subject to the following two conditions: (1) this device may not cause harmful interference, and (2) this device must accept any interference received, including interference that may cause undesired operation.

Note: This equipment has been tested and found to comply with the limits for a Class B digital device, pursuant to Part 15 of FCC Rules. These limits are designed to provide reasonable protection against harmful interference in a residential installation. This equipment generates, uses, and can radiate radio frequency energy and, if not installed and used in accordance with the instructions, may cause harmful interference to radio communications.

However, there is no guarantee that interference will not occur in a particular installation. If this equipment does cause harmful interference to radio or television reception, which can be determined by turning the equipment off and on, the user is encouraged to try to correct the interference by one or more of the following measures:

- Reorient or relocate the receiving antenna.
- Increase the separation between the equipment and receiver.
- Connect the equipment into an outlet on a circuit different from that to which the receiver is connected.
- Consult the dealer or an experienced radio/TV technician for help.

Changes or modifications not expressly approved by Audiovox could void the user's authority to operate the equipment.

Manufacturer/Responsible Party
Audiovox Accessories Corporation
111 Congressional Blvd., Suite 350
Carmel, IN 46032

1-317-810-4880 (No technical /product support is available via this number. This phone number is for regulatory matters only.)

Visit www.mysmallwonder.com for technical support



RCA
EZ1010



RCA
EZ1010RD



RCA
EZ1010BL

This Class B digital apparatus complies with Canadian ICES-003.
Cet appareil numérique de la classe B est conforme à la norme NMB-003 du Canada.

Contents

Important safety instructions

| | |
|-------------------------------------|---|
| IMPORTANT SAFETY INSTRUCTIONS | 1 |
| Important battery precautions | 2 |
| Ecology..... | 2 |
| Precautions for the unit | 2 |

FCC Information.....3

Contents4

End user license agreement

| | |
|---------------------------------|---|
| End user license agreement..... | 6 |
|---------------------------------|---|

Getting started

| | |
|---------------------------------------|----|
| 1. Content of the box..... | 8 |
| 2. Battery Installation | 8 |
| 3. Inserting microSD memory card..... | 9 |
| 4. Turning on the camcorder | 9 |
| 5. Resetting the camcorder | 10 |
| 6. Setting date and time | 10 |
| 7. Using the tripod (Optional)..... | 10 |

General controls

| | |
|------------------------|----|
| General controls | 11 |
| Operation modes | 12 |

Recording videos

| | |
|------------------------|----|
| Recording quality..... | 13 |
| Quality settings..... | 13 |
| Recording videos..... | 14 |

Taking photos

| | |
|---------------------|----|
| To take photos..... | 15 |
|---------------------|----|

Playback mode

| | |
|------------------------------|----|
| Playing back recordings..... | 16 |
|------------------------------|----|

Deleting

| | |
|--------------------------|----|
| Deleting recordings..... | 18 |
|--------------------------|----|

Menu settings

| | |
|---------------------------------|----|
| Using the camcorder menu..... | 19 |
| Menu options and settings | 19 |

Connecting to external devices

Viewing videos on TV 20
Recording videos to VHS tape or DVD 20

Managing videos on your computer

Computer system requirements..... 21
About RCA Memory Manager 22
Viewing videos on PC..... 22

Additional information

Tips and troubleshooting..... 23
Product registration 24
For your records 24
Service Information 24
Copyright warning..... 24
Back up your data 24
Visiting RCA website 24
Technical specifications 25

Warranty information

Limited warranty 26

End user license agreement

This is a copy of the EULA that you need to agree to in order to use this product.



End user license agreement

THIS END USER LICENSE AGREEMENT (THIS "EULA") IS A LEGAL AGREEMENT BETWEEN YOU AND AUDIOVOX CORPORATION AND, AS APPLICABLE, ANY AUDIOVOX SUBSIDIARY, AS DEFINED BELOW (COLLECTIVELY "AUDIOVOX"), FOR THE RCA BRANDED PORTABLE DIGITAL AUDIO/VIDEO DEVICE APPLICATION/DRIVER SOFTWARE PROGRAM WHICH MAY INCLUDE ASSOCIATED SOFTWARE COMPONENTS, SOFTWARE LICENSED BY AUDIOVOX FROM THIRD PARTIES ("LICENSORS") AND ASSOCIATED DOCUMENTATION, IF ANY (COLLECTIVELY, THE "PROGRAM"). THIS EULA CONTAINS IMPORTANT LEGAL LIMITATIONS, RESTRICTIONS AND DISCLAIMERS, AND ALSO SPECIFIES THE DURATION OF YOUR LICENSE.

BY INSTALLING THE PROGRAM OR CLICKING ON THE ACCEPTANCE BUTTON OF THE PROGRAM, COPYING OR OTHERWISE USING THE PROGRAM, YOU ACKNOWLEDGE AND AGREE THAT YOU HAVE READ THIS EULA, UNDERSTAND IT, AND AGREE TO BE BOUND BY ITS TERMS AND CONDITIONS. THIS PROGRAM IS PROTECTED BY COPYRIGHT LAWS AND INTERNATIONAL COPYRIGHT TREATIES, AS WELL AS OTHER INTELLECTUAL PROPERTY LAWS AND TREATIES. YOU MAY USE THE PROGRAM ONLY IN ACCORDANCE WITH THIS EULA, AND ANY SUCH USE IS HEREBY UNDERSTOOD TO BE CONDITIONAL UPON YOUR SPECIFIC AGREEMENT TO THE UNMODIFIED TERMS SET FORTH HEREIN. IF YOU DO NOT AGREE WITH ALL OF THE TERMS OF THIS EULA, CLICK ON THE REJECTION BUTTON AND/OR DO NOT INSTALL THE PROGRAM AND/OR DO NOT USE THE PROGRAM.

1. LICENSE

- (a) Under this EULA, you are granted a non-exclusive, non-sublicenseable, non-assignable and non-transferable (except as expressly set forth below) license (i) to use and install the Program on a single workstation, and (ii) to make one (1) copy of the Program into any machine-readable form for backup of the Program, provided the copy contains all of the original Program's proprietary notices.
- (b) You may transfer the Program and license to another party only as a part of the RCA branded Portable Digital Audio/Video Device ("A/V Device"), and only if the other party agrees to accept the terms and conditions of this EULA. If you transfer the Program, you must at the same time either transfer all copies to the same party or destroy any copies not transferred.
- (c) The terms of this EULA will govern any software upgrades or updates provided by AUDIOVOX that replace and/or supplement the original Program, unless such upgrade or update is accompanied by separate license terms and conditions in which case the terms of that separate license will govern. You acknowledge and agree that AUDIOVOX may automatically download upgrades or updates to the Program software to your computer in order to update, enhance, and/or further develop the Program.

2. LICENSE RESTRICTIONS

- (a) Except for the licenses expressly granted to you in this EULA, no other licenses or rights are granted or implied.
- (b) You may not (i) make the Program available over a network where it could be used by multiple computers at the same time; (ii) modify, translate, reverse engineer, decompile, disassemble (except to the extent that this restriction is expressly prohibited by law), or create derivative works based upon the Program; (iii) copy the Program, except as expressly permitted herein; (iv) remove or alter any copyright notices on all copies of the Program; or (v) rent, lease or lend the Program. You agree that you shall only use the Program in a manner that complies with all applicable laws in the jurisdictions in which you use the Program, including, but not limited to, applicable restrictions concerning copyright and other intellectual property rights.
- (c) The Program may contain pre-release code that does not perform at the level of a final code release. In such case, the Program may not operate properly. Updated versions of the Program may be downloaded from www.rcaaudiovideo.com/downloads
- (d) AUDIOVOX is not obligated to provide support services for the Program.
- (e) The Program is provided with "RESTRICTED RIGHTS". Use, duplication, or disclosure by the U.S. Government is subject to restrictions as set forth in subparagraph (c)(1)(ii) of DFARS 252.227-7013, or FAR 52.227-19, or in FAR 52.227-14 Alt. III, as applicable.

3. TERM AND TERMINATION

- (a) Your license is effective on the date you accept this EULA and remains in effect until this EULA is terminated by either party.
- (b) You may terminate this EULA and the associated license, without any notice or delay, by destroying or permanently erasing the Program and all copies thereof.

- (c) If you fail to comply with any of the terms of this EULA, in whole or part, your license will automatically terminate without notice from AUDIOVOX.
- (d) Upon termination of this EULA and your associated license, you shall cease all use of the Program and destroy or permanently erase the Program and all full or partial copies thereof.

4. WARRANTY DISCLAIMER

THE PROGRAM IS PROVIDED "AS IS" WITHOUT WARRANTY OF ANY KIND, EITHER EXPRESSED OR IMPLIED, INCLUDING, BUT NOT LIMITED TO THE IMPLIED WARRANTIES OF MERCHANTABILITY, FITNESS FOR A PARTICULAR PURPOSE, TITLE OR NON-INFRINGEMENT. THE ENTIRE RISK AS TO THE QUALITY AND PERFORMANCE OF THE PROGRAM IS WITH YOU. SHOULD THE PROGRAM PROVE DEFECTIVE, YOU (AND NOT AUDIOVOX, ITS SUPPLIERS, OR ITS DEALERS) ASSUME THE ENTIRE COST FOR ALL NECESSARY REPAIR OR CORRECTION.

This exclusion of warranty may not be allowed under some applicable laws. As a result, the above exclusion may not apply to you, and you may have other rights depending on the law that applies to you.

5. OWNERSHIP RIGHTS

All title and intellectual property rights, including but not limited to copyrights, in and to the Program and any copies thereof are owned by AUDIOVOX, its Licensors or its suppliers. All title and intellectual property rights in and to the content which may be accessed through use of the Program is the property of the respective content owner and may be protected by applicable copyright or other intellectual property laws and treaties. This license grants you no rights to use such content. All rights not expressly granted are reserved by AUDIOVOX or its Licensors.

6. LIMITATION OF LIABILITY

(a) TO THE MAXIMUM EXTENT PERMITTED BY APPLICABLE LAW, IN NO EVENT SHALL AUDIOVOX, OR ITS DEALERS BE LIABLE FOR ANY SPECIAL, INCIDENTAL, INDIRECT, OR CONSEQUENTIAL DAMAGES WHATSOEVER (INCLUDING, WITHOUT LIMITATION, DAMAGES FOR LOSS OF PROFITS, BUSINESS INTERRUPTION, CORRUPTION OF FILES, LOSS OF BUSINESS INFORMATION, OR ANY OTHER PECUNIARY LOSS) REGARDLESS OF CAUSE OR FORM OF ACTION, INCLUDING CONTRACT, TORT, OR NEGLIGENCE, ARISING OUT OF YOUR USE OF OR INABILITY TO USE THE PROGRAM, EVEN IF AUDIOVOX HAS BEEN ADVISED OF THE POSSIBILITY OF SUCH DAMAGES. BECAUSE SOME STATES AND JURISDICTIONS DO NOT ALLOW THE EXCLUSION OR LIMITATION OF LIABILITY OF CONSEQUENTIAL OR INCIDENTAL DAMAGES, THE ABOVE LIMITATION MAY NOT APPLY TO YOU.

(b) YOU ASSUME RESPONSIBILITY FOR THE SELECTION OF THE APPROPRIATE PROGRAM TO ACHIEVE YOUR INTENDED RESULTS, AND FOR THE INSTALLATION, USE, AND RESULTS OBTAINED.

7. THIRD PARTY SOFTWARE

ANY THIRD PARTY SOFTWARE THAT MAY BE PROVIDED WITH THE PROGRAM IS INCLUDED FOR USE AT YOUR OPTION. IF YOU CHOOSE TO USE SUCH THIRD PARTY SOFTWARE, THEN SUCH USE SHALL BE GOVERNED BY SUCH THIRD PARTY'S LICENSE AGREEMENT, AN ELECTRONIC COPY OF WHICH WILL BE INSTALLED IN THE APPROPRIATE FOLDER ON YOUR COMPUTER UPON INSTALLATION OF THE SOFTWARE. AUDIOVOX IS NOT RESPONSIBLE FOR ANY THIRD PARTY'S SOFTWARE AND SHALL HAVE NO LIABILITY FOR YOUR USE OF THIRD PARTY SOFTWARE.

8. GOVERNING LAW

If you acquired this A/V Device in the United States, this EULA shall be governed and construed in accordance with the laws of the State of Indiana, U.S.A. without regard to its conflict of laws principles. If you acquired this A/V Device outside the United States or the European Union, then local law may apply.

9. GENERAL TERMS

This EULA can only be modified by a written agreement signed by you and AUDIOVOX, and changes from the terms and conditions of this EULA made in any other manner will be of no effect. If any portion of this EULA shall be held invalid, illegal, or unenforceable, the validity, legality, and enforceability of the remainder of the Agreement shall not in any way be affected or impaired thereby. This EULA is the complete and exclusive statement of the agreement between you and AUDIOVOX, which supersedes all proposals or prior agreements, oral or written, and all other communications between you and AUDIOVOX, relating to the subject matter of this hereof. AUDIOVOX'S Licensors shall be considered third party beneficiaries of this Agreement and shall have the right to enforce the terms herein.

"AUDIOVOX SUBSIDIARY" shall mean any person, corporation, or other organization, domestic or foreign, including but not limited to subsidiaries, that is directly or indirectly controlled by Audiovox Corporation including, but not limited to, Audiovox Consumer Electronics, Inc. and Audiovox Electronics Corporation. For purposes of this definition only, the term "control" means the possession of the power to direct or cause the direction of the management and policies of an entity, whether by ownership of voting stock or partnership interest, by contract, or otherwise, including direct or indirect ownership of at least fifty percent (50%) of the voting interest in the entity in question.

Getting started

Dear RCA customer,

Thank you for purchasing the RCA Small Wonder Camcorder. This product will let you record videos with high definition quality. You can also manage your recordings on your computer with the RCA Memory Manager included with this product.

To start using your camcorder, please follow the setup instructions in the following pages.

1. Content of the box

- Small Wonder Camcorder
- 4 x AAA batteries
- USB cable
- AV cable
- Tripod
- Carrying case
- Wrist strap
- Quick Start Guide
- Owner Registration card
- Warranty leaflet

2. Battery Installation

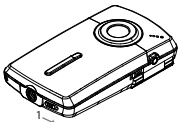

Push (to the right) to unlock.

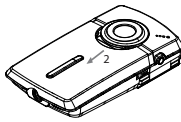

Observe the polarities.



Slide up to lock.

- Once the batteries is replaced, the maximum recording times are approximately as follows*:
 - 120 minutes of HQ video
 - 140 minutes of WebQ video
 - 1100 photos

* For reference only – actual battery life may vary with different cards and video contents.

3. Inserting microSD memory card

- A microSD memory card (not included) is recommended for recording as the camcorder internal memory will only permit minutes of recording time.

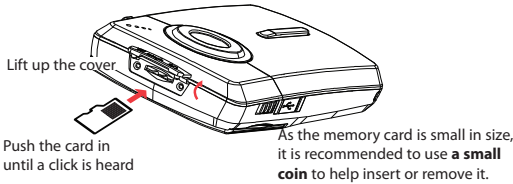

- The card icon () appears on the screen with memory card inserted.
- To remove card, push card in until a click is heard, then slowly release the card. As card is under minimal tension when locked in memory slot, please use care when removing.
- The camcorder has internal memory which only permits minutes of recording time. A microSD memory card is recommended for recording.
- Recordings are saved in the internal memory when microSD memory card is not installed.
- Once microSD memory card is inserted, new recordings will be saved on the memory card.
- In playback mode, the camcorder will playback recordings stored in the microSD memory card. To playback recordings in the internal memory, remove the microSD card.



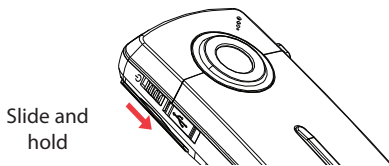

4. Turning on the camcorder

- Slide and hold the power switch  until the camcorder turns on.

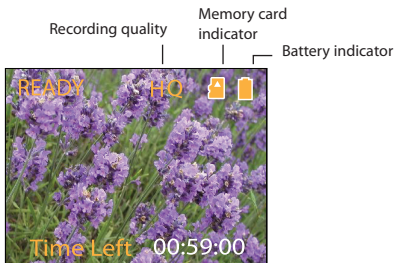

- "Ready" shows on the LCD screen when the camcorder is ready for recording.



- Slide and hold the power switch  to turn off the camcorder.
- The camcorder will automatically turn off after 3 minutes if not in use.
- Refer to the following pages for more information on recording and other operations.

5. Resetting the camcorder

- To reset the camcorder (if it is not functioning properly), remove the batteries and re-install.

6. Setting date and time

- It is recommended to set the date and time before using the camcorder. Refer to "Menu settings" on page 19 for more information.

7. Using the tripod (Optional)

A tripod is included to help reducing blur for steady, smooth videos and clear photos.

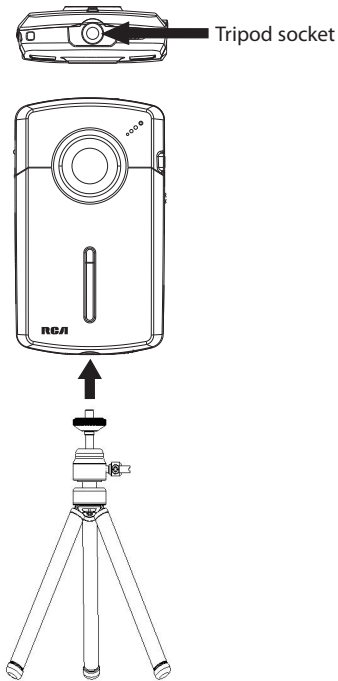

1. Insert the attachment screw of the tripod into the tripod socket at the bottom of the camcorder.
2. Tighten the attachment screw to secure the camcorder.
3. Loosen the attachment screw to remove the camcorder from the tripod.

DO NOT disassemble the tripod.



General controls

General controls



microSD card slot (Lift up the cover to show the card slot)

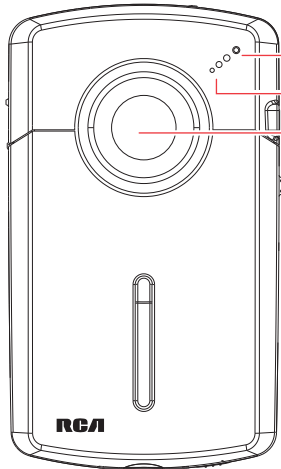

Recording indicator

Microphone

Lens

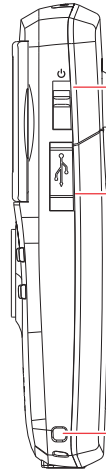

On/off switch

USB (Lift up the cover to access the connector)

Camcorder strap hole

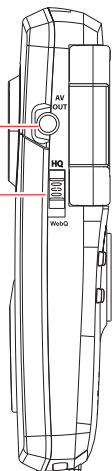

AV output

Video quality selector

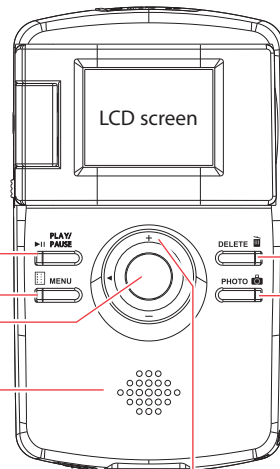

LCD screen

Play/pause

Setup menu

Record

Audio speaker

Delete recordings

Take photo

+/- – Adjust volume during playback/zoom during record and preview

◀/▶ – Skip to previous or next recording; fast rewind or forward

Operation modes

There are two basic modes for operating the camcorder: Preview and Playback. The camcorder will always enter into Preview mode after switched on. Refer to the diagram below for switching between modes and read relevant sections in the user manual for detailed operations.

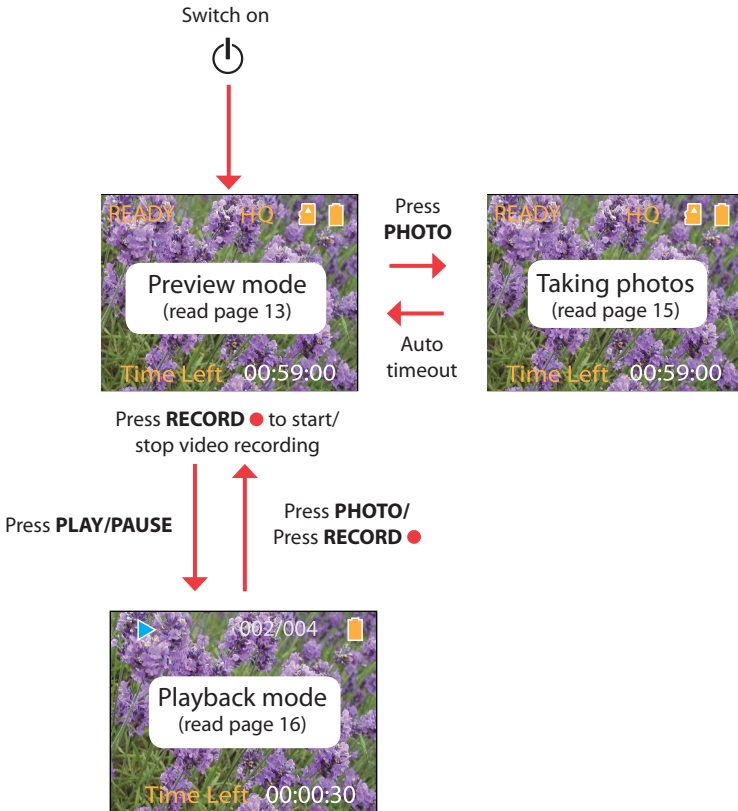

Recording videos

Recording quality

- Slide the Video Quality selector to select the recording quality. The selected setting (HQ or webQ) appears on the display screen during recording.

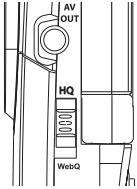

Quality settings

| Settings | Recommended for: | Resolutions (pixel) and Frame Rate (FPS) | Approx. recording durations on a 16GB memory card* |
|-------------------------|--|--|--|
| HQ (High Quality mode) | Viewing on TV & Capturing fast movements | 640 x 480 @ 30fps | 8 hours |
| WebQ (Web Quality mode) | Uploading to and viewing on the web | 448 x 336 @ 30fps | 16 hours |

* Actual recording time and capacity will vary depending on type of video content being recorded, system requirements, and other factors.



QuickTime and the QuickTime logo are trademarks or registered trademarks of Apple Computer, Inc., used under license therefrom.

Recording videos

1. In Preview mode, press the red **RECORD** ● button to begin recording.

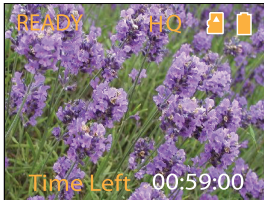

Video recording indicator

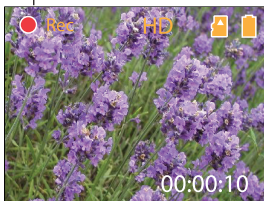

- While recording, the red recording light on the camcorder front turns on.
2. Press **PLAY/PAUSE** to pause a recording.
 - A pause indicator **||** replaces the red ● at the top left corner of the screen.
 - To resume recording, press **PLAY/PAUSE**.
 3. Press + or – to zoom in or out before or during recording.
 4. Press the red **RECORD** ● button to stop recording.

Taking photos

To take photos

1. In Preview mode, press **PHOTO** to take photos.

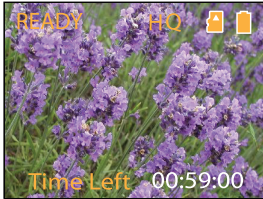

- The resolution of the photos is 1.2 mega pixel which is interpolated from 0.3 mega pixel sensor.
2. After taking photos, wait for few seconds timeout to return to Preview mode.

Playback mode

Playing back recordings

1. Press **PLAY/PAUSE** to enter Playback mode and start playback of the most recent recording (video/photo).

Playback indicator Current file number/Total number of files



Elapsed playback time

2. Press + or – during playback to adjust volume (video only).
3. Hold down ◀ or ▶ to fast rewind or forward the selected video during playback.

Fast forward indicator

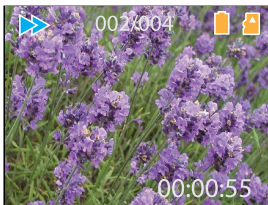

Elapsed playback time

4. Press **PLAY/PAUSE** to pause playback.
- Press **PLAY/PAUSE** again to resume playback.

Pause indicator

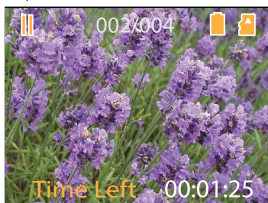

Remaining playback time

Press and hold **PLAY/PAUSE** for three seconds to play all recordings.



5. To select another video, press ◀ or ▶ to cue the previous or next video.

Type of file
(Video/Photo) Current file number/Total number of files

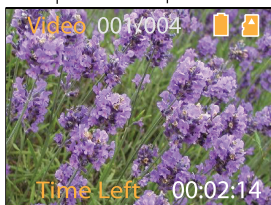

Duration of
current file

6. If no video is selected after playback has finished, Preview mode will resume after 2 minutes.
- You may also press **PHOTO** to go to Preview mode after playback, or press the red **RECORD** ● button to return to Preview mode

Deleting

Deleting recordings

To delete the last recording:

1. Press **DELETE** and press + or - to select **One**.

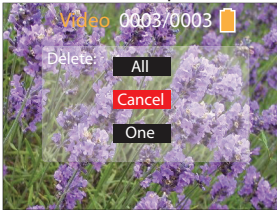

2. Press the red **RECORD** ● button to confirm delete.

To delete all recordings:

1. Press **DELETE** and press + or - to select **All**.

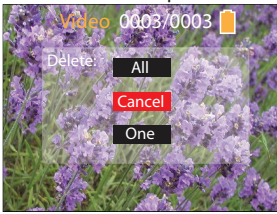

2. Press the red **RECORD** ● button.
3. Press + or - to select **Confirm** and press the red **RECORD** ● button to confirm delete all recordings.

Menu settings

Using the camcorder menu

1. Press **MENU** to show the camcorder menu on the screen.
2. Press + or – to highlight a menu option.

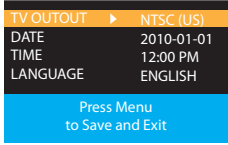

3. Press ► to enter the highlighted menu option.
4. Press + or – to change the setting.

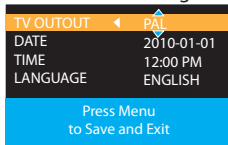

5. Press ◀ to exit the current menu option.
6. Press **MENU** to save settings and exit the camcorder menu.

Menu options and settings

| Menu options | Available settings |
|--------------|-----------------------------------|
| TV Output | NTSC (US), PAL |
| Date | YYYY - MM - DD |
| Time | HR : MM |
| Language | English, Spanish, French |
| Key tone | On, Off |
| Flicker | 50 Hz, 60 Hz (US) |
| System Info | Show the current firmware version |

Connecting to external devices

Viewing videos on TV

1. Plug in the AV cable (provided) – Insert the single connector end into the camcorder (AV jack) and connect the double connector ends to the corresponding video (yellow) and audio (white) input jacks on the TV.

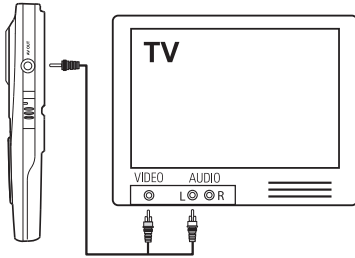

2. Turn on the TV and the camcorder.
3. Switch the TV to the selected video input.
 - Refer to your TV manual for instructions.
4. You may play and delete videos viewed on the TV by using the camcorder buttons.

The default TV output standard is NTSC. You can switch it to PAL standard by going to the camcorder menu. Refer to "Menu settings" for more information.



Recording videos to VHS tape or DVD

1. Plug in the AV cable (provided) – Insert the single connector end into the camcorder and connect the double connector ends to corresponding video (yellow) and audio (white) inputs of the recording device (VHS or DVD recorder).
2. Turn on the camcorder and the recording device.
3. Switch recording device to the video input connected to the camcorder.
 - Refer to your user manual of the recording device for instructions.
4. Start recording of your recording device and press and hold **PLAY/PAUSE** on the camcorder for 3 seconds to play all videos on the camcorder.

Managing videos on your computer

Computer system requirements

Windows: Windows® XP (SP2 or higher) or Windows Vista™ or Windows® 7

- Pentium 4 1.6 GHz or equivalent AMD Athlon processor
- 512 MB RAM (1 GB recommended)
- 300 MB available hard disk space
- 1024 x 768 pixels, 16-bit color monitor or higher
- Internet Access (broadband recommended)

Macintosh: OS X 10.5,10.6

- Intel Core Duo processor (or higher)
- 768 MB RAM (1GB recommended)
- 300 MB free hard drive space for program installation
- 1024 x 768 pixels or higher recommended
- Internet Access (broadband recommended)

Connecting to a PC

1. Connect the supplied USB cable to the connection jack. USB connector standard: mini-B
2. Connect the other end of the cable to the computer.

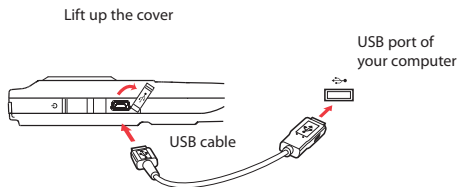

3. **Windows:** The first time you connect the camcorder to the PC, the Small Wonder will mount as a drive letter. To access the Memory Manager 3 installer, open My Computer and double-click the drive letter associated with the SMALLWONDER label. Double-click **MemoryMgr3_Windows_Installer.exe** to start the installation.
- The RCA Detective application is installed with Memory Manager 3 and will automatically run the Memory Manager 3 application when your camcorder is connected to the PC.

Mac: The first time you connect the camcorder to the Mac, the Small Wonder will mount as a volume labeled **SMALLWONDER** on the desktop. To access the Memory Manager 3 installer, double-click the **SMALLWONDER** volume. Double-click the **RCAMacInstallers.dmg** disk image in the **SMALLWONDER** volume. Locate the **RCAMacInstallers** volume on the desktop and Double-click on it. Double-click the **MemoryMgr3 Mac Installer** file in the **RCAMacInstallers** volume to start the installation. After the Memory Manager 3 installation has completed, double-click the **RCA Detective Installer** file in the **RCAMacInstallers** volume to install the RCA Detective application, which will automatically run the Memory Manager 3 application when your camcorder is connected to the Mac.

- Camcorder cannot record while connected to the PC.
- Memory Manager is proprietary software licensed by Audiovox Corporation.



About RCA Memory Manager

The included RCA Memory Manager application lets you:

- Browse and play videos
- Delete videos
- Save videos to your computer
- Edit videos by simply drag-and-drop

For more detailed instructions on using RCA Memory Manager, please refer to the help section in the software.



Viewing videos on PC

To ensure that videos can be managed and played on your PC:

- Make sure to install the included Memory Manager application.

* The application is also available for free download at www.mysmallwonder.com

Windows is a registered trademark of Microsoft Corporation in the United States and other countries.

Additional information

Tips and troubleshooting

Cannot turn on the camcorder.

- Make sure the battery is not empty. Refer to the user manual to replace new batteries before use.

MicroSD card cannot be detected by camcorder.

- Make sure the microSD card is inserted properly. Remove and insert the card from the card slot again when the camcorder is powered off.

Camcorder not turned on after connected to PC.

- The camcorder battery may be very low. Slide the power button to turn on the camcorder after connected to PC.

Cannot record videos.

- Make sure the memory space is not full for recording.

Available time for recording has significantly reduced.

- Make sure you have properly selected the video recording quality before recording.

The recording time and date are incorrect.

- Make sure you have properly set the date and time in the setting menu. Refer to "Menu settings" for more information.

The keytone is annoying. Can it be switched off?

- Yes. Refer to "Menu settings" for more information.

No sound when playing back recordings.

- Adjust the volume by pressing + or – during playback.

Pictures are distorted when videos are played back via connected TV set.

- Make sure you have correctly selected the TV output system (PAL or NTSC) from the setting menu. Refer to "Menu settings" for more information.

Can I retrieve deleted videos and photos?

- Unfortunately, deleted videos cannot be retrieved.

The camcorder is not functioning properly.

- Remove and re-install batteries, and then turn on again. If problem still exist, replace with new batteries.

Cannot view recorded videos on PC.

- Install the included Memory Manager software and use it to view videos on your PC.

My friends cannot view the videos I have sent them.

- Use the SHARE functions of the Memory Manager for sharing videos with friends and family. The native files from the camcorder may not play in other computers.

Product registration

Please go to www.mysmallwonder.com for online registration.

For your records

Keep your sales receipt for proof of purchase to obtain warranty parts and service.

In the event that service should be required, you may need both the model number and the serial number.

In the space below, record the date and place of purchase, and the serial number:

Model No.

Date of Purchase

Place of Purchase

Serial No.

Service Information

This product should be serviced only by those specially trained in appropriate servicing techniques. For instructions on how to obtain service, refer to the warranty included in this Guide.

Copyright warning

This player is for your personal use only. Unauthorized recording or duplication of copyrighted material may infringe upon the rights of third parties and may be contrary to copyright laws.

Back up your data

As with any portable player, you must back up the drive regularly. The manufacturer is not responsible for lost data.

Visiting RCA website

Please visit www.mysmallwonder.com for:

- Latest software and firmware
- RCA Memory Manager Software
- User manual
- Frequently asked questions (FAQ)
- Customer service and technical support information

Technical specifications

Product:

- Digital Camera Recorder

Brand:

- RCA

Model:

- EZ1010, EZ1010BL and EZ1010RD

Battery:

- 4 x AAA battery

Size and frame rate of video recordings:

- HQ mode: 640 x 480 pixels @ 30 fps (AVI format)
- webQ mode: 448 x 336 pixels @ 30 fps (AVI format)

Size of still images:

- 1280 x 960 pixels (JPG)

Recording media:

- Internal memory
- MicroSD card (not included)

Maximum recording time (approximate figures):

| Video Recording Modes | Maximum recording time with 16 GB microSD card |
|------------------------------------|--|
| HQ (High Quality mode) | 8 hours |
| Web Q (Web Quality mode) | 16 hours |
| Maximum no. of photos can be taken | 16,000 |

LCD screen:

- 1.5 inches

Microphone:

- Mono microphone

Battery life:

- Maximum recording time for video: 120 minutes HQ video; 140 minutes of WebQ video
- Maximum number of photos can be taken: 1100 photos

Warranty information

Limited warranty

12 Month Limited Warranty Applies to RCA Audio/Video Products

AUDIOVOX ELECTRONICS CORP. (the Company) warrants to the original retail purchaser of this product that should this product or any part thereof, under normal use and conditions, be proven defective in material or workmanship within 12 months from the date of original purchase, such defect(s) will be repaired or replaced with reconditioned product (at the Company's option) without charge for parts and repair labor.

To obtain repair or replacement within the terms of this Warranty, the product is to be delivered with proof of warranty coverage (e.g. dated bill of sale), specification of defect(s), transportation prepaid, to the Company at the address shown below.

This Warranty does not extend to the elimination of externally generated static or noise, to correction of antenna problems, loss/interruptions of broadcast or internet service, to costs incurred for installation, removal or reinstallation of product, to corruptions caused by computer viruses, spyware or other malware, to loss of media, files, data or content, or to damage to tapes, discs, removable memory devices or cards, speakers, accessories, computers, computer peripherals, other media players, home networks or vehicle electrical systems.

This Warranty does not apply to any product or part thereof which, in the opinion of the Company, has suffered or been damaged through alteration, improper installation, mishandling, misuse, neglect, accident, or by removal or defacement of the factory serial number/bar code label(s). THE EXTENT OF THE COMPANY'S LIABILITY UNDER THIS WARRANTY IS LIMITED TO THE REPAIR OR REPLACEMENT PROVIDED ABOVE AND, IN NO EVENT, SHALL THE COMPANY'S LIABILITY EXCEED THE PURCHASE PRICE PAID BY PURCHASER FOR THE PRODUCT.

This Warranty is in lieu of all other express warranties or liabilities. ANY IMPLIED WARRANTIES, INCLUDING ANY IMPLIED WARRANTY OF MERCHANTABILITY, SHALL BE LIMITED TO THE DURATION OF THIS WRITTEN WARRANTY. ANY ACTION FOR BREACH OF ANY WARRANTY HEREUNDER INCLUDING ANY IMPLIED WARRANTY OF MERCHANTABILITY MUST BE BROUGHT WITHIN A PERIOD OF 24 MONTHS FROM DATE OF ORIGINAL PURCHASE. IN NO CASE SHALL THE COMPANY BE LIABLE FOR ANY CONSEQUENTIAL OR INCIDENTAL DAMAGES FOR BREACH OF THIS OR ANY OTHER WARRANTY. No person or representative is authorized to assume for the Company any liability other than expressed herein in connection with the sale of this product.

Some states do not allow limitations on how long an implied warranty lasts or the exclusion or limitation of incidental or consequential damage so the above limitations or exclusions may not apply to you. This Warranty gives you specific legal rights and you may also have other rights which vary from state to state.

How to make a warranty claim:

- If your product is capable of storing content (such as an mp3 player, digital voice recorder, etc), it is recommended to make periodic backup copies of content stored on the product. If applicable, before shipping a product, make a back up copy of content or data stored on the device. Also, it is advisable to remove any personal content which you would not want exposed to others. IT IS LIKELY THAT CONTENTS AND DATA ON THE DEVICE WILL BE LOST DURING SERVICE AND REFORMATTING. AUDIOVOX ACCEPTS NO LIABILITY FOR LOST CONTENT OR DATA, OR FOR THE SECURITY OF ANY PERSONAL CONTENT OR DATA ON THE RETURNED DEVICE. Product will be returned with factory default settings, and without any pre-loaded content which may have been installed in the originally purchased products. Consumer will be responsible for reloading data and content. Consumer will be responsible to restore any personal preference settings.
- Properly pack your unit. Include any remotes, memory cards, cables, etc. which were originally provided

with the product. However DO NOT return any removable batteries, even if batteries were included with the original purchase. We recommend using the original carton and packing materials.

- Include evidence of purchase date such as the bill of sale. Also print your name and address and a description of the defect. Send via standard UPS or its equivalent to:

Audiovox Electronics Corp.

Attn: Service Department.

150 Marcus Blvd.

Hauppauge N.Y. 11788

1-877-833-3491

- Insure your shipment for loss or damage. Audiovox accepts no liability in case of damage or loss en route to Audiovox.
- Pay any charges billed to you by the Exchange Center for service not covered by the warranty.
- A new or refurbished unit will be shipped to you freight prepaid.

What we will do:

Provide you with a new, or at our option, a refurbished unit. The exchange unit is under warranty for the remainder of the original product's warranty period.

For Canada Customers, please ship to:

Audiovox Return Centre

c/o Genco

6685 Kennedy Road,

Unit#3, Door 16,

Mississauga, Ontario

L5T 3A5

Illustrations contained within this publication are for representation only and subject to change.

The descriptions and characteristics given in this document are given as a general indication and not as a guarantee. In order to provide the highest quality product possible, we reserve the right to make any improvement or modification without prior notice.

Visit <http://store.audiovox.com> to find the best accessories for your products.



For Customer Service
Visit Our Website At

www.mysmallwonder.com

Product Information, Photos,
FAQ's, User Manual

© 2010 Audiovox Accessories Corporation
111 Congressional Blvd., Suite 350
Carmel, IN 46032
Trademark(s) ® Registered

v1.0 (1.0.1.0)

Free Manuals Download Website

<http://myh66.com>

<http://usermanuals.us>

<http://www.somanuals.com>

<http://www.4manuals.cc>

<http://www.manual-lib.com>

<http://www.404manual.com>

<http://www.luxmanual.com>

<http://aubethermostatmanual.com>

Golf course search by state

<http://golfingnear.com>

Email search by domain

<http://emailbydomain.com>

Auto manuals search

<http://auto.somanuals.com>

TV manuals search

<http://tv.somanuals.com>