

RCA

Digital Camcorder User's Guide

Changing Entertainment. Again.



CC9370

Safety Information

Be sure to read all the safety information before you begin to use this product.

WARNING

To reduce the risk of fire or electric shock, do not expose this camcorder or AC charger to rain or moisture.

WARNING

RISK OF ELECTRIC SHOCK
DO NOT OPEN

To reduce the risk of electric shock, do not remove cover (or back). No user serviceable parts inside. Refer servicing to qualified service personnel.



This symbol indicates "dangerous voltage" inside the product that presents a risk of electric shock or personal injury.



This symbol indicates important instructions accompanying the product.

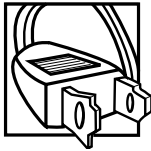

CAUTION: To prevent electric shock, match wide blade of plug to wide slot, fully insert.

ATTENTION: Pour éviter les chocs électriques, introduire la lame la plus large de la fiche dans la borne correspondante de la prise et pousser jusqu'au fond.

To reduce risk of injury, charge only rechargeable batteries recommended by the manufacturer for this camcorder. Other types of batteries may burst causing damage and personal injury.

FCC Regulations state that unauthorized changes or modifications to this equipment may void the user's authority to operate it.

Product Registration

Please fill out the product registration card and return it immediately. Returning this card allows us to contact you if needed.

Keep your sales receipt for proof of purchase to obtain warranty parts and service and attach it here. Record the serial number and model numbers located on the bottom of the camcorder.

Model No: CC9370

Serial No: _____

Purchase Date: _____

Purchased From: _____

Table of Contents

Assistance	3	On-screen Menus	29
First-Time Operation	3	Accessing Menus	29
Getting Started	3	Fader/Wipe Effects	29
Using the LCD Monitor:	7	Program AE with Special	
Reviewing Operating Controls	9	Effects	30
Powering the Camcorder	11	Exposure Control	32
Using the Adapter/Charger	11	Iris Lock	32
Using the Rechargeable Battery	12	White Balance Adjustment ...	33
Charging the Battery	13	Manual White Balance	34
Battery Life	14	Using the Manual Menu	35
Battery Level Indicator	14	Digital Image Stabilization ...	35
Battery Care and Storage	14	Tele Macro Focusing	35
Other Camcorder Details	15	Wide Mode	36
Shoulder Strap	15	Cutting Wind Noise	37
Working With the Right Media .	16	Resetting Defaults	37
Mini DV Cassettes	16	Using the Camera Menu	37
Erase Protection Tab	16	Recording Mode	38
Recording and Playback Speeds		Sound Mode	38
and Times	16	Zoom Mode	38
Cassette Notes	17	Gain Up	39
Care and Storage	17	Tally Light	39
Time-Remaining Display	17	ID Number	40
On-Screen Preferences	18	Demo Mode	40
Display Menu Options	18	Side LED	41
Setting the Date and Time	18	Using the Display Menu	41
Displaying Information on		On-Screen Displays	41
the Camcorder or TV	19	Date and Time Display	42
Displaying Date and Time		Time Code	42
Information On Screen	20	Clock Adjustment	42
Time Code Display	20	Recording	43
Using the Monitors	22	Recording Details	43
Seeing What You Are		Video Light	43
Recording	22	Camcorder Focus	45
Using the LCD Monitor	22	Auto Focus	45
Using the Viewfinder	23	Manual Focus	46
Focusing the Eyepiece	23	Snapshot Feature	46
On-screen Indicators	24	FRAME	46
Warning Indicators	24	FULL	46
Recording Mode Indicators	25	MULTI-4	47
Playback Mode Indicators	27	MULTI-9	47
		PIN-UP	47

Table of Contents

Recording

- Recording Details
 - Digital and Optical Zooming 47
 - Using the Zoom Lever 47

Playback 49

- Basic Playback 49
 - Speaker Volume 49
 - Still Playback Mode 50
 - Shuttle Search 50
 - Frame-By-Frame Playback ... 50
- Basic Connections 50
 - Displaying Data on a TV or VCR 50

Viewing Recordings on a TV

- Using A/V Input Jacks 51

Connecting to a TV Using

- A/V Input Jacks 51

Connecting to a VCR

- Using A/V Input Jacks 52

Connecting to a Computer

- Using IEEE 1394 Jacks 53

Connecting to a VCR to

- Capture Sound Only 54

Dubbing to Another Digital

- Video Camcorder 55

Camcorder Tips 56

- Recording Tips 56
- Traveling Tips 56

Optional Accessories 57

- Soft Carrying Case 57
- Shoulder Strap 57
- Rechargeable Battery 57
- Extended Life Battery 57
- AC Battery Charger 58
- Universal Remote Control 58
- IEEE 1394 Cable 58
- A/V Cable 58
- DC Cable 58
- Tripod 59
- Accessories Order Form 60

Trouble Checks 63

Specifications 68

Care and Maintenance 69

- After Using the Camcorder 69
- Cleaning The Camcorder 69
- Proper Care and Storage 70
- Things to Avoid 70

Customer Assistance and Service 71

Warranty 72

Working With the Core Filter 74

Index 75

First-Time Operation

Assistance

The toll-free numbers are available to help with any problem you may encounter.

Camcorder Exchange Warranty 800-283-6503 (*pages 72-73*)

Customer Service 800-336-1900 (*page 71*)

Accessories 800-338-0376 (*pages 57-62*)

Getting Started

This section describes the steps necessary to set up your camcorder to record. Refer to the other sections for detailed operation and feature options.

1. Unpack the camcorder and accessories.

- Save all packing materials and box in case the camcorder ever needs to be shipped or stored.
- The items shown are packed with the camcorder. If any pieces are missing or appear damaged, contact your dealer immediately.
- Remove the plastic film that covers the front and side logos on the camcorder. Use a fingernail, not anything sharp, to remove.

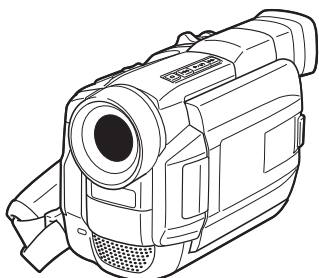

Model CC9370

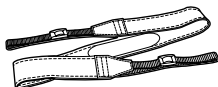

*Shoulder Strap
Part No. ACS091*

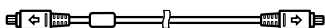

*IEEE 1394
Connection Cable
Part No. 249644*

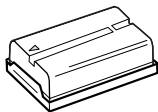

*Lithium-ion Battery
Part No. 247800*

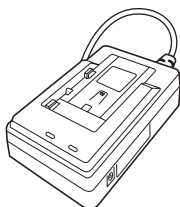

*AC Adapter/Charger
Part No. 247801*



*Audio/Video Cable
Part No. 249645*



*Core Filter for Optional
S-Video cable
(see page 74 for details)*

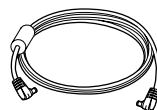

*DC Cable
Part No. 244268*

Caution

Never use the adapter/charger for any purpose other than charging the 247800 battery pack (or the optional BB46L) or for supplying power to the camcorder.

First-Time Operation

2. Adjust the handstrap to fit your hand.

- A. Lift the flap on the handstrap and separate the Velcro strip.
- B. Insert your hand so your fingers can comfortably reach the camera buttons.
- C. Adjust the strap to fit snugly.
- D. Refasten the strap, and fold the flap back down.

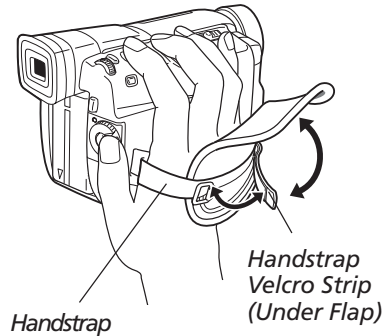

3. Attach the adapter/charger.

Since the battery must be charged before it can be used the first time, attach the adapter/charger to the camcorder using the included DC power cable.

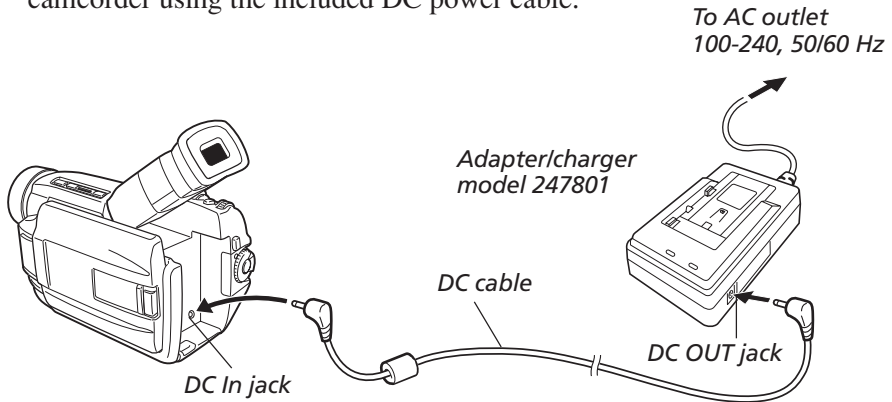

- A. Connect one end of the DC cable to the *DC OUT* jack on the adapter/charger.
- B. Connect the other end of the DC cable to the DC in jack on the camcorder.
- C. Plug the adapter/charger's plug into a working power outlet.

First-Time Operation

4. Press in the Lock Button and rotate the Power Switch to automatic (A) record .

- The Power Indicator lights when the camcorder is turned on.
- The position of the Power Switch determines whether the camcorder is in automatic (A) or manual (M) record mode, powered off (OFF), or in playback mode (PLAY).
- Automatic recording places the camcorder into AutoShot™ mode. Focus, exposure, iris control, white balance, and the recording light are controlled by the camcorder during automatic recording.

Note: Many special effects do not operate in AutoShot mode (see pages 31-32 for more information).

- Manual (M) recording mode allows you to control many of the camcorder's special features.

Note: The camcorder automatically turns off to save battery power if left in record-pause mode for more than five minutes. Set the Power Switch to OFF, then back to automatic or manual record mode to turn back on.

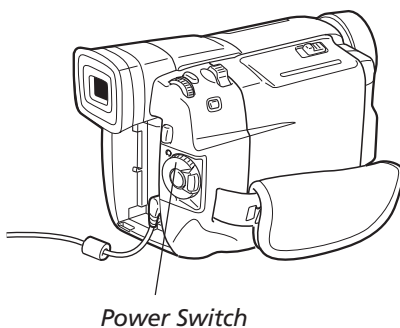
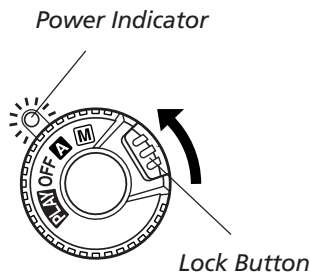

5. Set the Light (AUTO/ON/OFF) switch to AUTO.

Open the LCD monitor by pressing and holding the PUSH OPEN latch, then rotate the monitor outward.

Note: Opening the LCD more than 25 degrees automatically turns it on and turns off the image in the viewfinder.

With the light switch set to AUTO, the Video Light automatically turns on when more light is needed.

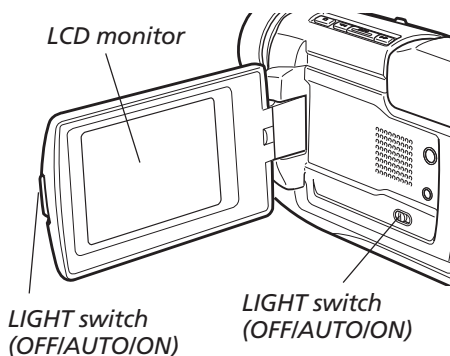

First-Time Operation

6. Insert a Mini DV cassette.

- A. Make sure the camcorder is connected to a power supply.
- B. With the camcorder set to automatic (A) record, slide and hold the OPEN/EJECT latch. Gently pull the cassette cover open until it snaps into place. The cassette holder automatically opens.
- C. Insert a Mini DV cassette with the record protection tab facing up and the tape window facing out.

Note: The Mini DV cassette's record Protection Tab must be set to REC in order to be recorded on.

- D. Push on the area marked **PUSH HERE** until the cassette holder locks into place.
- E. **PAUSE** appears on the LCD or in the viewfinder when a recordable tape is inserted into the camcorder.

Record protection tab

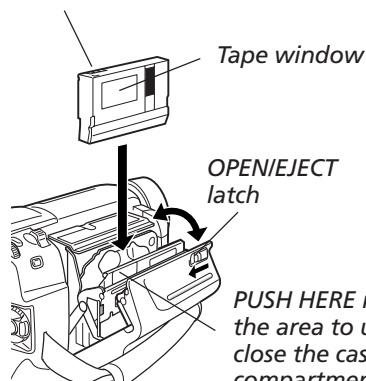

Caution

Never open the cassette holder door by force. This could damage the camcorder and void the warranty.

The camcorder must be connected to a power supply to load or eject a cassette.

7. Use the LCD monitor to see what's recording.

To see what's recording use the color LCD monitor.

Note: When the LCD monitor opens more than 25 degrees, the viewfinder automatically turns off. When the LCD monitor is closed, the viewfinder automatically turns on.

To enable both you and the person being recorded to see what's on the LCD monitor, you can rotate the screen 180 degrees so the front of the monitor faces forward.

Note: With the LCD monitor completely rotated, the viewfinder also turns on.

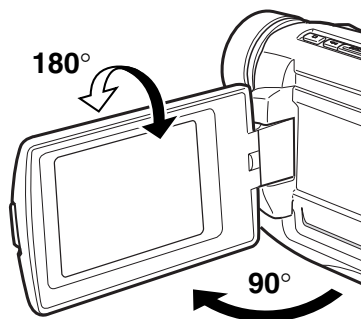

First-Time Operation

Using the LCD Monitor:

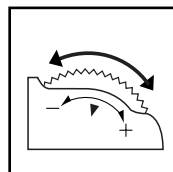
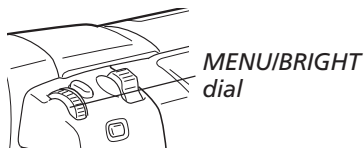

- A. Open the monitor 90 degrees from the camcorder body.
- B. Tilt the monitor 180 degrees forward or 90 degrees down as required for convenient viewing while recording.
- C. To adjust the brightness of the LCD monitor's image, rotate the MENU/BRIGHT dial .

Note: Adjusting the LCD monitor brightness does not affect the recorded image on cassette.



Rotating the MENU/BRIGHT dial adjusts the brightness of the LCD monitor.

8. Start and stop recording.

- A. Remove the Lens Cap.
- B. Put the camcorder in automatic record mode by pressing the Lock Button in and rotating the Power Switch to the  icon.
- C. Press and release the Thumb Trigger to start recording. The  icon appears in the viewfinder or LCD monitor (but does not show up in the recording). This indicator reflects that recording has started.
- D. When finished recording, press and release the thumb trigger again to stop recording. The camcorder is now in the record-pause mode. The  icon appears in the viewfinder or on the LCD monitor.

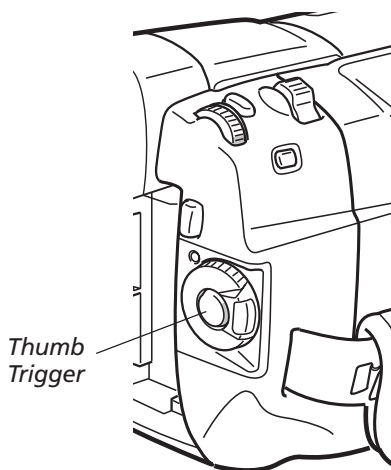

First-Time Operation

9. Play back your recording.

- A. Press the Lock Button in while rotating the Power Switch to the **PLAY** icon to put the camcorder in playback mode.

The Power Indicator lights.

- B. Press the Rewind Button (◀◀) on top of the camcorder to reverse the cassette to the beginning. When rewound completely, the camcorder will automatically stop.

The time counter and date/time on-screen displays will blink.

- C. Press the Play/Pause button (▶/||) on top of the camcorder to start playback.

- D. View the recording using the LCD monitor or viewfinder.

Notes: The LCD monitor displays the recording in full color while the viewfinder displays in black and white only.

Sound will play back if the LCD monitor is open or closed. To adjust the volume, use the Zoom Lever (also labeled – VOL +).

More information about using the LCD monitor and viewfinder can be found on pages 22-23.

- E. Press the Stop Button (■) on top of the camcorder when finished playing back the tape.

Power Indicator

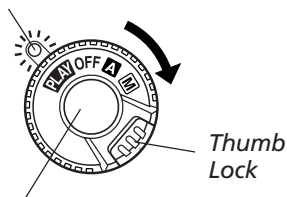

Pressing the Thumb Trigger will start or pause recording

Playback buttons on top of the camcorder include Stop (■), Rewind (◀◀), Play/Pause (▶/||), and Fast Forward (▶▶).

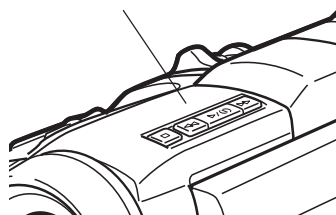

10. Turn off the camcorder.

Press in the Lock Button and rotate the Power Switch to OFF.

11. Close the LCD monitor.

First-Time Operation

Reviewing Operating Controls

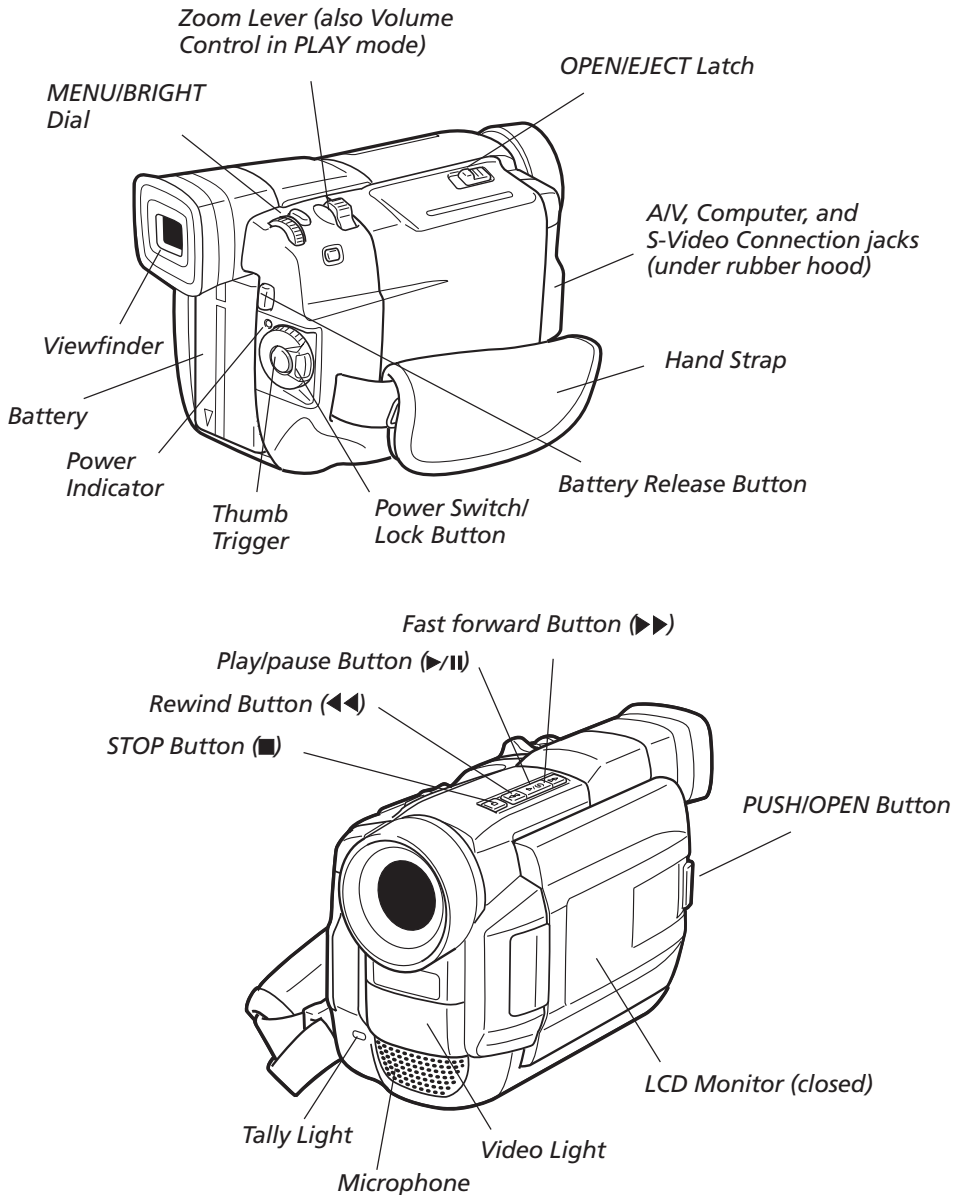

First-Time Operation

Reviewing Operating Controls

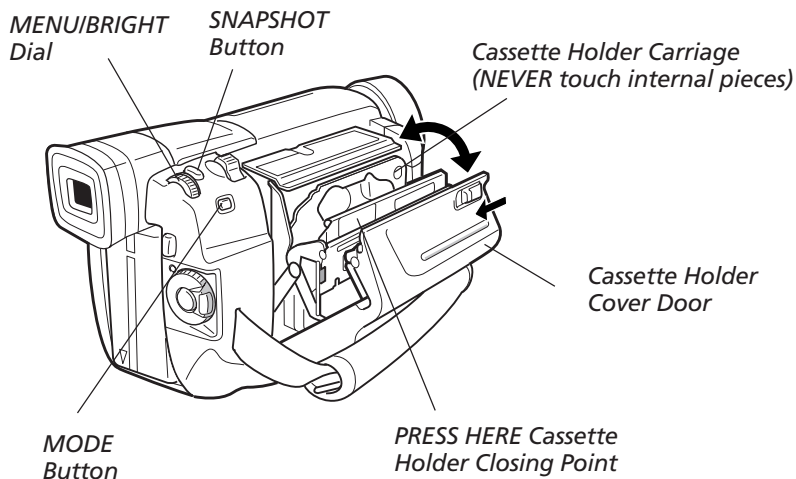
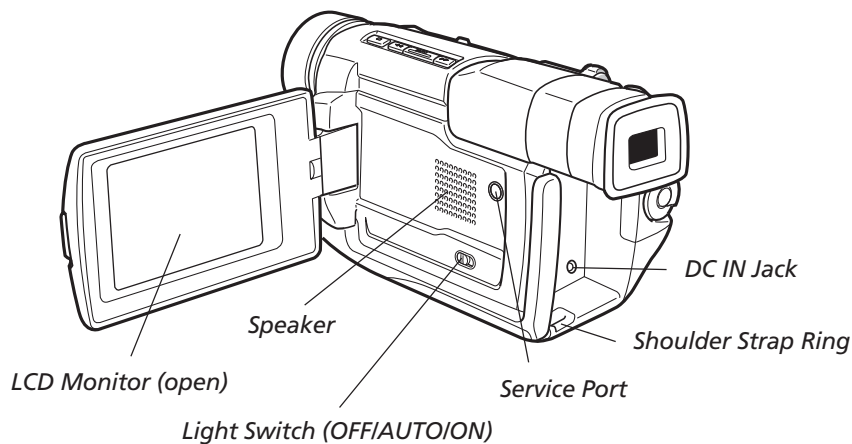

Powering the Camcorder

Using the Adapter/Charger

The Adapter/Charger attaches to the camcorder and lets you power your camcorder directly from standard household power. The Adapter/Charger operates on 100-240 volts, 50/60 Hz.

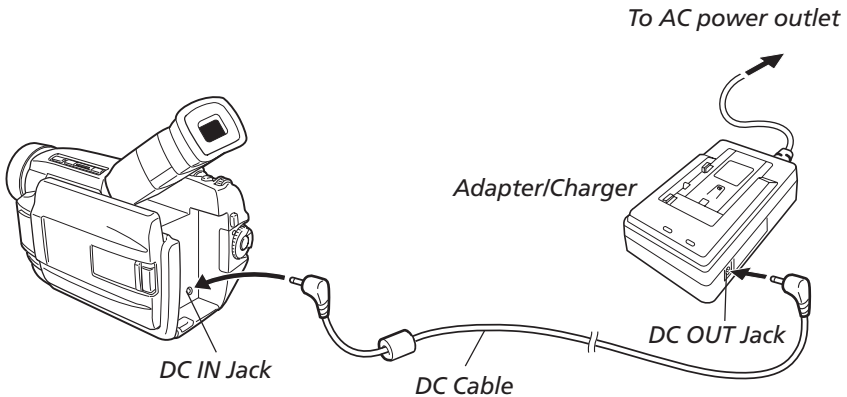

Attaching the Adapter/Charger

1. Connect one end of the DC cable to the DC OUT jack on the Adapter/Charger .
2. Connect the other end of the DC cable to the DC IN jack on the camcorder.
3. Plug the Adapter/Charger's plug into an AC power outlet (100-240V, 50/60Hz).

CAUTION

Never use this Adapter/Charger for any purpose other than charging the 247800 battery pack (or the optional BB46L) or in conjunction with the DC cable to supply power to the camcorder.

Removing the Adapter/Charger

1. Unplug the Adapter/Charger from the power outlet.
2. Remove the DC cable from the Adapter/Charger and camcorder.

Using an Optional Plug Adapter

An optional plug adapter might be required in some countries.

1. Plug the adapter/charger's plug into the AC plug adapter.

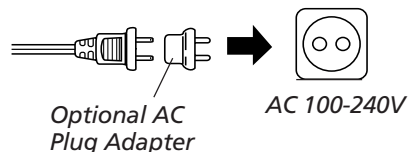

2. Plug the AC plug adapter into the AC outlet.

Powering the Camcorder

Using the Rechargeable Battery

The battery must be charged as described on the next page before it can be used the first time. Initial charging takes approximately 90 minutes. When fully charged, the battery supplies approximately 75-95 minutes of operating time— depending on how much the monitor, zoom, and pause are used. Conserve battery power by turning the camcorder off during recording breaks.

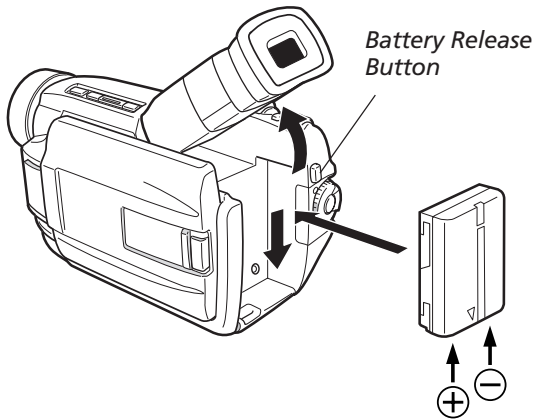

Safety Precautions

- Do not short the battery's terminals.
- Do not attempt to disassemble or modify the battery. No user-serviceable parts are inside.
- Use the battery only with specified adapter/chargers and camcorders.
- Throwing the battery into a fire or exposing it to excessive heat – over 149 degrees F (65 degrees C) could be hazardous.

Attaching a Charged Battery

If the DC cable is attached to the camcorder, remove it before attaching the battery.

1. Lift the viewfinder.
2. Slide the battery into the back of the camcorder. Make sure the arrow diagram on the battery points down so the contacts on the battery and camcorder match.
3. Turn the Power Switch to record (M or A). The power indicator lights.

Removing a Battery

Press and hold the BATTERY RELEASE button. Slide the battery up and out to remove.

Powering the Camcorder

Charging the Battery

If the DC cable is attached to the DC OUT jack on the Adapter/Charger, remove it.

1. Make sure the arrow on the battery faces up and points to the Adapter/Charger's POWER light.
2. Hold the battery flush against the Adapter/Charger and slide it in the direction of the arrow.
3. Plug the Adapter/Charger into the nearest AC power outlet (100-240V, 50/60Hz).
4. If the battery is properly connected, the CHARGE indicator blinks.
5. After the battery is charged, the CHARGE indicator stops blinking and remains lit.
6. Remove the charged battery by sliding it off the Adapter/Charger.
7. Attach the charged battery to the camcorder as described on the previous page.

Note: If you try to charge a battery that has not been charged for a long period of time, it may take a few minutes for the *CHARGE* indicator to flash.

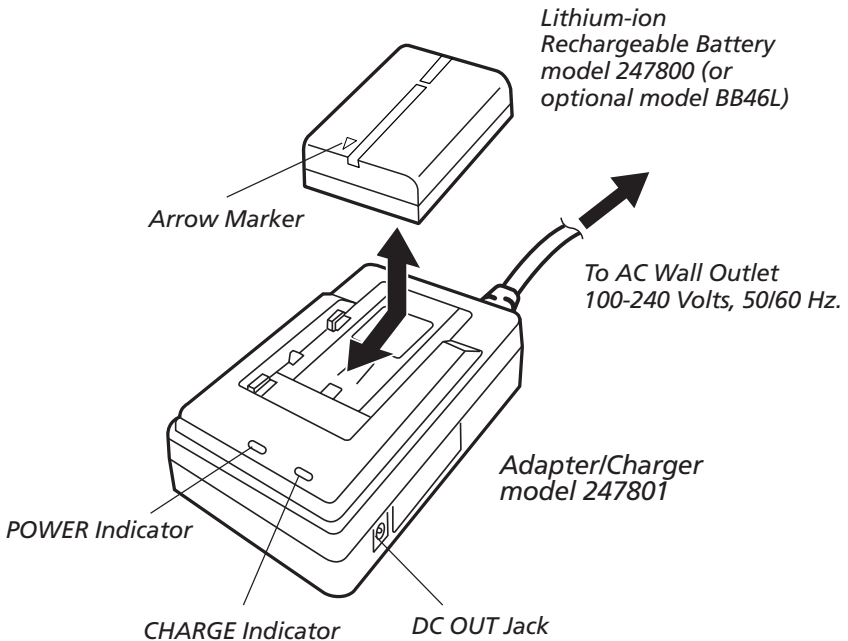

CAUTION

When a battery is attached to the Adapter/Charger, do not turn them upside down. The battery may fall off and be damaged or cause injury.

Powering the Camcorder





Battery Life

Battery Level Indicator

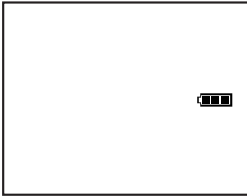
The battery level indicator appears in the viewfinder or LCD monitor and reveals the amount of power left in the rechargeable battery.

Notes: The battery level indicator is not recorded on the tape.



- When  appears, the battery is fully charged.
- As power is used,  will appear which will be followed by the  icon.
- Finally, when the battery power is almost gone,  flashes on screen. The camcorder turns off automatically after a few seconds. Before replacing the battery or plugging the DC Cable into the camcorder, set the Power Switch to OFF to turn off the camcorder.

Battery Care and Storage

- Recharging takes approximately 70 minutes for the battery depending on its condition.

Notes: If a protective cap is on the battery, remove it before use or charging.

When charging a battery for the first time or after a long storage period, the CHARGE indicator may not light on the Adapter/Charger. Remove the battery and try again.

Charge the battery in temperatures between 50 and 90 degrees Fahrenheit (10-35 degrees Celsius).

Charging times are based on a fully discharged battery.

Charging times vary depending on ambient temperature and battery condition.

If you connect the camcorder's DC cord to the Adapter/Charger during battery recharging, power is supplied to the camcorder and charging stops.

- After repeated charging and use, battery life gradually decreases. When operation time is too short to be useful, the battery should be replaced.
- If the battery discharging must be stopped in the middle, remove the battery from the adapter/charger before unplugging it from the AC outlet.
- If the battery pack becomes too hot, remove it from the charger and let it cool down.
- Let a hot battery cool down before attaching it to the AC adapter/charger.

Shoulder Strap

The camcorder's shoulder strap is designed to let you carry the camera from your shoulder and – when ready– bring the camcorder to shooting position in one quick movement.

Attaching the Shoulder Strap

1. Make sure the battery pack or DC cord is removed.
2. Following the illustration, thread the strap through the eyelet.
3. Fold the strap back and thread it through the buckle.
4. Repeat the procedure to attach the other end of the strap to the other eyelet located under the Hand Strap. Make sure the strap is not twisted.

Caution

When carrying the camcorder with the shoulder strap, you should close the LCD monitor and rotate the viewfinder down. This helps prevent possible damage to the monitor or viewfinder from bumping against your body as you move. Make sure the shoulder strap is firmly attached before using it to carry the camcorder.

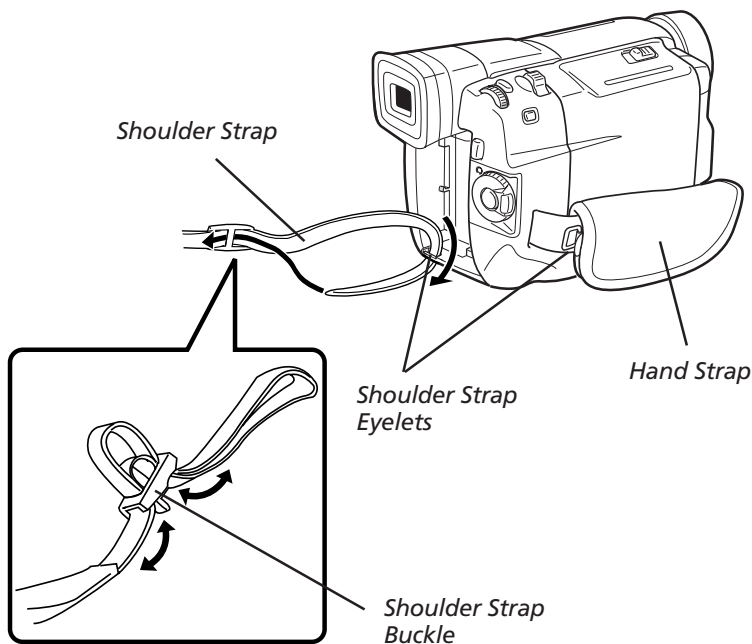

Working With the Right Media

Mini DV Cassettes

This camcorder is designed to work exclusively with digital video cassettes. Only cassettes marked with a Mini DV logo can be used with this unit. Also keep in mind that this camcorder is not compatible with other digital media formats.

Note: For details on loading and unloading cassettes into the digital camcorder, see page 6 in this manual.



Erase Protection Tab

You can use your videocassettes over and over again. To erase a previous recording, make sure that the Erase Protection Tab is set to REC. To protect a cassette from being recorded over, move the Erase Protection Tab to SAVE.

Recording and Playback Speeds and Times

The camcorder records and plays back in Standard Play (SP) or Long Play (LP) mode. Select the recording speed using the on-screen menus (*see page 38 for details*).

The selected speed is displayed on screen but not in the recording. The maximum SP and LP recording times for popular Mini DV cassettes are shown.

- SP Provides the best picture (less picture noise), but the shortest recording time (as few as 30 minutes).
- LP Provides the longest recording times (up to 120 minutes with an 80-minute tape) but has more potential picture noise than SP in normal playback.

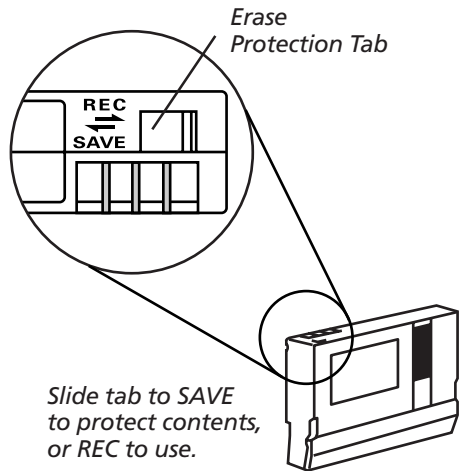

Cassette	Recording Time	
	SP	LP
30 min.	30 min.	45 min.
60 min.	60 min.	90 min.
80 min.	80 min.	120 min.

Working With the Right Media

Cassette Notes

- A power supply must be attached to load or eject a cassette.
- When loading a cassette, it takes a few seconds for the Cassette Holder to open. Never apply force to the holder or door cover as this might result in damage to the camcorder and void the warranty.
- If the cassette holder does not open after a few seconds, close the holder door and try again. If it still does not open, turn the camcorder off then on again.
- If the cassette does not load properly, open the cassette holder door and fully remove the unit. Wait a few minutes and reinsert it.
- When the camcorder is suddenly moved from a cold environment to a warm environment, wait a short time before opening the cassette holder door.
- Closing the cassette holder door before the holder comes out may damage the camcorder.
- Even when the camcorder is turned off, a cassette can still be loaded or unloaded. After the cassette holder is closed with the camcorder switched off, though, it may not recede. **Turn the power on before loading or unloading cassettes.**
- When recording, once the cassette holder door is open, a blank portion will be recorded on the tape or a previously recorded scene will be taped over regardless of whether the tape holder came out or not.
- Loosen the grip strap if it appears to interfere with the cassette holder door operation.

Care and Storage

- When finished with a cassette, rewind it, remove it from the camcorder, and label it. Protect the tape using the erase protection tab if necessary.
- Store cassettes vertically in their protective cases at normal room temperatures. Never leave the camcorder or cassettes in a car or outdoors for an extended period of time. Excessive heat or cold might damage cassettes.
- Keep cassettes away from strong magnetic fields such as electric motors, speakers and other devices.
- Keep dust from entering the cassette compartment. All dust is abrasive and causes excessive wear on the cassette and the camcorder's recording and playback heads.
- Never use cassettes with damaged or spliced tape.
- Do not use a cassette if it has been damaged or exposed to moisture. The tape might jam and/or damage the camcorder.

Time-Remaining Display

The approximate time remaining on a recording tape is displayed on screen:

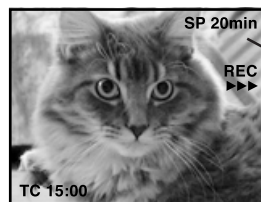

Time Remaining Display

Display Menu Options

The Display Menu offers a chance to set what is shown on screen during recording and playback. You must set the correct date and time before they can be displayed in either mode.

Setting the Date and Time

The correct date and time must be set before they can be displayed.

Date and time information is recorded onto the tape at all times, but its display can be turned on or off during playback (see *Displaying information on the camcorder or TV* on the next page for details).

1. With a power supply attached, press in the Lock Tab and rotate the Power Switch to manual (M) record. The power indicator lights.

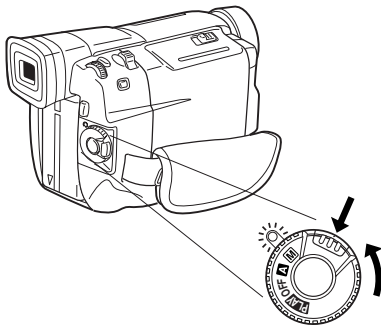

2. Press in the MENU/BRIGHT dial to display the camcorder's on-screen menus. The FADER/WIPE menu (F) is the default display.

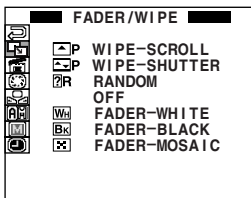

3. Rotate the MENU/BRIGHT dial to highlight DISPLAY MENU (D).
4. Press in the MENU/BRIGHT dial to display a series of submenus.
5. Rotate the MENU/BRIGHT dial to highlight CLOCK ADJ.
6. Press in the MENU/BRIGHT dial to select the choice and display time and date information. The month is highlighted.

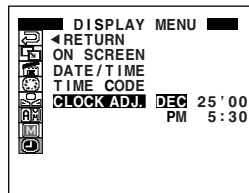

7. Rotate the MENU/BRIGHT dial to display the correct month.
8. Press in the MENU/BRIGHT dial when the correct month is shown to advance to the day entry.
9. Repeat the procedure to select the correct day. Following day is the year, then hour, and finally the minute.

Note: You must rotate through all 12 hours to change a.m. times to p.m.

10. After advancing through all of the time and date settings and CLOCK ADJ. is the only highlighted item, rotate the MENU/BRIGHT dial to highlight ◀RETURN.

On-Screen Preferences

6. Press in the MENU/BRIGHT dial to return to the main menu icons. To exit the menus and return to normal viewing, press in the MENU/BRIGHT dial when the END icon (⏪) is highlighted.

Note: For different date/time display options, see the following instructions.

You can proceed to make changes to other DISPLAY MENU items, or highlight and select ◀RETURN and then END menu selections to exit the menus and return to normal record viewing.

Displaying Information on the Camcorder or TV

1. With a power supply attached, press in the Lock Tab and rotate the Power Switch to manual (M) record.
The power indicator lights.
2. Press in the MENU/BRIGHT dial to display the camcorder's on-screen menu system.

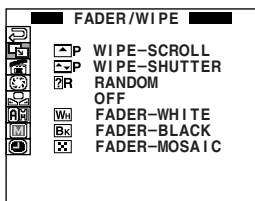

3. Rotate the MENU/BRIGHT dial to highlight the DISPLAY MENU icon (⊙). Press in the MENU/BRIGHT dial to select the choice. Press in the MENU/BRIGHT dial again to select ON SCREEN.

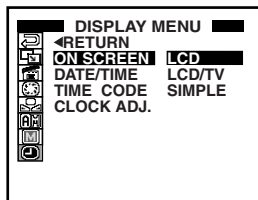

4. Choose which information will be displayed on what devices. Rotate the MENU/BRIGHT dial to highlight LCD, LCD/TV, or SIMPLE.

LCD Displays information only on the camcorder's LCD monitor and not on a connected TV screen.

LCD/TV Makes the camera's display appear on a connected TV or VCR display as well as the camcorder's LCD monitor.

SIMPLE Keeps on-screen indicators (except the tape running indicator, warning icons, and date/time information) from appearing on screen. This also keeps the camcorder's information (except date and time) from appearing on a connected TV or VCR display.

5. When you've made your choice, press in the MENU/BRIGHT dial to select it and exit back to the DISPLAY MENU.

Note: You can proceed to make changes to other DISPLAY MENU items, or highlight and select ◀RETURN and then END menu selections to exit the menus and return to normal record viewing.

On-Screen Preferences

Displaying Date and Time Information On Screen

1. With a power supply attached, press in the Lock Tab and rotate the Power Switch to manual (M) record. The power indicator lights.
2. Press in the MENU/BRIGHT dial to display the camcorder's on-screen menu system.
3. Rotate the MENU/BRIGHT dial to highlight the DISPLAY MENU icon (⊙). Press in the MENU/BRIGHT dial to select it.

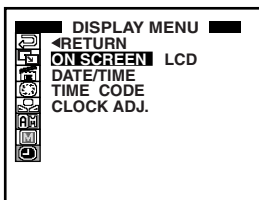

4. Rotate the MENU/BRIGHT dial to highlight DATE/TIME. Press in the MENU/BRIGHT dial to select it.

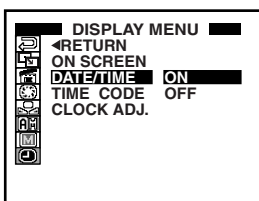

5. Rotate the MENU/BRIGHT dial to select ON or OFF.
ON Sets the date and time to always be displayed on screen.
OFF The date and time do not appear on screen

6. When the desired choice is made, press in the MENU/BRIGHT dial to activate it and exit back to the DISPLAY MENU.

Note: You can proceed to make changes to other DISPLAY MENU items, or highlight and select ◀RETURN and then END menu selections to exit the menus and return to normal record viewing.

Time Code Display

During recording, a time code is captured on the tape. This code confirms the location of the recorded scene on the tape during playback.

If recording starts from a blank portion of the tape, the time code begins counting from 00:00:00 (minutes: seconds: frame number). If recording starts from the end of a previously recorded scene, the time code continues from the last time code number.

Note: The time code is automatically set to 00:00:00 when a tape is ejected.

1. With a power supply attached, press in the Lock Tab and rotate the Power Switch to manual (M) record. The power indicator lights.
2. Press in the MENU/BRIGHT dial to display the camcorder's on-screen menu system.
3. Rotate the MENU/BRIGHT dial to highlight the DISPLAY MENU icon (⊙). Press in the MENU/BRIGHT dial to select it.
4. Rotate the MENU/BRIGHT dial to highlight TIME CODE. Press in the MENU/BRIGHT dial to select the choice and display submenus.

On-Screen Preferences

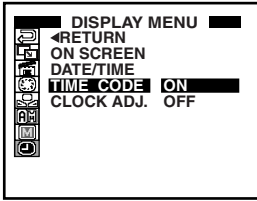

5. Rotate the MENU/BRIGHT dial to select ON or OFF.
 - ON Displays the time code on the camcorder's viewfinder or LCD monitor as well as a connected TV or VCR display. Frame numbers are not displayed during recording.
 - OFF The time code is not displayed at all.
6. When you've made your choice, press in the MENU/BRIGHT dial to activate it and exit back to the DISPLAY MENU.

Note: You can proceed to make changes to other DISPLAY MENU items, or highlight and select RETURN and then END menu selections to exit the menus and return to normal record viewing.

Using the Monitors

Seeing What You Are Recording

To see what the camcorder's recording, use either the LCD monitor or the viewfinder monitor. When the LCD monitor is open more than 25 degrees, the viewfinder turns off. When you close the LCD monitor, the viewfinder turns on.

To enable both you and the person you're recording to see what's being captured, rotate the LCD monitor completely around 180 degrees so the front of the monitor faces the person being recorded (the viewfinder turns on automatically when the monitor is turned to the front).

Using the LCD Monitor

The camcorder's LCD monitor is a miniature color monitor that displays the images captured by the camcorder in either record mode or for recording playback.

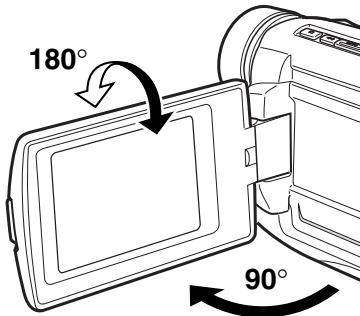

Cautions

Never force the monitor to rotate completely around. This could damage both the monitor and/or the camcorder.

When carrying the unit with the shoulder strap, close the monitor to prevent possible damage to it from bumping against objects as you move.

1. Open the LCD monitor at least 25 degrees. The viewfinder turns off.
2. For convenient viewing, the LCD can be tilted once the monitor is open 90 degrees from the camera body. Tilt the monitor forward up 180 degrees or down up to 90 degrees.
 - From a high angle (such as over a crowd)—tilt the monitor down to record.
 - From a low angle (such as when kneeling)—tilt the monitor up to record.
3. Adjust the brightness of the LCD's image by turning the bright control (MENU/BRIGHT dial). This does not affect the brightness of the recording you are making.
 - Turn the dial toward + to brighten the image.
 - Turn the dial toward – to darken the image.
4. When finished recording, close the monitor and lock it into place.

Note: Recording on bright, sunny days can make the LCD monitor hard to see. Use the viewfinder instead.

Using the Monitors

Using the Viewfinder

The camcorder's viewfinder is a miniature monitor that displays in black and white.

Note: When the LCD monitor is open more than 25 degrees the viewfinder turns off unless the LCD is rotated 180 degrees to face forward. With the LCD forward, both monitors are turned on.

For convenient viewing, rotate the viewfinder up or down.

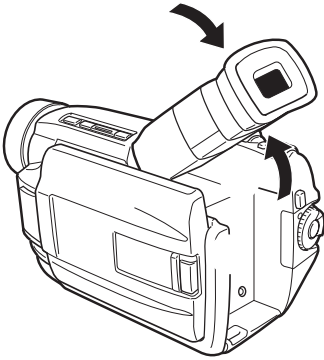

Cautions

Never force the viewfinder to rotate completely around. This will damage the viewfinder and/or the camcorder.

When carrying the camcorder with the shoulder strap, put the viewfinder down to help prevent possible damage to it from bumping against your body as you move.

Focusing the Eyepiece

The Diopter Adjustment Control on the underside of the viewfinder focuses the eyepiece's display allowing for individual vision needs.

If you wear eyeglasses, you may be able to operate the camcorder without them by using the Diopter Adjustment Control.

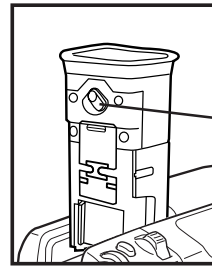

Diopter Adjustment Control

To set the correct focus, concentrate on one of the icons in the on-screen menus.

1. Adjust the eyepiece for comfortable viewing.
2. Press in the MENU/BRIGHT dial to display the on-screen menus.
3. Concentrating on the icons, turn the Diopter Adjustment Control until they come into focus.

Note: The eyepiece focus control does not affect the focus of the image captured by the camcorder.

Using the Monitors

On-screen Indicators

Several displays appear on the LCD monitor or in the viewfinder to aid in the operation of the camcorder. Although it may look crowded, all of the icons shown below do not appear on-screen at the same time. Also, not all screen icons are shown in the illustration. Refer to the icon descriptions that follow.

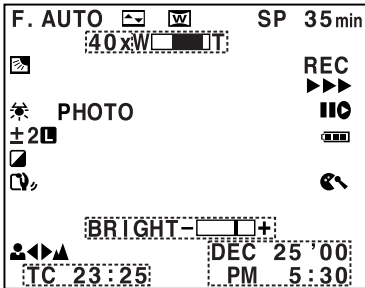

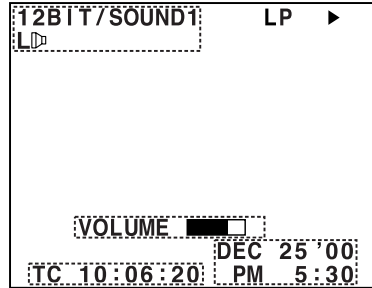

Recording Menu Icons



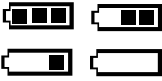

Playback Menu Icons

Warning Indicators







 <p>Battery Levels</p>	<p>Indicates the amount of power left in the rechargeable battery.</p> <p>An empty battery icon flashes on screen when the battery's power is almost exhausted.</p>
 <p>Missing Cassette Warning</p>	<p>Appears when the <i>power switch</i> is set to either automatic (A) or manual (M) record and no cassette is in the camcorder.</p>
<p>CHECK TAPE'S ERASE PROTECTION SWITCH</p>	<p>Appears when the Erase Protection Tab is set to SAVE while the Power Switch is set to either automatic (A) or manual (M) record.</p>
 <p>Head Cleaning Warning</p>	<p><i>HEAD CLEANING REQUIRED USE CLEANING CASSETTE</i> appears if dirt is detected on the recording heads. Use an optional cleaning cassette to remove dirt.</p>

Using the Monitors







Warning Indicators	
 Condensation Warning	<i>CONDENSATION, OPERATION PAUSED PLEASE WAIT</i> appears if moisture occurs inside the camcorder. When this indication appears, wait at least one hour before using the camcorder again.
TAPE! Missing Cassette Warning	Appears if a tape is not loaded when the Recording Start/Stop button or SNAPSHOT button is pressed when the Power Switch is set to automatic (A) or manual (M) record.
TAPE END End of Cassette Warning	Appears when a tape reaches its end during recording or playback.
DIFFERENT FORMATTED TAPE	Appears if a tape in another format is loaded.
LENS CAP Covered Lens Warning	Appears briefly after the power is turned on to either automatic or manual record mode and the lens cap is still attached.
SET DATE/TIME Missing Information Warning	Appears when the date and time are not set. Appears when the built-in clock battery runs out and the previously set date/time is erased. Consult your nearest RCA service center for replacement.



Recording Mode Indicators (A or M)	
F. AUTO Auto Recording Indicator	Appears when in automatic (A) record mode.
 Fade and Wipe Effect	Displays the fade/wipe effect in use (<i>see pages 29-30 for details about fade and wipe effects.</i>)

Using the Monitors









Recording Mode Indicators (A or M)	
 Wide Frame Indicator	Appears when the camcorder is in 16x9 mode (wide screen).
SP Tape Speed Indicator	Display of the set recording speed (either Standard Play [SP] or Long Play [LP]).
40X Zoom Ratio	Displays the approximate zoom ratio during zooming. <ul style="list-style-type: none"> • A* appears when GAIN UP is set to AUTO and the shutter speed is automatically adjusted. •  is the zoom lever indicator.
 Back Lighting Indicator	Appears when back lighting compensation is turned on.
REC/PAUSE Record/Pause Indicators	<ul style="list-style-type: none"> • REC appears during recording. • PAUSE appears during Record-Standby.
 Active Tape Indicator	Appears when a tape is running.
 White Balance Adjustment	Appears when white balance is adjusted.
PHOTO Snapshot Indicator	Appears when a snapshot is being taken.
±2 Exposure Adjustment Icon	Appears when the exposure is adjusted.
±2  Iris Lock Indicator	Appears when the iris is locked.

Using the Monitors

Recording Mode Indicators ( or )	
 Special Effects Indicator	Displays the selected <i>Program AE</i> with special effects icons.
 Image Stabilization Indicator	Appears when Digital Image Stabilization (DIS) is activated. The icon blinks or goes out when DIS is activated but cannot be used.
 Wind Cut Mode	Appears when wind cut mode is engaged to reduce the noise created by wind.
BRIGHT -  + Bright/Sound Indicator	<ul style="list-style-type: none"> • BRIGHT displays the brightness of the LCD monitor. • SOUND displays the sound mode for approximately five seconds after the camcorder is turned on.
 Manual Focus Indicator	Appears when the focus is adjusted manually.
DEC 25 '00 PM 5:30 Date/Time Indicator	Displays the date and time briefly when the camcorder is turned on.
TC 23:25 Time Code Display	Displays the time code.

Playback Mode Indicators ()	
12BIT/SOUND1  Sound Mode Indicator	Displays the sound mode (either 12 or 16-bit)
LP Tape Speed Indicator	Displays the playback tape speed (either SP or LP).

Using the Monitors

Playback Mode Indicators ()	
<p style="text-align: center;"> Playback Indicator</p> <p style="text-align: center;"> Rewind Indicator</p> <p style="text-align: center;"> Fast Forward Indicator</p> <p style="text-align: center;"> Playback/Pause Indicator</p> <p style="text-align: center;"> Forward Slow Motion Indicator</p> <p style="text-align: center;"> Reverse Slow Motion Indicator</p>	<p>Tape progress indicators appear on screen after the corresponding button on top of the camcorder has been pressed.</p>
<p style="text-align: center;">VOLUME  Bright/Sound Display</p>	<ul style="list-style-type: none"> • BRIGHT Displays the brightness of the LCD monitor. • SOUND displays the speaker volume. The level indicator moves to reflect an increase or decrease in volume.
<p style="text-align: center;">TC 10:06:20 Time Code Display</p>	<p>Displays the recorded time code.</p>
<p style="text-align: center;">DEC 25 '00 PM 5:30 Date/Time Display</p>	<p>Displays the date/time.</p>

On-Screen Menus

Your digital camcorder has a variety of modes to choose from to achieve recordings with professional results. You can change detailed settings using the camcorder's on-screen menu system.

Accessing Menus

1. Press in the Thumb Release and rotate the Power Switch to manual (M) record.
2. Press in the MENU/BRIGHT dial to display the on-screen menus.

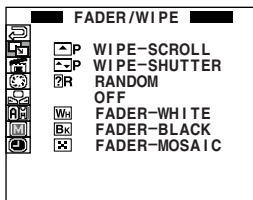

3. Rotate the MENU/BRIGHT dial to highlight the desired menu function to allow:
 - FADER/WIPE adjustment of transition effects.
 - P.AE/EFFECT setting special effect functions.
 - EXPOSURE setting exposure values and iris lock.
 - W.BALANCE adjustment of white balance settings or setting manual white balance.
 - CAMERA MENU adjustment of recording speed, sound mode, zoom, gain up, tally, computer ID number, demonstration mode, and side LED settings.

- MANUAL MENU adjustment of image stabilization, tele macro focus, wide mode, wind cut, and camera reset settings.
 - DISPLAY MENU adjustment of on-screen displays, date and time, time code stamp, and clock adjustment settings.
4. When the desired icon is highlighted, press in the MENU/BRIGHT dial to display the menu's choices. Rotate the MENU/BRIGHT dial to highlight the desired submenu selection.

Fader/Wipe Effects

These effects create professional-looking scene transitions.

Note: Some fade/wipe effects cannot be used with certain types of P.AE special effects. If an unusable fade/wipe effect is selected, its indicator blinks or goes out.

1. Highlight the FADER/WIPE icon by rotating the MENU/BRIGHT dial. Press the MENU/BRIGHT dial in to highlight the submenus.
2. Use the MENU/BRIGHT dial to scroll through available options.
 - FADER - WHITE fades in or out using a white screen.
 - FADER - BLACK fades in or out using a black screen.

On-Screen Menus

- ☒ FADER - MOSAIC fades in or out with a tile-like mosaic effect.
- ☒ FADER - B/W fades into color from black and white or fades out from color to black and white.
- ☒ WIPE - CORNER wipes in from black from the upper right to the lower left or wipes out from lower left to upper right leaving a black screen.
- ☒ WIPE - WINDOW starts in the center of black and wipes out towards the corners, or comes in from the corners gradually wiping to the center.
- ☒ WIPE - SLIDE wipes in from right to left or out from left to right.
- ☒ WIPE - DOOR two black halves wipe open left and right, or close from left and right.
- ☒ WIPE - SCROLL the scene wipes in from bottom to top, or wipes out from top to bottom.
- ☒ WIPE - SHUTTER wipes in from the center of black toward the top and bottom, or wipes out from top and bottom toward the center.
- ☒ DISSOLVE the new scene gradually appears as the old one gradually disappears.
- ☒ WIPE - CORNER new scenes wipe in over previous ones from the upper right to lower left.
- ☒ WIPE - WINDOW new scenes gradually wipe in from the center of previous ones to the corners.
- ☒ WIPE - SLIDE a new scene will gradually wipe in over the previous one from right to left.
- ☒ WIPE - DOOR the previous scene wipes out from left and right, like a door being pushed open to reveal the next scene.
- ☒ WIPE - SCROLL new scenes wipe in over previous ones from bottom to the top.
- ☒ WIPE - SHUTTER new scenes wipe in over the preceding one from the center toward top and bottom.
- ☒ RANDOM when activated, the camcorder randomly selects the effect used for transitions. Picture wipe/dissolve is not available.

On-Screen Menus

Program AE with Special Effects

Your digital camcorder offers a variety of special effects to add a professional touch to recordings.

Note: Program AE with special effects can be changed during recording or during record-standby modes.

To Open the PROGRAM AE menu:

1. Rotate the MENU/BRIGHT dial to highlight the P.AE/EFFECT icon (📺). Press in the MENU/BRIGHT dial to highlight the submenu.
2. Rotate the MENU/BRIGHT dial to scroll through available choices.

☾ **TWILIGHT** makes evening scenes look more natural. White balance is initially set to ☀, but can be changed to a preferred setting. When twilight is selected, the camcorder automatically adjusts the focus from about 32 feet to infinity. From less than 32 feet, adjust the focus manually.

☑ **SEPIA** recorded scenes have a brownish tint like old photos. Combine this with the cinema mode for a classic look.

B/W **MONOTONE** footage is shot in classic black and white. Used together with Cinema mode, it enhances the classic film effect.

📷 **CLASSIC FILM** gives recordings a strobe effect.

📷 **STROBE** recordings look like a series of consecutive snapshots.

📷 **VIDEO ECHO** adds a ghosted image to the subject. Zoom magnification over 10X is not available.

SLOW **SLOW SHUTTER** lights dark subjects or areas even brighter than they would be under good natural lighting. Use **SLOW** only in dark environments.

⚙️ **SLOW 4X** the shutter speed is set to 1/15 of a second to quadruple the sensitivity.

⚙️ **SLOW 10X** the shutter speed is set to 1/6 of a second to provide ten times the sensitivity. Note that images take on a strobe-like effect. If the manual focus indicator blinks, adjust focus manually or use a tripod.

SHUTTER Variable Shutter Speed

1/60 shutter speed is fixed to 1/60 of a second. Black bands that normally appear when shooting a TV screen become narrower.

1/100 the shutter speed is fixed at 1/100 of a second. The flickering that occurs when shooting under a fluorescent light or mercury-vapor lamp is reduced.

Continues on next page

SHUTTER Variable Shutter Speed

1/250, 1/500 allows for fast-moving images to be captured one frame at a time for vivid, stable slow-motion playback. The faster the shutter speed, the darker the picture becomes. Use the shutter function under good lighting conditions.

Exposure Control

Manual exposure adjustment is recommended for the following conditions:

- When using reverse lighting or when the background is too bright.
- When shooting a reflective, natural background such as at the beach or when skiing.
- When the background is overly dark or the subject is overly bright.

To Adjust Exposure Control:

1. Rotate the MENU/BRIGHT dial to highlight the EXPOSURE icon (☰). Press in the MENU/BRIGHT dial to highlight the submenus.
2. Rotate the MENU/BRIGHT dial to highlight *MANUAL*. Press in the MENU/BRIGHT dial to select it. The menu screen disappears. *EXP.* appears on screen as well as the plus-or-minus indicator.
3. Rotate the MENU/BRIGHT dial toward + to brighten the image, or towards – to darken the image (maximum of plus or minus 6).

4. Press in the MENU/BRIGHT dial to set the exposure adjustment. *EXP.* and the highlight bar on the plus-or-minus indicator disappear.

To Return to Automatic Exposure Control:

Select *AUTO* in step 2, or set the Power Switch to automatic (A) record.

Notes:

To brighten the subject quickly, press the BACKLIGHT button on top of the camera (this is also the rewind button). The ☒ icon is displayed and the subject is brightened. If pressed again, ☒ disappears and the brightness returns to the previous level.

A +3 exposure value has the same effect as using the backlight button.

Using backlight may cause the light around the subject to become too bright and the subject too overexposed.

Backlight compensation is also available in automatic (A) record mode, manual exposure control is not.

Pressing the backlight button has no effect when exposure is set to *MANUAL*.

Iris Lock

The iris controls the amount of light that enters the camcorder.

Use Iris Control in the following situations:

- When shooting a moving subject.
- When the distance to the subject changes (so its size in the LCD monitor or viewfinder changes), such as when a subject is backing away.

On-Screen Menus

- When shooting a reflective, natural background such as at the beach or when skiing.
- When shooting subjects under a spotlight.
- When zooming.

When the subject is close, keep the iris locked. Even when the subject moves away from the camcorder, the image will not darken or lighten.

Setting Iris Lock:

1. Rotate the MENU/BRIGHT dial to highlight the EXPOSURE icon (☰). Press in the MENU/BRIGHT dial to highlight the submenu.
2. Rotate the MENU/BRIGHT dial to highlight *MANUAL*. Press in the MENU/BRIGHT dial to select it. The menu screen disappears. *EXP.* appears on screen as well as the plus-or-minus indicator.
3. Adjust zoom so the subject fills the screen, then press and hold the

MENU/BRIGHT dial for more than two seconds. The exposure control indicator and the Iris Lock icon (☑) appear.

4. Press in the MENU/BRIGHT dial and the ☑ icon changes to ☒ and the iris is locked. *EXP.* disappears.

Returning to Automatic Iris Control:

In step 2 of *Setting the Iris Lock*, rotate the MENU/BRIGHT dial to display *AUTO*. The on-screen exposure control indicator and ☑ disappear. Alternatively, you can set the Power Switch to automatic (A) record.

Locking the Exposure Control and Iris:
After step 2 of *Setting the Iris Lock*, adjust the exposure by rotating the MENU/BRIGHT dial. Then, in step 3, lock the iris.

For automatic locking, in step 2 of *Setting the Iris Lock*, select *AUTO*, and press and hold the MENU/BRIGHT dial. The iris becomes automatic after about 2 seconds.

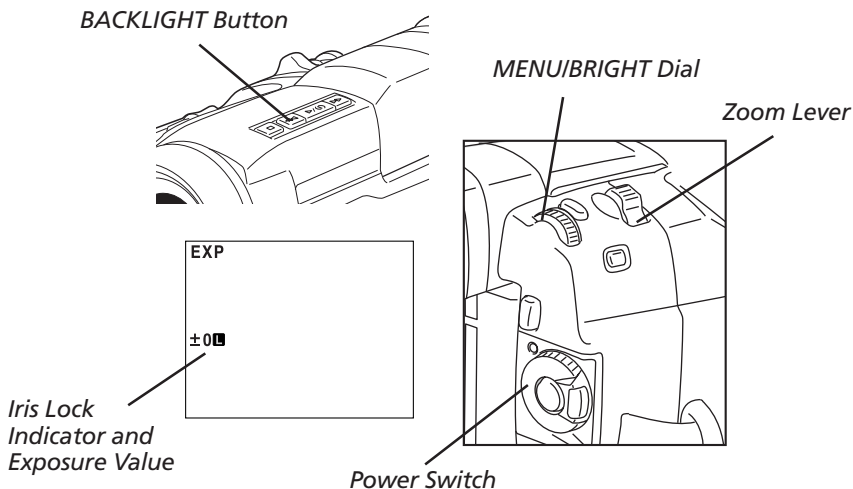

White Balance Adjustment

White balance refers to how accurate color is reproduced under various lighting conditions. If the white balance is correct, all other colors will be reproduced correctly as well.

White balance is usually adjusted automatically. Users who want more control over this function, though, can manually adjust the camcorder's white balance settings.

1. Press in the Lock Button and rotate the Power Switch to manual (M) record.
2. Press in the MENU/BRIGHT dial to display the on-screen menus.
3. Rotate the MENU/BRIGHT dial to select the *W.BAL* icon (☐). Press in the MENU/BRIGHT dial to display the submenus.
4. Rotate the MENU/BRIGHT dial to highlight the desired setting.
AUTO— white balance is automatically adjusted by the camcorder.
☑ **MAN**— white balance is set manually.
 - ☀ — outdoors, sunny day.
 - ☁ — outdoors, cloudy day.
 - 📷 — video lighting is used.
5. Press in the MENU/BRIGHT dial to make the selection.

Returning to Automatic White Balance:

In step 4, select *AUTO*, or set the Power Switch to automatic (A) record.

Note: Manual white balance cannot be used when Sepia or Monotone special effects are in use.

Manual White Balance Operation

1. To set the white balance to manual control, follow steps 1-4 in the previous section, then select the ☑ **MAN** option.
2. Hold a sheet of plain white paper in front of the subject. Adjust the zoom or move the camcorder so that the white paper fills the screen.
3. Press in the MENU/BRIGHT dial until the ☑ icon begins blinking. When the setting is complete, the ☑ icon stops blinking.
4. Press in the MENU/BRIGHT dial to complete setting manual balance. Only the manual white balance icon (☑) is displayed.

To Change the Tint for Recording:

In step 2 of *White Balance Adjustment*, substitute colored paper for white. The white balance is adjusted based on the color, changing the tint. Red paper will produce deeper greens, blue produces deeper oranges, and yellow produces deeper violets.

Notes:

It may be difficult for the camcorder to focus on a white sheet of paper. Use manual focus instead.

Because color temperature is different depending on lighting sources (natural or fluorescent light, candlelight, etc.), the subject tint will differ depending on the white balance settings. Adjusting white balance manually may produce more natural images.

Once manual white balance has been set, it remains set even if the camcorder's power is turned off or the power supply is removed.

Using the Manual Menu

Several options can be changed in the camcorder's MANUAL MENU. You can work with image stabilization, tele-macro focusing, wide mode settings, wind-sound removal, and resetting the camcorder to factory settings.

Digital Image Stabilization

Digital Image Stabilization (DIS) is used to compensate for unstable images cause by camera shake, especially at high magnifications.

Notes:

Accurate stabilization may not be possible if hand shake is excessive, or when recording:

- Subjects with vertical or horizontal stripes.
- Dark or dim subjects.
- Subjects with excessive backlighting.
- Scenes with movement in various directions.
- Scenes with low-contrast backgrounds.

Switch off DIS when the camcorder is mounted to a tripod.

The  icon blinks or disappears if DIS cannot be used.

Activating Image Stabilization:

1. Rotate the MENU/BRIGHT dial to highlight the MANUAL icon (). Press in the MENU/BRIGHT dial to highlight the submenu.
2. Rotate the MENU/BRIGHT dial to highlight *DIS*. Press in the MENU/BRIGHT dial to display the submenu.

3. Rotate the MENU/BRIGHT dial to highlight *ON*. Press in the MENU/BRIGHT dial to activate your choice.
4. To exit menus, rotate the MENU/BRIGHT dial to highlight *RETURN*. Press in the MENU/BRIGHT dial *twice* to return to normal viewing.

Tele Macro Focusing

This feature allows for focusing on objects that are very close to the camcorder. Usually the distance to a subject where the lens is in focus depends on zoom magnification. Unless there is a distance more than 3.3 feet to the subject, the lens is out of focus at the maximum telephoto setting. With tele macro set to "ON," you can shoot a subject as large as possible at a distance of approximately two feet.

Activating Tele Macro:

1. Rotate the MENU/BRIGHT dial to highlight the MANUAL icon (). Press in the MENU/BRIGHT dial to highlight the submenu.
2. Rotate the MENU/BRIGHT dial to highlight *TELE MACRO*. Press in the MENU/BRIGHT dial to display the submenu.
3. Rotate the MENU/BRIGHT dial to highlight *ON*. Press in the MENU/BRIGHT dial to activate your choice.
4. To exit menus, rotate the MENU/BRIGHT dial to highlight *RETURN*. Press in the MENU/BRIGHT dial *twice*.

On-Screen Menus

Wide Mode

Caution: Do not use wide screen modes unless you have a compatible 16X9 TV. When played on a regular TV, CINEMA mode creates black bars in the picture.

The camcorder lets you make recordings compatible with the 16X9 (wide screen) format. When Wide Mode is activated, the camcorder records black bars at the top and bottom of the picture to produce the wide-screen effect. This is also known as “letterbox” recording.

1. Push in the thumb trigger and rotate et the Power Switch to manual (M) record.
2. Press in the MENU/BRIGHT dial to display the on-screen menus.
3. Rotate the MENU/BRIGHT dial to highlight the MANUAL icon (M). Press in the MENU/BRIGHT dial to select it.

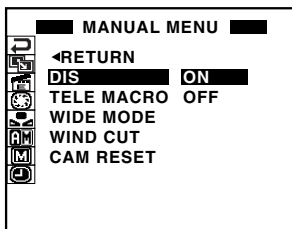

4. Rotate the MENU/BRIGHT dial to highlight *WIDE MODE*. Press in the *MENU/BRIGHT* dial to select it.

5. Rotate the MENU/BRIGHT dial to highlight *OFF*, *CINEMA*, or *SQUEEZE*.
 - Select *OFF* to record in normal mode suitable for standard TVs.



- Select *CINEMA* to insert black bands on the top and bottom of the screen.



Note: During playback on wide screen TVs, the black bands are cut and the screen ratio becomes 16X9. A □ icon will appear in the camcorder’s LCD or viewfinder. During playback/recording on a standard 4X3 TVs, viewfinders, or monitors, black bands appear like a letterbox 16X9 movie.

- Select *SQUEEZE* for playback on TVs with a 16X9 aspect ratio. This naturally expands the image to fit the screen without distortion. A □ icon appears on the camcorder’s LCD or viewfinder. In this mode, playback on a standard 4X3 TV, monitor, or viewfinder will display an elongated image.

On-Screen Menus



6. When the right choice is highlighted, press in the MENU/BRIGHT dial *twice* to activate your selection and exit the menus.

New 16x9 TV Screen

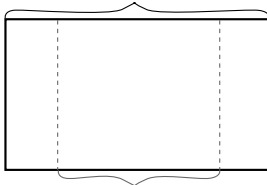

Standard Shape TV Screen

Cutting Wind Noise

To help cut down on the noise created by wind when shooting outside, use the Wind Cut feature.

Note: When using wind cut, the sound quality changes. This is normal.

Activating Wind Cut:

1. Rotate the MENU/BRIGHT dial to highlight the MANUAL icon (M). Press in the MENU/BRIGHT dial in to highlight the submenu.
2. Rotate the MENU/BRIGHT dial to highlight *WIND CUT*. Press in the MENU/BRIGHT dial to display the submenu.
3. Rotate the MENU/BRIGHT dial to highlight either *ON* or *OFF*. Press in the MENU/BRIGHT dial to activate the choice.

4. To exit menus, rotate the MENU/BRIGHT dial to highlight MENU/RETURN. Press in the MENU/BRIGHT dial *twice* to return to normal viewing.

Resetting Camcorder Defaults

If you ever want to set the camcorder back to its original factory settings, use the CAM RESET function.

1. Rotate the MENU/BRIGHT dial to highlight the MANUAL icon (M). Press in the MENU/BRIGHT dial in to highlight the submenu.
2. Rotate the MENU/BRIGHT dial to highlight *CAM RESET*. Press in the MENU/BRIGHT dial to display the submenu.
3. Rotate the MENU/BRIGHT dial to highlight either *CANCEL* or *EXECUTE*. Press in the MENU/BRIGHT dial to activate the highlighted choice.
4. To exit menus, rotate the MENU/BRIGHT dial to highlight MENU/RETURN. Press in the MENU/BRIGHT dial *twice* to return to normal viewing.

Using the Camera Menu

Several options can be changed in the camcorder's CAMERA MENU. You can adjust recording speed, sound mode, zoom, gain up, tally light, computer ID number, demonstration mode and side LED settings from the CAMERA MENU.

Recording Mode

Your camcorder can record in either Standard Play (SP) or Long Play (LP) speed. In SP mode, a 30 minute tape will record for 30 minutes whereas the same tape will record 45 minutes in LP speed. LP speed decreases the quality of recordings.

Setting the Recording Speed:

1. Rotate the MENU/BRIGHT dial to highlight the CAMERA MENU icon (CAM). Press in the MENU/BRIGHT dial to highlight the submenus.
2. Rotate the MENU/BRIGHT dial to highlight *REC MODE*. Press in the MENU/BRIGHT dial to display the submenus.
3. Rotate the MENU/BRIGHT dial to highlight either *SP* or *LP*. Press in the MENU/BRIGHT dial to activate the choice.
4. To exit menus, rotate the MENU/BRIGHT dial to highlight *RETURN*. Press in the MENU/BRIGHT dial *twice* to return to normal viewing.

Sound Mode

The digital camcorder can record in either 12-bit or 16-bit sound. Both modes will record stereo sound, but the 12-bit mode will record in four separate channels whereas 16-bit mode records in two. Using 12-bit sound is recommended with audio dubbing and is the factory preset for the camcorder.

Setting the Sound Mode:

1. Rotate the MENU/BRIGHT dial to highlight the CAMERA MENU icon (CAM). Press in the MENU/BRIGHT dial to highlight the submenus.
2. Rotate the MENU/BRIGHT dial to highlight *SOUND MODE*. Press in the MENU/BRIGHT dial to display the submenus.
3. Rotate the MENU/BRIGHT dial to highlight either *12 BIT* or *16 BIT*. Press in the MENU/BRIGHT dial to activate the choice.
4. To exit menus, rotate the MENU/BRIGHT dial to highlight *RETURN*. Press in the MENU/BRIGHT dial *twice* to return to normal viewing.

Zoom Mode

This digital camcorder can magnify images up to 250 times (250X) the normal view using digital interpretation. There is also an optical zoom, the amount actually supported by the camcorder's lens, of up to 10 times (or 10X).

Selecting Zoom Mode:

1. Rotate the MENU/BRIGHT dial to highlight the CAMERA MENU icon (CAM). Press in the MENU/BRIGHT dial to highlight the submenus.
2. Rotate the MENU/BRIGHT dial to highlight *Zoom*. Press in the MENU/BRIGHT dial to display the submenus.
3. Rotate the MENU/BRIGHT dial to highlight the desired setting.

On-Screen Menus

- **10X** the maximum optical zoom. If the camcorder is using digital zoom and then is set to 10X zoom mode, the magnification will reset.
 - **40X** allows use of digital zoom. By digitally processing and magnifying images, zooming is possible from 10X (the optical limit) to 40X.
 - **250X** allows use of digital zoom. By digitally processing and magnifying images, zooming is possible from 10X (the optical limit) to 250X.
4. Press in the MENU/BRIGHT dial to activate the choice.
 5. To exit menus, rotate the MENU/BRIGHT dial to highlight *RETURN*. Press in the MENU/BRIGHT dial *twice* to return to normal viewing.

Gain Up

This camcorder allows you to adjust the shutter speed to compensate for various recording settings.

Setting Gain Up:

1. Rotate the MENU/BRIGHT dial to highlight the CAMERA MENU icon (CAM). Press in the MENU/BRIGHT dial to highlight the submenus.
2. Rotate the MENU/BRIGHT dial to highlight *GAIN UP*. Press in the MENU/BRIGHT dial to display the submenus.
3. Rotate the MENU/BRIGHT dial to highlight the desired setting.

- **OFF** allows shooting of dark scenes with no picture brightness.
 - **AGC** the overall appearance may be grainy, but the image is bright.
 - **AUTO** (A) the shutter speed is automatically adjusted (1/30 – 1/200 of a second). Shooting a subject in low or poor lighting at 1/30 of a second provides a brighter image than in the AGC mode, but the subject's movements are not as smooth or natural. The overall appearance may be grainy. When the shutter is automatically adjusted, the A icon appears in the LCD or viewfinder.
4. Press in the MENU/BRIGHT dial to activate the choice.
 5. To exit menus, rotate the MENU/BRIGHT dial to highlight *RETURN*. Press in the MENU/BRIGHT dial *twice* to return to normal viewing.

Tally Light

The tally light on the front of the camcorder comes on to signal the start of recording. You can turn this light on or off.

Turning the Tally Light On or Off:

1. Rotate the MENU/BRIGHT dial to highlight the CAMERA MENU icon (CAM). Press in the MENU/BRIGHT dial to highlight the submenus.

2. Rotate the MENU/BRIGHT dial to highlight *TALLY*. Press in the MENU/BRIGHT dial to display the submenus.
3. Rotate the MENU/BRIGHT dial to highlight either *ON* or *OFF*.
4. Press in the MENU/BRIGHT dial to activate the choice.
5. To exit menus, rotate the MENU/BRIGHT dial to highlight *RETURN*. Press in the MENU/BRIGHT dial *twice* to return to normal viewing.

ID Number

In order to connect the camcorder to a device such as a video editor using the Service Terminal, a unique ID number must be assigned. The numbers available range from 01 to 99. The factory default setting is 06.

Setting the ID Number:

1. Rotate the MENU/BRIGHT dial to highlight the CAMERA MENU icon (CAM). Press in the MENU/BRIGHT dial to highlight the submenus.
2. Rotate the MENU/BRIGHT dial to highlight *ID NUMBER*. Press in the MENU/BRIGHT dial to display the submenu.
3. Rotate the MENU/BRIGHT dial to highlight the desired number.
4. Press in the MENU/BRIGHT dial to activate the choice.
5. To exit menus, rotate the MENU/BRIGHT dial to highlight *RETURN*. Press in the MENU/BRIGHT dial *twice* to return to normal viewing.

Demo Mode

The camcorder can demonstrate certain functions such as Program AE with special effects, and can be used to confirm how these functions work using Demo Mode.

When Demo Mode is turned on and the menu screen is exited, a display of the camera's features begins.

Notes:

Performing any action during demonstration mode stops the demonstration temporarily. If no operation is performed for more than one minute after action has ceased, Demo Mode starts back up.

If a cassette is in the camcorder, the demonstration cannot be turned on.

Demo Mode stays on, even if the camcorder's power is turned off.

Some functions are not available when Demo Mode is turned on. After viewing the demonstration, turn off Demo Mode.

Accessing Demo Mode:

1. Rotate the MENU/BRIGHT dial to highlight the CAMERA MENU icon (CAM). Press in the MENU/BRIGHT dial to highlight the submenus.
2. Rotate the MENU/BRIGHT dial to highlight *DEMO MODE*. Press in the MENU/BRIGHT dial to display the submenus.
3. Rotate the MENU/BRIGHT dial to highlight either *ON* or *OFF*.
4. Press in the MENU/BRIGHT dial to activate the choice.
5. To exit menus, rotate the MENU/BRIGHT dial to highlight *RETURN*. Press in the MENU/BRIGHT dial *twice* to return to normal viewing.

On-Screen Menus

Exiting Demo Mode:

In step 3 from *Accessing DEMO MODE*, select *OFF* or insert a videocassette.

Side LED

The camcorder's side LED indicator can light up when the power switch is set to either automatic (A) or manual (M) record mode.

Accessing Side LED Mode:

1. Rotate the MENU/BRIGHT dial to highlight the CAMERA MENU icon (CAM). Press in the MENU/BRIGHT dial to highlight the submenus.
2. Rotate the MENU/BRIGHT dial to highlight *SIDE LED*. Press in the MENU/BRIGHT dial to display the submenus.
3. Rotate the MENU/BRIGHT dial to highlight either *ON* or *OFF*.
4. Press in the MENU/BRIGHT dial to activate the choice.
5. To exit menus, rotate the MENU/BRIGHT dial to highlight *RETURN*. Press in the MENU/BRIGHT dial *twice* to return to normal viewing.

Using the Display Menu

Several important options are addressed in the DISPLAY MENU. Here, you can set how icons, the date and time, and time code are displayed. You can also set the date and time.

On-Screen Displays

You can set what information is shown on which displays the camcorder is using, including the LCD monitor, viewfinder, or even a TV screen.

Accessing On Screen Settings:

1. Rotate the MENU/BRIGHT dial to highlight the DISPLAY MENU icon (DIS). Press in the MENU/BRIGHT dial in to highlight the submenus.
2. Rotate the MENU/BRIGHT dial to highlight *ON SCREEN*. Press in the MENU/BRIGHT dial to display the submenus.
3. Rotate the MENU/BRIGHT dial to highlight your selection.
 - **LCD** keeps indicators (except the date, time, and time code) from appearing on a connected TV screen.
 - **LCD/TV** makes indicators appear on screen when connected to a TV.
 - **SIMPLE** shows only a basic display including the tape running indicator, warning indicators, date, time, etc. Also keeps the camcorder's display (except date, time, and time code) from appearing on a connected TV monitor.
4. Press in the MENU/BRIGHT dial to activate the highlighted choice.
5. To exit menus, rotate the MENU/BRIGHT dial to highlight *RETURN*. Press in the MENU/BRIGHT dial *twice* to return to normal viewing.

Date and Time Display

You can turn the date and time display on or off on the camcorder.

1. Rotate the MENU/BRIGHT dial to highlight the DISPLAY MENU icon (☐). Press in the MENU/BRIGHT dial in to highlight the submenus.
2. Rotate the MENU/BRIGHT dial to highlight *DATE/TIME*. Press in the MENU/BRIGHT dial to display submenus.
3. Rotate the MENU/BRIGHT dial to highlight either *ON* or *OFF*.
4. Press in the MENU/BRIGHT dial to activate the highlighted choice.
5. To exit menus, rotate the MENU/BRIGHT dial to highlight *RETURN*. Press in the MENU/BRIGHT dial *twice* to return to normal viewing.

Time Code

The time code stamp helps determine where the cassette is positioned. A time code is always recorded, but does not appear on the image itself, only on-screen.

If a recording starts at a blank portion of the tape, the time code begins counting from 00:00:00 (minute:second:frame). If a recording starts from the end of a previously recorded scene, the time code continues from the last time code number. If a blank portion of a tape is left part way through a recording, the time code is interrupted. When recording resumes, the time code starts counting again from 00:00:00.

Accessing Time Code Settings:

1. Rotate the MENU/BRIGHT dial to highlight the DISPLAY MENU icon (☐). Press in the MENU/BRIGHT dial.
2. Rotate the MENU/BRIGHT dial to highlight *TIME CODE*. Press in the MENU/BRIGHT dial to highlight the submenus.
3. Rotate the MENU/BRIGHT dial to highlight either *ON* or *OFF*.
4. Press in the MENU/BRIGHT dial to activate the highlighted choice.
5. To exit menus, rotate the MENU/BRIGHT dial to highlight *RETURN*. Press in the MENU/BRIGHT dial *twice* to return to normal viewing.

Clock Adjustment

To Set the Current Date and Time:

1. Rotate the MENU/BRIGHT dial to highlight the DISPLAY MENU icon (☐). Press in the MENU/BRIGHT dial.
2. Rotate the MENU/BRIGHT dial to highlight *CLOCK ADJ*. Press the MENU/BRIGHT dial to highlight the submenus.
3. Rotate the MENU/BRIGHT dial to change numbers. Press in the MENU/BRIGHT dial to advance to the next field. Repeat as necessary.
4. To exit menus, rotate the MENU/BRIGHT dial to highlight *RETURN*. Press in the MENU/BRIGHT dial *twice* to return to normal viewing.

Recording Details

To get the most out of your camcorder, make sure to review this chapter. Here you will find out about the camcorder's built-in color-enhancement light, about focusing, and about Snapshot mode.

Video Light

To brighten the scene when natural lighting is too dim, the camcorder uses a built-in video light.

The video light can be turned on at all times, set to turn on automatically when the camcorder senses additional light is needed, or turned off altogether.

Setting the Video Light:

1. Press and hold the OPEN HERE latch and open the LCD monitor. This reveals the LIGHT OFF/AUTO/ON switch.
2. Move the switch to the desired setting.
 - **OFF** turns off the light.
 - **AUTO** Automatically allows the camcorder to turn on the light when there is insufficient lighting on the subject.
 - **ON** keeps the light on at all times as long as the camcorder is turned on.

Notes:

The video light can only be used when the camcorder is on.

It is recommended that you set the white balance to artificial light (☀) when using the video light.

When not using the video light, turn it off to save battery power.

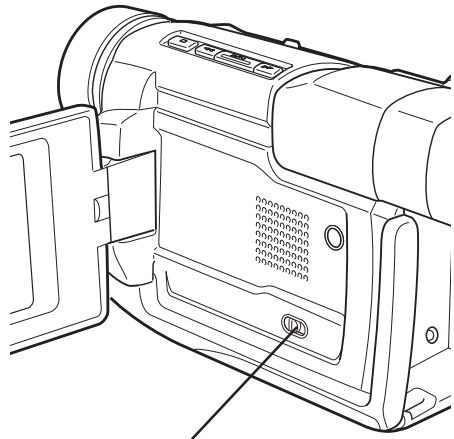

*LIGHT OFF/AUTO/ON switch
(open the LCD monitor to access)*

Cautions

Never operate the video light closer than one foot to people or other objects.

The video light becomes very hot. Do not touch it during operating or right after use. Serious injury may result.

Do not place the camcorder in a carrying case right after using the light.

Never operate the video light close to flammable or explosive material.

Recording

Warning

The video light and bulb need to cool for approximately 30 minutes after the camcorder has been used before the bulb assembly is replaced.

Do not touch the light bulb with your fingers. If the bulb is accidentally touched, wipe it with a soft cloth. A dirty bulb may cause smoke and have a reduced service life.

Video Light Details

Even if the battery indicator () does not blink due to low battery charge, the camcorder may turn off automatically when you turn on the video light, or if the video light is turned on when you start a recording.

- When LIGHT OFF/AUTO/ON switch is set to *AUTO*:
 - The video light may keep turning on and off depending on the lighting conditions. If this happens, manually switch the light ON or OFF using the LIGHT OFF/AUTO/ON switch.
 - If Slow Shutter mode is turned on, the video light is likely to stay on.
 - While in Twilight mode, the light will not activate.
 - To replace the video light, It is recommended that you consult your nearest camcorder dealer.

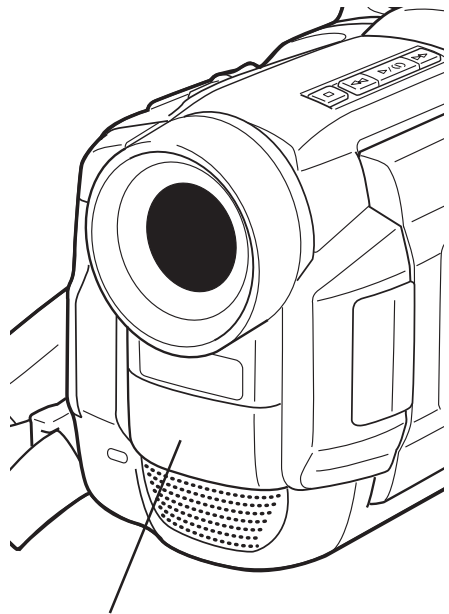

Video Light

Recording

Camcorder Focus





Your digital camcorder can be set to automatically focus images, or you can manually set the focus.

Auto Focus

The full-range auto focus system offers continuous shooting ability from close up (as near as approximately 2 inches from the subject) to the horizon.

Correct focus may not be possible when:

- Two subjects overlap in the same scene.
- Illumination is low.
- The subject has no contrast (difference in brightness and darkness), such as a flat, one-color wall, or a clear, blue sky.
- A dark object is barely visible in the viewfinder.
- A scene contains minute or identical patterns that are regularly repeated.
- The scene is affected by sunbeams or light reflecting off the surface of a body of water.
- Shooting a scene with a high-contrast background.

Note: The   and   icons are low-contrast warnings that appear on screen and blink when there is a problem with illumination or contrast.

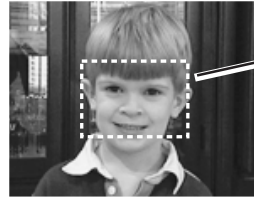

Focus detection zone



Focus indicators tell whether the camcorder is focusing on the foreground or background

Notes:

If the lens is smeared or blurred, accurate focusing may not be possible. Keep the lens clean, wiping it with a soft cloth. When condensation occurs, wipe lens with a soft cloth or wait for it to dry naturally.

When shooting a subject close to the lens, zoom out first. If you zoom in auto focus mode, the camcorder may automatically zoom back out depending on the distance between the camcorder and the subject. This will not occur when TELE MACRO is activated.

Recording

Manual Focus

Follow these steps to focus the camcorder's lens manually:

1. Adjust the viewfinder's Diopter Adjustment Control to assure that the viewfinder's image is crisp.
2. Press in the Thumb Lock and rotate the Power Switch to manual (M) record.
3. Press the FOCUS button (also the fast forward [▶▶] button) on top of the camcorder. The manual focus indicator (👤▲) appears on screen.
3. To focus on a subject further away, rotate the MENU/BRIGHT dial clockwise (towards +). The ▶ icon appears on screen and blinks. To focus on a subject near the camcorder, rotate the MENU/BRIGHT dial counterclockwise (towards -). The ◀ icon appears and blinks.
4. Press in the MENU/BRIGHT dial.

To Reset Auto Focus:

Press the FOCUS button (▶▶) twice or set the Power Switch to automatic (A) record. If FOCUS (▶▶) is pressed once, the camcorder will enter the Focus Adjustment mode again.

Notes:

Be sure to focus the lens in the maximum telephoto position when using manual focus.

If you focus in on a subject in wide-angle position, sharply focused images cannot be obtained when zoomed on because the depth-of-field is reduced at longer focal lengths.

When the focus level cannot be adjusted any further or closer, 👤 or ▲ will blink.

Snapshot Feature

The Snapshot feature captures still images that look like photographs recorded onto a cassette.

Note: When pressing the SNAPSHOT button in every mode except Multi-4 or Multi-9, a camera shutter sound effect can be heard.

To Select a Snapshot Mode:

1. Press the Thumb Lock in and rotate the Power Switch to record (either A or M).
2. Choose the appropriate Snapshot mode from the five available by pressing the camera's MODE button until the desired effect appears on screen.

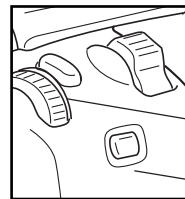

- **FRAME** places a snapshot within a frame.



- **FULL** takes a snapshot with no frame.



- **MULTI-4** takes four snapshots in a quick progression (giving the illusion of movement) and places all four images within one shot.



- **MULTI-9** takes nine snapshots in a quick progression (giving the illusion of movement) and places all nine images within one shot.



- **PIN-UP** places a snapshot on top of a shadow effect. The image and shadow are placed within a frame.



Digital and Optical Zooming

You can zoom in and out for close-up or wide-angle shots just by moving the zoom lever on the camcorder. The camcorder automatically focuses at most distances when zooming. Optical zooming is possible up to 10 times, and digital zooming allows up to 250 times normal magnification.

Using the Zoom Lever (*W* and *T*)

To zoom in tight (telephoto) or out wide (wide angle), rotate the zoom lever to either *T* or *W*.

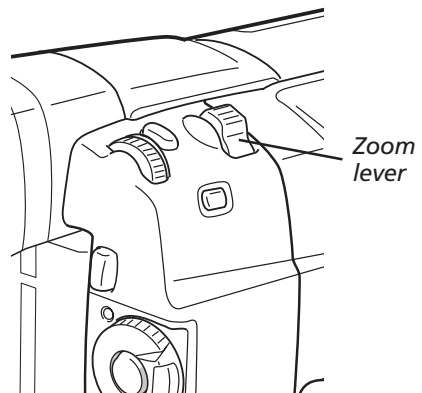

Recording

With tele photo zooming it is possible to capture images to a maximum of 250 times normal magnification. To do this, the camcorder uses technology to artificially enhance the image (*see pages 38-39 for details*).

Note: see pages 38-39 for details on selecting a digital zoom mode.

- For close-up telephoto zoom, rotate the zoom lever toward *T*.

Optical zoom (*see pages 38-39 for details*) is the natural, non-enhanced magnification that the camcorder's lens will support. This digital camcorder has an optical zoom of 10 times (10X).

- For a wide angle zoom, rotate the lever toward *W*.

When using the zoom lever, an indicator appears on screen to display the approximate zoom ratio.

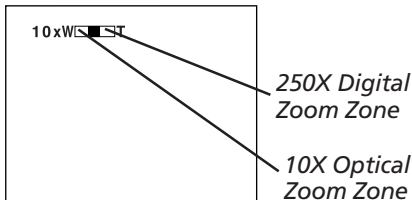

Notes:

While zooming, focusing may become unstable. If so, set the zoom while in record-standby mode and adjust the image using manual focus (*see page 46 for details*). Once the focus is set, zoom the camcorder in or out while recording.

During digital zoom, the quality of image may suffer.

Digital zoom cannot be used when image enhancement effects, such as picture wipe/dissolve (*see pages 29-30*), or video echo (*see page 31*), are being used.

Tele macro focusing (as close as two inches from the subject) is possible when the zoom lever is set all the way to *W* (*see also Tele Macro on page 35*).

Playback Options

The camcorder's playback features include displaying still images, high-speed shuttle search, and frame-by-frame playback. In this section, you will also learn how to connect your camcorder to a TV, VCR, or computer.

Playback features (PLAY, PAUSE, FORWARD, REVERSE, STOP) can be handled using the camcorder's buttons.

This camcorder can also be controlled by most RCA, GE, or PROSCAN universal remote controls using the VCR2 button. Such remotes without a VCR2 button should be able to be programmed to control the camcorder using the AUX button. See the manual that accompanied the universal remote for details on programming it).

Note: See the Accessories section for more information about ordering an optional remote control.

Basic Playback

1. Insert a Mini DV cassette.
2. Press in the Lock Button and rotate the Power Switch to playback (PLAY) mode.
3. Press the Play-Pause Button (▶/⏸) to start playback.
 - To stop playback, press the Stop Button (■).
 - Press the Rewind Button (◀◀) to reverse playback direction, or the Fast Forward Button (▶▶) to advance the tape while in stop mode.

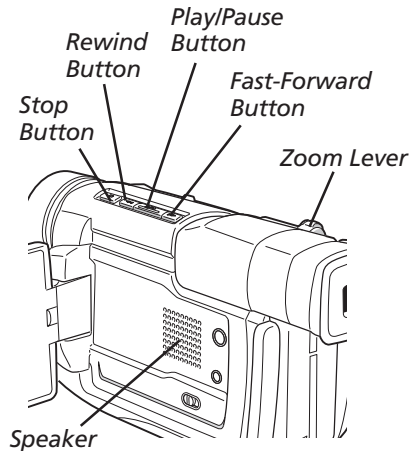

Controlling Speaker Volume



Slide the Power Zoom Lever (VOL.) towards + to turn up the volume, or towards - to turn down the volume.

Notes:

If stop mode continues for five minutes when power is supplied from a battery, the camcorder shuts off automatically to conserve power. To turn the camcorder on again, set the Power Switch to OFF, then to back to playback (PLAY) mode.

The playback picture can be viewed in the LCD monitor, viewfinder or on a connected TV.

LCD monitor/viewfinder indications:

- When power is supplied from a battery the  icon is displayed. When power is supplied through the DC cord, the  icon does not appear.
- When a tape is stopped, no indicators are displayed.

When a cable is connected to the Audio/Video jacks, no sound is heard from the speaker.

Still Playback Mode

Still playback pauses the tape, freezing a single frame on the display.

Activating Still Playback:

1. Press the Play/Pause Button (▶/⏸) during playback to freeze the image.
2. To resume normal playback, press the Play/Pause Button again.
 - If still playback continues for more than a few minutes, the camcorder's stop mode is automatically engaged.
 - After approximately five minutes in stop mode, the power turns off to conserve power.
 - When the Play/Pause Button is pressed, the image may not freeze immediately. The camcorder takes a moment to stabilize the still image.

Shuttle Search

Allows high-speed searching in either forward or reverse directions.

Activating Shuttle Search:

1. Press the Fast-Forward Button (▶▶) or the Reverse Button (◀◀) during playback.
2. To resume normal playback, press the Play/Pause Button (▶/⏸).
 - During playback, press and hold the Reverse (◀◀) or Forward (▶▶) Button. The search continues as long as the button is held. Once released, normal playback resumes.
 - A slight mosaic effect appears on screen during Shuttle Search. This is normal.

Frame-By-Frame Playback

Allows frame-by-frame searching.

1. Press the Play/Pause Button (▶/⏸) during playback to pause the image.
2. Rotate the MENU/BRIGHT dial towards + for forward frame-by-frame playback, or towards – for reverse frame-by-frame playback.
 - To resume normal playback, press the Play/Pause Button (▶/⏸).

Basic Connections

This manual includes information for some basic types of connections.

Displaying Camcorder Data on a Connected TV or VCR

- Date/Time: set *DATE/TIME* to *ON* or *OFF* in the *DISPLAY* menu.
- Time Code: set *TIME CODE* to *ON* or *OFF* in the *DISPLAY* menu.
- Playback Sound Mode, Tape Speed and Tape Running: set *ON SCREEN* to *LCD* or *SIMPLE* in the *DISPLAY MENU*.

Notes:

It is recommended to use the AC Adapter/Charger as the power supply instead of the battery pack to achieve uniform playback.

Use the provided A/V Connection Cable, making sure to connect the end with a single plug to the camcorder.

Adjust the TV sound volume to its minimum level to avoid a sudden burst of sound when the camcorder is turned on.

If you have a TV or speakers that are not specially shielded, do not place the speakers next to the TV as interference will occur in the camcorder playback picture.

Viewing Recordings on a TV Using A/V Input Jacks

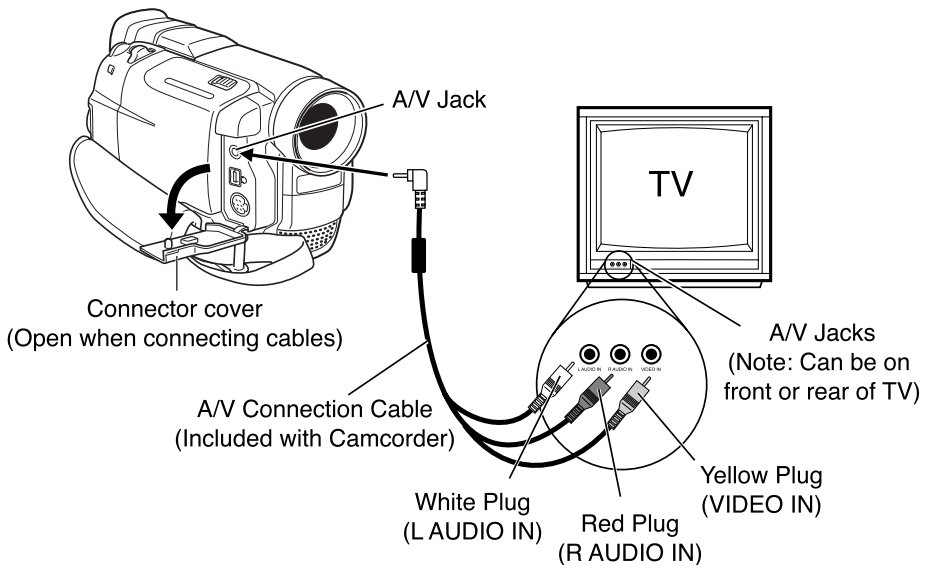

Connecting the Camcorder to a TV Using A/V Input Jacks:

1. Locate the A/V cable that came with the camcorder.
2. Make sure all units are turned off.
3. Connect the white plug of the A/V cables to the Left AUDIO IN jack (L AUDIO IN).
4. Connect the red plug of the A/V cables to the Right AUDIO IN jack (R AUDIO IN).

Note: Some TVs do not offer both left and right audio jacks. If your TV only has one audio jack, use the A/V cable's white plug for audio.

5. Connect the yellow plug of the A/V cables to the VIDEO IN jack.
6. Open the camcorder's Connector Cover.

7. Connect the A/V Connection Cable's single plug into the camcorder's A/V Jack.
8. Press in the Thumb Lock and rotate the Power Switch to playback (**PLAY**) mode.
9. Turn on the TV.
10. Tune the TV to its video input channel for viewing.
11. Press the camcorder's Play/Pause Button (**▶/||**) to begin playback.

Note: The camcorder and some TVs have an S-Video Jack which can be used for a better image quality. If using an optional S-Video Cable, it must have a core filter to meet FCC requirements.

Capturing Recordings to a VCR Using A/V Input Jacks

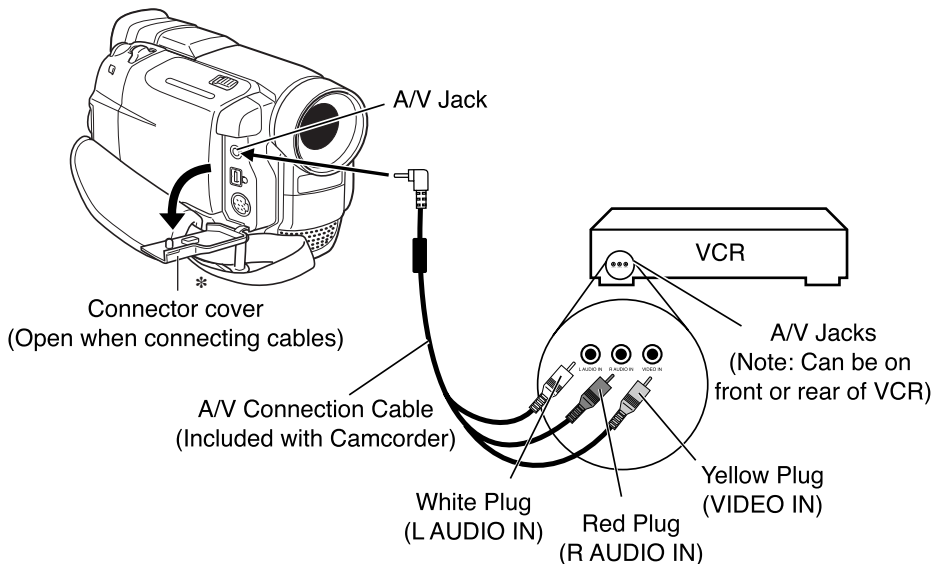

Connecting the Camcorder to a VCR Using A/V Input Jacks:

1. Locate the A/V cable that came with the camcorder.
2. Make sure all units are turned off.
3. Connect the white plug of the A/V cables to the VCR's Left AUDIO IN jack (L AUDIO IN).
4. Connect the red plug of the A/V cables to the VCR's Right AUDIO IN jack (R AUDIO IN).

Note: Some VCRs do not offer both left and right audio jacks. If your TV only has one audio jack, use the A/V cable's white plug for audio.

5. Connect the yellow plug of the A/V cables to the VCR's VIDEO IN jack.

6. Open the camcorder's Connector Cover.
7. Connect the A/V Connection Cable's single plug into the camcorder's A/V Jack.
8. Press in the Thumb Lock and rotate the Power Switch to playback (**PLAY**) mode.
9. Turn on the VCR.
10. Tune the VCR to its video input channel for viewing.
11. Insert a videotape into the VCR.
12. Press the camcorder's Play/Pause Button (**▶/⏸**) to begin playback.
13. Press the record button on the VCR to begin capture.

Playback

Connecting the Camcorder to a Computer Using IEEE 1394 Jacks

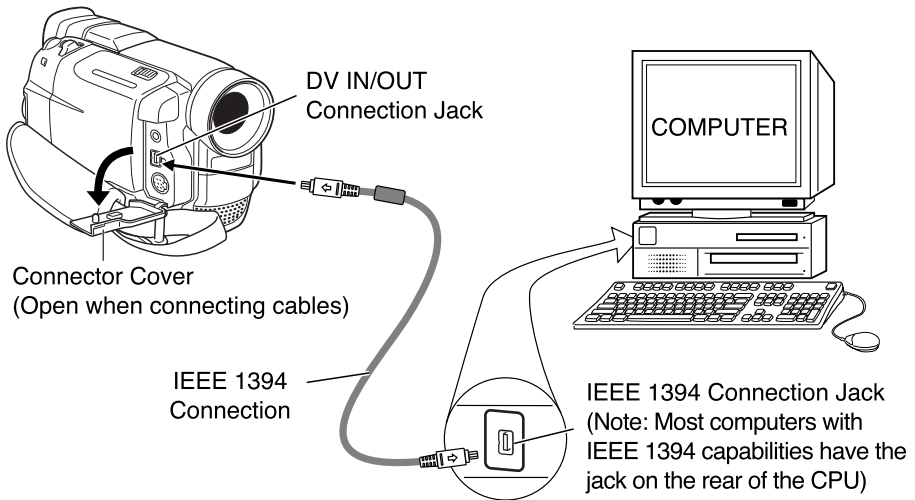

Connecting the Camcorder to a Computer Using an IEEE 1394 Jack

It is also possible to transfer video and still images to a computer equipped for digital video capture using an IEEE 1394 board.

1. Locate the IEEE 1394 cable that came with the camcorder.
2. Make sure the camcorder and computer are turned off.
3. Connect one end of the IEEE 1394 cable to your computer.
4. Connect the other end of the IEEE 1394 cable to the camcorder's DV IN/OUT jack.
5. Press in the Thumb Lock and rotate the Power Switch to playback (**PLAY**) mode.

6. Turn on the computer.
7. Follow your computer's video capture software instructions to upload the camera's data to the computer.
8. Press the camcorder's Play/Pause Button (**▶/||**) to begin playback.

Notes:

It is recommended to use the AC Adapter/Charger as the power supply instead of the battery pack for uniform playback.

Date and time information cannot be captured to a computer.

When using a DV cable, be sure it has a core filter attached. The core filter reduces interference and is required to meet FCC standards.

Connecting the Camcorder to a VCR to Capture Sound Only

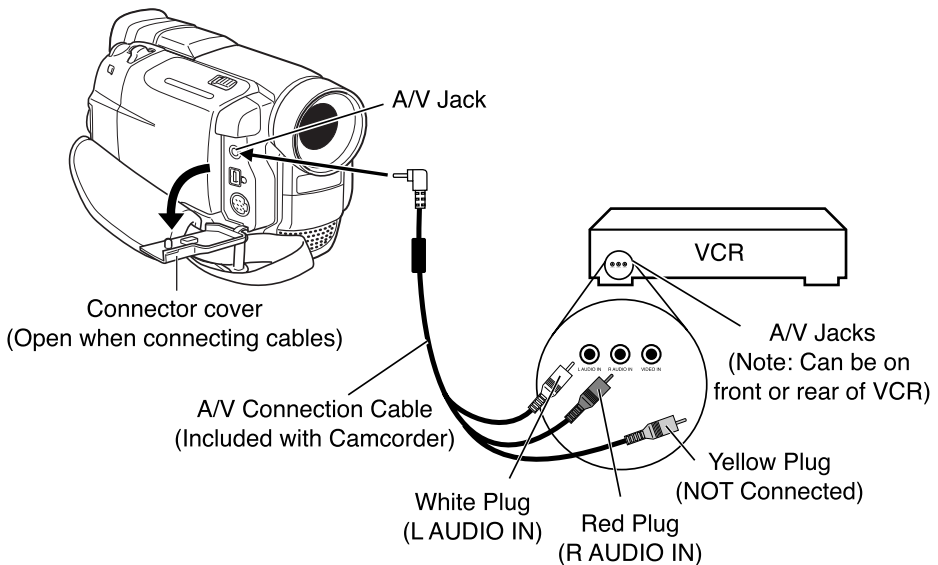

Dubbing Sound to a VCR Using A/V Input Jacks:

1. Locate the A/V cable that came with the camcorder.
2. Make sure all units are turned off.
3. Connect the white plug of the A/V cables to the VCR's Left AUDIO IN jack (L AUDIO IN).
4. Connect the red plug of the A/V cables to the VCR's Right AUDIO IN jack (R AUDIO IN).

Note: Some VCRs do not offer both left and right audio jacks. If your TV only has one audio jack, use the A/V cable's white plug for audio.

6. Open the camcorder's Connector Cover.

7. Connect the A/V Connection Cable's single plug into the camcorder's A/V Jack.
8. Press in the Thumb Lock and rotate the Power Switch to playback (**PLAY**) mode.
9. Turn on the VCR.
10. Tune the VCR to its video input channel to hear the recording.
11. Start the VCR's record mode.
12. Press the camcorder's Play/Pause Button (**▶/⏸**) to begin playback.

Playback

Dubbing to Another Digital Video Camcorder Equipped With an IEEE 1394 Connection Port

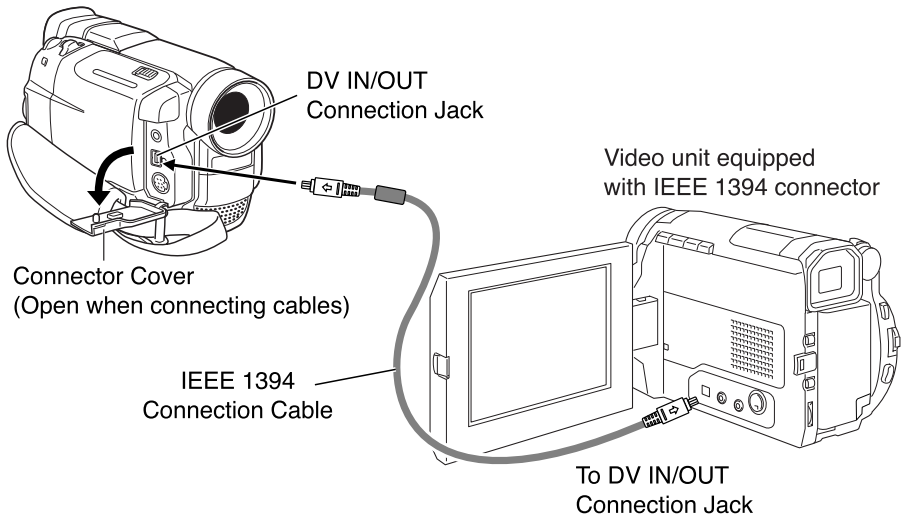

Digital Dubbing Using IEEE 1394 Jacks

When sending a digital signal from one DV device to another, there is little if any image or sound deterioration.

To Use This Camcorder as a Player:

1. Make sure the power of both camcorders is off.
2. Connect one end of the IEEE 1394 cable to each digital camcorder.
3. Press the camcorder's Play/Pause Button (▶/II) to start playback.
4. While watching the playback on the monitor, start the receiving camcorder's record mode from the spot on the source tape you want to begin recording.

Notes:

It is recommended to use the AC adapter/charger as the power supply instead of the battery pack for uniform playback.

For digital dubbing, this camcorder can be connected to only one device at a time. This camcorder can also be used as the recording camcorder.

If a blank portion or distorted image is played back during dubbing, the process may stop to avoid capturing problem images.

Even though the IEEE 1394 cable is connected correctly, sometimes the image may not appear during playback. If this occurs, turn off the power and make connections again.

When using an IEEE 1394 cable, be sure it has a core filter attached. The core filter reduces interference and is required to meet FCC standards.

Recording Tips

- Try to make sure indoor scenes are well-lit. This improves picture quality and color reproduction.
- Do not move the camcorder rapidly from side-to-side while recording. A steady, gradual “pan” avoids blurring and “jitter”.
- Use the viewfinder or LCD monitor to make sure the camcorder is level while recording so that your scene isn’t “tilted.”
- Do not bump or tap the camcorder’s microphone while recording because this sound will be recorded.
- Include close-ups of individuals when taping family outings or group functions.
- Fading in and out of scenes makes your videos appear more professional.
- Learn to use the special production effects available with your camcorder to add variety to your recordings.
- Be aware of video and audio backgrounds. Background details barely noticed while you are taping may show up as visual “clutter” on your recording. Background noises (especially TV sets, radios, household appliances, traffic sounds, etc.) might detract from the sound you want to record.

- Avoid long “still” shots of landmarks and scenic attractions. Recordings are more interesting if they include people and details. “Local color” gives travel videos lasting appeal. Consider recording a familiar or landmark scene from an unfamiliar vantage point.

Traveling Tips

- Write down your camcorder’s serial number and keep it separate from the camcorder when traveling. If your camcorder is lost or stolen, you will be able to identify it.
- Use extra care to avoid damage to your camcorder and accessories when operating them at a beach or pool. Spray, sand, and dust should be avoided. If your lens has been exposed to the elements, clean it only with proper lens cleaning supplies.
- Make sure you have any plug adapters that you might need before taking your camcorder to other countries. Consult your dealer for advice.
- Carry your camcorder in a carrying case when traveling. See the next page for a case designed especially for this camcorder. An ordinary suitcase or carry bag does not offer the protection your camcorder needs. Treat your camcorder as carry-on luggage to protect it from rough handling.

Optional Accessories

We invite you to take a look at some great ideas for sparking creativity and adding to the fun of using your digital camcorder. The following pages have a selection of accessories to help make your memorable moments look and sound even better.

These accessories are designed to make the process of recording and watching your videos more enjoyable.

To order accessories, contact your local Dealer.

If a dealer is not nearby, all accessories are available through toll-free ordering or by using the order form found on page 61.

AC201A Soft Carrying Case

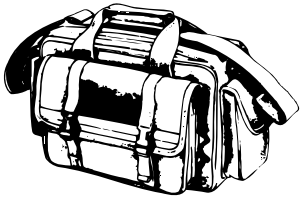

Custom compact soft case designed especially to provide protection and utility for your digital camcorder and most accessories. Rugged fabric lined with soft non-abrasive material and generous padding. Has three outside pockets with storage for lens filters, adapters, batteries, and tapes.

ACS091 Shoulder Strap

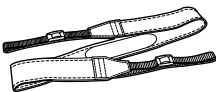

Designed to replace the shoulder strap that comes with the digital camcorder.

All specifications and descriptions of accessories are subject to change without notice.

247800 Rechargeable Battery

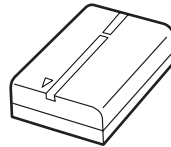

This rechargeable 2-hour, lithium-ion battery is designed specifically for long life (depending on how much you use zoom and pause). The 247800 can be recharged with the AC adapter/charger that came with the camcorder.

BB46L Extended Life Battery

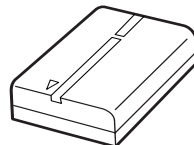

This rechargeable 2-hour, lithium-ion battery is designed specifically for long life (depending on how much you use zoom and pause). The BB46L can be recharged with the AC adapter/charger that came with the digital camcorder.

247801 AC Battery Charger

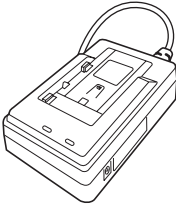

The 247801 battery charger plugs into an AC outlet and charges the 247800 or BB46L camcorder battery.

Because the 247801 operates on 100-240 Volts, 50/60 HZ, it can be used virtually anywhere in the world. A plug adapter might be required in some countries. Charging takes approximately 90 minutes for the 247800.

RCU800 Universal Remote Control

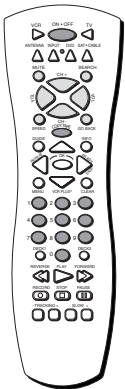

The RCU800 universal remote control is an RCA-branded unit which can control your digital camcorder using the VCR2 or AUX buttons.

244268 IEEE 1394 Cable

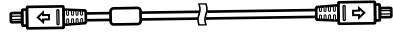

Replacement for the included IEEE 1394 connection cable. Used to attach the digital camcorder to a IEEE 1394 equipped computer with a digital video capture board installed.

244268 DC Cable

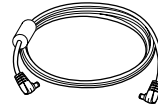

Replacement for the included DC cable. Used to attach the digital camcorder to the adapter charger.

249645 A/V Cable



Replacement for the included A/V cable. Used to attach the digital camcorder to an external component like a TV or VCR.

Using the Optional AC088 Tripod

Mounting the camcorder on a tripod, such as AC088, keeps the camcorder steady and produces excellent video results.

This tripod's fluid-effect head provides smooth camera pan and tilt. The quick-release mount makes it easy to attach or remove the camcorder. The grooved, tubular 3-section leg design folds down to 26" when not in use. Rubber feet allow for sure footing.

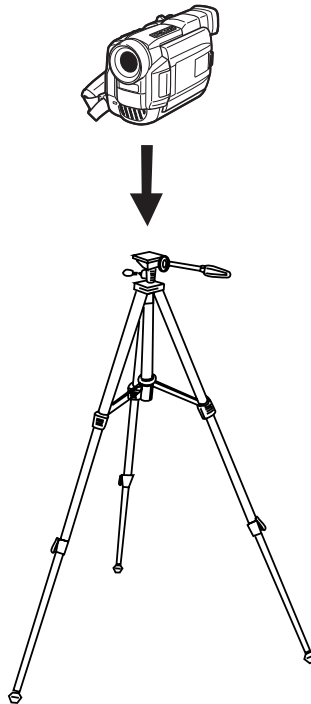

Cautions: Before using a tripod, make sure it is stable enough to hold the camcorder without falling over. Do not transport the camcorder attached to the tripod.

When attaching your camcorder to a tripod, be careful not to force the tripod screw into the camcorder's tripod mounting hole.

The tripod screw should not protrude into the camcorder more than approximately three-eighths ($3/8$) of an inch. Forcing the screw could damage the mounting hole on the bottom of the camcorder.

Accessories

Accessories Order Form (Model CC9370)

Description	Part No.	Price	Qty.	Total
Super Lightweight Tripod	AC088	\$ 49.95		
Soft Camcorder Case	AC201A	\$ 34.95		
Shoulder Strap	ACS091	\$ 12.95		
Rechargeable Battery	247800	\$ 69.95		
Extended Life Battery	BB46L	\$ 69.95		
AC Adapter/Charger	247801	\$ 89.95		
A/V Cable	249645	\$ 9.95		
DC Cable	244268	\$ 28.60		
IEEE 1394 Connection Cable	249644	\$ 39.95		
RCA Universal Remote Control	RCU800	\$ 39.95		

All prices subject to change without notice.

Total Merchandise \$ _____

Sales Tax \$ _____

We are required by law to collect the appropriate sales tax for each individual state, county, and locality to which the merchandise is being sent.

Shipping and Handling \$ **5.00** _____

Total Amount Enclosed \$ _____

Use VISA, MasterCard, or Discover.
Money order or check must be in U.S. currency only. No COD or cash.

Please complete other side also

Detach Here



Charge your order on your VISA, MasterCard,
or Discover Card by filling in below

USE YOUR CREDIT CARD

IMPORTANT: Copy complete account number from your VISA card

Expiration date:



IMPORTANT: Copy complete account number from your MasterCard



Copy Number above your name on MasterCard Expiration date:

IMPORTANT: Copy complete account number from your Discover Card



Expiration date:

AUTHORIZED SIGNATURE

Prices are subject to change without notice.

Print or type your name and
address clearly.



A complete and correct order will
save you days of waiting.

Name: _____
Street: _____
_____ Apt: _____
City: _____
State: _____ Zip: _____

Please make sure that both sides of this form have been filled out completely.

Y Allow 4 weeks for delivery.

Y All accessories are subject to availability.

Detach Here

Accessories

To order accessories, contact your local Dealer.

If a dealer is not nearby, you can also follow the directions below to order by telephone or direct-by-mail.

United States and Canada Orders

To place your order by phone, have your Visa, MasterCard, or Discover card ready and call the toll-free number listed below.

Use this number only to place an order for accessory items listed on this order form.

1-800-338-0376

To place your order by mail, detach and mail the completed order form with credit card information, money order, or check in U.S. currency (made payable to Thomson Consumer Electronics, Inc.) to the following address:



**Video Accessories
PO Box 8419
Ronks, PA 17573**

Trouble Checks

Troubles sometimes are caused by simple “faults” that you can easily correct without the help of a service technician by first checking a few basic remedies.

Before you call or take your camcorder to an Authorized RCA Camcorder Service Center, look below for the type of trouble you are experiencing. Then perform the simple checks and adjustments listed for that trouble.

If service should be necessary, the warranty information lists what your warranty covers and explains how to get service.

Trouble	Checks and Adjustments
No power is supplied.	<ul style="list-style-type: none">• Connect the AC adapter/charger securely (<i>page 4</i>).• Replace the dead battery with a fully charged one (<i>pages 12-14</i>).
“SET DATE/TIME!” appears.	<ul style="list-style-type: none">• Set the date/time (<i>pages 18-19</i>).• Consult your nearest camcorder dealer for replacement.
Recording cannot be performed.	<ul style="list-style-type: none">• Set the tape’s erase protection tab to <i>REC</i>.• Set the <i>power switch</i> to automatic or manual record ( or ).• Replace with new cassette.• Close the cassette holder cover.
There is no picture.	<ul style="list-style-type: none">• Turn the camcorder’s power off and on again (<i>page 5</i>).
Some functions are not available using the MENU/BRIGHT dial.	<ul style="list-style-type: none">• Set the Power Switch to manual () record (<i>page 5</i>).
The focus does not adjust automatically. The cassette will not load properly.	<ul style="list-style-type: none">• Set focus mode to the <i>Auto</i> (<i>page 45</i>).• Clean the lens and check the focus again (<i>page 69</i>).

Trouble Checks

Trouble	Checks and Adjustments
The cassette will not load properly.	<ul style="list-style-type: none"> • Set it in the right position (<i>page 6</i>). • Install a fully charged battery (<i>pages 12-14</i>) or connect the camcorder to the AC Adapter (<i>page 4</i>). • Make sure to use only Mini DV cassettes (<i>page 16</i>).
Snapshot mode cannot be used.	<ul style="list-style-type: none"> • Turn off Squeeze mode in the MANUAL MENU (<i>pages 36-37</i>).
The color of Snapshots looks brownish-orange.	<ul style="list-style-type: none"> • Turn off Sepia and/or Monotone effects (<i>page 31</i>).
The image taken using Snapshot is too dark.	<ul style="list-style-type: none"> • Press the BACKLIGHT Button (<i>page 33</i>).
Digital Zoom does not work.	<ul style="list-style-type: none"> • In the Menu screen set ZOOM to 40X or 250X (<i>pages 38-39</i>). • Disengage the VIDEO ECHO mode (<i>page 31</i>). • Wait until the Picture Wipe or Dissolve effects are completed (<i>pages 29-30</i>).
Program AE with special effects and Fade/Wipe effects do not work.	<ul style="list-style-type: none"> • Set the Power Switch to manual (M) record (<i>page 5</i>).
The Black & White Fader does not work.	<ul style="list-style-type: none"> • Turn off Sepia and/or Monotone effects (<i>page 31</i>).
The Dissolve function does not work.	<ul style="list-style-type: none"> • Turn off Sepia, Monotone or Slow Shutter before adding Dissolve to a scene transition (<i>page 31</i>). • Set WIDE MODE to CINEMA or OFF (<i>pages 36-37</i>). • Make sure you have selected the mode of Program AE with special effects you want before starting editing (<i>pages 31-32</i>).

Trouble Checks

Trouble	Checks and Adjustments
The Picture Wipe and/or Dissolve functions do not work.	<ul style="list-style-type: none"> • Select Picture Wipe or Dissolve before recording. The effects are then automatically activated (<i>pages 29-30</i>). • The camcorder automatically shuts off after five minutes in Record-Standby mode. Make sure you continue using the camcorder within five minutes after pausing a tape (<i>page 26</i>). • Disengage Slow Shutter mode (<i>page 31</i>) or set WIDE MODE to OFF (<i>page 36-37</i>) before using Picture Wipe effects.
The Video Echo mode does not work.	<ul style="list-style-type: none"> • Set WIDE MODE to CINEMA or OFF (<i>pages 36-37</i>). • Do not use Video Echo during a fade-in or fade-out (<i>page 31</i>).
Even when <i>Slow Shutter</i> is not selected, the image looks like it is.	<ul style="list-style-type: none"> • If you want the lighting to look more natural, set GAIN UP to AGC or OFF (<i>page 39</i>).
There is no strobe when the <i>Classic Film</i> or <i>Strobe</i> mode is activated.	<ul style="list-style-type: none"> • Do not try to use the Classic Film or Strobe modes during a scene transition (<i>page 31</i>).
White Balance cannot be activated.	<ul style="list-style-type: none"> • Turn off Sepia or Monotone before setting White Balance (<i>page 31</i>).
During recording, the date/time does not appear.	<ul style="list-style-type: none"> • Set DATE/TIME to ON (<i>page 42</i>). • When the LCD monitor is turned to face forward, (<i>page 22</i>) date and time do not appear.
The indicators and messages do not appear.	<ul style="list-style-type: none"> • In the Menu screen, set ON SCREEN to LCD or LCD/TV (<i>page 41</i>) and set TIME CODE to ON (<i>page 42</i>).
Images on the LCD monitor appear dark or whitish.	<ul style="list-style-type: none"> • Adjust the brightness and angle of the LCD monitor (<i>page 22</i>).

Trouble Checks

Trouble	Checks and Adjustments
The back of the LCD monitor is hot.	<ul style="list-style-type: none"> • Close the LCD monitor to turn it off or set the Power Switch to <i>OFF</i> and let the camcorder cool down (<i>page 22</i>).
The LCD monitor or viewfinder indications blink.	<ul style="list-style-type: none"> • This can occur in certain conditions including using Fade and Wipe effects (<i>pages 29-30</i>), Program AE with Special Effects (<i>pages 31-32</i>), and Digital Image Stabilization (<i>page 35</i>).
Play, rewind and fast-forward do not work.	<ul style="list-style-type: none"> • Set the Power Switch to playback (PLAY) mode (<i>page 49</i>).
The tape is moving, but there is no picture.	<ul style="list-style-type: none"> • Set the TV to its video input channel (see the TV's User's Manual). • Make sure all A/V connections are correct and snug. • Close the cassette holder door (<i>page 6</i>).
Images on the LCD monitor are jittery.	<ul style="list-style-type: none"> • Turn the speaker volume down (<i>page 49</i>).
Blocks of noise appear during playback, or there is no playback picture and the screen becomes blue.	<ul style="list-style-type: none"> • Clean the video heads with an optional cleaning cassette (see your local dealer to purchase).
The LCD monitor, viewfinder and/or lens are dirty (ex. fingerprints).	<ul style="list-style-type: none"> • Wipe them gently with soft cloth. Wiping strongly can cause damage (<i>page 69</i>).
An unusual icon appears on-screen.	<ul style="list-style-type: none"> • Check the section of the manual that explains LCD monitor and viewfinder icons (<i>pages 24-28</i>).

Trouble Checks

Trouble	Checks and Adjustments
An error indication (E01 — E06) appears on-screen.	<ul style="list-style-type: none">Remove the power supply (battery pack, etc.) and wait a few minutes for the icon to clear. When it does, reattach the power supply, turn on the camcorder's power, and resume recording. <p>If the indication remains after repeating the above procedure two or three times, consult your nearest camcorder service technician.</p>
The charger indicator on the AC Adapter/Charger does not light.	<ul style="list-style-type: none">To protect the battery, it is recommended to charge it in places with a temperature of 50-95 degrees Fahrenheit (10°C to 35°C) (<i>pages 13-14</i>).
No picture appears on the LCD monitor.	<ul style="list-style-type: none">Remove the lens cap.Adjust the brightness of the LCD monitor (<i>page 22</i>).If the LCD is rotated forward, make sure it is fully rotated 180 degrees.
When the camcorder is connected via the IEEE 1394 connector, the camcorder does not operate.	<ul style="list-style-type: none">Turn the camcorder's power off and on again.

Specifications

General

Power requirement: 6.3 VDC

Power consumption:

Viewfinder on: 4.3 watts

LCD monitor on: 5.3 watts

Weight: 1.3 lbs. (550g)

Dimensions – Including Viewfinder:

3-3/16" (W) x 3-13/16" (H) x 6-5/16" (D)

80 (W) x 96 (H) x 159 (D) mm

Video Recorder Section

Format: DV

Record/playback system:

Digital component recording

Video signal: EIA standard

NTSC color

Viewfinder

0.24" Black and white electronic
viewfinder

LCD Monitor

3" diagonally measured LCD/TFT active
matrix system

Camera Section

Image sensor: 1/4" CCD imager

Lens: F1.6, f=3.9 to 62.4mm

16:1 power zoom lens

400:1 digital zoom

Filter diameter: 40.5 mm

Tripod Mount

One 1/4" x 20 threaded hole

AC Adapter/Charger

Power requirement: 110-240 V, 50/60 Hz.

Power consumption: 23 watts

Weight: .56 lbs. (250g)

Dimensions:

2-11/16" (W) x 1-1/2" (H) x 4-3/8" (D)

68 (W) x 38 (H) x 110 (D) mm

Care and Maintenance

After Using the Camcorder

1. Turn off the camcorder.
2. Slide and hold the OPEN/EJECT latch in the direction of the arrow, then pull the cassette holder cover open until it locks. The cassette holder opens automatically.
3. Remove the cassette.
4. Press the area marked **PUSH HERE** to close the cassette holder.
 - Once the cassette holder is pushed in, it recedes automatically. Wait until the holder recedes completely before closing the cassette holder cover.
4. Slide the BATTERY RELEASE button and remove the battery pack.

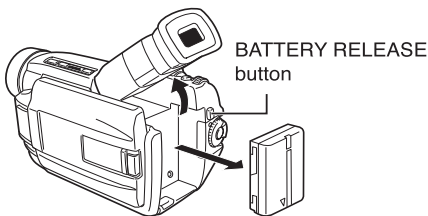
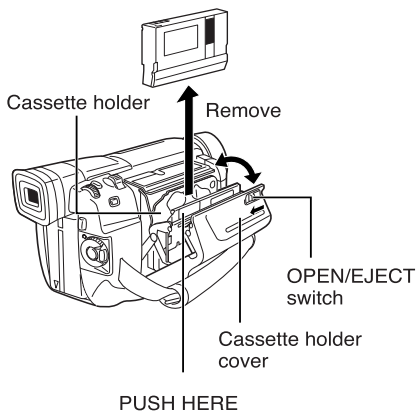

Cleaning The Camcorder

1. Clean the exterior wiping gently with a soft cloth. For heavy dirt, use diluted, mild soap and wring the cloth well. Then wipe again with a dry cloth.
2. Open the LCD monitor (*page 22*) and wipe it gently with a soft, dry cloth. Close when done.
3. To clean the lens, blow it with air using a blower brush. Wipe gently with lens cleaning paper.
4. To clean the viewfinder, raise it to the vertical position. Carefully open the cover on the bottom of the viewfinder.

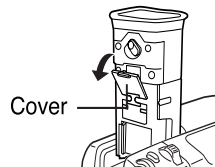

Insert a lens blower or soft cloth into the gap to clean the interior.

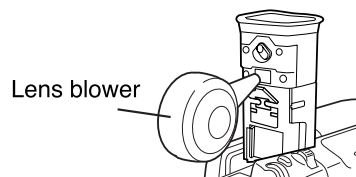

Close the cover and tilt the viewfinder back to the horizontal position.

Notes: Avoid using strong cleaning agents such as alcohol.

Cleaning should be done only after the power supply has been disconnected.

Mold may form if the lens is left dirty.

When using a cleaner or chemically treated cloth refer to the cautions of each product.

Proper Care and Storage

- Keep dirt from entering the camcorder's cassette door. Dust and grit are abrasive and cause excessive wear to both the recording/playback heads and cassettes.
- Always cap the lens when the camcorder is not in use.
- Before handling the camcorder, make sure your hands and face are free from any chemical products such as suntan lotion, as it might damage the finish.
- The camcorder might be damaged by improper storage or handling. Do not subject the camcorder to swinging, shaking, or dropping.
- Do not store the camcorder in temperatures below -22°F (-30°C) or above 149°F (65°C).
- When the camcorder is not in use, always remove the cassette and AC adapter/charger or battery.
- Retain the original carton for future storage or shipping purposes.

Things to Avoid

- Do not attempt to disassemble the camcorder. There are no user-serviceable parts inside.
- Avoid operating the camcorder immediately after moving it from a cold location to a warm location. Give the camcorder 1-1/2 to 2 hours to reach a stable temperature before inserting a cassette.
- In cold to warm conditions,

condensation might occur causing the tape to stick to the recording heads and damage the camcorder or cassettes.

- Never aim the camcorder at the sun or other bright objects.
- Do not leave the camcorder in direct sunlight for extended periods of time. The resulting heat buildup might permanently damage the camcorder's internal parts.
- Do not operate the camcorder in extremely humid environments.
- Do not operate the camcorder near the ocean as salt water or spray might damage the internal parts of the camcorder.
- Do not operate the camcorder for extended periods in temperatures below 40°F (4°C) or above 95°F (35°C).
- Do not expose the camcorder or adapter/charger to rain or moisture. If any component becomes wet, turn off the power and take the unit to an authorized RCA camcorder service provider.
- Do not use an adapter/charger or batteries other than the ones specified for the camcorder. Using the wrong accessories might cause damage to the camcorder.

Customer Assistance and Service

You can reach Thomson at the following number:

800-283-6503

(Toll free inside U.S.A.)

Our toll-free camcorder number operates from 8 a.m.

to 5 p.m. CST

Monday – Friday

for U.S. customers only

Thomson provides a toll-free telephone number to help with any problems encountered with the camcorder. Many problems can be diagnosed over the phone, but, if necessary, repair or replacement will be arranged. Have the camcorder's model/serial number and date of purchase ready when you call for faster service. If your unit is out of warranty, we will quote the cost of a repair or replacement unit to you.

Returning equipment to Thomson for repair or exchange

If we are unable to resolve your problem over the phone, we will gladly service your unit or exchange it for a new or refurbished camcorder. Refer to the limited warranty on the reverse side to learn about your specific rights and responsibilities.

Always consult Thomson and get a Service Request number before returning anything! Obtain a Service Request (SR) number from the telephone representative before returning your equipment to avoid delays, accounting errors, or even loss of your unit.

Important information to customers who ship defective equipment to Thomson Consumer Electronics

The Thomson representative who authorized the return of your equipment will give you an SR number over the phone. They will also provide you with instructions on where and how to return your camcorder. Write the number in large, clear characters on the outside of the box. To avoid confusion and misunderstandings, shipments without an SR number clearly visible on the outside of the box will be returned to you at your expense.

Include a brief note describing the problem and any conversations about the problem you have had with Thomson personnel.

Include your name, address and model/serial number of the camcorder. These numbers are located on the bottom of the camcorder.

If the camcorder is within the warranty period, please provide a copy of the bill of sale to verify purchase date. Use the original box and packing material to protect the equipment from damage in shipment.

For your protection, insure all shipments for full replacement value and use a reliable shipper. Thomson assumes no responsibility for warranty shipments from the customer to the factory if not shipped in the manner prescribed by Thomson.

Warranty

What your warranty covers:

- Any defect in materials or workmanship.

For how long after your purchase:

- 90 days for labor charges.
- One year for parts.

The warranty period for rental units begins with the first rental or 45 days from date of shipment to the rental firm, whichever comes first.

What we will do:

During the initial 90 days

- Exchange your camcorder with a new or refurbished unit, or repair your camcorder. The option will be ours. There will be no cost to you.

After the 90 days and within one year

- Exchange your camcorder with a new or refurbished unit, or repair your camcorder. The option will be ours. Parts will be provided at no charge, but you will be responsible for the cost of labor required for the repair.

How you get service:

- Call 1-800-283-6503 and have your unit's date of purchase and model/serial number ready. The model/serial number information is on the bottom of your camcorder.
- A representative will troubleshoot your problem over the phone. If the representative determines that you should receive a replacement unit, you will be provided with a Service Request (SR) number and the location of a nearby exchange point if one exists. No returns will be accepted without the SR number.

To receive a replacement Camcorder before you return yours:

Option I

1. Provide your Discover, MasterCard, or Visa account number and expiration date

to our phone representative. This is for security purposes. If we receive your unit, excluding all accessories, within 14 days from the date you were provided the SR number, only items not covered by warranty will be charged to your account. **IF YOUR UNIT IS NOT RECEIVED WITHIN 14 DAYS, THE SUGGESTED RETAIL VALUE OF THE CAMCORDER WILL BE CHARGED TO YOUR CREDIT CARD.** This amount, less \$10.00 handling, will be credited if the unit is subsequently received.

2. We will send you a replacement unit.
3. Ship the unit back to us, excluding all accessories, using the replacement unit's carton. Shipping instructions will be included in the carton along with your SR number which will allow you to easily ship the unit back to us. **Make sure you insure your shipment in case of damage or loss.** Include with the shipment:
 - Evidence of purchase date, such as a bill of sale to verify your unit's warranty eligibility.
 - A brief note describing your camcorder's problem.
 - Your name, address and phone number.

Return transportation, storage, handling, and insurance costs are your sole responsibility. We accept no liability in case of damage or loss.

Option II

1. We will send a replacement unit to the exchange point.
2. The exchange location will notify you of its arrival.
3. Take your unit, excluding all accessories, and your evidence of purchase date, such as a bill of sale, to the exchange location and you will be provided the new or refurbished unit.
4. If the repairs were covered by your warranty, you will not be billed.

Warranty

To receive a replacement unit after we have received your unit:

1. **Write the SR number on the outside of the carton used to return the unit. Make sure you insure your shipment in case of damage or loss.**
2. Carefully pack the unit, excluding all accessories, using the original box and packing material if possible.
3. Include with the shipment:
 - Evidence of purchase date, such as a bill of sale, to verify your unit's warranty eligibility.
 - A brief note describing your camcorder's problem.
 - Your name, address and phone number.

Return transportation, storage, handling, and insurance costs are your sole responsibility. We accept no liability in case of damage or loss.

4. The representative will advise the address to mail a cashier's check or money order for payment if there are any out of warranty labor or parts charges and you elect not to use your credit card.
5. Upon receipt of your product, a new or refurbished unit will be shipped to you.

To have your Camcorder repaired by an Authorized RCA Camcorder Service Center:

- Check with your dealer or call 1-800-336-1900 for the Authorized RCA Camcorder Service Center nearest you.
- Take your unit to the Authorized RCA Camcorder Service Center of your choice.
- Show the Authorized RCA Camcorder Service Center representative evidence of purchase date, such as a bill of sale.
- Pick up your camcorder when repairs are complete.

What your warranty does not cover:

- Adjustment of customer controls.
- Damage from misuse or neglect.
- A unit that has been modified or incorporated into other products or is used for institutional or other commercial purposes.
- Batteries for remote control and clock.
- Cleaning of video/audio heads.
- Camcorders purchased or serviced outside the U.S.A.
- Return transportation, storage and handling costs of your unit, including insurance for loss or damage.
- Acts of God, such as but not limited to lightning damage.

Product Registration:

- Please complete and mail the Product Registration Card packed with your camcorder. It will make it easier to contact you should it ever be necessary. The return of the card is not required for warranty coverage.

How State Law relates to warranty:

- This warranty gives you specific legal rights and you also may have other rights that vary from state to state.

If you purchased your camcorder outside the United States:

- This warranty does not apply. Contact your dealer for warranty information.

Service calls that do not involve defective materials or workmanship are not covered by this warranty. Costs of such calls are the sole responsibility of the purchaser.

Optional S-Video Cables

Attaching a Core Filter to an Optional S-Video Cable

Your digital camcorder and some TVs and video units have an S-Video jack. S-Video provides excellent video transfer abilities (not sound). You can purchase an S-Video cable at many retail electronics stores.

When using an S-Video cable, it must have a Core Filter attached to meet FCC requirements. The Core Filter reduces picture interference.

A core filter is supplied with this digital camcorder.

Attaching the Core Filter to an Optional S-Video Cable

1. Release the stoppers on both ends of the Core Filter and open.



2. Run the cable through the Core Filter, leaving approx. 1 1/4 inches of cable between the cable plug and the Core Filter casing.

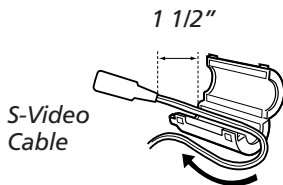

3. Wind the cable once around the outside of the Core Filter. Make sure not to leave slack in the cable.

4. Loop the cable back through the Core Filter casing.

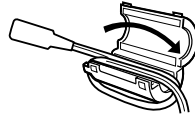

5. Close the Core Filter until it clicks shut. The S-Video cable is now ready for use.

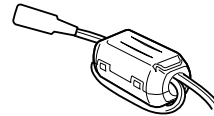

Note: When working with an S-Video cable, attach the end with the Core Filter to the camcorder.

A

- Accessories 3, 57
 - AC battery charger 58
 - carrying case 57
 - order form 60
 - rechargeable battery 57
 - remote control 58
 - tripod 59
- Adapter/Charger 3, 11, 58
 - attaching 4, 11
 - removing 11
- Assistance 3
- Audio/Video Cable 3
- Auto Focus 45
- Automatic Recording
 - AutoShot 5

B

- Battery 3, 9, 12
 - attaching 12
 - care and storage 14
 - charging 13
 - life 14
 - removing 12
 - using 12
- Battery Levels Indicator 24
- Battery Release Button 9

C

- CAM RESET 37
- Camcorder
 - care and maintenance 69
 - care and storage 70
 - cleaning 69
 - exchange warranty 3
 - focusing 45
 - operating tips 56
 - repair or exchange 71
 - resetting factory defaults 37
 - things to avoid 70

- CAMERA Icon 38, 39, 40, 41
- Camera Menu 29, 37
- Cassette Holder
 - cover door 10
 - Push Here 6
- Cassettes
 - care and storage 17
 - Mini DV 16
 - Record Protection Tab 6
- CHECK TAPE'S ERASE PROTECTION SWITCH Indicator 24
- CINEMA Mode 36
- CLASSIC FILM 31
- Clock Adjustment 18, 42
- Connections 50
 - basic 50
 - capturing sound only 54
 - to a computer 53
 - to a TV 51
 - to a VCR 52
 - to another DV camcorder 55
 - using A/V jacks 51, 52, 54
 - using an IEEE 1394 cable 53, 55
- Connectivity Jacks 9
- Core Filter 74
- CRK76 Remote Control 58
- Customer Assistance and Service
 - 3, 71

D

- Date and Time
 - displaying 20
 - setting 18
- Date and Time Display 42
- DC jack
 - cable 3
 - IN 4
 - OUT 4
- Demo Mode 40
- Digital Image Stabilization 35
- Digital Zoom 47

Display Menu 20, 29, 41
 options 18
DISSOLVE 30
Dubbing
 digital 55
 sound 54

E

Exposure 29
 control 32
Eyepiece
 focusing 23

F

Fade and Wipe Effects 29
 FADER - B.W 30
 FADER - BLACK 29
 icon 29
Fast Forward Button 9
FCC Declaration of Conformity 79
Focus 45
 auto 45
 manual 46

G

Gain Up 39
 AGC 39
 auto 39
 off 39
 setting up 39

H

Handstrap 9
 adjusting 4
Head Cleaning Warning 24

I

ID Number 40
 setting 40

Image Stabilization
 activating 35
Indicators
 on-screen 24
Industry Canada Information 79
Iris Lock
 setting 33

L

LCD Monitor 6, 9, 22, 43
 rotating 6, 22
 using 7, 22
Letterbox 36
Light (AUTO/OFF/ON) Switch
 5, 10, 43
Lock Button 5, 9
Long Play (LP) Mode 16
LP Speed 38

M

Manual Focus 46
Manual Menu
 using 35
Manual White Balance
 operation 34
Menu Options 18
 displaying
 camcorder 18
 TV 18
MENU/BRIGHT Dial
 7, 9, 10, 21, 29, 35
Menus
 accessing 29
Microphone 9
Mini DV 16
Missing Cassette Warning Indicator
 24, 25
MODE Button 10, 46
MULTI-4 Snapshot Feature 47
MULTI-9 Snapshot Mode 47

O

- On Screen Displays 41
- On-screen Indicators 24
- On-Screen Preferences 18
- OPEN/EJECT
 - slider 9
 - switch 6
- Optical Zoom 47

P

- PIN-UP Snapshot Mode 47
- Play/Pause Button 9
- Playback 8, 49
 - basic 49
 - frame-by-frame 50
 - options 49
 - shuttle search 50
 - speeds 16
 - still 50
- Plug Adapter 11
- Power Indicator 9
- Power Switch 5, 7
 - automatic recording 5
 - lock button 5
 - manual recording 5
- Power Zoom Lever
 - volume control 49
- Product Registration 2
- Program AE 30
- Program AE Effects 30
- Push Here 6
- PUSH/OPEN Button 9

R

- RANDOM 30
- Rechargeable Battery 57
- Record Protection Tab 6

- Recording 43
 - details 43
 - icon 7
 - mode 38
 - playing back 8
 - speeds 16
 - starting/stopping 7
 - time 17
 - tips 56

- Remote Control
 - universal 58
- Rewind Button 9

S

- S-Video Cable 74
- Safety Precautions 12
- Shoulder Strap 3
 - attaching 15
 - ring 10
- Shuttle Search 50
- Side LED 41
- SLOW 10X 31
- SLOW 4X 31
- Snapshot Feature 46
 - button 46
 - Full 46
 - Multi-4 46
 - MULTI-9 47
 - PIN-UP 47
- Sound
 - dubbing 54
 - mode 38
- SP mode 38
- Speaker 10
- Speaker Volume 49
- Special Effects 30
- Specifications 68
- Speeds and Times
 - recording and playback 16
- SQUEEZE Mode 36

Standard Speed (SP) Mode 16
Still Playback 50
STOP Button 9

T

Table of Contents 1
Tally Light 9, 39
Tapes
 Mini DV 16
Tele Macro Focusing 35
Thumb Trigger 9
Time Code 42
 display 20
Time-Remaining Display 17
Tips
 recording 56
 traveling 56
Tripod 59
Trouble Checks 63
TWILIGHT 31

V

Variable Shutter Speed 31
 1/100 31
 1/250 31
 1/500 31
 1/60\ 31
VIDEO ECHO 31
Video Light 43, 44
Viewfinder 9, 23
 focusing 23
 using 23

W

W and T (Zoom Lever) 47
W.BALANCE 29
Warranty 72

White Balance Adjustment 33
 automatic 33
 manual 33
Wide Mode 36
Wind Noise 37
 cutting 37
WIPE - DOOR 30
WIPE - SLIDE 30
WIPE - WINDOW 30

Z

Zoom Lever 47
 volume control 9
Zoom Mode 38
 10X 38
 250X 38
 40X 38
 digital interpretation 38
 selecting 38
Zooming 47
 digital 47
 optical 47
 zoom lever 47

FCC Declaration of Conformity and Industry Canada Information

FCC Regulations state that unauthorized changes or modifications to this equipment may void the user's authority to operate it.

This device complies with part 15 of FCC Rules. Operation is subject to the following two conditions: (1) This device may not cause harmful interference, and (2) This device must accept any interference received, including interference that may cause undesired operation.

This Class B digital apparatus complies with the Canadian ICES-003.

Cet appareil numérique de la Classe B est conforme a la norme NMB-003 du Canada.

This equipment has been type tested and found to comply with the limits for a Class B Digital Device in accordance with the specifications in Part 15 of the FCC rules. These rules are designed to provide reasonable protections against radio and television interference in a residential installation. This equipment generates, uses and can radiate radio frequency energy and, if not installed and used in accordance with the instructions, may cause harmful interference to radio communications. However, there is no guarantee that interference will not occur in a particular installation.

If this equipment does cause interference to radio or television reception (which you can determine by turning the equipment off and on), try to correct the interference by one or more of the following measures:

Reorient or relocate the receiving antenna (that is, the antenna for the radio or television that is "receiving" the interference).

Change the position of the Camcorder with respect to the radio or television equipment that is receiving interference.

Move the Camcorder away from the equipment that is receiving interference.

Plug the Camcorder into a different wall outlet so that the Camcorder and the equipment receiving interference are on different branch circuits.

If these measures do not eliminate the interference, please consult your dealer or an experienced radio/television technician for additional suggestions. Also, the Federal Communications Commission has prepared a helpful booklet, "How To Identify and Resolve Radio/TV Interference Problems." This booklet is available from the U.S. Government Printing Office, Washington D.C. 20402. Please specify stock number 004-000-00345-4 when ordering copies.

For more information on FCC conformity: Thomson Consumer Electronics, Inc., 10330 N. Meridian St., Indianapolis IN 46290; 1-800-587-5850.

This Page Left Blank Intentionally

This Page Left Blank Intentionally

 **THOMSON CONSUMER ELECTRONICS**

10330 N Meridian Street

Indianapolis, IN 46290

©2000 Thomson Consumer Electronics, Inc.

Trademark(s)® Registered

Marca(s) Registrada(s)

Printed in Japan

TOCOM 15604110

Part Number LYT0634-001A(VP)

Free Manuals Download Website

<http://myh66.com>

<http://usermanuals.us>

<http://www.somanuals.com>

<http://www.4manuals.cc>

<http://www.manual-lib.com>

<http://www.404manual.com>

<http://www.luxmanual.com>

<http://aubethermostatmanual.com>

Golf course search by state

<http://golfingnear.com>

Email search by domain

<http://emailbydomain.com>

Auto manuals search

<http://auto.somanuals.com>

TV manuals search

<http://tv.somanuals.com>