

OWNER'S MANUAL

DieHard®

**Microprocessor Controlled, Fully Automatic
Operation Battery Charger
with Engine Starter**

Plus Battery and Alternator Tester

**2-AMP SLOW CHARGE
15-AMP FAST CHARGE
40-AMP RAPID CHARGE
125-AMP ENGINE START**

**FOR 12-VOLT
BATTERIES**

**Model No.
200.71226**

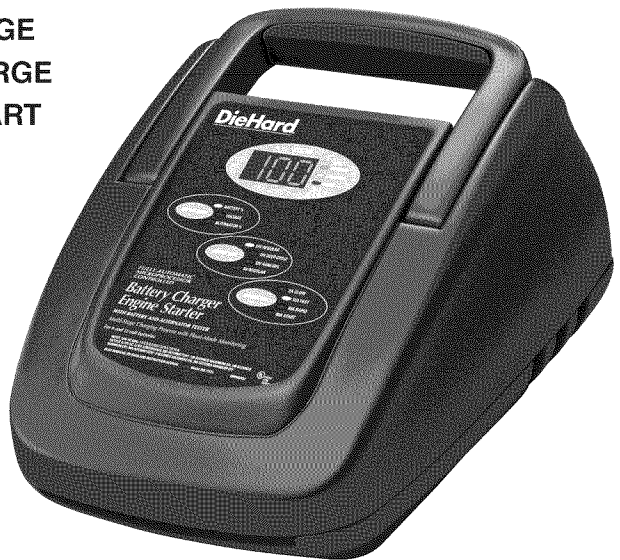

CAUTION:

Read all Safety Rules and Operating Instructions,
and follow them with each use of this product.

Sears, Roebuck and Co., Hoffman Estates, IL 60179 U.S.A.

TABLE OF CONTENTS

WARRANTY	2
IMPORTANT SAFETY INSTRUCTIONS	3
PERSONAL SAFETY PRECAUTIONS	4
BEFORE USING YOUR BATTERY CHARGER	5
Plugging It In	5
Assembling Your Charger	5
Using An Extension Cord	5
PREPARING YOUR BATTERY TO BE CHARGED	5
OPERATING INSTRUCTIONS	6
Charging Battery In The Vehicle	6
Charging Battery Removed From The Vehicle	7
Using Engine Start	7
USING YOUR BATTERY CHARGER	8
CHARGER CONTROLS	9
CONTROL PANEL GUIDE	10
USING THE BUILT-IN BATTERY TESTER	11
USING THE BUILT-IN ALTERNATOR TESTER	12
BATTERY PERCENT AND CHARGE TIME	13
CHARGING TIPS	14
MAINTENANCE AND CARE	14
TROUBLESHOOTING	15
PARTS	16
WIRING DIAGRAM	16

PLEASE SAVE THIS OWNER'S MANUAL AND READ BEFORE EACH USE.

The DieHard Model 71226 Microprocessor Controlled, Fully Automatic Operation Battery Charger with Engine Starter Plus Battery and Alternator Tester offers features to accommodate the needs for home or light commercial use. This manual will explain how to use the battery charger safely and effectively. Please read and follow these instructions and precautions carefully.

For information about troubleshooting, call toll-free from anywhere in the U.S.A. 7 am to 4:30 pm Central Time Monday through Friday. **1-800-SEARS-64 (1-800-732-7764)**.

WARRANTY

THREE-YEAR FULL WARRANTY

If this Battery Charger fails due to a defect in material or workmanship within three years from the date of purchase, RETURN IT TO ANY SEARS STORE or OTHER DIEHARD OUTLET IN THE UNITED STATES FOR FREE REPLACEMENT.

This warranty gives you specific legal rights, and you may also have other rights which vary from state to state.

Sears, Roebuck and Co., Hoffman Estates, IL 60179

IMPORTANT SAFETY INSTRUCTIONS

WARNING – RISK OF EXPLOSIVE GASES

WORKING IN VICINITY OF A LEAD-ACID BATTERY IS DANGEROUS. BATTERIES GENERATE EXPLOSIVE GASES DURING NORMAL BATTERY OPERATION. FOR THIS REASON, IT IS OF UTMOST IMPORTANCE THAT EACH TIME BEFORE USING YOUR CHARGER, YOU READ THIS MANUAL AND FOLLOW THE INSTRUCTIONS EXACTLY.

To reduce risk of battery explosion, follow these instructions and those published by battery manufacturer and manufacturer of any equipment you intend to use in vicinity of battery. Review cautionary markings on these products and on engine.

SAVE THESE INSTRUCTIONS

- **WARNING:** Handling the cord on this product or cords associated with accessories sold with this product, may expose you to lead, a chemical known to the State of California to cause cancer and birth defects or other reproductive harm. **Wash hands after handling.**
- Read all instructions and cautions printed on the battery charger, battery, and vehicle or equipment using battery.
- Use charger only on lead-acid type rechargeable batteries, such as those used in cars, trucks, tractors, airplanes, vans, RVs, trolling motors, etc. This charger is not intended to supply power to a low voltage electrical system other than in a starter-motor application.
- **Never** use charger for charging dry cell batteries that are commonly used with home appliances like radios, stereos, remote controls, etc. These batteries may burst and cause personal injury.
- Do not disassemble charger. Take it to a qualified service professional if service or repair is required. Incorrect assembly may result in fire or electrical shock.
- To reduce risk of electrical shock, unplug the charger from the outlet before attempting any maintenance or cleaning.
- Always charge battery in a well-ventilated area.
- **WARNING:** Battery chargers get hot during operation and must have proper ventilation. Air needs to flow around entire charger. Do not set charger on flammable materials like carpeting, upholstery, paper, cardboard, etc. Charger may damage leather and melt plastic and rubber.

HELP US HELP YOU —

Remember:

Place charger as far away from the battery being charged as the charger cables will permit.

Do not expose charger to rain or snow.

Never charge a frozen battery. If battery fluid (electrolyte) becomes frozen, bring battery into a warm area to thaw before you begin charging.

Never allow battery acid to drip on charger when reading specific gravity or filling battery.

Never set a battery on top of the charger.

Never place charger directly above battery being charged. The gases from the battery will corrode and damage the charger.

Never touch the battery clamps together when the charger is on. You could cause a spark.

Never operate charger if it has received a hard blow, been dropped, or otherwise damaged. Take it to a qualified professional for inspection and repair.

Be sure to position the charger power cord to prevent it from being stepped on, tripped over, or damaged.

Never pull out the plug by the cord when unplugging the charger. Pulling on the cord may cause damage to the cord or the plug.

Do not operate the charger if it has a damaged power cord or plug. Have the cord replaced.

PERSONAL SAFETY PRECAUTIONS

- **Wear complete eye and clothing protection** when working with lead-acid batteries.
- **Make sure** that someone is within range of your voice to come to your aid if needed while you work with or are near a lead-acid battery.
- **Have plenty of fresh water and soap** nearby for use in case battery acid contacts your eyes, skin, or clothing. If this happens, wash immediately with soap and water. Then get medical attention.
- **Avoid touching your eyes** while working with a battery. Acid particles (corrosion) may get into your eyes. If this occurs, flush eyes immediately with running cold water for at least 10 minutes. Then immediately get medical attention.
- **Remove all personal metal items** from your body such as rings, bracelets, necklaces and watches, while working with a lead-acid battery. A battery can produce a short circuit current high enough to weld a ring (or the like) to metal, causing a severe burn.
- **Take care** not to drop any metal tool or metal object onto the battery. This may spark or short circuit the battery or another electrical device that may cause an explosion.
- **Always** operate the battery charger in an open, well-ventilated area.
- **Never** smoke or allow a spark or flame in the vicinity of the battery or engine. Batteries generate explosive gases.
- **Neutralize** any acid spills thoroughly with baking soda before attempting to clean up.

BEFORE USING YOUR BATTERY CHARGER

It is important to understand your charger's requirements. This section will tell you about your charger's electrical requirements and how to prepare a battery for charging.

PLUGGING IT IN

Your charger requires a 120V AC 2-prong wall outlet receptacle installed according to all local codes and ordinances.

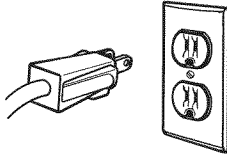

ASSEMBLING YOUR CHARGER

Included with your battery charger are two cord wrap cleats for storage of the clamp cables.

To install, align the two tabs to correspond with the two receptacles and push until you hear a snap.

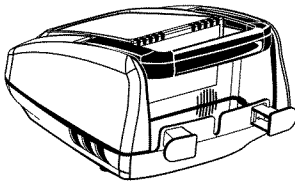

Wrap clamp cables after unplugging the power cord from the AC wall outlet and store your charger in a dry location.

USING AN EXTENSION CORD

The use of an extension cord is not recommended. If you must use an extension cord, please make sure that you follow these guidelines:

- Make sure that the pins on charger's power cord fit firmly into the extension cord, and that the extension cord fits firmly into the receptacle.
- Check that the extension cord is properly wired and in good electrical condition.
- Make sure that the wire size is large enough for its length and for the AC ampere rating, as specified in the chart below.

MINIMUM RECOMMENDED EXTENSION CORD				
Length of Cord, in Feet	25	50	100	150
AWG* Size of Cord	18	16	12	10

*AWG=American Wire Gauge

PREPARING YOUR BATTERY TO BE CHARGED

It is important that you read and follow these guidelines while you are preparing to charge the battery.

- Make sure that you have a 12 volt lead-acid battery. Determine voltage of battery by referring to vehicle owner's manual or the battery markings. Charge battery initially at charger's lowest rate.
- Clean the battery terminals. Be careful to keep corrosion from getting in or around your eyes or on your hands.
- Wear safety glasses. See additional "Personal Safety Precautions" on page 4.
- If required, for batteries with removable vent caps, add distilled water to each cell until the battery acid reaches the level recommended by the manufacturer. This will help purge excessive gases from the cells. Be careful not to overfill. If you have a sealed battery with non-removable vent caps, no action is necessary.
- Take time to read all of the battery manufacturer's specific precautions, such as removing or not removing vent caps while charging, and recommended rates of charge.
- Be sure that the area around the battery is well ventilated while it is being charged. Gas can be forcefully blown away by using a piece of cardboard or other nonmetallic material as a fan.
- If it is necessary to remove the battery from the vehicle to charge it, always remove the grounded terminal from the battery first. Turn off all vehicle accessories to avoid sparks from occurring.
- **NOTE:** A marine (boat) battery installed in a boat must be removed and charged on shore.

OPERATING INSTRUCTIONS

NOTE: A marine (boat) battery must be removed and charged on shore. To charge it on board requires equipment specially designed for marine use.

IMPORTANT: Follow all safety instructions and precautions when charging your battery. Wear complete eye protection and clothing protection. Charge your battery in a well-ventilated area.

CHARGING BATTERY IN THE VEHICLE:

1. Avoid personal injury by keeping clear of fan blades, belts, pulleys and other engine parts.
2. Avoid damaging the charger by keeping the power cord and output cords away from the hood, door or moving engine parts.
3. Note the polarity of the battery posts by checking the identification marks on the battery: POSITIVE (POS, P or +) and NEGATIVE (NEG, N or -). The positive post is usually larger than the negative post.
4. Identify which battery post is grounded or connected to the chassis. THIS IS NORMALLY THE NEGATIVE POST.

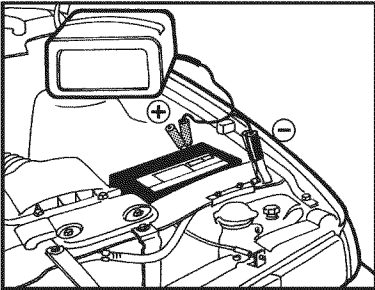

NEGATIVE GROUNDED SYSTEM

5. **Connecting to a negative-grounded system:** Connect the red (POSITIVE) output clamp to the POSITIVE post of the battery. Rock and twist the clamp back and forth to be sure a solid electrical connection is made. Then connect the black (NEGATIVE) output clamp to a heavy, unpainted metal

part of the chassis or engine block, away from the battery (see figure). DO NOT connect clamp to negative battery post, carburetor, fuel line or sheet metal part.

Connecting to a positive-grounded system: Connect the black (NEGATIVE) output clamp to the NEGATIVE post of the battery. Rock and twist the clamp back and forth to be sure a solid electrical connection is made. Then connect the red (POSITIVE) output clamp to a heavy, unpainted metal part of the chassis or engine block, away from the battery. DO NOT connect clamp to positive battery post, carburetor, fuel line or sheet metal part.

6. Plug power cord into a 120V AC 2-prong wall outlet. The charger will be set to the default state of REGULAR charge type, no charge rate (tester mode).
7. Press the appropriate control buttons to select the desired charge rate and charge type. Within a few seconds, the CHARGING (yellow) LED should light and the charging process should start. If the CHECK (red) LED is on, check for correct cable connections.
8. To disconnect the charger, unplug its power cord before attempting to disconnect the output clamps. Then, standing away from the battery, remove the output clamp from the chassis or engine block. Finally, remove the output clamp from the battery post.
9. Clean and store the charger in a dry location.

CHARGING BATTERY REMOVED FROM THE VEHICLE:

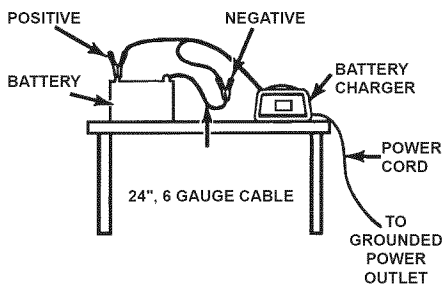

1. Note the polarity of the battery posts by checking the identification marks on the battery: POSITIVE (POS, P or +) and NEGATIVE (NEG, N or -). The positive post is usually larger than the negative post.
2. Attach at least a 24-inch-long, 6-gauge (AWG), insulated battery cable to NEGATIVE (NEG, N or -) battery post. Rock and twist the clamp back and forth to be sure a solid electrical connection is made.
3. Connect the red (POSITIVE) output clamp to the POSITIVE battery post. Rock and twist the clamp back and forth to be sure a solid electrical connection is made.
4. Position yourself as far away from the battery as possible, and then connect the black (NEGATIVE) output clamp to the free end of the cable.
5. Plug the power cord into a 120V AC 2-prong wall outlet. The charger will be set to the default state of REGULAR charge type, no charge rate (tester mode).
6. Press the appropriate control buttons to select the desired charge rate and charge type. Within a few seconds, the CHARGING (yellow) LED should light and the charging process should start. If the CHECK (red) LED is on, check for correct cable connections.
7. To disconnect the charger, unplug its power cord before attempting to disconnect the charger clamps. Then, standing away from the battery, remove the output clamp from the NEGATIVE battery post. Finally, remove the output clamp from the POSITIVE battery post.
8. Clean and store the charger in a dry location.

USING ENGINE START

Your battery charger can be used to jump start your car if the battery is low. Follow these instructions on how to use the ENGINE START feature.

IMPORTANT: Follow all safety instructions and precautions when charging your battery. Wear complete eye protection and clothing protection. Charge your battery in a well-ventilated area.

IMPORTANT: Using the ENGINE START feature WITHOUT a battery installed in the vehicle could cause damage to the vehicle's electrical system.

1. For battery connections, see page 6 and follow instructions 1–6 of CHARGING BATTERY IN THE VEHICLE. With the charger plugged in and connected to the battery of the vehicle, set the CHARGE RATE to 125A START. Only the 125A START, VOLTAGE, and CHARGING LEDs should be lit.
2. Crank the engine until it starts or 5 seconds passes. If engine does not start, wait 3 minutes before cranking again.
3. After the engine starts, unplug the power cord before disconnecting the output clamps from the battery.
4. Clean and store the charger in a dry location.

NOTE: During the starting sequence listed above, the charger is set to one of three states.

1. **Wait for cranking** - The charger waits until the engine is actually being cranked before delivering 125 amps for engine start. The charger delivers charge at a rate of up to 15 amps while waiting and will reset if the engine is not cranked within 15 minutes. (If the charger resets, it sets itself for a 2A charge and REGULAR battery.) While waiting for cranking, the digital display shows the battery voltage (it can't be set to percent).
2. **Cranking** - When cranking is detected, the charger will automatically deliver up to its maximum output (at least 125A) as required by the starting system for up to 5 seconds or until the engine cranking stops. The digital display shows a countdown of the remaining crank time

in seconds. It starts at 5 and counts down to 0.

- Cool Down** - After cranking, the charger enters a mandatory 3-minute (180 second) cool down state. During this period, no settings can be changed. The buttons are ignored. The digital display indicates the remaining cool down time in seconds. It starts at 180 and counts down to 0. The 125A START LED blinks once every second. During the cool down period, no current is delivered to

the battery. After 3 minutes, the 125A START LED will stop blinking and will light continuously, indicating that another crank cycle can be started. The digital display will change from displaying the countdown back to displaying the battery voltage. The CHARGING LED will be lit again.

ENGINE STARTING NOTES:

- If the battery is disconnected during the cool down period, the charger will reset.

USING YOUR BATTERY CHARGER

OVERVIEW

Using this battery charger is very simple. First, connect the battery and AC power following the precautions listed under "OPERATING INSTRUCTIONS". Then select the appropriate CHARGE TYPE and CHARGE RATE for your battery. The charger will then do everything automatically. This section explains a few details.

CHARGING: If the charger does not detect a properly connected battery, the CHECK (red) LED will light continuously until such a battery is detected. Charging will not begin while the CHECK LED is on. When charging begins, the CHARGING LED will be lit.

AUTOMATIC SHUT OFF: When the 2A, 15A or 40A charge rate is selected, the charger is set to perform an automatic charge. When an automatic charge is performed, the charger stops charging automatically after the battery is charged.

ABORTED CHARGE: If charging can't be completed normally, charging will be aborted. When charging is aborted, the charger's output is shut off and the red CHECK LED and digital display blink on and off (at opposite times). In that state, the charger ignores all buttons. To reset from after an aborted charge, either disconnect the battery or unplug the charger.

DESULFATION MODE: If a battery is left discharged for an extended period, it could become sulfated and not accept a normal charge. If the charger detects a sulfated battery, the charger will switch to

a special mode of operation designed for such batteries. Activation of the special desulfation mode is indicated by blinking the CHARGING LED. If successful, normal charging will resume after the battery is desulfated. The CHARGING LED will then stop blinking and light continuously. Desulfation could take up to 10 hours. If desulfation fails, charging will be aborted and the CHECK (red) LED will blink.

COMPLETION OF CHARGING: Charge completion is indicated by the CHARGED (green) LED; when lit, the charger has stopped charging and switched to the Maintain Mode of operation, if the DEEP CYCLE charge type was selected. For other charge types, the CHARGED LED comes on when the battery is charged enough for normal use.

MAINTAIN MODE: When the CHARGED (green) LED is lit, the charger has started Maintain Mode. This mode of operation is also known as Float-Mode Monitoring. In this mode, the charger keeps the battery fully charged by delivering a small current, when necessary. The voltage is maintained at a level determined by the CHARGE TYPE selected. **NOTE:** For charge types other than DEEP CYCLE, the CHARGED LED might be lit before Maintain Mode is started.

GENERAL CHARGING NOTES: The charger is designed to control its cooling fan for efficient operation. Consequently, it is normal for the fan to start and stop when maintaining a fully charged battery. The fan does not run in Tester Mode.

If the charge mode is changed after charging has started (by pressing the CHARGE RATE or CHARGE TYPE button), the charging process will be restarted.

The voltage displayed during charging is the charging voltage and usually will be higher than the battery's resting voltage.

CHARGER CONTROLS

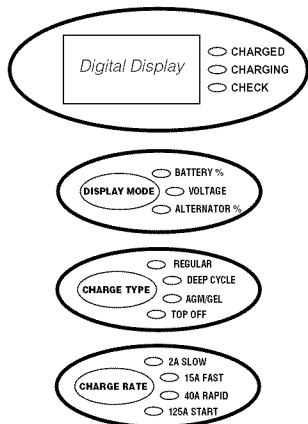

71226 CONTROL PANEL

DISPLAY MODE SWITCH

Use this switch button to set the function of the digital display to one of the following.

- **BATTERY %:** The digital display shows an estimate of the percent of charge of the battery connected to the charger battery clamps.
- **VOLTAGE:** The digital display shows the voltage at the charger battery clamps in DC volts.
- **ALTERNATOR %:** The digital display shows an estimated percentage of the output of the vehicle charging system connected to the charger battery clamps as compared to a properly functioning system.

CHARGE TYPE SWITCH

Use this switch button to set the type of battery to be charged to one of the following.

- **REGULAR:** This is the type of battery usually used in cars, trucks, and motorcycles. These batteries have vent caps and are often marked "low maintenance" or "maintenance-free".
- **DEEP CYCLE:** Deep cycle batteries are usually marked as "deep cycle" or "marine". Deep cycle batteries are usually larger than the other types.

- **AGM/GEL:** AGM and gel cell batteries have sealed cases without vent caps. Such batteries are often smaller than the other types.
- **TOP OFF:** Use the Top Off charge if your battery is not fully charged, but close enough to cause the charger to quickly change to the Maintain mode after one of the other charge types is started. Selecting Top Off will cause the charger to advance to the later stages of its charging process then change to regular maintain mode after charging is complete.

With the exception of AGM and gel cell batteries, all other battery types may or may not have vent caps. *Vent caps are located on top of the battery and provide a means to add distilled water when needed.* Batteries should be marked with their type. If charging a battery that is not marked, check the manual of the item that uses the battery. If the battery type is unknown, use the REGULAR setting. Make sure the battery complies with the safety instructions on page 3.

CHARGE RATE SWITCH

Use this switch button to set the charge rate to one of the following.

- **2A SLOW CHARGE RATE:** Intended for charging small batteries such as those commonly used in garden tractors, snow mobiles and motorcycles. The 2A rate is not intended to be used as a trickle charger for larger batteries.
- **15A FAST or 40A RAPID CHARGE RATE:** Use for charging automotive batteries, marine batteries, and deep cycle batteries. Not intended for industrial applications.
- **125A START:** Provides 125 amps for cranking an engine with a weak or run down battery. Always use in combination with a battery.

NOTE: To turn OFF the charger, unplug from the power cord from the wall outlet.

71226 CONTROL PANEL GUIDE

MODE OF OPERATION

MODE OF OPERATION	Charged	Charging	Check	Battery %	Voltage	Alternator %	2A	15A	40A	125A Start	Regular	Deep-Cycle	AGM, Gel	Top Off	Digital Display
Initial power-up, battery not detected			○		○						○				0.0
No battery or reversed battery detected			○	User selected			User selected			User selected			0% or 0.0V		
Battery tester activated				○							User selected			0~100%	
Battery tester with charged battery	○			○							User selected			100%	
Battery tester with no battery			○	○							User selected			0%	
Voltage meter activated					○						User selected			0.0~17.0V	
Alternator tester activated						○					User selected			0~199%	
Alternator tester on good alternator	○					○					User selected			0~199%	
Alternator tester on bad alternator			○			○					User selected			0~199%	
2 Amp charge with battery detected		○		User sel.			○				User selected			xx% or xx.xV	
15 Amp charge activated		○		User sel.				○			User selected			xx% or xx.xV	
40 Amp charge activated		○		User sel.					○		User selected			xx% or xx.xV	
Charge complete - Maintain Mode started	○			User sel.							User selected			100% or xx.xV	
125A Engine Start															
Waiting for engine crank		○			○					○					1.0~16.0V
Cranking engine		○								○					5→0
Cool down after cranking										B					180→0
Desulfation mode activated		B		User sel.			User selected			User selected			15% or 16V		
Charge aborted			B												8.8.8. (B)

○ indicates an LED that is on continuously.

B indicates an LED that blinks on and off.

USING THE BUILT-IN BATTERY TESTER

OVERVIEW

This battery charger has a built-in battery tester that displays either an accurate battery voltage or an estimate of the battery's relative charge based on the battery voltage and the Battery Council International scale.

TESTING SEQUENCE

There are four basic steps required to use the 71226 as a battery tester.

1. Connect the charger battery clamps to the battery. Be sure to follow all of the precautions listed under "OPERATING INSTRUCTIONS".
2. Connect the charger power cord to a 120V AC 2-prong wall outlet. Again, be sure to follow all of the precautions listed under "OPERATING INSTRUCTIONS".
3. If necessary, press the BATTERY TYPE button until the correct type is indicated.
4. Read the voltage on the digital display or press the display mode button to set the tester to BATTERY % and read the battery percent.

TESTER AND CHARGER

When first turned on, the 71226 operates only as a tester, not as a charger. To continue to use it as only a tester, avoid pressing the CHARGE RATE switch button. Selecting a charge rate activates the battery charger and deactivates the tester. Pressing the CHARGE RATE button when the 125A Start LED is lit (except during the 180 second cool down) will shut off the charger and activate the tester.

POWER-UP IDLE TIME LIMIT

If no switch button is pressed within 15 minutes after the charger is first powered up, the charger will automatically switch from tester to charger, if a battery is connected. In that case, the charger will be set for the 2A charge rate and 12V REGULAR charge type.

TESTER WITHOUT TIME LIMIT

If either the DISPLAY MODE or CHARGE TYPE button is pressed within the first ten minutes after the charger is

powered up, the charger will remain a tester (not a charger) indefinitely, unless a charge rate is selected.

TESTING AFTER CHARGING

After the charger has been changed from tester to charger (by selecting a charge rate), it remains a charger. To change the charger back to a tester, press the CHARGE RATE switch until all CHARGE RATE LEDs are OFF.

TESTER STATUS LEDs

When the 71226 is operating as a battery tester, the status LEDs light under the following conditions:

- The CHARGED (green) LED will light if a charged battery is tested.
- The CHARGING (yellow) LED does not light in the battery test mode.
- The CHECK (red) LED lights unless a properly connected battery is detected.
- When the tester display mode is set to VOLTAGE, the CHARGED and CHARGING LEDs won't light.

INITIAL PERCENT CALCULATION

When a battery % is calculated for the first time after connecting a battery, the digital display will show three dashes ("---") for a period as long as several seconds while the tester analyzes the battery.

NOTES FOR TESTING BATTERY %

A recently charged battery could have a temporarily high voltage due to what is known as "surface charge". The voltage of such a battery will gradually drop during the period immediately after the charging system is disengaged. Consequently, the tester could display inconsistent values for such a battery. For a more accurate reading, the surface charge should be removed by temporarily creating a load on the battery, such as by turning on lights or other accessories.

The battery % ranges from 0 to 100.

The battery tester is only designed to test batteries. Testing a device with a rapidly changing voltage could yield unexpected or inaccurate results.

USING THE BUILT-IN ALTERNATOR TESTER

This battery charger has a built-in alternator tester that displays either an accurate alternator voltage or an estimate of the alternator's relative output compared to normal alternators. The Alternator % values displayed should be taken as general reference, not precise diagnosis. The alternator tester functions the same as the battery tester (see previous section of this manual for details) with a few differences.

TESTING SEQUENCE

There are three basic steps required to use the 71226 as an alternator tester.

1. Connect the charger battery clamps to the battery or charging system. Be sure to follow all of the precautions listed under "OPERATING INSTRUCTIONS".
2. Connect the charger power cord to a 120V AC 2-prong wall outlet. Again, be sure to follow all of the precautions listed under "OPERATING INSTRUCTIONS".
3. Start the vehicle and turn on the vehicle's headlights. Read the voltage on the digital display or press the DISPLAY MODE button to set the tester to ALTERNATOR % and read the alternator percent.

TESTER STATUS LEDs

When the 71226 is operating as an alternator tester, the status LEDs light under the following conditions.

- The CHARGED (green) LED will light if the output of the charging system is at the normally desired level.
- The CHARGING (yellow) LED does not light in the alternator test mode.
- The CHECK (red) LED lights if the VOLTAGE is much higher or lower than normally desired.
- When the tester display mode is set to VOLTAGE, the CHARGED and CHARGING LEDs won't light (it could be testing a battery or an alternator).

ALTERNATOR TESTING NOTES

- The alternator percent display can range from 0 to 199.
- The DISPLAY MODE cannot be set to ALTERNATOR % during charging.

BATTERY PERCENT AND CHARGE TIME

This charger adjusts the charging time in order to charge the battery completely, efficiently and safely. The microprocessor automatically makes the necessary decisions. However, this section includes guidelines that can be used to estimate charging times.

The duration of the charging process depends on three factors:

1. **Battery State** – If a battery has only been slightly discharged, it can be charged in less than a few hours. The same battery could take up to 10 hours if very weak. The battery state can be estimated by using the built-in tester (see page 11). The lower the reading the longer charging will take.
2. **Battery rating** – A higher rated battery will take longer to charge than a lower rated battery under the same conditions. A battery is rated in ampere-hours (AH), reserve capacity (RC) and cold cranking amps (CCA). The lower the rating the quicker the battery will be charged.
3. **Charge rate** – The charge rate is measured in amps. This charger provides charge rates of 2A, 15A and 40A. The 125A rate is for engine start only. The 2A rate is for charging smaller batteries such as those used for motorcycles and garden tractors. Such batteries should not be charged using the 15A or 40A rate. The 15A and 40A rates are for charging larger batteries. In the 40A mode, the charger begins at a low-charge rate and increases the charge rate if it is determined that the battery can accept the higher rate. All charging modes will decrease the charge rate as the battery approaches maximum charge. After the charging process has started, the digital display can be used to determine charging progress by selecting the BATTERY % mode.

There are some important facts to keep in mind when charging a battery.

- When the display indicates 77% charged, the battery has been charged enough to start most vehicles and has already been charged as much as by many other battery chargers.
- When the display indicates 85% charged, the battery has already been charged at least as much as by most other battery chargers.
- The battery % shown in tester mode is an estimate based on the battery voltage and the Battery Council International scale. The battery % shown in charger mode is an estimate of the relative charge in the battery compared to the charge it should have if the charging process is allowed to complete.
- The battery % shown in tester mode can be used to estimate the relative charge time. The lower the % shown, the longer the charge time for a given battery.
- The battery % shown in charger mode is an indication of the relative progress of the charging process. The higher the battery % displayed, the less charge time remains.
- The more a battery is discharged, the faster it absorbs charge from a charger. That means that the battery % increases faster at the beginning of the charging process than at the end. In other words, it takes longer for the battery to absorb the last few percent of charge than the first several percent.

CHARGING TIPS

Read this entire manual before using your charger. The tips below serve only as a guide for specific situations.

If your vehicle won't start: You don't need to fully charge a battery to start your vehicle. If the charger won't start your vehicle using the 125A START rate, try charging the battery using the 40A rate for 10 or 15 minutes. That should charge the battery enough to allow the 125A START rate to start the vehicle. If the vehicle will then be operated continuously for an extended period (such as a long drive), the vehicle could charge the battery back to normal during that period. If the vehicle will only be operated for a short period (short drive), the battery might need to be charged again before it could start the vehicle again.

Reviving your battery: If you only wish to charge your battery enough to operate your vehicle, you don't need to wait for the entire charging process to be completed. When the charger displays a battery % of 77 or more (see page 13), the battery has usually been charged enough for the vehicle to start and operate normally.

Completing an interrupted charge: If the charging process has been interrupted and restarted after the charger displays a battery % of 85 or more, the charger could go straight to Maintain Mode (see page 8). However, if the original charge was started using 40A, the charge can often be completed using the 2A rate.

MAINTENANCE AND CARE

A minimal amount of care can keep your battery charger working properly for years.

1. Clean the clamps each time you are finished charging. Wipe off any battery fluid that may have come in contact with the clamps to prevent corrosion.
2. Coil the input and output cords neatly when storing the charger. This will help prevent accidental damage to the cords and charger.
3. Occasional cleaning of the case of the charger with a soft cloth will keep the finish shiny.

TROUBLESHOOTING

Performance problems often can be corrected by the user. Please read through this chart for a possible solution to common problems.

PROBLEM	POSSIBLE CAUSE	SOLUTION
The battery is connected and the charger is on, but isn't charging.	The charger is in tester mode, not charger mode.	Press the CHARGE RATE button to activate charging and select a charge rate.
Indicator lights are lit in an erratic manner not explained in the "Using Your Battery Charger" section.	You might have accidentally activated a special diagnostic mode. The charger may be defective.	Make sure nothing is touching the control panel, then unplug the charger and plug it in again. Return to place of purchase for replacement.
The CHECK (red) LED always flashes before the battery is completely charged.	The incorrect CHARGE TYPE may have been selected. This will happen if the battery did not reach full charge within 24 hours. May be due to a very large battery or a bank of batteries requiring more power than a 30/12 Amp charger can deliver within 24 hours. The battery may also be faulty.	Reset the charger by unplugging it or briefly disconnecting it or briefly disconnecting the negative battery clip. Select the desired CHARGE RATE and CHARGE TYPE again, if necessary.
Engine crank time is less than specified.	Starter motor may be drawing more than 80 Amps.	Charge the battery at the 40A rate for 10 to 15 minutes then crank the engine.
The green CHARGED LED lights a few minutes after connecting to the battery.	The battery may be fully charged or recently charged, leaving the battery voltage high enough to appear to be fully charged. The incorrect CHARGE TYPE may have been selected.	If the battery is in a vehicle, turn the headlights on for a few minutes to reduce the battery voltage and try charging again. Reset the charger by unplugging it or briefly disconnecting the negative battery clip. Select the desired CHARGE RATE and CHARGE TYPE again, if necessary.

PARTS

This section shows an illustration of your battery charger. Use it to become familiar with part locations and appearance.

Replacement Parts List Sears 71226		
ITEM	DESCRIPTION	PART NUMBER
1	Handle Assembly	2299001477
2	Case, Top	3799004060
3	Faceplate	0899002635
4	Control Board Assembly	2299001463
5	Output Cables and Clamps	3899001198
6	Power Cord	90026135
7	Cord Cleat	1199004390
8	Transformer	93026579
9	Power Board/ Heatsink Assembly	2299001482
10	Circuit Breaker	3999000104
11	Fan	0099000453
12	Case, Bottom	3699001330
13	Instruction Manual	0099000537

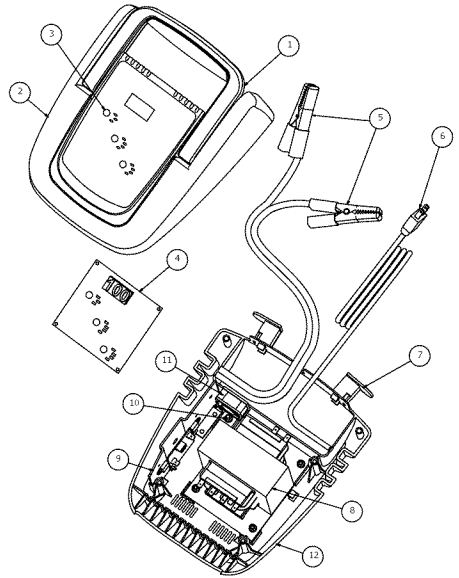

WIRING DIAGRAM

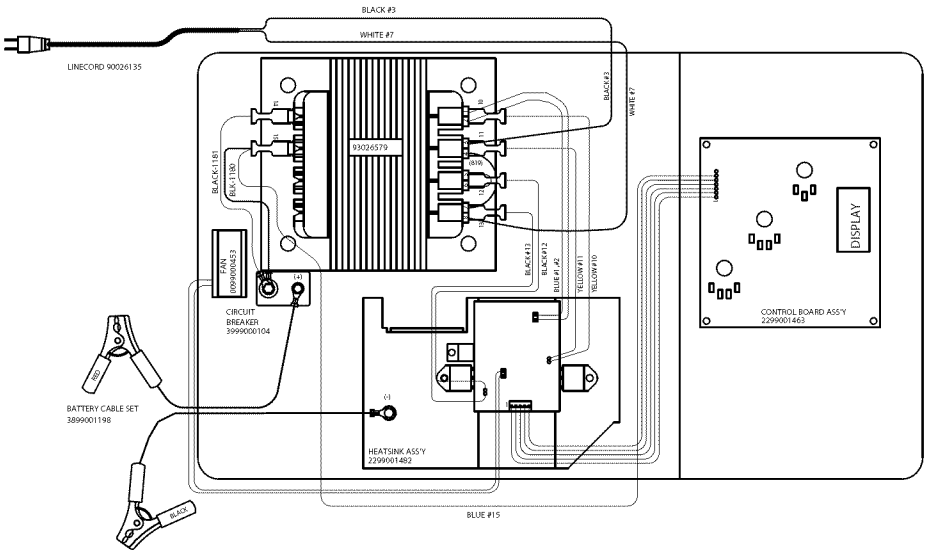

For information about troubleshooting, call toll-free from anywhere in the U.S.A. 7 am to 4:30 pm Central Time Monday through Friday. 1-800-SEARS-64 (1-800-732-7764).

Free Manuals Download Website

<http://myh66.com>

<http://usermanuals.us>

<http://www.somanuals.com>

<http://www.4manuals.cc>

<http://www.manual-lib.com>

<http://www.404manual.com>

<http://www.luxmanual.com>

<http://aubethermostatmanual.com>

Golf course search by state

<http://golfingnear.com>

Email search by domain

<http://emailbydomain.com>

Auto manuals search

<http://auto.somanuals.com>

TV manuals search

<http://tv.somanuals.com>