

SEARS

**OWNERS
MANUAL**

MODEL NO.
608.718571

CAUTION:
Read Rules for
Safe Operation
and Instructions
Carefully

Save These
Instructions



10 AMP / 2 AMP 12 VOLT AUTOMATIC BATTERY CHARGER

FOR 12 VOLT BATTERIES

Operation
Repair Parts

THIS MANUAL WILL HELP YOU USE YOUR SEARS BATTERY CHARGER SAFELY AND EFFICIENTLY

WARNING: WORKING WITH OR NEAR LEAD ACID BATTERIES IS DANGEROUS. BATTERIES CONTAIN SULFURIC ACID AND PRODUCE EXPLOSIVE GASES. A BATTERY EXPLOSION COULD RESULT IN LOSS OF EYESIGHT OR SERIOUS BURNS. PLEASE READ THIS ENTIRE MANUAL CAREFULLY BEFORE USING YOUR CHARGER.

❖ FULL 12 MONTH WARRANTY ❖

If, within twelve months from date of purchase, this battery charger fails due to a defect in materials or workmanship, simply return it to the nearest Sears store throughout the United States, and Sears will repair or replace it, free of charge.

This warranty gives you specific legal rights, and you may also have other rights which vary from state to state.

Sears, Roebuck and Company, Dept. 698/731A, Sears Tower, Chicago, IL 60684

IMPORTANT SAFETY INSTRUCTIONS SAVE THESE INSTRUCTIONS

1. This manual contains important safety and operating instructions applicable to the use of battery charger model number 608.718571.
2. Do not expose charger to rain or snow.
3. Use of an attachment not recommended or sold by the battery charger manufacturer may result in a risk of fire, electric shock, or injury of persons.
4. To reduce risk of damage to electric plug and cord, pull by plug rather than cord when disconnecting charger.
5. An extension cord should not be used unless absolutely necessary. Use of improper extension cord could result in a risk of fire or electric shock. If extension cord must be used, make sure:
 - a. That pins on plug of extension cord are the same number, size, and shape of those of plug on charger;
 - b. That extension cord is properly wired and in good electrical condition; and
 - c. That wire in cord is proper size as follows: Minimum recommended AWG wire size for various length extension cords used with this charger:

Length of Cord, Feet	25	50	100	150
AWG Size	18	18	16	14

6. Do not operate charger with damaged cord or plug. Replace them immediately.
7. Do not operate charger if it has received a sharp blow, been dropped, or otherwise damaged in any way; take it to the nearest Sears Service Center.
8. Do not disassemble charger; take it to the nearest Sears Service Center when service or repair is required. Incorrect reassembly may result in a risk of electric shock or fire.
9. To reduce risk of electric shock, unplug charger from outlet before attempting any maintenance or cleaning. Turning off controls will not reduce this risk.

PERSONAL PRECAUTIONS

1. Remove personal metal items such as rings, bracelets, necklaces, and watches when working with a lead-acid battery. A lead-acid battery can produce a short circuit current high enough to weld jewelry to metal, causing a severe burn.
2. Someone should be within range of your voice or close enough to come to your aid when you work near a lead-acid battery.
3. Have plenty of fresh water and soap nearby in case battery acid contacts skin, clothing or eyes.
4. Wear complete eye protection and clothing protection. Avoid touching eyes while working near battery.
5. Clothing will be damaged if it comes in contact with battery acid.
6. If battery acid contacts skin or clothing, wash immediately with soap and water. If acid contacts eyes, immediately flood eyes with running cold water for at least 15 minutes and get medical attention immediately.
7. NEVER smoke or allow a spark or flame in vicinity of battery or engine.
8. Be extra cautious to reduce risk of dropping a metal tool onto battery. It might spark or short-circuit battery or other electrical parts that may cause explosion.
9. Use charger for charging a LEAD-ACID battery only. It is

not intended to supply power to a low-voltage electrical system other than in an automotive application. Do not use battery charger for charging dry-cell batteries that are commonly used with home appliances. These batteries may burst and cause injury to persons and damage to property.

10. DO NOT ATTEMPT TO CHARGE A FROZEN BATTERY . . . If the case is not cracked, remove the battery to a warm area until the ice has completely melted before attempting to charge.

WARNING — RISK OF EXPLOSIVE GASES.

1. WORKING IN VICINITY OF A LEAD-ACID BATTERY IS DANGEROUS. BATTERIES GENERATE EXPLOSIVE GASES DURING NORMAL BATTERY OPERATION. FOR THIS REASON, IT IS OF UTMOST IMPORTANCE THAT EACH TIME BEFORE USING YOUR CHARGER, YOU READ THIS MANUAL AND FOLLOW THE INSTRUCTIONS EXACTLY.
2. To reduce risk of battery explosion, follow these instructions and those published by battery manufacturer and manufacturer of any equipment you intend to use in vicinity of battery. Review cautionary marking on these products and on engine.

GROUNDING AND AC POWER CORD CONNECTION INSTRUCTIONS

Charger should be grounded to reduce risk of electric shock. Charger is equipped with an electric cord having an equipment-grounding conductor and a grounding plug. The plug must be plugged into an outlet that is properly installed and grounded in accordance with all local codes and ordinances.

DANGER — Never alter AC cord or plug provided - if it will not fit outlet, have proper outlet installed by a qualified electrician. Improper connection can result in a risk of an electric shock.

This battery charger is for use on a nominal 120 volt circuit and has a grounding plug that looks like the plug illustrated in sketch A in Figure 1. A temporary adapter, which looks like the adapter illustrated in sketches B and C, may be used to connect this plug to a two-pole receptacle as shown in sketch B if a properly grounded outlet is not available. The temporary adapter should be used only until a properly grounded outlet can be installed by a qualified electrician.

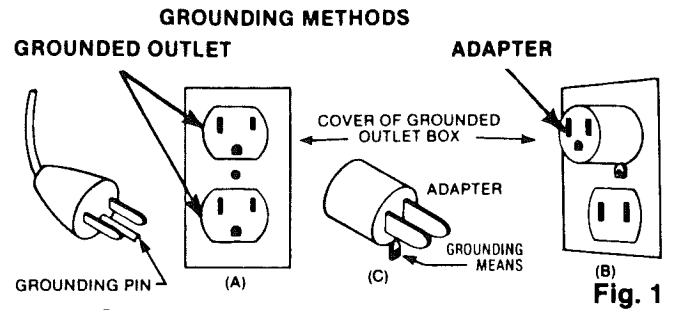

DANGER — Before using adapter as illustrated, be sure that center screw of outlet plate is grounded. The green colored rigid ear or lug extending from adapter must be connected to a properly grounded outlet - make certain it is grounded. If necessary, replace original outlet cover plate screw with a longer screw that will secure adapter ear or lug to outlet cover plate and make ground connection to grounded outlet.

PREPARING TO CHARGE

1. If necessary to remove battery from vehicle to charge, always remove grounded terminal from battery first. Make sure all accessories in the vehicle are off, so as not to cause an arc.
2. Be sure area around battery is well ventilated while battery is being charged. Gas can be forcefully blown away by using a piece of cardboard or other non-metallic material as a fan.
3. Clean battery terminals. Be careful to keep corrosion from coming in contact with eyes.
Keep the battery terminals clean and tight. Use Sears terminal protectors to prevent corrosion. (Available through most Sears stores or catalog.)
4. If battery has removable filler vents, check periodically to make sure battery electrolyte (liquid) covers the plates. If liquid is down, add only DISTILLED WATER to bring level up. This also helps purge excessive gas from the cells.
NOTE: DO NOT OVERFILL (OVERFILLING COULD RESULT IN DAMAGE). For a battery without cell caps, carefully

follow manufacturer's charging instructions.

5. Study all battery manufacturer's specific precautions such as removing or not removing cell caps while charging, and recommended rates of charge.
6. Determine voltage of battery by referring to car owner's manual. This charger can be used to charge only 12 volt batteries.

CHARGER LOCATION

1. Locate charger as far away from battery as the DC cables permit.
2. Never place charger directly above battery being charged; gases from battery will corrode and damage charger.
3. Never allow battery acid to drip on charger when reading specific gravity or filling battery.
4. Do not operate charger in a closed-in area or restrict ventilation in any way.
5. Do not set battery on top of charger.

OPERATING INSTRUCTIONS

Your new Sears automatic battery charger is a home type automotive charger designed to charge 12 V batteries of either conventional or maintenance free construction. The rated output current is 10 amperes for large batteries and 2 amperes for smaller batteries such as on motorcycles, garden tractors, etc.

When operating your charger carefully follow the steps under CHARGING BATTERY IN VEHICLE or CHARGING BATTERY OUT OF VEHICLE. After completion of Step 7, the meter on the charger will indicate the amount of DC amperes of charge being delivered to the battery. This charging rate will taper off as the battery comes up to full charge. In automatic chargers the

voltage is limited to a preset level to prevent overcharging. The charge rate drops to a very low pulsating rate to maintain battery charge level. If current is drawn from the battery as in some type of standby operation, the charger will automatically come on to compensate.

DEEP CYCLE CHARGING — [To charge deep cycle batteries, you must monitor the charging to insure the size battery you are charging permits the voltage to increase to the preset trickle trip point of the control circuit.] If the battery becomes very warm ($\cong 125^{\circ}\text{F}$) or appears to be bubbling freely charging should be stopped.

DC CONNECTION PRECAUTIONS

1. Connect and disconnect DC output clips only after removing AC cord from electric outlet. Never allow clips to touch each other.
2. Attach clip to battery post and twist or rock back and forth several times to make a good connection. This helps to keep clip from slipping off terminal and helps to reduce risks of sparking. Attach grounding clip to engine block or unpainted car frame, away from gas line and carburetor.

CHARGING BATTERY IN VEHICLE

FOLLOW THESE STEPS WHEN BATTERY IS INSTALLED IN VEHICLE. A SPARK NEAR BATTERY MAY CAUSE BATTERY EXPLOSION. TO REDUCE RISK OF A SPARK NEAR BATTERY:

1. Position AC and DC cords to reduce risk of damage by hood, door or moving engine parts.
2. Stay clear of fan blades, belts, pulleys and other parts that can cause injury.

3. Check polarity of battery posts. POSITIVE (POS, P, +) battery post usually has a larger diameter than NEGATIVE (NEG, N, -) post.
4. Determine which post of battery is grounded (connected) to the chassis. If negative post is grounded to chassis (as in most vehicles), see item 5. If positive post is grounded to chassis, see item 6.
5. For common negative-grounded vehicle, connect POSITIVE (RED) clip from battery charger to POSITIVE (POS, P, +) ungrounded post of battery. Connect NEGATIVE (BLACK) clip to vehicle chassis or engine block away from battery. Do not connect clip to carburetor, fuel lines, or sheet-metal body parts. Connect to a heavy gage metal part of the frame or engine block.
6. For positive-grounded vehicle, connect NEGATIVE (BLACK) clip from battery charger to NEGATIVE (NEG, N, -) ungrounded post of battery. Connect POSITIVE (RED) clip to vehicle chassis or engine block away from battery. Do not connect clip to carburetor, fuel lines, or sheet-metal body parts. Connect to a heavy gage metal part of the frame or engine block. Set control to 10 amp or 2 amp.
7. ONLY - After completing steps 1 through 6, plug the power cord of the charger into grounded 120 volts, 60 Hz outlet.

PROPER DISCONNECT PROCEDURE

1. ALWAYS unplug the charger power cord before doing anything else.
2. Then disconnect the grounded clamp from the engine block or framework.
3. Finally, disconnect the remaining clamp from the battery terminal.

CHARGING BATTERY OUT OF VEHICLE

FOLLOW THESE STEPS WHEN BATTERY IS OUTSIDE VEHICLE. A SPARK NEAR THE BATTERY MAY CAUSE BATTERY EXPLOSION. TO REDUCE RISK OF A SPARK NEAR BATTERY:

1. Check polarity of battery posts. POSITIVE (POS, P, +) battery post usually has a larger diameter than NEGATIVE (NEG, N, -) post.
2. Attach at least a 24-inch-long 6-gauge (AWG) insulated battery cable to NEGATIVE (NEG, N, -) battery post. (This can be a standard automobile battery cable available through your Sears Auto Center or other auto parts store.)
3. Connect POSITIVE (RED) charger clip to POSITIVE (POS, P, +) post of battery.
4. Position yourself and free end of cable as far away from the battery as possible - then connect NEGATIVE (BLACK) charger clip to free end of cable.
5. Do not face battery when making final connection. Set control to desired current 10 or 2 amp.
6. ONLY - After completing steps 1 through 5, insert power cord to a grounded outlet of 120 volts, 60 Hz.
7. A marine (boat) battery must be removed and charged on shore. To charge it on board requires equipment specially designed for marine use.

PROPER DISCONNECT PROCEDURE

1. ALWAYS unplug the charger power cord before doing anything else.
2. Then disconnect the negative (black) lead from the end of the 24 inch cable.
3. Finally, disconnect positive (red) lead from battery post.

CHARGER OVERLOAD PROTECTION

Your Sears battery charger is protected from power overload by two automatic heat sensing switches. One is in the DC output

circuit (item 7 on your parts list), the other is built on the transformer. The first will operate when a short circuit, reverse connections, or too long engine cranking overloads the charger. The protector will open with a click sound and reclose in a few seconds. The second protector will operate when a prolonged overload due to a defective battery or other excessive load causes the transformer to overheat. It is a one time device and once it functions the transformer must be replaced.

TIME REQUIRED TO CHARGE

1. A battery is fully charged when:
 - a. A hydrometer reading of the electrolyte liquid reaches 1.250 or above (all cells should have approximately the same reading).
 - b. The charger rate drops to a very low pulsating rate to maintain battery charge level. (3-5) hours for most 12 volt batteries or (5-8) hours for smaller 12 volt batteries at 2 amperes.
2. OVERCHARGING OF BATTERIES SHOULD BE AVOIDED AS MUCH AS POSSIBLE. Overcharging causes excessive gassing, loss of water, and eventual damage to the battery. Charging should be stopped if battery becomes very warm (over about 125 Degrees Fahrenheit) or appears to be bubbling freely.

POSSIBLE CHARGING PROBLEMS

1. Meter needle swings to far right side of meter: Your new battery charger has been equipped with an automatic reset circuit breaker. This protects the charger from temporary overload conditions. A severely discharged battery, a battery with shorted cells, or reversed charger connections at the battery will cause this protective device to operate.
Under these overload conditions, the circuit breaker will open, and when cooled down will reset automatically. This cycling process can be identified by a clicking sound made during the opening and closing of the circuit breaker.
 - a. Check for reverse polarity connections.
 - b. If battery is severely discharged, charge meter needle will start to cycle up and down, and will stabilize after 15 to 20 minutes.
 - c. Battery may have one or more shorted cells. Cycling will start immediately and continue indefinitely. If cycling has not stopped as outlined in (b), disconnect charger (AC power cord first) and have battery tested.
2. No meter reading:
 - a. Check connections to battery and engine block or car frame. Be sure polarity is correct (red clip to positive). "Rock" the clips to bite through any dirt or corrosion. If in a vehicle, be sure terminals on battery are clean and tight.
 - b. Check AC outlet or extension cord connections.
 - c. One or more cells may be shorted. Thermal switch in charger may cycle (click on and off).

MAINTENANCE AND CLEANING

Very little maintenance is required. As with any appliance or tool, a few common sense rules will prolong the life of your battery charger.

ALWAYS BE SURE CHARGER IS UNPLUGGED BEFORE DOING ANY MAINTENANCE OR CLEANING.

1. Store in a clean, dry place.
2. Coil up cords when not in use.
3. Clean case and cords with a dry or slightly damp cloth.
4. Clean any corrosion from clips with a solution of water and baking soda.
5. Examine cords periodically for cracking or other damage. Have them replaced if necessary.

SERVICE

A parts list, assembly drawing, etc. are provided for use by service personnel.

WARNING: TO REDUCE THE RISK OF ELECTRIC SHOCK, DO NOT PERFORM ANY SERVICING OTHER THAN THAT CONTAINED IN THE OPERATING INSTRUCTIONS UNLESS YOU ARE QUALIFIED TO DO SO.

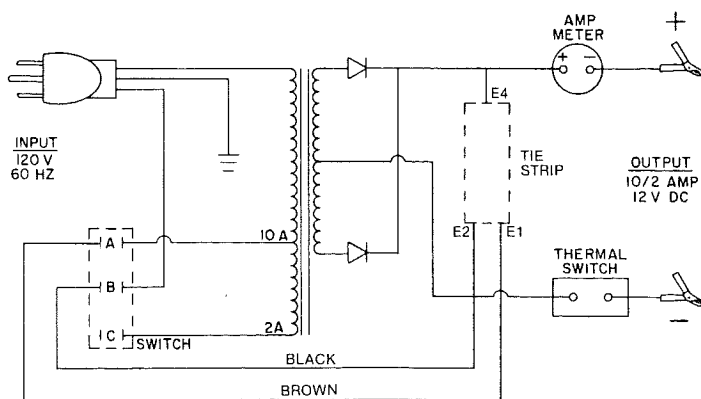
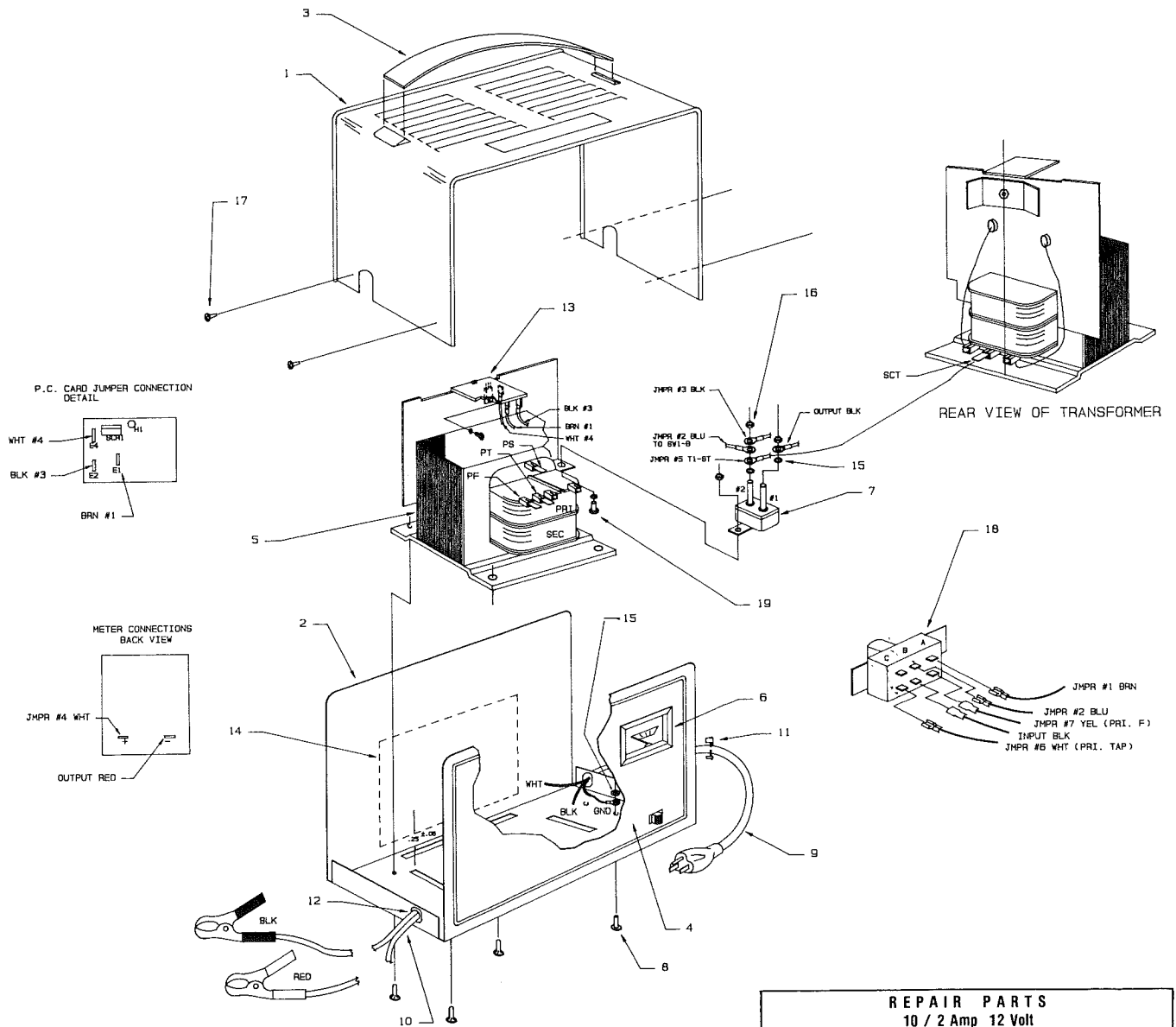

REPAIR PARTS 10 / 2 Amp 12 Volt Battery Charger MODEL NO. 608.718571

Key	Part Number	Description
1	SD-122262	Cover
2	SD-30-122599	Case
3	SA-1-128431	Handle
4	SB-135724	Decal
5	ST-91340	Transformer
6	SA-1490528	Meter
7	SA-2-133344	Thermal Switch
8	**	Rivet
9	SA-1-1320517	Input Cord
10	SA-83986	Output Cord
11	SA-105350	Strain Relief
12	SA-105598	Strain Relief
13	SB-1-134371B	P.C. Assembly
14	SA-128299	Warning Label
15	*STD-551210	No. 10 Lockwasher (3)
16	*STD-541110	No. 10-32 Hex Nut (3)
17	*STD-510605	No. 6-32 x 1/2 Screw
	SA-135726	Owner's Manual & Parts List
18	SA-1591008	Switch
19	*	10-32 x 3/8 Screw

**For Replacement Use:

- *STD-511103 No. 10-32 x 3/8 Screw (4)
- *STD-541210 No. 10 Lockwasher (2)
- *STD-541110 No. 10-32 Hex Nut (4)

*Standard Hardware - may be purchased locally.

HOW TO USE YOUR BATTERY CHARGER

1. This charger is for 12 volt batteries.
2. Make sure battery is in a well-ventilated area.
3. Do not smoke, strike a match or cause any sparks in the vicinity of the battery.
4. For a negative grounded vehicle:
 - a. Connect RED (+) clip to (+) terminal on battery.
 - b. Connect BLACK (-) clip to engine block away from battery. Do not connect to battery terminal. (A spark near the battery may cause battery explosion.)

When charging battery out of vehicle:

 - 1) Connect a 24" minimum length of No. 6 gauge insulated battery cable to negative (-) battery terminal.
 - 2) Connect RED (+) clip to (+) terminal.
 - 3) Connect BLACK (-) clip to jumper cable away from battery. Do not connect to battery terminal. (A spark near the battery may cause battery explosion.)
5. Select desired charging amperage.
6. Plug the AC (input cord) into a grounded outlet.
7. Charger Disconnect
 - a) Disconnect AC (input cord).
 - b) Remove BLACK (-) clip.
 - c) Remove RED (+) clip.

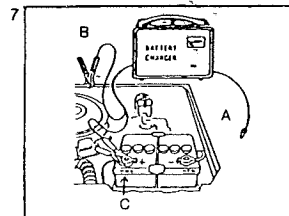
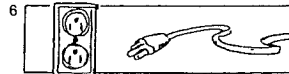
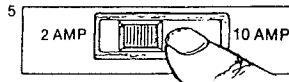
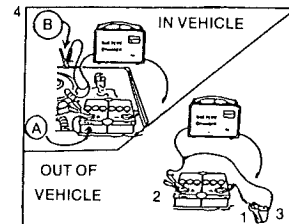
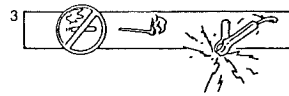
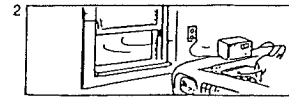
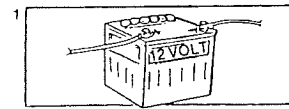

SEARS

OWNERS MANUAL

MODEL NO. 608.718571

HOW TO ORDER REPAIR PARTS

10 AMP / 2 AMP 12 VOLT AUTOMATIC BATTERY CHARGER

Now that you have purchased your battery charger, should a need ever exist for repair parts or service, simply contact any Sears Service Center and most Sears, Roebuck and Co. stores. Be sure to provide all pertinent facts when you call or visit.

The model number of your battery charger will be found on the front panel.

WHEN ORDERING REPAIR PARTS, ALWAYS GIVE THE FOLLOWING INFORMATION:

- PART NUMBER
- PART DESCRIPTION
- MODEL NUMBER
- NAME OF ITEM

All parts listed may be ordered from any Sears Service Center and most Sears stores.

If the parts you need are not stocked locally, your order will be electronically transmitted to a Sears Repair Parts Distribution Center for handling.

Free Manuals Download Website

<http://myh66.com>

<http://usermanuals.us>

<http://www.somanuals.com>

<http://www.4manuals.cc>

<http://www.manual-lib.com>

<http://www.404manual.com>

<http://www.luxmanual.com>

<http://aubethermostatmanual.com>

Golf course search by state

<http://golfingnear.com>

Email search by domain

<http://emailbydomain.com>

Auto manuals search

<http://auto.somanuals.com>

TV manuals search

<http://tv.somanuals.com>