

OWNER'S OPERATION AND INSTALLATION MANUAL

PL600HYLA/PL600HYLB

60,000BTU/Hr

PN750HYLA/PN750HYLB

75,000BTU/Hr

Manually Controlled



⚠ WARNING: If the information in this manual is not followed exactly, a fire or explosion may result causing property damage, personal injury, or loss of life.

⚠ FOR YOUR SAFETY:
Do not store or use gasoline or other flammable vapors and liquids in the vicinity of this or any other appliance.

WHAT TO DO IF YOU SMELL GAS:

- Shut off supply to the appliance.
- Extinguish any open flames.
- Immediately call your gas supplier. Follow the gas supplier's instructions.
- If you can not reach your gas supplier, call the fire department.

Installation and service must be performed by a qualified installer, service agency or the gas supplier.

⚠ IMPORTANT: Read this owner's manual carefully and completely before trying to assemble, operate, or service this heater.

⚠ WARNING: Improper installation, adjustment, alteration, service, or maintenance can cause injury or property damage. Read the installation, operating and maintenance instructions thoroughly before installing or servicing this equipment

⚠ WARNING: For Outdoor Use Only. Do not use for cooking

**Save this manual for future reference.
Installer: Leave this manual with customer.**

GENERAL INFORMATION

These instructions are intended as a general guide and do not supersede national or local codes in anyway. Authorities having jurisdiction should be consulted before installation.

Installation and provision for combustion and ventilation air must confirm with the national Fuel Gas Code. This campfire has been tested to, and complies with IAS 4-96 1997, U, S, Requirements for Outdoor Gas Fireplace

TABLE OF CONTENTS

<i>GENERAL INFORMATION</i>	2
<i>SAFETY INFORMATION</i>	3
<i>INSTALLATION</i>	5
<i>OPERATING HEATER</i>	7
<i>MAINTENANCE AND STORAGE</i>	8
<i>PRODUCT FEATURES</i>	9
<i>SPECIFICATION</i>	10
<i>TROUBLESHOOTING</i>	10
<i>PARTS LIST</i>	11
<i>WARRANTY</i>	end



Liquid propane units are designed and certified for use only with household liquid propane supply period. Do not use “portable” propane tanks of less than 100-lbs, Capacity, LP units cannot be operated with 20-lb. Propane tanks commonly used with portable, liquid propane gas grills.

SAFETY INFORMATION

THIS GAS APPLIANCE IS DESIGNED FOR OUTDOOR USE ONLY. IT IS NOT INTENDED FOR INSTALLATION IN ANY BUILDING, GARAGE OR ENCLOSED STRUCTURE. IT IS NOT INTENDED FOR INSTALLATION IN OR ON RECREATIONAL VEHICLES OR BOATS.

 **WARNING:** Follow all gas leak procedures in this manual, prior to operation.

 **WARNING:** Fuels used in gas fired appliances, and the products of combustion of such fuels, contain chemicals known to the State of California to cause cancer, birth defects and /or other reproductive harm. This warning is issued pursuant to California Health & Safety Code Sec.25249.1

While this appliance is not in use, the gas must be turned off at the gas supply.

While this appliance is not in use, it should be covered to protect it from weather and other adverse elements.

DO NOT ATTEMPT TO DISCONNECT THE GAS OR ANY GAS FITTING WHILE THIS APPLIANCE IS IN OPERATION.

Inspect the gas connections of this appliance prior to each use. Do not operate the unit if there is a gas leak present.

Do not put anything flammable, on or around or beneath the campfire.

NEVER Leave the campfire unattended while in operation.

NEVER Allow children to operate this appliance.

NEVER Lean over the campfire or place hand or fingers on the screen cover or near flame.

NEVER Use liquid propane gas in a natural gas unit, or natural gas in a liquid propane unit. Gas conversions **SHOULD ONLY BE DONE BY A QUALIFIED SERVICE TECHNICIAN.** **DO NOT** use charcoal briquettes or lighter fluid in any campfire.

Storage of this appliance indoors is permissible only if the gas is disconnected.

PROPER CLEARANCES FROM COMBUSTIBLE, CONSTRUCTION AND MATERIALS MUST BE MAINTAINED FROM ALL SIDES, TOP AND BOTTOM OF THIS APPLIANCE.

THIS APPLIANCE SHOULD NEVER BE PLACED ON ANY COMBUSTIBLE SURFACE.

THIS APPLIANCE SHOULD NEVER BE PLACED UNDER ANY COMBUSTIBLE CONSTRUCTION OR MATERIALS.

THIS APPLIANCE SHOULD NEVER BE PLACED CLOSER THAN FORTY-EIGHT (48") INCHES FROM ANY SIDE TO ANY COMBUSTIBLE CONSTRUCTION OR MATERIALS.

Location

Your campfire can be installed on a flat, stable surface, away from any combustible materials or construction. (See Figure 13)

Place unit on any level, outdoor, non combustible surface.

NOTE: Do not place this appliance on grass or dirt area, this may prevent proper venting.

HARD PIPING TO UNIT WITHOUT GAS PROXIMITY

1. TURN OFF THE GAS SUPPLY SYSTEM

NOTE: All gas connections (except for brass to brass) require the following:

Clean pipe threads using either a wire brush or steel wool. Apply Teflon tape or pipe dope to the steel fittings before making any connection.

BE CAREFUL! Make sure all gas connections are snug, but not over tighten!

2. Extend the gas supply system using 1/2" black iron pipe from current house supply. This may be accomplished by a teeing off" or tapping into a convenient gas line connection; installing the necessary pipe for the distance required; and then installing a manual valve at exterior house wall. If pipe is to pass through a foundation or house wall, make sure to re-seal the area around the pipe with weather sealant.

3. From manual valve, extend piping to the campfire.

Location Continue

Note :If pipe is to be placed in an underground trench, check with local codes for required depth and material construction.

4. Connect the 3/8" male flare brass fitting (furnished with campfire) to the 1/2" steel piping making sure to clean the pipe threads and use Teflon tape or pipe dope.(FLEX LINE NOT SUPPLIED)
5. Connect the 1/2" female X 3/8" male flare brass fitting to the 3/8" female brass flare fitting, as assembled on the right side of the gas line, of the right side of the campfire.

NOTE: Brass to brassw connections do not require teflon tape or pipe dope.

(Note: show drawing of hard piping installation.

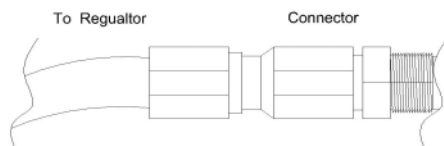

Children and adults should be alerted to the hazards of high surface temperatures and should stay away to avoid burns or clothing ignition.

Young children should be carefully supervised when they are in the area of the appliance.

- Never leave the appliance unattended during operation.
- Clothing or other flammable materials should not be placed on or near the appliance.
- Any guard or other protective device removed for servicing the appliance must be replaced prior to operating the appliance
- Installation and repair should be done by a qualified service person.. The appliance should be inspected before use and at least annually by a qualified service person. More frequent cleaning may be required as necessary. It is imperative the control compartment, burners and circulating air passageways of the appliance be kept clean.
- Inspect the fuel supply connection before each use of the appliance.

- Storage of this appliance indoors is permissible only if it has been disconnected from its fuel supply. (natural gas line or LP gas)

LOCAL CODES

Install and use heater with care. Follow all local codes. In the absence of local codes, use the latest edition of The National Fuel Gas Code, ANSZ223.1, also known as NFPA54*.

Available from :

American National Standards Institute, INC.

1430 Broadway, New York, NY10018

National Fire Protection Association, INC.

Battery march Park Quincy. MA 02269

Do not use this appliance if any part has been under water. Immediately call a qualified service technician to inspect the appliance and to replace any part of control system and any gas control which has been under water.

IMPORTANT: Installation of natural gas and LP should be done by a qualified installer, service agency or gas supplier.

The appliance and its manual shutoff valve must be disconnected from the gas supply piping system during any pressure testing of the system at test pressures in excess of 1/2 psig (3.5kPa).

This appliance must be isolated from the gas supply piping system by closing its manual shutoff valve during any pressure testing of the gas supply piping system at test pressures equal to or less than 1/2 psig (3.5kPa).

Installation

LOGS LIST

PL600HYLA PN750HYLA

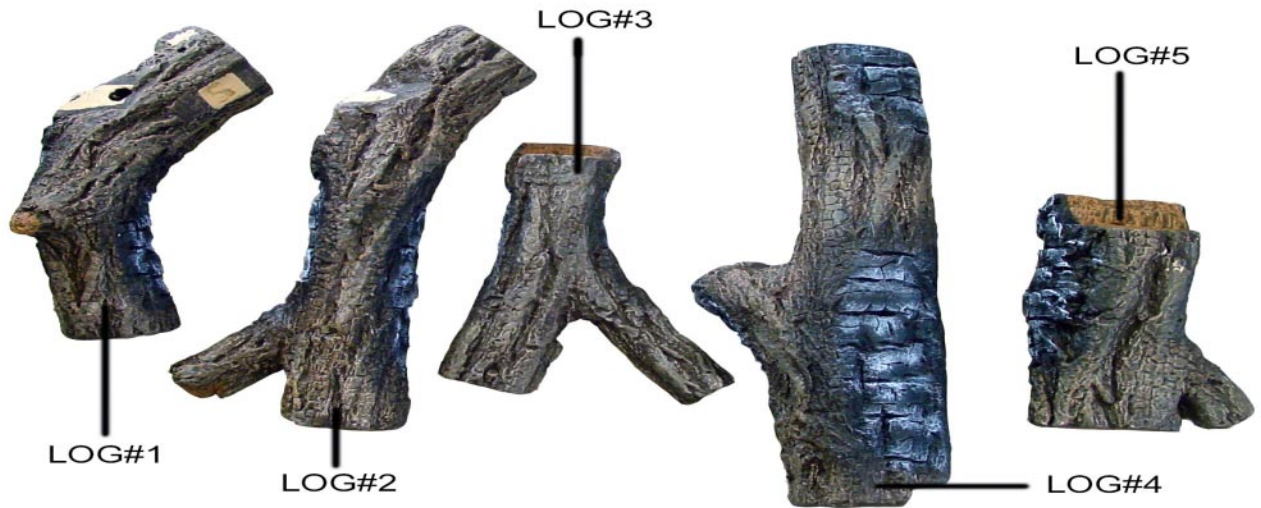

FIG 2 The LOG sets for PL600HYLA/ PN750HYLA

PL600HYLB PN750HYLB

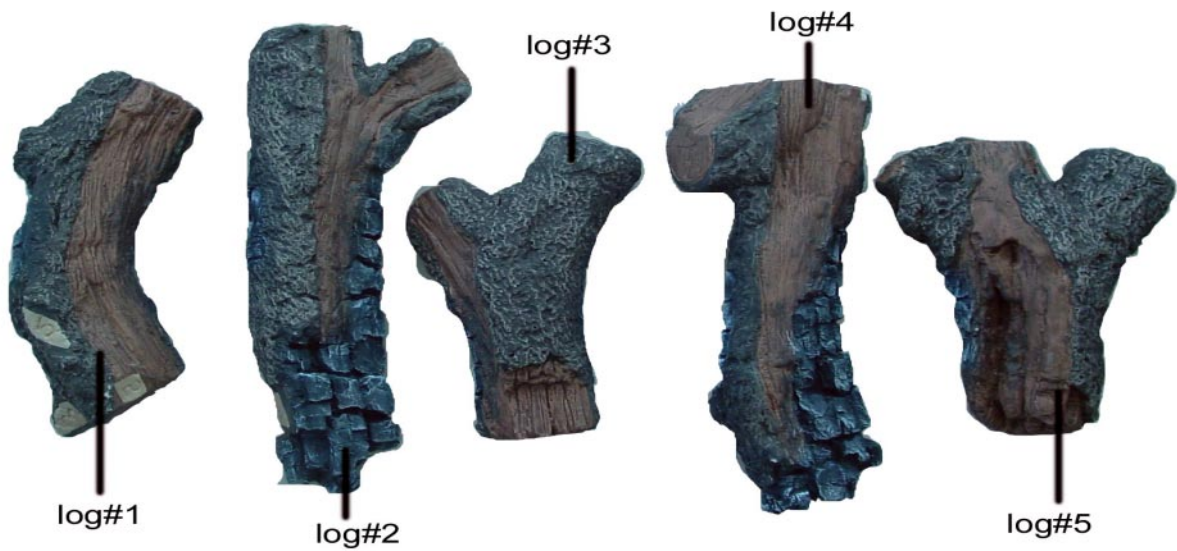

FIG 3 The LOG sets for PL600HYLB/ PN750HYLB

Installation *continue*

Check to make sure you have the correct parts before assembling.

. Logs: 5

Caution: Some of the steel edges may be sharp. Please use caution when assembling the unit.

INSTALLATION INSTRUCTIONS:

1. Remove log from inside the box. Please note each log fits the number marked on foam package.
2. Next remove campfire from box.
3. You may use bricks or blocks to create your surround to place your campfire on.
4. Make sure that the campfire is placed on a flat surface.
5. Check the log piece (FIG-4).



Fig.-4 Check the log piece

6. Make sure that the logs were installed correctly. (FIG.-5).(Base logs are pre-installed.)



Fig.-5 Install and check the base logs

7. Install the No.#1 log as indicated on base log .Fix the log on the bracket by the screw . (FIG.-6).



Fig. 6 Install the LOG #1

8. Install the No.#2 log as indicated on base log. (FIG.-7).



Fig. -7 install the LOG #2

9. Install the No.#3 log as indicated on the base log (FIG.-8).



Fig. -8 install the LOG #3

Installation (continue)

11. install the No. # 4 log as indicated on the base (FIG.-9).



Fig. -9 Install the LOG #4

12. Install the No. #5 Log as indicated on the base log (FIG. 10).



FIG. -10 Insatll the LOG #5

FUEL REQUIREMENTS:

Natural gas models

- I - Connect the ON/OFF gas valve of the appliance to the incoming gas supply line. See Figure 10. -
- Make certain all gas connections are right.
- Turn the ON/OFF valve at the appliance slowly to the "ON" position. Use a soap and water solution to test for leaks.

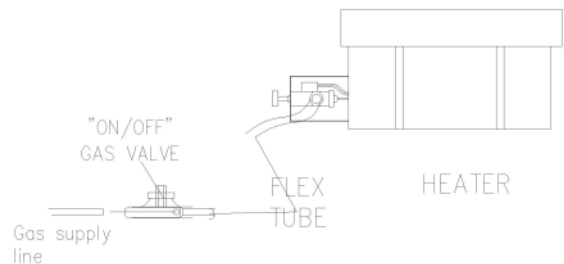

Fig. 11 Natural gas burner assembly

OPERATING HEATER

Your campfire burener is build to operate with natural gas or build for LP gas.

This appliance is lit a piezo ignitor, follow these instructions exactly when lighting the campfire. BEFORE LIGHTING, smell around the appliance the appliance area for gas. Be sure to smell to next to the ground as liquid propane gas heavier than air and will settle to the ground.



Follow adaptable lighting instructions. Apply soap solution to all joints. Bubbles forming indicates a leak. Do not use a match or an open flame to detect leak. Light heater after ensuring that no gas leak exists.

CONNECTING TO GAS SUPPLY

Note: Apply a mixture of liquid soap and water to all joints. **Do not use an open flame.** Bubbles forming show a leak. Check all connections for leaks immediately.

LIGHTING INSTRUCTIONS

⚠ WARNING: FOR YOUR SAFETY READ BEFORE LIGHTING

1. STOP! Read the safety information above.
2. Make sure manual shutoff valve is fully open.
3. Press in and turn control knob clockwise  90 degree to the OFF position.
4. Wait five (5) minutes to clear out any gas. Then smell for gas around log set and near floor. If you smell gas, STOP! Follow the safety information above. If you don't smell gas, go on to the next step.
5. Turn control knob counterclockwise  90 degree to the PILOT position and press in. Keep control knob pressed in for five(5) seconds.

Note: You may be running this log set for first time after hooking up to gas supply. If so, the control knob may need to be pressed in for 30 seconds. This will allow air to bleed from the gas system.

6. With control knob pressed in, push down and release ignitor button. This will light the pilot. The pilot is attached to the side of the front burner. If needed, keep pressing ignitor button until pilot lights.

NOTE: If pilot does not stay lit, contact a qualified service person or PRO-COM's 800# on the back of this manual. Until repairs are made, light pilot with the piezo.

7. Keep control knob pressed in for 30 seconds after lighting pilot. After 30 seconds, release control knob.

Note: If pilot goes out, repeat steps 3 through 7.



If control knob does not pop up when released, contact a qualified service person or PRO-COM's 800# on the back of this manual.

8. Turn control knob counterclockwise  90 degree to the ON position. Burner should light. If burner does not light, call a qualified service person or PRO-COM's 800# on the back of this manual.

⚠ WARNING: If you do not follow these instructions exactly, a fire or explosion may result causing property damage, personal injury or loss of life.

TO TURN OFF GAS TO APPLIANCE

Shutting Off Appliance

1. Turn control knob clockwise  90 degrees to the PILOT position.
2. Press in and turn control knob  clockwise 90 degrees to OFF position.

Shutting Off Burner Only (pilot stays lit)

Turn control knob clockwise  90 degrees to the PILOT position.

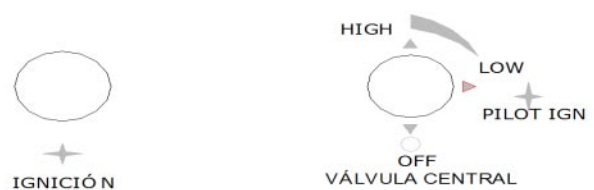

Fig12 The operating board

MAINTENANCE AND STORAGE

1. Storage of an appliance indoors is permissible only if the gas supply system is disconnected and removed from the appliance. .
2. Have the heater inspected by qualified service man before each use or at least annually.
3. Check the POL fitting for any damage before each use and replace if any damage is found.
4. Spiders and insects can nest and live in outdoor appliances, especially in the burners and orifices. This will interrupt the normal flow of LP gas to the heater and can be a very dangerous situation. Inspect for insect infiltration of burner/orifice when one of the following occurs:
 - A. The smell of gas along with predominating yellow tipping of the burner flames.
 - B. Heater can not reach desired temperature.
 - C. Uneven burner flow.
 - D. Burner makes popping noises during normal use or shutdown.
5. Adopt rainproof cover (provided with the heater) to avoid rust of heater when not in use.

PRODUCT FEATURES

SAFETY PILOT

The heater has a pilot with a safety shutoff system. The safety pilot is a required feature for outdoor heaters. It shuts off the heater if flame is extinguished by rough wind.

PIEZO IGNITION SYSTEM

This heater has a piezo igniter. This system requires no matches, batteries, or other sources to light heater.

VALVE CONTROL SYSTEM

This heater has a control valve to control the gas flow, with the control valve, you can chose the proper flame of the fire.

Option Screen

For Your safety

You may purchase the screen to maintain a clearance around the campfire

CAUTION

PLEASE DO NOT TOUCH SCREEN OR PLACE ANY OBJECTS ON SCREEN WHILE BURNER IS ON

Children and adults should be alerted to the hazards of high surface temperatures and should stay away from SCREEN to avoid burns or clothing ignition,



FIG. 13 The screen

SERVICE INDICATIONS:

A hazardous condition may result if a heater has been modified or is not functioning properly. When the heater is working properly:

1. The flame is essentially yellow.
2. There is no strong disagreeable odor, eye burning or other physical discomfort.
3. No smoke or soot exists internal or external to the campfire.
4. No unplanned or unexplained shut down of the heater occur.

REPLACEMENT

REPLACEMENT PARTS:

Note: Use only original replacement parts. This will protect your warranty coverage for parts replaced under warranty.

PARTS UNDER WARRANTY:

Contact authorized dealers of this product. If they can't supply original replacement part(s) call PRO-COM's Technical Service Department at 1-877-886-5989 for referral information.

When calling PRO-COM or your dealer, have ready

- Your name
- Your address
- Model and serial numbers of your heater
- How heater was malfunctioning
- Type of gas used (propane/LP or natural gas)
- Warranty card
- Usually, we will ask you to return the defective part back to retail store.

PARTS NOT UNDER WARRANTY:

Contact authorized dealers of this product or Parts Central if they can't supply original replacement part (s) Call PRO-COM's Parts Department at 1-877-886-5989 for referral information.

When calling PRO-COM, have ready

- Model number of your heater
- The replacement part number

ACCESSORIES

Purchase the accessories from your local dealer or Parts Central. If they cannot supply these accessories call PRO-COM's Sales Department at 1-877-886-5989 for referral information. You can also write to the address listed on the back page of this manual.

HIGH ALTITUDE DERATE

In the U.S.A., Input BTU shall be derated 4%(1 orifice size) per 1000ft, for above 2000ft.. In Canada, input BTU shall be derated 10% (2 orifice size) at altitudes from 2000ft.to 4500ft..

SPECIFICATIONS

Model	L600HYLA/B	PN750HYLA/B
Btu (LP/NG)	60.000	75.000
Gas Type	LP	NG
Ignition	Piezo	Piezo
Inlet Gas Pressure* (In. of water)		
Maximum	14"	10.5"
Minimum	11"	5.5"
Dimensions, Inches (H x W x D)		
Stove	17 3/4" x22 7/8"x18 1/8"	17 3/4" x22 7/8"x18 1/8"
Carton	15" x25 "x20 1/4"	15" x25 "x20 1/4"
Weight, Lbs		
Stove	32/33	32/ 33
Shipping Weight	55/58	55/ 58

* For purpose of shipment adjustment.

Minimum clearances: Bottom: (This appliance may not be place on any combustibile materials)
 Top: 8 FT. (2.4m)
 Side /walls (around): 48 inch (1220mm)

TROUBLESHOOTING

OBSERVED PROBLEM	POSSIBLE CAUSE	REMEDY
Burner does not light	<ol style="list-style-type: none"> Air in gas lines. Inlet gas pressure is too low. Gas supply turned off. Air passageway on heater blocked. Burner orifice clogged. Control knob not in ING/ON position. Control knob not fully pressed in while in ING/ON position. 	<ol style="list-style-type: none"> Continue holding down control knob. Repeat igniting operation until air is removed. Check gas pressure. Fully open gas supply. Check air passageway. Clean burner. Turn control knob to ING/ON position. Press down control knob.
When ignitor buttons pressed in, there is no spark at safety Pilot.	<ol style="list-style-type: none"> Ignitor electrode positioned wrong. Ignitor broken. Broken ignitor cable. Ignitor electrode not connected to ignitor cable. 	<ol style="list-style-type: none"> Reposition ignitor. Replace pilot Replace ignitor cable. Connect electrode to ignitor cable.
Burner fire does not last.	<ol style="list-style-type: none"> Damaged thermocouple. Thermocouple electrode corrosion. Damaged control valve. Control knob not pressed long enough. Thermocouple connection loose at control valve. Pilot flame not touching thermocouple. 	<ol style="list-style-type: none"> Replace thermocouple. Clean thermocouple electrode. Replace control valve. After pilot lights, keep control knob pressed in for 30 seconds. Hand tighten connection or replace thermocouple. Contact qualified service man.

PARTS LIST

PL600HYLA/PL600HYLB

PN750HYLA/PN750HYLB

KEY NO.	PART NUMBER	DESCRIPTION	QTY.	
			LP	NG
1	PL001-01	Lower Bracket 1	1	1
2	PL001-02	Lower Bracket 2	1	1
3	PL002-01	Burner Bracket	1	1
4	PL003-01	Boarding	1	1
5	PL007-01	LOG Bracket	1	1
6	NDW0804	Thermocouple	1	1
7	PL004-01	Valve bracket	1	1
8	M083-02	Ignitor	1	1
9	NV2050-A	Valve	1	1
10	NDW0807-B	Electrical & Ignition cable	1	1
11	PB31-003	Line to pilot	1	1
12	NDW-L600x4	Pilot Ignition ASM	1	-
13	NDW-N600x4	Pilot Ignition SAM	-	1
14	PL008-01	Injector	1	-
15	PL008-02	Injector	-	1
16	PB31-001	Line to burner	-	1
17	PB25-001	P Series Burner	1	1
18	PL006-01	Valve Support	1	1
19	PB52-01	Control Knob	1	1
20	PL022-01	Connect	1	1
21	ZL012-01	Connect to Regulator	1	
22	NR02-02	Regulator	1	

ILLUSTRATED PARTS BREAKDOWN

PL600HYLA / PL600HYLB
PN750HYLA / PN750HYLB

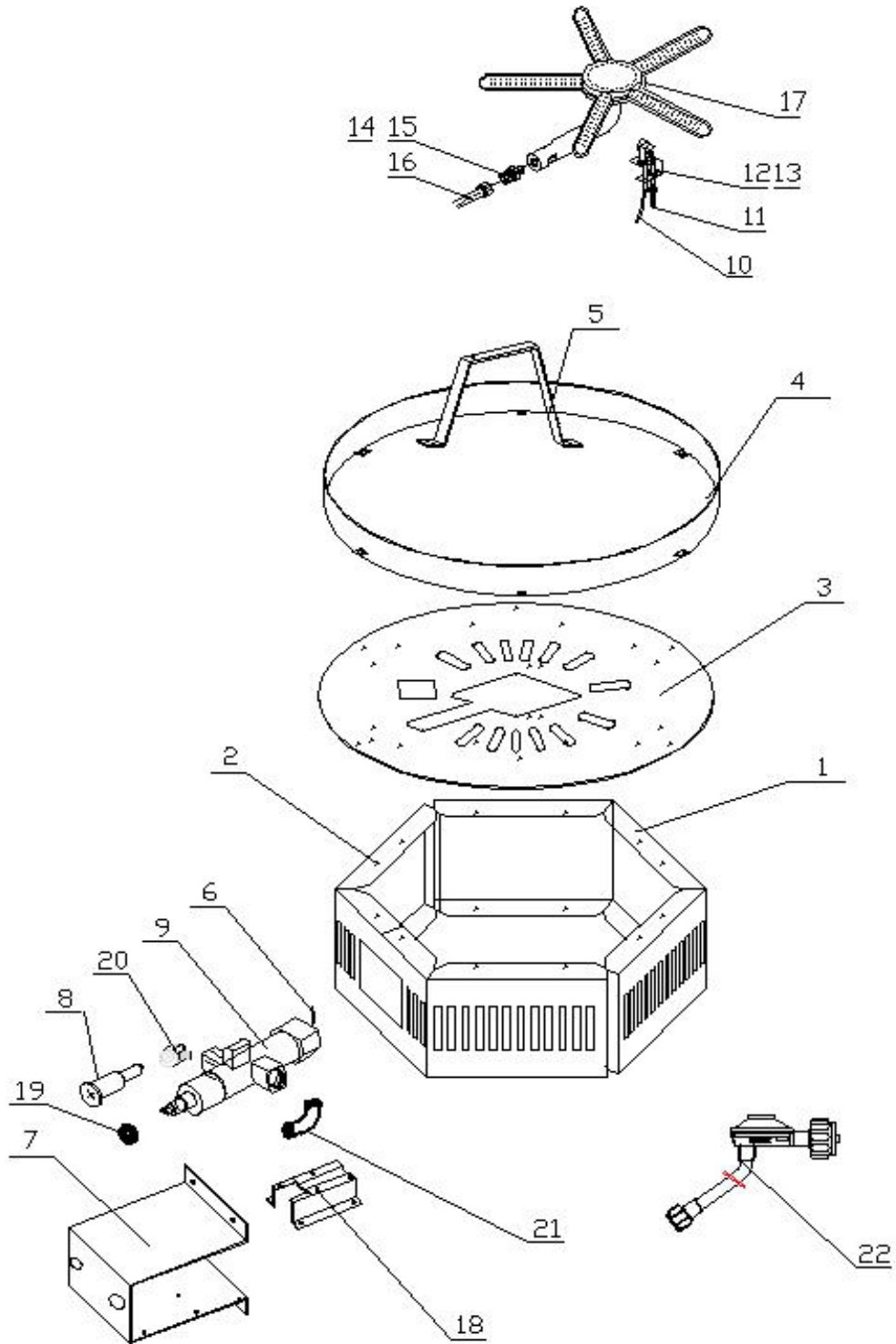

WARRANTY INFORMATION

KEEP THIS WARRANTY

Model: _____
Serial No. _____
Date Purchased _____

Always specify model and serial numbers when communicating with PRO-COM.

We reserve the right to amend these specifications at any time without notice. The only warranty applicable is our standard written warranty. We make no other warranty, expressed or implied.

LIMITED WARRANTY PRO-COM OUTDOOR CAMPFIRE

PRO-COM warrants this product to be free from defects in materials and components for one (1) years from the date of first purchase, provided that the product has been properly installed, operated and maintained in accordance with all applicable instructions, to make a claim under this warranty, the Bill of Sale or cancelled check must be presented.

This warranty is extended only to the original retail purchaser. This warranty covers the cost of part(s) required to restore this heater to proper operating condition and an allowance for labor when provided by a PRO-COM Authorized Service Center. Warranty part(s) MUST be obtained through authorized dealers of this product and/or PRO-COM who will provide original factory replacement parts. Failure to use original factory replacement parts voids this warranty. The heater MUST be installed by a qualified installer in accordance with all local codes and instructions furnished with the unit.

This warranty does not apply to parts that are not in original condition because of normal wear and tear or parts that fail or become damaged as a result of misuse, accidents, lack of proper maintenance or defects caused by improper installation. Travel, diagnostic cost, labor, transportation and any and all such other costs related to repairing a defective heater will be the responsibility of the owner.

TO THE FULL EXTENT ALLOWED BY THE LAW OF THE JURISDICTION THAT GOVERNS THE SALE OF THE PRODUCT, THIS EXPRESS WARRANTY EXCLUDES ANY AND ALL OTHER EXPRESSED WARRANTIES AND LIMITS THE DURATION OF ANY AND ALL IMPLIED WARRANTIES INCLUDING WARRANTIES OF MERCHANTABILITY AND FITNESS FOR A PARTICULAR PURPOSE TO ONE (1) YEAR ON ALL COMPONENTS FROM THE DATE OF FIRST PURCHASE. NANJING PRO-COM'S LIABILITY IS HEREBY LIMITED TO THE PURCHASE PRICE OF THE PRODUCT AND NANJING PRO-COM SHALL NOT BE LIABLE FOR ANY OTHER DAMAGES WHATSOEVER INCLUDING INDIRECT, ACCIDENTAL OR CONSEQUENTIAL DAMAGES.

Some states do not allow a limitation on how long an implied warranty lasts or an exclusion or limitation of accidental or consequential damages, the above limitation on implied warranties, or exclusion or limitation on damages may not apply to you.

This warranty gives you specific legal right, and you may also have other rights that vary from state to state.

For information about this warranty please write to:

NANJING PRO-COM ELECTRIC APPLIANCE CO., LTD.
#6 CHUANGYE ROAD, HIGH NEW TECHNOLOGY & DEVELOPMENT ZONE,
GREAT BRIDGE ROAD NORTH, NANJING, 210061, CHINA.

Patent Pending

PRO-COM TOLL- FREE NUMBER: 1- 877- 886- 5989

Free Manuals Download Website

<http://myh66.com>

<http://usermanuals.us>

<http://www.somanuals.com>

<http://www.4manuals.cc>

<http://www.manual-lib.com>

<http://www.404manual.com>

<http://www.luxmanual.com>

<http://aubethermostatmanual.com>

Golf course search by state

<http://golfingnear.com>

Email search by domain

<http://emailbydomain.com>

Auto manuals search

<http://auto.somanuals.com>

TV manuals search

<http://tv.somanuals.com>