

Operating Instructions DVD Video Camera

Model No. **VDR-D300**
VDR-D250

- The illustration shows VDR-D300.
- VDR-D250 does not have a built-in flash.

Before using

Setup

Recording

Playback

Editing

Disc and card management

With other products

With a computer

Others

Before connecting, operating or adjusting this product, please read the instructions completely. Spanish Quick Use Guide is included. Guía para rápida consulta en español está incluida.

LEICA DICOMAR (VDR-D300)



For USA assistance, please call: 1-800-211-PANA(7262) or, contact us via the web at: <http://www.panasonic.com/contactinfo>

For Canadian assistance, please call: 1-800-561-5505 or visit us at www.panasonic.ca



LSQT1011 B

Things You Should Know

Thank you for choosing Panasonic!

You have purchased one of the most sophisticated and reliable products on the market today. Used properly, we're sure it will bring you and your family years of enjoyment. Please take time to fill in the information on the right.

The serial number is on the tag located on the underside of your camera. Be sure to **retain this manual** as your convenient camera information source.

Date of Purchase

Dealer Purchased From

Dealer Address

Dealer Phone No.

Model No.

Serial No.

Safety Precautions

WARNING: TO PREVENT FIRE OR SHOCK HAZARD, DO NOT EXPOSE THIS EQUIPMENT TO RAIN OR MOISTURE.

CAUTION: TO PREVENT FIRE OR SHOCK HAZARD AND ANNOYING INTERFERENCE, USE THE RECOMMENDED ACCESSORIES ONLY.

CAUTION: DANGER OF EXPLOSION IF BATTERY IS INCORRECTLY REPLACED. REPLACE ONLY WITH THE SAME OR EQUIVALENT TYPE.

CAUTION: USE OF CONTROLS OR ADJUSTMENTS OR PERFORMANCE OF PROCEDURES OTHER THAN THOSE SPECIFIED HEREIN MAY RESULT IN HAZARDOUS RADIATION EXPOSURE.

- Since this product gets hot during use, operate it in a well ventilated place; do not install this equipment in a confined space such as a bookcase or similar unit.



CAUTION
RISK OF ELECTRIC SHOCK
DO NOT OPEN



CAUTION: TO REDUCE THE RISK OF ELECTRIC SHOCK,
DO NOT REMOVE COVER (OR BACK)
NO USER-SERVICEABLE PARTS INSIDE
REFER SERVICING TO QUALIFIED SERVICE PERSONNEL



This symbol warns the user that un-insulated voltage within the unit may have sufficient magnitude to cause electric shock. Therefore, it is dangerous to make any kind of contact with any inside part of this unit.



This symbol alerts the user that important literature concerning the operation and maintenance of this unit has been included. Therefore, it should be read carefully in order to avoid any problems.

AC Adaptor

- The rating plate is on the underside of the AC Adaptor.

WARNING

AS WITH ANY SMALL OBJECT, SD CARDS CAN BE SWALLOWED BY YOUNG CHILDREN. DO NOT ALLOW CHILDREN TO HANDLE THE SD CARD.

**CLASS 1
LASER PRODUCT**

IEC 60825-1:2001

CAUTION

This product contains a laser diode of higher class than 1. To ensure continued safety, do not remove any covers or attempt to gain access to the inside of the product. Refer all servicing to qualified personnel.

FCC Note: This equipment has been tested and found to comply with the limits for a Class B digital device, pursuant to Part 15 of the FCC Rules. These limits are designed to provide reasonable protection against harmful interference in a residential installation. This equipment generates, uses, and can radiate radio frequency energy and, if not installed and used in accordance with the instructions, may cause harmful interference to radio communications. However, there is no guarantee that interference will not occur in a particular installation. If this equipment does cause harmful interference to radio or television reception, which can be determined by turning the equipment off and on, the user is encouraged to try to correct the interference by one or more of the following measures:

- Reorient or relocate the receiving antenna.
- Increase the separation between the equipment and receiver.
- Connect the equipment into an outlet on a circuit different from that to which the receiver is connected.
- Consult the dealer or an experienced radio/TV technician for help.

FCC Caution: To assure continued compliance, follow the attached installation instructions and use only shielded interface cables with ferrite core when connecting to computer or peripheral devices.

Any changes or modifications not expressly approved by the party responsible for compliance could void the user's authority to operate this equipment.

Declaration of Conformity (U.S.A. only)

Trade Name: Panasonic
Model No.: VDR-D250/VDR-D300
Responsible party: Panasonic Corporation of North America
One Panasonic Way, Secaucus, NJ 07094
Support Contact: Panasonic Consumer Electronics Company
1-800-211-PANA (7262)

This device complies with Part 15 of the FCC Rules. Operation is subject to the following two conditions: (1) This device may not cause harmful interference, and (2) this device must accept any interference received, including interference that may cause undesired operation.

This class B digital apparatus complies with CANADIAN ICES-003.

U.S.A./CANADA CONSUMERS: ATTENTION:



A lithium ion/polymer battery that is recyclable powers the product you have purchased. Please call 1-800-8-BATTERY for information on how to recycle this battery.

Panasonic

VDR-D250/
VDR-D300



Tested To Comply
With FCC Standards

FOR HOME OR OFFICE USE

IMPORTANT SAFETY INSTRUCTIONS

- 1) Read these instructions.
- 2) Keep these instructions.
- 3) Heed all warnings.
- 4) Follow all instructions.
- 5) Do not use this apparatus near water.
- 6) Clean only with dry cloth.
- 7) Do not block any ventilation openings. Install in accordance with the manufacturer's instructions.
- 8) Do not install near any heat sources such as radiators, heat registers, stoves, or other apparatus (including amplifiers) that produce heat.
- 9) Do not defeat the safety purpose of the polarized or grounding-type plug. A polarized plug has two blades with one wider than the other. A grounding type plug has two blades and a third grounding prong. The wide blade or the third prong are provided for your safety. If the provided plug does not fit into your outlet, consult an electrician for replacement of the obsolete outlet.
- 10) Protect the power cord from being walked on or pinched particularly at plugs, convenience receptacles, and the point where they exit from the apparatus.
- 11) Only use attachments/accessories specified by the manufacturer.
- 12) Use only with the cart, stand, tripod, bracket, or the table specified by the manufacturer, or sold with the apparatus. When a cart is used, use caution when moving the cart/apparatus combination to avoid injury from tip-over.
- 13) Unplug this apparatus during lightning storms or when it will be left unused for long periods of time.
- 14) Refer all servicing to qualified service personnel. Servicing is required when the apparatus has been damaged in any way, such as when the power-supply cord or plug is damaged, liquid has been spilled or objects have fallen into the apparatus, the apparatus has been exposed to rain or moisture, does not operate normally, or has been dropped.



Precautions

USE & LOCATION

WARNING

- **TO AVOID SHOCK HAZARD** ... Your camera and power supply should not be exposed to rain or moisture. Do not connect the power supply or operate your camera if it gets wet. Your camera has been designed for outdoor use, however it is not designed to sustain direct exposure to water, rain, sleet, snow, sand, dust, or a direct splashing from a pool or even a cup of coffee. This action could permanently damage the internal parts of your camera. Do not attempt to disassemble this unit. There are no user serviceable parts inside. Unplug your camera from the power supply before cleaning.

CAUTION

- **DO NOT AIM YOUR CAMERA AT THE SUN OR OTHER BRIGHT OBJECTS**
- **DO NOT LEAVE THE CAMERA WITH THE EVF AIMED DIRECTLY AT THE SUN AS THIS MAY CAUSE DAMAGE TO THE INTERNAL PARTS OF THE EVF**
- **DO NOT EXPOSE YOUR CAMERA TO EXTENDED HIGH TEMPERATURE** ... Such as, in direct sunlight, inside a closed car, next to a heater, etc... This action could permanently damage the internal parts of your camera.

■ Indemnity concerning recording content

The manufacturer shall in no event be liable for the loss of recordings due to malfunction or defect of this unit, its accessories or recordable media.

IMPORTANT

■ Carefully observe copyright laws

Whatever you have recorded and created can be used for your personal entertainment only. Under copyright laws, other materials cannot be used without obtaining permission from the holders of the copyrights.

- **AVOID SUDDEN CHANGES IN TEMPERATURE** ... If the unit is suddenly moved from a cold place to a warm place, moisture may form on the disc and inside the unit.
- **DO NOT LEAVE YOUR CAMERA OR THE POWER SUPPLY TURNED ON WHEN NOT IN USE.**
- **STORAGE OF YOUR CAMERA** ... Store and handle your camera in a manner that will not subject it to unnecessary movement (avoid shaking and striking). Your camera contains a sensitive pick-up device which could be damaged by improper handling or storage.

CARE

- **TO CLEAN YOUR CAMERA** ... Do not use strong or abrasive detergents when cleaning your camera body.
- **TO PROTECT THE LENS** ... Do not touch the surface of the lens with your hand. Use a commercial camera lens solution and lens paper when cleaning the lens. Improper cleaning can scratch the lens coating.
- **TO PROTECT THE FINISH OF YOUR CAMERA** ... Before handling your camera, make sure your hands and face are free from any chemical products, such as suntan lotion, as it may damage the finish.

-If you see this symbol-



Information on Disposal in other Countries outside the European Union

This symbol is only valid in the European Union.
If you wish to discard this product, please contact your local authorities or dealer and ask for the correct method of disposal.

- SD Logo is a trademark.
- Apparatus Claims of U.S. Patent Nos. 4,631,603, 4,577,216, and 4,819,098, licensed for limited viewing.
This product incorporates copyright protection technology that is protected by method claims of certain U.S. patents and other intellectual property rights owned by Macrovision Corporation and other rights owners. Use of this copyright protection technology must be authorized by Macrovision Corporation, and is intended for home and other limited viewing uses only unless otherwise authorized by Macrovision Corporation. Reverse engineering or disassembly is prohibited.
- Manufactured under license from Dolby Laboratories.
“Dolby” and the double-D symbol are trademarks of Dolby Laboratories.
- LEICA is a registered trademark of Leica microsystems IR GmbH and DICOMAR is a registered trademark of Leica Camera AG.
- Microsoft®, Windows® and DirectX® are either registered trademarks or trademarks of the Microsoft Corporation in the United States and/or other countries.
- IBM and PC/AT are registered trademarks of International Business Machines Corporation of the U.S.
- Intel®, Pentium® and Celeron® are the registered trademarks or trademarks of the Intel Corporation.
- Macintosh, Mac OS and QuickTime are trademarks of Apple Computer, Inc., registered in the U.S. and other countries.
- Microsoft product screen shot(s) reprinted with permission from Microsoft Corporation.
- Other names of systems and products mentioned in these instructions are usually the registered trademarks or trademarks of the manufacturers who developed the system or product concerned.

These operating instructions are designed for use with models VDR-D300 and VDR-D250. Pictures may be slightly different from the original.

- The illustrations used in these operating instructions show model VDR-D300, however, parts of the explanation refer to different models.
- Depending on the model, some functions are not available.
- Features may vary, so please read carefully.

Contents

Before using

Features	9
Quick Guide	11
Accessories	14
Parts identification and handling	15
Using the LCD monitor	19
Using the viewfinder	19
Using the remote control	20
Discs and cards	23
Discs that can be used on this unit	23
Cards that you can use with this unit	26
Disc and card handling	27

Setup

Power supply	28
Charging the battery	28
Connecting to the AC outlet	30
Turning the unit on/off	30
Inserting/removing a disc	32
Inserting/removing an SD card	34
Selecting a mode	35
How to use the joystick	36
Switching the language	41
Using the menu screen	42
Setting date and time	45
Adjusting LCD monitor/viewfinder	47

Recording

Before recording	48
Recording motion pictures	50
Changing the recording mode of the motion picture	51
Recording still pictures	52
Number of pixels and picture quality for still picture recording	54
Various recording functions	56
Zoom in/out function	56
Recording yourself	57
Backlight compensation function	58
Fade in/fade out function	59
Soft skin mode	61
Tele macro function	62
MagicPix function	63
Self-timer recording	64
Wind noise reduction function	65
Wide mode	66
Image stabilizer function	67

Built-in flash (VDR-D300 only)	68
Manual recording functions	70
Scene mode	70
Manual focus adjustment	72
White balance	73
Manual shutter speed/ aperture adjustment	75

Playback

Motion picture playback	76
Still picture playback	79
Playing back still pictures as a slide show	80

Editing

Editing scenes	81
Deleting scenes	81
Dividing a scene	83
Combining scenes	84
Using playlists	85
What is a playlist?	85
Creating a new playlist	86
Playing back a playlist	87
Editing a playlist	88
Editing still pictures	94
Deleting still pictures	94
Locking still pictures	96
DPOF setting	97

Disc and card management

Formatting discs and cards	98
Formatting discs	98
Formatting an SD card	99
Finalizing a disc	100
Finalizing a disc	100
Un-finalizing a DVD-RW	101
Protecting a disc	102
Displaying disc information	103

With other products

With a TV	104
Playback on TV	104
With a DVD recorder/player	106
Playback on DVD recorder/player	106
Copying (dubbing) recordings onto a DVD recorder's hard disk	107

With a VCR	108
Recording (dubbing) images onto other video devices	108
With a printer (PictBridge)	109

With a computer

Before using with a computer

(Windows)	111
What you can do with a computer	111
Contents on provided CD-ROM	112
Operating environment	114
End User License Agreement	117

Installation (Windows)	118
Installing DVD-RAM Driver	118
Installing DVD-MovieAlbumSE	120
Installing DVDfunSTUDIO	121
Reading the operating instructions of the software applications	122
Software application uninstallation	122

Connection and recognition

(Windows)	123
Connection and recognition procedures	123
About the computer display	124
To disconnect USB cable safely	125
Verifying the unit is correctly recognized by the computer	126

Creating a DVD-Video disc on a computer (Windows)	127
Creating a DVD-Video on a computer from a DVD-RAM or DVD-RW (VR format)	127

Before using with a computer

(Macintosh)	130
What you can do with a computer	130
Contents on provided CD-ROM	131
Operating environment	133

Installation (Macintosh)	135
Reading the operating instructions of the software applications	136
Software application uninstallation	136

Using discs on a computer

(Macintosh)	137
Creating a DVD-Video on a computer from a recorded disc	137
To disconnect USB cable safely	139

Using an SD card on a computer

(Macintosh)	140
Connection	140
Copying still picture files to a computer	141
To disconnect USB cable safely	141

Others

Menus	142
Menu list	142
Other menus	144
Indications	145
Indications	145
Messages	147
Functions that cannot be used simultaneously	149
Frequently asked questions	150
Troubleshooting	152
Cautions for use	159
Explanation of terms	163
Specifications	165
Number of recordable pictures on an SD card	167
Optional accessories	168
DVD video camera accessories	168
Accessory Order Form (For USA Customers)	169
Request for Service Notice (USA Only)	170
Limited Warranty (For USA Customers)	171
Customer Services Directory	172
Warranty (For Canadian Customers)	173
Index	174
Spanish Quick Use Guide/ Guía española para el uso rápido ...	176

Features

■ Easy recording! (→ 50)

No need to search for the recording start position.

The new recording will not overwrite any previously recorded scene.

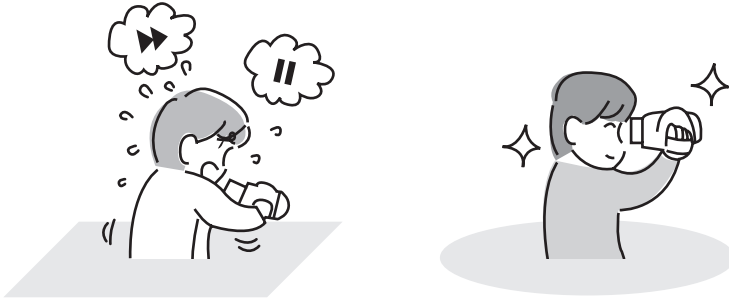

■ Easy playback! (→ 76)

Recorded scenes are displayed as thumbnails.

You can easily search for the scenes you want to watch.

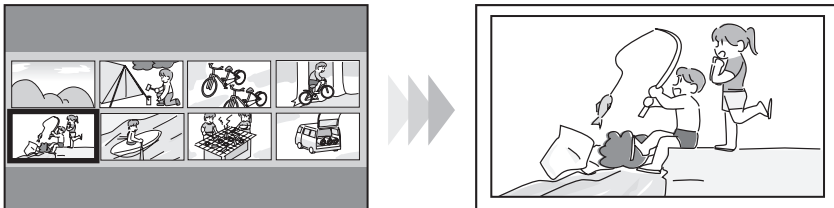

■ Editing scenes! (→ 81, 85)

You can create an original video (playlist) by collecting your favorite scenes together and then easily record (dub) this video to a VCR or a DVD recorder hard disk.

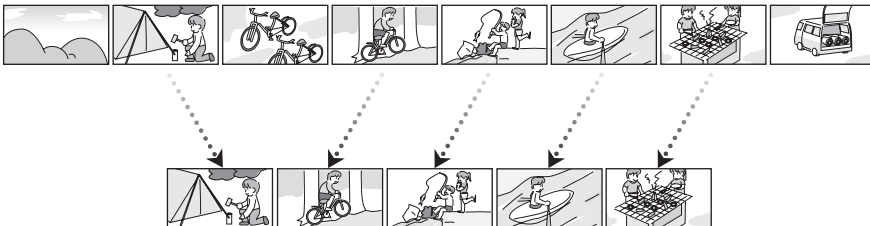

Features

■ Using with DVD player/recorder! (→ 106, 107)

Just insert the disc into a DVD player/recorder compatible with 8 cm (3") discs to play back the scenes recorded with this unit on it.

If you have a DVD recorder with hard disk, you can copy (dub) scenes recorded on a disc with this unit to the hard disk.

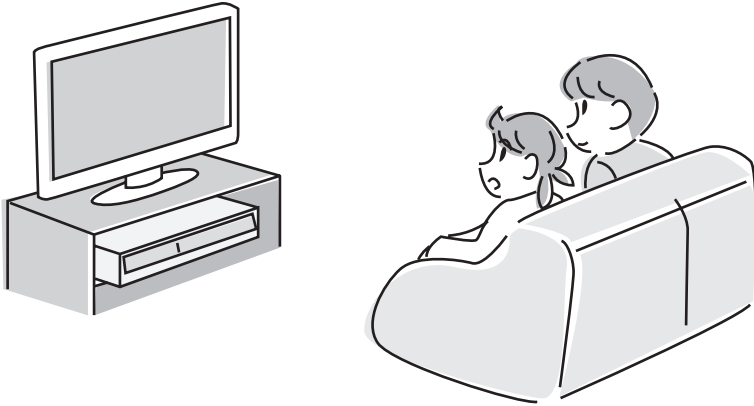

Before using

■ Using with a computer! (→ 111)

You can enjoy editing scenes with the software on the supplied CD-ROM and creating original DVD-Video discs.



Quick Guide

■ Charging the battery

- 1 Connect the AC cable to the AC adaptor and the AC outlet.
- 2 Put the battery on the battery mount by aligning the mark, and then securely plug it in.

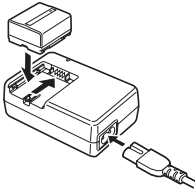

■ Fitting the battery

Push the battery against the battery holder and slide it until it clicks.

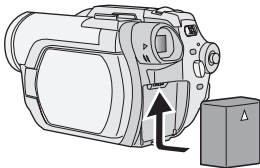

■ Removing the battery

While sliding the BATTERY RELEASE lever, slide the battery to remove it.

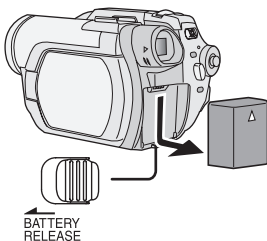

■ How to turn on/off the power

While pressing the button **A**, set the OFF/ON switch to ON/OFF.

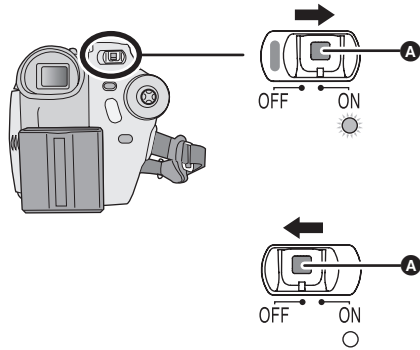

■ Inserting/removing a disc

- 1 Slide the DISC EJECT lever once and release it.

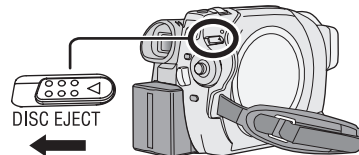

- 2 Open the cover of the disc compartment by hand and insert/remove the disc.

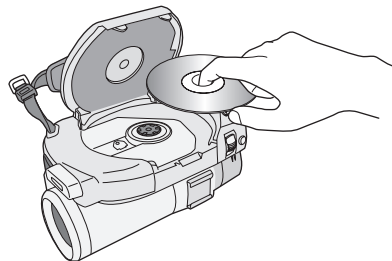

- 3 Push the section marked "PUSH CLOSE" on the cover of the disc compartment to close the cover.

Quick Guide

■ Inserting/removing an SD card

- 1 Open the card slot cover.

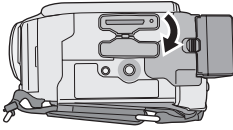

- 2 Insert/remove the SD card into/from the card slot.

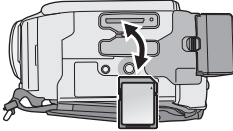

- 3 Securely close the card slot cover.

■ Recording motion pictures

- Rotate the mode dial to select .

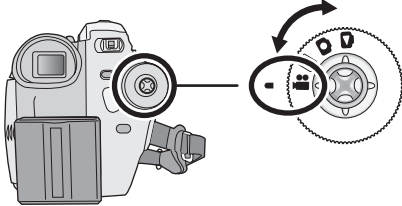

- 1 Press the recording start/stop button to start recording.

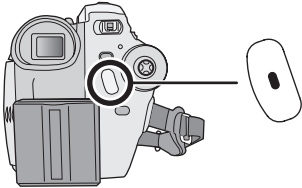

- 2 Press the recording start/stop button again to pause recording.



■ Recording still pictures

- Rotate the mode dial to select .

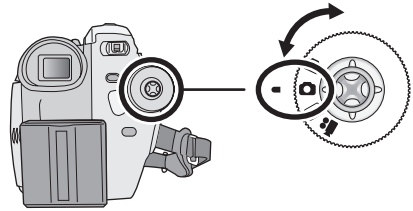

- 1 Press the PHOTO SHOT button halfway in order to adjust focusing. (For auto focusing only)

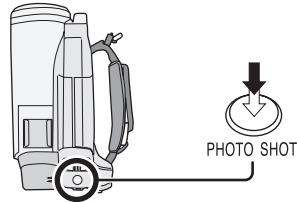

- 2 Press the PHOTO SHOT button fully to take the picture.

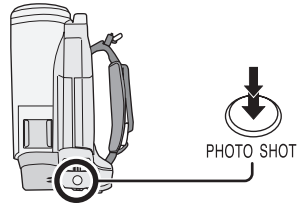

■ Motion picture playback

- Rotate the mode dial to select .

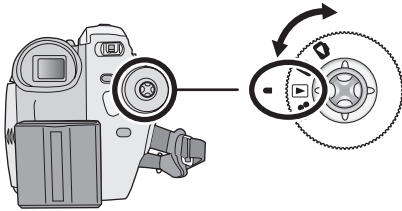

- 1 Select the scene to be played back.



- 2 Press the joystick.



- 3 Move the joystick to operate.



- ▶/||: Playback/Pause
- ◀◀ (Move): Skip playback (backward)
- ◀◀ (Move and hold): Review playback
- ▶▶ (Move): Skip playback (forward)
- ▶▶ (Move and hold): Cue playback
- : Stops the playback and shows the thumbnails.

■ Still picture playback

- Rotate the mode dial to select .

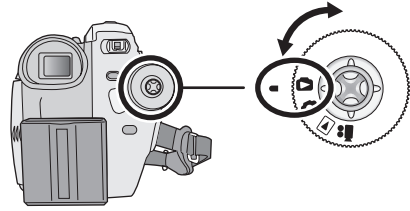

- 1 Select the file to be played back.



- 2 Press the joystick.



- 3 Move the joystick to operate.



- ▶/||: Slide show start/pause.
(When [SLIDE SHOW] is selected.)
- ◀: Plays back the previous picture.
- ▶: Plays back the next picture.
- : Stops the playback and shows the thumbnails.

Accessories

Check the accessories before using this unit.

Battery pack
CGA-DU12



Remote control
N2QAEC000019
Button-type battery
CR2025



AC adaptor
PV-DAC14D



Shoulder strap
VFC3506-1A



AC cable
K2CA2CA00029 or
K2CA2CA00025

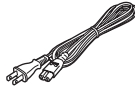

USB cable
K1HA05CD0014



DC cable
K2GJ2DZ00018



CD-ROM
LSFT0643



AV/S cable
K2KZ9CB00001



8 cm (3") DVD-RAM disc
(Single sided)
LM-AF30UB



(VDR-D250 only)
Lens cap
VYF3031



Before using

CAUTION:

This unit will operate on 110/120/220/240 V AC. An AC plug adaptor may be required for voltages other than 120 V AC. Please contact either a local or foreign electrical parts distributor for assistance in selecting an alternate AC plug. We recommend using the accessory power plug adaptor (VJSS0070) in an area which has special AC outlets.

Parts identification and handling

- 1 Lens (LEICA DICOMAR) (VDR-D300)
Lens (VDR-D250)
- 2 Built-in flash (VDR-D300 only) (→ 68)
- 3 Recording lamp (→ 144)
- 4 White balance/remote control sensor (→ 74, 21)
- 5 Terminal cover
- 6 Audio-video output terminal [A/V]
(→ 104, 108)
- 7 USB terminal [↔] (→ 109, 123, 137)
- 8 Lens cover (VDR-D300 only)
- 9 Microphone (built-in, stereo)
- 10 Terminal for Magic Wire Remote Control [REMOTE] (→ 22)
Microphone terminal [MIC]
 - A compatible plug-in powered microphone can be used as an external microphone.
 - When the unit is connected with AC adaptor, sometimes noise may be heard depending on microphone type. In that case, please switch to battery for power supply and noise will stop.
- 11 Viewfinder (→ 19)

Due to limitations in LCD production technology, there may be some tiny bright or dark spots on the viewfinder screen. However, this is not a malfunction and does not affect the recorded picture.
- 12 Delete button [⏏] (→ 81, 92, 94)
- 13 LCD monitor open part [OPEN] (→ 19)
- 14 Battery/DC cable holder (→ 28, 30)
- 15 Power switch [OFF/ON] (→ 30)
- 16 Status indicator (→ 30)
- 17 Mode dial (→ 35)
- 18 Joystick (→ 36)
 - Move up, down, left or right to select items.
 - Press the center to enter the selection.
- 19 Recording start/stop button (→ 50)
- 20 Menu button [MENU] (→ 42)
- 21 Accessory shoe
 - Accessories, such as a video DC light (optional), are attached here.
- 22 Eyepiece corrector knob (→ 47)
- 23 Zoom lever [W/T] (→ 56)
Volume lever [-VOLUME+] (→ 77)
- 24 Photoshot button [PHOTO SHOT] (→ 52)

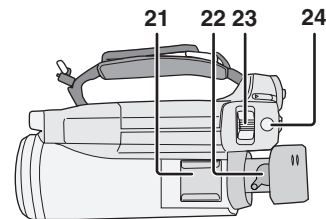
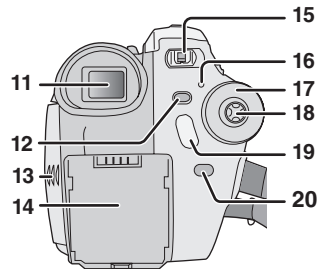
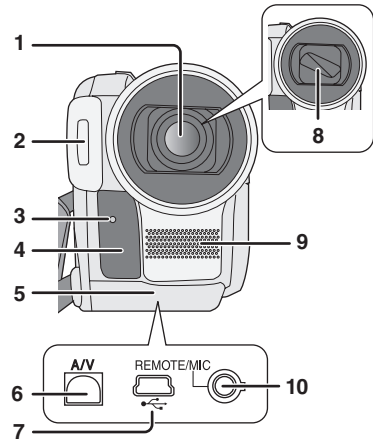

Parts identification and handling

- 25 Card slot cover (→ 34)
- 26 Card slot (→ 34)
- 27 Tripod receptacle (→ 18)
- 28 Card access lamp (→ 34)
- 29 Battery release lever [BATTERY RELEASE] (→ 28)
- 30 Speaker
- 31 LCD monitor (→ 19)

Due to limitations in LCD production technology, there may be some tiny bright or dark spots on the LCD monitor screen. However, this is not a malfunction and does not affect the recorded picture.

- 32 Mode select switch [AUTO/MANUAL/FOCUS] (→ 49, 70)
- 33 Power LCD button [POWER LCD] (→ 47)
- 34 Reset button [RESET] (→ 155)
- 35 Disc eject lever [DISC EJECT] (→ 32)
- 36 Disc/computer access lamp [ACCESS/PC] (→ 32, 124, 139)
- 37 Disc compartment (→ 32)
- 38 Grip belt (→ below)
- 39 Shoulder strap fixture (→ 17)

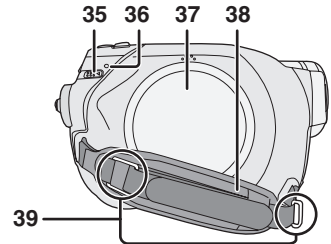
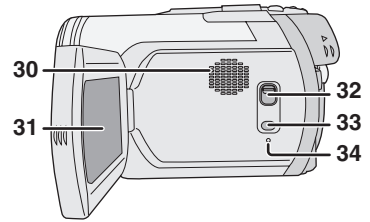
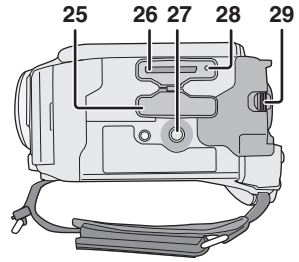

Using grip belt

Adjust the belt length so it fits your hand.

(U.S.A. only)

When this unit is purchased, a sensor tag is attached to the grip belt. Remove the tag before use.

- 1 Flip the belt.
- 2 Take off the tag.
- 3 Replace the belt.

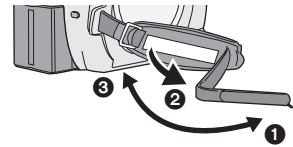

Adjust the belt length and the pad position.

- 1 Flip the belt.
- 2 Adjust the length.
- 3 Fix the belt.

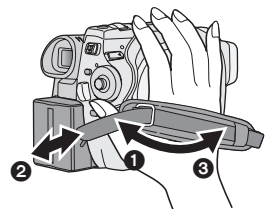

Shoulder strap fixture

Put the strap through the fixture **1** and through the stopper **2** so it will not come off. Extend part **3** by at least 2 cm (1").

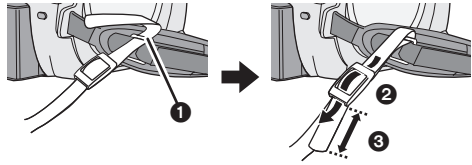

Put the opposite end of the strap through **A** and attach it in the same way.

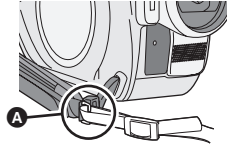

Lens hood

In order to remove the lens hood, rotate it counter-clockwise **A**. In order to attach it, place into slot **B**, and then rotate it clockwise **C**.

- (VDR-D300 only) The lens hood has a built-in lens cover.

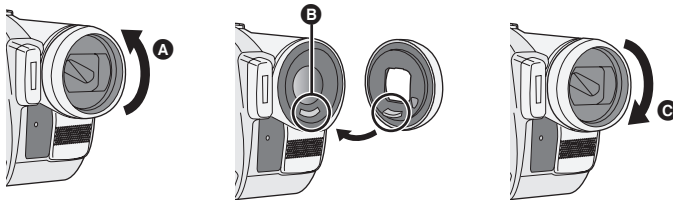

Attaching the lens cap (VDR-D250 only)

Attach the lens cap to protect the surface of the lens.

- 1 Pass the end of the lens cap cord through the belt.

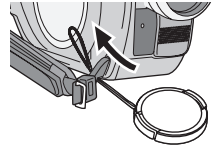

- 2 Pass the lens cap through the loop made by itself.

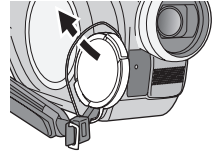

- 3 To attach or remove the lens cap, hold both sides of the lens cap with the tips of your finger and thumb.

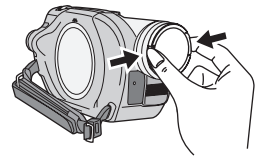

During recording

The lens cap removed can be attached to the lens cap fixture.

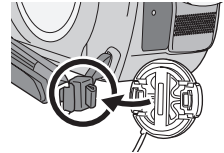

Tripod receptacle

This is a hole for attaching the unit to the optional tripod. (Please carefully read the operating instructions for how to attach the tripod to the unit.)

- When the tripod is used, the card slot cover cannot be opened. Insert an SD card before attaching this unit to the tripod. (→ 34)

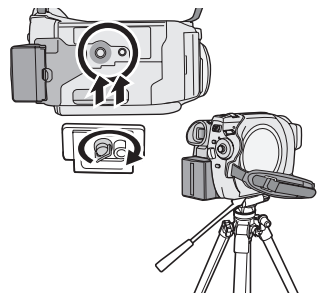

Using the LCD monitor

You can record the image while viewing it on the LCD monitor.

1 Place your finger on OPEN and pull the LCD monitor out in the direction of the arrow.

- It can open up to 90°.

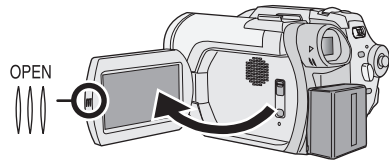

2 Adjust the angle of the LCD monitor according to your preference.

- It can rotate up to 180° **A** towards the lens or 90° **B** towards the viewfinder.

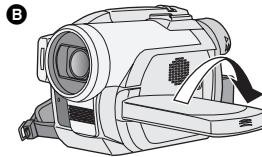
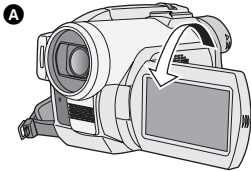

- The brightness and color level of the LCD monitor can be adjusted from the menu. (→ 47)
- If it is forcibly opened or rotated, the unit may be damaged or fail.
- If the LCD monitor is rotated by 180° towards the lens and the viewfinder is extended (when recording yourself), the LCD monitor and the viewfinder simultaneously light.

Using the viewfinder

Pull out the viewfinder.

The viewfinder will be activated. (If the LCD monitor is opened, the viewfinder will be deactivated.)

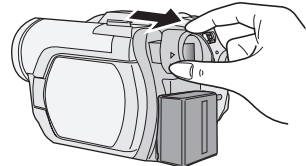

- The brightness of the viewfinder (→ 47) and the field of view (→ 47) can be adjusted.

Using the remote control

- 1 Photoshot button [PHOTO SHOT]*
- 2 On-screen display button [EXT DISPLAY] (→ 105)
- 3 Date/time button [DATE/TIME] (→ 46)
- 4 Playback operation buttons (→ 76, 77)
- 5 Delete button []*
- 6 Direction buttons [▲, ▼, ◀, ▶] (→ 44)
- 7 Recording start/stop buttons [START/STOP]*
- 8 Zoom/volume buttons [ZOOM, VOL]*
- 9 Menu button [MENU]* (→ 44)
- 10 Enter button [ENTER] (→ 44)

* means that these buttons function in the same manner as the corresponding buttons on the unit.

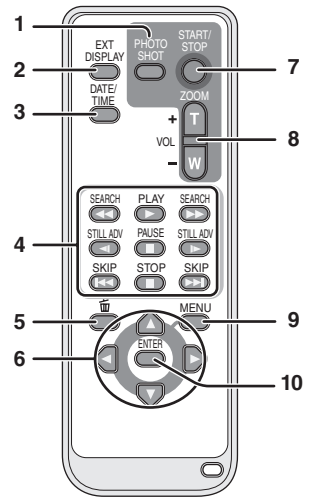

■ Install a button-type battery

Install the button-type battery supplied in the remote control before using it.

- 1 While pressing the stopper **A**, pull out the battery holder.
- 2 Set the button-type battery with its (+) mark facing upward and get the battery holder back in place.

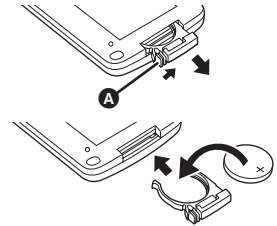

■ Concerning the button-type battery

- When the button-type battery runs down, replace it with a new battery (part number: CR2025). The battery is normally expected to last about 1 year, but it depends on operation frequency.
- Keep the button-type battery out of the reach of children.

Warning

Danger of explosion if battery is incorrectly replaced.

Replace only with the same or equivalent type recommended by the equipment manufacturer. Discard used batteries according to manufacturer's instructions.

Risk of fire, explosion and burns. Do not recharge, disassemble, heat above 100 °C (212 °F) or incinerate. Keep the Button-Type battery out of the reach of children. Never put Button-Type battery in mouth. If swallowed, call your doctor.

Replace battery with Panasonic PART NO. CR2025 only. Use of another battery may present a risk of fire or explosion.

Caution: Battery may explode if mistreated.

Dispose of used battery promptly. Keep away from children.

Do not recharge, disassemble or dispose of in fire.

■ Remote control usable range

The distance between the remote control and the unit's remote control sensor **A**: Within approx. 5 m (16 feet)

Angle: Approx. 10° up and 15° down, left, and right

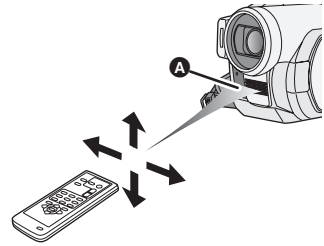

-
- The remote control is intended for indoor operation. Outdoors or under strong light, the unit may not operate properly even within the usable ranges.

Using the Magic Wire Remote Control (optional)

This remote control can be used from different high and low angles. It is also handy when a tripod is used. When you do not use the remote control, attach the clip to the grip belt. Left-handed users can use this unit more easily.

- 1 **Recording start/stop button [REC]**
- 2 **Zoom lever [W/T]**
- 3 **Photoshot button [PHOTO SHOT]**

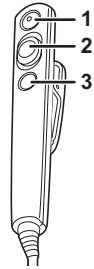

■ Connect the Magic Wire Remote Control to the unit

Plug the Magic Wire Remote Control into the REMOTE/MIC terminal as far as it goes.

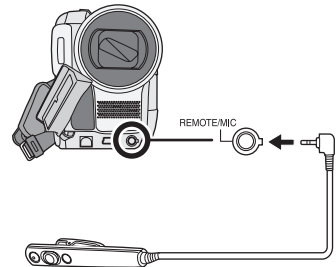

- If the pin plug of the remote control is not inserted securely into the REMOTE/MIC terminal as far as it will go, normal operation may not be ensured.
- Before using, make sure that the plug is inserted securely into the terminal as far as it will go.







■ About the clip (on the backside)

When you move with the clip fitted to your pocket or elsewhere, beware of knocking over the tripod or causing the unit to fall off the table.



Discs and cards

Discs that can be used on this unit

Disc type	DVD-RAM 8 cm (3") Single sided/ double sided	DVD-RW 8 cm (3") Single sided/double sided		DVD-R 8 cm (3") Single sided/ double sided
	 (DVD-RAM Ver. 2.1)	 [DVD-RW Ver. 1.1/ 2X-SPEED (2X/1X)]		 (DVD-R for General Ver. 2.0)
Recording format	DVD Video Recording format (VR format)	DVD Video Recording format (VR format)	DVD-Video format (Video format)	DVD-Video format (Video format)
Characteristic	Rewritable disc	Rewritable disc	One time recording disc*1	One time recording disc
Display on the screen				
Indication in these instructions	RAM	-RW(VR)	-RW(V)	-R
Functions				
• Deleting recorded scenes	●	●	—	—
• Editing on this unit	●	●	—	—
• Playback on other products*2	●*3	●*4	●*5	●*5
• Recording after finalizing	—	●	●*6	—

●: available —: not available

*1 By formatting the disc, it can be used repeatedly. (→ 98)

*2 DVD players and DVD recorders that support 8 cm (3") discs.

*3 Playback is possible on compatible products.

*4 Playback is possible on compatible products. (May have to be finalized on this unit.)

*5 Must be finalized on this unit. (→ 100)

*6 Un-finalize the disc. (→ 101)

Discs and cards

- **Still pictures cannot be recorded on a disc with this unit.**
- When using double sided disc, you cannot record or play continuously from one side of the disc to the other. You will need to eject the disc and turn it over.
- Discs inserted in a holder, cartridge, or caddy case cannot be used. Always remove bare discs from these containers prior to use.
- It is recommended that you use Panasonic discs. Usually discs compatible with the DVD standard can be used for recording and playback with no problems. However, some commercially available discs do not meet the DVD standard for quality and performance. If you use one of these discs, you may not be able to record or playback normally. (The message "RECOMMENDED TO USE PANASONIC DISC" appears.) Refer to the following support site for information about discs that have been confirmed as compatible by Panasonic.
http://panasonic.co.jp/pavc/global/cs/e_cam (This website is in English only.)
- Discs recorded on this unit may not be playable on other products.
- Recording on DVD-R in DVD Video Recording format is not supported.
- When using DVD-RW or DVD-R, do not perform the following, as doing so may make the disc unusable.
 - Record on a disc with other products after recording on it with this unit.
 - Record on a disc with this unit after recording on it with other products.
 - Insert an un-finalized disc in any other products.

■ About format types

What is the DVD Video Recording format (VR format)?

This is a format for recording on DVD discs which allows you to record and erase repeatedly and create playlists. You can record on DVD-RAM and DVD-RW in DVD Video Recording format with this unit.

What is the DVD-Video format (Video format)?

By finalizing the disc, it can be played back on most DVD players. You can record on DVD-RW and DVD-R in DVD-Video format with this unit.

■ Examples of discs that cannot be used on this unit

- DVD-RAM (2.6 GB) Ver. 1.0
- DVD-R (3.9 GB) Ver. 1.0
- DVD-R (4.7 GB) for Authoring Ver. 2.0
- +RW
- +R
- DVD-R DL
- Discs other than those with diameter of 8 cm (3")
- Dual/double layer discs
- DVD-ROM
- DVD-Video
- CD-R
- CD-RW
- CD
- LD
- MO
- MD
- iD
- Floppy disk
- CD-ROM

When using brand-new DVD-RW

When using DVD-RW, select whether to record in DVD Video Recording format (VR format) or DVD-Video format (Video format) and then format the disc. (→ 24, About format types)

- 1 When a brand-new DVD-RW is inserted in this unit, the screen on the right appears. Select [YES], then press the joystick.

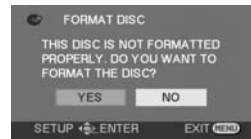

- 2 Select format type, then press the joystick.

VIDEO: DVD-Video format

VR: DVD Video Recording format



- 3 When the confirm screen appears, select [YES], then press the joystick.

- To change the format type, format the disc again. (→ 98)
If the disc is formatted, then all the data recorded on the disc will be erased.

Cards that you can use with this unit

Card type	SD Memory Card	miniSD™ Card
Capacity	8 MB, 16 MB, 32 MB, 64 MB, 128 MB, 256 MB, 512 MB, 1 GB, 2 GB (Maximum)	32 MB, 64 MB, 128 MB, 256 MB, 512 MB
Indication in these instructions	SD	

- **Motion pictures cannot be recorded on an SD card with this unit.**
- Please confirm the latest information on the following website. (This website is in English only.)
http://panasonic.co.jp/pavc/global/cs/e_cam
- For the purposes of these operating instructions, SD Memory Card and miniSD™ Card are referred to as the "SD card".
- This unit supports SD cards formatted in FAT12 system and FAT16 system based on SD Memory Card Specifications.
- Use this unit to format SD cards. If an SD card is formatted on other products (such as a computer), the time spent for recording may become longer and you may not be able to use the SD card. (→ 99)
- We recommend that you use a Panasonic brand SD card.
- Be sure to insert miniSD™ Cards in the dedicated card adaptor before use. Inserting a card in this unit without the adaptor may damage the unit or the card.
- Do not insert an empty card adaptor in this unit. Do not leave the adaptor in this unit while inserting or removing miniSD™ Cards. This may cause the unit to malfunction.
- When the write-protect switch on SD Memory Card is locked, no recording, deletion or editing will be possible on the card.

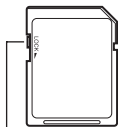

Write-protect switch

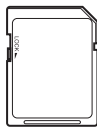

Locked status

- Keep the memory card out of reach of children to prevent swallowing.
- MultiMediaCards cannot be used on this unit.

Disc and card handling

■ How to hold a disc or card

Do not touch the recorded surface or the terminal surface.

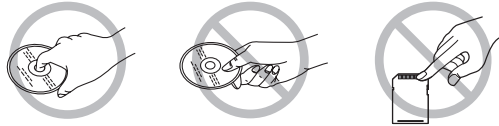

■ If there is dirt or condensation on the disc

Wipe with a damp cloth and then wipe dry.

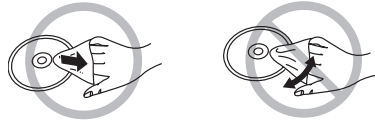

■ Handling precautions

- Be careful about scratches and dirt.
- Do not attach labels or stickers to discs. (This may cause disc warping and un-balanced rotation, rendering it unusable.)
- Write on the label side of the disc only with a soft, oil-based felt pen. Do not use ballpoint pens or other hard writing implements.
- Do not use record cleaning sprays, benzene, thinner, static electricity prevention liquids or any other solvent.
- Do not use scratch-proof protectors or covers.
- Do not expose the terminals of the card to water, garbage or dust.
- Do not drop, stack, or impact discs. Do not place objects on them.
- Do not use the following discs:
 - Discs with exposed adhesive from removed stickers or labels.
 - Discs that are badly warped or cracked.
 - Irregularly shaped discs, such as heart shapes.
- Do not place in the following areas:
 - In direct sunlight.
 - In very dusty or humid areas.
 - Near a heater.
 - Locations susceptible to significant difference in temperature (condensation can occur).
 - Where static electricity or electromagnetic waves occur.
- To protect discs and cards, return them to their cases when you are not using them.



Power supply

Charging the battery

When this unit is purchased, the battery is not charged. Charge the battery before using this unit.

- If the DC cable is connected to the AC adaptor, then the battery will not charge. Remove the DC cable from the AC adaptor.

- 1 Connect the AC cable to the AC adaptor and the AC outlet.
- 2 Put the battery on the battery mount by aligning the mark, and then securely plug it in.

- The output plug of the AC cable is not completely connected to the AC adaptor jack. As shown in **A**, there is a gap.

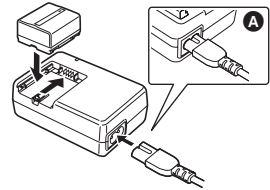

■ Charging lamp

Lights up: Charging

Goes off: Charging completed

Flashing: The battery is over discharged (discharged excessively). In a while, the lamp will light up and normal charging will start.

When the battery temperature is excessively high or low, the CHARGE lamp flashes and the charging time will be longer than normal.

- Battery charging time (→ 29)
- We recommend using Panasonic batteries.
- If you use other batteries, we cannot guarantee the quality of this product.

Fitting the battery

Push the battery against the battery holder and slide it until it clicks.

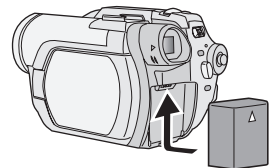

Removing the battery

While sliding the BATTERY RELEASE lever, slide the battery to remove it.

- Hold the battery with your hand so it does not fall.

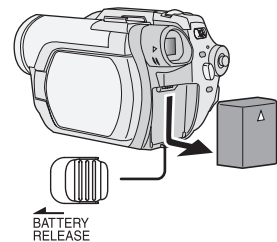

- Before removing the battery, be sure to set the OFF/ON switch to OFF and check that the status indicator is off before removing the battery.

Charging time and recordable time

The times shown in the tables below are for when the temperature is 25 °C (77 °F) and the humidity is 60%. If the temperature is higher or lower than 25 °C (77 °F), the charging time will become longer.

■ Charging time

Battery model number	Voltage/capacity	Charging time
Supplied battery/ CGA-DU12 (optional)	7.2 V/1150 mAh	2 h 25 min
CGA-DU21 (optional)	7.2 V/2040 mAh	3 h 55 min

- “2 h 25 min” indicates 2 hours 25 minutes.
- The charging times shown in the table are approximations.

■ Recordable time

- The times indicate the recordable time when the viewfinder is used. The times in parentheses indicate the recordable time when the LCD monitor is used.

(When using a DVD-RAM disc)

Battery model number	Voltage/capacity	Recording mode	Maximum continuously recordable time	
			VDR-D300	VDR-D250
Supplied battery/ CGA-DU12 (optional)	7.2 V/ 1150 mAh	XP	1 h 25 min (1 h 20 min)	1 h 30 min (1 h 25 min)
		SP	1 h 35 min (1 h 30 min)	1 h 40 min (1 h 35 min)
		LP	1 h 40 min (1 h 35 min)	1 h 45 min (1 h 35 min)
CGA-DU21 (optional)	7.2 V/ 2040 mAh	XP	2 h 40 min (2 h 35 min)	2 h 50 min (2 h 40 min)
		SP	3 h (2 h 50 min)	3 h 10 min (2 h 55 min)
		LP	3 h 10 min (2 h 55 min)	3 h 15 min (3 h 5 min)

- “1 h 25 min” indicates 1 hour 25 minutes.
- The recordable times shown in the table are approximations.

- Along with the reduction of the battery capacity, the display will change:

→ → → → .

If the battery discharges, then () will flash.

- The recordable time will become shorter in the following cases:
 - When you use both the viewfinder and the LCD monitor simultaneously while rotating the LCD monitor frontward to record yourself, using the 0 Lux MagicPix function, etc.
 - When you use this unit with the LCD monitor lit up by pressing the POWER LCD button.

- The batteries heat up after use or charging. This unit will also heat up while being used. This is not a malfunction.

- Be aware that the operating time of the battery will become shorter in low temperatures. We recommend charging a spare battery for use when recording.

Connecting to the AC outlet

- 1 **Connect the AC cable to the AC adaptor and the AC outlet.**
- 2 **Connect the DC cable to the AC adaptor.**
- 3 **Connect the DC cable to this unit.**
 - Do not use the AC cable for other equipment since the AC cable is exclusively designed for this unit. Do not use the AC cable from other equipment for this unit.

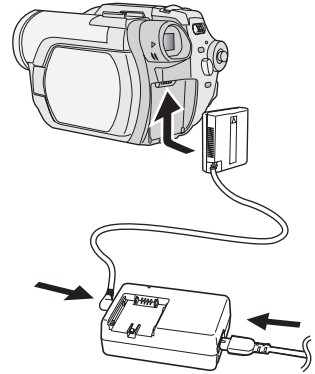

- While the DC cable is connected to the AC adaptor, the battery will not charge.

Turning the unit on/off

- (VDR-D250 only) When recording, remove the lens cap before turning the unit on. If the unit is turned on with the lens cap attached, the automatic white balance adjustment (→ 163) may not function properly.

How to turn on the power

While pressing the button **A**, set the OFF/ON switch to ON.

The status indicator **B** lights and the power turns on.

- (VDR-D300 only) In disc recording mode or card recording mode, the lens cover opens.
- When the unit is turned on for the first time, a message asking you to set the date and time will appear. Select [YES] and set the date and time. (→ 45)

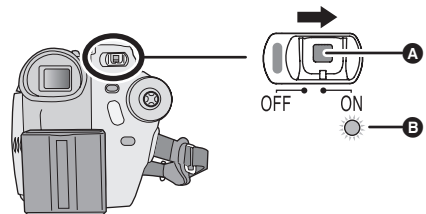

How to turn off the power

While pressing the button **A**, set the OFF/ON switch to **OFF**.

The status indicator **B** goes off when the power turns off.

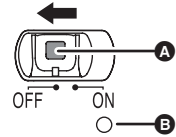

When the power is turned on for the first time after changing the disc or battery, the unit carries out a recognition procedure to check that there are no problems with the disc.

This takes approximately 25 seconds with DVD-RAM.

If you want to start using the unit as soon as you turn on the power, do the following.

- 1) Turn on the power.
 - 2) After "READING DISC..." disappears from the screen, turn off the power.
- You can start recording approximately 8 seconds after you turn on the power again.
- Depending on the condition of the disc, it may take longer than this.
 - If the date and time are not set, it will take longer than usual before you can start recording.

How to turn the power on and off with the LCD monitor/viewfinder

When the OFF/ON switch is set to ON, the power can be turned on and off with the LCD monitor and the viewfinder when the unit is in disc recording mode or card recording mode.

To turn on the power
Open the LCD monitor or extend the viewfinder.

The status indicator lights and the power turns on.

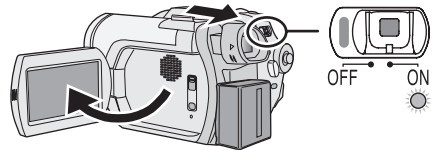

To turn off the power
Close the LCD monitor and retract the viewfinder.

The status indicator goes off and the power turns off.

- The power will not turn off unless the LCD monitor is closed and the viewfinder is retracted.
- The power will not turn off while recording on a disc even if the LCD monitor is closed and the viewfinder is retracted.

Set the OFF/ON switch to OFF when the unit is not being used.

Inserting/removing a disc

When inserting or removing the disc, fit the charged battery pack or connect the AC adaptor to the unit. The cover of the disc compartment will not open unless the unit is powered.

1 Slide the DISC EJECT lever once and release it.

A few moments after the ACCESS/PC lamp blinks, the cover of the disc compartment will open slightly.

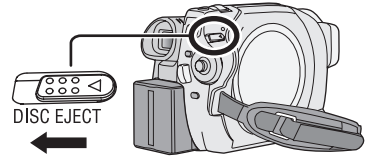

2 Open the cover of the disc compartment by hand and insert/remove the disc.

■ Inserting disc

Fit the disc onto the spindle in the center.

- A** Recording/playback side
- B** Pickup lens

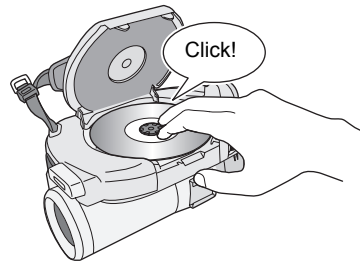
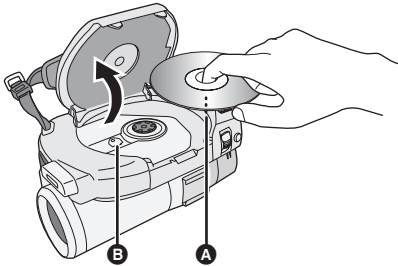

■ Removing disc

While pressing down on the spindle, grasp the edge of the disc and gently lift it out.

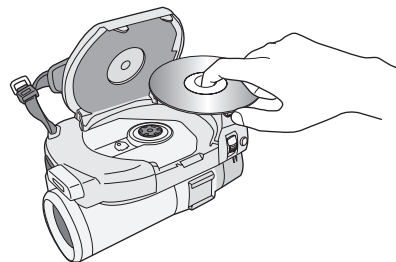
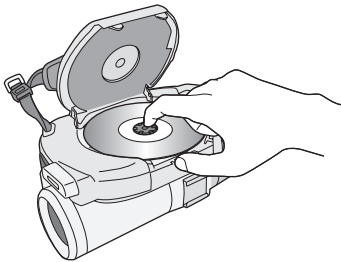

3 Push the section marked "PUSH CLOSE" on the cover of the disc compartment to close the cover.

■ Identifying recording/playback sides of disc

Single sided disc:

The recording/playback side is opposite to the labelled side.

Double sided disc:

The "SIDE A" recording/playback side is opposite to the "SIDE A" marked side. The "SIDE B" recording/playback side is the "SIDE A" marked side.

"SIDE A" mark

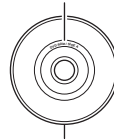

The opposite side is the "SIDE A" recording/playback side.

- Do not use excessive force when opening the cover.
- Do not touch the pickup lens or the recording/playback side of the disc.
This may impair recording and playback.
- Insert the disc securely to prevent damage.
- When you open the cover, the ACCESS/PC lamp flashes red. Do not leave the cover open.
- If the cover is open, the power will not turn off even if the OFF/ON switch is set to OFF.
- If the disc is not correctly inserted, the cover will not close. Never try to forcibly close the cover. This could cause damage. Reinsert the disc properly.
- If a single sided disc is inserted into the unit with the printed label facing the inside, an error message will appear. Remove the disc and reinsert it with its recording/playback side facing the inside.
- Do not allow the recording/playback side to become dirty or scratched.
- Do not remove the battery pack or disconnect the AC adaptor while removing the disc or until power is completely turned off. If you do, the cover will not open. If this happens, reattach the battery pack or reconnect the AC adaptor, slide the DISC EJECT lever once, and then release it. A repair disc message may be displayed when the power is turned back on. (→ 148, About recovery)
- Do not insert anything other than the 8 cm (3") DVD-RAM, DVD-RW or DVD-R disc into the disc compartment. Doing so could cause malfunctions.
- Do not touch the pickup lens or other parts inside the disc compartment. Be sure not to touch the area around the pickup lens for it becomes extremely hot.

After inserting a disc/After recording finishes

While the ACCESS/PC lamp is lit, the disc is rotating and disc information is being recorded. If the power supply is interrupted at this time, the disc may become unusable. Do not disconnect the AC adaptor or remove the battery. Also, do not strongly shake or cause impact to the unit.

Inserting/removing an SD card

Before inserting/removing an SD card, be sure to set the OFF/ON switch to OFF.

If the SD card is inserted or removed while the OFF/ON switch is set to ON, this unit may malfunction or the data recorded on the SD card may be lost.

1 Set the OFF/ON switch to OFF to turn off the power.

- Check that the status indicator has gone off.

2 Open the card slot cover.

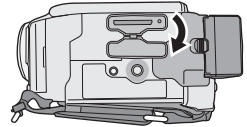

3 Insert/remove the SD card into/from the card slot.

- When inserting an SD card, face the label side **A** upwards and press it straight in with one stroke as far as it goes.
- When removing the SD card, press the center of the SD card and then pull it straight out.

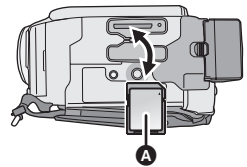

4 Securely close the card slot cover.

■ Concerning the SD card

- Electrical noise, static electricity or failure of this unit or the SD card may damage or erase the data stored on the SD card. We recommend saving important data on a computer.

■ Card access lamp

- When this unit accesses the SD card (reading, recording, playback, erasing, etc.), the access lamp lights up.
- If the following operations are performed when the access lamp is lit, then the SD card or the recorded data may be damaged or this unit may malfunction.
 - Removing the SD card
 - Operating the OFF/ON switch or the mode dial
 - Removing the battery or disconnecting the AC adaptor

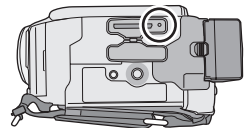



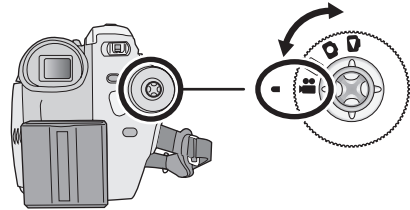

Selecting a mode

The mode dial is used to switch between recording and playback modes.
Rotate the mode dial slowly but surely.

Rotate the mode dial, and set the desired mode pictograph to the position shown in the illustration.



 Disc recording mode (→ 50)	Use this to record motion pictures on a disc.
 Disc playback mode (→ 76)	Use this to play back motion pictures on a disc.
 Card recording mode (→ 52)	Use this to record still pictures on an SD card.
 Card playback mode (→ 79)	Use this to play back still pictures on an SD card.

- Do not forcefully turn the dial.

How to use the joystick

This unit has a joystick for selecting functions, performing operations, etc. so it is easy to operate this unit with one hand.

Basic operations

Operations on the menu screen and selection of files on the thumbnail view screen, etc.

Move the joystick up, down, left, or right to select an item or scene, and then press the joystick to set it.

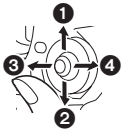

- ❶ Select by moving up.
- ❷ Select by moving down.
- ❸ Select by moving left.
- ❹ Select by moving right.
- ❺ Press the joystick to select the item.

- Menu screen operations (→ 42)

Operations during recording

◇ Rotate the mode dial to select  or .

1 Press the center of the joystick, and icons will be displayed on the screen.

- When the center of the joystick is pressed again, the indication disappears.
- Each time the joystick is moved down, the indication changes.



2 Move the joystick up, left or right to select an item.

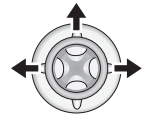

Operations during playback

◇ Rotate the mode dial to select or .

1 Move the joystick up, down, left or right to select the scene to be played back and press the joystick.

The selected scene is played back on the full screen. The operation icon is automatically displayed on the screen.

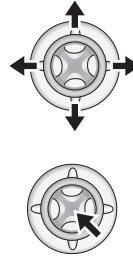

2 Move the joystick up, down, left or right to operate.

• Each time the center of the joystick is pressed, the operation icon appears or disappears.

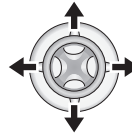

About the operations icons displayed in each mode

About auto mode and manual mode (→ 49)

Disc recording mode



Icon	Direction	Function	Page	
(1/3)		▲	Backlight compensation	58
		◀	Fade	59
		▶	Help mode	40
(2/3)		◀	Soft skin mode	61
		▶	Tele macro	62
(3/3)		▲	MagicPix/0 Lux MagicPix	63
In manual mode (4/4)	<u>WB</u>	▲	White balance	73
	<u>IRIS</u>	◀	Iris or gain value	75
	<u>SHTR</u>	▶	Shutter speed	75
In manual focus mode (5/5)	<u>MF</u> <u>MF+</u>	◀▶	Manual focus adjustment	72

• The shaded operation icons are not displayed while recording.

How to use the joystick

▶ Disc playback mode



Icon	Direction	Function	Page
▶/	▲	Playback/pause	76
■	▼	Stop playback and show thumbnails	76
⏮	◀	Rewind, skip (during playback)	76
◀		Reverse slow/frame playback (during pause)	77
▶▶	▶	Fast forward, skip (during playback)	76
▶▶		Forward slow/frame playback (during pause)	77

📷 Card recording mode

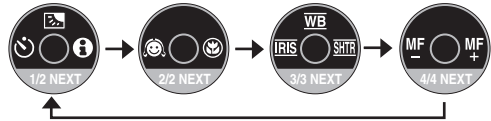

Icon	Direction	Function	Page	
(1/2)		▲	Backlight compensation	58
		◀	Self timer	64
		▶	Help mode	40
(2/2)		◀	Soft skin mode	61
		▶	Tele macro	62
In manual mode (3/3)	<u>WB</u>	▲	White balance	73
	<u>IRIS</u>	◀	Iris or gain value	75
	<u>SHTR</u>	▶	Shutter speed	75
In manual focus mode (4/4)	<u>MF</u> - <u>MF</u> +	◀▶	Manual focus adjustment	72

 **Card playback mode**
(When [PICTURE] is selected)



Icon	Direction	Function	Page
■	▼	Stop playback and show thumbnails	79
◀	◀	Playback previous picture	79
▶	▶	Playback next picture	79

 **Card playback mode**
(When [SLIDE SHOW] is selected)



Icon	Direction	Function	Page
▶/	▲	Slide show start/pause	79
■	▼	Stop playback and show thumbnails	79
◀	◀	Playback previous picture (during pause)	79
▶	▶	Playback next picture (during pause)	79

How to use the joystick

■ Help mode

The help mode explains the operation icons displayed when the AUTO/MANUAL/FOCUS switch is set to AUTO in disc/card recording mode.

◇ Rotate the mode dial to select  or .

1 Press the joystick to display the icon during the recording pause.



2 Move the joystick right to select [].



3 Move the joystick up, left or right to select the desired icon.

- An explanation of the selected icon is displayed on the screen.
- Each time the joystick is moved down, the indication changes.

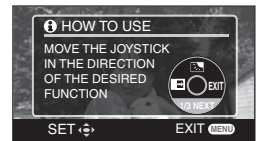

To exit the help mode

Press the MENU button or select [EXIT].



- When the help mode is used, functions cannot be set.

Switching the language

You can switch the language on the screen display or the menu screen.

- 1 Press the MENU button, then select [LANGUAGE] and press the joystick.



- 2 Select [English] and press the joystick.

Using the menu screen

Refer to "Menu list" (→ 142) for information about the menus.

1 While stopped, press the MENU button.

The menu displayed differs depending on the position of the mode dial.

- Do not switch the mode dial when the menu is displayed.

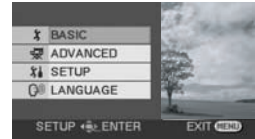

2 Move the joystick up or down in order to select the desired top menu A.

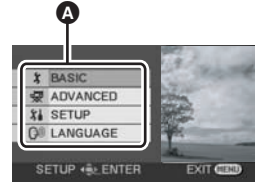

3 Move the joystick right or press the joystick.

The submenu B is displayed.

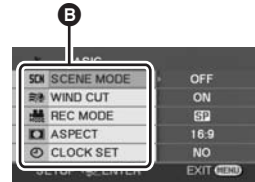
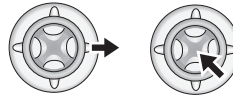

4 Move the joystick up or down in order to select the submenu item.

- Current settings on menus

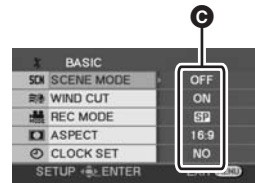

- 5 Move the joystick right or press the joystick.

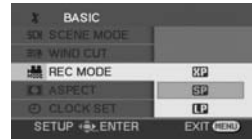
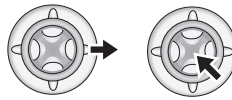

- 6 Move the joystick up or down in order to select the desired item.

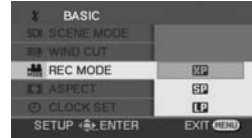

- 7 Press the joystick to enter the selection.



To get back to the previous screen

Move the joystick left.

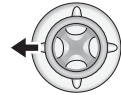

To exit the menu screen

Press the MENU button.



- The menu screen does not appear during recording or playing. You cannot start other operations while the menu screen appears.

Operating with remote control

The menu screen transition is the same as when the buttons on the main unit are used.

1 Press the MENU button.

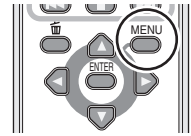

2 Select a menu item.

- Use the direction buttons (▲, ▼, ◀, ▶) and ENTER button in place of the joystick on the main unit.

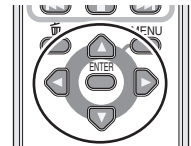

3 Press the MENU button to exit the menu screen.

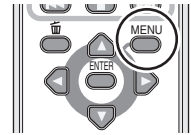

Setting date and time

When the unit is turned on for the first time, a message asking you to set the date and time will appear.

- Select [YES] and press the joystick. Perform steps 2 and 3 below to set the date and time.

If the screen shows the incorrect date and time, then adjust it.

◇ Rotate the mode dial to select  or .

- 1 Press the MENU button, then select [ BASIC] → [ CLOCK SET] → [YES] and press the joystick.

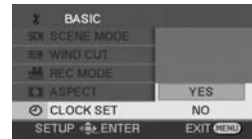

- 2 Move the joystick left or right to select the item to be set. Then, move the joystick up or down to set the desired value.

- The year will change as follows:
2000, 2001, ..., 2099, 2000, ...
- The 12-hour system is used to display the time.





- 3 Press the joystick to enter the selection.

- After pressing the MENU button to finish the setting, check the date and time display.
- The clock function starts at [00] seconds.

Setting date and time

■ Changing the date and time display style

Press the MENU button, then select [ SETUP] → [ DATE/TIME] → desired display style and press the joystick.



- You can also show or change the date and time display by repeatedly pressing the DATE/TIME button on the remote control.

[DATE]	[D/T]	[OFF]
12.15.2006	3:30 PM 12.15.2006	

- The recording time is not displayed in disc playback mode.



■ Changing the display style

Press the MENU button, then select [ SETUP] → [ DATE FORMAT] → desired display style and press the joystick.

Display style	Y/M/D	M/D/Y	D/M/Y
Screen display	2006.12.15	12.15.2006	15.12.2006



- The date and time function are driven by a built-in lithium battery.
- Make sure to check the time before recording.
- If the time display becomes [-], the built-in lithium battery has run down. Use the following steps to charge the battery. When you turn on the power for the first time after charging, a message asking you to set the date and time will appear. Select [YES] and set the date and time.

To recharge the built-in lithium battery

Connect the AC adaptor or attach the battery to the unit, and the built-in lithium battery will be recharged. Leave the unit as is for approx. 24 hours, and the battery will save the date and time for approx. 6 months. (Even if the OFF/ON switch is set to OFF, the battery is still being recharged.)

Adjusting LCD monitor/viewfinder

Adjusting the brightness and color level

- 1 Press the **MENU** button, then select [ **SETUP**]
→ [ **LCD SET**] or [ **EVF SET**] → [**YES**] and
press the joystick.



- 2 Move the joystick up or down to select the item to be adjusted. Then, move the joystick left or right to make the adjustment.

The bar display moves.

[ **LCD SET**]

 : Brightness of the LCD monitor

 : Color level of the LCD monitor

[ **EVF SET**]

 : Brightness of the viewfinder

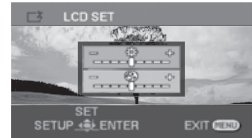



- To adjust the brightness of the viewfinder, close the LCD monitor and extend the viewfinder to activate it.
- When the LCD monitor is rotated by 180° towards the lens, the brightness and color level of the LCD monitor cannot be adjusted.
- These settings will not affect the images actually recorded.

■ In order to increase the brightness of the entire LCD monitor Press the **POWER LCD** button.

The [] indication appears on the LCD monitor.

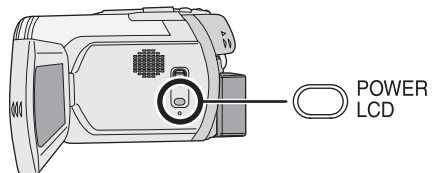
- The entire LCD monitor will become approx. twice as bright as usual.



- When the **POWER LCD** button is pressed again, the [] indication disappears and the original brightness is restored.
- This will not affect the images to be recorded.
- If you turn on the unit when the AC adaptor is used, this function will automatically be activated.

Adjusting the field of view

Adjust the focus by sliding the eyepiece corrector knob.

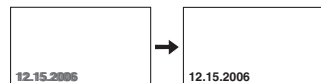
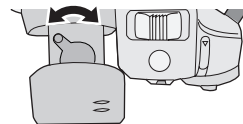

Before recording

Basic camera positioning

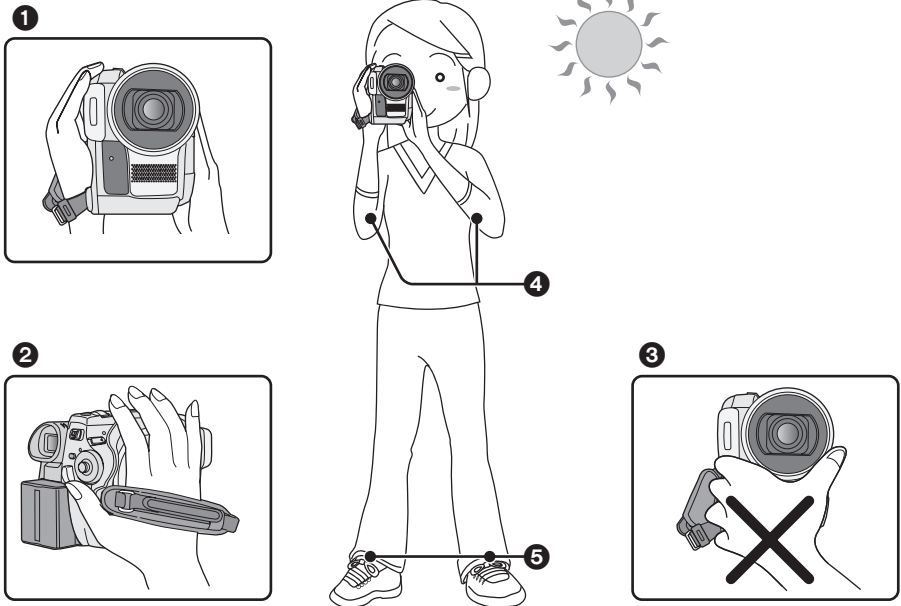

- ❶ Hold the camera with both hands.
 - ❷ Run your hand through the grip belt.
 - ❸ Do not cover the microphones or sensors with your hands.
 - ❹ Keep your arms near your body.
 - ❺ Slightly open your legs.
- When you are outdoors, record pictures with the sunlight behind you. If the subject is backlit, it will become dark in the recording.

■ About auto mode

Set the AUTO/MANUAL/FOCUS switch to AUTO, and color balance (white balance) and focusing will be adjusted automatically.

- Auto white balance (→ 163)
- Auto focusing (→ 164)

Depending on the brightness of the subject etc., the aperture and shutter speed are automatically adjusted for an optimum brightness.

(When set to the disc recording mode: The shutter speed is adjusted to a maximum of 1/250.)

- Color balance and focus may not be adjusted automatically depending on light sources or scenes. If so, manually adjust these settings.
 - Scene mode setting (→ 70)
 - White balance setting (→ 73)
 - Shutter speed setting (→ 75)
 - Iris/gain value setting (→ 75)
 - Focus setting (→ 72)

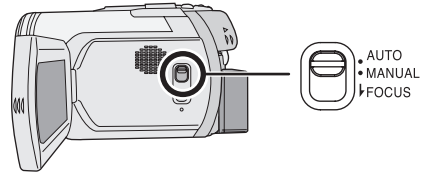

■ Auto Ground-directional Standby (AGS) (VDR-D300 only)

This function prevents unnecessary recording when you forget to pause recording and walk with the unit tilted upside down while recording continues.

- If the unit continues to be tilted upside down from the normal horizontal position while recording on a disc, it is automatically set to recording pause.



Turning the AGS function on/off

◇ Rotate the mode dial to select .

Press the MENU button, then select [SETUP] → [AGS AGS] → [ON] or [OFF] and press the joystick.

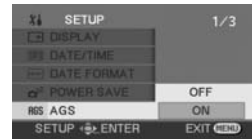

- The AGS function may activate and cause the unit to pause the recording if you are recording a subject right above or right below you. In these cases, set [AGS] to [OFF] then continue the recording.
- Use the recording start/stop button to pause the recording. The AGS function is only a backup function for when you forget to pause the recording.
- The time it takes the unit to be put into recording pause after being tilted upside down varies depending on the operating conditions.

Recording motion pictures

RAM -RW(VR) -RW(V) -R

Record motion pictures onto a disc.

- When the unit is purchased, the aspect ratio is set to [16:9] for recording images compatible with a wide-screen TV.

To watch images on a regular TV (4:3), change the aspect ratio setting (→ 66) before recording the images or when watching them on the connected TV (→ 105).

- (VDR-D250 only) Remove the lens cap before turning the unit on.

If the unit is turned on with the lens cap attached, the automatic white balance adjustment may not function properly.

1 Turn the unit on.

2 Rotate the mode dial to select .

(VDR-D300 only) The lens cover opens automatically.

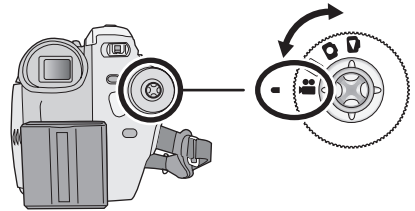

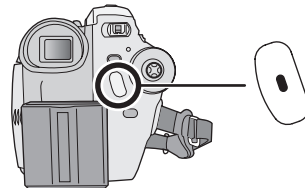

3 Open the LCD monitor or extend the viewfinder.

4 Press the recording start/stop button to start recording.



To end the recording

Press the recording start/stop button again to pause recording.

-  and  are red during recording. Do not move this unit until  is green.



- The images recorded between pressing the recording start/stop button to start recording and pressing it again to pause recording become one scene.
 - When about 5 minutes have passed without any operation in recording pause, the unit automatically turns off to prevent the battery from running down. When you want to use the unit, turn it on again.
- This setting can also be set to [OFF]. (→ 144, POWER SAVE)

Screen indications in the disc recording mode

- A** Recording mode
- B** Remaining time left for recording
(When the remaining time is less than 1 minute, [R 0h00m] flashes red.)
- C** Recording time elapsed



- The maximum number of scenes on a disc (per side): 999 (Even if there is remaining capacity for recording on a disc, you may not be able to record 999 scenes.)
- Sound is recorded in Dolby Digital from the internal stereo microphone on the front of the unit. Take care not to block this microphone.
- Each time the unit enters the recording pause mode, the counter display will be reset to "0h00m00s".
- While motion picture recording is in progress, the recording will not stop even if the LCD monitor is closed and the viewfinder is retracted.
- While "WRITING THE INFORMATION ON THE DISC." is displayed, do not disconnect the AC adaptor or remove the battery as doing so may make the disc unusable.
- While motion picture recording is in progress, do not disconnect the AC adaptor or remove the battery. If you do, a repair disc message may be displayed when the power is turned back on. (→ 148, About recovery)

Immediately after recording finishes the ACCESS/PC lamp lights. While it lights, the disc is rotating and disc information is being recorded. If you run while holding the unit or swing it, the recorded images may be distorted so do not strongly shake or cause impact to it.

Changing the recording mode of the motion picture

Press the MENU button, then select [BASIC] → [REC MODE] → desired item and press the joystick.

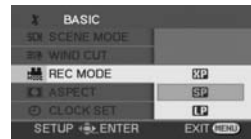

Recording modes and recordable time available for the motion picture

Recording mode		Recordable time (on single side)
XP	(High quality)	Approx. 18 min
SP	(Normal)	Approx. 37 min
LP	(Long play)	Approx. 75 min

↑ Image quality prioritized
↓ Recording time prioritized

- This unit records in VBR. VBR is an abbreviation for Variable Bit Rate. VBR recording automatically varies the bit rate (amount of data in a fixed time) depending on the subject being recorded. This means if a subject with sharp movements is recorded, the recording time is reduced.
 - When the unit is moved too much or too fast
 - When a subject with sharp movements has been recorded (Particularly if it has been recorded in [LP] mode.)
- Mosaic-pattern noise may appear on a playback image in the following cases.
 - When there is a complicated pattern in the background

Recording still pictures

SD

Record the still picture on an SD card.

- When this unit is purchased, [PICTURE SIZE] is set to [**2M**] (VDR-D300)/[**1.7M**] (VDR-D250) for recording pictures compatible with a wide-screen TV (16:9).
To record pictures with a 4:3 aspect ratio, change the [PICTURE SIZE] setting before recording (→ 54).
- (VDR-D250 only) Remove the lens cap before turning the unit on.
If the unit is turned on with the lens cap attached, the automatic white balance adjustment may not function properly.

1 Turn the unit on.

2 Rotate the mode dial to select .

(VDR-D300 only) The lens cover opens automatically.

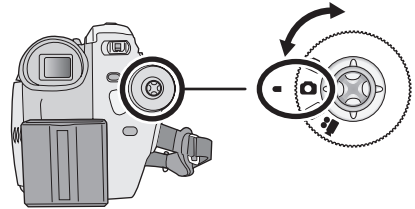

3 Open the LCD monitor or extend the viewfinder.

4 Press the PHOTO SHOT button halfway in order to adjust focusing. (For auto focusing only)

The shutter speed and the iris/gain value are fixed and the unit focuses on the subject automatically.

- (VDR-D300 only) If you set [O.I.S.] to [ON], then the image stabilizer function will be more effective. ([**MEGA**]) (MEGA optical image stabilizer) will be displayed.)

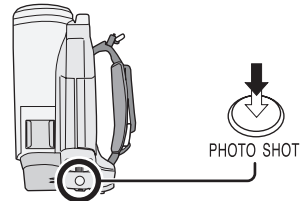

A Shutter chance mark

- (The white lamp flashes.): Focusing
- (The green lamp lights up.): When in focus
- No mark: When focusing is unsuccessful.

• The shutter chance mark is indicated as follows when the PHOTO SHOT button is not pressed halfway. Please use it as a guide for recording.

- (The green lamp lights up.): When in focus and a good picture can be recorded.
- (The white lamp lights up.): Almost in focus

B Focus area

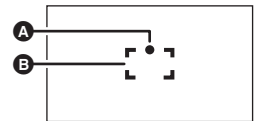

5 Press the PHOTO SHOT button fully to take the picture.

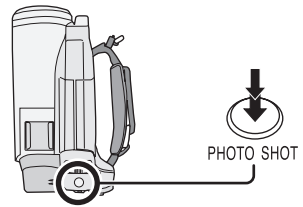

- For information about the number of recordable still pictures on an SD card (→ 167)
- When the [PICTURE SIZE] is set to other than [0.3M], the mega pixel recording mode is set.
- The sound cannot be recorded.
- If the write protection switch on the SD card is set to LOCK, it cannot be used for recording.
- The PHOTO SHOT button on the remote control and the Magic Wire Remote Control cannot be pressed halfway.
- If the [PICT. QUALITY] is set to [M], mosaic-pattern noise may appear on a playback image depending on the picture content.
- While this unit accesses the SD card ([] is displayed/the access lamp is lit), do not perform the following operations. The SD card or the recorded data may be damaged.
 - Turn the unit off.
 - Remove the SD card.
 - Operate the mode dial.
- Another product may degrade or not play back still pictures recorded on this unit.

■ To record still pictures clearly

- When zooming in on the subject with a magnification of 4× or higher, it is difficult to reduce the slight shaking from holding this unit by hand. We recommend decreasing the zoom magnification and approaching the subject when recording.
- When recording still pictures, hold the unit firmly with your hands and keep your arms stationary at your side so as not to shake the unit.
- You can record stable pictures without shaking by using a tripod and the remote control.

Screen indications in card recording mode

- A** Remaining number of still pictures
(Flashes in red when [R 0] appears.)
- B** Size of still pictures
- C** Quality of still pictures



Recording still pictures

■ About the shutter chance mark

- The shutter chance mark does not appear in manual focus mode.
- When the subject is not easily focused, focus on the subject manually.
- You can record still pictures on the card even if the shutter chance mark does not appear, but pictures may be recorded without being focused.
- The shutter chance mark does not appear or has difficulty displaying in the following cases.
 - When the zoom magnification is high.
 - When the unit is shaken.
 - When the subject is moving.
 - When the subject stands in front of a light source.
 - When close subjects and far subjects are included in the same scene.
 - When the scene is dark.
 - When there is a bright part in the scene.
 - When the scene is filled with only horizontal lines.
 - When the scene lacks contrast.

■ Concerning the focusing area

When there is a contrasting object ahead or behind the subject in the focus area, the subject may not be focused. If so, move the contrasting object out of the focus area.

Even when it is still difficult to focus, adjust the focus manually.

Number of pixels and picture quality for still picture recording

■ PICTURE SIZE

Changing the recording size.

Press the **MENU** button, then select [**BASIC**] → [**PICTURE SIZE**] → desired item and press the joystick.

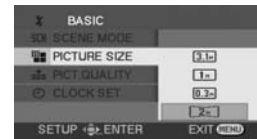

VDR-D300

Icon	Aspect	Number of pixels
	4:3	2048×1512
	4:3	1280×960
	4:3	640×480
	16:9	1920×1080



VDR-D250

Icon	Aspect	Number of pixels
	4:3	1760×1320
	4:3	1280×960
	4:3	640×480
	16:9	1760×992

- When this unit is purchased, [PICTURE SIZE] is set to [] (VDR-D300)/[] (VDR-D250). The sides of pictures recorded with a 16:9 aspect ratio may be cut at printing. Check before printing.

■ PICT. QUALITY

Selecting the picture quality.

Press the **MENU** button, then select [ **BASIC**] → [ **PICT. QUALITY**] → desired item and press the joystick.





: Still pictures with a high picture quality are recorded.

: Priority is given to the number of still pictures recorded. Still pictures are recorded in normal picture quality.

Switching the shutter effect on/off

You can add a shutter sound when recording still pictures.

Press the **MENU** button, then select [ **ADVANCED**] → [ **SHTR EFFECT**] → [ON] or [OFF] and press the joystick.

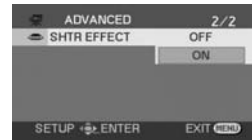

- This function's default setting is [ON].

Various recording functions

Zoom in/out function

RAM -RW(VR) -RW(V) -R SD

You can zoom in up to 10× optically.

◇ Rotate the mode dial to select  or .

Move the zoom lever.

T side: Close-up recording (zoom in)

W side: Wide-angle recording (zoom out)

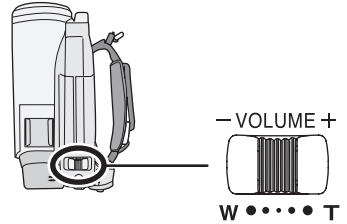
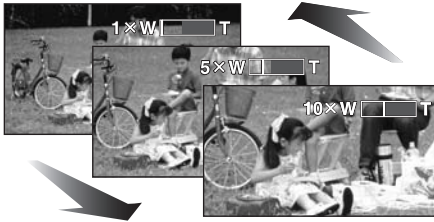

- When zooming in while holding this unit by hand, we recommend using the image stabilizer function. (→ 67)
- When distant subjects are brought closer, they are focused at about 1 m (3.3 feet) (VDR-D300)/1.2 m (3.9 feet) (VDR-D250) or more.
- When the zoom magnification is 1×, this unit can focus on a subject approx. 3.5 cm (1.4") (VDR-D300)/4 cm (1.6") (VDR-D250) away from the lens. (Macro function)
- The zoom speed varies depending on the range over which the zoom lever is moved. (The zoom speed does not vary when operating with the remote control or the Magic Wire Remote Control.)
- When the zoom speed is high, the subject may not be focused easily.

Digital zoom function

RAM -RW(VR) -RW(V) -R

If the zoom magnification exceeds 10×, then the digital zoom function will be activated. The maximum magnification provided by the digital zoom can be switched.

◇ Rotate the mode dial to select .

Press the MENU button, then select [ ADVANCED]

→ [ D.ZOOM] → desired item and press the joystick.

OFF: Optical zoom only (Up to 10×)

25×: Up to 25×

700×: Up to 700×



- If [25×] or [700×] is selected, the digital zoom range is displayed in blue while zooming.
- The larger the digital zoom magnification, the more the image quality is degraded.
- This function cannot be used in card recording mode.

To use the zoom microphone function

RAM -RW(VR) -RW(V) -R

Interlocked with the zooming operation, the microphone will collect sounds clearly far away with the tele-shot or those in the vicinity with the wide-angle shot.

◇ Rotate the mode dial to select .

Press the MENU button, then select [ ADVANCED]

→ [ ZOOM MIC] → [ON] and press the joystick.



- The zoom microphone function does not work with an external microphone.

Recording yourself

RAM -RW(VR) -RW(V) -R SD

You can record yourself while viewing the LCD monitor. You can record persons in front of the unit while showing them the image.

◇ Rotate the mode dial to select  or .

Rotate the LCD monitor towards the lens side.

The image is horizontally flipped as if you see a mirror image. (However the image recorded is the same as a normal recording.)

- Extend the viewfinder to see the picture while recording.
- When the recording aspect is 16:9, the image displayed on the viewfinder screen is squeezed horizontally, but this is normal and not a sign of any trouble.

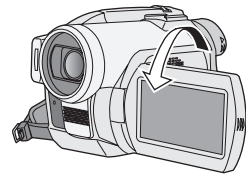

- When the LCD monitor is rotated towards the lens side, the icon will not be displayed even if you press the joystick.
- Only some indications will appear on the screen. When [] appears, return the direction of the LCD monitor to normal position and check the warning/ alarm indication. (→ 147)

Backlight compensation function

This is for protecting a backlit subject from being darkened.

RAM -RW(VR) -RW(V) -R SD

Use this function when the light is emanating from behind the subject and the subject appears dark.

◇ Rotate the mode dial to select  or .

1 Press the joystick. Then move the joystick down to display the icon shown in the illustration.



2 Move the joystick up to select .

The image on the screen will become brighter.



To return to normal recording

Select  again.

- If you turn off the power or operate the mode dial, the backlight compensation function is canceled.

Fade in/fade out function

RAM -RW(VR) -RW(V) -R

Fade in: The image and audio gradually appear.

Fade out: The image and audio gradually disappear.

◇ Rotate the mode dial to select .

To fade in

- 1 While recording is paused, press the joystick. Then move the joystick down to display the icon shown in the illustration.



- 2 Move the joystick left to select [].



- 3 Press the recording start/stop button.

Start recording. (fade in)

When you start recording, the image/audio gradually appears.

- Once the "fade in" is complete, the fade setting is canceled.



To fade out

- 1 During recording, press the joystick. Then move the joystick down to display the icon shown in the illustration.



- 2 Move the joystick left to select [].



Various recording functions

3 Press the recording start/stop button.

Pause recording. (fade out)

The image/audio gradually disappears. After the image/audio completely disappears, recording stops.

- After recording, the fade setting is canceled.



To cancel fading

Select [] again.

To select the color for fade in/out

The color which appears in fading pictures can be selected.

Press the **MENU** button, then select [ **ADVANCED**] → [ **FADE COLOR**] → [**WHITE**] or [**BLACK**] and press the joystick.

- If you turn off the power, the fade function is canceled.
- While the fade in/fade out function is selected, it takes several seconds to display the image when you start recording. It also takes several seconds to pause recording.
- The thumbnails of scenes recorded using fade in become black (or white).

Soft skin mode

This makes skin colors appear softer for a more attractive appearance.

RAM -RW(VR) -RW(V) -R SD

This is more effective if you record the bust image of a person.

◇ Rotate the mode dial to select  or .

1 Press the joystick. Then move the joystick down to display the icon shown in the illustration.



2 Move the joystick left to select [].



To cancel the soft skin mode

Select [] again.

- If the background or anything else in the scene has colors similar to the skin color, they will also be smoothed.
- If the brightness is insufficient, the effect may not be clear.

Tele macro function

This is for bringing only what you want to record into focus to take close-ups.

RAM -RW(VR) -RW(V) -R SD

By focusing only on the subject and blurring the background, the image can be impressive.

VDR-D300 This unit can focus on the subject at a distance of approx. 50 cm (20").

VDR-D250 This unit can focus on the subject at a distance of approx. 40 cm (16").

◇ Rotate the mode dial to select  or .

1 Press the joystick. Then move the joystick down to display the icon shown in the illustration.



2 Move the joystick right to select [].

- If the magnification is 10× or less, then it is automatically set to 10×.



To cancel the tele macro function

Select [] again.

- If a sharper focus cannot be achieved, adjust the focus manually. (→ 72)
- In the following cases, the tele macro function is canceled.
 - The zoom magnification becomes lower than 10×.
 - The power is turned off or the mode dial is operated.

MagicPix function

This allows recording in dark places.

RAM -RW(VR) -RW(V) -R

This function allows you to record color subjects in dark locations to stand out against the background.

Attach this unit to a tripod, and you can record images free from vibration.

- Only manual focusing can be used.
- Recorded scene is seen as if frames were missed.

MagicPix function: You can record dark locations brightly in color.

0 Lux MagicPix function: You can record completely dark locations with the light of the LCD monitor.

◇ Rotate the mode dial to select .

1 Press the joystick. Then move the joystick down to display the icon shown in the illustration.

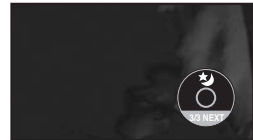

2 Move the joystick up to select [].

Each upward press changes the modes:

Off → MagicPix function → 0 Lux MagicPix function → Off

- The unit is in manual focus mode while recording with the MagicPix function. Move the joystick left or right to bring the subject into focus manually. (→ 72)



3 (In the case of 0 Lux MagicPix function)

Extend the viewfinder and rotate the LCD monitor towards the lens side.

- When the LCD monitor is reversed, the screen is lit in white.
- Extend the viewfinder and view the images while recording.
- The light of the LCD monitor reaches approx. 1.2 m (3.9 feet) or less.

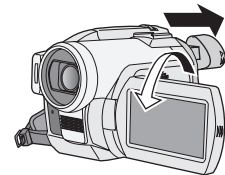

To cancel the MagicPix function

Select [] until the MagicPix indication disappear.

- The MagicPix function makes the signal charging time of CCD up to approximately 30× longer than usual, so that dark scenes invisible to the naked eye can be recorded brightly. For this reason, bright dots that are usually invisible may be seen, but this is not a malfunction.
- If you turn off the power or operate the mode dial, the MagicPix function is canceled.
- If set in a bright place, the screen may become whitish for a while.

Self-timer recording

This is for recording shots of yourself as well.

SD

You can record still pictures on an SD card using the timer.

◇ Rotate the mode dial to select .

1 Press the joystick. Then move the joystick down to display the icon shown in the illustration.



2 Move the joystick left to select .



3 Press the PHOTO SHOT button.

After the recording lamp and the  display flashes for approx. 10 seconds, a still picture will be recorded.

- After recording, the self-timer is canceled.
- If you press the PHOTO SHOT button halfway and then fully, the subject is focused when the button is pressed halfway.
- When you press the PHOTO SHOT button fully, the subject is focused just before recording.

To stop the timer midway through

Press the MENU button. (The self-timer setting is canceled.)



- If you turn off the power, the self-timer standby mode is canceled.
- Depending on the time taken to bring the subject into focus, the recording may take longer than set to start.

Wind noise reduction function

This is for reducing the wind noise coming into the microphone when recording.



RAM -RW(VR) -RW(V) -R

◇ Rotate the mode dial to select .

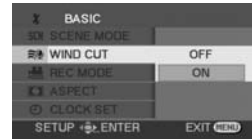
Press the MENU button, then select [ BASIC] → [ WIND CUT] → [ON] and press the joystick.



To cancel the wind noise reduction function

Press the MENU button, then select [ BASIC] → [ WIND CUT] → [OFF] and press the joystick.

- This function's default setting is [ON].
- Depending on the wind strength, the wind noise is reduced. (If this function is activated in strong winds, the stereo effect may be reduced. When the wind weakens, the stereo effect will be restored.)
- The wind noise reduction function does not work with an external microphone.

Wide mode



This is for selecting the screen's aspect ratio when recording motion pictures.

RAM -RW(VR) -RW(V) -R

This allows you to record images compatible with wide-screen TVs (16:9) and regular TVs (4:3).

■ Recording images with a 16:9 aspect ratio

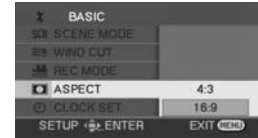

◇ Rotate the mode dial to select .

Press the MENU button, then select [ BASIC] → [ ASPECT] → [16:9] and press the joystick.



■ Recording images with a 4:3 aspect ratio

◇ Rotate the mode dial to select .

Press the MENU button, then select [ BASIC] → [ ASPECT] → [4:3] and press the joystick.

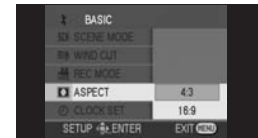

- The default setting is [16:9].

Image stabilizer function

This is for reducing image shakes (jitter) during recording.

VDR-D300 **RAM** **-RW(VR)** **-RW(V)** **-R** **SD**

VDR-D250 **RAM** **-RW(VR)** **-RW(V)** **-R**

Reduces the image shaking (jitter) due to hand movement when recording.

■ VDR-D300

◇ Rotate the mode dial to select  or .

Press the MENU button, then select [ ADVANCED]

→ [**O.I.S.** O.I.S.] → [**ON**] and press the joystick.

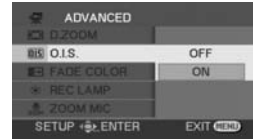

■ VDR-D250

● The image stabilizer function does not work in card recording mode.

◇ Rotate the mode dial to select .

Press the MENU button, then select [ ADVANCED] → [**EIS** EIS] → [**ON**] and press the joystick.

To cancel the image stabilizer function

Press the MENU button, then select [ ADVANCED] → [**O.I.S.** O.I.S.]/[**EIS** EIS] → [**OFF**] and press the joystick.



- This function's default setting is [ON].
- (VDR-D300 only) In the card recording mode, pressing the PHOTO SHOT button halfway increases the effect of the image stabilizer function. (MEGA optical image stabilizer)
- When a tripod is used, we recommend that you turn the image stabilizer off.
- In the following cases, the image stabilizer function may not work effectively.
 - When the digital zoom is used
 - When the unit is shaken greatly
 - When you record a moving subject while tracking it
 - When recording in extremely dark places (VDR-D250 only)
- The image stabilizer function does not work when the MagicPix function is being used. (VDR-D250 only)



Built-in flash (VDR-D300 only)

SD

Use the built-in flash in order to record still pictures in dark places.

◇ Rotate the mode dial to select .

1 Press the MENU button, then select [ ADVANCED] → [ FLASH] → desired item and press the joystick.

- : Forced flash
- A: Auto







- When [A] is set, the ambient brightness is automatically detected, and the flash will activate only when necessary.









2 Press the PHOTO SHOT button.

The flash is activated and the picture will be recorded.

When the flash is not used

Press the MENU button, then select [ ADVANCED] → [ FLASH] → [] and press the joystick.

: Forced off

- Do not block the flash by hand or any other means.
- The unit, even when its flash has been turned off, automatically determines if the flash is necessary by detecting the ambient brightness. (If it determines that the flash is necessary, the [] indication lights up in yellow.)
- When the [+]/[-] indication or the [A] ([A+]/[A-]) indication is displayed, the flash can be lit. If the indication is flashing or not displayed, the flash cannot be lit.
- The available range of the flash is approx. 1 m to 2.5 m (3.3 feet to 8.2 feet) in dark places. Pictures will appear dark or reddish when they are recorded by using the flash at distances greater than 2.5 m (8.2 feet).
- When setting the flash to [A] and adjusting the shutter speed or iris/gain at the same time, the indication [A] etc. may disappear and the flash may not flash.
- Using the flash fixes the shutter speed of 1/750 or faster to 1/500.
- The picture may become out of focus in dark places. If so, adjust the focus manually.
- The picture may appear dark if flash is lit in front of a white background.
- Set the flash to [] where using a flash is prohibited.
- If the flash will be activated a large number of times, it may take longer to charge it.

Red eye reduction function

Reduces the phenomena where human eyes become red from flashes.

Press the MENU button, then select [ ADVANCED]

→ [ RED EYE] → [ON] and press the joystick.





- The flash is activated 2 times. Do not move until the second flash is finished.
- Use this when you take pictures of people in dark places.
- Red eye phenomenon may appear depending on the recording conditions.

To adjust the brightness of the flash

Press the MENU button, then select [ ADVANCED]

→ [ FLASH LEVEL] → desired item and press the joystick.

 -: If the brightness is too high.

 ±0: In normal recording

 +: If the brightness is insufficient.



Manual recording functions

Scene mode

This is for recording in various situations.

RAM -RW(VR) -RW(V) -R SD

When you record images in different situations, this mode automatically sets optimum shutter speeds and apertures.



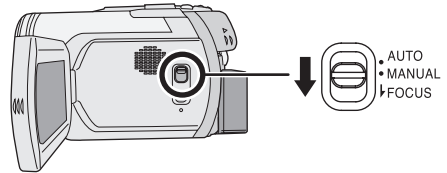

◇ Rotate the mode dial to select  or .

- 1 Set the AUTO/MANUAL/FOCUS switch to MANUAL.

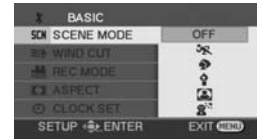

- 2 Press the MENU button, then select [ BASIC] → [SCN SCENE MODE] → desired item and press the joystick.



Display	Mode	Recording conditions
	Sports	To record sports scenes or scenes where there are quick motions
	Portrait	To make people stand out against the background
	Low light	To make the scene brighter in dark conditions
	Spotlight	To make the subject under a spotlight look more attractive
	Surf & snow	To record images in bright places such as ski slopes and beaches

To cancel the scene mode function

Press the MENU button, then select [ BASIC] → [SCN SCENE MODE] → [OFF] and press the joystick.

- You can also cancel the scene mode function by setting the AUTO/MANUAL/FOCUS switch to AUTO.

Sports mode

- For slow-motion playback or playback pause of recorded pictures, this mode helps diminish camera shake.
- During normal playback, the image movement may not look smooth.
- Avoid recording under fluorescent light, mercury light or sodium light because the color and brightness of the playback image may change.
- If you record a subject illuminated with strong light or a highly reflective subject, vertical lines of light may appear.
- If the brightness is insufficient, the sports mode does not function. The [] display flashes.
- If this mode is used indoors, the screen may flicker.

Portrait mode

- If this mode is used indoors, the screen may flicker. If so, change the scene mode setting to [OFF].

Low light mode

- Extremely dark scenes may not be able to be recorded finely.

Spotlight mode

- If the recording subject is extremely bright, the recorded image may become whitish and the periphery of the recorded image extremely dark.

Surf & snow mode

- If the subject is extremely bright, the recorded image may become whitish.

Manual focus adjustment

RAM -RW(VR) -RW(V) -R SD

If auto focusing is difficult due to the conditions, then manual focusing is available.

◇ Rotate the mode dial to select  or .

- 1 Set the AUTO/MANUAL/FOCUS switch to MANUAL.

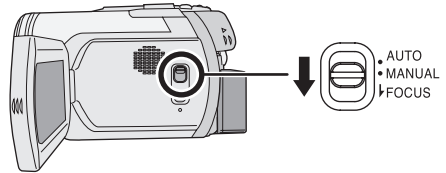

- 2 Move the switch down and set it to FOCUS position.

The manual focus indication [▶MF] and the icon shown in the illustration appear.



- 3 Move the joystick left or right to bring the subject into focus.

- When focused with a wide angle, the subject may not be in focus when zoomed in. First, zoom in on the subject, and then focus on it.

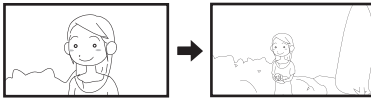

To restore to the automatic adjustment

Press the AUTO/MANUAL/FOCUS switch down again to the FOCUS position.

- You can also restore the auto focusing by setting the AUTO/MANUAL/FOCUS switch to AUTO.

White balance

This is for recording in natural colors.

RAM -RW(VR) -RW(V) -R SD

The automatic white balance function may not reproduce natural colors depending on the scenes or lighting conditions. If so, you can adjust the white balance manually.

◇ Rotate the mode dial to select  or .

1 Set the AUTO/MANUAL/FOCUS switch to MANUAL.

The icon shown in the illustration is displayed automatically.







2 Move the joystick up to select [WB].



3 Move the joystick left or right to select the white balance mode.



Display	Mode	Recording conditions
	Auto white balance adjustment	—
	Indoor mode (for recording under incandescent lamps)	Incandescent lights, halogen lamps
	Outdoor mode	Outdoors under a clear sky
	Manual adjustment mode	<ul style="list-style-type: none"> Mercury-vapor lamps, sodium lamps, some fluorescent lights Lights used for wedding receptions at hotels, stage spotlights in theaters Sunrise, sunset, etc.

To restore to the automatic adjustment

Set the white balance mode to [AWB].

- You can also restore the automatic adjustment by setting the AUTO/MANUAL/FOCUS switch to AUTO.

To set the white balance manually

1 Select [MNL], fill the screen with a white subject.

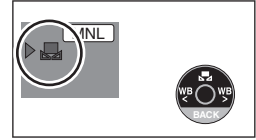

2 Move the joystick up to select [MNL].

When the [MNL] display changes from flashing to on, setting is complete.

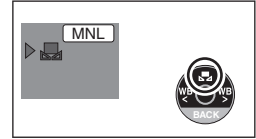

- When the [MNL] display continues flashing green, the white balance cannot be set because the place is dark etc. In this case, use the automatic white balance.

■ About the white balance sensor **A**

The white balance sensor detects the type of light source during recording. Do not cover the white balance sensor during recording, or it may not function properly.

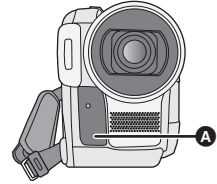

■ About the black balance adjustment

This is one of the 3CCD system functions that automatically adjusts the black when the white balance is set in the manual adjustment mode. When the black balance is adjusted, the screen will temporarily be black. (The black balance cannot be adjusted manually.)

- 1 Black balance adjustment in progress. (Flashes.)
- 2 White balance adjustment in progress. (Flashes.)
- 3 Adjustment completed. (Lights up.)



- When the [MNL] display flashes white, the manual white balance previously adjusted is stored. Whenever recording conditions change, re-set the white balance for correct adjustment.
- When setting both the white balance and the iris/gain, set the white balance first.
- (VDR-D250 only) When the unit is turned on with the lens cap attached, the automatic white balance adjustment may not function properly. Please turn the unit on after removing the lens cap.

Manual shutter speed/aperture adjustment

RAM -RW(VR) -RW(V) -R SD

- Shutter Speed:** Adjust it when recording fast-moving subjects.
Aperture: Adjust it when the screen is too bright or too dark.

◇ Rotate the mode dial to select  or .

1 Set the AUTO/MANUAL/FOCUS switch to MANUAL.

The icon shown in the illustration is displayed automatically.





2 Move the joystick left or right to select [IRIS] (aperture) or [SHTR] (shutter speed).



3 Move the joystick left or right to make the adjustment.

A Shutter speed:

-  1/60 to 1/8000
-  **VDR-D300** 1/30 to 1/2000
- VDR-D250** 1/30 to 1/500

- The shutter speed closer to 1/8000 is faster.

B Iris/Gain value: CLOSE → (F16 to F2.0) → OPEN → (0dB to 18dB)

- Value closer to [CLOSE] darken the image.
- Value closer to [18dB] brighten the image.
- When the iris value is adjusted to brighter than [OPEN], it changes to the gain value.



To restore to automatic adjustment

Set the AUTO/MANUAL/FOCUS switch to AUTO.

- When setting both the shutter speed and the iris/gain value, set the shutter speed and then set the iris/gain value.
 - When recording in an extremely bright place, the screen may change color or flicker. If so adjust the shutter speed manually to [1/60] or [1/100].
- #### ■ Manual shutter speed adjustment

 - Avoid recording under fluorescent light, mercury light or sodium light because the color and brightness of the playback image may change.
 - If you increase the shutter speed manually, the sensitivity lowers and accordingly the gain value increases automatically, which may increase the noises on the screen.
 - You may see vertical lines of light in the playback image of a brightly shining subject or highly reflective subject, but this is not a malfunction.
 - During normal playback, image movement may not look smooth.

■ Manual iris/gain adjustment

 - If the gain value is increased, the noise on the screen increases.
 - Depending on the zoom magnification, there are iris values that are not displayed.

Motion picture playback

RAM RW(VR) RW(V) R

Play back the motion pictures recorded on the disc.

1 Rotate the mode dial to select .

The motion pictures recorded on the disc are displayed as thumbnails.

- (VDR-D300 only) The lens cover closes.

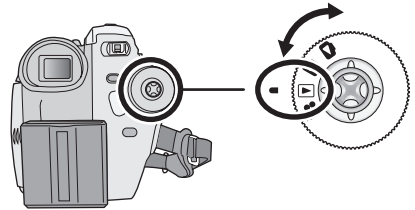

2 Select the scene to be played back.

A Scene number

B Scroll bar display

The selected scene will be encircled by a red frame.

- When 9 or more scenes have been recorded, the next (or previous) page is displayed by moving the joystick.
- If you move and hold the joystick up or down, you can advance 8 scenes at a time. The screen will not change at this time, but the scene numbers and scroll bar display will change so release the joystick when you have arrived at the page with the scene you want to display.

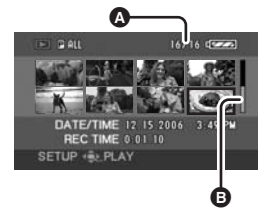

3 Press the joystick.

The selected scene is played back on the full screen.

The operation icon is automatically displayed on the screen.





4 Move the joystick to operate.

: Playback/Pause



 (Move): Skip playback (backward)

 (Move and hold): Review playback*

 (Move): Skip playback (forward)

 (Move and hold): Cue playback*

: Stops the playback and shows the thumbnails.

* Press the  or  button on the remote control.

- During playback, the recording time is not displayed on the screen.
- No sound will be heard except during normal playback.
- If pause play is continued for 5 minutes, the screen returns to the thumbnails.
- When the amount of time recorded on the scene is short, playback may not be possible.
- The thumbnails of motion pictures that cannot be played back are displayed in shades of blue and white.
- The power will not turn off when the LCD monitor and the viewfinder are closed and retracted.
- When playing back a motion picture recorded with other products on this unit or playing back a motion picture recorded with this unit on other products, the picture quality may deteriorate and it may be unplayable. (The message "CANNOT PLAY." appears.)

Slow-motion playback

- 1 Move the joystick up during playback to pause the playback.
- 2 Move and hold the joystick right. (Slow-motion pictures will be played back in reverse when you move and hold the joystick left.)
 - Normal playback is restored when you move the joystick up.



- Operating with the remote control
- Press the ◀ or ▶ button.

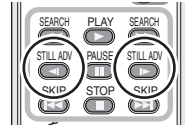

Frame-by-frame playback

The motion picture is advanced one frame at a time.

- 1 Move the joystick up during playback to pause the playback.
- 2 Move the joystick right. (The frames will be advanced one at a time in the reverse direction when you move and hold the joystick left.)
 - Normal playback is restored when you move the joystick up.



- Operating with the remote control
- 1 Press the ⏏ button.

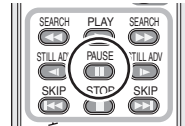

- 2 Press the ◀ or ▶ button.

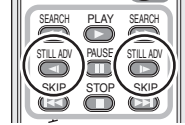

To adjust the volume

Adjust the speaker volume during playback.

Move the volume lever to change the volume level.

Towards “+”: increases the volume

Towards “-”: decreases the volume

- The further the [] indicator moves to the right (towards the “+” end), the higher the volume level becomes.
- When the adjustment is completed, the volume setting display will disappear.

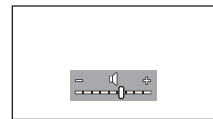
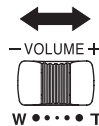

Playing back motion pictures by date

Recorded scenes are grouped by date on this unit. Scenes recorded on the same day can be played back in succession.

- 1 Press the **MENU** button, then select **[▶] PLAY SETUP** → **[■] PLAY MODE** → **[BY DATE]** and press the joystick.

- When [PLAY MODE] is set to [VIEW ALL], all recorded motion pictures will be played back in succession. ([▶]ALL) is displayed.)

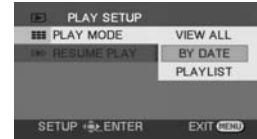

- 2 Select the date for playback, then press the joystick.

The scenes recorded on the same day are displayed as thumbnails.



- 3 Select the scene to be played back.

- Even if scenes are recorded on the same day, they are grouped separately in the following cases.
 - When the number of scenes exceeds 99 **RAM** **-RW(VR)** **-RW(V)** **-R**
 - When the disc is removed **-RW(V)** **-R**
 - When the [ASPECT] setting is changed **-RW(V)** **-R**
 - When the disc is repaired **-RW(V)** **-R**
 - When the mode dial is switched **-R**
 - When the power is turned off **-R**

Resuming the previous playback

- Press the **MENU** button, then select **[▶] PLAY SETUP** → **[▶▶] RESUME PLAY** → **[ON]** and press the joystick.

If playback of a motion picture is stopped, [R] appears on the thumbnail view of the stopped scene.

- If playback is stopped at any point during a motion picture while [RESUME PLAY] is set to [OFF], the next time the motion picture is played back, it will be from the beginning.
- The resume position memorized is cleared if you turn off the power or operate the mode dial. (The [RESUME PLAY] setting is kept.)

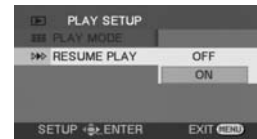

Still picture playback

SD

Play back the still pictures recorded on the card.

1 Rotate the mode dial to select .

The still pictures recorded on the SD card are displayed as thumbnails.

- (VDR-D300 only) The lens cover closes.

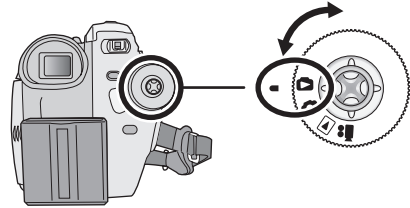

2 Select the file to be played back.

A File number

B Scroll bar display

The selected file will be encircled by a red frame.

- When 9 or more files have been recorded, the next (or previous) page is displayed by moving the joystick.
- If you move and hold the joystick up or down, you can advance 8 files at a time. The screen will not change at this time, but the file numbers and scroll bar display will change so release the joystick when you have arrived at the page with the file you want to display.

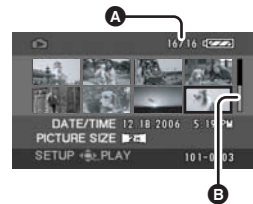



3 Press the joystick.

The selected file is played back on the full screen.

The operation icon is automatically displayed on the screen.



4 Move the joystick to operate.

 : Slide show (playback of the still pictures on the SD card in numerical order) start/pause. (When [SLIDE SHOW] is selected.)

: Plays back the previous picture.

: Plays back the next picture.

: Stops the playback and shows the thumbnails.

Playing back still pictures as a slide show

Press the MENU button, then select
[▶] **PLAY SETUP** → [≡] **PLAY MODE** →
[SLIDE SHOW] and press the joystick.



■ About still picture compatibility

- This unit is compliant with the unified standard DCF (Design rule for Camera File system) established by JEITA (Japan Electronics and Information Technology Industries Association).
- The file format supported by this unit is JPEG. (Not all JPEG formatted files will be played back.)
- If an out-of-specs file is played back, the folder/file number may not be displayed.
- This unit may degrade or not play back data recorded or created on another product and another product may degrade or not play back data recorded on this unit.

- Do not operate the mode dial during the slide show.
- While this unit accesses the SD card (the access lamp is lit), do not remove the SD card.
- It takes time to display the file depending on the number of pixels of the file.
- The thumbnails of still pictures that cannot be played back are displayed in shades of blue and white.
- If you attempt to play back file recorded in a different format or file data is defective, the whole display becomes grayish and an error message may appear.
- When playing back a file recorded on other products, the date and time display is different from when it was recorded.
- The power will not turn off when the LCD monitor and the viewfinder are closed and retracted.

Editing scenes

Deleting scenes

This is for deleting scenes recorded on discs.

RAM -RW(VR)

The deleted scenes cannot be restored.

- Scenes on DVD-RW (Video format) and DVD-R cannot be deleted.

Deleting scenes one at a time

◇ Rotate the mode dial to select .

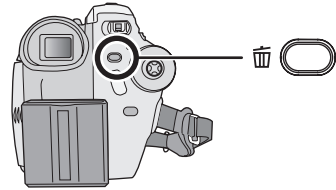

- 1 Press the  button during playback.



- 2 When the confirmation message appears, select [YES], then press the joystick.

Deleting multiple scenes from the thumbnail display

◇ Rotate the mode dial to select .

- 1 Press the MENU button, then select [DELETE] → [SELECT] or [ALL] and press the joystick.

- When [ALL] is selected, the following scenes will be deleted. Proceed to step 4.
 - When [PLAY MODE] is set to [VIEW ALL]: All the scenes on the disc
 - When [PLAY MODE] is set to [BY DATE]: All the scenes selected by date



- 2 (Only when [SELECT] is selected in step 1)
Select the scene to be deleted, then press the joystick.

- The selected scene is encircled by a yellow frame.
- When the joystick is pressed again, the selected scene will be canceled.
- Up to 8 scenes displayed on a page can be set in succession.



- 3 (Only when [SELECT] is selected in step 1)
Press the  button.

- 4 When the confirmation message appears, select [YES], then press the joystick.

(Only when [SELECT] is selected in step 1)

To continue deleting other scenes

Repeat steps 2-4.

To complete editing

Press the MENU button.

- To delete an unwanted part of a scene, divide the scene first, and then delete the unnecessary part. (→ 83)
- In case of [ALL], the deletion may take time if there are many scenes on the disc.
- Do not turn off this unit while deleting.
- When you delete scenes, use a battery with sufficient battery power or use the AC adaptor.
- It may not be possible to delete scenes that have been divided. Combine the divided scenes, and then delete them.



Dividing a scene

This is for dividing a scene into two.

RAM -RW(VR)

To delete unnecessary portion of scene, first divide the scene, and then delete the unnecessary portion.

◇ Rotate the mode dial to select .

- 1 Press the MENU button, then select [ EDIT SCENE] → [ DIVIDE] and press the joystick.

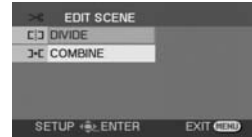

- 2 Select the scene to be divided, then press the joystick.

The selected scene is played back.



- 3 When you reach the area where you want to divide the scene, move the joystick down to set the dividing point.

- Using slow-motion playback or frame-by-frame playback makes it easy to search for the point where you want to divide the scene. (→ 77)



- 4 When the confirmation message appears, select [YES], then press the joystick.

To continue dividing other scenes

Repeat steps 2-4.

To complete editing

Press the MENU button.

Combining scenes

This function is only for combining two consecutive scenes into one.

RAM -RW(VR)

◇ Rotate the mode dial to select .

1 Press the MENU button, then select [⌘ EDIT SCENE] → [⌘ COMBINE] and press the joystick.

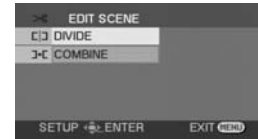

2 Select the scene to be combined, then press the joystick.

- The selected scene and the next scene are combined.
- If you wish to combine scenes that are not next to each other or scenes with different recording dates, first create a playlist and then combine the scenes on the playlist. (→ 86, 91)



3 When the confirmation message appears, select [YES], then press the joystick.

To continue combining other scenes

Repeat steps 2-3.

To complete editing

Press the MENU button.

Using playlists

What is a playlist?

You can create a playlist by gathering your favorites from the recorded scenes. Since the playlist is not created by copying data, you will consume little of the disc capacity by making a playlist.

- If you create or delete playlists, the original scenes will not be modified. Editing scenes on a playlist will not affect the original scenes.

Recorded scenes



Playlist



- The maximum number of items on a disc (per side)
 - Playlists: 99
 - Playlist scenes: 999
- If original scenes are deleted, the portion of playlists created with these scenes is also deleted.

Creating a new playlist

RAM -RW(VR)

◇ Rotate the mode dial to select .

- 1 Press the MENU button, then select [ PLAY SETUP] → [ PLAY MODE] → [PLAYLIST] and press the joystick.

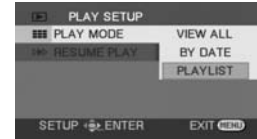

- 2 Select [CREATE], then press the joystick.



- 3 Select the scene to be added to the playlist, then press the joystick.

The selected scene is encircled by a yellow frame.

- When the joystick is pressed again, the selected scene will be canceled.
- Up to 8 scenes can be set in succession.
- The scenes are registered in the playlist in the order that they were selected. After creating a playlist, the order of the scenes in it can be changed by [MOVE] function. (→ 89)

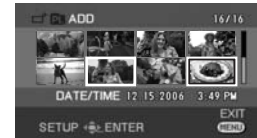

- 4 Press the MENU button.

- 5 When the confirmation message appears, select [YES], then press the joystick.

The thumbnail view screen of the created playlist is displayed.

To add another scene to the same playlist

Select [ADD]. (→ 88)

To playback a playlist

Select the scene to start playback, then press the joystick.

Playing back a playlist

RAM -RW(VR)

◇ Rotate the mode dial to select .

- 1 Press the MENU button, then select [ PLAY SETUP] → [ PLAY MODE] → [PLAYLIST] and press the joystick.



- 2 Select the playlist to be played back, then press the joystick.

Scenes in the selected playlist are displayed as thumbnails.





- 3 Select the scene to start playback, then press the joystick.



To select a different playlist

When the first scene is selected in the playlist thumbnail view screen, move the joystick left. The screen returns to the PLAYLIST VIEW (step 2).

To return to showing the original scenes

Press the MENU button, then select [ PLAY SETUP] → [ PLAY MODE] → [VIEW ALL] or [BY DATE] and press the joystick.

Editing a playlist

RAM -RW(VR)

Editing scenes on a playlist will not affect the original scenes.

Adding scenes to playlist

◇ Select playlist playback mode. (→ 87, steps 1 and 2)

- 1 Press the MENU button, then select [⌘ EDIT] and press the joystick.



- 2 Select the playlist to be edited, then press the joystick.

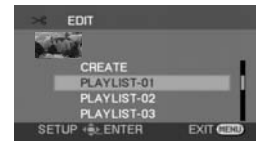

- 3 Select [⊞ ADD], then press the joystick.



- 4 Select the scene to be added, then press the joystick.

The selected scene is encircled by a yellow frame.

- When the joystick is pressed again, the selected scene will be canceled.
- Up to 8 scenes can be set in succession.
- The scenes are added to the playlist in the order that they were selected. The order of the scenes in the playlist can be changed by [MOVE] function. (→ 89)

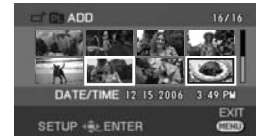

- 5 Press the MENU button.

- 6 When the confirmation message appears, select [YES], then press the joystick.

The thumbnail view screen of the playlist that scenes were added to is displayed.

To continue adding scenes to the playlist

Repeat steps 1-6.

Moving scenes

The scenes in a playlist can be moved.

◇ Select playlist playback mode. (→ 87, steps 1 and 2)

1 Press the MENU button, then select [> EDIT] and press the joystick.



2 Select the playlist to be edited, then press the joystick.



3 Select [≡ MOVE], then press the joystick.



4 Select the scene to be moved, then press the joystick.

The selected scene is encircled by a yellow frame, and the position to insert is shown by a red bar.



5 Select the position to insert the scene, then press the joystick.



To continue moving other scenes in the playlist

Repeat steps 4-5.

To complete editing

Press the MENU button.

Dividing a scene

You can divide a scene into two parts.

- Dividing scenes on a playlist will not affect the original scenes.

◇ **Select playlist playback mode. (→ 87, steps 1 and 2)**

- 1 Press the MENU button, then select [∞ EDIT] and press the joystick.**



- 2 Select the playlist to be edited, then press the joystick.**



- 3 Select [∞ DIVIDE], then press the joystick.**



- 4 Select the scene to be divided, then press the joystick.**

The selected scene is played back.



- 5 When you reach the area where you want to divide the scene, move the joystick down to set the dividing point.**

- Using slow-motion playback or frame-by-frame playback makes it easy to search for the point where you want to divide the scene. (→ 77)



- 6 When the confirmation message appears, select [YES], then press the joystick.**

To continue dividing other scenes

Repeat steps 4-6.

To complete editing

Press the MENU button.

Combining scenes

Two consecutive scenes can be combined into one.

- Combining scenes on a playlist will not affect the original scenes.

◇ **Select playlist playback mode. (→ 87, steps 1 and 2)**

- Press the MENU button, then select [✂ EDIT] and press the joystick.



- Select the playlist to be edited, then press the joystick.

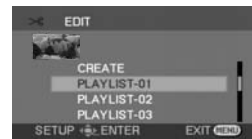

- Select [⌘ COMBINE], then press the joystick.



- Select the scene to be combined, then press the joystick.

- The selected scene and the next scene are combined.



- When the confirmation message appears, select [YES], then press the joystick.

To continue combining other scenes

Repeat steps 4-5.

To complete editing

Press the MENU button.

Deleting scenes

- Deleting scenes on a playlist will not affect the original scenes.

Deleting scenes one at a time:

◇ Select playlist playback mode. (→ 87, steps 1 and 2)

1 Press the  button during playback.

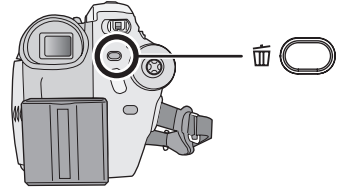

2 When the confirmation message appears, select [YES], then press the joystick.

Deleting multiple scenes from the thumbnail display:



◇ Select playlist playback mode. (→ 87, steps 1 and 2)

1 Press the MENU button, then select [ EDIT] and press the joystick.



2 Select the playlist to be edited, then press the joystick.



3 Select [ DELETE] → [ SELECT] or [ ALL] and press the joystick.

- When [ALL] is selected, the selected playlist will be erased. Proceed to step 6.



4 (Only when [SELECT] is selected in step 3)
Select the scene to be deleted, then press the joystick.

The selected scene is encircled by a yellow frame.

- When the joystick is pressed again, the selected scene will be canceled.
- Up to 8 scenes displayed on a page can be set in succession.

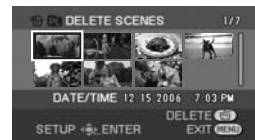

- 5** (Only when [SELECT] is selected in step 3)
Press the  button.
-

- 6 When the confirmation message appears, select [YES], then press the joystick.**
-

(Only when [SELECT] is selected in step 3)

To continue deleting other scenes

Repeat steps 4-6.

To complete editing

Press the MENU button.

- Deleting scenes on a playlist will not increase the remaining capacity for recording.
- The playlist itself is deleted if you delete all the scenes in it.
- When a playlist is deleted, the number of each subsequent playlist decreases by one.
- It may not be possible to delete scenes that have been divided. Combine the divided scenes, and then delete them.

Editing still pictures

Deleting still pictures

This is for deleting still picture files recorded on SD cards.

SD

The deleted files cannot be restored.

Deleting files one at a time

◇ Rotate the mode dial to select .

1 Press the  button during playback.

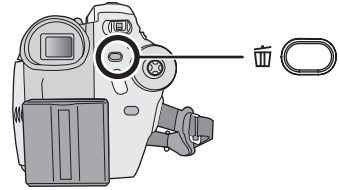

2 When the confirmation message appears, select [YES], then press the joystick.

Deleting multiple files from the thumbnail display

◇ Rotate the mode dial to select .

1 Press the MENU button, then select [DELETE]
→ [SELECT] or [ALL] and press the joystick.

- When [ALL] is selected, all files on the SD card except the locked files will be erased. Proceed to step 4.



2 (Only when [SELECT] is selected in step 1)
Select the file to be deleted, then press the joystick.

The selected file is encircled by a yellow frame.

- When the joystick is pressed again, the selected file will be canceled.
- Up to 8 files displayed on a page can be set in succession.

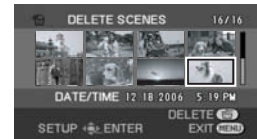

3 (Only when [SELECT] is selected in step 1)
Press the  button.

4 When the confirmation message appears, select [YES], then press the joystick.

(Only when [SELECT] is selected in step 1)

To continue deleting other files

Repeat steps 2-4.

To complete editing

Press the MENU button.

■ Deleting still picture files recorded on an SD card by other products

A still picture file (other than JPEG) that cannot be played back on this unit may be erased.

- In case of [ALL], the deletion may take time if there are many files on the SD card.
- Do not turn off this unit while deleting.
- When you delete files, use a battery with sufficient battery power or use the AC adaptor.
- Do not remove the SD card while deleting.
- If files conforming to DCF standard are deleted, all the data related to the files will be deleted.



Locking still pictures

This is for preventing still picture files from being deleted by mistake.

SD

Still picture files recorded on an SD card can be locked so that they may not be deleted by mistake. (However even if you lock some files on an SD card, formatting the card will delete all the files.)

◇ Rotate the mode dial to select .

- 1 Press the MENU button, then select [ PLAY SETUP] → [ LOCK] → [YES] and press the joystick.



- 2 Select the file to be protected, then press the joystick.

[] display appears and the selected file is locked.

- Press the joystick again to release the lock setting.
- You can also select multiple files in succession.

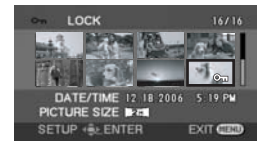

To complete the settings

Press the MENU button.

DPOF setting

This is for writing the printing data on an SD card.

SD

You can write the data of still pictures to be printed and number of copies (DPOF data) onto the SD card.

◇ Rotate the mode dial to select .

1 Press the MENU button, then select [▶] PLAY SETUP → [DPOF SET] → [SET] and press the joystick.



2 Select the file to be set, then press the joystick.

The number of prints set to be in DPOF is displayed.

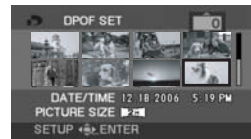

3 Move the joystick up or down to select the number of prints, then press the joystick.

- You can select from 0 to 999. (The selected number of pictures can be printed with the printer supporting DPOF.)
- To cancel the setting, set the number of prints to [0].
- You can also select multiple files in succession.

To complete the settings

Press the MENU button.

To cancel all DPOF settings

Press the MENU button, then select [▶] PLAY SETUP → [DPOF SET] → [CANCEL ALL] and press the joystick.

- When the confirmation message appears, select [YES], then press the joystick.

■ What is DPOF?

DPOF stands for Digital Print Order Format. This enables picture printing information to be written onto an SD card so that it can be used on a system supporting DPOF.

- The DPOF setting can be established for up to 999 files.
- DPOF setting made on other devices may not be recognized by this unit. Please perform the DPOF settings on this unit.
- You cannot add the recording date to pictures to be printed with the DPOF settings.

Formatting discs and cards



Formatting discs

This is for initializing discs.

RAM -RW(VR) -RW(V)

Please be aware that if a disc is formatted, then all the data recorded on the disc will be erased.

◇ Rotate the mode dial to select .

1 Press the MENU button, then select [ SETUP] → [ FORMAT DISC] → [YES] and press the joystick.

• When formatting a DVD-RAM, skip to step 3.

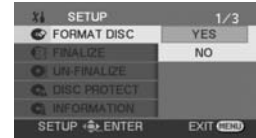

2 (When formatting a DVD-RW only) Select format type (→ 24), then press the joystick.



3 When the confirmation message appears, select [YES], then press the joystick.

• When formatting is complete, press the MENU button to exit the message screen.

- In the case of a double sided disc, format each side.
- It may not be possible to format a disc with many scratches or dirt. Such discs cannot be used.
- During formatting, do not turn this unit off.
- When you format the disc, use a battery with sufficient battery power or the AC adaptor.

Formatting DVD-RAM:

- We recommend formatting on this unit. If formatting on a computer, use the supplied software. For more details, refer to the operating instructions of the software.

If you connect this unit to a computer to format a DVD-RAM, you cannot use DVDForm (→ 112) to physically format it. Use a separate DVD-RAM drive to physically format a DVD-RAM.

Formatting DVD-RW:

- Format on this unit.



Formatting an SD card

This is for initializing cards.

SD

Please be aware that if an SD card is formatted, then all the data recorded on the card will be erased. Store important data on a computer, etc.

◇ Rotate the mode dial to select .

- 1 Press the MENU button, then select [ SETUP] → [ FORMAT CARD] → [YES] and press the joystick.

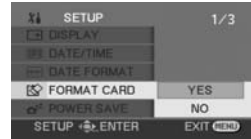

- 2 When the confirmation message appears, select [YES], then press the joystick.

- When formatting is complete, press the MENU button to exit the message screen.
- Use this unit to format SD cards. If an SD card is formatted on other products (such as a computer), the time spent for recording may become longer and you may not be able to use the SD card.
- Depending on the type of SD card being used, it may take time to format.
- During formatting, do not turn this unit off.
- When you format the SD card, use a battery with sufficient battery power or the AC adaptor.
- Do not remove the SD card while formatting.

Finalizing a disc

Finalizing a disc

This is for enabling discs to be played on other devices.

-RW(VR) **-RW(V)** **-R**

To play back a DVD-RW (Video format) or a DVD-R on other devices e.g. a DVD player, finalize the disc.

■ Finalizing video format discs

Be sure to finalize the disc on this unit, before using it on other devices.

DVD-RW (Video format): After finalizing, the disc becomes play-only. You can record on the disc after un-finalizing (→ 101) or formatting (→ 98).

DVD-R: After finalizing, the disc becomes play-only and you can no longer record.

■ Finalizing VR format discs

DVD-RAM: It is not necessary to finalize DVD-RAM.

DVD-RW (VR format): Finalizing a DVD-RW (VR format) increases its compatibility with other products. DVD-RW (VR format) after finalization can be recorded and edited in the same way as DVD-RW (VR format) before finalization.

◇ **Connect this unit to the AC adaptor.** (Finalization cannot be executed using a battery.)

◇ **Rotate the mode dial to select** .

1 Press the MENU button, then select [ SETUP]
→ [ FINALIZE] → [**YES**] and press the joystick.

• When finalizing a DVD-RW (VR format), skip to step 3.

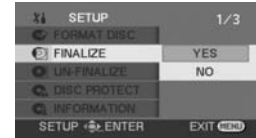

2 [When finalizing a DVD-RW (Video format) or DVD-R]

Select whether or not to create a top menu, then press the joystick.

YES: After finalizing, a top menu containing thumbnails appears first during playback.

NO: A top menu is not created. Playback starts from the first scene.

3 When the confirmation message appears, select [YES], then press the joystick.

• When finalizing is complete, press the MENU button to exit the message screen.

• Do not finalize a disc recorded on this unit using any other device.

• In the case of a double sided disc, finalize each side.

• The top menu created when finalizing does not appear on this unit. Play back the disc on a DVD player.

Titles are displayed by recording date on the top menu. However, when [PLAY MODE] is set to [BY DATE] to view scenes by recording date, some scenes recorded on the same date may be separated. (→ 78) These scenes will be displayed as separate titles on the top menu.

• Depending on the condition of the disc, the time it takes for finalizing will differ. It may take up to 15 minutes.

• If this unit becomes hot or is shaken strongly or impacted while finalizing, the finalization will fail and the disc may become unplayable on other devices.



• If the power supply stops while finalizing, the finalization will fail and the disc may become unplayable on other devices even if disc repair is carried out.

Un-finalizing a DVD-RW

This is for un-finalizing a DVD-RW (Video format) so that it can be used for recording.

-RW(V)

◇ Rotate the mode dial to select .

1 Press the MENU button, then select [ SETUP] → [ UN-FINALIZE] → [YES] and press the joystick.

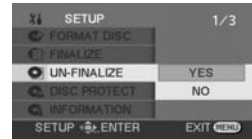

2 When the confirmation message appears, select [YES], then press the joystick.

- When un-finalizing is complete, press the MENU button to exit the message screen.
- DVD-RW (VR format) cannot be un-finalized. DVD-RW (VR format) after finalization can be recorded and edited in the same way as DVD-RW (VR format) before finalization.
- DVD-R cannot be un-finalized.
- When you un-finalize the disc, use a battery with sufficient battery power or the AC adaptor.

Protecting a disc

RAM -RW(VR)

This is for preventing recorded contents from being deleted or edited by mistake. Further recording and editing is not possible on protected discs until the protection is released.

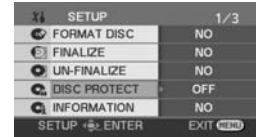

◇ Rotate the mode dial to select .

- 1 Press the MENU button, then select [ SETUP] → [ DISC PROTECT] and press the joystick.



- 2 When the confirmation message appears, select [YES], then press the joystick.

To release disc protection

- 1) Press the MENU button, then select [ SETUP] → [ DISC PROTECT] and press the joystick.
- 2) When the confirmation message appears, select [YES], then press the joystick.



- If the disc has been protected on another device, it may not be possible to release the protection on this unit. In this case, release the protection on the device that you used to protect it.

Displaying disc information

RAM -RW(VR) -RW(V) -R

Information such as the number of recorded scenes, the remaining space and whether or not the disc is finalized or protected is displayed.

◇ Rotate the mode dial to select .

Press the MENU button, then select [ SETUP] → [ INFORMATION] → [YES] and press the joystick.

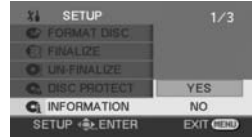

To exit the information screen

Press the MENU button.

With a TV

Playback on TV

RAM -RW(VR) -RW(V) -R SD

The motion pictures and still pictures recorded by this unit can be played back on a TV.

- Use the AC adaptor to free you from worrying about the battery running down.

1 Connect this unit and a TV.

- **A** AV/S cable (supplied)
 - Insert the plugs as far as they will go.

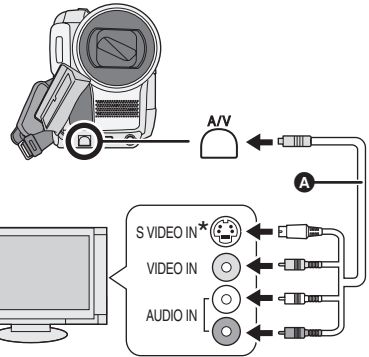

* If the TV has an S Video terminal, also connect the S Video plug to it. This allows you to enjoy more beautiful pictures.

2 Turn on this unit, then rotate the mode dial to select or .

3 Change the input channel on the TV.

- The channel set will differ depending on the terminal to which the unit is connected.

4 Start playback on this unit.

The image and audio are output on the TV.



■ If the image or audio from this unit is not output on the TV

- Check that the plugs are inserted as far as they go.
- Check the connected terminal.
- **Check the TV's input setting (input switch).** (For more information, please read the operating instructions for the TV.)

- If the images are not displayed correctly on a wide-screen TV, adjust the aspect setting on the TV. (Refer to the operating instructions of the TV for details.) If the pictures are displayed squeezed horizontally on a regular TV (4:3), change the [TV ASPECT] setting on this unit. (→ 105)

■ To watch images with a 16:9 aspect ratio on a regular TV (4:3)

When playing back motion pictures recorded with a 16:9 aspect ratio ([ASPECT] was set to [16:9]) or still pictures recorded with a 16:9 aspect ratio ([PICTURE SIZE] was set to [2M] (VDR-D300)/ [1.7M] (VDR-D250)) on a TV with a 4:3 aspect ratio, the images may be squeezed horizontally. In this case, change the menu setting to play back the pictures in the original aspect ratio. (Depending on the TV setting, the pictures may not be displayed correctly. For more information, please read the operating instructions of your TV.)

Press the MENU button, then select [ SETUP] → [ TV ASPECT] → [4:3] and press the joystick.



Example of images with a 16:9 aspect ratio on a regular TV (4:3)

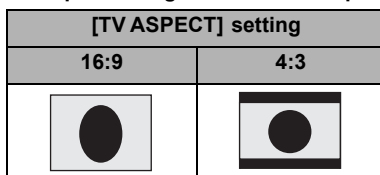

- This function's default setting is [16:9].

■ To display the on-screen information on the TV

The information displayed on the screen (operation icon and time code, etc.) can be displayed on the TV.

Press the EXT DISPLAY button on the remote control.

- Press the button again to erase the information.
- The screen on this unit will not change.

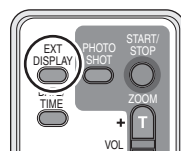

With a DVD recorder/player

Playback on DVD recorder/player

- When playing back a disc on a DVD recorder/player, place the device so that the disc lies flat.

Playing back a DVD-RAM or a DVD-RW (VR format)

Insert the disc in the DVD recorder/player, then play it back.

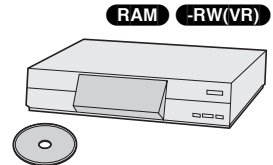

- Playback is only possible on devices that support 8 cm (3") DVD-RAM or DVD-RW (VR format). See the operating instructions for DVD recorder/player.
- DVD-RW (VR format) may have to be finalized. In this case, finalize the disc on this unit. (→ 100)
- You cannot record images that allow "One time only recording" on a 8 cm (3") disc.

Playing back a DVD-RW (Video format) or a DVD-R

1 Finalize the disc on this unit. (→ 100)

2 Insert the disc in the DVD recorder/player, then play it back.

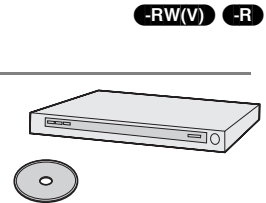

- Do not insert a disc that has not been finalized into a DVD recorder/player: the disc may be unusable. Also, a message asking you to format the disc may appear on the DVD recorder. Do not format the disc.
- Playback is possible on devices that support 8 cm (3") DVD-Video, but playback on all DVD players is not guaranteed.

Copying (dubbing) recordings onto a DVD recorder's hard disk

RAM -RW(VR) -RW(V) -R

If you have a DVD recorder with hard disk, images recorded by this unit can be stored on the hard disk.

- If you want to record (dub) a disc that the DVD recorder is not compatible with, connect this unit and the DVD recorder with the AV/S cable and then record (dub) the disc. (→ 108)

1 [Only when you record (dub) a DVD-RW (Video format) or DVD-R] Finalize the disc on this unit. (→ 100)

2 Insert the disc in the DVD recorder, then copy (dub) the contents onto the hard disk.

- For details on how to copy (dub) the images onto the hard disk, refer to the operating instructions of the DVD recorder.

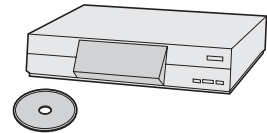

- DVD-RW (VR format) may have to be finalized. In this case, finalize the disc on this unit. (→ 100)
- Do not insert a DVD-RW (Video format) or DVD-R that has not been finalized into a DVD recorder: the disc may be unusable. Also, a message asking you to format the disc may appear on the DVD recorder. Do not format the disc.
- If your DVD recorder has an SD card slot, you can write the still picture files recorded on an SD card with this unit to a disc or the hard disk.
- You cannot record images that allow "One time only recording" on a 8 cm (3") disc.

If you record (dub) images directly from the disc or with the AV/S cable and then play them back on a wide-screen TV, they may be squeezed horizontally. In this case, refer to the operating instructions of the device you are recording (dubbing) to or read the operating instructions of the wide-screen TV and set the aspect setting to 16:9 (Full).

With a VCR

Recording (dubbing) images onto other video devices

RAM -RW(VR) -RW(V) -R

You can record (dub) images played back on this unit onto other video devices.

You can create a playlist by gathering the scenes you want to record (dub), then record (dub) the scenes in this playlist only to other devices. (→ 86)

- Use the AC adaptor to free you from worrying about the battery running down.

1 Connect this unit and a video device.

- **A** AV/S cable (supplied)
- Insert the plugs as far as they will go.

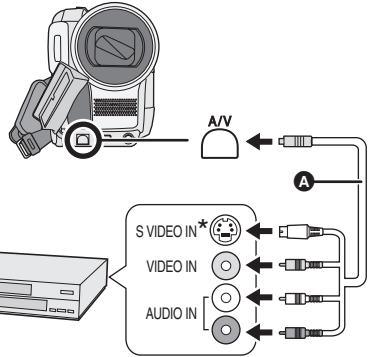

* If the video device has an S Video terminal, also connect the S Video plug into it. This allows you to enjoy more beautiful pictures.

2 Turn on this unit, then rotate the mode dial to select .

3 Change the input channel on the video device and TV.

- The channel set will differ depending on the terminal to which the unit is connected.

4 Start playback on this unit.

Then start recording on the connected device.

- See the operating instructions of the video device for details.

To stop recording (dubbing)

Stop recording on the connected device.

Then stop playback on this unit.



- If the date and time display and function indication are unnecessary, cancel them before recording (dubbing). (→ 46, 105)

With a printer (PictBridge)

SD

To print pictures by directly connecting this unit to the printer, use a printer compatible with PictBridge. (Read the operating instructions for the printer.)

- Use the AC adaptor to free you from worrying about the battery running down.
- ◇ **Insert an SD card with recorded images in the unit, turn on the unit and then rotate the mode dial to select .**

1 Press the MENU button, then select [ SETUP] → [ USB FUNCTION] → [PictBridge] and press the joystick.

- Press the MENU button to exit the menu screen.

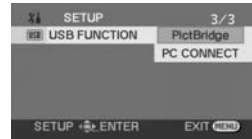

2 Connect this unit and a printer.

- A** USB cable (supplied)
 - Insert the plugs as far as they will go.
 The [PictBridge] indication appears on this unit's screen.
- If the [PictBridge] indication does not appear or continues to flash, disconnect and then reconnect the USB cable or check the printer, SD card and settings on this unit.
- Do not use any other USB cables except the supplied one. (Operation is not guaranteed with any other USB cables.)

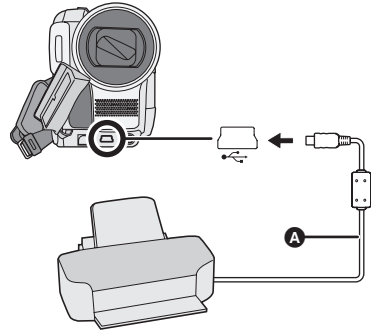

3 Select a file to be printed, then press the joystick.

The number of pictures set is displayed.



4 Move the joystick up or down to select the desired number of prints, then press the joystick.

- You can set up to 9 prints.
- To cancel the setting, set the number of prints to [0].
- Up to 8 files displayed on a page can be set in succession by repeating steps 3 and 4.

5 Press the MENU button to display the PictBridge menus.



With other products

6 Select the date print setting on [DATE PRINT].

- If the printer is not capable of date printing, this setting is unavailable.



7 Select the paper size setting on [PAPER SIZE].

STANDARD: Size specific to the printer

4×5 INCH: L size

5×7 INCH: 2L size

4×6 INCH: Postcard size

A4: A4 size

- You cannot set paper sizes not supported on the printer.

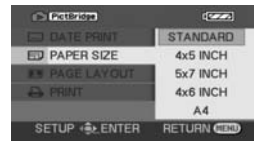

8 Select the layout setting on [PAGE LAYOUT].

STANDARD: Layout specific to the printer

 : No frame print

 : Frame print

- You cannot set page layouts not supported on the printer.

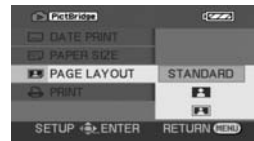

9 Select [PRINT] → [YES] and press the joystick.

The pictures are printed.

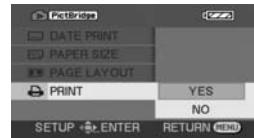

- Exit PictBridge by disconnecting the USB cable (supplied) after the pictures have been printed.



When you stop printing halfway

Move the joystick down.

A confirmation message appears. If [YES] is selected, the number of prints set is canceled and the screen returns to step 3. If [NO] is selected, all the settings are kept and the screen returns to step 3.

- Avoid the following operations during printing. These operations disable proper printing.
 - Disconnecting the USB cable
 - Removing the SD card
 - Switching the mode dial
 - Turning off the power
- Check the settings for the paper size, quality of print, etc. on the printer.
- The sides of pictures recorded when [] (VDR-D300)/[] (VDR-D250) is set may be cut at printing. Check before printing.

When using the printer with a trimming feature or other feature which cuts out both edges of the pictures, cancel the feature for printing. (Refer to the operating instructions of the printer for details.)
- You may not be able to print still pictures recorded with other products.
- When the unit is connected directly to the printer, the DPOF settings cannot be used.
- Connect the printer directly to this unit. Do not use a USB hub.

Before using with a computer (Windows)

What you can do with a computer

■ When using a DVD-RAM or DVD-RW (VR format) recorded on this unit

- Before using DVD-RW (VR format) on a computer, be sure to finalize it on this unit.

Can do	Software used
Playing back on a computer	DVD-MovieAlbumSE (supplied)
Copying a disc	DVD-MovieAlbum CopyTool (supplied)
Editing motion pictures (DVD-RAM only)	DVD-MovieAlbumSE (supplied)
Creating a DVD-Video disc	DVD-MovieAlbumSE (supplied) and DVDfunSTUDIO (supplied)

■ When using a DVD-RW (Video format) or DVD-R recorded on this unit

- Before using the disc on a computer, be sure to finalize it on this unit.

Can do	Software used
Playing back on a computer	Commercially available DVD-Video playback software

■ When using an SD card recorded on this unit

Can do	Software used
Playing back on a computer	Standard Windows picture viewer or a commercially available picture viewer
Copying files to a computer	Windows Explorer

- We will not guarantee proper operation of this unit if you use software other than that supplied with this unit to read/write data to the unit.

Contents on provided CD-ROM

The following software applications are contained on the provided CD-ROM.

■ DVD-RAM Driver

This is necessary to configure the unit as a drive on a computer.

DVDForm:

This is used to format DVD-RAM on a computer.

■ DVD-MovieAlbum

DVD-MovieAlbumSE:

This software is for playing back and editing* VR format motion pictures.

By using DVD-MovieAlbumSE with this unit, it is possible to perform playback and editing* of the DVD-RAM or DVD-RW (VR format). It is also possible to transfer exported data to DVDfunSTUDIO.

DVD-RAM/
DVD-RW(VR)

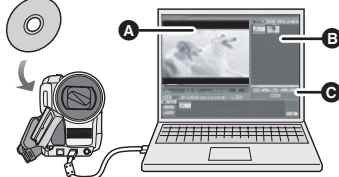

Playing back and editing* DVD-RAM and DVD-RW (VR format).

- A** Playback area
- B** Thumbnails
Disc contents are shown.
- C** Editing buttons*

* Editing can only be performed on a DVD-RAM.

DVD-MovieAlbum CopyTool:

This is used when creating a copy of a VR format disc.

Copy the data to the hard disk of the computer and then write it to another DVD-RAM.

■ DVDfunSTUDIO

This software is for creating a DVD-Video disc.

Use this software when burning a DVD-Video disc from motion pictures edited using DVD-MovieAlbumSE. For details, refer to page 127.

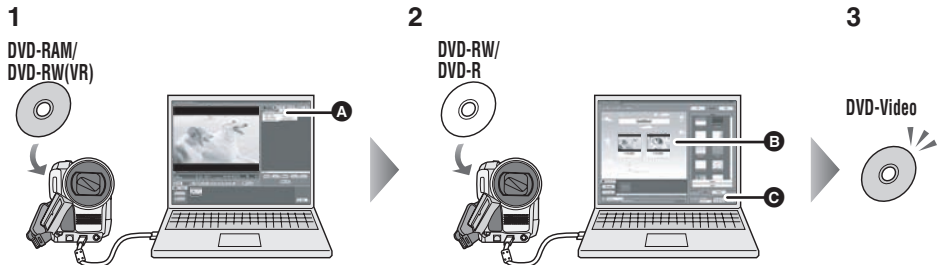

1 Export the images from a DVD-RAM or DVD-RW (VR format) with DVD-MovieAlbumSE.

A File Export

2 Create a DVD menu with DVDfunSTUDIO, then write the data to a DVD-RW or DVD-R.

B DVD menus created

Arrange the motion pictures exported from DVD-MovieAlbumSE in the DVD menu and edit the menu design.

C Burning button

The contents start being written to disc.

3 A DVD-Video disc is created.

Playback is possible on a DVD player that supports 8 cm (3") DVD-Video.

■ Acrobat Reader

To view the installed operating instructions, Adobe Acrobat Reader 5.0 or later is required.

If the Adobe Acrobat Reader is not already installed on your computer, you can install it from the CD-ROM. Click the [Acrobat Reader] in [Setup Menu], and follow the on-screen messages to install.

Operating environment

- A CD-ROM drive is necessary to install the supplied software applications.
- When 2 or more USB devices are connected to a computer, or when devices are connected through USB hubs or by using extension cables, proper operation is not guaranteed.
- Use the supplied USB cable when connecting to the computer. (Operation is not guaranteed with any other USB cables.)

■ DVD-RAM Driver

Personal computer	IBM PC/AT compatible personal computer
OS	Microsoft Windows 2000 Professional Microsoft Windows XP Home Edition Microsoft Windows XP Professional

■ DVD-MovieAlbumSE 4.2

Personal computer	IBM PC/AT compatible personal computer
OS	Microsoft Windows 2000 Professional Microsoft Windows XP Home Edition Microsoft Windows XP Professional
CPU	Intel Pentium III 450 MHz or higher (1 GHz or higher recommended) or Intel Celeron 633 MHz or higher (including compatible CPU) (Intel Pentium III 1 GHz or higher recommended for Windows XP)
RAM	128 MB or more (256 MB or more recommended)
Display	High Color (16 bit) or more Desktop resolution of 800×600 pixels or more (1024×768 pixels or more recommended) 4 MB video memory or more
Free hard disk space	200 MB or more
Necessary software	DirectX 8.1, 9.0, 9.0a, 9.0b, 9.0c Acrobat Reader 5.0 or later DVD-RAM Driver
Sound	DirectSound Support Windows compatible sound device

- Even if the system requirements mentioned in these operating instructions are fulfilled, some computers cannot be used.
- This software can not be used on Macintosh.
- DirectX 9.0b will be installed automatically during installation of the supplied software.
- This software is not compatible with a multi-CPU environment.
- Operation on Microsoft Windows XP Media Center Edition, Tablet PC Edition and 64-bit operating system is not guaranteed.
- Depending upon the environment of your computer, if it does not support USB 2.0 (Hi-Speed), for example, frame dropout may occur, the audio may be intermittent, or the software may run slowly when you play back recorded images. DVD-RAM and DVD-RW (VR format) can be used if you insert them in the computer's internal DVD-RAM/DVD-RW (VR format) compatible drive.

■ DVDfunSTUDIO 2.4

Personal computer	IBM PC/AT compatible personal computer
OS	Microsoft Windows 2000 Professional Service Pack 4 Microsoft Windows XP Home Edition Service Pack 2 Microsoft Windows XP Professional Service Pack 2
CPU	Intel Pentium III 800 MHz or higher
RAM	256 MB or more (512 MB or more recommended)
Display	High Color (16 bit) or more Desktop resolution of 1024×768 pixels or more 4 MB video memory or more
Free hard disk space	200 MB or more ● When writing to a disc, the same amount of free space as the disc is necessary.
Necessary software	DirectX 9.0b, 9.0c ● If you install the software in a computer that is not compatible with DirectX 9.0b or 9.0c, the computer may not work properly. If you are unsure whether or not your computer is compatible, contact the maker of your computer. Acrobat Reader 5.0 or later
Sound	DirectSound Support
Interface	USB port [USB 2.0 (Hi-Speed) recommended]

- Even if the system requirements mentioned in these operating instructions are fulfilled, some computers cannot be used.
- This software can not be used on Macintosh.
- DirectX 9.0b will be installed automatically during installation of the supplied software.
- Operation on an OS other than the one pre-installed is not guaranteed.
- Operation is not guaranteed on computers that are not PC/AT compatible.
- Input is not supported in languages other than English, French and Spanish.
- Operation cannot be guaranteed on all DVD drives.
- DVD discs authored with this software are not guaranteed to play in all DVD players.
- Operation on Microsoft Windows XP Media Center Edition and Tablet PC Edition is not guaranteed.
- This software is not compatible with Microsoft Windows 3.1, Windows 95, Windows 98, Windows ME, Windows NT and 64-bit operating system.
- This software is not compatible with a multi-CPU environment.
- This software is not compatible with a multi-boot environment.
- If your computer does not satisfy the above system requirements, an error may occur when writing data to disc.
- Set the display resolution to 1024×768 (16 bits color) or higher.
Select [start] → ([Settings] →) [Control Panel] → ([Appearance and Themes] →) [Display] and select [Settings] tab, and then adjust [Screen resolution] and [Color quality].

Before using with a computer (Windows)

■ **Using Built-in SD Drive**

Personal computer	IBM PC/AT compatible personal computer
OS	Microsoft Windows 2000 Professional Microsoft Windows XP Home Edition Microsoft Windows XP Professional
CPU	Intel Pentium II 300 MHz or higher
RAM	32 MB or more (64 MB or more recommended)
Interface	USB 1.1 or later — A type

- The USB equipment operates with the driver installed as standard in OS.

End User License Agreement

Before opening the CD-ROM package, please read the following.

You ("Licensee") are granted a license for the Software defined in this End User Software Agreement ("Agreement") on condition that you agree to the terms and conditions of this Agreement. If Licensee does not agree to the terms and conditions of this Agreement, promptly return the Software to Matsushita Electric Industrial Co., Ltd. ("Matsushita"), its distributors or dealers from which you made the purchase.

Article 1 License

Licensee is granted the right to use the software, including the information recorded or described on the CD-ROM, instruction manuals, and any other media provided to Licensee (collectively "Software"), but all applicable rights to patents, copyrights, trademarks and trade secrets in the Software are not transferred to Licensee.

Article 2 Use by a Third Party

Licensee may not use, copy, modify, transfer or allow any third party, whether free of charge or not, to use, copy or modify the Software, except as expressly provided for in this Agreement.

Article 3 Restrictions on Copying the Software

Licensee may make a single copy of the Software in whole or in part solely for back-up purposes.

Article 4 Computer

Licensee may only use the Software on a single computer at a single location.

Article 5 Reverse Engineering, Decompiling or Disassembly

Licensee may not reverse engineer, decompile, or disassemble the Software, except to the extent either of them is permitted under law or regulation of the country where Licensee resides. Matsushita, or its distributors or dealers will not be responsible for any defects in the Software or damage to Licensee caused by Licensee's reverse engineering, decompiling, or disassembly of the Software.

Article 6 Limitation of Liability

The Software is provided "AS-IS" without warranty of any kind, either expressed or implied, including, but not limited to, warranties of non-infringement, merchantability and/or fitness for a particular purpose. Further, Matsushita does not warrant that the operation of the Software will be uninterrupted or error free. Matsushita or any of its distributors or dealers will not be liable for any damage suffered by Licensee arising from or in connection with Licensee's use of the Software.

Article 7 Export Control

Licensee agrees not to export or re-export to any country the Software in any form without the appropriate export licenses under regulations of the country where Licensee resides, if necessary.

Article 8 Termination of License

The right granted to Licensee hereunder will be automatically terminated if Licensee violates any of the terms and conditions of this Agreement. Upon such automatic termination, Licensee must destroy the Software and related documentation together with all the copies thereof at Licensee's own expense.

Installation (Windows)

When installing the software, log on to your computer as the Administrator or with a user name with equivalent authorization. (If you do not have authorization to do this, consult your manager.)

Do not connect the USB cable before installing the DVD-RAM Driver.
If the DVD-RAM Driver is installed after connecting this unit and the computer with the USB cable, this unit may not be correctly recognized by the computer.
(The DVD-RAM Driver has a driver for USB connection.)

- Before starting the installation, close any other software applications which are running.
- Do not perform any other operations on your computer while the software is being installed.
- Install DVD-RAM Driver and then install DVD-MovieAlbumSE or DVDFunSTUDIO.

Installing DVD-RAM Driver

1 Insert the CD-ROM into the computer.

The [Setup Menu] screen will appear.

- If the [Setup Menu] screen does not appear, double-click the CD-ROM drive icon in [My Computer].



2 Click [DVD-RAM Driver].

- The software application may not run properly if you cancel the installation at any point e.g. by pressing [Cancel].



3 Click [Driver and Formatter Setup].

- If an [Information] or [Question] message appears, continue to follow the on-screen messages to install it.



4 Click [Next].



5 Read carefully through the End User License Agreement (→ 117), then click [Yes].

- You cannot install the application if you click [No].



6 Click [Next].

Continue to follow the on-screen messages to install it.

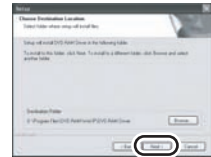

- 7 When installation is complete, some notes will appear:
Check the contents, then click [X] at the top right of window.



8 Click [Finish].

Windows 2000 only:

The detection of device will start, after which it will take several minutes for the computer to detect the device. When detecting the device is complete, a message that prompts you to reboot will appear:
 Click [Yes].



The computer must be rebooted for the driver to work.

■ If any trouble has occurred while installing DVD-RAM Driver:

When the [Block] is selected in the [Driver Signing Options] in the [System Properties], the installation procedure will not complete. Select [Warn] and try again.

To check and change the setting, select [start] → ([Settings] →) [Control Panel] → ([Performance and Maintenance] →) [System] and select [Driver Signing] of the [Hardware] tab.

■ About the [RAMASST] support tool:

[RAMASST] is a support tool for Windows XP that disables the drive's CD writing function so that data can be written from a computer to a DVD-RAM.

When you install the DVD-RAM Driver, [RAMASST] is automatically installed and displayed in [Startup].

Installing DVD-MovieAlbumSE

1 Insert the CD-ROM into the computer.

The [Setup Menu] screen will appear.

- If the [Setup Menu] screen does not appear, double-click the CD-ROM drive icon in [My Computer].



2 Click [DVD-MovieAlbum].

- The software application may not run properly if you cancel the installation at any point e.g. by pressing [Cancel].
- Depending on the operating environment, you may be required to install DirectX 9.0b. If so, click [Yes], and install it.
If you install the software in a computer that is not compatible with DirectX 9.0b or 9.0c, the computer may not work properly. If you are unsure whether or not your computer is compatible, contact the maker of your computer.



3 Click [Next].



4 Select [NTSC] for the TV system, click [Next].



5 Click [Next].

Continue to follow the on-screen messages to install it.



6 Click [Finish].

The computer must be rebooted for the application to work.



Installing DVDFunSTUDIO

1 Insert the CD-ROM into the computer.

The [Setup Menu] screen will appear.

- If the [Setup Menu] screen does not appear, double-click the CD-ROM drive icon in [My Computer].



2 Click [DVDFunSTUDIO].

- The software application may not run properly if you cancel the installation at any point e.g. by pressing [Cancel].
- Depending on the operating environment, you may be required to install DirectX 9.0b. If so, click [Yes], and install it.
If you install the software in a computer that is not compatible with DirectX 9.0b or 9.0c, the computer may not work properly. If you are unsure whether or not your computer is compatible, contact the maker of your computer.



3 Click [Next].



4 Select [NTSC (North America)] for the TV system, click [Next].



5 Click [Next].

Continue to follow the on-screen messages to install it.



6 Click [Finish].

The computer must be rebooted for the application to work.



Reading the operating instructions of the software applications

For details on how to use the software applications, read the PDF instructions.

- You will need Adobe Acrobat Reader 5.0 or later to read the PDF operating instructions. (→ 113)

■ DVD-RAM Driver

Select [start] → [All Programs (Programs)] → [DVD-RAM] → [DVD-RAM Driver] → [Using DVD-RAM disc].



■ DVD-MovieAlbumSE

Select [start] → [All Programs (Programs)] → [Panasonic] → [DVD-MovieAlbumSE] → [Operation Manual].



■ DVDfunSTUDIO

Select [start] → [All Programs (Programs)] → [Panasonic] → [DVDfunSTUDIO] → [Operating instructions].



Software application uninstallation

Follow the steps below to uninstall any software applications that you no longer require.

- 1 Select [start] → ([Settings] →) [Control Panel] → [Add or Remove Programs (Applications)].

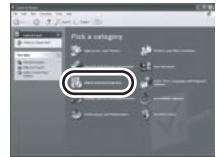

- 2 Select the software application to be deleted, then click [Change/Remove] ([Change or Remove] or [Add/Remove]).

- Proceed with the uninstallation by following the on-screen instructions.
- After uninstalling the software, be sure to reboot the computer.



Connection and recognition (Windows)

Connection and recognition procedures

After the driver and software applications are installed, the unit must be connected to the computer and be correctly recognized by the computer.

- Connect after installing the driver and software applications.
- If the supplied CD-ROM is inserted in the computer, remove it. (If the [Setup Menu] is running, wait until it finishes, then remove the CD-ROM.)
- If the recognition procedure is not accomplished properly, operation will not be possible after connecting the unit to the computer.
- If the unit fails to operate normally, it may mean that you have not conducted the installation or recognition procedure properly.
- **Be sure to finalize DVD-RW (VR format), DVD-RW (Video format) and DVD-R on this unit, before using them on the computer. Un-finalized discs will not be recognized by the computer.**



◇ Connect this unit to the AC adaptor.

1 Insert a disc or card with recorded images in the unit, turn on the unit and then select the unit's operation mode.

When using a disc: Select .

When using a card: Select .

2 (Only in card playback mode)

Press the MENU button, then select [ SETUP]
 → [ USB FUNCTION] → [PC CONNECT] and press the joystick.

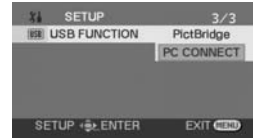

- Press the MENU button to exit the menu screen.

3 Connect this unit and a computer.

- **A** USB cable (supplied)
- Insert the plugs as far as they will go. The unit and computer will not operate properly if the plugs are not inserted fully.

This unit is automatically recognized by the computer.

- Do not use any other USB cables except the supplied one. (Operation is not guaranteed with any other USB cables.)

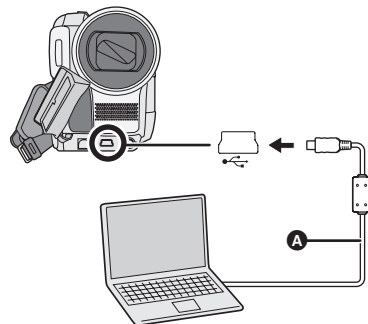

With a computer

- When the unit is connected to a computer, the operation mode cannot be changed and its power cannot be turned off.

In this case, disconnect the USB cable (→ 125).

- When the unit is connected to a computer in disc playback mode, no image will appear on the LCD monitor or viewfinder.
- When this unit is connected to a computer, you cannot use this unit's DISC EJECT lever to remove a disc. Use Windows Explorer to right-click the drive icon for this unit and select [Eject].

- When a computer is accessing a disc or card in this unit, the ACCESS/PC lamp or card access lamp lights. (When a card is being accessed,  appears on the LCD monitor.) Do not disconnect the USB cable or AC adaptor while the disc or card is being accessed as it may damage the data.
- The disc and card cannot be accessed simultaneously.
- It may be necessary to reboot the computer after connecting this unit to it for the first time.

About the computer display

When the unit is connected to a computer, it is recognized as an external drive.

- Depending on the operating environment of the computer, the shape of the drive icon and the drive name (Example: E:) will differ.

■ In disc playback mode (When accessing the disc)

Windows XP:

Optical disc drive is displayed in [My Computer].



Windows 2000:

[Removable Disk] and optical disc drive are displayed in [My Computer].

- When a DVD-RAM or DVD-RW (VR format) is inserted in this unit, it can be accessed from the removable disk drive.
- When a DVD-RW (Video format) or DVD-R is inserted in this unit, it can be accessed from the optical disc drive.



Example folder structure of a DVD-RAM or DVD-RW (VR format):

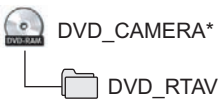

- DVD video recording format motion pictures are stored in the [DVD_RTAV] folder.

Example folder structure of a DVD-RW (Video format) or DVD-R:

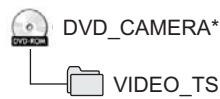

- DVD-Video format motion pictures are stored in the [VIDEO_TS] folder.

* Depending on the maker of the disc and the device used to format it, the name displayed will differ.

Do not copy, move or change the name of the folders and files recorded on this unit by Windows Explorer etc.

■ In card playback mode (When accessing the card)

[Removable Disk] is displayed in [My Computer].

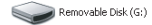

Example folder structure of an SD card:

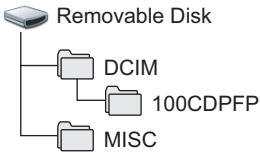

- JPEG format still pictures (IMGA0001.JPG etc.) are stored in the [100CDPFP] folder. These can be opened with picture software that supports JPEG pictures.
 - Up to 999 files can be recorded in the [100CDPFP] or other such folder.
 - The DPOF setting files are recorded in the [MISC] folder.
-
- Do not use the computer to delete the SD card's folders. Otherwise, it may no longer be possible for this unit to read the SD card.
 - Always use this unit to format SD cards.
 - When data not supported by this unit has been recorded on a computer, it will not be recognized by this unit.

To disconnect USB cable safely

1 Double click the icon in task tray.

Hardware disconnect dialog appears.

- Depending on your computer's settings, this icon may not be displayed.

2 Select [USB Mass Storage Device] and click [Stop].

3 Verify [MATSHITA DVD-RAM LMXK1931 USB Device] or [MATSHITA DVD Cam USB Device] is selected and click [OK].

Click [Close], and you can safely disconnect the cable.

- If you disconnect the USB cable while the access lamp is on or while  appears on the LCD monitor, it may damage the data.

Verifying the unit is correctly recognized by the computer

To verify the unit is correctly recognized by the computer, select the unit's mode, connect the unit to the computer via the USB cable and then follow the steps below.

- With some computers including those made by NEC, the Device Manager may not be displayed if a mode that places restrictions on the functions has been established. Consult the manufacturer or follow the steps in your computer's operating instructions to establish a mode in which all the functions can be used, then proceed with operation.

- 1 Select [start] → ([Settings] →) [Control Panel] → ([Performance and Maintenance] →) [System].

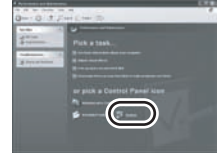

- 2 Click the [Hardware] tab, then click [Device Manager].



- 3 Verify the following items are displayed.

■ If the driver has been recognized properly

When using a disc:

Windows XP:

- [MATSHITA DVD-RAM LMXX1931 USB Device] is displayed at [DVD/CD-ROM drives].
- [USB Mass Storage Device] is displayed at [Universal Serial Bus controllers].

Windows 2000 Professional:

- [MATSHITA DVD-RAM LMXX1931 USB Device] is displayed at [DVD/CD-ROM drives].
- [MATSHITA DVD-RAM LMXX1931 USB Device] is displayed at [Disc drives].
- [USB Mass Storage Device] is displayed at [Universal Serial Bus controllers].

When using a card:

[USB Mass Storage Device] is displayed at [Universal Serial Bus controllers].

■ If the driver has not been recognized properly

[!] or [Unknown device] appears at [Universal Serial Bus controllers] or [Other devices], etc. (Where the display will appear depends on the type of computer you are using.)

You can use the following method to enable it to be recognized.

Method 1: Turn off the unit and your computer once and try again.

Method 2: Eject the disc or SD card from the unit and try again.

Method 3: Try connecting the unit to another USB port on your computer.



Creating a DVD-Video disc on a computer (Windows)

Creating a DVD-Video on a computer from a DVD-RAM or DVD-RW (VR format)

Using DVD-MovieAlbumSE and DVDfunSTUDIO, you can create a DVD-Video disc (DVD-RW/ DVD-R disc) from the images recorded on this unit.

- Before using DVD-RW (VR format) on a computer, be sure to finalize it on this unit.
- When using DVD-MovieAlbumSE or DVDfunSTUDIO, log on to your computer as Administrator with a login name equally authorized. If you log on with a login name other than Administrator, you cannot use the applications.
- The End User License Agreement is displayed when the software is first started so read carefully through its terms and conditions, then click [I agree.].

◇ Connect this unit to the AC adaptor.

1 Insert a DVD-RAM or DVD-RW (VR format) with recorded images in the unit, turn on the unit and then rotate the mode dial to select .

2 Connect this unit and a computer.

- Ⓐ USB cable (supplied)
 - Insert the plugs as far as they go. The unit and computer will not operate properly if the plugs are not inserted fully.
- Do not use any other USB cables except the supplied one. (Operation is not guaranteed with any other USB cables.)

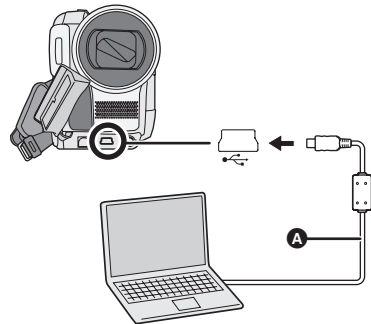

With a computer

Creating a DVD-Video disc on a computer (Windows)

3 (On the computer)

Select **[start]** → **[All Programs (Programs)]** → **[Panasonic]** → **[DVD-MovieAlbumSE]** → **[DVD-MovieAlbumSE]**.



DVD-MovieAlbumSE starts and the images recorded on the disc are displayed.

When starting DVD-MovieAlbumSE, the [Mount Information] dialog box may appear or the recorded images may not be shown. If this occurs, try the following procedure. If there are multiple drives, a drive other than this unit may be selected.

- 1) Click [Preference] on the dialog box or  ([Preference]) button at top right of DVD-MovieAlbumSE screen, and then click the [Device setting] tab.
- 2) Choose the drive where the disc is loaded in the [Drive Select] column, and then click [OK].

4 (When using a DVD-RAM only)

Edit the images on the disc as required.

5 Click  ([Additional]) and select **[File Export]** → **[Export all titles]** or **[Export a title]**.



6 **Set the export settings in the [Export all titles] ([Export a title]) screen and click [Start].**

- It is recommended that you do not change the settings displayed on the screen.



7 **When export is complete, a message will appear. Check the small box for [Eject the disc being used.], and then click [Yes].**

DVD-MovieAlbumSE automatically closes and DVDfunSTUDIO automatically starts.

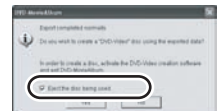

8 **Insert a brand-new DVD-RW or DVD-R disc into the unit.**



9 When the [CollectTool] screen appears, click [OK].

The exported scene will be automatically registered on the DVDfunSTUDIO editing screen.



10 Edit the DVD menu as required.

- Set the disc size to [8 cm DVD].

11 Click [Burning].

Writing to DVD-RW/DVD-R disc will start.

When writing is complete, the disc is ejected automatically.



- The DISC EJECT lever on this unit does not work when the unit is connected to a computer. Use the software's eject button to eject the disc. (When not using the software, use Windows Explorer to right-click the drive icon for this unit and select [Eject].)
- Title names set using DVD-MovieAlbumSE cannot be displayed on this unit. Also, the names of playlists created on this unit cannot be displayed on DVD-MovieAlbumSE.
- If you export an image recorded in 16:9 aspect ratio with DVD-MovieAlbumSE, it is saved as a 4:3 aspect image that has been squeezed horizontally. If you then use the exported image with DVDfunSTUDIO, it is displayed as a 16:9 aspect image.
- The DVD menu created with DVDfunSTUDIO does not appear on this unit. Play back the disc on a DVD player.
- You cannot add data to a disc written to with DVDfunSTUDIO as the disc is finalized after writing.

Take care that the temperature of the unit, when connected to a computer, does not rise excessively [reference for usage: approx. 30 minutes at about 30 °C (86 °F)].

Before using with a computer (Macintosh)

What you can do with a computer

■ When using a disc recorded on this unit

Before using DVD-RW (VR format), DVD-RW (Video format) and DVD-R on the computer, finalize them on this unit.

Can do	Software used
Playing back on a computer	DVD-RAM or DVD-RW (VR format): Playback is not possible DVD-RW (Video format) or DVD-R: Standard OS or commercially available DVD-Video playback software
Saving motion pictures on a computer	Pixe VRF Browser EX (supplied)
Editing motion pictures	Pixe VRF Browser EX (supplied) ● You can save the edited data to your computer and then write it to disc with ImageMixer VCD/DVD2.
Creating a DVD-Video disc	Pixe VRF Browser EX (supplied) and ImageMixer VCD/DVD2 (supplied)

■ When using an SD card recorded on this unit

Can do	Software used
Playing back on a computer	Standard OS picture viewer or a commercially available picture viewer
Copying files to a computer	Drag and drop to the Finder

Contents on provided CD-ROM

The following software applications are contained on the provided CD-ROM.

■ Pixe VRF Browser EX

This software is for importing motion pictures recorded on disc to a computer. The motion pictures imported to the computer can be edited with [MPEG Editor]. The motion pictures saved on the computer with this software become the contents of the DVD-Video or Video CD disc created with ImageMixer VCD/DVD2.

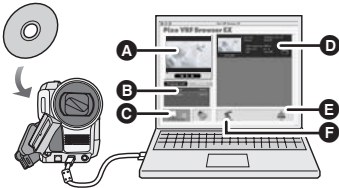

- A** Preview window
- B** Program List/Playlist/Title List window
- C** Drive select button
- D** Video List window

The contents of the program etc. selected in **B** are shown.

- E** [Save] button
- F** [MPEG Editor] button

Before using with a computer (Macintosh)

■ ImageMixer VCD/DVD2

This software is for creating DVD-Video and Video CD discs.

Use this software when burning a DVD-Video or Video CD disc from motion pictures saved using Pixe VRF Browser EX. For details, refer to page 137.

- To create a DVD-Video disc, a separate DVD-RW/DVD-R/+RW/+R drive is required.
To create a Video CD disc, a separate CD-RW/CD-R drive is required.

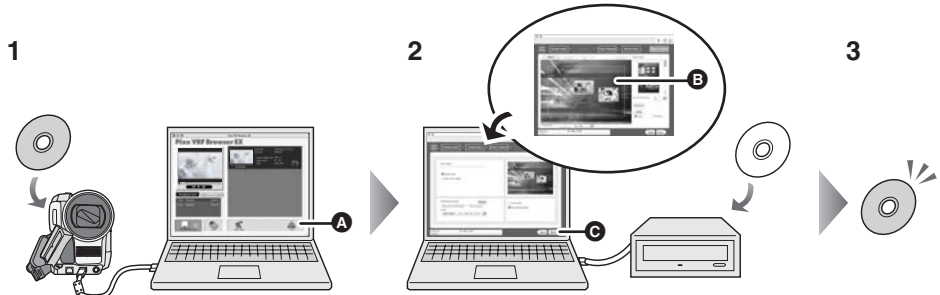

1 Save the motion pictures from the disc to the computer with Pixe VRF Browser EX.

- A** [Save] button

2 Create a DVD or Video CD menu with ImageMixer VCD/DVD2 and then write the data to a new disc.

- B** DVD or Video CD menus created
Arrange the motion pictures saved on the computer with Pixe VRF Browser EX and edit the menu design.
- C** Write button
The contents start being written to disc.

3 A DVD-Video or Video CD disc is created.

- Playback is possible on a DVD player.

Operating environment

- A CD-ROM drive is necessary to install the supplied software.
- Even if the system requirements mentioned in these operating instructions are fulfilled, some computers cannot be used.
- Use the supplied USB cable when connecting to the computer. (Operation is not guaranteed with any other USB cables.)

■ Pixe VRF Browser EX

OS	Mac OS X v10.2.8, v10.3.4 to v10.3.9, v10.4.1 to v10.4.2 <ul style="list-style-type: none"> • Mac OS X Server is not supported.
CPU	iMac G4, iMac G5, iBook G4, PowerBook G4, Power Mac G5, eMac, Mac mini Series with USB 2.0 port as a standard equipment PowerPC G4 or above
Memory	256 MB or more (512 MB or more recommended)
Graphics	Minimum of 1024×768 pixels, 32,000 colors (Full color recommended) <ul style="list-style-type: none"> • Will not run correctly with a screen smaller than 1024×768, or with less than 256 colors.
Other requirements	DVD Video Recording format: DVD-RAM and DVD-RW discs DVD-Video format: DVD-RW and DVD-R discs

■ Pixe VRF Browser EX specifications

Compatible formats	DVD Video Recording format (DVD-RAM/DVD-RW) DVD-Video format (DVD-RW/DVD-R)	
Save formats	MPEG2 motion pictures	Program stream
		Elementary stream
	Still pictures	PICT format
Reading method	Direct reading from DVD media	
	Folder reading	

Before using with a computer (Macintosh)

■ ImageMixer VCD/DVD2

OS	Mac OS X v10.2.8, v10.3.4 to v10.3.9, v10.4.1 to v10.4.2 ● Mac OS X Server is not supported.
CPU	iMac G4, iMac G5, iBook G4, PowerBook G4, Power Mac G5, eMac, Mac mini Series with USB 2.0 port as a standard equipment PowerPC G4 or above
Memory	256 MB or more (512 MB or more recommended)
Hard disk	Disk space required for installation: approx. 200 MB ● 1 GB or more space in Startup Disk is required when operating application. ● When creating a disc or disc image, you will need three times as much space as the size of the disc itself.
Graphics	Minimum of 1024×768, 32,000 colors (Full color recommended) ● Will not run correctly with a screen smaller than 1024×768, or with less than 256 colors.
Other	Pre-installed QuickTime 6 or later

- To compile a disc, a separate recording drive is required.

■ Using Built-in SD Drive

OS	Mac OS X v10.1 to v10.4
CPU	PowerPC G3 (400 MHz or higher), G4, G5
RAM	64 MB or more

- The USB equipment operates with the driver installed as standard in OS.

For technical inquiries about these software applications, contact the PIXELA Customer Support Center in your region.
U.S. and Canada (Toll-Free) +1-800-458-4029
Website: <http://www.pixela.co.jp/oem/panasonic/e/index.html> (This website is in English only.)

Installation (Macintosh)

- Before starting the installation, close any other software applications which are running.
- Do not perform any other operations on your computer while the software is being installed.

1 Insert the CD-ROM into the computer.

[PANASONIC] CD-ROM icon appears.

2 Double-click [PANASONIC] → [Imx for Panasonic] → [ImageMixer.pkg].

The installer setup screen appears.

3 Click [Continue].

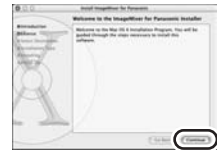

4 Read carefully through the terms and conditions shown on the screen for the [Software License Agreement], click [Continue] and then click [Agree].

- You cannot install the application if you click [Disagree].



5 Click [Continue].

Continue to follow the on-screen messages to install it.



6 Click [Close].



Reading the operating instructions of the software applications

For details on how to use the software applications, read the help.

■ Pixe VRF Browser EX

After starting Pixe VRF Browser EX, select [Help] → [Pixe VRF Browser EX Help] from the Menu Bar.

■ ImageMixer VCD/DVD2

After starting ImageMixer VCD/DVD2, click the [?] icon at top right of ImageMixer VCD/DVD2 screen.

Software application uninstallation

Follow the steps below to uninstall any software applications that you no longer require.

Drag the folder in which the software is installed into the Trash and then empty the Trash.

- After uninstalling the software, be sure to reboot the computer.

Using discs on a computer (Macintosh)

Creating a DVD-Video on a computer from a recorded disc

Using Pixe VRF Browser EX and ImageMixer VCD/DVD2, you can create a DVD-Video disc (DVD-RW/DVD-R disc) from the images recorded on this unit.

- Before using DVD-RW (VR format), DVD-RW (Video format) or DVD-R on a computer, finalize them on this unit.
- To create a DVD-Video disc, a separate DVD-RW/DVD-R/+RW/+R drive is required.
- Before initial use, select the software's [ReadMe] in the folder in which the software is installed and then read through the additional instructions or updated information.

◇ Connect this unit to the AC adaptor.

1 Remove the disc from the unit, turn on the unit and then rotate the mode dial to select .

2 Connect this unit and a computer.

- A** USB cable (supplied)
 - Insert the plugs as far as they will go. The unit and computer will not operate properly if the plugs are not inserted fully.
- Do not use any other USB cables except the supplied one. (Operation is not guaranteed with any other USB cables.)

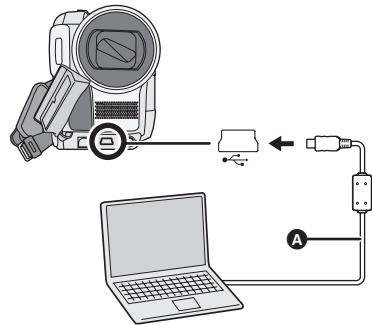

3 (On the computer)

Double-click the [Pixe VRF Browser EX for Panasonic] icon in the [ImageMixer for Panasonic] folder you installed.

Pixe VRF Browser EX starts.

4 Click the drive button, select [MATSHITA DVD-RAM LMXK1931] from the pop-up menu and then click [OK].

The cover of the disc compartment on this unit opens.



Using discs on a computer (Macintosh)

5 Insert the disc in this unit.

The contents recorded on the disc are displayed.

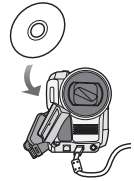

6 Click the desired program (A), select the scene to be added to the DVD-Video (B) and then click the [Save] button (C).

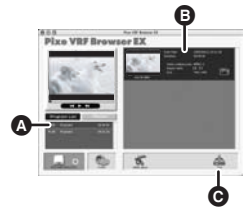

7 Select the destination folder to save, select [Default] in [Format] and then click the [Save] button.

- When saving is complete, select [Pixe VRF Browser EX] → [Quit Pixe VRF Browser EX] from the Menu Bar to exit Pixe VRF Browser EX.
- The disc cover on this unit opens. You can remove the disc and disconnect the USB cable.



8 Prepare a DVD-RW/DVD-R/+RW/+R drive that can be written to.

- Check that a disc is not inserted in the drive.

9 Double-click the [ImageMixerVCD/DVD2] icon in the [ImageMixer for Panasonic] folder you installed.

ImageMixer VCD/DVD2 starts.

10 Click the [DVD-Video] button.



11 Use [Select folder] to select the folder containing the MPEG files saved with Pixe VRF Browser EX and then click the [Add] button.

- Repeat this to add multiple folders.



12 Click [Create Menu] (A) and edit the DVD menu as required, then click [Write to Disc] (B).

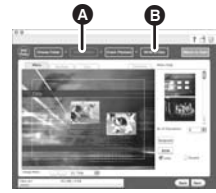

13 Check [Create disc] (A), select the drive to be used (B) and then click [Write] (C).



14 Insert a brand-new 12 cm (5") DVD-RW or DVD-R disc into the disc drive and click [OK].

- 12 cm (5") +RW and +R discs can also be used if the disc drive supports them.



15 Proceed with the write setting and then click [OK].

Writing to the disc starts.

- Depending on the amount of data, writing to the disc may take time.

- When the unit is connected to a computer, the operation mode cannot be changed and its power cannot be turned off.

In this case, disconnect the USB cable (→ below).

- When the unit is connected to a computer in disc playback mode, no image will appear on the LCD monitor or viewfinder.
- When this unit is connected to a computer, you cannot use this unit's DISC EJECT lever to remove a disc. Use the software's eject button to eject the disc.

- When a computer is accessing a disc in this unit, the ACCESS/PC lamp lights. Do not disconnect the USB cable or AC adaptor while the disc is being accessed as it may damage the data.

To disconnect USB cable safely

When the drive icon is displayed on the desktop:

Drag the icon into the Trash and then disconnect the USB cable.

When the drive icon is not displayed on the desktop:



Exit the application and then disconnect the USB cable.

- If you disconnect the USB cable while the access lamp is on, it may damage the data.

Using an SD card on a computer (Macintosh)

Connection

- ◇ Connect this unit to the AC adaptor.
- ◇ Insert an SD card with recorded images in the unit, turn on the unit and then rotate the mode dial to select .

- 1 Press the MENU button, then select [ SETUP]
→ [ USB FUNCTION] → [PC CONNECT] and press the joystick.

- Press the MENU button to exit the menu screen.

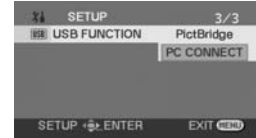

2 Connect this unit and a computer.

- Ⓐ USB cable (supplied)
- Insert the plugs as far as they will go. The unit and computer will not operate properly if the plugs are not inserted fully.



icon appears.

- Do not use any other USB cables except the supplied one. (Operation is not guaranteed with any other USB cables.)

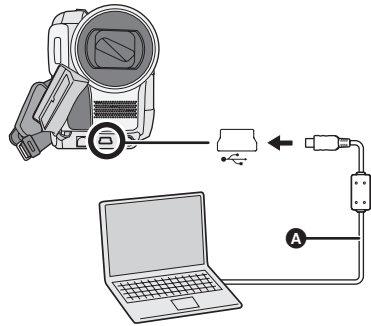

- **When the unit is connected to a computer, the operation mode cannot be changed and its power cannot be turned off.**

In this case, disconnect the USB cable (→ 141).

- When a computer is accessing a card in this unit, the card access lamp lights. ( appears on the LCD monitor.) Do not disconnect the USB cable or AC adaptor while the card is being accessed as it may damage the data.

Copying still picture files to a computer

1 Double-click the [NO_NAME] icon.

The folders on the SD card are displayed.

2 Select the file in the [100CDPFP] folder to copy and drag and drop it to the destination copy folder.

■ Example folder structure of an SD card:

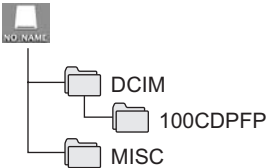

- JPEG format still pictures (IMGA0001.JPG etc.) are stored in the [100CDPFP] folder. These can be opened with picture software that supports JPEG pictures.
 - Up to 999 files can be recorded in the [100CDPFP] or other such folder.
 - The DPOF setting files are recorded in the [MISC] folder.
-
- Do not use the computer to delete the SD card's folders. Otherwise, it may no longer be possible for this unit to read the SD card.
 - Always use this unit to format SD cards.
 - When data not supported by this unit has been recorded on a computer, it will not be recognized by this unit.

To disconnect USB cable safely

Drag the [NO_NAME] icon into the Trash and then disconnect the USB cable.

- If you disconnect the USB cable while the access lamp is on or while  appears on the LCD monitor, it may damage the data.





Menu

Menu list

Motion picture recording menus

BASIC	
SCN SCENE MODE	OFF
WIND CUT	ON
REC MODE	SP
ASPECT	16:9
CLOCK SET	NO
SETUP +ENTER EXIT MENU	











■ [] BASIC

- [SCN SCENE MODE] (→ 70)
- [] WIND CUT] (→ 65)
- [] REC MODE] (→ 51)
- [] ASPECT] (→ 66)
- [] CLOCK SET] (→ 45)

■ [] ADVANCED

- [] D.ZOOM] (→ 56)
- [] O.I.S.] (VDR-D300) (→ 67)
- [] E.I.S.] (VDR-D250) (→ 67)
- [] FADE COLOR] (→ 60)
- [] REC LAMP] (→ 144)
- [] ZOOM MIC] (→ 57)

■ [] SETUP



- [] DISPLAY] (→ 144)
- [] DATE/TIME] (→ 46)
- [] DATE FORMAT] (→ 46)
- [] POWER SAVE] (→ 144)
- [] AGS]* (→ 49)
- [] BEEP SOUND] (→ 144)
- [] LCD SET] (→ 47)
- [] EVF SET] (→ 47)
- [] INITIAL SET] (→ 144)
- [] JOYSTICK LED] (→ 144)
- [] DEMO MODE] (→ 144)

■ [] LANGUAGE] (→ 41)







Still picture recording menus

BASIC	
SCN SCENE MODE	OFF
PICTURE SIZE	[2:1]
PICT. QUALITY	
CLOCK SET	NO
SETUP +ENTER EXIT MENU	











■ [] BASIC

- [SCN SCENE MODE] (→ 70)
- [] PICTURE SIZE] (→ 54)
- [] PICT. QUALITY] (→ 55)
- [] CLOCK SET] (→ 45)

■ [] ADVANCED

- [] FLASH]* (→ 68)
- [] RED EYE]* (→ 69)
- [] FLASH LEVEL]* (→ 69)
- [] O.I.S.]* (→ 67)
- [] REC LAMP] (→ 144)
- [] SHTR EFFECT] (→ 55)

■ [] SETUP

- [] DISPLAY] (→ 144)
- [] DATE/TIME] (→ 46)
- [] DATE FORMAT] (→ 46)
- [] POWER SAVE] (→ 144)
- [] BEEP SOUND] (→ 144)
- [] LCD SET] (→ 47)
- [] EVF SET] (→ 47)
- [] INITIAL SET] (→ 144)
- [] JOYSTICK LED] (→ 144)
- [] DEMO MODE] (→ 144)

■ [] LANGUAGE] (→ 41)

* VDR-D300 only

▶ Motion picture playback menus

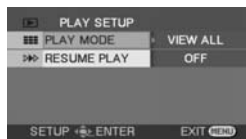

■ [🗑️] DELETE]

(Only when [PLAY MODE] is set to [VIEW ALL] or [BY DATE])

[🗑️] SELECT] (→ 81)

[🗑️] ALL] (→ 81)

■ [▶] PLAY SETUP]

[≡] PLAY MODE] (→ 78, 86, 87)

[▶▶] RESUME PLAY] (→ 78)

■ [✂️] EDIT SCENE]

(Only when [PLAY MODE] is set to [VIEW ALL] or [BY DATE])

[⏸️] DIVIDE] (→ 83)

[⏸️] COMBINE] (→ 84)

■ [✂️] EDIT]

(Only when [PLAY MODE] is set to [PLAYLIST])

[➕] ADD] (→ 88)

[⇄] MOVE] (→ 89)

[⏸️] DIVIDE] (→ 90)

[⏸️] COMBINE] (→ 91)

[🗑️] DELETE] (→ 92)

■ [🔧] SETUP]

[🗑️] FORMAT DISC] (→ 98)

[🗑️] FINALIZE] (→ 100)

[🗑️] UN-FINALIZE] (→ 101)

[🗑️] DISC PROTECT] (→ 102)

[🗑️] INFORMATION] (→ 103)

[+] DISPLAY] (→ 144)

[DATE] DATE] (→ 46)

[DATE] DATE FORMAT] (→ 46)

[⏸️] POWER SAVE] (→ 144)

[🔊] BEEP SOUND] (→ 144)

[LCD] LCD SET] (→ 47)

[EVF] EVF SET] (→ 47)

[TV] TV ASPECT] (→ 105)

[🕒] JOYSTICK LED] (→ 144)

■ [🗑️] LANGUAGE] (→ 41)

▶ Still picture playback menus



■ [🗑️] DELETE]

[🗑️] SELECT] (→ 94)

[🗑️] ALL] (→ 94)

■ [▶] PLAY SETUP]

[≡] PLAY MODE] (→ 80)

[🔒] LOCK] (→ 96)

[DPOF] DPOF SET] (→ 97)

■ [🔧] SETUP]

[+] DISPLAY] (→ 144)

[DATE] DATE/TIME] (→ 46)

[DATE] DATE FORMAT] (→ 46)

[🗑️] FORMAT CARD] (→ 99)

[⏸️] POWER SAVE] (→ 144)

[🔊] BEEP SOUND] (→ 144)

[LCD] LCD SET] (→ 47)

[EVF] EVF SET] (→ 47)

[TV] TV ASPECT] (→ 105)

[🕒] JOYSTICK LED] (→ 144)

[USB] USB FUNCTION] (→ 109, 123, 140)

■ [🗑️] LANGUAGE] (→ 41)

Other menus

■ [REC LAMP]

- OFF ● ON

The recording lamp lights during recording and flashes when the unit receives a signal from the remote control. When this is set to [OFF], it does not light during recording.

■ [DISPLAY]

- OFF ● ON

The screen indications are selected as shown in the illustration below.

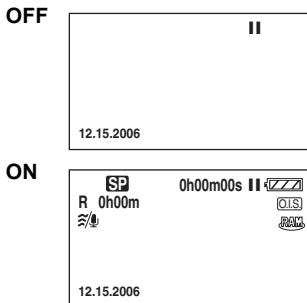

■ [POWER SAVE]

- OFF ● 5 MINUTES

[OFF]: The power saving function is not activated.

[5 MINUTES]:

When about 5 minutes passed without any operation, this unit automatically turns off to prevent the battery from running down. When you use this unit, turn it on again.

- In the following cases, the unit may not turn off even when you set this to [5 MINUTES].
 - When using the AC adaptor
 - When connecting the unit to a computer or printer via the USB cable

■ [BEEP SOUND]

- OFF ● ON

This allows operations such as starting and ending recording to be signaled by a beep. When [OFF] is set, no beep is heard when an operation such as recording is started or ended.

1 Beep

When you start recording

When you turn on the power

When this unit is recognized by the computer or the printer, etc.

2 Beeps

When you pause recording

When you turn off the power

2 Beeps for 4 times

When an error occurs e.g. recording not starting. Check the sentence displayed on the screen. (→ 147)

■ [INITIAL SET]

- YES ● NO

When there is a menu that cannot be selected depending on a combination of functions, set to [YES] for changing the menu settings back to the initial shipping condition.

(Language setting cannot be back to the initial shipping condition.)

■ [JOYSTICK LED]

- OFF ● ON

If set to [ON], the circumference of the joystick lights up in blue during operation.

■ [DEMO MODE]

- OFF ● ON

This item is used to start the unit demonstration.

(Only when using the AC adaptor and the mode dial is at the  or  position)

If you set this to [ON] without inserting a disc or an SD card, this unit is automatically set to the demonstration mode for introducing its functions. If any button is pressed or operated, the demonstration mode is canceled. If no operations take place for approx. 10 minutes, the demonstration mode automatically starts. To terminate the demonstration mode, insert a disc or an SD card, or set this to [OFF]. For normal use, set this function to [OFF].

Indications

Indications

■ Recording indications

① Motion picture recording

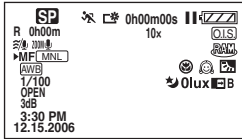

② Still picture recording

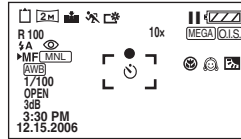

	Remaining battery power
R 0h00m	Remaining time for recording
0h00m00s	Elapsed recording time
3:30 PM 12.15.2006	Date/time indication
●/ (Red)	Recording/writing to a disc
 (Green)	Recording pause
WIDE	Wide mode
AUTO	Auto mode
MNL	Manual mode
MF	Manual focus
2X	Zoom magnification indication
	Back light mode
OIS (VDR-D300) EIS (VDR-D250)	Image stabilizer
	Power LCD
1/100	Shutter speed
OPEN, F2.0	F number
0dB	Gain value
	Soft skin mode
	Tele macro
EW, EB	Fade (White), Fade (Black)
	MagicPix function
	0 Lux MagicPix function
ZOOM	Zoom microphone
	Wind noise reduction
XP, SP, LP	Motion picture recording mode
	Sports mode
	Portrait mode
	Low light mode
	Spotlight mode
	Surf & snow mode

AWB 	Auto white balance Indoor mode (recording under incandescent lamp)
	Outdoor mode
	Manual adjustment mode
RAM VR -RW Video -RW -RW -R	Disc type DVD-RAM DVD-RW (VR format) DVD-RW (Video format) DVD-RW (unformatted) DVD-R
 	Flash (VDR-D300 only)
	Red eye reduction (VDR-D300 only)
○ (White) ● (Green)	Shutter chance mark
	Self-Timer recording
MEGA	MEGA OIS (VDR-D300 only)
 	Number of recording pixels for still pictures VDR-D300 2048×1512 1920×1080 VDR-D250 1760×1320 1760×992 VDR-D300/VDR-D250 1280×960 640×480
□ (White) □ (Green) □ (Red)	Card can be recorded to Recognizing the card Recording/accessing the card
	Still picture quality
R 100	Remaining number of still pictures

Indications

■ Playback indications

① Motion picture playback

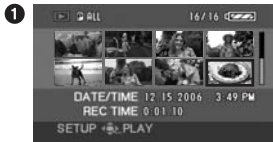

② Still picture playback

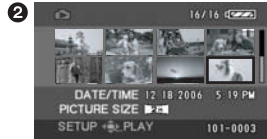

	Playback
	Pause
	Cue/Review playback
	Last/first scene paused
	Skip playback
	Slow motion playback
	Frame-by-frame playback
0h00m00s	Motion picture playback time
	Play mode All scenes on the disc displayed Scenes recorded on the selected date displayed Scenes in the selected playlist displayed
No.10	Scene number
	Volume adjustment
R	Resume playback
	Contents that have been protected on another device.
	Slide show playback
100-0001	Still picture folder/file number display
	When a printer compatible with PictBridge is connected
	Accessing the card (When connected to a computer)
	DPOF already set (to more than 1)
	Locked still pictures

	Number of recording pixels for still pictures
	VDR-D300 2048×1512
	1920×1080
	VDR-D250 1760×1320
	1760×992
	VDR-D300/VDR-D250 1280×960
	640×480

The picture size is not displayed for still pictures recorded with other products that have different picture sizes from the sizes shown above.

■ Confirmatory indications

	-- (Time display) The built-in battery is low. (→ 46)
	The warning/alarm indication appears when LCD monitor is rotated towards the lens side. Return the direction of the LCD monitor to normal position and check the warning/alarm indication.
	NO DISC No disc is inserted.
	Unusable disc
	No SD card is inserted/unusable card.

Messages

CANNOT RECORD.	Data writing to the disc or card has failed.
NO DATA.	There are no images recorded on the disc or card.
THIS DISC IS INCOMPATIBLE.	You inserted an incompatible disc (copy-protected discs, etc.).
PLEASE CHECK THE DISC.	You inserted a disc that cannot be read on this unit (a disc recorded in PAL video format etc.).
RECOMMENDED TO USE PANASONIC DISC	You inserted a disc that does not meet the DVD standard for quality and performance so you may not be able to record normally. Refer to the following support site for information about discs that have been confirmed as compatible by Panasonic. http://panasonic.co.jp/pavc/global/cs/e_cam (This website is in English only.)
AGS MODE ON -REC PAUSED	The AGS function is activated. (→ 49)
CANNOT RECORD. (THIS DISC IS FINALIZED)	A finalized DVD-RW (Video format) or DVD-R has been inserted. After finalizing, the discs become play-only and cannot record. If you un-finalize a DVD-RW (Video format), it can be used for recording. (→ 101)
CANNOT RECORD. DISC IS FULL.	The disc is full or the number of scenes has reached the maximum limit so no further data can be recorded. Delete unnecessary scenes (→ 81) or insert a new disc.
CANNOT RECORD. THE NUMBER OF SCENES HAS EXCEEDED THE MAXIMUM LIMIT.	
CANNOT OPERATE. TEMPERATURE IS HIGH. PLEASE TURN OFF AND WAIT A WHILE.	The temperature of the unit is high so it cannot be operated. Turn off the power, wait until the unit cools and then turn on the power again.
CANNOT UN-FINALIZE THIS DISC.	DVD-R cannot be un-finalized. DVD-RW (VR format) cannot be un-finalized. DVD-RW (VR format) after finalization can be recorded and edited in the same way as DVD-RW (VR format) before finalization.
CHECK CARD.	This card is not compatible or it cannot be recognized by the unit.
CARD LOCKED.	The write protection switch on the SD Memory Card is set to LOCK. (→ 26)

CARD FULL.	The SD card is full so no further data can be recorded. Delete unnecessary files (→ 94) or insert a new SD card.
PUSH THE RESET SWITCH.	An irregularity in the unit has been detected. Press the RESET button to restart the unit. (→ 155)
CHANGE TO MANUAL MODE.	You are attempting to use a function that cannot be used simultaneously.
CANCEL MAGICPIX MODE.	
TURN OFF POWER LCD.	
CANNOT SET.	With DVD-RW (Video format) and DVD-R, if the number of dates displayed becomes 99 when [PLAY MODE] is set to [BY DATE], you cannot change the aspect setting from 16:9 to 4:3 and vice versa.
CHANGE MODE TO USE USB.	The USB cable is connected in the recording mode.
DISCONNECT USB CABLE.	You are attempting to turn the mode dial with the USB cable connected to the unit.
	The unit's power cannot be turned off when the unit is connected to the computer.
	The unit cannot correctly establish the connection to the computer or printer. Disconnect and then reconnect the USB cable or check the [USB FUNCTION] setting on this unit.

About recovery

It is possible that the system cannot complete writing of a file normally when, for example, power is turned off for some reason during recording or editing.

If faulty management information is found when a disc is accessed, the following message may appear. Be sure to follow the messages. (Repairing may take time depending on the error.)

DISC ERROR HAS OCCURRED. REPAIR DISC NOW?

- When you repair the disc, use a battery with sufficient battery power or the AC adaptor.
- Depending on the condition of the data, it may not be possible to completely repair the data.
- If the disc is removed without it being repaired, you will no longer be able to playback the scenes recorded before the power went off.
- Do not repair a disc that has been recorded on another device. This may cause the loss of data or the disc.

Functions that cannot be used simultaneously

Some functions in this unit are disabled or cannot be selected due to the unit's specifications. The table below shows examples of functions restricted by various conditions.

Functions	Conditions which disable the functions
Digital zoom	<ul style="list-style-type: none"> • In card recording mode
Fade	
MagicPix	<ul style="list-style-type: none"> • While recording to a disc (Cannot set or cancel) • In card recording mode
Backlight compensation	<ul style="list-style-type: none"> • When the MagicPix function is used (Cannot set or cancel) • When the iris/gain is set
Soft skin mode (Set and cancel)	<ul style="list-style-type: none"> • While recording to a disc
Tele macro (Set and cancel)	
Help mode	
Image stabilizer	<ul style="list-style-type: none"> • When the MagicPix function is used (VDR-D250 only) • In card recording mode (VDR-D250 only)
Flash (VDR-D300 only)	<ul style="list-style-type: none"> • In disc recording mode
Zoom microphone	<ul style="list-style-type: none"> • An external microphone is used
Wind noise reduction	

Functions	Conditions which disable the functions
Scene mode	<ul style="list-style-type: none"> • When setting the AUTO/MANUAL/ FOCUS switch to AUTO • When the MagicPix function is used
Change of white balance	<ul style="list-style-type: none"> • When digital zoom (10× or higher) is used • When the MagicPix function is used
Adjusting the shutter speed, iris/gain	<ul style="list-style-type: none"> • When the MagicPix function is used • When the scene mode is used

Frequently asked questions



What kind of discs can be used?	DVD-RAM, DVD-RW and DVD-R can be used if they are 8 cm (3") bare discs. (→ 23)
Can discs with a cartridge be used?	They can be used if the cartridge is removed.
Can double sided discs be used?	They can be used. However you cannot record or play continuously from one side of the disc to the other. You will need to eject the disc and turn it over.
Can I record continuously from one side of the disc to the other on a double sided disc?	You cannot record continuously from one side of the disc to the other. The recording time indicated on the disc package is the total time for both sides. You will need to eject the disc and turn it over to record on both sides.
Can DVD-R only be recorded to once only?	Recording can be started and stopped until the disc is full. However the data recorded on the DVD-R cannot be erased.
Is playback possible on a DVD player?	By finalizing a DVD-RW (Video format) or a DVD-R in this unit, it can be played back on a DVD player. DVD-RAM or DVD-RW (VR format) can be played back on a DVD recorder, DVD player etc. that supports DVD-RAM or DVD-RW (VR format). Refer to the operating instructions of the DVD recorder or DVD player. ● DVD-RW (VR format) may have to be finalized. In this case, finalize the disc on this unit.
Can software other than that supplied be used?	For information about software from other companies, contact the makers of the software.
Is playback possible on a computer (Windows)?	DVD-RAM, DVD-RW (VR format): Use the supplied software DVD-MovieAlbumSE. ● Before using DVD-RW (VR format) on a computer, be sure to finalize it on this unit. DVD-RW (Video format), DVD-R: Finalize the disc on this unit and then play it back with commercially available DVD-Video playback software. SD card: Use picture viewer software.
Is editing possible on a computer (Windows)?	DVD-RAM: Use the supplied software DVD-MovieAlbumSE. DVD-RW (VR format), DVD-RW (Video format), DVD-R: Editing is not possible on a computer.

<p>Is it possible to copy data to a computer (Windows)?</p>	<p>DVD-RAM, DVD-RW (VR format): Use DVD-MovieAlbum CopyTool or the File Export function in DVD-MovieAlbumSE. <ul style="list-style-type: none"> • Before using DVD-RW (VR format) on a computer, be sure to finalize it on this unit. DVD-RW (Video format), DVD-R: Copying data to a computer is not possible. SD card: Copy with Windows Explorer.</p>
<p>What should I do when the disc contents cannot be displayed with DVD-MovieAlbumSE?</p>	<p>If there are multiple drives, a drive other than this unit may be selected. Click the [Preference] button at top right of DVD-MovieAlbumSE screen, click the [Device setting] tab to choose the drive where the disc is loaded in the [Drive Select] column, and then click [OK].</p>
<p>Is playback possible on a computer (Macintosh)?</p>	<p>DVD-RAM, DVD-RW (VR format): Playback is not possible on a computer. DVD-RW (Video format), DVD-R: Finalize the disc on this unit and then play it back on a standard OS or commercially available DVD-Video playback software. SD card: Use picture viewer software.</p>
<p>Is editing possible on a computer (Macintosh)?</p>	<p>Use [MPEG Editor] in Pixe VRF Browser EX. You can save the edited data to your computer and then write it to disc with ImageMixer VCD/DVD2. <ul style="list-style-type: none"> • Before using DVD-RW (VR format), DVD-RW (Video format) or DVD-R on a computer, finalize them on this unit. </p>
<p>Is it possible to save data to a computer (Macintosh)?</p>	<p>Discs: Use Pixe VRF Browser EX. <ul style="list-style-type: none"> • Before using DVD-RW (VR format), DVD-RW (Video format) or DVD-R on a computer, finalize them on this unit. SD card: Copy with the Finder.</p>
<p>DVD-RAM or DVD-RW (VR format) icon is not displayed on the desktop (Macintosh).</p>	<p>What version of Mac OS X are you using? If it is V10.3.x or earlier, the icon is not displayed even if the disc is recognized by the computer. Use Disk Utility or Apple System Profiler to verify if the disc is recognized by the computer.</p>
<p>When Pixe VRF Browser EX is started, a message is displayed about ejecting the disc.</p>	<p>Is there a disc in this unit when Pixe VRF Browser EX is started? Insert the disc after starting Pixe VRF Browser EX.</p>
<p>Which format should be selected when saving motion pictures with Pixe VRF Browser EX?</p>	<p>To use the saved file with ImageMixer VCD/DVD2, select [Default] (Program Stream).</p>

Troubleshooting

Unit operations

Problem	Check points
<p>This unit cannot be turned on.</p>	<ul style="list-style-type: none"> ● Is the battery fully charged? → Charge the battery using the AC adaptor. (→ 28) ● The battery protection circuit may have operated. Attach the battery to the AC adaptor for 5 to 10 seconds. If the unit still cannot be used, the battery is faulty. ● Is the LCD monitor opened or the viewfinder extended?
<p>This unit is turned off automatically.</p>	<ul style="list-style-type: none"> ● If you do not use the unit for approximately 5 minutes, the power is automatically turned off to conserve the battery charge. To resume recording, turn the power back on. The power will not turn off automatically when the power save function (→ 144) is set to [OFF].
<p>This unit does not stay on long enough.</p>	<ul style="list-style-type: none"> ● Is the battery low? → If the remaining battery power indication is flashing or the message "LOW BATTERY." is displayed, the battery has run down. Charge the battery. (→ 28)
<p>Battery runs down quickly.</p>	<ul style="list-style-type: none"> ● Is the battery fully charged? → Charge it with the AC adaptor. (→ 28) ● Are you using the battery in an extremely cold place? → The battery is affected by ambient temperature. In cold places, the operating time of the battery becomes shorter. ● Has the battery worn out? → The battery has a limited life. If the operating time is still too short even after the battery is fully charged, the battery has worn out and can no longer be used.
<p>This unit cannot be operated though powered up.</p> <p>This unit does not operate normally.</p>	<ul style="list-style-type: none"> ● The unit cannot be operated unless you open the LCD monitor or extend the viewfinder. ● Press the RESET button. (→ 155) If normal conditions are not restored yet, remove the battery or AC adaptor, wait about 1 minute and then reconnect the battery or AC adaptor. Then about 1 minute later, turn on the power again. (Conducting the above operation when the access lamp is on may destroy the data on the disc or card.)
<p>The screen has changed suddenly.</p>	<ul style="list-style-type: none"> ● Has the demonstration started? → If you set [DEMO MODE] to [ON] without inserting a disc or a card in disc recording mode or card recording mode, the unit is automatically set to the demonstration mode for introducing its functions. Normally this should be set to [OFF]. Press the MENU button, then select [SETUP] → [DEMO MODE] → [OFF] and press the joystick.

Problem	Check points
The remote control does not function.	<ul style="list-style-type: none"> ● Has the button-type battery of the remote control run out? → Replace it with a new button-type battery. (→ 20)
The DISC EJECT lever does not work.	<ul style="list-style-type: none"> ● The disc cover will not open unless the unit is powered. → Connect a charged battery or AC adaptor. ● The DISC EJECT lever does not work when the unit is connected to the computer. (→ 156, 158)
The disc cannot be read.	<ul style="list-style-type: none"> ● Are there fingerprints or dirt on the surface of the disc? → If there are fingerprints or dirt on the disc, wipe them off. (→ 27)
A function indication such as remaining time indication or elapsed time indication is not shown.	<ul style="list-style-type: none"> ● If you set [SETUP]→[DISPLAY]→[OFF], indications other than warnings and date indications disappear.
Recording does not start although power is supplied to this unit and the disc or card is correctly inserted.	<ul style="list-style-type: none"> ● Is the DVD-RAM or the DVD-RW (VR format) write-protected? → Release the protection. (→ 102) If the DVD-RAM or DVD-RW (VR format) was protected on another device, release the protection on the same device. ● Has the DVD-RW (Video format) or DVD-R been finalized? → After finalizing, the discs become play-only and cannot record. If you un-finalize a DVD-RW (Video format), it can be used for recording. (→ 101) ● Has the SD card's write protect switch been set to LOCK? → No recording is possible while the write protect switch is set to LOCK. (→ 26) ● Is the memory of the disc or card full? → If the disc or card has no more available memory, free up some memory by deleting unnecessary scenes (→ 81, 94) or use a new disc or card. ● Is the unit set to the disc recording mode or card recording mode? → No recording is possible unless the mode dial is at  or . ● Is the disc cover open? → If the cover is open, this unit may not operate normally. Close the disc cover.
Recording starts but stops immediately. The playback picture breaks up for a moment.	<ul style="list-style-type: none"> ● Is the disc scratched or dirty? → Clean the disc. (→ 27) If there are scratches on the disc, use a new disc. ● The unit is hot. Follow the messages on the display. To use the unit again, turn the unit off and leave it for a while.

Problem	Check points
<p>The unit arbitrarily stops recording.</p>	<ul style="list-style-type: none"> ● Is the AGS function activated? → Record in the normal horizontal position or set [AGS] to [OFF]. (→ 49)
<p>Recorded still pictures are not clear.</p>	<ul style="list-style-type: none"> ● Are you trying to record small or finely detailed objects with [PICT. QUALITY] set at [FINE]? → If you try to record small or finely detailed objects with [PICT. QUALITY] set at [FINE], the images may break up into a mosaic-like pattern. Record with [PICT. QUALITY] set at [NORMAL] instead. (→ 55)
<p>Auto focus function does not work.</p>	<ul style="list-style-type: none"> ● Is manual focus mode selected? → Set the AUTO/MANUAL/FOCUS switch to AUTO. ● Are you trying to record a scene which is hard to bring into focus in auto focus mode? → There are some recording subjects and surroundings for which the auto focus does not operate correctly. (→ 164) If so, use the manual focus mode to adjust the focus. (→ 72) ● Is the MagicPix function set? → When the MagicPix function is working, focusing shifts into the manual mode.
<p>Sound is not played back from the built-in speaker of this unit.</p>	<ul style="list-style-type: none"> ● Is the volume too low? → During playback, move the volume lever to display the volume indication and adjust it. (→ 77)
<p>Although this unit is correctly connected to a TV, playback images cannot be seen. The playback images are squeezed horizontally.</p>	<ul style="list-style-type: none"> ● Have you selected video input on the TV? → Please read the operating instructions of your TV and select the channel that matches the input used for the connection. ● Is the [TV ASPECT] setting correct? → Change the setting to match the aspect ratio of the TV. Press the MENU button, then select [] SETUP → [] TV ASPECT → [16:9] or [4:3] and press the joystick.
<p>Scenes cannot be deleted or edited.</p>	<ul style="list-style-type: none"> ● Is the DVD-RAM or the DVD-RW (VR format) write-protected? → Release the protection. (→ 102) If the disc or the contents on the disc have been protected on another device, release the protection on the same device. ● It may not be possible to delete scenes that have been divided. → Combine the divided scenes, and then delete them. (→ 84) ● Scenes displayed as thumbnails in shades of blue and white may not be deleted. If the scenes are unnecessary, format the disc or card to erase the data. (→ 98, 99) Please be aware that if a disc or card is formatted then all the data recorded on the disc or card will be erased. ● Is the file on the SD card locked? → Locked files cannot be deleted. Release the lock setting. (→ 96) ● If the SD card's write protect switch is set to LOCK, then deletion is disabled. (→ 26)

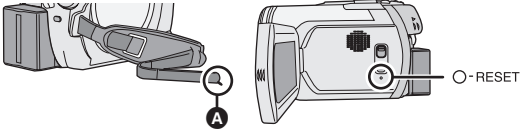
Problem	Check points
<p>The images on the SD card do not look normal.</p>	<ul style="list-style-type: none"> • The data may be destroyed. It may have been destroyed by static or electromagnetic waves. Store important data on a computer or other products as well.
<p>Even if a disc or a card is formatted, it cannot be used.</p>	<ul style="list-style-type: none"> • Either this unit or the disc or card may be damaged. Please consult a dealer. Use an SD Memory Card from 8 MB to 2 GB with this unit.
<p>The indication disappears.</p> <p>The screen is frozen.</p> <p>No operation can be performed.</p>	<ul style="list-style-type: none"> • Is this unit connected to a computer? → No operation can be performed on this unit when it is connected to a computer. • Turn off the power to this unit. If the power cannot be turned off, press the RESET button, or remove the battery or AC adaptor and then reattach it. After that, turn on the power again. If normal operation is still not restored, detach the power connected, and consult the dealer who you purchased this unit from.
<p>“PUSH THE RESET SWITCH.” is displayed.</p>	<ul style="list-style-type: none"> • The unit has automatically detected an error. Press the RESET button with the projecting part of the grip belt A. This will restart the unit.  <ul style="list-style-type: none"> • If you do not press the RESET button, the power to this unit is turned off automatically about 1 minute later. • Even after you press the RESET button, the indication may still appear repeatedly. If so, this unit needs repair. Detach the power connected, and consult the dealer who you purchased this unit from. Do not attempt to repair the appliance by yourself.

With a computer (Windows)

Problem	Check points
<p>Even if connected by the USB cable, this unit is not recognized by the computer.</p>	<ul style="list-style-type: none"> ● Have you set this unit to the correct mode? → The unit is not recognized if it is set to a recording mode. Set it to a playback mode. If it is set to card playback mode, disconnect the USB cable, set [USB FUNCTION] to [PC CONNECT] and then reconnect the USB cable. ● Select another USB terminal on the computer. ● Check the operating environment. (→ 114) ● Turn on the power to this unit.
<p>When DVD-MovieAlbumSE is started, the [Mount Information] dialog box appears.</p>	<ul style="list-style-type: none"> ● You inserted an incompatible disc. → A disc other than a DVD-RAM or a DVD-RW (VR format) is loaded in the drive: DVD-MovieAlbumSE cannot be used for media other than DVD-RAM or DVD-RW (VR format). ● If there are multiple drives, a drive other than this unit may be selected. → Click the [Preference] button in the dialog box, click the [Device setting] tab to choose the drive where the disc is loaded in the [Drive Select] column, and then click [OK]. ● If an error message appears even after a compatible disc is inserted, packet writing software may be installed in your computer. Uninstall the packet writing software.
<p>An image that should have been recorded does not appear when DVD-MovieAlbumSE is started.</p>	<ul style="list-style-type: none"> ● If there are multiple drives, a drive other than this unit may be selected. → Click the [Preference] button at top right of DVD-MovieAlbumSE screen, click the [Device setting] tab to choose the drive where the disc is loaded in the [Drive Select] column, and then click [OK].
<p>DVD-RW (Video format) or DVD-R cannot be played back on DVD-MovieAlbumSE.</p>	<ul style="list-style-type: none"> ● DVD-MovieAlbumSE does not support playback or data read of DVD-RW (Video format) or DVD-R. → Use optional-user provided DVD-Video playback software to play back DVD-RW (Video format) or DVD-R on the computer.
<p>The DISC EJECT lever does not work when the unit is connected to the computer.</p>	<ul style="list-style-type: none"> ● The DISC EJECT lever does not work after the unit is connected to the computer. → Use Windows Explorer to right-click the drive icon and execute [Eject]. Or use the software's eject button to eject the disc. ● After files are exported from DVD-MovieAlbumSE, a confirmation message is displayed about ejecting the disc. Select [Eject the disc being used].

Problem	Check points
<p>Cannot write to DVD-RAM.</p> <p>Cannot format a disc with the DVD-RAM Driver.</p>	<ul style="list-style-type: none"> ● (Windows XP only) Deleting the unit name from the Device Manager and then connecting the unit and the computer again can improve this. Follow the steps below. Before proceeding, be sure to remove the disc from the unit. <ol style="list-style-type: none"> 1) Select [start] → ([Settings] →) [Control Panel] → ([Performance and Maintenance] →) [System]. 2) Click the [Hardware] tab, then click [Device Manager]. 3) Right click [MATSHITA DVD-RAM LMXX1931 USB Device] displayed at [DVD/CD-ROM drives] and then select [Uninstall]. 4) When erasing is complete, reboot the computer. The computer will automatically recognize the unit again.
<p>When the USB cable is disconnected, an error message will appear on the computer.</p>	<ul style="list-style-type: none"> ● To disconnect the USB cable safely, double-click the icon in the task tray and follow the instructions on the screen. 

With a computer (Macintosh)

Problem	Check points
<p>Even if connected by the USB cable, this unit is not recognized by the computer.</p>	<ul style="list-style-type: none"> ● Have you set this unit to the correct mode? → The unit is not recognized if it is set to a recording mode. Set it to a playback mode. If it is set to card playback mode, disconnect the USB cable, set [USB FUNCTION] to [PC CONNECT] and then reconnect the USB cable. ● Select another USB terminal on the computer. ● Check the operating environment. (→ 133) ● Turn on the power to this unit.
<p>DVD-RAM or DVD-RW (VR format) icon is not displayed on the desktop.</p>	<ul style="list-style-type: none"> ● What version of Mac OS X are you using? → If it is V10.3.x or earlier, the icon is not displayed even if the disc is recognized by the computer. Use Disk Utility or Apple System Profiler to verify if the disc is recognized by the computer.
<p>When Pixe VRF Browser EX is started, a message is displayed about ejecting the disc.</p>	<ul style="list-style-type: none"> ● Is there a disc in this unit when Pixe VRF Browser EX is started? → Insert the disc after starting Pixe VRF Browser EX.

Problem	Check points
<p>Cannot register the file with ImageMixer VCD/DVD2.</p>	<ul style="list-style-type: none"> ● Is there a file with a compatible format in the folder? → Check the help for ImageMixer VCD/DVD2. ● In [Options] in the [Select folder], confirm the small box for [Add sub-folder(s)] is checked. ● The same folder cannot be selected simultaneously in DVD-Video mode and Video CD mode. In [Selected folder(s)] for the mode not being used, delete the folder.
<p>Cannot select this unit as the write destination drive with ImageMixer VCD/DVD2.</p>	<ul style="list-style-type: none"> ● Cannot write to this unit with ImageMixer VCD/DVD2. → To create a DVD-Video disc, a separate DVD-RW/DVD-R/+RW/+R drive is required.
<p>The disc for writing is not recognized by ImageMixer VCD/DVD2.</p>	<ul style="list-style-type: none"> ● If there is a disc in the drive before ImageMixer VCD/DVD2 is started, the drive will not be recognized properly. → 1) Click the upper-right save icon and save the settings. 2) Exit from ImageMixer VCD/DVD2 and remove the disc. 3) Start ImageMixer VCD/DVD2 again, click the [Load Project] button to read the file with the saved settings. 4) Proceed with [Write to Disc] again.
<p>The message [There is no work disk space.] is displayed and the data cannot write to disc.</p>	<ul style="list-style-type: none"> ● There is not enough work space to write to the disc. → Click the [Preferences] button on the upper-right of ImageMixer VCD/DVD2 and select a work space with a large amount of free space.
<p>The DISC EJECT lever does not work when the unit is connected to the computer.</p>	<ul style="list-style-type: none"> ● The DISC EJECT lever does not work after the unit is connected to the computer. Use the software's eject button to eject the disc.
<p>When the USB cable is disconnected, an error message will appear on the computer.</p>	<ul style="list-style-type: none"> ● When the drive icon is displayed on the desktop, drag the icon into the Trash and then disconnect the USB cable. ● When the drive icon is not displayed on the desktop, exit the application and then disconnect the USB cable.

Cautions for use

About this unit

- The unit, disc and card become warm after long operation, but this is not a malfunction.

Keep the unit away from magnetized products/mobile phones, microwave ovens, TVs and video game products.

- If you use the unit on or near a TV, the images or sound may be disturbed due to electromagnetic wave radiation.
- Do not use near cell phone because doing so may cause noise to adversely affect the picture and sound.
- Recordings may be damaged, or images may be distorted, by the strong magnetic fields created by speakers or large motors.
- Electromagnetic wave radiation generated by digital circuits including microprocessors may adversely affect the unit, causing the disturbance of images and sounds.
- If the unit is affected by such products and does not function properly, turn off the unit and detach the battery or AC adaptor. Then connect the battery or AC adaptor again.

Do not use the unit near radio transmitters or high-voltage cables.

- If you record pictures near radio transmitters or high-voltage cables, recorded images or sounds may be adversely affected.

Make sure to use the supplied cords and cables. If you use optional accessories, use the cords and the cables supplied with them.

Do not extend the cords and the cables.

Do not spray insecticides or volatile chemicals onto the unit.

- If the unit is sprayed with such chemicals, its body may be marred and the surface finish may peel off.
- Do not leave rubber or plastic products in contact with the unit for a long time.

When you use the unit in a sandy or dusty place such as a beach, do not let sand or fine dust get into the body and terminals of the unit.

Also, keep the unit away from sea water.

- Sand or dust may damage the unit. (Care should be taken when inserting and removing a disc or a card.)
- If sea water splashes onto the unit, wipe off the water with a well wrung cloth. Then wipe the unit again with a dry cloth.

When carrying the unit, do not drop or bump it.

- A strong impact can break the unit's casing, causing it to malfunction.

Do not use benzine, paint thinner or alcohol for cleaning the unit.

- Before cleaning, detach the battery or pull out the AC cable from the AC outlet.
- The camera body may be discolored and the surface finish may peel off.
- Wipe the unit with a soft dry cloth to remove dust and fingerprints. To remove stubborn stains, thoroughly wring a cloth that has been soaked in a neutral detergent diluted with water and wipe the unit with it. Afterwards, wipe it with a dry cloth.
- When you use a chemical dust cloth, follow the instructions that came with the cloth.

Do not touch the laser pickup lens.

- If you touch the laser pickup lens directly it may cause malfunctions.

Do not use a commercial available 8 cm (3") CD lens cleaner.

- Using 8 cm (3") CD lens cleaner could cause this unit to malfunction.

Do not use the unit for surveillance purposes or other business uses.

- If you use the unit for a long time, heat will build up inside it and this may cause a malfunction.
- This unit is not intended for business use.

When you are not going to use the unit for an extended time

- When storing the unit in a cupboard or cabinet, it is recommended that you place a desiccant (silica gel) in with it.

About the battery

The battery used in this unit is a rechargeable lithium-ion battery. It is susceptible to humidity and temperature and the effect increases the more the temperature rises or falls. In cold areas, the full charge indication may not appear or the low battery indication may appear about 5 minutes after starting use. At high temperatures, the protection function may be triggered, making it impossible to use the unit.

Be sure to detach the battery after use.

- If the battery is left attached, a minute amount of current continues to flow even if the unit's power is off. Keeping the unit in this state may result in over discharge of the battery. This may result in you not being able to use the battery even after it is charged.
- The battery should be stored in the vinyl bag so metal does not come into contact with the terminals.
- The battery should be stored in a cool place free from humidity, with as constant temperature as possible. (Recommended temperature: 15 °C to 25 °C (59 °F to 77 °F), Recommended humidity: 40% to 60%)
- Extremely high temperatures or low temperatures will shorten the life of the battery.
- If the battery is kept in high-temperature, high-humidity, or oily-smoky places, the terminals may rust and cause malfunctions.
- To store the battery for a long period of time, we recommend you charge it once every year and store it again after you have completely used up the charged capacity.
- Dust and other matter attached to the battery terminals should be removed.

Prepare spare batteries when going out for recording.

- Prepare batteries appropriate to 3 to 4 times the period during you want to record pictures in. In cold places such as a ski resort, the period during which you can record pictures is shortened.
- When you travel, do not forget to bring an AC adaptor so that you can recharge the batteries at your destination.

If you drop the battery accidentally, check to see if the terminals are damaged.

- Attaching a battery with damaged terminals can damage the unit or AC adaptor.

Do not throw old battery into fire.

- Heating a battery or throwing it into a fire may result in an explosion.
- If the operating time is very short even after the battery has been recharged, the battery has worn out. Please purchase a new battery.

About the AC adaptor

- If the battery is warm, charging requires more time than normal.
- If the temperature of the battery is extremely high or extremely low, the CHARGE lamp may continue flashing, and the battery may not be charged. Wait until the appropriate temperature is restored before charging the battery again. If the battery still fails to charge, something may be wrong with the battery or AC adaptor. Contact your dealer.
- If you use the AC adaptor near a radio, radio reception may be disturbed. Keep the AC adaptor 1 m (3.3 feet) or more away from the radio.
- When using the AC adaptor, it may generate whirring sounds. However, this is normal.
- After use, be sure to disconnect the AC adaptor. (If it is left connected, a minute amount of current is consumed.)
- Always keep the electrodes of the AC adaptor and battery clean.

Put this unit near the outlet to make it easy for the interrupting device (plug) to reach it.

About the disc

- **If there is dust, a scratch, or dirt on disc or if it is warped, the following phenomena may occur:**
 - Block noise in playback image
 - Momentary stop of playback image
 - Sound interrupted during playback, or abnormal sound
 - Thumbnail display with shades of blue and white
 - Disc cannot correctly be recognized
 - Delay between video and audio
- When recording images, this unit may avoid the portions of disc where recording is not possible, due to dust, scratches, etc. (It will pause at such a portion and automatically restart recording.)

When the access lamp is illuminated (during access to the disc), do not open the disc cover, turn off the power, or cause any vibrations or impacts.



DVD-R

- For optimum recording on DVD-R disc, this unit writes control data to the disc in order to automatically make adjustments when it is inserted and ejected accompanying recording. If the disc has no area for control data to be written, recording may not be possible. To prevent this, do not insert a DVD-R which has been recorded on more than 50 times.
- Do not insert a DVD-R recorded on this unit that has not been finalized into a recordable device, such as a DVD recorder. The recorded data may be damaged.

About the SD card

- The memory capacity indicated on the label of an SD card is the total of the capacity for copyright protection and management and the capacity which can be used on the unit, a computer etc.
- During prolonged use, the unit's surfaces and the SD card will heat up slightly. This is normal.

When inserting or removing the SD card, always set the OFF/ON switch to OFF.

While this unit accesses the SD card (while  or  is being displayed/the access lamp is lit), do not remove the SD card, operate the mode dial, turn off the power or shake or impact the unit.

LCD monitor/viewfinder

- When the LCD monitor gets dirty, wipe it with a dry soft cloth.
- In a place with drastic temperature changes, condensation may form on the LCD monitor. Wipe it with soft dry cloth.
- When the unit has become very cold, for example due to storage in a cold area, its LCD monitor will be slightly darker than usual immediately after the power is turned on. The normal brightness will be restored when the unit's internal temperature rises.

Extremely high precision technology is employed to produce the LCD Monitor screen featuring a total of approximately 123,000 pixels. The result is more than 99.99% effective pixels with a mere 0.01% of the pixels inactive or always lit. However, this is not a malfunction and does not affect the recorded picture.

Extremely high precision technology is employed to produce the viewfinder screen featuring a total of approximately 123,000 pixels. The result is more than 99.99% effective pixels with a mere 0.01% of the pixels inactive or always lit. However, this is not a malfunction and does not affect the recorded picture.

About condensation

When condensation forms on the unit, the lens will cloud up and the unit may not work properly. Make every effort to ensure that condensation does not form. If it does form, take the actions described below.

Causes of condensation

Condensation takes place when the ambient temperature or humidity is changed as follows.

- When this unit is brought inside from the cold (e.g. a ski slope) to a warm room.
- When this unit is moved from an air-conditioned car to outside.
- When a cold room has been warmed up quickly.
- When cool wind from an air conditioner is directly blown onto this unit.
- After summer afternoon showers of rain.
- When this unit is in a very humid place where the air is thick with steam. (e.g. a heated swimming pool)

When this unit is taken to a location with a significant temperature difference such as from a cold place to a hot place.

If, for example, you have used this unit for recording on a ski slope and are taking it into a heated room, place the unit inside a plastic bag, remove as much of the air from inside the bag as possible, then seal the bag. Leave the unit for about an hour in the room so the temperature of the unit is close to the ambient temperature of the room, then use it.

What to do with the lens is fogged up.

Remove the battery or AC adaptor and leave the unit for about 1 hour. When the unit becomes close to the ambient temperature, the fog disappears naturally.

Explanation of terms

Automatic white balance

White balance adjustment recognizes the color of light and adjusts so the white color will become a purer white. The unit determines the hue of light that comes through the lens and white balance sensor, thereby judging the recording condition, and selects the closest hue setting.

This is called automatic white balance adjustment.

However, since the unit only stores white color information under several light sources, automatic white balance adjustment does not function normally under other light sources.

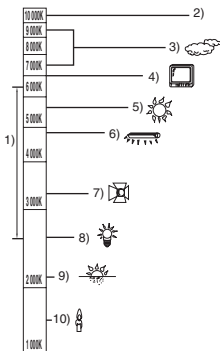

The illustration above shows the range over which the auto white balance functions.

- 1) The effective range of automatic white balance adjustment on this unit
- 2) Blue sky
- 3) Cloudy sky (rain)
- 4) TV screen
- 5) Sunlight
- 6) White fluorescent lamp
- 7) Halogen light bulb
- 8) Incandescent light bulb
- 9) Sunrise or sunset
- 10) Candlelight

Outside of the effective range of automatic white balance adjustment, the image will become reddish or bluish. Even within the effective range of automatic white balance adjustment, the automatic white balance adjustment may not function properly if there is more than one light source. For light outside the functional automatic white balance

adjustment range, use the manual white balance adjustment mode.

White balance

The images recorded by the unit may become bluish or reddish under the influence of certain light sources. To avoid such phenomena, adjust the white balance.

White balance adjustment determines the white color under different light sources. By recognizing which is the white color under sunlight and which is the white color under a fluorescent light, the unit can adjust the balance among the other colors.

Since the white color is the reference for all the colors (that make up light), the unit can record pictures in a natural hue if it can recognize the reference color white.

Auto focus

The lens is moved forward or backward automatically to bring the subject into focus.

Auto focus has the following characteristics.

- Adjusts so that the vertical lines of a subject are seen more clearly.
- Attempts to bring an object with higher contrast into focus.
- Focuses on the screen center only.

Due to these characteristics, auto focus does not work correctly in the following situations. Record pictures in the manual focus mode.

Recording distant and close-up objects at the same time

Since the unit focuses on whatever is at the center of the screen, it is difficult to bring the background into focus when close-up objects are placed in focus. When recording people with distant mountains in the background, you cannot focus on both the subject which is close-up and the objects which are in the distance.

Recording a subject behind dirty or dusty window

The subject behind the window will not be focused because the focus is on the dirty window.

Similarly, when recording something on the opposite side of a road with heavy traffic, a vehicle that happens to pass by may be brought into focus.

Recording a subject that is surrounded by objects with glossy surfaces or by highly reflective objects

Since whatever is shiny or glistens is brought into focus, it is hard to focus on the subject to be recorded. The focus may become blurry when recording subjects at the seashore, in night views or in scenes involving fireworks or special lights.

Recording a subject in dark surroundings

The unit cannot focus correctly because the light information that comes through the lens decreases considerably.

Recording a fast-moving subject

As the focus lens-inside moves mechanically, it cannot keep up with a fast-moving subject. When, for example, recording a sports event with fast moving subjects, the focus may lose its sharpness.

Recording a subject with little contrast

It is easy to bring subjects with a sharp contrast or vertical lines or stripes into focus. This means that a subject with little contrast, such as a white wall, may become blurry because the unit achieves focus based upon the vertical lines of an image.

Specifications

DVD Video Camera: Information for your safety

Power source: DC 7.9 V/7.2 V
Power consumption: **VDR-D300** 8.0 W/**VDR-D250** 7.5 W

Signal system	EIA Standard: 525 lines, 60 fields NTSC color signal
Recording format	DVD Video Recording format (DVD-RAM, DVD-RW) DVD-Video format (DVD-RW, DVD-R)
Image sensor	1/6-inch 3CCD image sensor Total: 800 K×3 Effective pixels: VDR-D300 Moving picture: 640 K×3 (4:3), 540 K×3 (16:9) Still picture: 710 K×3 (4:3), 540 K×3 (16:9) VDR-D250 Moving picture: 440 K×3 (4:3), 380 K×3 (16:9) Still picture: 530 K×3 (4:3), 400 K×3 (16:9)
Lens	Auto Iris, F1.8 to F2.8 Focal length: VDR-D300 3.0 mm to 30.0 mm VDR-D250 2.45 mm to 24.5 mm Macro (Full range AF)
Filter diameter	37 mm
Zoom	10× optical zoom, 25/700× digital zoom
Monitor	2.7" wide LCD monitor (approx. 123 K pixels)
Viewfinder	Color electric viewfinder (approx. 123 K pixels)
Microphone	Stereo (with a zoom function)
Speaker	1 round speaker ∅ 20 mm
Standard illumination	1,400 lx
Minimum required illumination	12 lx (1 lx with the MagicPix function)
Video output level	1.0 Vp-p, 75 Ω
S-Video output level	Y: 1.0 Vp-p, 75 Ω C: 0.286 Vp-p, 75 Ω
Audio output level (Line)	316 mV, 600 Ω
Mic input	Mic sensitivity -50 dB (0 dB=1 V/Pa, 1 kHz) (Stereo mini jack)
USB	Card reader/writer function (No copyright protection support) USB 2.0 compliant (Hi-Speed) PictBridge-compliant Motion picture transfer
Flash (VDR-D300 only)	GN 4.8

Specifications

Dimensions (excluding projecting parts)	VDR-D300 Approx. 63 mm (W) × 87 mm (H) × 138 mm (D) [Approx. 2.48 inch (W) × 3.43 inch (H) × 5.43 inch (D)] VDR-D250 Approx. 63 mm (W) × 87 mm (H) × 136 mm (D) [Approx. 2.48 inch (W) × 3.43 inch (H) × 5.35 inch (D)]
Mass (without supplied battery, lens cap and a disc)	VDR-D300 Approx. 585 g (1.29 lbs.) VDR-D250 Approx. 555 g (1.224 lbs.)
Operating temperature	0 °C to 40 °C (32 °F to 104 °F) [0 °C to 30 °C (32 °F to 86 °F) when connected to the computer]
Operating humidity	10% to 80%

Motion pictures

Recording media	8 cm (3") DVD-RAM Ver. 2.1 8 cm (3") DVD-RW Ver. 1.1/2X-SPEED (2X/1X) 8 cm (3") DVD-R for General Ver. 2.0
Compression	MPEG2
Recording mode and transfer rate	XP: 9 Mbps (VBR) (Approx. 18 min recordable time on a single-sided DVD-RAM) SP: 5 Mbps (VBR) (Approx. 37 min recordable time on a single-sided DVD-RAM) LP: 2.5 Mbps (VBR) (Approx. 75 min recordable time on a single-sided DVD-RAM)
Audio compression	Dolby Digital (Dolby AC3), 16 bit (48 kHz/2 ch)

Still pictures

Recording media	SD Memory Card (8 MB/16 MB/32 MB/64 MB/128 MB/256 MB/512 MB/1 GB/2 GB (Maximum))
Compression	JPEG (Design rule for Camera File system, based on Exif 2.2 standard), DPOF corresponding
Picture size	VDR-D300 2048×1512, 1920×1080 (16:9), 1280×960, 640×480 VDR-D250 1760×1320, 1760×992 (16:9), 1280×960, 640×480

AC adaptor: Information for your safety



Power source:	AC 110 V to 240 V, 50/60 Hz
Power consumption:	19 W
DC output:	DC 7.9 V, 1.4 A (Unit operation) DC 8.4 V, 0.65 A (Battery charging)



Dimensions	Approx. 61 mm (W) × 32 mm (H) × 91 mm (D) [Approx. 2.40 inch (W) × 1.26 inch (H) × 3.58 inch (D)]
Mass	Approx. 110 g (0.24 lbs.)

Mass and dimensions are approximate values.
Specifications may change without prior notice.



Number of recordable pictures on an SD card



VDR-D300

Picture size	3.1M (2048×1512)	
Picture quality		
8 MB	3	5
16 MB	8	13
32 MB	18	29
64 MB	39	61
128 MB	75	120
256 MB	160	250
512 MB	320	490
1 GB	630	990
2 GB	1290	2010



2M (1920×1080)	
	
4	7
10	17
24	39
51	81
98	155
210	330
410	650
820	1290
1680	2630



VDR-D250



Picture size	2.3M (1760×1320)	
Picture quality		
8 MB	4	7
16 MB	10	18
32 MB	24	40
64 MB	51	83
128 MB	99	160
256 MB	210	330
512 MB	410	660
1 GB	820	1330
2 GB	1680	2700

1.7M (1760×992)	
	
7	11
18	28
40	61
83	125
160	240
330	510
660	1010
1330	2010
2700	4100

VDR-D300/VDR-D250











Picture size	1M (1280×960)	
Picture quality		
8 MB	8	14
16 MB	21	34
32 MB	47	75
64 MB	97	155
128 MB	185	300
256 MB	390	620
512 MB	780	1230
1 GB	1550	2470
2 GB	3160	5030

0.3M (640×480)	
	
45	95
100	200
220	440
440	880
880	1760
1760	3520
3520	7040
7040	14080
14080	28160

- The number of recordable pictures depends on whether [] and [] are used together and on the subject being recorded.
- The numbers shown in the table are approximations.

Optional accessories

DVD video camera accessories

Accessory No.	Figure	Description
LM-AF30U		8 cm (3") DVD-RAM (single sided)
LM-AF60U		8 cm (3") DVD-RAM (double sided)
LM-RW30U		8 cm (3") DVD-RW (single sided)
LM-RW60U		8 cm (3") DVD-RW (double sided)
LM-RF30V		8 cm (3") DVD-R (single sided)
PV-DAC14		AC adaptor with AC Cable and DC Cables
CGA-DU12A/1B*		1150 mAh/Rechargeable Lithium Ion Battery Pack
CGA-DU21A/1B*		2040 mAh/Rechargeable Lithium Ion Battery Pack
RP-SDK02GU1A RP-SDK01GU1A RP-SDK512U1A RP-SDH256U1A RP-SDQ02GU1A RP-SDQ01GU1A RP-SD512BU1A RP-SD256BU1A RP-SD128BU1A RP-SD064BPPA RP-SD032BPPA		Pro High Speed 2 GB SD Memory Card Pro High Speed 1 GB SD Memory Card Pro High Speed 512 MB SD Memory Card Super High Speed 256 MB SD Memory Card High Speed 2 GB SD Memory Card High Speed 1 GB SD Memory Card High Speed 512 MB SD Memory Card High Speed 256 MB SD Memory Card High Speed 128 MB SD Memory Card High Speed 64 MB SD Memory Card High Speed 32 MB SD Memory Card
BN-SDPC3E		SD PCMCIA High Speed Adaptor
N2QCAD000007		Magic Wire Remote Control
VW-LDC10		Video DC Light (10 W) • Battery pack (CGR-DU06) is necessary to activate it.

* Please refer to page 29 concerning the battery charging time and available recording time.

NOTE: Accessories and/or model numbers may vary by country. Please consult your local dealer.

Accessory Order Form (For USA Customers)

Please photocopy this form when placing an order.

1. Model # _____

2. Items Ordered

Accessory #	Description	Price Each	Quantity	Total Price
Subtotal				
Your State & Local Sales Tax				
Shipping & Handling				6.95
Total Enclosed				

3. Method of payment (check one)

- Check of Money Order enclosed (NO C.O.D.SHIPMENTS)
- VISA Credit Card # _____
- MasterCard Expiration Date _____
- Discover Customer Signature _____

Make Check or Money Order Payable to: PANASONIC ACCESSORIES

(Please do not send cash)

4. Shipping information (UPS delivery requires complete street address)

Ship To:

Mr.

Mrs.

Ms. _____

First

Last

Phone#:

Day () _____

Street Address

Night () _____

City

State

Zip

TO OBTAIN ANY OF OUR ACCESSORIES YOU CAN DO ANY OF
THE FOLLOWING:
VISIT YOUR LOCAL PANASONIC DEALER
OR
CALL PANASONIC'S ACCESSORY ORDER LINE AT 1-800-332-5368
[6 AM-5 PM M-F, 6 AM-10:30 AM SAT, PACIFIC TIME]
OR
MAIL THIS ORDER TO: PANASONIC SERVICES COMPANY ACCESSORY ORDER OFFICE
20421 84th Avenue South Kent, WA. 98032

In CANADA, please contact your local Panasonic dealer for more information on Accessories.

Request for Service Notice (USA Only)

Please photocopy this form when making a request for service notice, in the unlikely event this product needs service.

Request for Service Notice:

- Please include your **proof of purchase**.
(Failure to do so will delay your repair.)
 - To further speed your repair, please provide an explanation of what is wrong with the unit and any symptom it is exhibiting.
-
-
-
-

Mail this completed form and your Proof of Purchase along with your unit to:
Panasonic Services Company
410B Airport Road
Elgin, IL 60123-9333
Attn: Camcorder Repair

Limited Warranty (For USA Customers)

PANASONIC CONSUMER ELECTRONICS
COMPANY, DIVISION OF PANASONIC
CORPORATION OF NORTH AMERICA
One Panasonic Way, Secaucus, New Jersey 07094

PANASONIC PUERTO RICO, INC.
Ave. 65 de Infantería, Km. 9.5 San Gabriel Industrial Park,
Carolina, Puerto Rico 00985

Panasonic Video Products Limited Warranty

Limited Warranty Coverage

If your product does not work properly because of a defect in materials or workmanship, Panasonic Consumer Electronics Company or Panasonic Puerto Rico, Inc. (collectively referred to as "the warrantor") will, for the length of the period indicated on the chart below, which starts with the date of original purchase ("warranty period"), at its option either (a) repair your product with new or refurbished parts, or (b) replace it with a new or a refurbished product. The decision to repair or replace will be made by the warrantor.

Product	Parts	Labor	Service	Contact Number
Camcorder	One (1) Year (except CCD Image Sensor) CCD Image Sensor - 6 (Six) Months	Ninety (90) Days Ninety (90) Days	Carry-In or Mail-In	1-800-211-PANA(7262)
DVD/VCR Deck, AV Mixer	One (1) Year	Ninety (90) Days	Carry-In or Mail-In	1-800-211-PANA(7262)
TV/VCR, TV/DVD, TV/DVD/VCR Combination	One (1) Year (except CRT) CRT - Two (2) Years	Ninety (90) Days Ninety (90) Days	Carry-In: 21" CRT and Smaller In-Home or Carry-In: 22" CRT and Larger	1-800-211-PANA(7262)
TV/HDR Combination	One (1) Year (except CRT) CRT - Two (2) Years	Ninety (90) Days Ninety (90) Days	In-Home or Carry-In	1-888-843-9788
Rechargeable Batteries (in exchange for defective item)	Ten (10) Days	Not Applicable	Carry-In or Mail-In	1-800-211-PANA(7262)
Tape (in exchange for defective item)	Five (5) Days	Not Applicable	Carry-In or Mail-In	1-800-211-PANA(7262)
Memory Cards (in exchange for defective item)	Ninety (90) Days	Not Applicable	Carry-In or Mail-In	1-800-211-PANA(7262)

During the "Labor" warranty period there will be no charge for labor. During the "Parts" warranty period, there will be no charge for parts. You must carry-in or mail-in (prepaid) your product or arrange for in-home service, as applicable, during the warranty period.

If non-rechargeable batteries are included, they are not warranted. This warranty only applies to products purchased and serviced in the United States or Puerto Rico. This warranty is extended only to the original purchaser of a new product which was not sold "as is". A purchase receipt or other proof of the original purchase date is required for warranty service.

Carry-In, Mail-in (Prepaid) or In-Home Service

For Carry-In, Mail-In (prepaid) or In-Home Service (as applicable) in the United States call toll free contact number listed above or visit Panasonic Web Site: <http://www.panasonic.com>

For assistance in Puerto Rico call Panasonic Puerto Rico, Inc. (787)-750-4300 or fax (787)-768-2910.

In-Home service, if applicable, requires clear, complete and easy access to the product by the authorized servicer and does not include removal or re-installation of an installed product. It is possible that certain in-home repairs will not be completed in-home, but will require that the product, or parts of the product, be removed for shop diagnosis and/or repair and then returned.

Limited Warranty Limits And Exclusions

This warranty ONLY COVERS failures due to defects in materials or workmanship, and DOES NOT COVER normal wear and tear or cosmetic damage, nor does it cover markings or retained images on the picture tube resulting from viewing fixed images (including, among other things, letterbox pictures on standard 4:3 screen TV's, or non-expanded standard 4:3 pictures on wide screen TV's, or onscreen data in a stationary and fixed location). The warranty ALSO DOES NOT COVER damages which occurred in shipment, or failures which are caused by products not supplied by the warrantor, or failures which result from accidents, misuse, abuse, neglect, bug infestation, mishandling, misapplication, alteration, faulty installation, set-up adjustments, misadjustment of consumer controls, improper maintenance, power line surge, lightning damage, modification, or commercial use (such as in a hotel, office, restaurant, or other business), rental use of the product, service by anyone other than a Factory Servicenter or other Authorized Servicer, or damage that is attributable to acts of God.

THERE ARE NO EXPRESS WARRANTIES EXCEPT AS LISTED UNDER "LIMITED WARRANTY COVERAGE". THE WARRANTOR IS NOT LIABLE FOR INCIDENTAL OR CONSEQUENTIAL DAMAGES RESULTING FROM THE USE OF THIS PRODUCT, OR ARISING OUT OF ANYBREACH OF THIS WARRANTY.

(As examples, this excludes damages for lost time, cost of having someone remove or re-install an installed unit if applicable, or travel to and from the servicer, loss of media or images, data or other memory or recorded content. The items listed are not exclusive, but are for illustration only.)

ALL EXPRESS AND IMPLIED WARRANTIES, INCLUDING THE WARRANTY OF MERCHANTABILITY, ARE LIMITED TO THE PERIOD OF THE LIMITED WARRANTY.

Some states do not allow the exclusion or limitation of incidental or consequential damages, or limitations on how long an implied warranty lasts, so the exclusions may not apply to you. This warranty gives you specific legal rights and you may also have other rights which vary from state to state. If a problem with this product develops during or after the warranty period, you may contact your dealer or Servicenter. If the problem is not handled to your satisfaction, then write to the warrantor's Consumer Affairs Department at the addresses listed for the warrantor.

PARTS AND SERVICE (INCLUDING COST OF AN IN-HOME SERVICE CALL, WHERE APPLICABLE) WHICH ARE NOT COVERED BY THIS LIMITED WARRANTY ARE YOUR RESPONSIBILITY.

Customer Services Directory

Service in Canada: As per Sevicenter listed in Canadian warranty information → 173

Obtain Product Information and Operating Assistance; locate your nearest Dealer or Servicenter; purchase Parts and Accessories; or make Customer Service and Literature requests by visiting our Web Site at:

<http://www.panasonic.com/consumersupport>

or, contact us via the web at:

<http://www.panasonic.com/contactinfo>

You may also contact us directly at:

1-800-211-PANA (7262),

Monday-Friday 9 am-9 pm; Saturday-Sunday 10 am-7 pm, EST

For hearing or speech impaired TTY users, TTY : 1-877-833-8855

Accessory Purchases

Purchase Parts, Accessories and Instruction Books online for all Panasonic Products by visiting our Web Site at:

<http://www.pasc.panasonic.com>

or, send your request by E-mail to:

npcparts@us.panasonic.com

You may also contact us directly at:

1-800-332-5368 (Phone) 1-800-237-9080 (Fax Only) (Monday – Friday 9 am to 8 pm, EST.)

Panasonic Services Company

20421 84th Avenue South,

Kent, WA 98032

(We Accept Visa, MasterCard, Discover Card, American Express, and Personal Checks)

For hearing or speech impaired TTY users, TTY : 1-866-605-1277

Product Repairs

Centralized Factory Servicenter

MAIL TO:

Panasonic Services Company

410B Airport Road

Elgin, IL 60123-9333

Attention: Camcorder Repair

Please carefully pack and ship, prepaid and insured, to the Elgin Centralized Factory Servicenter Customer's in Puerto Rico, please ship or carry in to location below ("Service in Puerto Rico").

Service in Puerto Rico

Panasonic Puerto Rico, Inc.

Ave. 65 de Infantería, Km. 9.5, San Gabriel Industrial Park,

Carolina, Puerto Rico 00985

Phone (787)750-4300, Fax (787)768-2910

As of October 2005

Warranty (For Canadian Customers)

Panasonic Canada Inc.

5770 Ambler Drive, Mississauga, Ontario L4W 2T3

PANASONIC PRODUCT – LIMITED WARRANTY

Panasonic Canada Inc. warrants this product to be free from defects in material and workmanship and agrees to remedy any such defect for a period as stated below from the date of original purchase.

Camcorder Product – One (1) year, parts and labour

LIMITATIONS AND EXCLUSIONS

This warranty does not apply to products purchased outside Canada or to any product which has been improperly installed, subjected to usage for which the product was not designed, misused or abused, damaged during shipping, or which has been altered or repaired in any way that affects the reliability or detracts from the performance, nor does it cover any product which is used commercially. Dry cell batteries are also excluded from coverage under this warranty.

This warranty is extended to the original end user purchaser only. A purchase receipt or other proof of date of original purchase is required before warranty service is performed.

THIS EXPRESS, LIMITED WARRANTY IS IN LIEU OF ALL OTHER WARRANTIES, EXPRESS OR IMPLIED, INCLUDING ANY IMPLIED WARRANTIES OF MERCHANTABILITY AND FITNESS FOR A PARTICULAR PURPOSE.

IN NO EVENT WILL PANASONIC CANADA INC. BE LIABLE FOR ANY SPECIAL, INDIRECT OR CONSEQUENTIAL DAMAGES.

In certain instances, some jurisdictions do not allow the exclusion or limitation of incidental or consequential damages, or the exclusion of implied warranties, so the above limitations and exclusions may not be applicable.

WARRANTY SERVICE

FOR PRODUCT OPERATION ASSISTANCE, please contact:

Our Customer Care Centre: Telephone #: (905) 624-5505
1-800 #: 1-800-561-5505
Fax #: (905) 238-2360
Email link: "Contact Us" on www.panasonic.ca

FOR PRODUCT REPAIRS, please locate your nearest Authorized Servicentre at www.panasonic.ca :

Link: "Servicentres™ locator" under "Customer support"

Panasonic Factory Service:

Vancouver

Panasonic Canada Inc.
12111 Riverside Way
Richmond, BC V6W 1K8
Tel: (604) 278-4211
Fax: (604) 278-5627

Toronto

Panasonic Canada Inc.
5770 Ambler Dr.
Mississauga, ON L4W 2T3
Tel: (905) 624-8447
Fax: (905) 238-2418

IF YOU SHIP THE PRODUCT TO A SERVICENTRE

Carefully pack and send prepaid, adequately insured and preferably in the original carton. Include details of the defect claimed, and proof of date of original purchase.

Index

■ Numerics

0 Lux MagicPix function 63

■ A

AC adaptor 28, 30, 161

Aperture 75

Auto focus 164

Auto Ground-directional Standby (AGS) . . . 49

Automatic white balance 73, 163

■ B

Backlight compensation 58

Battery 28, 29, 160

Beep sound 144

Black balance 74

■ C

Card 26, 27, 34, 162

Charging time 29

■ D

Date and time display 45

Delete

 Scene 81

 Still picture 94

Demo mode 144

Digital zoom 56

Disc 23, 27, 32, 161

 Information 103

Display 144

DPOF setting 97

Dubbing 107, 108

DVD-RAM, DVD-RW, DVD-R 23

■ F

Fade 59

Finalize 100

Flash 68

Format

 Card 99

 Disc 98

Frame-by-frame playback 77

■ G

Gain 75

■ H

Help mode 40

■ I

Image stabilizer function 67

Initial setting 144

Iris 75

■ L

Language 41

LCD monitor 19, 47, 162

Locking files 96

■ M

MagicPix function 63

Manual focus 72

Menu 42

Menu list 142

Motion picture playback 76

Motion picture recording 50

■ N

Number of recordable pictures 167

■ O

Operation icons 37

■ P

Pickup lens 32

PictBridge 109

Picture quality 55

Picture size 54

Playing back motion pictures by date 78

Playlist 85

Power LCD 47

Power save 144

Protect (Disc) 102

■ R

Recording lamp 144

Recording mode 51

Recording time elapsed 51

Red eye reduction 69

Remaining number of still pictures 53

Remaining time 51

Repair (Disc) 148

Resume playback 78

■ S

Scene mode 70

SD Memory Card 26

Self-recording 57

Self-timer recording 64

Shutter effect 55

Shutter speed 75

Skip playback 76

Slide show 80

Slow-motion playback 77

Soft skin mode 61

Still picture compatibility 80

Still picture playback 79

Still picture recording 52

■ T

Tele macro 62

TV aspect 105

■ U	
Un-finalize	101
■ V	
Video format	24
Viewfinder	19, 47, 162
Volume adjustment	77
VR format	24
■ W	
White balance	73, 163
Wide mode	66
Wind noise reduction function	65
■ Z	
Zoom	56
Zoom microphone	57

Spanish Quick Use Guide/Guía española para el uso rápido

■ Carga de la batería

- 1 Conecte el cable eléctrico de CA al adaptador de CA y a la toma de la red de CA.
- 2 Meta la batería en el respectivo soporte alineando la marca, luego encájela.

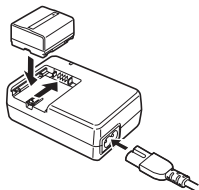

■ Montaje de la batería

Empuje la batería contra el porta batería y hágala deslizar hasta que dispare.

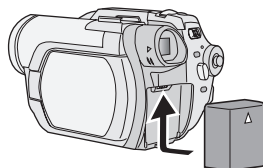

■ Cómo quitar la batería

Mientras hace deslizar la palanca BATTERY RELEASE, haga deslizar la batería para quitarla.

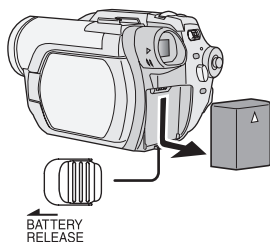

■ Cómo encender/apagar la alimentación

Mientras pulsa el botón **A**, ajuste el interruptor OFF/ON a ON/OFF.

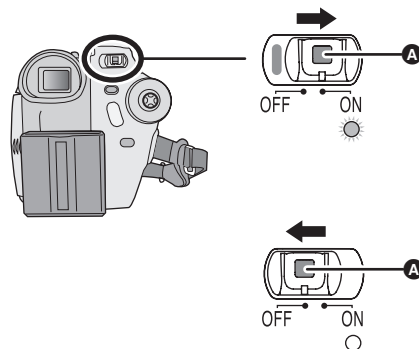

■ Insertar/quitar un disco

- 1 Haga deslizar la palanca DISC EJECT una vez y la deje.

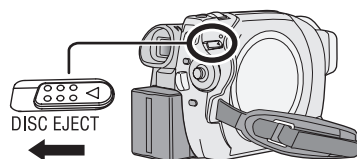

- 2 Abra la tapa del compartimento del disco manualmente e inserte/saque el disco.

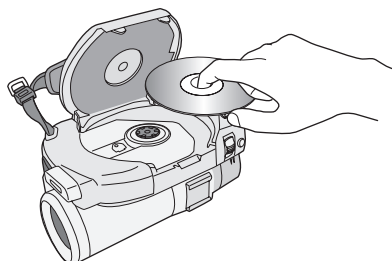

- 3 Empuje la sección marcada "PUSH CLOSE" en la tapa del compartimento del disco para cerrarla.

■ Cómo insertar/quitar una tarjeta SD

- 1 Abra la tapa de la ranura de la tarjeta.

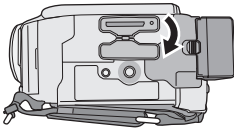

- 2 Inserte/quite la tarjeta SD en/de la ranura de la tarjeta.

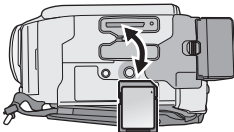

- 3 Cierre firmemente la tapa de la ranura de la tarjeta.

■ Grabación de imágenes dinámicas

- Gire el selector de modo para seleccionar .

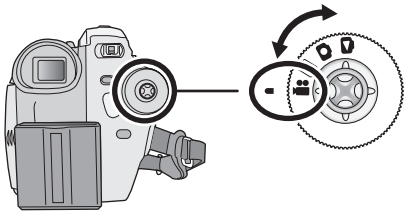

- 1 Pulse el botón de inicio/parada de la grabación para empezar a grabar.

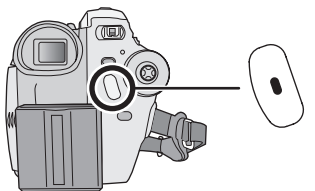

- 2 Pulse de nuevo el botón de inicio/parada de la grabación para detener brevemente la grabación.



■ Grabación de imágenes fijas

- Gire el selector de modo para seleccionar .

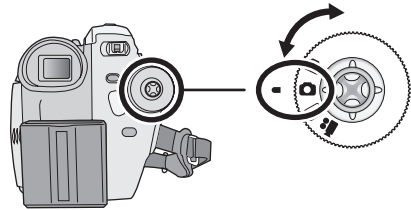

- 1 Pulse el botón PHOTO SHOT a medias para enfocar al sujeto. (Solo en el modo de enfoque automático)

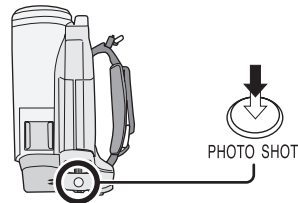

- 2 Pulse completamente el botón PHOTO SHOT.

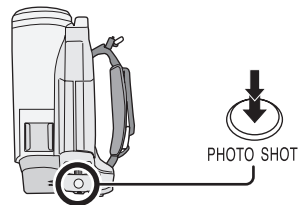

■ Reproducción de imágenes dinámicas

- Gire el selector de modo para seleccionar .

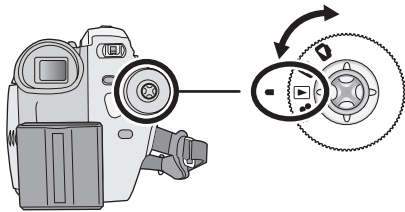

1 Seleccione la escena a ser reproducida.

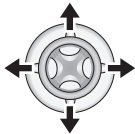

2 Pulse el joystick.



3 Mueva el joystick para obrar.

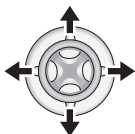

- ▶/||: Reproducción/Pausa
- ◀◀ (Mueva): Salto de reproducción (hacia atrás)
- ◀◀ (Mueva y mantenga): Reproducción regresiva
- ▶▶ (Mueva): Salto de reproducción (en adelante)
- ▶▶ (Mueva y mantenga): Reproducción progresiva
- : Detiene la reproducción y muestra las miniaturas.

■ Reproducción de imágenes fijas

- Gire el selector de modo para seleccionar .

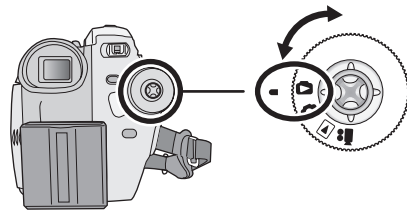

1 Seleccione el archivo a ser reproducido.

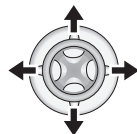

2 Pulse el joystick.



3 Mueva el joystick para obrar.

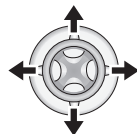

- ▶/||: La exposición de diapositivas (reproducción de las imágenes en la tarjeta SD en orden numérico) inicia/se interrumpe. (Solo si se ha seleccionado [DIAPOSITIVA].)
- ◀◀: Reproduce la imagen anterior.
- ▶▶: Reproduce la imagen siguiente.
- : Detiene la reproducción y muestra las miniaturas.

**Panasonic Consumer Electronics Company,
Division of Panasonic Corporation of North America**

One Panasonic Way, Secaucus, NJ 07094

Panasonic Puerto Rico, Inc.

Ave. 65 de Infantería, Km. 9.5, San Gabriel Industrial Park, Carolina, Puerto Rico 00985

Panasonic Canada Inc.

5770 Ambler Drive, Mississauga, Ontario, L4W 2T3



LSQT1011 B

F0106Mc1016 (12100 Ⓑ)



Printed in Japan

Free Manuals Download Website

<http://myh66.com>

<http://usermanuals.us>

<http://www.somanuals.com>

<http://www.4manuals.cc>

<http://www.manual-lib.com>

<http://www.404manual.com>

<http://www.luxmanual.com>

<http://aubethermostatmanual.com>

Golf course search by state

<http://golfingnear.com>

Email search by domain

<http://emailbydomain.com>

Auto manuals search

<http://auto.somanuals.com>

TV manuals search

<http://tv.somanuals.com>