

marantz®

Model VP-12S2 User Guide

DLP™ Projector

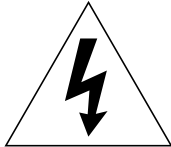

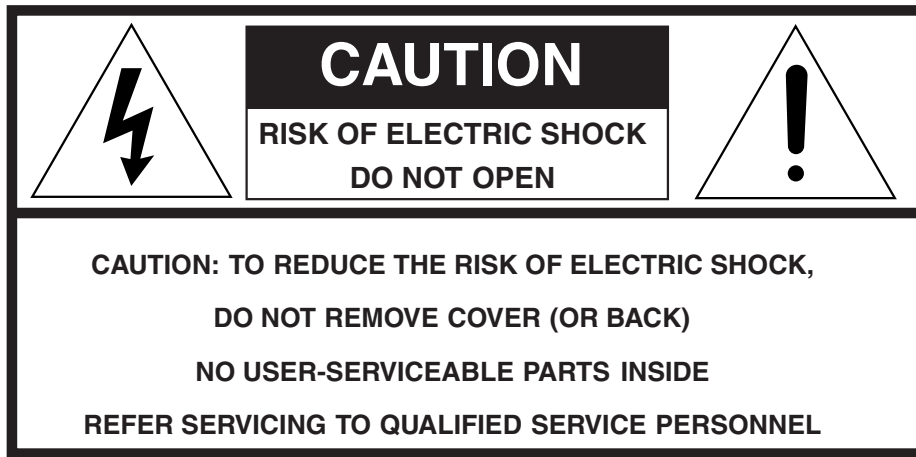

The lightning flash with arrowhead symbol within an equilateral triangle is intended to alert the user to the presence of uninsulated "dangerous voltage" within the product's enclosure that may be of sufficient magnitude to constitute a risk of electric shock to persons.



The exclamation point within an equilateral triangle is intended to alert the user to the presence of important operating and maintenance (servicing) instructions in the literature accompanying the product.

WARNING

TO REDUCE THE RISK OF FIRE OR ELECTRIC SHOCK,
DO NOT EXPOSE THIS PRODUCT TO RAIN OR MOISTURE.

CAUTION: TO PREVENT ELECTRIC SHOCK, MATCH WIDE BLADE OF PLUG TO WIDE SLOT, FULLY INSERT.

ATTENTION: POUR ÉVITER LES CHOCS ÉLECTRIQUES, INTRODUIRE LA LAME LA PLUS LARGE DE LA FICHE DANS LA BORNE CORRESPONDANTE DE LA PRISE ET POUSSER JUSQU'AU FOND.

For the customers in the USA:

This equipment has been tested and found to comply with the limits for a Class B digital device, pursuant to Part 15 of the FCC Rules. These limits are designed to provide reasonable protection against harmful interference in a residential installation. This equipment generates, uses and can radiate radio frequency energy and, if not installed and used in accordance with the instructions, may cause harmful interference to radio communications. However, there is no guarantee that interference will not occur in a particular installation. If this equipment does cause harmful interference to radio or television reception, which can be determined by tuning the equipment off and on, the user is encouraged to try to correct the interference by one or more of the following measures:

- Reorient or relocate the receiving antenna.
- Increase the separation between the equipment and receiver.
- Connect the equipment into an outlet on a circuit different from that to which the receiver is connected.
- Consult the dealer or an experienced radio/TV technician for help.

NOTE:

Changes or modifications not expressly approved by the party responsible for compliance could void the user's authority to operate the equipment.

For the customers in Canada:

This Class B digital apparatus meets all requirements of the Canadian Interference-Causing Equipment regulations.

IMPORTANT SAFETY INSTRUCTIONS

READ BEFORE OPERATING EQUIPMENT

This product was designed and manufactured to meet strict quality and safety standards. There are, however, some installation and operation precautions which you should be particularly aware of.

1. Read Instructions – All the safety and operating instructions should be read before the product is operated.
2. Retain Instructions – The safety and operating instructions should be retained for future reference.
3. Heed Warnings – All warnings on the product and in the operating instructions should be adhered to.
4. Follow Instructions – All operating and use instructions should be followed.
5. Cleaning – Unplug this product from the wall outlet before cleaning. Do not use liquid cleaners or aerosol cleaners. Use a damp cloth for cleaning.
6. Attachments – Do not use attachments not recommended by the product manufacturer as they may cause hazards.
7. Water and Moisture – Do not use this product near water-for example, near a bath tub, wash bowl, kitchen sink, or laundry tub, in a wet basement, or near a swimming pool, and the like.
8. Accessories – Do not place this product on an unstable cart, stand, tripod, bracket, or table. The product may fall, causing serious injury to a child or adult, and serious damage to the product. Use only with a cart, stand, tripod, bracket, or table recommended by the manufacturer, or sold with the product. Any mounting of the product should follow the manufacturer's instructions, and should use a mounting accessory recommended by the manufacturer.
9. A product and cart combination should be moved with care. Quick stops, excessive force, and uneven surfaces may cause the product and cart combination to overturn.
10. Ventilation – Slots and openings in the cabinet are provided for ventilation and to ensure reliable operation of the product and to protect it from overheating, and these openings must not be blocked or covered. The openings should never be blocked by placing the product on a bed, sofa, rug, or other similar surface. This product should not be placed in a built-in installation such as a bookcase or rack unless proper ventilation is provided or the manufacturer's instructions have been adhered to.
11. Power Sources – This product should be operated only from the type of power source indicated on the marking label. If you are not sure of the type of power supply to your home, consult your product dealer or local power company. For products intended to operate from battery power, or other sources, refer to the operating instructions.
12. Alternate Warnings – This product is equipped with a three-wire grounding-type plug, a plug having a third (grounding) pin. This plug will only fit into the a grounding-type power outlet. This is a safety feature. If you are unable to insert the plug into the outlet, contact your electrician to replace your obsolete outlet. Do not defeat the safety purpose of the grounding-type plug.
13. Power-Cord Protection – Power-supply cords should be routed so that they are not likely to be walked on or pinched by items placed upon or against them, paying particular attention to cords at plugs, convenience receptacles, and the point where they exit from the product.
14. Protective Attachment Plug – The product is equipped with an attachment plug having overload protection. This is a safety feature. See Instruction Manual for replacement or resetting of protective device. If replacement of the plug is required, be sure the service technician has used a replacement plug specified by the manufacturer that has the same overload protection as the original plug.
15. Lightning – For added protection for this product during a lightning storm, or when it is left unattended and unused for long periods of time, unplug it from the wall outlet and disconnect the antenna or cable system. This will prevent damage to the product due to lightning and power-line surges.
16. Power Lines – An outside antenna system should not be located in the vicinity of overhead power lines or other electric light or power circuits, or where it can fall into such power lines or circuits. When installing an outside antenna system, extreme care should be taken to keep from touching such power lines or circuits as contact with them might be fatal.
17. Overloading – Do not overload wall outlets, extension cords, or integral convenience receptacles as this can result in a risk of fire or electric shock.
18. Object and Liquid Entry – Never push objects of any kind into this product through openings as they may touch dangerous voltage points or short-out parts that could result in a fire or electric shock. Never spill liquid of any kind on the product.
19. Servicing – Do not attempt to service this product yourself as opening or removing covers may expose you to dangerous voltage or other hazards. Refer all servicing to qualified service personnel.
20. Damage Requiring Service – Unplug this product from the wall outlet and refer servicing to qualified service personnel under the following conditions:
 - a. When the power-supply cord or plug is damaged.
 - b. If liquid has been spilled, or objects have fallen into the product.
 - c. If the product has been exposed to rain or water.
 - d. If the product does not operate normally by following the operating instructions. Adjust only those controls that are covered by the operating instructions as an improper adjustment of other controls may result in damage and will often require extensive work by a qualified technician to restore the product to its normal operation.
 - e. If the product has been dropped or damaged in any way, and
 - f. When the product exhibits a distinct change in performance – this indicates a need for service.
21. Replacement Parts – When replacement parts are required, be sure the service technician has used replacement parts specified by the manufacturer or have the same characteristics as the original part. Unauthorized substitutions may result in fire, electric shock, or other hazards.
22. Safety Check – Upon completion of any service or repairs to this product, ask the service technician to perform safety checks to determine that the product is in proper operating condition.
23. Wall or Ceiling Mounting – The product should be mounted to a wall or ceiling only as recommended by the manufacturer.
24. Heat – The product should be situated away from heat sources such as radiators, heat registers, stoves, or other products (including amplifiers) that produce heat.

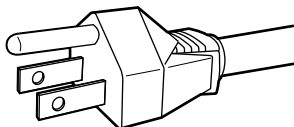

AC POLARIZED PLUG

TABLE OF CONTENTS

IMPORTANT SAFEGUARDS	1
Caution Concerning the Lamp Replacement	1
Caution Concerning the Lamp Unit.....	1
Cautions Concerning the Setup of the Projector	1
Notes on Operation.....	1
FEATURES	2
ACCESSORIES	3
PROJECTOR LAYOUT AND FUNCTIONAL OVERVIEW	4
Front and Top View	4
Rear and Terminals View	5
Bottom View.....	5
Remote Controller.....	6
Preparing the Remote Controller.....	7
Remote Controller Operational Range	7
CONNECTION	8
Connection with AC Power Supply	8
Connection with Video Equipments	8
Connection with a HD-Video, Satellite, Cable Tuner or PC.....	9
Advanced Connection.....	9
INITIAL SETTING	10
Turning on the Power	10
Zooming and Focusing	10
Adjusting the Image Position	10
Adjusting the Height.....	11
Detail Focusing	11
Keystone Correction	12
INSTALLATION	13
Recommended Setting	13
Screen Size and Projection Distance (inch)	14
Screen Size and Projection Distance (m)	15
BASIC OPERATIONS	16
Turning on the Power	16
Selecting the Input Signal Source.....	16
Selecting the Aspect Mode	16
The Screen Images in a 16:9 screen	17
The Screen Images in a 4:3 screen	18
To Turn off the Power	19
OPERATIONS	20
Menu Structure	20
Using On-Screen Menu	21
Picture Adjust.....	21
Fine Menu.....	22
Setting.....	24
Display	25
Configuration	26
Trigger 2	27
Memory	28
Lamp Life and Replace Lamp.....	28
MAINTENANCE	30
Replacing Lamp Unit	30
Cleaning the Lens.....	31
Replacement Parts	31
Optional Accessories	31
TROUBLESHOOTING	32
ERROR MODE	32
ON SCREEN MESSAGE	33
SPECIFICATIONS	33
GLOSSARY	34
DIMENSIONS	35

IMPORTANT SAFEGUARDS

Caution Concerning the Lamp Replacement

There is potential glass particle hazard if the lamp ruptures.

Caution Concerning the Lamp Unit

There is a potential hazard of glass particle if the lamp ruptures.
In case of lamp rupture, contact your nearest Marantz Authorized Dealer or Service Center for a replacement.
See "Replacing Lamp Unit". (P.30)

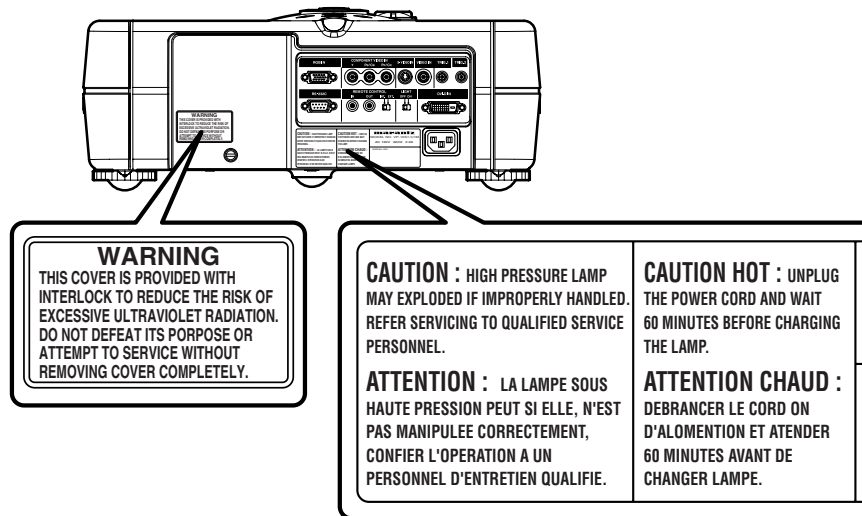

Caution Concerning the Setup of the Projector

For minimal servicing and to maintain high image quality, avoid humidity, dust and cigarette smoke.

When the projector is subjected to these environments, the lens and part of ventilation holes must be cleaned more often than usual. As long as the projector is properly maintained in this manner, use in these environments will not reduce the overall operation life. Please note that all internal cleaning must be performed by an Marantz Authorized Dealer, or Service Center.

- Do not expose the projector to extreme heat or cold.
Operating temperature: 41 °F to 95 °F (+5 °C to 35 °C)
Storage temperature: -4 °F to 140 °F (-20 °C to +60 °C)

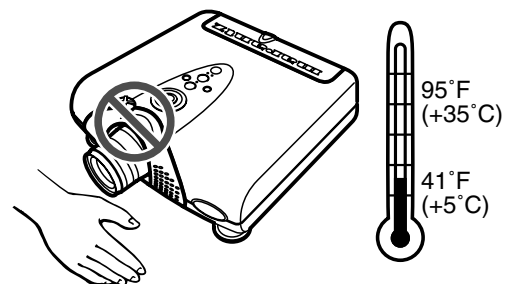

Notes on Operation

- The exhaust ventilative hole, the lamp cage cover and adjacent areas may get extremely hot during projector operation. To prevent injury, do not touch these areas until they have sufficiently cooled down.
- Allow at least 1 foot (30 cm) of space between the exhaust ventilative hole and the nearest wall or obstruction.
- If the cooling fan becomes obstructed, a protection device will automatically turn off the projector lamp. This does not indicate a malfunction. Remove the projector power cord from the wall outlet and wait at least 10 minutes. Then turn on the power by plugging the power cord back in. This will return the projector to the normal operating condition.

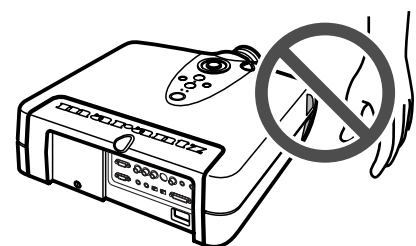

FEATURES

❖ Optics

- Texas Instruments DLP™ (Digital Light Processing) Technology
- 1280 x 720 DMD™ Panel
- 16 : 9 Aspect Ratio
- Custom Optics Developed by Minolta
- 2600 : 1 Contrast Ratio
- 700 ANSI Lumens Brightness
- Brightness Uniformity : 90 %
- No Halo Effect
- Lens Up/Down Shift Construction
- Dust Free Optics Sealing
- No Light Leakage (Double Seals Cabinet Structure)
- Extremely Quite (Noise Cancel Duct Construction, Ceiling Color Wheel Motor)
- Long Life Lamp (Average 2000 Hours)
- Double Shrink Seal Lamp Structure Minimizes Burst Ratio

❖ Electronics & Software

- Full Digital Device
- 3 Faroudja Chips Inside (Decoder, Doubler, and Enhancer)
- 3-2 Pull Down
- 10-Bit Digital Gamma Processing
- Horizontal/Vertical Keystone Correction
- 480p, 720p, 1080i adapted
- Four Picture Modes: Theater, Standard, Dynamic, User
- Twelve Picture Memories
- 4 Aspect Modes
- Fine Menu
- Three Color Temperatures (5250K/6500K/9000K)
- Black Level Selection (0IRE/7.5IRE)
- Control through RS-232C
- Two trigger for powered Screen Control
- Ecology Lamp Mode
- Component Video Input

- **DLP, Digital Micromirror Device** and **DMD** are trademarks of Texas Instruments.
- “**DCDi**” is a trademark of Faroudja, a division of Sage Inc.
- All trademarked product names mentioned in this manual are the property of their respective companies.

Note: Pixel defects

DMD™ (Digital Micromirror Device™) is one of the most advanced technologies for consumer products. The DMD™ made by high precision technology, however some pixel defects may be found on the projected image. We are trying our best to control the quality in order to reduce the number of defective pixels. It is almost impossible to have zero pixel defects, even using the most advanced technology. This is not a problem only for Marantz, but all DLP™ projector manufactures. Therefore we have to note that the warranty does not cover the DMD™ for pixel defects. We appreciate your understandings.

Note: Lamp

SHP lamp is one of the most advanced technologies for consumer products. The lamp made by high precision technology, however some lamps might be failing before it reaches its life. And projector's brightness is getting darker along with accumulated lamp usage hours. We are trying our best to control the quality in order to reduce lamp failures. It is almost impossible to have zero failure, even using the most advanced technology. This is not a problem only for Marantz, but all projector manufactures. Therefore we have to note that the warranty does not cover the SHP lamp for lamp failures: explosion, and non-lighting except initial use. And also we have to note that the warranty does not cover the SHP lamp for lamp failures: flickering, and getting darker along with accumulated lamp usage hours. We appreciate your understandings.

ACCESSORIES

- Lens Cap x 1

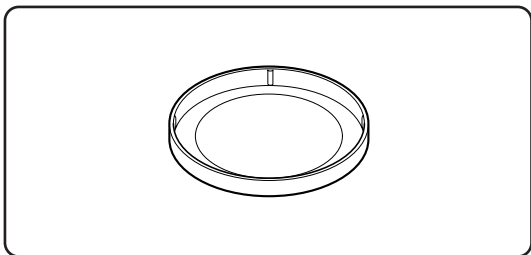

- AC Power Cord (Only for 125V) x 1

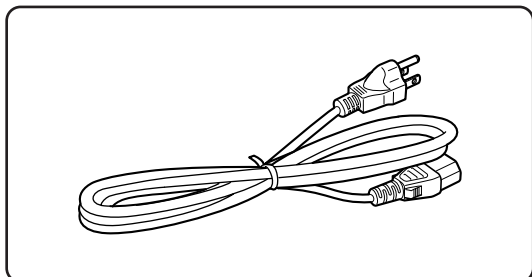

- Remote Controller x 1

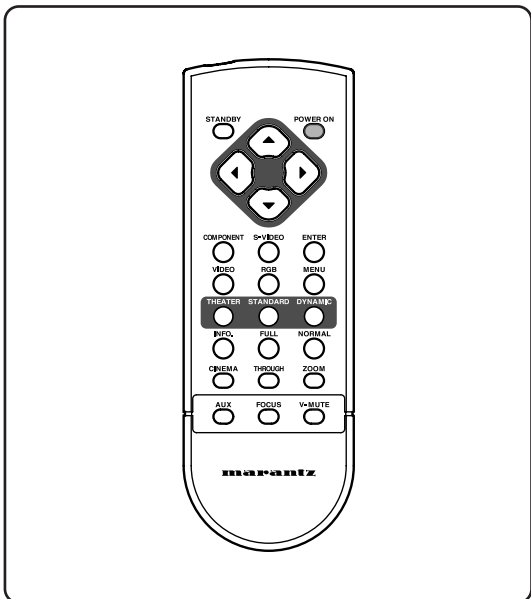

- Control Adapter Cable (Mini Jack to RCA) x 1

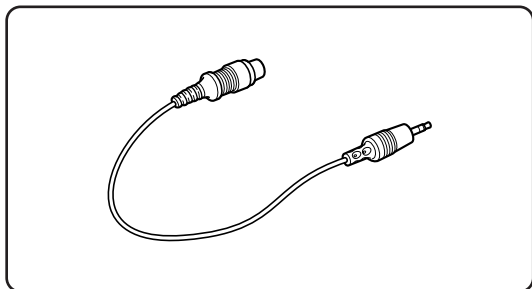

- AA Size Batteries x 2

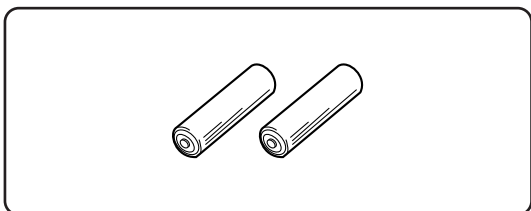

- User Guide x 1

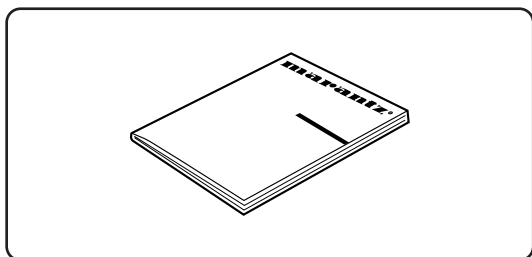

- Warranty Card (1 copy each for USA, CANADA)

PROJECTOR LAYOUT AND FUNCTIONAL OVERVIEW

Front and Top View

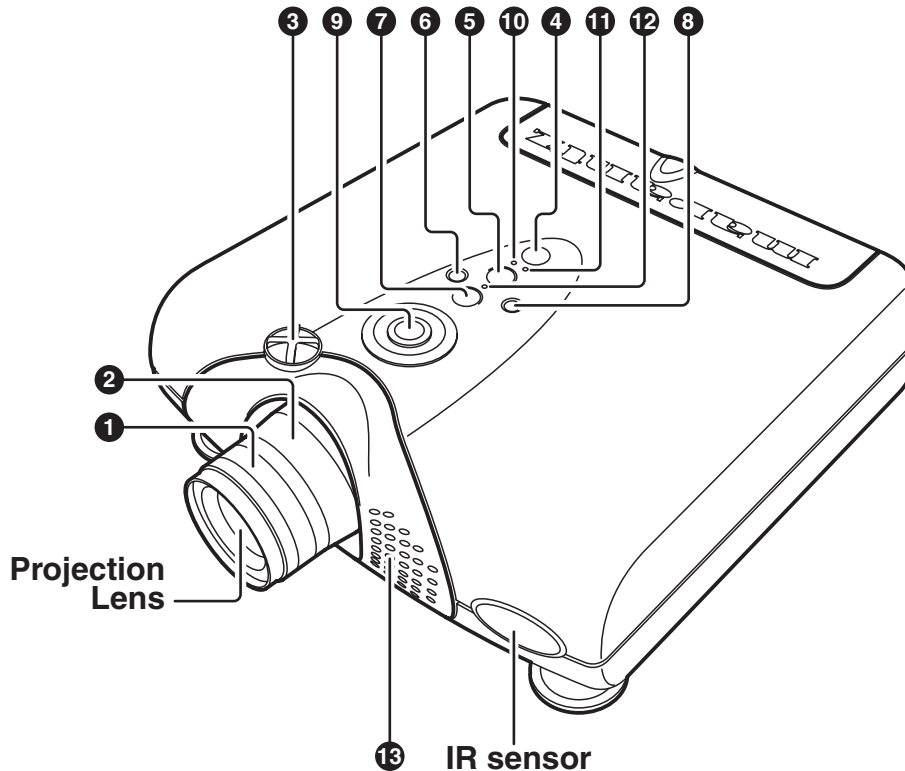

❶ Focus ring (➡ P.10)

Adjust the picture focus.

❷ Zoom ring (➡ P.10)

Adjust the size of the projected image.

❸ Lens Shift knob (➡ P.10)

Manually adjust the position of the image vertically.

❹ POWER key (➡ P.16)

Press to turn the projector ON or STANDBY mode.

❺ MENU key (➡ P.21)

Display the on-screen menu.

❻ ENTER key

Confirm "Reset All", "Reset Lamp Life", "New Lamp?".

❼ INPUT SELECT key (➡ P.16)

When the key is pressed, the unit toggles between COMPONENT, S-VIDEO, VIDEO, RGB and AUX inputs.

❽ FOCUS key (➡ P.11)

Display a focus pattern.

❾ The ▲/▼/◀/▶ keys

Control the MENU cursor.

❿ POWER ON indicator

Lights up when the power is turned on. Flashes while the projector goes into standby mode for about one minute.

⓫ STANDBY indicator

Lights up when the power is turned off.

⓬ WARNING/LAMP indicator

Flashes or lights up when something is wrong with the lamp cover, lamp, fan, or temperature inside the projector.

⓭ Ventilation holes

Notes:

- Do not place anything near the ventilation holes to avoid overheat inside the unit.
- Do not place your hand or objects near the ventilation holes; the air is coming out.

Rear and Terminals View

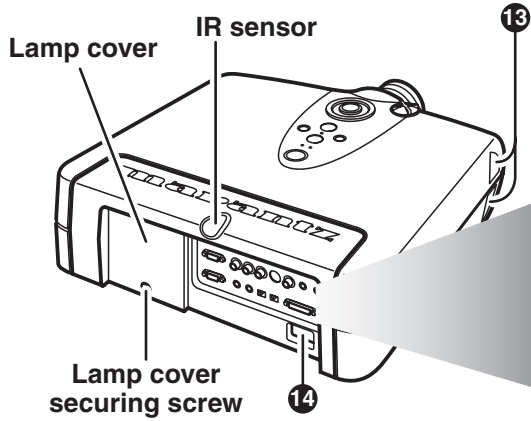

Terminals

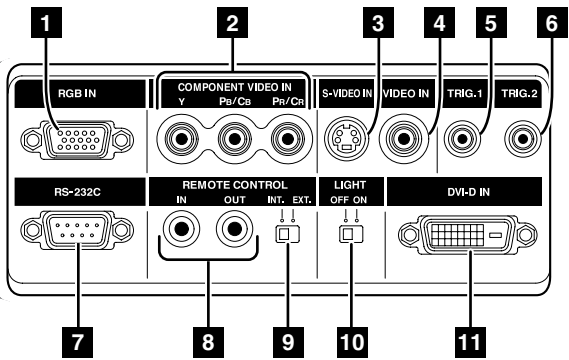

14 AC IN (P.8)
Connect the supplied AC power code.

❖ Terminals

1 RGB IN
Connect the analog RGB output from an IBM VGA or compatible equipment.

2 COMPONENT VIDEO IN
Y, Pb/Cb, Pr/Cr connectors.
Connect the COMPONENT VIDEO output from video equipment or an A/V processor/receiver with a component video output.

3 S-VIDEO IN
Connect the S-VIDEO output from a video equipment.

4 VIDEO IN
Connect the composite video output from a video equipment.

5 TRIG.1 (TRIGGER 1)
When the unit is turned on, 12V is output. When the unit is turned off, no voltage is output. This allows such as a powered up/down screen, whenever the projector is turned on or off.

Note:
To connect with external devices, use an ordinal 35mm mini-plug (mono) cable with attaching the supplied ferrite core.

6 TRIG.2 (TRIGGER 2)
Select ON or OFF at each aspect mode, such as Full, Normal, Zoom, and Through to control screen aspect ratio with powered up/down dual aspect ratio screen.

Notes:

- Do not use TRIG.1 and TRIG.2, as the power source.
- To connect with external devices, use an ordinal 35mm mini-plug (mono) cable with attaching the supplied ferrite core.

7 RS-232C
Connect the RS-232C of equipment for external control.

8 REMOTE CONTROL IN/OUT
By connecting this projector to another Marantz audio component using a supplied System Control cable, you can remotely operate the components as a single system.

- When connecting to component with a remote sensor (such as the SR9200, SR8200), be sure to connect the "REMOTE CONTROL IN" jack of this projector to the "REMOTE CONTROL OUT" jack of the component with the remote sensor.

- When connecting to component which is not equipped with a remote sensor, be sure to connect the component to the "REMOTE CONTROL OUT" jack of this projector.

9 REMOTE switch (EXT. / INT.)
When using this projector independently, set this switch to "INT.". When using this projector in a system with a Marantz DVD player or AV Receiver equipped with a remote sensor, set the switch to "EXT.".

10 LIGHT ON/OFF
Select ON : The terminal panel lights up.

11 DVI-D IN
Connect the digital RGB signal (TMDS compliant, single link only)
Note: To use the DVI-D terminal, please follow the cautions on page 9.

Bottom View

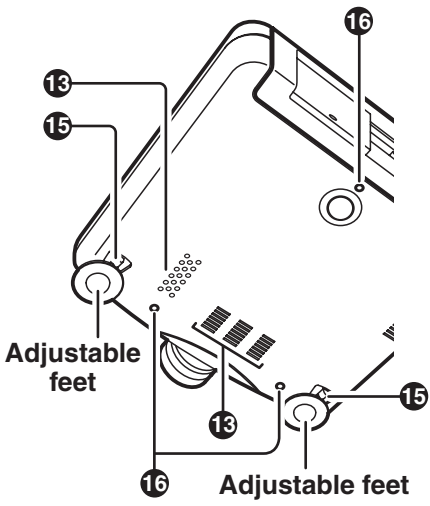

15 Adjustment lever (P.11)
Lift the projector and turn the adjustment lever right or left. The adjustable feet will extend from the projector. Then, release the lever, the adjustable feet is locked.

16 Screw holes for ceiling mount kit

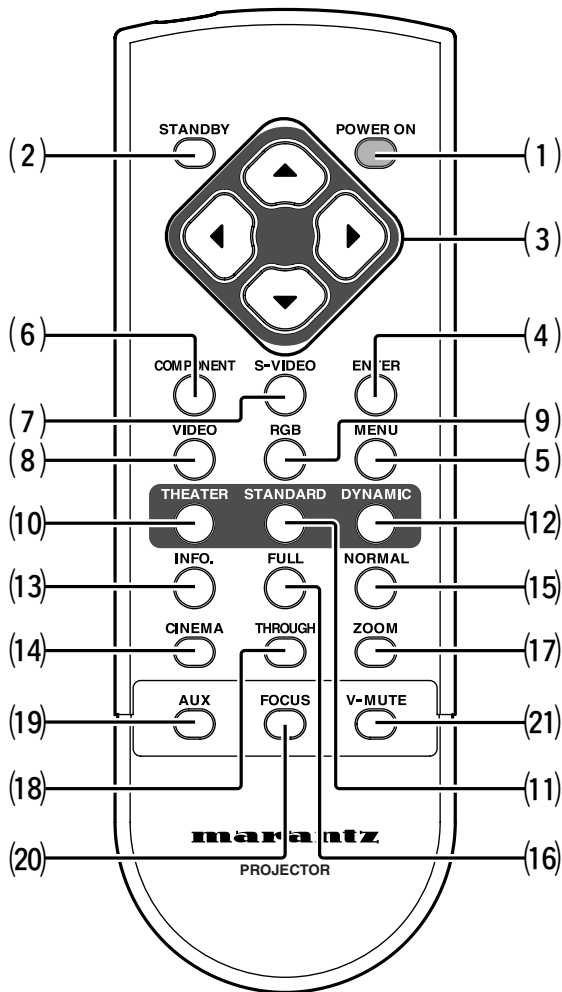

(1) POWER ON key (P.10)

Turn the projector on.

(2) STANDBY key (P.19)

Turn the projector off.

(3) ▲ / ▼ / ◀ / ▶ keys

Control the MENU cursor.

(4) ENTER key

Confirm "Reset All", "Reset Lamp Life", "New Lamp?".

(5) MENU key (P.21)

Display the on-screen menu.

(6) COMPONENT key (P.16)

Select the COMPONENT VIDEO IN signal.

(7) S-VIDEO key (P.16)

Select the S-VIDEO IN signal.

(8) VIDEO key (P.16)

Select the VIDEO IN signal.

(9) RGB key (P.16)

Select the RGB IN signal.

(10) THEATER key (P.28)

Select the Theater picture mode.

Theater mode is designed for high fidelity black appearance and is good for movie pictures.

When the key is pressed, the mode toggles Theater 1, Theater 2, Theater 3 and Theater Default.

(11) STANDARD key (P.28)

Select the STANDARD picture mode.

Standard mode is good for normal pictures.

When the key is pressed, the mode toggles Standard 1, Standard 2, Standard 3, and Standard Default.

(12) DYNAMIC key (P.28)

Select the Dynamic picture mode.

Dynamic mode is good for visually dynamic pictures.

When the key is pressed, the mode toggles Dynamic 1, Dynamic 2, Dynamic 3 and Dynamic Default.

(13) INFO. key (P.28)

Turn the information menu on or off.

(14) CINEMA key

Press to turn the CINEMA mode – auto 3-2 pull down mode – on or off.

(15) NORMAL key (P.16)

Select NORMAL mode from four aspect ratio modes.

(16) FULL key (P.16)

Select FULL mode from four aspect ratio modes.

(17) ZOOM key (P.16)

Select ZOOM mode from four aspect ratio modes.

(18) THROUGH key (P.16)

Select THROUGH mode from four aspect ratio modes.

(19) AUX key (P.16)

Select the DVI-D IN signal.

(20) FOCUS key (P.11)

Display a focus pattern.

(21) V-MUTE key

Turn the picture into black. Press again to resume.

Preparing the Remote Controller

1. Open the Battery cover.

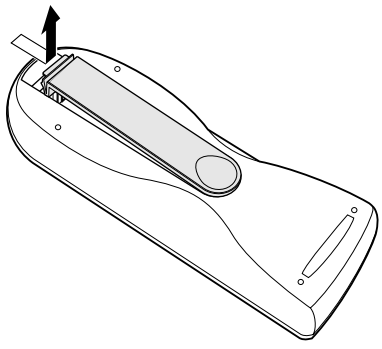

2. Insert two AA size batteries. Make sure the polarities match the + and - marks inside the battery compartment.

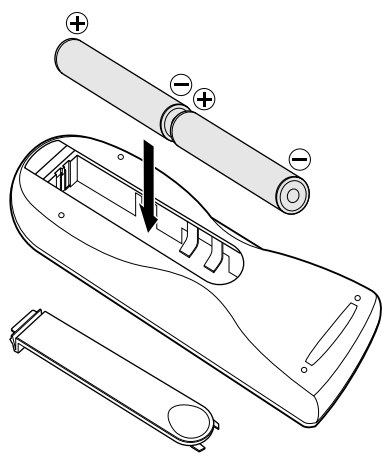

3. Close the battery cover.



CAUTION

- The available battery types are limited: manganese dry cell and alkaline dry cell.
- Do not mix different battery types.
- Do not mix old and new batteries.
- Only batteries of the same type are to be used.
- Remove exhausted batteries from the Remote Controller.
- Do not attempt to recharge non-rechargeable batteries.
- Do not use rechargeable batteries.
- Batteries are to be inserted with the correct polarity.
- The supply terminals are not to be short-circuited.
- Never throw batteries in a fire or attempt to open up its outer casing.
- If the user does not intend to use the Remote Controller for a long time, remove the batteries.
- Keep away from heat.
- The effect range of the Remote Controller is approximately 6m.
- Do not be subjected to strong shock.
- Do not be subjected to moisture. If the unit gets moistured, wipe it off immediately.
- The Remote Controller operation may not function if the projector's IR sensors are exposed to direct sun light or strong artificial light, or if there is an obstacle between the IR sensors and the Remote Controller.

Remote Controller Operational Range

Operate the remote controller within a distance of approximately 5m from the IR sensor (remote sensor) on the projector. Remote control operation may not be possible if the remote control unit's transmitter is not pointing in the direction of the remote sensor or if there is an obstruction between the transmitter and the remote sensor.

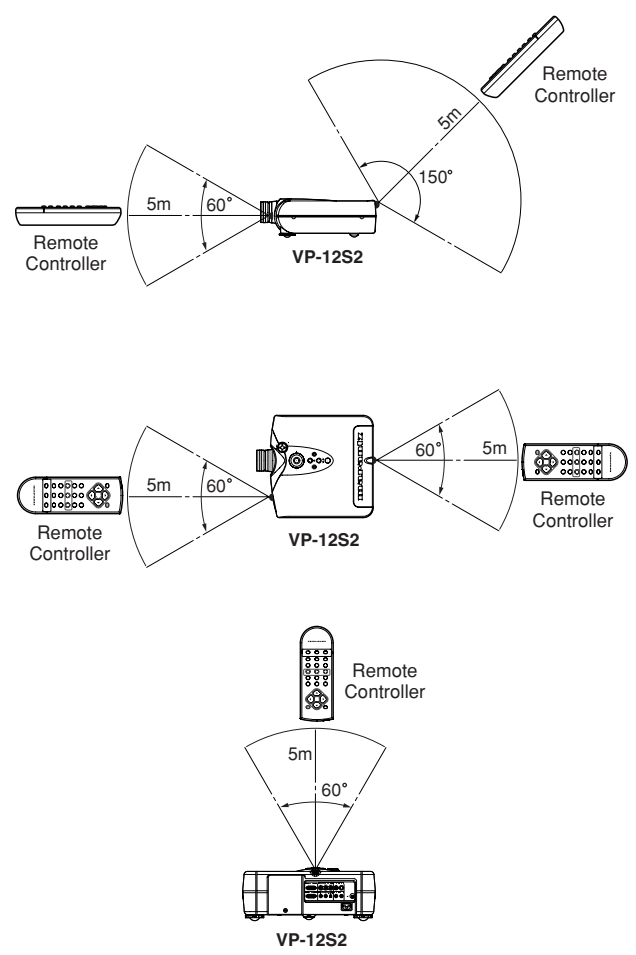

CONNECTION

❖ When making connections be sure to:

- Turn off all equipment before making any connections.
- Use the proper cables for each connection.
- Insert the plug properly. Any plugs that are not fully inserted often generate a noise.

❖ When pulling out a cable:

- Be sure to grab the plug, not the cable itself.

Connection with AC Power Supply

Connect the supplied AC power cord into the AC IN socket of the projector.

The STANDBY indicator lights up and the projector goes into the standby mode.

Note : Make sure the AC power cord is firmly connected into the AC IN socket.

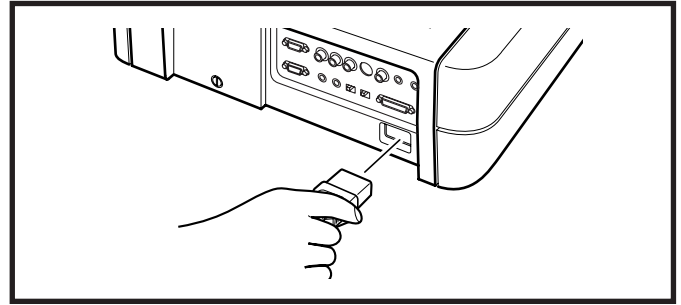

Connection with Video Equipments

You can connect this projector to a VCR, DVD player and other video equipment.

Connecting a video source using S-VIDEO IN and VIDEO IN terminals.

1. Connect one of the S-video cable to the S-VIDEO IN terminal, or one end of the video cable to the VIDEO IN terminal on the projector.
2. Connect the other end of the S-video cable or the video cable to the S-video output terminal or video output terminal of the video source.

Connecting with DVD player using COMPONENT VIDEO IN terminal

1. Connect each RCA connector of a component cable to the corresponding RCA terminals on the projector.
2. Connect the other end of the cable to the corresponding terminals on a DVD player.

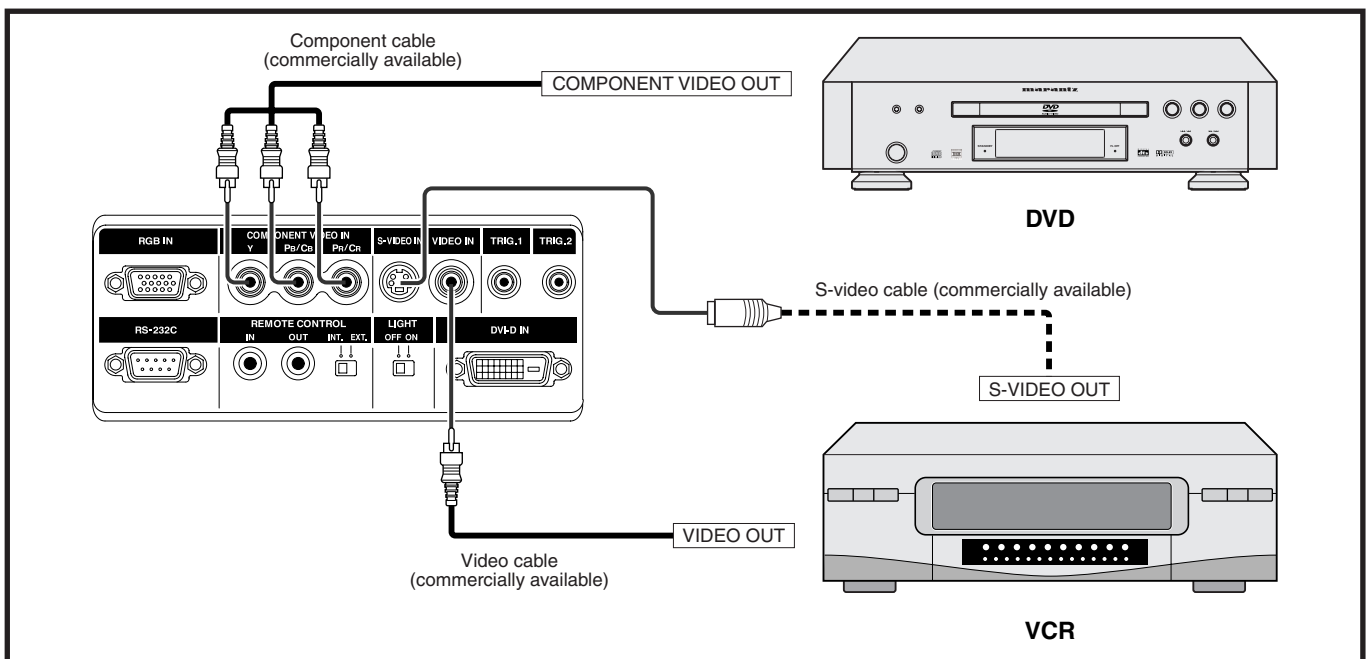

Connection with a HD-Video, Satellite, Cable Tuner or PC

You can connect this projector to HD-Video /PC using RGB IN port, or Satellite /Cable Tuner /PC using DVI-D IN port.

1. Connect one end of the RGB cable to the RGB IN port, or one end of the DVI-D cable to the DVI-D IN port on the projector.
2. Connect the other end to the corresponding port on a HD-Video, Satellite, Cable Tuner or personal computer.

Note : When projecting a video image from a device connected to the DVI-D terminal, follow the procedure below.

1. Turn on power of this unit. (☞ P.16)
2. Set the input video source to AUX (DVI-D input). (☞ P.16)
3. Turn on power of the device connected to the DVI-D terminal of the unit (i.e. DVD player).

If the procedure above is not followed, projected image may corrupt.

For the details of the DVI-D terminal on the device connected with the unit, see the instruction manual of the device.

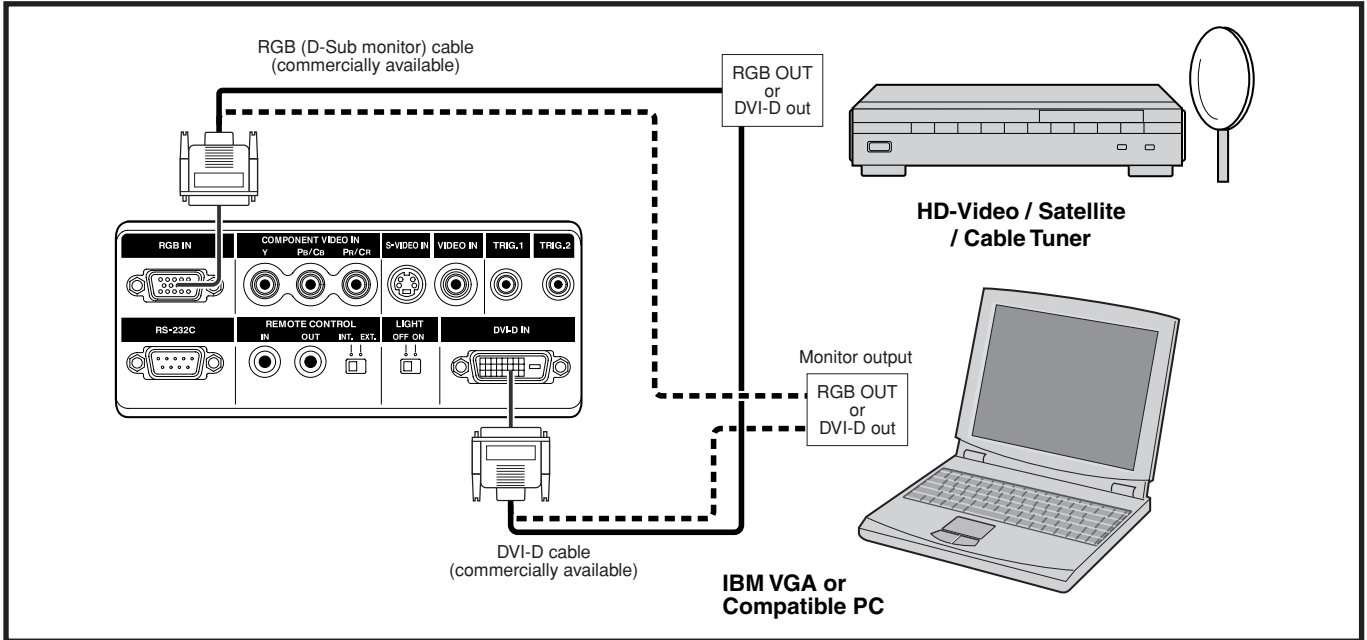

Advanced Connection

You can control total home theater system using PC or Marantz receiver equipment.

For installing below system, consult with Marantz authorized dealer.

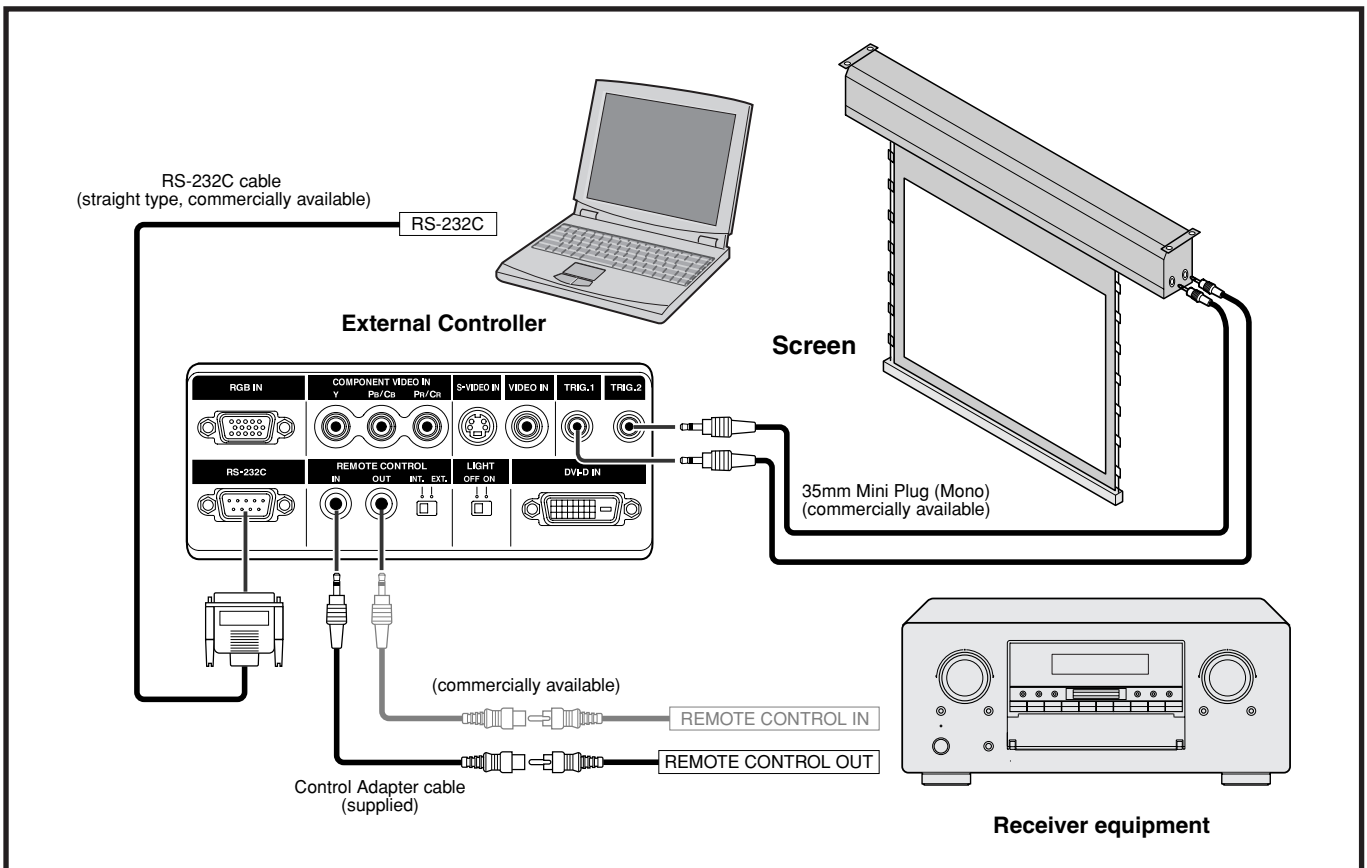

INITIAL SETTING

Turning on the Power

1. Connect the supplied AC power cord. (P.8)
2. Press the **POWER ON** key on the remote controller or the **POWER** key on the projector.
The POWER ON indicator lights up.

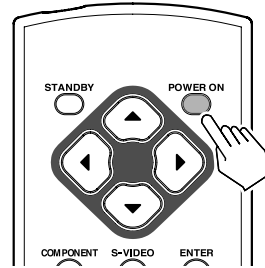
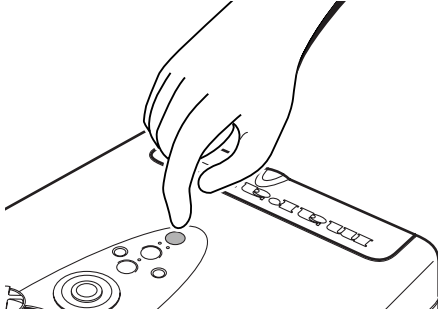

Zooming and Focusing

Project an image on the screen roughly at first.

1. Turn the **Zoom ring** and adjust to the desired size within the zoom range.
2. Turn the **Focus ring** until the image on the screen becomes clear.

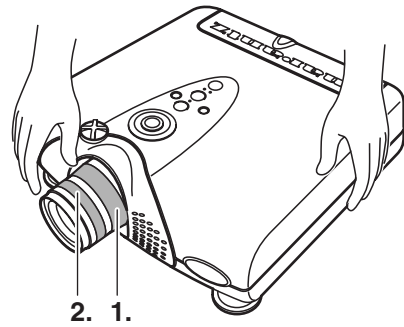

Adjusting the Image Position

You can adjust the image position with the Lens Shift knob.

- ❖ Turn the **Lens Shift knob to clockwise** : The image goes up.

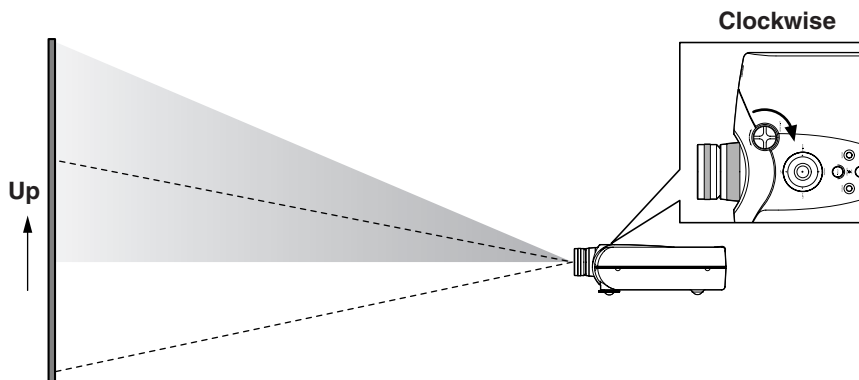

❖ Turn the Lens Shift knob to counterclockwise : The image goes down.

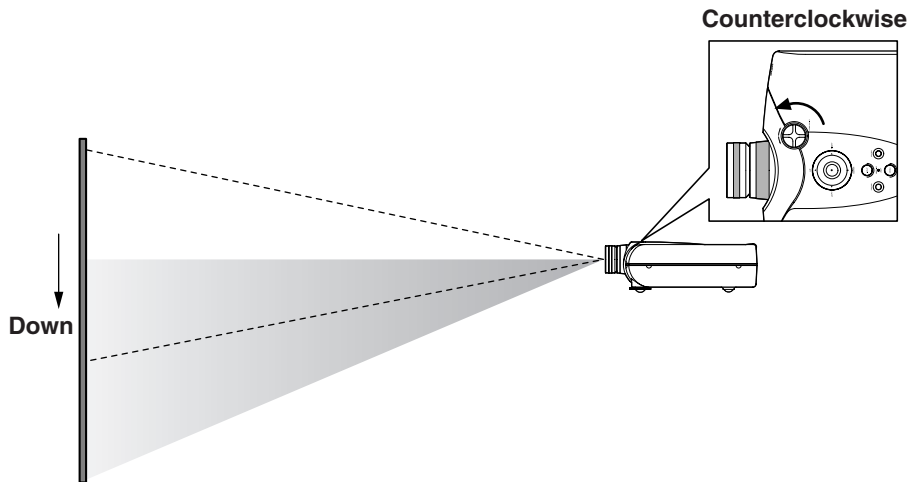

Adjusting the Height

Adjust the height of the image by raising the projector with the adjustment lever.

1. Operate the adjustment lever for releasing the adjustable feet. And lift the projector up carefully.

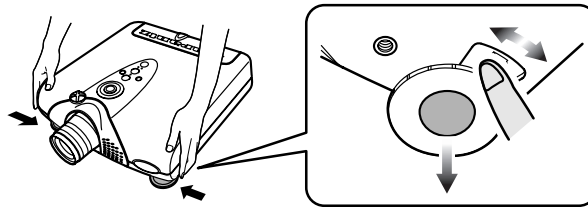

2. Remove your hands from the lever. Once the adjustable feet have locked in position, release the projector.
3. If the screen is at an angle, the adjusters can be used to adjust the angle of the image.

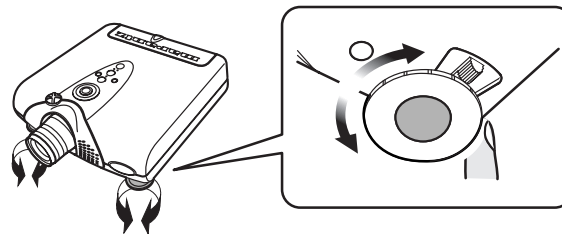

❖ Returning the Projector to its Initial Position

While holding the projector, press the foot releases and slowly lower the projector to its initial position.

Detail Focusing

You can strictly focus the image with focus pattern.

1. Press the **FOCUS** key to display the focus pattern.

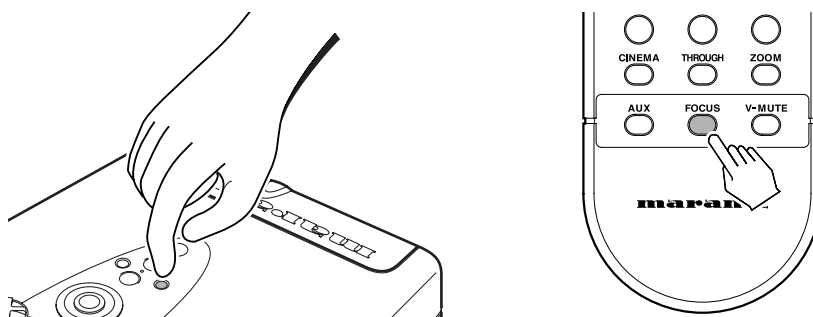

- Turn the **Focus ring** to make an adjustment.
Adjust the focus for the sharpest image possible to obtain, using focus pattern.

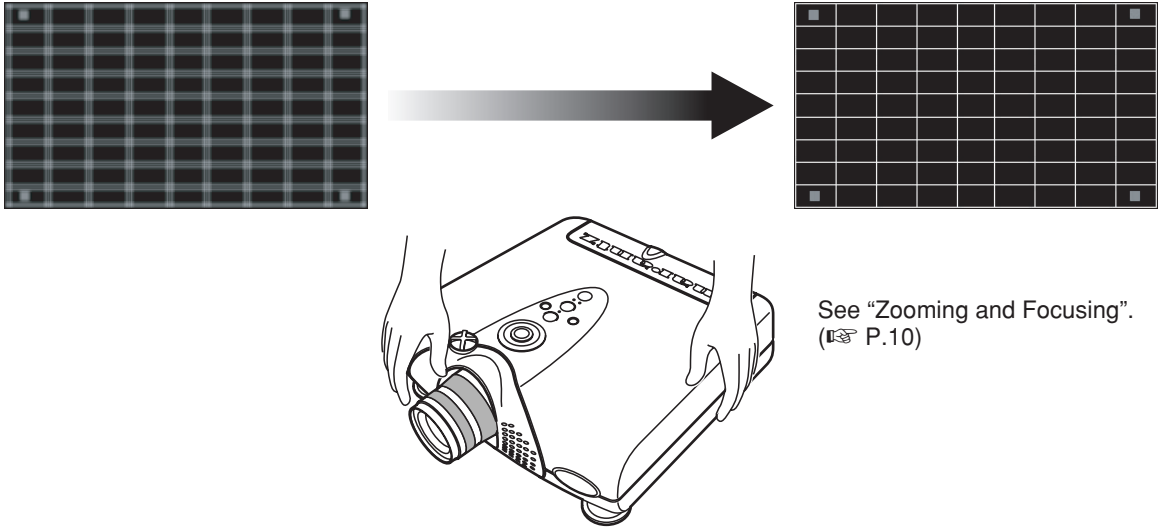

- Press the **FOCUS** key again to clear off the pattern.

Keystone Correction

When the projecting image is a trapezoid, correct it in Keystone-V and/or Keystone-H in the Display Menu.
See "Display". (P.25)

❖ Keystone-V (Electronic vertical keystone correction)

❖ Keystone-H (Electronic horizontal keystone correction)

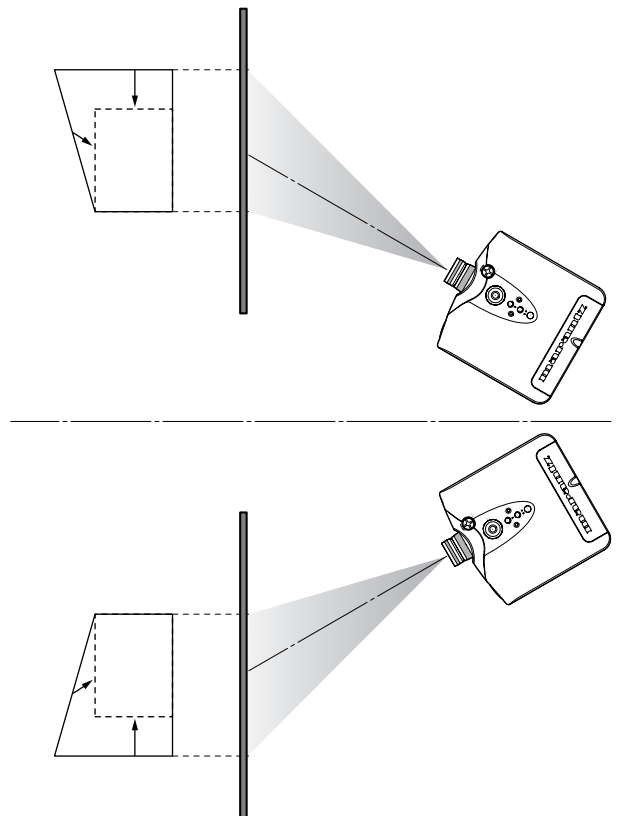
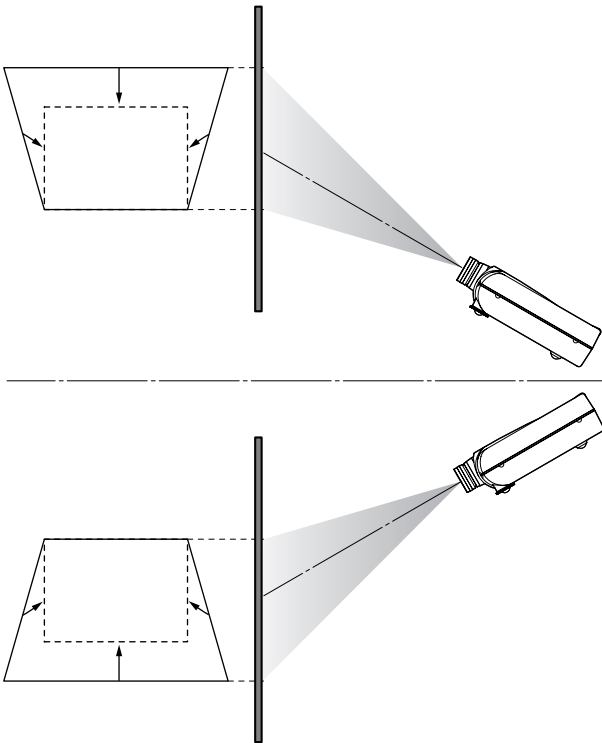

Note : Electronic horizontal keystone correction works properly when the lens shift position is at Full Up.

INSTALLATION

Recommended Setting

❖ Installing on a tabletop

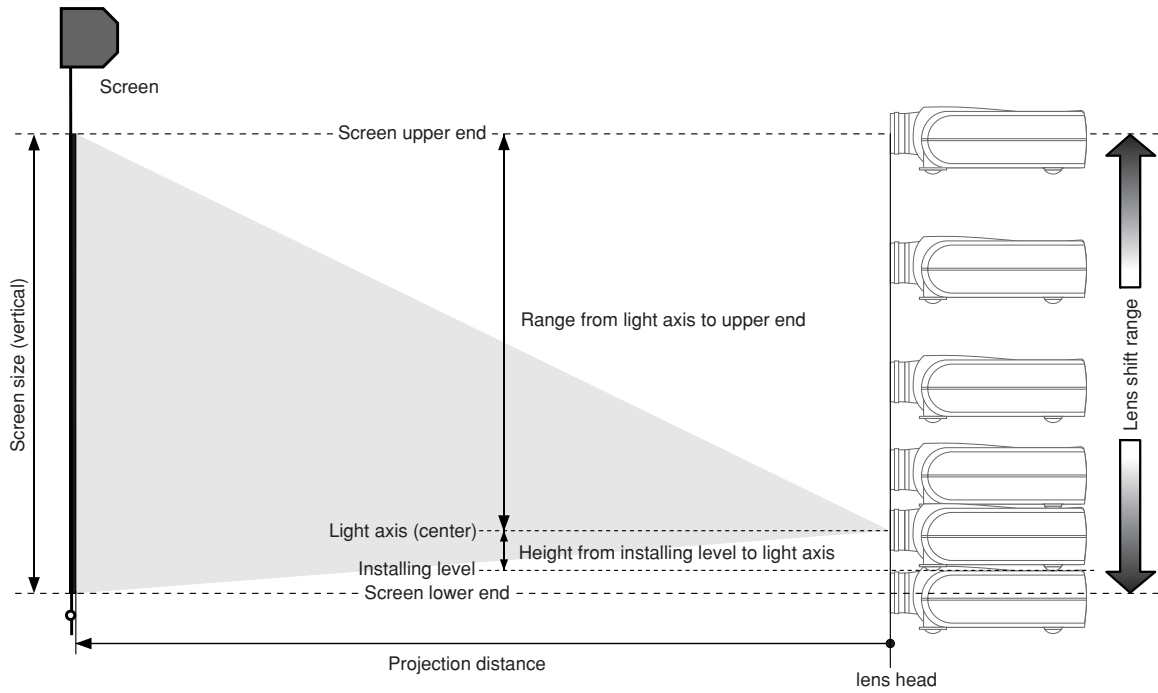

❖ Mounting on the ceiling

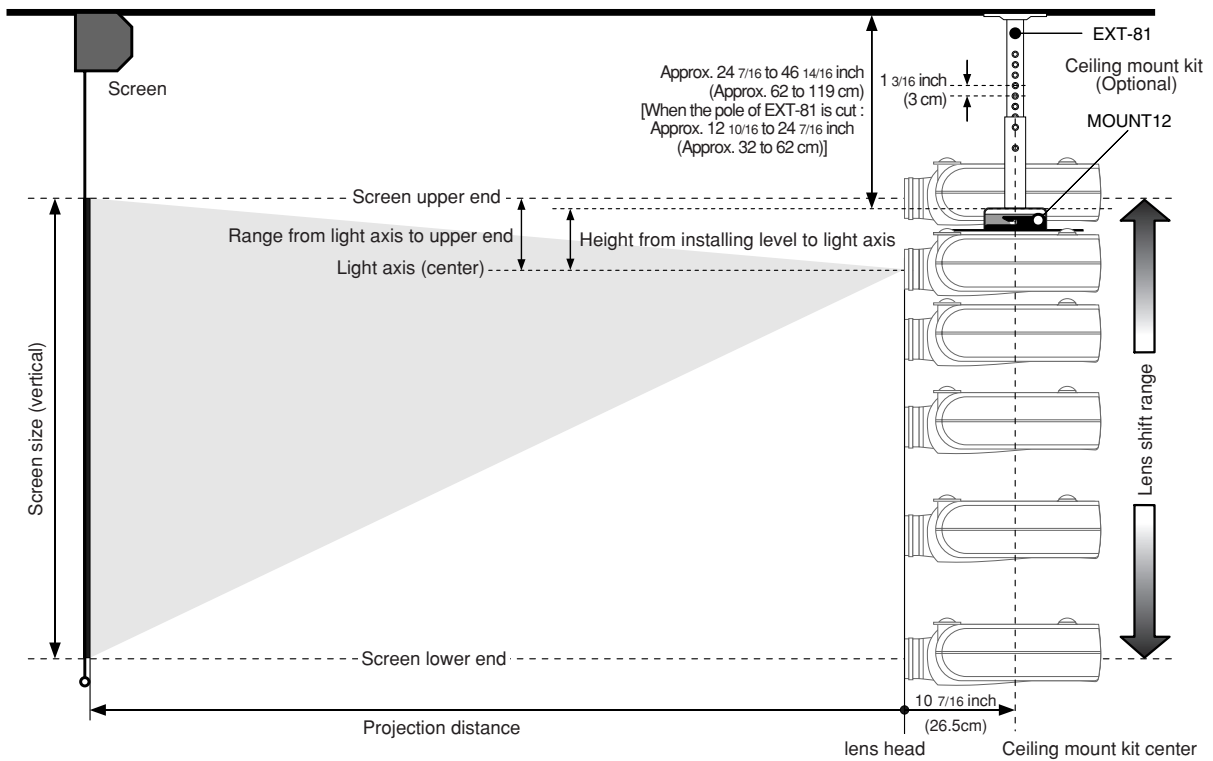

CAUTION

- For ceiling installation, consult with Marantz authorized dealer.
- Do not look into the lens when the projector is turned on. It could damage your eyesight.

Screen Size and Projection Distance (inch)

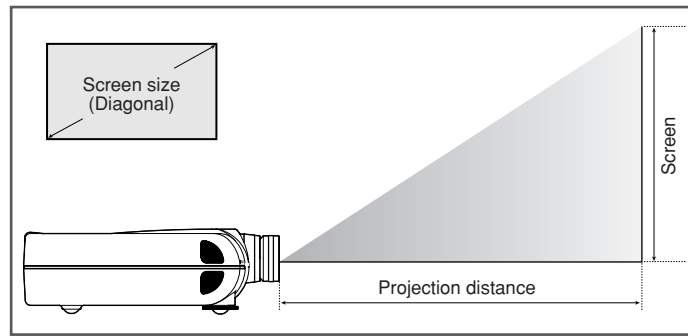

❖ 16 : 9 Screen

In case of displaying the 16:9 picture on the whole of the 16:9 screen.



16:9 Screen Size (1.77:1 Aspect Ratio)			Projection Distance	
Diagonal	Width	Height	Minimum	Maximum
inch	inch	inch	inch	inch
40	34 7/8	19 5/8	50 7/16	58 11/16
60	52 5/16	29 7/16	76 9/16	89
70	61	34 5/16	89 5/8	104 1/8
72	62 3/4	35 5/16	92 1/4	107 1/8
80	69 3/4	39 1/4	102 3/4	119 1/4
82	71 1/2	40 3/16	105 5/16	122 5/16
84	73 3/16	41 3/16	107 15/16	125 5/16
90	78 7/16	44 1/8	115 13/16	134 3/8
92	80 3/16	45 1/8	118 7/16	137 7/16
100	87 3/16	49	128 7/8	149 9/16
106	92 3/8	51 15/16	136 3/4	158 5/8
110	95 7/8	53 15/16	141 15/16	164 11/16
120	104 9/16	58 13/16	155	179 13/16
123	107 3/16	60 5/16	158 15/16	184 3/8
133	115 15/16	65 3/16	172	199 1/2
135	117 11/16	66 3/16	174 5/8	202 9/16
150	130 3/4	73 9/16	194 1/4	225 1/4
170	148 3/16	83 3/8	220 3/8	255 9/16
200	174 5/16	98 1/16	259 5/8	300 15/16
250	217 7/8	122 9/16	325	376 11/16

To calculate the installation measurement (unit : inch)
 Minimum = $(33.21 \times \text{Screen Size} - 47.6) \div 25.4$
 Maximum = $(38.46 \times \text{Screen Size} - 47.6) \div 25.4$
Note : Tolerance $\pm 5\%$

❖ 4 : 3 Screen

In case of displaying the 16:9 picture on the whole of the 4:3 screen.

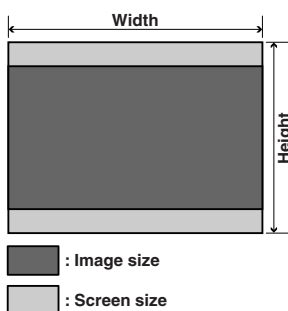

4:3 Screen Size (1.33:1 Aspect Ratio)			Projection Distance	
Diagonal	Width	Height	Minimum	Maximum
inch	inch	inch	inch	inch
40	32	24	46 1/8	53 3/4
60	48	36	70 1/8	81 9/16
70	56	42	82 1/8	95 7/16
72	57 5/8	43 3/16	84 9/16	98 3/16
80	64	48	94 3/16	109 5/16
84	67 3/16	50 3/8	98 15/16	114 7/8
90	72	54	106 3/16	123 1/4
100	80	60	118 3/16	137 1/8
110	88	66	130 3/16	151 1/16
120	96	72	142 3/16	164 15/16
150	120	90	178 3/16	206 5/8
170	136	102	202 3/16	234 7/16
180	144	108	214 3/16	248 3/8
200	160	120	238 3/16	276 3/16
250	200	150	298 1/4	345 11/16

To calculate the installation measurement (unit : inch)
 Minimum = $(30.49 \times \text{Screen Size} - 47.6) \times 1000 \div 25.4$
 Maximum = $(35.31 \times \text{Screen Size} - 47.6) \times 1000 \div 25.4$
Note : Tolerance $\pm 5\%$

Screen Size and Projection Distance (m)

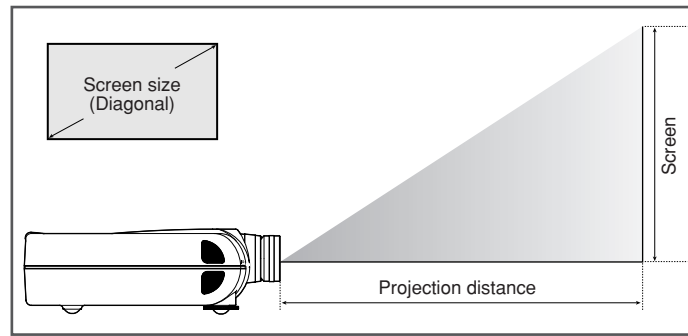

❖ 16 : 9 Screen

In case of displaying the 16:9 picture on the whole of the 16:9 screen.

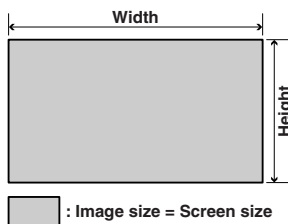

16:9 Screen Size (1.77:1 Aspect Ratio)			Projection Distance	
Diagonal	Width	Height	Minimum	Maximum
inch	mm	mm	m	m
40	886	498	1.28	1.49
60	1328	747	1.95	2.26
70	1550	872	2.28	2.64
72	1594	897	2.34	2.72
80	1771	996	2.61	3.03
82	1815	1021	2.68	3.11
84	1860	1046	2.74	3.18
90	1992	1121	2.94	3.41
92	2037	1146	3.01	3.49
100	2214	1245	3.27	3.80
106	2347	1320	3.47	4.03
110	2435	1370	3.61	4.18
120	2657	1494	3.94	4.57
123	2723	1532	4.04	4.68
133	2944	1656	4.37	5.07
135	2989	1681	4.44	5.14
150	3321	1868	4.93	5.72
170	3763	2117	5.60	6.49
200	4428	2491	6.59	7.64
250	5535	3113	8.25	9.57

To calculate the installation measurement (unit : m)
 Minimum = $(33.21 \times \text{Screen Size} - 47.6) \div 1000$
 Maximum = $(38.46 \times \text{Screen Size} - 47.6) \div 1000$
Note : Tolerance $\pm 5\%$

❖ 4 : 3 Screen

In case of displaying the 16:9 picture on the whole of the 4:3 screen.

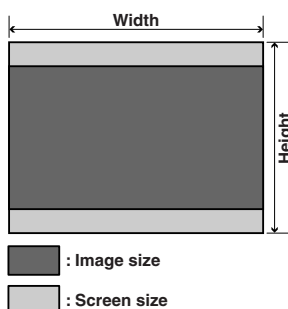

4:3 Screen Size (1.33:1 Aspect Ratio)			Projection Distance	
Diagonal	Width	Height	Minimum	Maximum
inch	mm	mm	m	m
40	813	610	1.17	1.36
60	1219	914	1.78	2.07
70	1422	1067	2.09	2.42
72	1463	1097	2.15	2.49
80	1626	1219	2.39	2.78
84	1707	1280	2.51	2.92
90	1829	1372	2.70	3.13
100	2032	1524	3.00	3.48
110	2235	1676	3.31	3.84
120	2438	1829	3.61	4.19
150	3048	2286	4.53	5.25
170	3454	2591	5.14	5.96
180	3658	2743	5.44	6.31
200	4064	3048	6.05	7.01
250	5080	3810	7.57	8.78

To calculate the installation measurement (unit : m)
 Minimum = $(30.49 \times \text{Screen Size} - 47.6) \div 1000$
 Maximum = $(35.31 \times \text{Screen Size} - 47.6) \div 1000$
Note : Tolerance $\pm 5\%$

BASIC OPERATIONS

Turning on the Power

Press the **POWER ON** key on the remote controller or the **POWER** key on the projector.

The POWER ON indicator lights up.

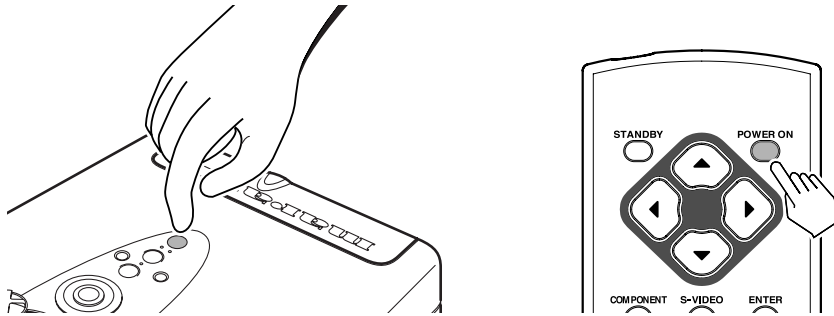

Selecting the Input Signal Source

Switch to the equipment connected to the projector.

Press the **INPUT SELECT** key on the projector or the **COMPONENT** key, **S-VIDEO** key, **VIDEO** key, **RGB** key or **AUX** key on the remote controller.

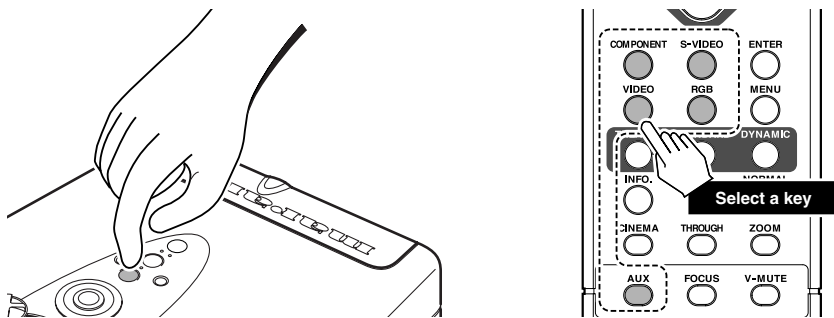

Selecting the Aspect Mode

You can select 4 kinds of ASPECT mode using remote controller.

Press the **FULL** key, **NORMAL** key, **ZOOM** key, or **THROUGH** key on the remote controller.

You can select the mode using on-screen menu, too.

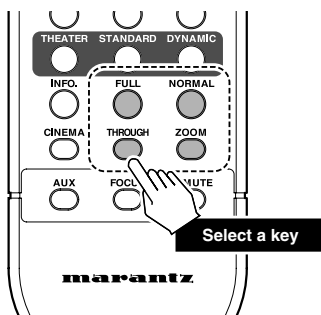

The Screen Images in a 16:9 screen

- Press the **ZOOM** key, the **NORMAL** key or the **FULL** key on the remote controller for the 4:3 aspect ratio video source.
 - Press the **FULL** key on the remote controller for 16:9 aspect ratio video source, such as 1080i, 1035i, and 720p video systems.
 - Press the **FULL** key on the remote controller for the squeezed video source.
- See "Setting". (P.24)

❖ Original Source Image

16 : 9 video source

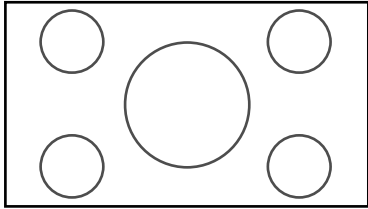

4 : 3 video source

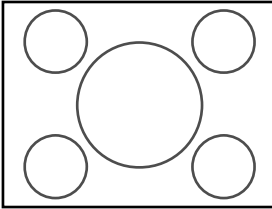

❖ Full mode

The 16:9 squeezed image is displayed with the correct aspect.

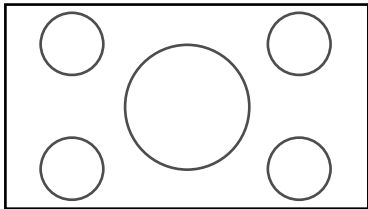

The 4:3 image is enlarged horizontally.

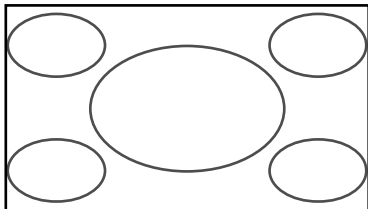

❖ Normal mode

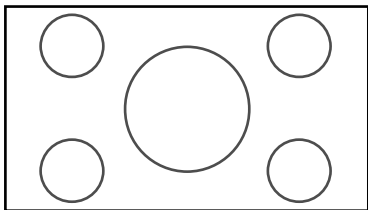

The picture in normal ratio 4:3 is displayed.

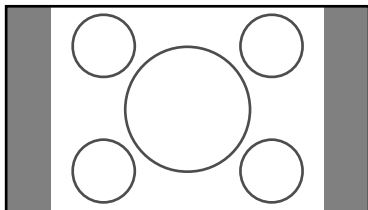

❖ Zoom mode

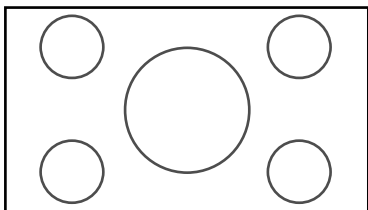

The picture in normal ratio 4:3 is enlarged vertically and horizontally (with same ratio) to the screen size

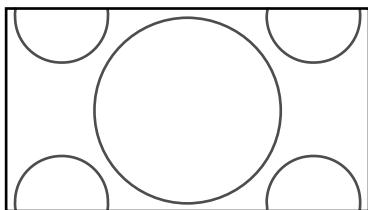

❖ Through mode

It shows an image when the video source has the same resolution to RGB/video signal with 720 or less vertical pixel number.

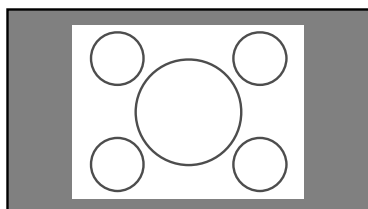
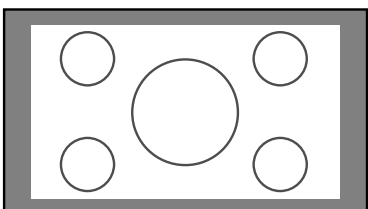

The Screen Images in a 4:3 screen

- Press the **ZOOM** key, the **NORMAL** key or the **FULL** key on the remote controller for the 4:3 aspect ratio video source.
 - Press the **FULL** key on the remote controller for 16:9 aspect ratio video source, such as 1080i, 1035i, and 720p video systems.
 - Press the **FULL** key on the remote controller for the squeezed video source.
- See "Setting". (P.24)

❖ Original Source Image

16 : 9 video source

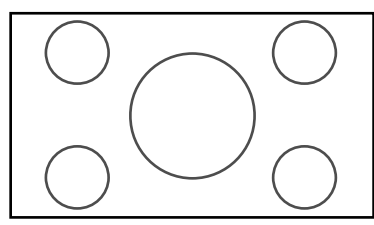

4 : 3 video source

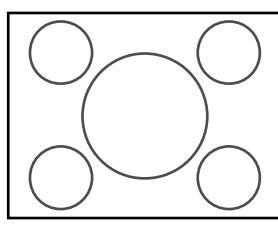

❖ Full mode

The 16:9 squeezed image is displayed with the correct aspect.

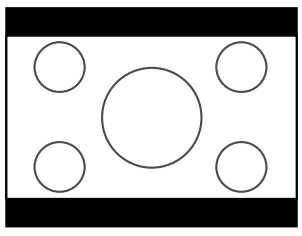

The 4:3 image is enlarged horizontally.

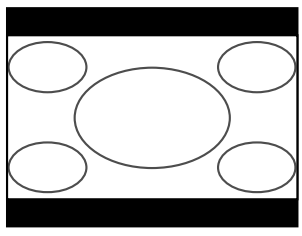

❖ Normal mode

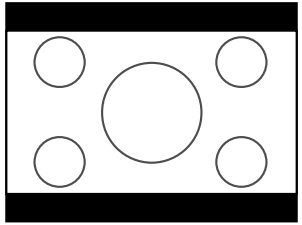

The picture in normal ratio 4:3 is displayed.

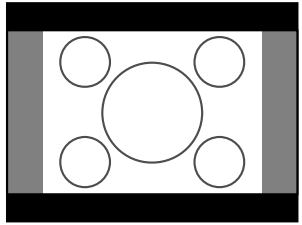

❖ Zoom mode

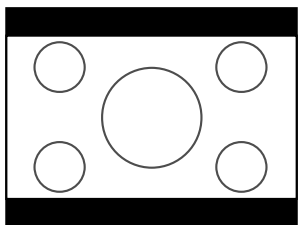

The picture in normal ratio 4:3 is enlarged vertically and horizontally (with same ratio) to the screen size

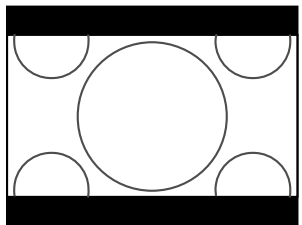

❖ Through mode

It shows an image when the video source has the same resolution to RGB/video signal with 720 or less vertical pixel number.

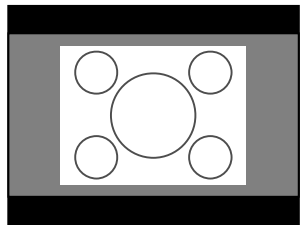
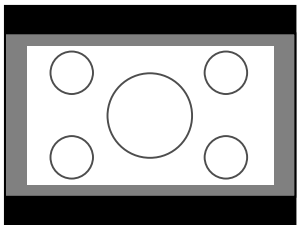

To Turn off the Power

1. Press the **STANDBY** key on the remote controller or the **POWER** key on the projector.
2. The fan continues to run for a while to reduce internal heat. The **POWER ON** indicator flashes in blue and no key will be active. After about one minute of cooling has been done, the unit turns off and the **STANDBY** indicator lights up.

Notice : Do not pull out the AC power cord until the projector turns in standby mode.

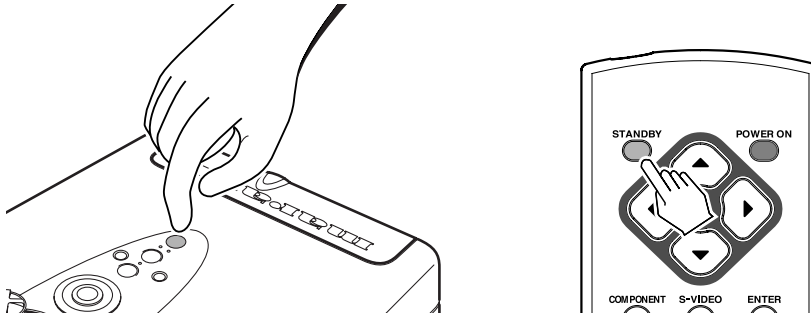

Notice :

- Do not pull out the power cord suddenly in the state of "POWER ON." It can cause a breakdown.
- When a **WARNING** indicator lit up or blinks in red, pull out the AC power cord after checking that the fan has stopped.
- The projector will not be turned on if the **POWER ON** key on the remote controller or the **POWER** key on the projector is pressed immediately after turning off. Press the **POWER ON** key on the remote controller or **POWER** key on the projector after the projector turns into standby mode.

OPERATIONS

Menu Structure

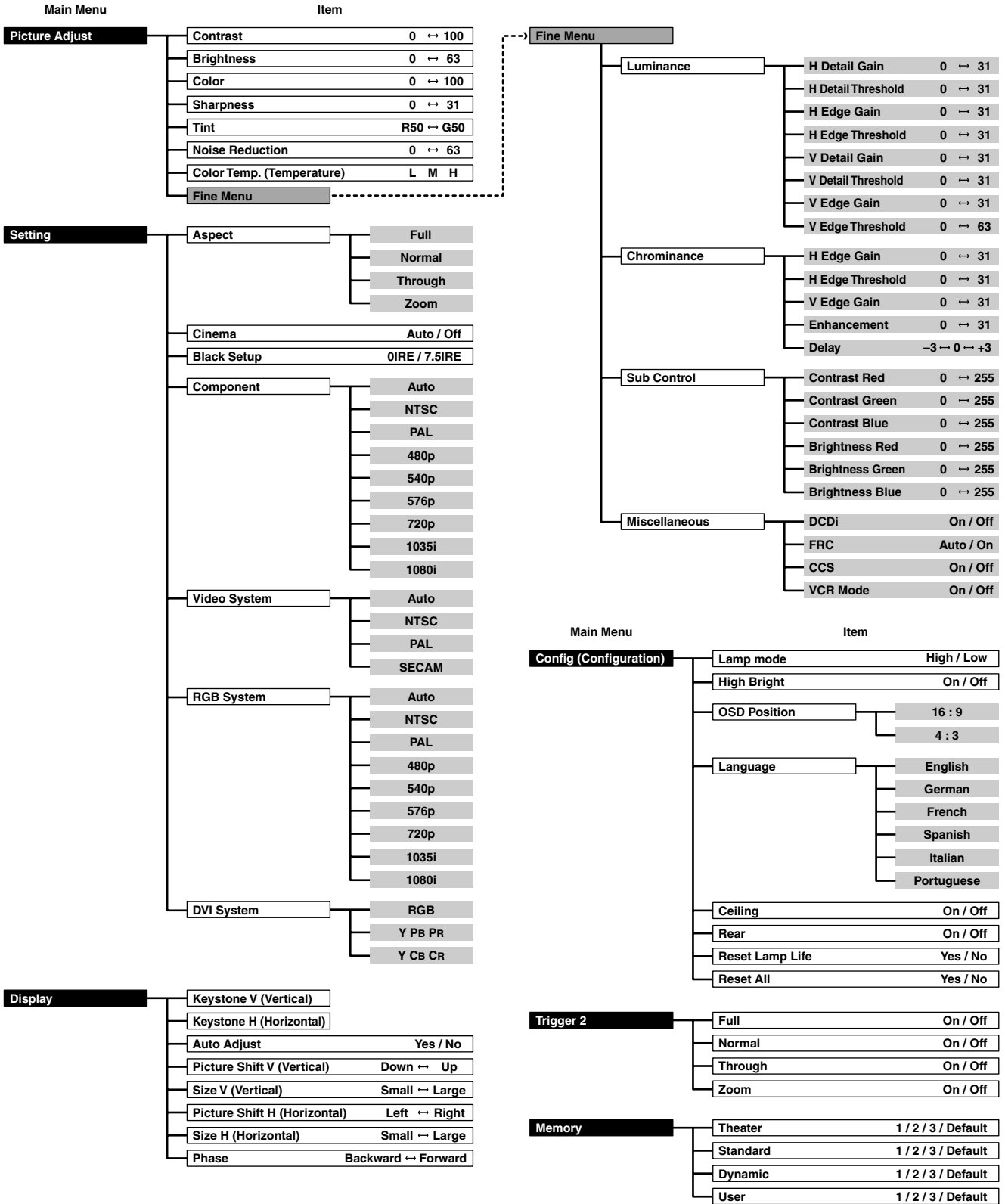

Using On-Screen Menu

Refer to the on-screen menu for making various adjustments and settings. (P.20)

1. Press the **MENU** key. The MENU appears.

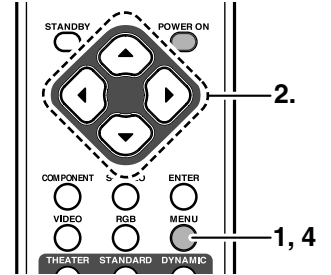
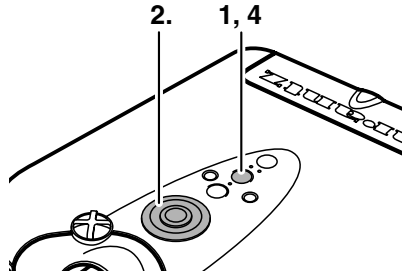
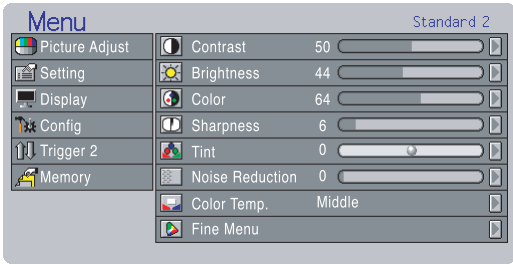

2. Use ▲/▼/◀/▶ keys to select a menu item.
3. Make adjustments in Picture Adjust, Setting, Display, Configuration, Trigger2, or Memory.
4. Press the **MENU** key to exit. The MENU disappears.

Picture Adjust

Adjust the picture to suit own preference by using the Picture Adjust feature.

❖ For a video signal input, the following adjustments can be made:

Item	Adjustments
Contrast	0 ←————→ 100
	Weak Strong
Brightness	0 ←————→ 63
	Dark Bright
Color	0 ←————→ 100
	Light Deep
Sharpness	0 ←————→ 31
	Soft Sharp
Tint	R50 ←————→ G50
	Purple Green
Noise Reduction	0 ←————→ 63
	Weak Strong
Color Temp. (Color Temperature)	L M H
	Red Blue

NOTE:

- You cannot adjust Tint in Component signal (YCbCr/YPbPr) or PAL format signal.
- If User Memory is set to default, Picture Adjust cannot be selected. To select Picture Adjust, set User Memory to either 1 to 3.
See "Memory". (P.28)

❖ Setting the Picture Adjust Menu

1. Use ◀/▶ key to adjust.
2. Use ▲ key to go back to the menu item.

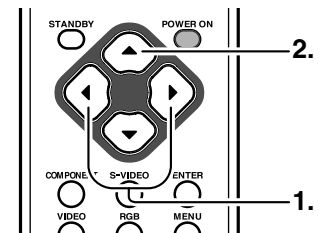
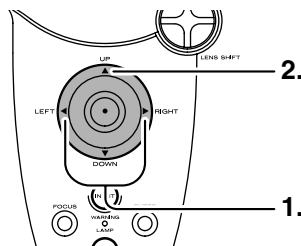

❖ Contrast



❖ Color Temp. (Temperature)

- H : Make white color bluer.
- M : Make white color less blue. This setting is approximately 6500 Kelvin.
- L : Make white color redder.



Fine Menu

By adjusting this Fine Menu, you can make fine picture adjustment.

Note : There are some parameters can not adjust according to input signal.

❖ Luminance

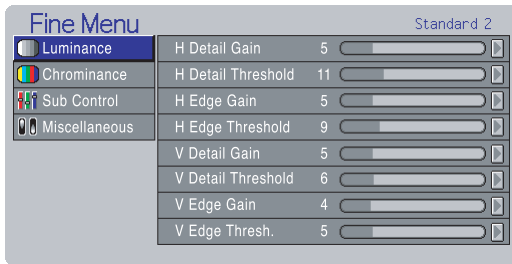

Item	Adjustments
H Detail Gain	0 ↔ 31
H Detail Threshold	0 ↔ 31
H Edge Gain	0 ↔ 31
H Edge Threshold	0 ↔ 31
V Detail Gain	0 ↔ 31
V Detail Threshold	0 ↔ 31
V Edge Gain	0 ↔ 31
V Edge Threshold	0 ↔ 63

H Detail Gain (Horizontal Detail Processing Gain)

: This menu allows the users to set the horizontal detail processing gain.

H Detail Threshold (Horizontal Detail processing Threshold)

: This menu allows the users to set the lower threshold for horizontal detail processing.

H Edge Gain (Horizontal Large Edge Enhancement Gain)

: This menu allows the users to set the horizontal large edge enhancement.

H Edge Threshold (Horizontal Large Edge Enhancement Threshold)

: This menu allows the users to set the lower threshold for horizontal large edge enhancement.

V Detail Gain (Vertical Detail Processing Gain)

: This menu allows the users to set the vertical detail processing gain.

V Detail Threshold (Vertical Detail Processing Threshold)

: This menu allows the users to set the lower threshold for vertical detail processing.

V Edge Gain (Vertical Large Edge Enhancement Gain)

: This menu allows the users to set the vertical large edge enhancement.

V Edge Threshold (Vertical Large Edge Enhancement Threshold)

: This menu allows the users to set the lower threshold for vertical large edge enhancement.

Note : If it is hard to see the effect, make the sharpness higher and adjust it.

❖ Chrominance

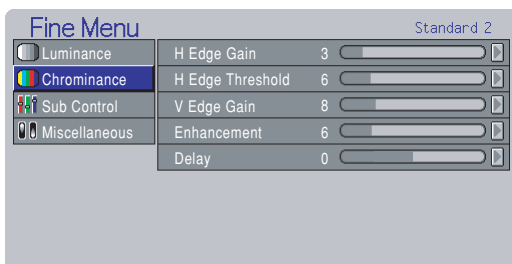

Item	Adjustments
H Edge Gain	0 ↔ 31
H Edge Threshold	0 ↔ 31
V Edge Gain	0 ↔ 31
Enhancement	0 ↔ 31
Delay	-3 ↔ 0 ↔ +3

H Edge Gain (Horizontal Large Edge Enhancement Gain)

: This menu allows the users to set the horizontal large edge enhancement.

H Edge Threshold (Horizontal Large Edge Enhancement Threshold)

: This menu allows the user to set the lower threshold for horizontal large edge enhancement.

V Edge Gain (Vertical Large Edge Enhancement Gain)

: This menu allows the users to set the vertical large edge enhancement.

Enhancement (Enhancer Gain)

: This menu allows the users to set the over all enhancement level.

Delay

: This menu allows the users to set the delay.

❖ Sub Control

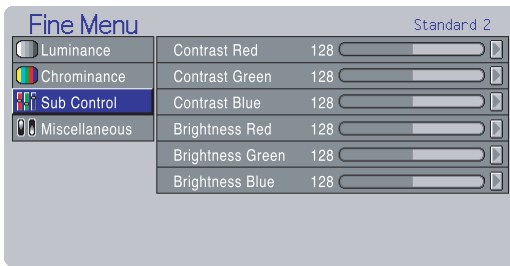

Item	Adjustments
Contrast Red	0 ← → 255
Contrast Green	0 ← → 255
Contrast Blue	0 ← → 255
Brightness Red	0 ← → 255
Brightness Green	0 ← → 255
Brightness Blue	0 ← → 255

Contrast Red

: This menu allows the users to set the contrast for red.

Contrast Green

: This menu allows the users to set the contrast for green.

Contrast Blue

: This menu allows the users to set the contrast for blue.

Brightness Red

: This menu allows the users to set the brightness for red.

Brightness Green

: This menu allows the users to set the brightness for green.

Brightness Blue

: This menu allows the users to set the brightness for blue.

❖ Miscellaneous

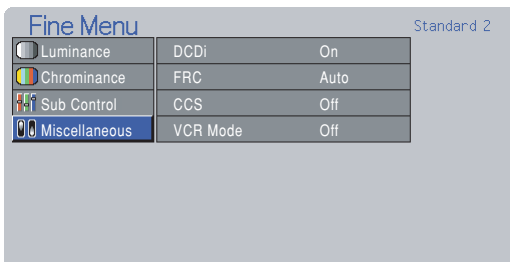

Item	Adjustments
DCDi	On ← → Off
FRC	Auto ← → On
CCS	On ← → Off
VCR Mode	On ← → Off

DCDi

: This menu allows the users to control DCDi.

FRC (Frame Rate Conversion)

Auto : Frame Rate Conversion function is basically off. However FRC turns on automatically depending on vertical frequency of input signal.

ON : Frame Rate Conversion function is "ON". (60Hz fixed)

CCS (Cross Color Suppressor Function)

ON : Cross color suppressor enabled.

OFF : Cross color suppressor disabled. For like progressive scan DVD players, where most of the source material does not contain any cross color, use this mode.

VCR Mode

ON : A projector is forced into the intra-field only deinterlacing mode.

OFF : A projector is used with external field memories and operates in the full set of deinterlacing modes, i.e., motion adaptive video deinterlacing and full frame film source deinterlacing using 3:2 pulldown detection (2:2 pulldown for 625/50 sources).

Setting

The following settings can be made:

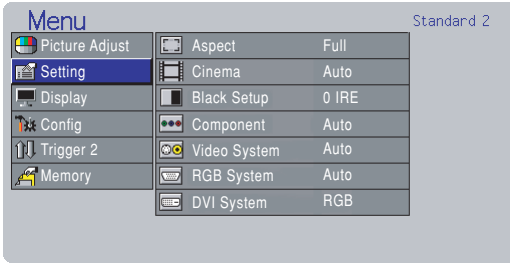

Aspect	Full, Normal, Through, Zoom
Cinema	Auto, Off Cinema mode : The 3-2 pull down for NTSC and the 2-2 pull down for PAL
Black Setup	0IRE, 7.5IRE Black level adjustment, for adjusting black level by a video source. NOTE : Black Setup is not available for IEEE1394 signal : AUX in signal.
Component	Auto, NTSC, PAL, 480p, 540p, 576p, 720p, 1035i, 1080i
Video System	Auto, NTSC, PAL, SECAM
RGB System	Auto, NTSC, PAL, 480p, 540p, 576p, 720p, 1035i, 1080i
DVI System	RGB, YPbPr, YCbCr Color space conversion select for DVI input. RGB: Color Space Conversion is skipped. YPbPr: This mode is suitable for HD TV signal such a 720p, 1080i. YCbCr: This mode is suitable for SD TV signal such a 480i, 480p.

NTSC(NTSC-3.58)	: Conventional analog broadcasting used mainly in USA, Canada, Taiwan, Korea, and Japan.
PAL(PAL-4.43)	: Conventional analog broadcasting used mainly in United Kingdom and Germany.
SECAM	: Conventional analog broadcasting used mainly in France and Russia.
480p	: Standard digital broadcasting
540p	: Special digital broadcasting (for example: RCA DTC100)
576p	: Standard digital broadcasting
720p, 1080i	: High Definition digital broadcasting
1035i	: Japanese "Hi-Vision" broadcasting

❖ Setting the Setting Menu

1. Use ▲ / ▼ key to adjust.
2. Use ◀ key to go back to the menu item.

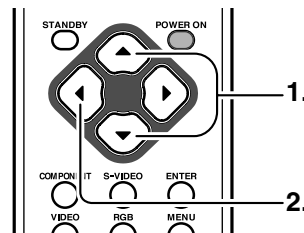
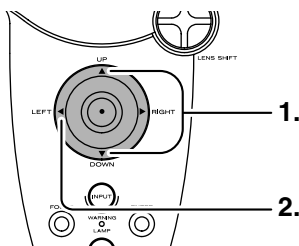

Display

The following adjustments can be made:

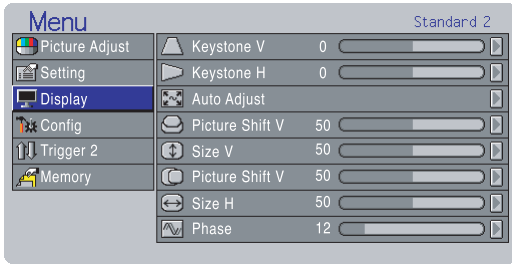

Item	Adjustments
Keystone-V (Electronic vertical keystone correction)	
Keystone-H (Electronic horizontal keystone correction)	
Auto Adjust	Yes / No
Picture Shift V	Down Up
Size V	Small Large
Picture Shift H	Left Right
Size H	Small Large
Phase	Backward Forward

– Keystone H, V

Adjust trapezoid image to rectangle image.

– Auto Adjust

Yes : For RGB IN signal, Picture Shift V and H, Size V and H, and Phase are adjusted automatically.

No : If something wrong with AUTO Adjust, select No, and adjust Size V, Size H, Picture Shift H, Picture Shift V, and/or Phase manually.

Use ◀/▶ key to select “Yes”, and press the **ENTER** key.

– Picture Shift V, H

Adjust the position of the picture. H adjusts the horizontal position of the picture. V adjusts the vertical position of the picture.

– Size V, H

Adjust the vertical and horizontal size of the picture.

– Phase

Adjust the phase of the DMD™ dots and the computer signal input from the RGB IN. Adjust the picture to where it looks clearest.

NOTE:

- If User Memory is set to default, Picture Shift V, H cannot be selected. To select Picture Shift V, H, set User Memory to either 1 to 3. See “Memory”. (P.28)

❖ Setting the Display Menu

1. Use ◀/▶ key to adjust.
2. Use ▲ key to go back to the menu item.

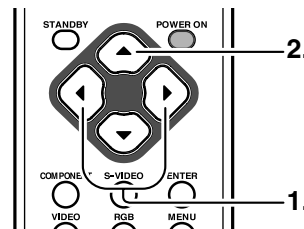
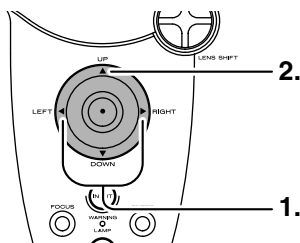

Configuration

The following adjustments can be made:

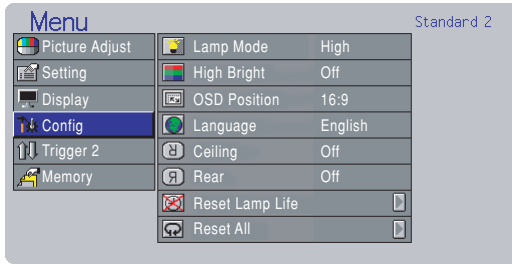

Lamp mode	High, Low
High Bright	On, Off High Bright On : Display brightest image.
OSD Position	16:9, 4:3
Language	English, German, French, Spanish, Portuguese, Italian
Ceiling	On, Off On: The picture is reversed horizontally and vertically.
Rear	On, Off On: The picture is reversed horizontally.
Reset Lamp Life	Yes, No
Reset All	Yes, No

– OSD Position (16:9 / 4:3)

Select OSD position from 16:9 or 4:3.

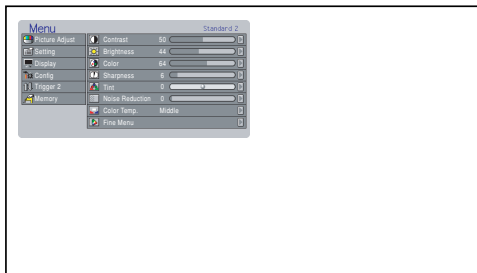

16 : 9 OSD position

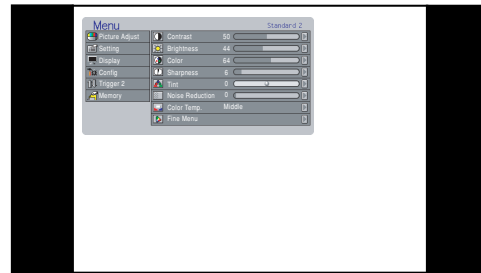

4 : 3 OSD position

– Reset Lamp Life

Lamp Life must be reset immediately if the lamp is replaced. Select “Reset Lamp Life” from Config menu. The menu shown below is displayed.



Again, select “Yes”, and press the **ENTER** key. Then the lamp life is initialized.

– Reset All

All settings are reset to the factory default settings except the lamp life. When the user selects “Yes”, the following message appears:



Again, select “Yes”, and press the **ENTER** key.

❖ Setting the Config Menu

1. Use ▲ / ▼ key to adjust.
2. Use ◀ key to go back to the menu item.

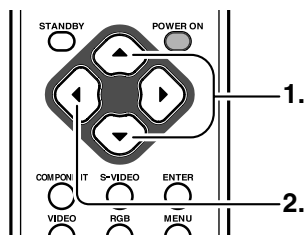
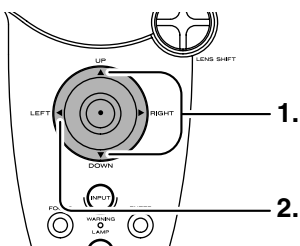

Trigger 2

Select either 12V output or 0V output by choosing On or Off for each aspect mode. Full, Normal, Zoom, and Through.

On: Output DC 12V.

Off: No output.

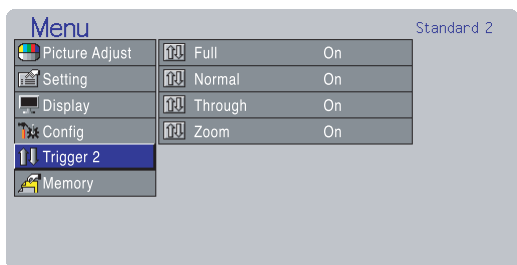

This allows you to control such as a powered dual aspect screen with the outputs for the aspect modes.

❖ Setting the Trigger 2 Menu

1. Use ▲ / ▼ key to adjust.
2. Use ◀ key to go back to the menu item.

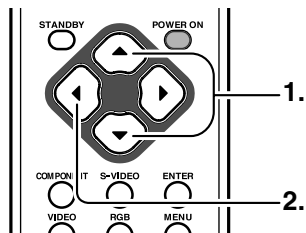
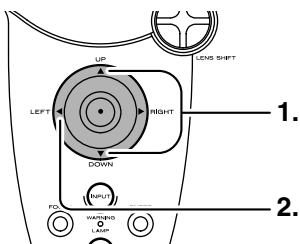

Memory

This unit has 4 picture modes, Theater, Standard, Dynamic, User, for your choice. You can choose one with the direction buttons on the unit or on the remote.

- **Theater :** This mode is designed for high fidelity black appearance and is good for movie pictures.
- **Standard :** This mode is good for normal pictures.
- **Dynamic :** This mode is good for visually dynamic pictures.
- **User :** This mode allows you to adjust your favorite gamma curve.

Note : It is possible to download the software for making the gamma curve from our web.

Also, each mode has 3 User Memories and Default. If Default is set, you cannot select "Picture Adjust" and "Display" in the menu.

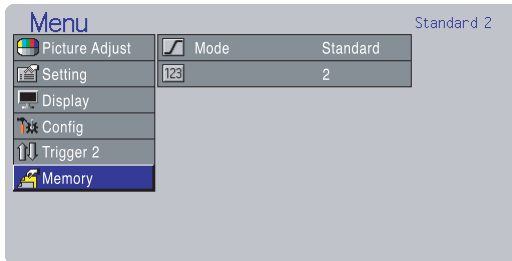

– Store memory

From the menu above, select "Memory" and choose one memory mode from 1-3 for either "Theater", "Standard", "Dynamic" or "User" with the remote controller. Picture Adjust menu will be displayed. Adjust the picture and the adjustment settings will be stored in the memory automatically.

❖ Setting the Memory Menu

1. Use ▲ / ▼ key to adjust.
2. Use ◀ key to go back to the menu item.

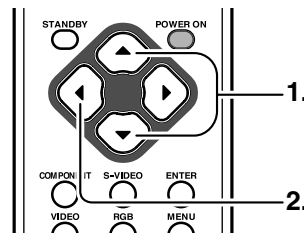
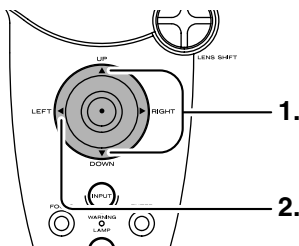

Lamp Life and Replace Lamp

❖ Lamp Life

Display the remaining lamp life by pressing the **INFO.** key on the remote controller.

Information	
Video Input	Component-1080i
Memory	Standard 2
Cinema Mode	Auto
Noise Reduction	0
Aspect	Full
Trigger 2	On
Lamp Life	921 Hours
Total Hours	3653 Hours

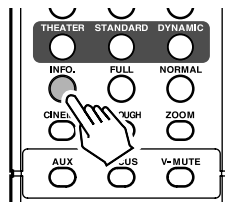

Notes:

- The maximum life limit of the lamp is 2,000 hours. Although we care very much about quality, the lamp can rarely breaks down if running time exceeds 1,000 hours. Therefore we recommend to replace the lamp if Lamp Life gets under 1,000 hours. The lamp cannot be used exceeding the maximum life limit.
- This product is checked under strict quality control when it is shipped out form factory.
 "Total Hours" in the menu includes the time for this check. So "Total Hours" may not be 0 hours when it is used first time.

- When the lamp life becomes less than 100 hours and the unit is still on, the remaining lamp life is displayed on the screen automatically.

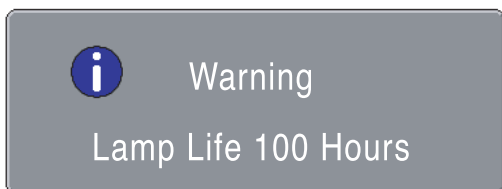

- When the lamp life becomes less than 5 hours, the remaining lamp life is displayed on the screen .

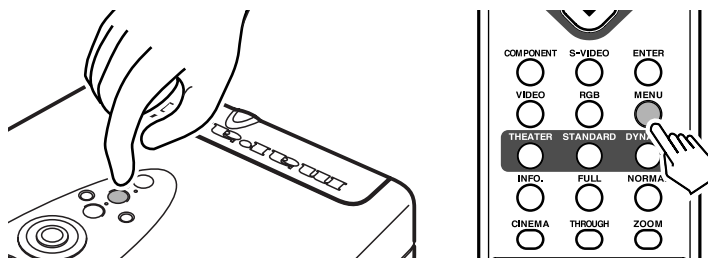
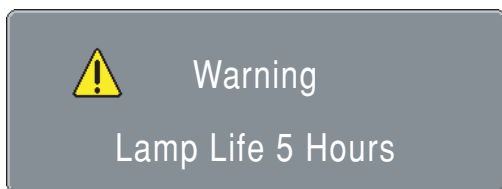

To clear the warning, press the **MENU** key.

- When the lamp life has expired (Lamp Life 0 HOURS), the unit will be immediately turned off, and the WARNING indicator will light up in red.

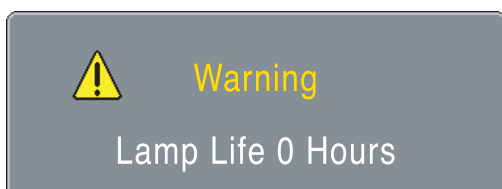

❖ Initialize the Lamp Life

If the lamp is replaced to new one, follow this procedure to reset (initialize) the lamp life. Refer to "Replacing Lamp Unit". (P.30)

1. Connect the AC power cord after replacing lamp unit. (P.8)
2. Press the **POWER ON** key on the remote controller or the **POWER** key on the projector. The following message appears for 120 seconds.



3. Select "Yes", using the ◀/▶ keys.
4. Press the **ENTER** key . The lamp life indicator is now initialized.

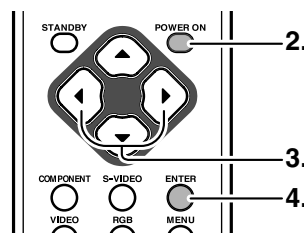
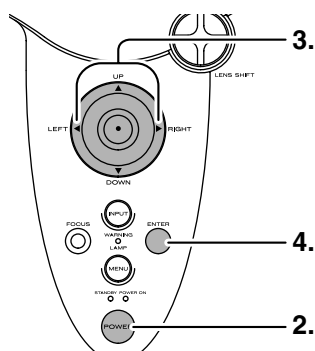

MAINTENANCE

Replacing Lamp Unit

CAUTION:

- Do not touch the lamp and the lamp unit carelessly. It is extremely hot. Wait at least one hour for the lamp to cool down before handling.
- Do not loosen any screws except for those mentioned below.
- The lamp may break if handled improperly.
- Do not use other than a Marantz replacement lamp unit.

❖ How to replace the Lamp Unit

PREPARATION:

When replacing the lamp, turn off the power for the projector. After the cooling fan stops, disconnect the power cord and wait for one hour until the lamp is cooled down completely, then replace the lamp.

1. Press the **STANDBY** key on the remote controller or the **POWER** key on the projector to turn the projector off.
5. Remove the lamp cover screw.

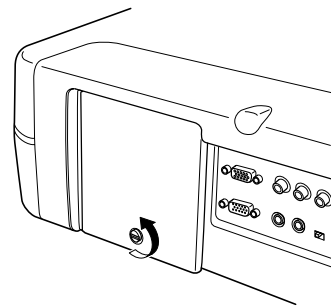
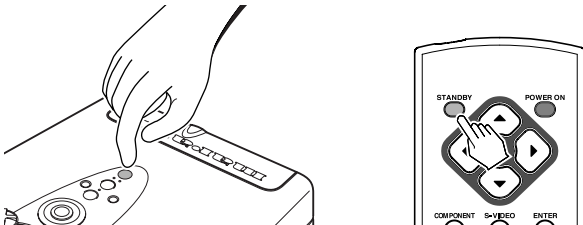

2. After the cooling fan stops, Unplug the AC power cord.

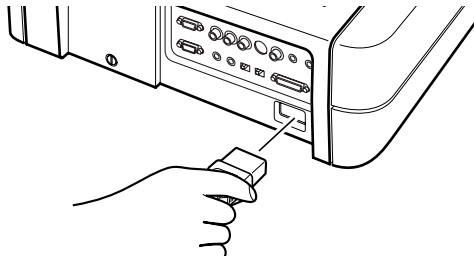

3. Wait at the least one hour for the lamp and lamp unit to cool down.
4. Read the caution and warning labels on the unit.

6. Remove the lamp cover in the direction of the arrow.

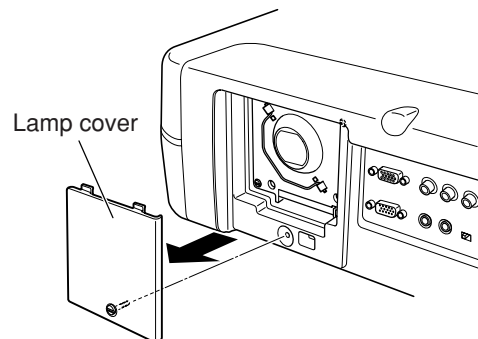

7. Remove the two screws of the lamp unit. At this time, do not remove the other screws.

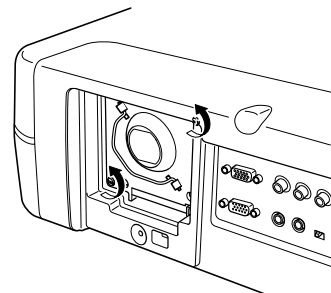

Lamp cover

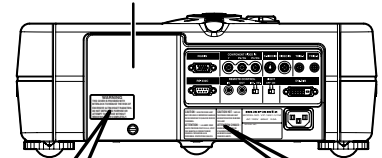

WARNING THIS COVER IS PROVIDED WITH INTERLOCK TO REDUCE THE RISK OF EXCESSIVE ULTRAVIOLET RADIATION. DO NOT DEFEAT ITS PURPOSE OR ATTEMPT TO SERVICE WITHOUT REMOVING COVER COMPLETELY.	CAUTION : HIGH PRESSURE LAMP MAY EXPLODED IF IMPROPERLY HANDLED. REFER SERVICING TO QUALIFIED SERVICE PERSONNEL.	CAUTION HOT : UNPLUG THE POWER CORD AND WAIT 60 MINUTES BEFORE CHARGING THE LAMP.
	ATTENTION : LA LAMPE SOUS HAUTE PRESSION PEUT SI ELLE, N'EST PAS MANIPULEE CORRECTEMENT, CONFIER L'OPERATION A UN PERSONNEL D'ENTRETIEN QUALIFIE.	ATTENTION CHAUD : DEBRANCER LE CORD ON D'ALIMENTATION ET ATENDER 60 MINUTES AVANT DE CHANGER LAMPE.

8. Holding the handle and pull the lamp unit out toward your side.

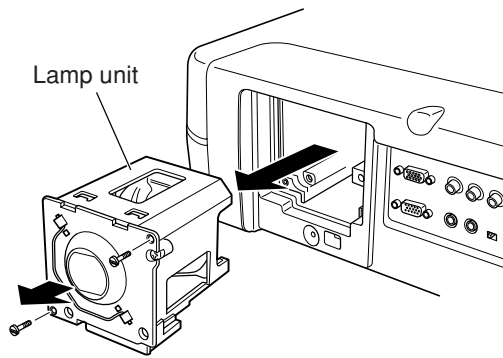

9. Install a new lamp unit in position securely.

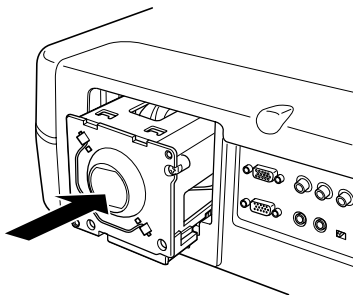

10. Tighten the two screws of the lamp unit. Push and fold the handle.

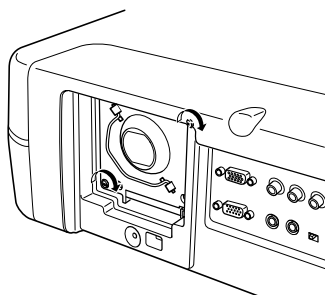

11. Install the lamp cover back in its original position and fasten with the fastening screw.

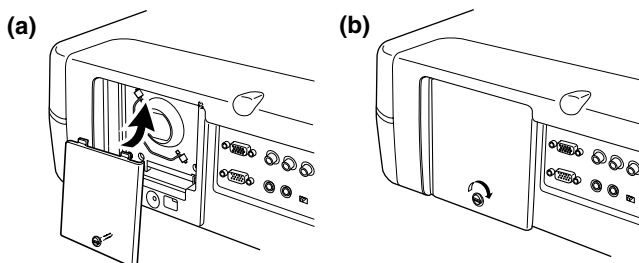

12. Plug in the video projector and turn on the power and project the image. Reset the Lamp Life. (➡ P.26)

Cleaning the Lens

If the lens becomes dirty or smudged, clean it with a soft dry cloth only. Use optical lens cleaners that are approved for eyeglasses or cameras. Do not use a dampen cloth, detergent solution, or thinner. It may damage the lens and remain as stains.

Replacement Parts

When replacement parts are required, be sure to inform a Marantz authorized service center. Use only replacement parts specified by Marantz. Unauthorized substitutions may result in fire, electric shock, or other hazards. And, the warranty may not be guaranteed.

Optional Accessories

- **Lamp Unit** : LU-12VPS1

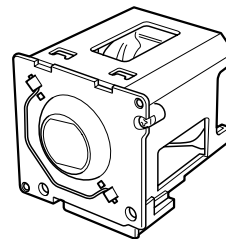

- **Ceiling Mount kit** : MOUNT 12

This kit is specially designed to mount the unit on ceiling.

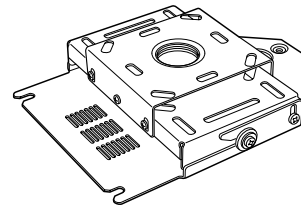

- **Extension Pole** : EXT-81

This tool is to adjust height with the Ceiling Mount Kit MOUNT 12.

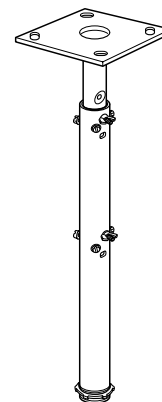

CAUTION:

For ceiling installation, consult with the Marantz Authorized dealer.

TROUBLESHOOTING

Try the following troubleshooting before calling for service.

1. Are the connections made properly ?
2. Are you operating the unit properly, following the instructions ?

If the unit does not operate properly, check the items shown in the following table.

If any trouble cannot be solved by the instructions below, malfunction of the internal circuitry is suspected; immediately unplug the AC power cord and contact Marantz dealer or service center.

Symptom	Possible Cause	Remedy
No power	AC power cord is not connected correctly.	Connect the AC power cord properly.
	Lamp cover is not closed correctly.	Close the cover properly.
Image is not displayed.	A signal cable is not connected correctly.	Connect a signal cable properly.
	Selected input is incorrect.	Select the correct input source .
	The picture mute is active.	Press the MUTE key to release the mute.
Poor color.	Picture is not adjusted properly.	Adjust the picture in the MENU mode.
Picture is too dark.	Lamp life is running out.	Replace the lamp.
	Contrast or brightness is not adjusted properly.	Adjust contrast or brightness properly.
Picture is not clear.	Picture is out of focus.	Adjust the focus.
	Dew is on the lens.	Run the projector for about two hours.
Picture rolls.	A signal cable is not properly connected.	Connect a signal cable properly.
The Remote Controller does not work.	Batteries are exhausted.	Replace batteries.
	The distance to the unit is too far.	Make the distance between the unit and the remote control closer.
	IR sensor on unit is obstructed.	Remove any obstacles.
	The "EXTERNAL" position on the connector panel is selected.	Select the "INTERNAL" position.

Note:

- If the lamp still does not function after the replacement and initialization of the lamp life, contact a Marantz authorized dealer, or service center.

ERROR MODE

WARNING/LAMP indicator, POWER ON indicator, and STANDBY indicator diagnose error mode of the projector as follows.

Error mode	Indicators			Possible Cause	Recommendation
	WARNING /LAMP	POWER ON	STANDBY		
Lamp cover	ON	OFF	Flashing	The lamp cover is not closed properly.	Close the cover correctly.
Lamp	ON	OFF	OFF	The lamp has failed, or the lamp is completely worn out.	Replace the lamp and reset lamp life.
Lamp temperature	Flashing	ON	Flashing	Temperature around the lamp unit becomes unusually high.	Check that nothing is blocking the ventilation holes, and leave off the unit for about an hour.
Power supply	Flashing	ON	OFF	Temperature around the power supply becomes unusually high.	
Fan	Flashing	OFF	ON	The fan inside the projector has stopped.	

ON SCREEN MESSAGE

Use the list below to check the message displayed on the screen.

Message	Meaning	Remedy
NO SIGNAL	No input signal.	Properly connect the cables.
REPLACE LAMP!	The lamp has reached the end of its life.	Replace the lamp and reset lamp life.
OUT OF RANGE	Improper signal feed to the projector.	Adjust resolution, V(Hz) : refresh rate of the equipment, referring to the Timing Chart.

SPECIFICATIONS

❖ Optical characteristics

Panel	0.8 inch 16:9 1280 x 720 pixels Digital Micromirror Device™
Lamp	Super High Pressure 150W
Lens	f: 26.5 to 30.7 / F: 3.0
Projection size	40 to 250 inches
Light output	700 ANSI LUMEN typical

❖ Input/Output

VIDEO IN	RCA x 1 NTSC-3.58/PAL-4.43/SECAM Composite video 1.0Vp-p/75 Ohm
S-VIDEO IN	S-Connector x 1 NTSC-3.58/PAL-4.43/SECAM S-Video
COMPONENT IN	RCA x 3 Y, Cb/Pb, Cr/Pr
RGB/HD IN	D-sub M 15 pin x 1 Analog RGB HD:1080i, 720p, 480p
DVI-D IN	DVI-D 24pin x 1 T.M.D.S compliant (single link only)  P.34
REMOTE CONTROLLER IN	Mini jack type x 1
REMOTE CONTROLLER OUT	Mini jack type x 1
AC IN	3 Prong Grounding Type
TRIG.1 OUT, TRIG.2 OUT	Mini Jack x 2 Output: DC12V or 0V
RS232C	RS232C receptacle plug x 1

❖ General

Power requirement	AC 100-120V / 220-240V, 50/60 Hz
Power consumption	< 250 W
Standby consumption	< 3.3 W
Chassis isolation	Class-1
Safety	UL6500 CSA E60065 EN60950
EMC	FCC Part-15 Class-B EN55022 Class-B
Dimensions	15 15/16(W) x 18 9/16(D) x 6 1/8(H) inch 404.5(W) x 471(D) x 158(H) mm
Net weight	13 kg
Operating Temperature	5 to 35 °C
Operating humidity	30 to 85%
Storage Temperature	- 20 to 60 °C
Storage humidity	30 to 85%

❖ Accessories

- Lens cap x 1
- Remote controller x 1
- Batteries x 2
- AC power code (only for 125V) x 1
- User Guide x 1
- Control Adapter cable (Mini jack to RCA) x 1
- Warranty Card (1 copy each for USA, CANADA)

Specifications may be subjected to change without any prior notice.

❖ Timing chart

Input Signal

System	Resolution	V (Hz)	H (KHz)	Scan	Signal	Video	S-Video	Component	RGB	DVI	Note
NTSC	768x240	59.94 / 60	15.73	I	NTSC	X	X	–	–	–	
PAL-B/G	960x287.5	50	15.63	I	PAL-B/G	X	X	–	–	–	
SECAM	960x287.5	50	15.63	I	SECAM	X	X	–	–	–	
480/60p	720x480	59.94 / 60	31.5	P	Video 60Hz	–	–	X	X	–	#2
576/50p	720x576	50	31.3	P	Video 50Hz	–	–	X	X	–	
1035/60i	1920x518	59.94 / 60	33.8	I	480/60p	–	–	X	X	X	#2
1080/60i	1920x540	59.94 / 60	33.8	I	576/50p	–	–	X	X	X	
1080/50i	1920x540	50	28.1	I	1035/60i	–	–	X	X	X	#2
1080/48i	1920x540	48	27.0	I	1080/60i	–	–	X	X	X	#2
720/60p	1280x720	59.94 / 60	45.0	P	1080/50i	–	–	X	X	X	
720/50p	1280x720	50	37.5	P	1080/48i	–	–	X	X	X	
720/48p	1280x720	48	36.0	P	720/60p	–	–	X	X	X	#2
540/60p	1920x540	59.94 / 60	33.8	P	720/50p	–	–	X	X	X	
640x350 ^{#1}	640x350	70	31.5	P	720/48p	–	–	X	X	X	
640x350 ^{#1}	640x350	85	37.9	P	540/60p	–	–	X	X	X	#2
640x400 ^{#1}	640x400	70	31.5	P	640x350@70Hz	–	–	–	X	X	
640x400 ^{#1}	640x400	85	53.7	P	640x350@85Hz	–	–	–	X	X	
640x480	640x480	60	31.5	P	640x400@70Hz	–	–	–	X	–	
640x480 ^{#1}	640x480	72	37.9	P	640x480@60Hz	–	–	–	X	X	
640x480 ^{#1}	640x480	75	37.5	P	640x480@72Hz	–	–	–	X	–	VESA#901101
640x480 ^{#1}	640x480	85	43.3	P	640x480@75Hz	–	–	–	X	–	
800x600	800x600	56	35.2	P	640x480@85Hz	–	–	–	X	–	
800x600	800x600	60	37.9	P	800x600@56Hz	–	–	–	X	X	VESA#900601
800x600 ^{#1}	800x600	72	48.1	P	800x600@60Hz	–	–	–	X	X	VESA#900602
800x600 ^{#1}	800x600	75	46.9	P	800x600@72Hz	–	–	–	X	–	VESA#900603A
800x600 ^{#1}	800x600	85	53.7	P	800x600@75Hz	–	–	–	X	–	
1024x768	1024x768	43	35.5	P	800x600@85Hz	–	–	–	X	–	
1024x768	1024x768	60	48.4	P	1024x768@60Hz	–	–	–	X	X	
1024x768 ^{#1}	1024x768	70	56.5	P	1024x768@70Hz	–	–	–	X	–	
1024x768 ^{#1}	1024x768	75	60.0	P	1024x768@75Hz	–	–	–	X	–	
1024x768 ^{#1}	1024x768	85	68.7	P							

#2 : both of 59.94 and 60Hz

I : Interlaced signal
P : Progressive signal

Notes:

- The systems marked #1 are not displayed properly.
- Any signals not in the list above may not be projected properly.

GLOSSARY

Aspect ratio

Width and height ratio of an image. The normal aspect ratio of a computer and video image is 4 : 3. There are also wide images with an aspect ratio of 16 : 9 and 21 : 9.

Black Level (Black setup)

The signal level which represents black picture intensity.
For NTSC system for USA, this level is 7.5IRE.
For NTSC system for Japan and DVD, this level is 0IRE.

Color Temperature

White color hue.
Low color temperature implies a warmer (more yellow/red) light.
High color temperature implies a colder (more blue) light.

Keystone

Distortion of the image caused by projection to a wrong vertical/horizontal angle.

DIMENSIONS

❖ Top

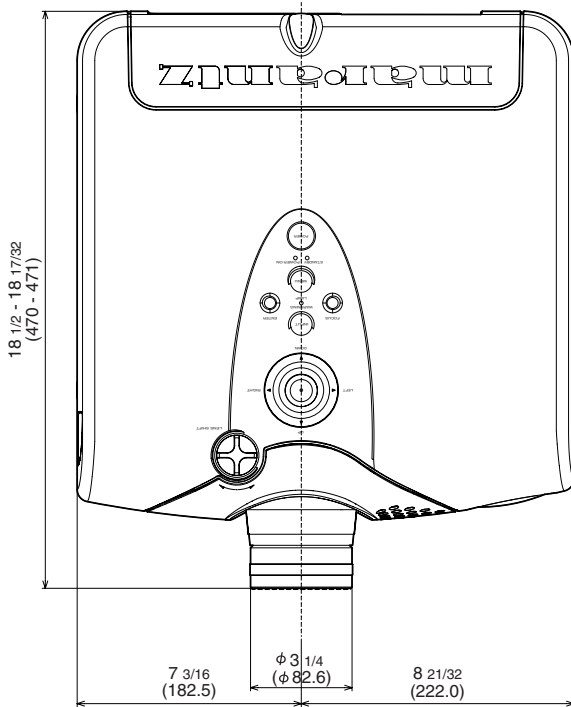

❖ Front

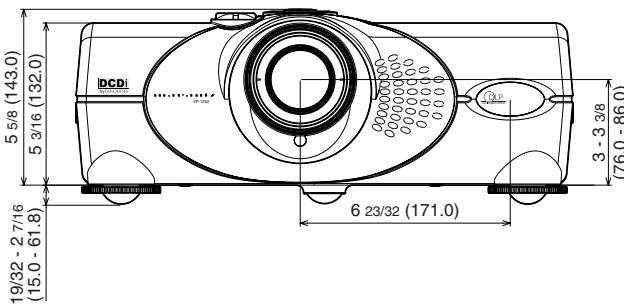

❖ Rear

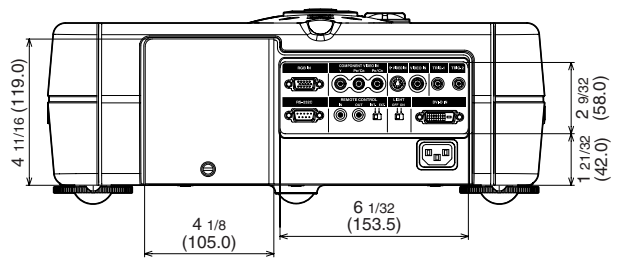

❖ Bottom

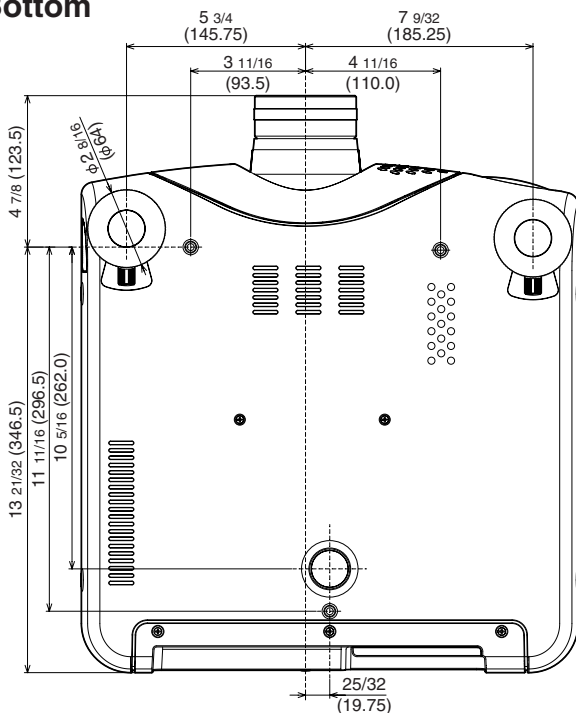

Unit : inch (mm)

COUNTRY	COMPANY	ADDRESS
ALGERIE	Azur 2000	8, Lotissement Ben Hatadi, Alger, Algeria
ARMENIA	NGYIG Ltd.	47 A/75 St. Lalaianis, 375000 Yerevan, Armenia
AUSTRALIA	QualiFi Pty. Ltd.,	P.O. Box 350, Mt. Waverley, VIC 3149, Australia
AUSTRIA	Huber & Prohaska GmbH	Taborstraße 95 / Ladestraße 1, Gebäude Hangartner, A-1200 Wien, Austria
BAHREIN	Ambassador Stores	P.O. Box 237,141, Government Avenue, Manama,Bahrein
BANGLADESH	Target	1078, Ramjoy Mohanja Lane Asadgonj, Chittagong 4000, Bangladesh
BELGIUM	Van der Heyden Audio N.V.	Brusselbaan 278, 9320 Erembodegem, Belgium
BULGARIA	Ariescommerce GmbH	Makedonia Blvd. 16, 1606 Sofia, Bulgaria
CANADA	Lenbrook Industries Limited	633 Granite Court, Pickering, Ontario
CHINA	Guang Chang Audio International Co., Ltd.	No.38 Yushan Road, ShiQiao, Pan Yu, Guang Dong, China
CYPRUS	Empire Hifi systems Ltd.	P.O. Box 5604, Nicosia, Cyprus
CZECH REPUBLIC	Audio International	Sokolska 41, 67902 Rajecko, OKR,Blansko, Czech Republic
DENMARK	Audio Nord	Dali Allé 1, 9610 Noerager, Denmark
DUBAI	V.V.& SONS	P.O. Box 105, Dubai, U.A.E.
EGYPT	Solimco	9, El Attibaa St. Doki, Cairo, Egypt
ESTONIA	HiFi Club Estonia	Ehte 4, 90503 Haapsalu, Estonia
F.Y.R.O.M.	T.P. KODI	ul.Cedomir Kantargiev 21a, Skopje, Former Yugoslavian Republic of Macedonia
FINLAND	Audio Nord	Uudenmaankatu 4-6, Helsinki SF-00120, Finland
FRANCE	Marantz France	A division of Marantz Europe B.V., P.O. Box 301, 92 156 Suresnes Cedex, France
GERMANY	Marantz Deutschland	Hakenbusch 3, 49078 Osnabrück, Germany
GREECE	Adamco S.A.	188, Hippocratous Street, 11471 Athens, Greece
HEADQUARTERS EUROPE:	Marantz Europe B.V.	P.O. Box 8744, 5605 LS Eindhoven, The Netherlands
HONG KONG	Marantz Hong Kong Ltd.	Unit 1706, Metroplaza II, 223 Hing Fong Road, Kwai Fong, N.T., Kowloon, Hong Kong
HUNGARY	Infovox Ltd.	Terez Krt.31, 1067 Budapest, Hungary
ICELAND	ID Electronics Ltd.	Armula 38, 108 Reykjavik, Iceland
INDIA	NOVA Audio Private	8,Punam Co-op.Society 29/30 Road#5, Union Park MUMBAI 400052, India
IRAN	Home Co.	5th floor no 878 Philips Building Enghelab ave, P.O. 11365/7844 Tehran, Iran
IRELAND	Marantz Ireland	Clonskeagh, Dublin 14, Ireland
ISRAEL	Elmor Ltd.	52 Heh Beiyar Street, Kikar Hamedina, Tel Aviv, Israel
ITALY	Marantz Italy	Via Casati 23, 20052 Monza (Milano), Italy, Servizio Consumatori 1678-20026, Numero Verde
IVORY COAST	Hifivoir	B.P. 2428, Abidjan 01, Ivory Coast
JAPAN	Marantz Japan Inc.	35-1 Sagami Ohno 7-Chome, Sagamihara-shi, Kanagawa 228-8505, Japan
KOREA	MK Enterprises Ltd.	Rm604, Electro-officetel, 16-58. Hangang-ro 3Ga, Yongsan-Ku, Seoul, Korea
KUWAIT	alAlamiah Electronics Intl.	P.O. Box 8196, Salmiah 22052, Kuwait
LATVIA	Ace Ltd.	61, LacPlesa Str., Riga LV 1011, Latvia
LEBANON	AZ Electronics S.A., 1,	P.O. Box 11 2833, Beirut, Lebanon
LITHUANIA	Accapella Ltd.	Ausros, Vartu G/5, Pasazo SKG., 2001 Vilnius, Lithuania
MALAYSIA	Wo Kee Hong Electronics Sdn. Bhd.	2nd Floor Bangnan Infinite Centre, Lot1, Jalan 13/6, 46200 Petaling Jaya, Selangor Datul Ehsan, Malaysia
MALTA	Doneo Co Ltd.	78 The Strand, Sliema SLM07, Malta
MAURITIUS	SKR Electronics Ltd.	P.O. Box 685, Bell Village, Port Louis, Mauritius
MILITARY MARKET EUROPE	PASCO GmbH	PO BOX 1280, Sandhausen 69200, Germany
NEW ZEALAND	Wildash Audio Systems	14 Malvern Road, Mt. Albert, Auckland, New Zealand
NORWAY	Audio Nord	Sandkerveien 64, Oslo 0483, Norway
OMAN	Mustafa & Jawad Trading CO.	P.O. Box 1918, Ruwi, Oman
POLAND	Philips Polska Sp. z.o.o.	Al.Jerozolimskie 195b, 02 222 Warszawa, Poland
PORTUGAL	Corel2	Comércio de Electrónica Lda., Av. Luís Bivar, No 85 A, 1050 Lisboa, Portugal
PROFESSIONAL EUROPE	Marantz Professional Products	Kingsbridge House, Padbury Oaks, 575-583 Bath Road, Longford, Middlesex UB7 0EH, U.K.
PROFESSIONAL U.S.A.	Marantz Professional Products	Distributed by: Superscope Technologies Inc., 1000 Corporate Blvd. Ste.D, Aurora, Illino
QATAR	Almana & Partners W.W.L.	P.O. Box 49, Doha, Qatar
REUNION	Vision +	180 Rue du Marechal Leclerc, 97400 Saint Denis, Ile de la Reunion
ROMANIA	Nova Music Entertainment	5, Zagazului Str. Bl.1G,apt.18, sector 1,Bucharest, Romania
RUSSIA	Absolute Audio	7/2, Montazhnaya Street, 107497 Moscow, Russia
SAUDI ARABIA	Adawlia Univ. Electr. Apl	P.O. Box 2154, Alkhubar 31952, Saudi Arabia
SINGAPORE	Wo Kee Hong Distribution PTE Ltd.	130 Joo Seng Road, #03-02 Olivine Building, Singapore 368357
SLOVAKIA	Bis Audio s.r.o.	Nam. SNP 10, 96001 Zvolem, Slovakia
SLOVENIA	Bofex	Smartinska 152, HALA V/3, 61000 Ljubljana, Slovenia
SOUTH AFRICA	Coherent Imports (PTY) Ltd.	P.O. Box 1614, Alberton, 1450, South Africa
SPAIN	Marantz Spain	Martinez Villergas 2, Apartado 2065, Madrid 28027, Spain
SRI LANKA	The listening Room	Mezzanine Floor, The Landmark 385, Galle Road, Colombo - 3, Sri Lanka
SWEDEN	Audio Nord	Almedalsvagen 4, Gotenborg 402-23, Sweden
SWITZERLAND	Sound Company AG	Postfach, 8010 Zürich, Switzerland
SYRIA	Hamzeh & Partners	Hafez Ibrahim Str. No 117, Damascus Shalan, Syria
TAHITI	Covecolor	Av. Prince Hinoi, Cours de l'union sacré, P.O. Box 2334, Papeete, Tahiti
TAIWAN	Pai-Yuing Co. Ltd.	6th No 148 Sung Kiang Road, Taipei 10429, Taiwan R.O.C.
THAILAND	MRZ Standard Co. Ltd.	746-750 Mahachai Road, Wangburapa, Bangkok 10200, Thailand
TUNESIA	Societe EDEVIG	40, Avenue du Golfe Arabe, El Menzah, 1004, Tunesia
TURKEY	Türk Philips Ticaret A.S.	Yukari Dudullu Organize sanayi Bolgesi, 2.Cadde no.28, 81260 Umraniye-Istanbul, Turkey
U.K.	Marantz Hifi UK Ltd.	Kingsbridge House, Padbury Oaks, 575-583 Bath Road, Longford, Middlesex UB7 0EH, U.K.
U.S.A.	Marantz America Inc.	1100 Maplewood Drive Itasca, IL 60143, U.S.A.
YUGOSLAVIA	ITM Company	Omladinskih Brigada 86, 11070 Belgrade, Yugoslavia

WWW.MARANTZ.COM

marantz® is a registered trademark.



Free Manuals Download Website

<http://myh66.com>

<http://usermanuals.us>

<http://www.somanuals.com>

<http://www.4manuals.cc>

<http://www.manual-lib.com>

<http://www.404manual.com>

<http://www.luxmanual.com>

<http://aubethermostatmanual.com>

Golf course search by state

<http://golfingnear.com>

Email search by domain

<http://emailbydomain.com>

Auto manuals search

<http://auto.somanuals.com>

TV manuals search

<http://tv.somanuals.com>