

marantz®

Model VC4400 User Guide

5 Disc DVD Changer



Safety Precautions



CAUTION
RISK OF ELECTRIC SHOCK
DO NOT OPEN



CAUTION: TO REDUCE THE RISK OF ELECTRIC SHOCK DO NOT REMOVE COVER (OR BACK) NO USER-SERVICEABLE PARTS INSIDE REFER SERVICING TO QUALIFIED SERVICE PERSONNEL.



This lightning flash with arrowhead symbol within an equilateral triangle is intended to alert the user to the presence of uninsulated dangerous voltage within the product's enclosure that may be of sufficient magnitude to constitute a risk of electric shock to persons.



The exclamation point within an equilateral triangle is intended to alert the user to the presence of important operating and maintenance (servicing) instructions in the literature accompanying the product.

WARNING: TO REDUCE THE RISK OF FIRE OR ELECTRIC SHOCK, DO NOT EXPOSE THIS PRODUCT TO RAIN OR MOISTURE.

WARNING: Do not install this equipment in a confined space such as a book case or similar unit.

CLASS 1 LASER PRODUCT
KLASSE 1 LASER PRODUKT
LUOKAN 1 LASER LAITE
KLASS 1 LASER APPARAT
CLASSE 1 PRODUIT LASER

CAUTION:

This Digital Video Disc Player employs a Laser System.

To ensure proper use of this product, please read this owner's manual carefully and retain for future reference should the unit require maintenance, contact an authorized service location (see service procedure).

Use of controls, adjustments, or the performance of procedures other than those specified herein may result in hazardous radiation exposure.

To prevent direct exposure to laser beam, do not try to open the enclosure. Visible laser radiation when open. **DO NOT STARE INTO BEAM.**

CAUTION: The apparatus should not be exposed to water (dripping or splashing) and no objects filled with liquids, such as vases, should be placed on the apparatus.

FCC WARNING: This equipment may generate or use radio frequency energy. Changes or modifications to this equipment may cause harmful interference unless the modifications are expressly approved in the instruction manual. The user could lose the authority to operate this equipment if an unauthorized change or modification is made.

REGULATORY INFORMATION: FCC Part 15

This product has been tested and found to comply with the limits for a Class B digital device, pursuant to Part 15 of the FCC Rules. These limits are designed to provide reasonable protection against harmful interference when the product is operated in a residential installation. This product generates, uses, and can radiate radio frequency energy and, if not installed and used in accordance with the instruction manual, may cause harmful interference to radio communications. However, there is no guarantee that interference will not occur in a particular installation. If this product does cause harmful interference to radio or television reception, which can be determined by turning the product off and on, the user is encouraged to try to correct the interference by one or more of the following measures:

- Reorient or relocate the receiving antenna.
- Increase the separation between the product and receiver.
- Connect the product into an outlet on a circuit different from that to which the receiver is connected.
- Consult the dealer or an experienced radio/TV technician for help.



NOTES ON COPYRIGHTS:

It is forbidden by law to copy, broadcast, show, broadcast via cable, play in public, or rent copyrighted material without permission.

This product features the copy protection function developed by Macrovision. Copy protection signals are recorded on some discs. When recording and playing the pictures of these discs on a VCR, picture noise will appear.

This product incorporates copyright protection technology that is protected by method claims of certain U.S. patents and other intellectual property rights owned by Macrovision Corporation and other rights owners. Use of this copyright protection technology must be authorized by Macrovision Corporation, and is intended for home and other limited viewing uses only unless otherwise authorized by Macrovision Corporation. Reverse engineering or disassembly is prohibited.

SERIAL NUMBER: The serial number is found on the back of this unit. This number is unique to this unit and not available to others. You should record requested information here and retain this guide as a permanent record of your purchase.

Model No. _____

Serial No. _____

IMPORTANT SAFETY INSTRUCTIONS

CAUTION: PLEASE READ AND OBSERVE ALL WARNINGS AND INSTRUCTIONS IN THIS OWNER'S MANUAL AND THOSE MARKED ON THE PRODUCT. RETAIN THIS BOOKLET FOR FUTURE REFERENCE.

This product has been designed and manufactured to assure personal safety. Improper use can result in electric shock or fire hazard. The safeguards incorporated in this product will protect you if you observe the following procedures for installation, use, and servicing.

This product does not contain any parts that can be repaired by the user.

DO NOT REMOVE THE CABINET COVER, OR YOU MAY BE EXPOSED TO DANGEROUS VOLTAGE. REFER SERVICING TO QUALIFIED SERVICE PERSONNEL ONLY.

- 1. Read these instructions.** - All these safety and operating instructions should be read before the product is operated.
- 2. Keep these instructions.** - The safety, operating and use instructions should be retained for future reference.
- 3. Heed all warnings.** - All warnings on the product and in the operating instructions should be adhered to.
- 4. Follow all instructions.** - All operating and use instructions should be followed.
- 5. Do not use this product near water.** - For example: near a bath tub, wash bowl, kitchen sink, laundry tub, in a wet basement; or near a swimming pool; and other areas located near water.
- 6. Clean only with dry cloth.** - Unplug this product from the wall outlet before cleaning. Do not use liquid cleaners.
- 7. Do not block any ventilation openings. Install in accordance with the manufacturer's instructions.** - Slots and openings in the cabinet are provided for ventilation and to ensure reliable operation of the product and to protect it from over-heating. The openings should never be blocked by placing the product on a bed, sofa, rug or other similar surface. This product should not be placed in a built-in installation such as a bookcase or rack unless proper ventilation is provided or the manufacturer's instructions have been adhered to.
- 8. Do not install near any heat sources such as radiators, heat registers, stoves, or other apparatus (including amplifiers) that produce heat.**
- 9. Do not defeat the safety purpose of the polarized or grounding-type plug.** A polarized plug has two blades with one wider than the other. A grounding type plug has two blades and a third grounding prong. The wide blade or the third prong are provided for your safety. If the provided plug does not fit into your outlet, consult an electrician for replacement of the obsolete outlet.
- 10. Protect the power cord from being walked on or pinched particularly at plugs, convenience receptacles, and the point where they exit from the product.**
- 11. Only use attachments/accessories specified by the manufacturer.**
- 12. Use only with the cart, stand, tripod, bracket, or table specified by the manufacturer, or sold with apparatus. When a cart is used, use caution when moving the cart/product combination to avoid injury from tip-over.**
- 13. Unplug this product during lightning storms or when unused for long periods of time.**
- 14. Refer all servicing to qualified service personnel. Servicing is required when the product has been damaged in any way, such as power-supply cord or plug is damaged, liquid has been spilled or objects have fallen into the product, the product has been exposed to rain or moisture, does not operate normally, or has been dropped.**



Table of Contents

Introduction

| | |
|---|------------|
| Safety Precautions | 2 |
| IMPORTANT SAFETY INSTRUCTIONS | 3 |
| Table of Contents | 4 |
| Before Use | 5-6 |
| Playable Discs | 5 |
| Precautions | 6 |
| Notes on Discs | 6 |
| About Symbols | 6 |
| Front Panel and Display Window | 7 |
| Remote Control | 8 |
| Rear Panel | 9 |

Preparation

| | |
|---|--------------|
| Connections | 10-11 |
| Connecting to a TV | 10 |
| Connecting to Optional Equipment | 11 |
| Before Operation | 12-15 |
| General Explanation | 12 |
| On-Screen Display | 12 |
| Initial Settings | 13-15 |
| • <i>Initial Settings General Operation</i> | 13 |
| • <i>Language</i> | 13 |
| • <i>Picture</i> | 13 |
| • <i>Sound</i> | 14 |
| • <i>Others</i> | 14 |
| • <i>Parental Control</i> | 15 |

Operation

| | |
|---|--------------|
| Operation with DVD and Video CD | 16-19 |
| Playing a DVD and Video CD | 16 |
| • Exchanging discs during playback | 16 |
| • Skipping discs | 16 |
| • Exchanging the disc and starting playback .. | 16 |
| General Features | 17 |
| • <i>Moving to another TITLE</i> | 17 |
| • <i>Moving to another CHAPTER/TRACK</i> | 17 |
| • <i>Search</i> | 17 |
| • <i>Still Picture and Frame-by-Frame Playback</i> .. | 17 |
| • <i>Slow Motion</i> | 17 |
| • <i>Random</i> | 17 |
| • <i>Repeat A-B</i> | 18 |
| • <i>Repeat</i> | 18 |
| • <i>Time Search</i> | 18 |
| • <i>3D Surround</i> | 18 |
| • <i>Zoom</i> | 18 |
| • <i>Marker Search</i> | 19 |
| Special DVD Features | 19 |
| • <i>Title Menu</i> | 19 |
| • <i>Disc Menu</i> | 19 |
| • <i>Camera Angle</i> | 19 |
| • <i>Changing the Audio Language</i> | 19 |
| • <i>Changing the Audio Channel</i> | 19 |
| • <i>Subtitles</i> | 19 |

Operation with Audio CD and MP3/WMA Disc . . 20-21

| | |
|--|----|
| Playing an Audio CD and MP3/WMA Disc | 20 |
| Notes on MP3/WMA Recordings | 20 |
| • <i>Pause</i> | 21 |
| • <i>Moving to another Track</i> | 21 |
| • <i>Repeat Track/ All/ Off</i> | 21 |
| • <i>Search</i> | 21 |
| • <i>Random</i> | 21 |
| • <i>Repeat A-B</i> | 21 |
| • <i>3D Surround</i> | 21 |
| • <i>Changing the Audio Channel</i> | 21 |
| • <i>Repeat Track/Disc/All/Off</i> | 21 |

Operation with JPEG Disc

| | |
|---|----|
| Viewing a JPEG disc | 22 |
| • <i>Moving to another File</i> | 22 |
| • <i>Still Picture</i> | 22 |
| • <i>To flip the picture</i> | 22 |
| • <i>To rotate picture</i> | 22 |
| • <i>Notes on JPEG Recordings</i> | 22 |

Programmed Playback

| | |
|--|----|
| Programmed Playback with Audio CD | 23 |
| Programmed Playback with MP3/WMA disc | 23 |
| Programmed Playback with Video CD | 23 |
| • <i>Repeat Programmed Tracks</i> | 24 |
| • <i>Erasing a Track from Program List</i> | 24 |
| • <i>Erasing the Complete Program List</i> | 24 |

Additional Information

| | |
|---|----|
| Screen Saver | 25 |
| Video Mode Setting | 25 |
| Setting Remote control codes of DVD player .. | 25 |

Reference

| | |
|---------------------------------|-----------|
| Troubleshooting | 26 |
| Language Code List | 27 |
| Country Code List | 28 |
| Specifications | 29 |

About the symbols for instructions



 Indicates hazards likely to cause harm to the unit itself or other material damage.

 Indicates special operating features of this unit.

 Indicates tips and hints for making the task easier.

Before Use

Playable Discs

| | |
|---|---------------------------------------|
|  | DVD (8 cm / 12 cm disc) |
|  | Video CD (VCD) (8 cm / 12 cm disc) |
|  | Audio CD (8 cm / 12 cm disc) |

In addition, this unit can play a DVD-R, DVD±RW, Kodak PICTURE CD, SVCD, and CD-R or CD-RW that contains audio titles, MP3, WMA or JPEG files.

Notes

- Depending on the conditions of the recording equipment or the CD-R/RW (or DVD-R/±RW) disc itself, some CD-R/RW (or DVD-R/±RW) discs cannot be played on the unit.
- Do not attach any seal or label to either side (the labeled side or the recorded side) of a disc.
- Do not use irregularly shaped CDs (e.g., heart-shaped or octagonal). It may result in malfunctions.

Notes on DVDs and Video CDs

Some playback operations of DVDs and Video CDs may be intentionally fixed by software manufacturers. As this unit plays DVDs and Video CDs according to disc content designed by the software manufacturer, some playback features of the unit may not be available or other functions may be added.

Refer also to the instructions supplied with the DVDs and Video CDs. Some DVDs made for business purposes may not be played on the unit.

Regional code of the DVD player and DVDs

This DVD player is designed and manufactured for playback of region “1” encoded DVD software. The region code on the labels of some DVD discs indicates which type of player can play those discs. This unit can play only DVD discs labeled “1” or “ALL”. If you try to play any other discs, the message “Check Regional Code” will appear on the TV screen. Some DVD discs may not have a region code label even though their playback is prohibited by area limits.



Disc-related terms

Title (DVD only)

The main film content or accompanying feature content or additional feature content, or music album.

Each title is assigned a title reference number enabling you to locate it easily.

Chapter (DVD only)

Sections of a picture or a musical piece that are smaller than titles. A title is composed of one or several chapters. Each chapter is assigned a chapter number, enabling you to locate the chapter you want. Depending on the disc, chapters may not be recorded.

Track (Video CD and audio CD only)

Sections of a picture or a musical piece on a video CD or an audio CD. Each track is assigned a track number, enabling you to locate the track you want.

Scene

On a video CD with PBC (Playback control) functions, moving pictures and still pictures are divided into sections called “Scenes”. Each scene is displayed in the menu screen and assigned a scene number, enabling you to locate the scene you want.

A scene is composed of one or several tracks.

Types of video CDs

There are two types of video CDs:

Video CDs equipped with PBC (Version 2.0)

PBC (Playback control) functions allow you to interact with the system via menus, search functions, or other typical computer-like operations. Moreover, still pictures of high resolution can be played if they are included in the disc.

Video CDs not equipped with PBC (Version 1.1)

Operated in the same way as audio CDs, these discs allow playback of video pictures as well as sound, but they are not equipped with PBC.

Before Use (Continued)

Precautions

Handling the unit

When shipping the unit

The original shipping carton and packing materials come in handy. For maximum protection, re-pack the unit as it was originally packed at the factory.

When setting up the unit

The picture and sound of a nearby TV, VCR, or radio may be distorted during playback. In this case, position the unit away from the TV, VCR, or radio, or turn off the unit after removing the disc.

To keep the exterior surfaces clean

Do not use volatile liquids, such as insecticide spray, near the unit. Do not leave rubber or plastic products in contact with the unit for a long period of time. They will leave marks on the surface.

Cleaning the unit

To clean the cabinet

Use a soft, dry cloth. If the surfaces are extremely dirty, use a soft cloth lightly moistened with a mild detergent solution. Do not use strong solvents such as alcohol, benzene, or thinner, as these might damage the surface of the unit.

To obtain a clear picture

The DVD player is a high-tech, precision device. If the optical pick-up lens and disc drive parts are dirty or worn, the picture quality will be poor. Regular inspection and maintenance are recommended after every 1,000 hours of use. (This depends on the operating environment.) For details, please contact your nearest dealer.

Remote Control Operation Range

Point the remote control at the remote sensor and press the buttons.

- **Distance:** About 16 ft (5 m) from the front of the remote sensor.
- **Angle:** About 30° in each direction of the front of the remote sensor.

Remote control battery installation

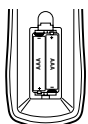

Detach the battery cover on the rear of the remote control, and insert two R03 (size AAA) batteries with **+** and **-** aligned correctly.



Caution
Do not mix old and new batteries. Never mix different types of batteries (standard, alkaline, etc.).

Notes on Discs

Handling discs

Do not touch the playback side of the disc. Hold the disc by the edges so that fingerprints will not get on the surface. Do not stick paper or tape on the disc.

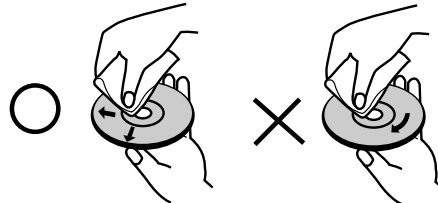

Storing discs

After playing, store the disc in its case. Do not expose the disc to direct sunlight or sources of heat, or leave it in a parked car exposed to direct sunlight, as there may be a considerable temperature increase inside the car.

Cleaning discs

Fingerprints and dust on the disc can cause poor picture quality and sound distortion. Before playing, clean the disc with a clean cloth. Wipe the disc from the center out.



Do not use strong solvents such as alcohol, benzene, thinner, commercially available cleaners, or anti-static spray intended for older vinyl records.







About Symbols

About the symbol display

“” may appear on the TV screen during operation. This icon means the function explained in this owner's manual is not available on that specific DVD video disc.

About the disc symbols for instructions

A section whose title has one of the following symbol is applicable only to the disc represented by the symbol.

-  DVD
-  Video CDs with the PBC (playback control) function.
-  Video CDs without the PBC (playback control) function.
-  Audio CDs.
-  MP3 discs.
-  WMA discs.
-  JPEG discs.

Front Panel and Display Window

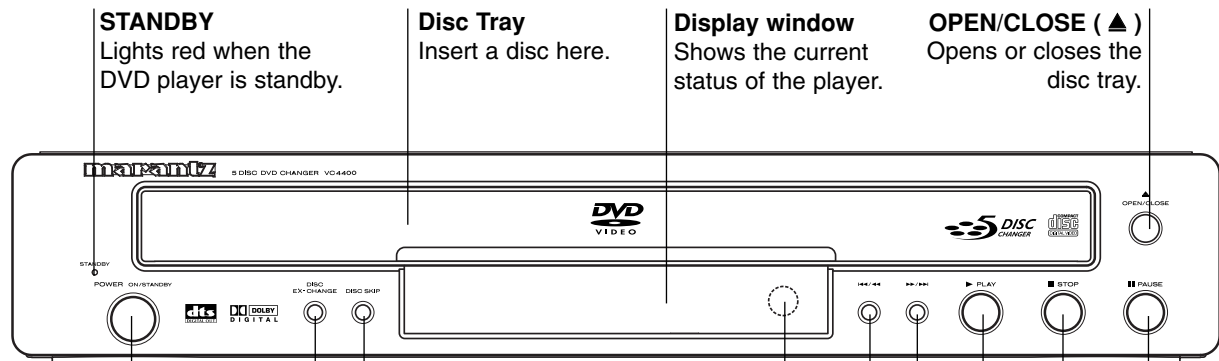

STANDBY
Lights red when the DVD player is standby.

Disc Tray
Insert a disc here.

Display window
Shows the current status of the player.

OPEN/CLOSE (▲)
Opens or closes the disc tray.

POWER ON/STANDBY
Switches the player ON and STANDBY.

DISC SKIP
Moves to the next available disc tray.

Remote Sensor

Reverse Skip/Scan (◀◀ / ▶▶)
Go to beginning of current chapter/track or to PREVIOUS chapter/track.
Press and hold for two seconds for a fast reverse search.

Forward Skip/Scan (▶▶ / ▶▶▶)
Go to NEXT chapter/track.
Press and hold for two seconds for a fast forward search.

DISC EX-CHANGE
Changes a disc (other than the one playing) during playback

PLAY (▶)
Starts playback.

STOP (■)
Stops playback.

PAUSE (||)
Pause playback temporarily/ press repeatedly for frame-by-frame playback.

ANGLE Lights when multi angles are present.

A light will appear if a disc is in the disc tray. The current disc tray flashes.

- DVD** DVD inserted
- CD** Audio CD inserted
- VCD** Video CD inserted
- MP3** MP3 or WMA disc inserted

Indicates current player function: Playback, Pause, etc.

TITLE Indicates current title number

CHP/TRK Indicates current chapter or track number

Indicates total playing time/elapsed time

PROG. Programmed playback active

RANDOM RANDOM playback active

Indicates repeat mode

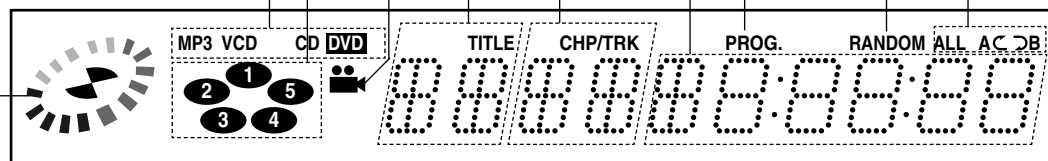

Remote Control

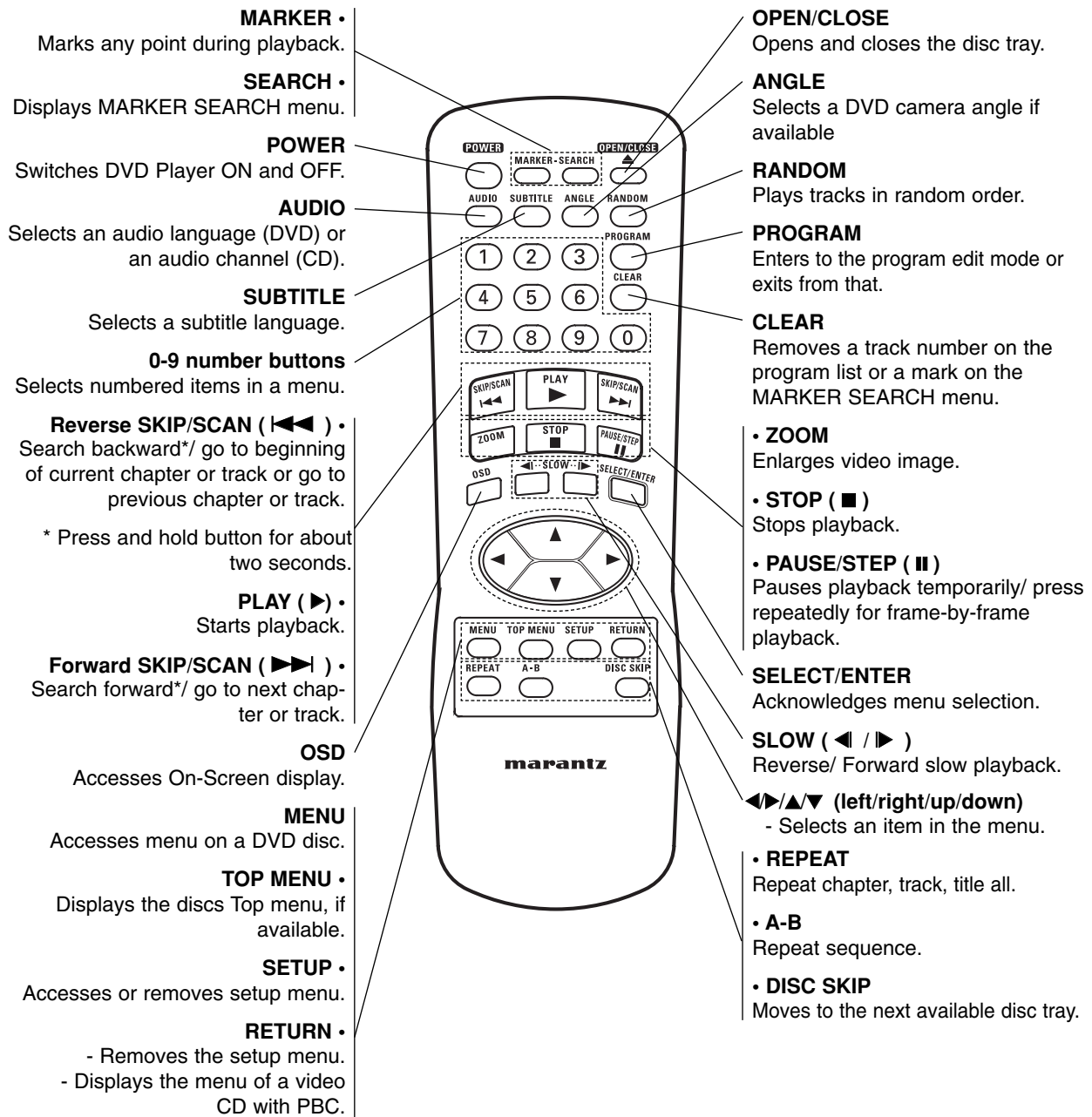

Setting Remote control codes of Remote control

- This remote control supports two remote control codes: C004 and C044.
- When the unit is shipped from the factory, the remote control is set to C004.
- To set the remote control to C044, hold down both the STOP button and "2" number button on the remote control for at least five seconds.
- You can change the code of remote control only when NO DISC appears in the display window.
- To set the remote control back to C004, hold down both the STOP button and "1" number button on the remote control for at least five seconds.
- Also set the remote control codes of the player to the same setting as the remote control.
(This setting is set to C004, when the unit is shipped from the factory.) (page 25)

Rear Panel

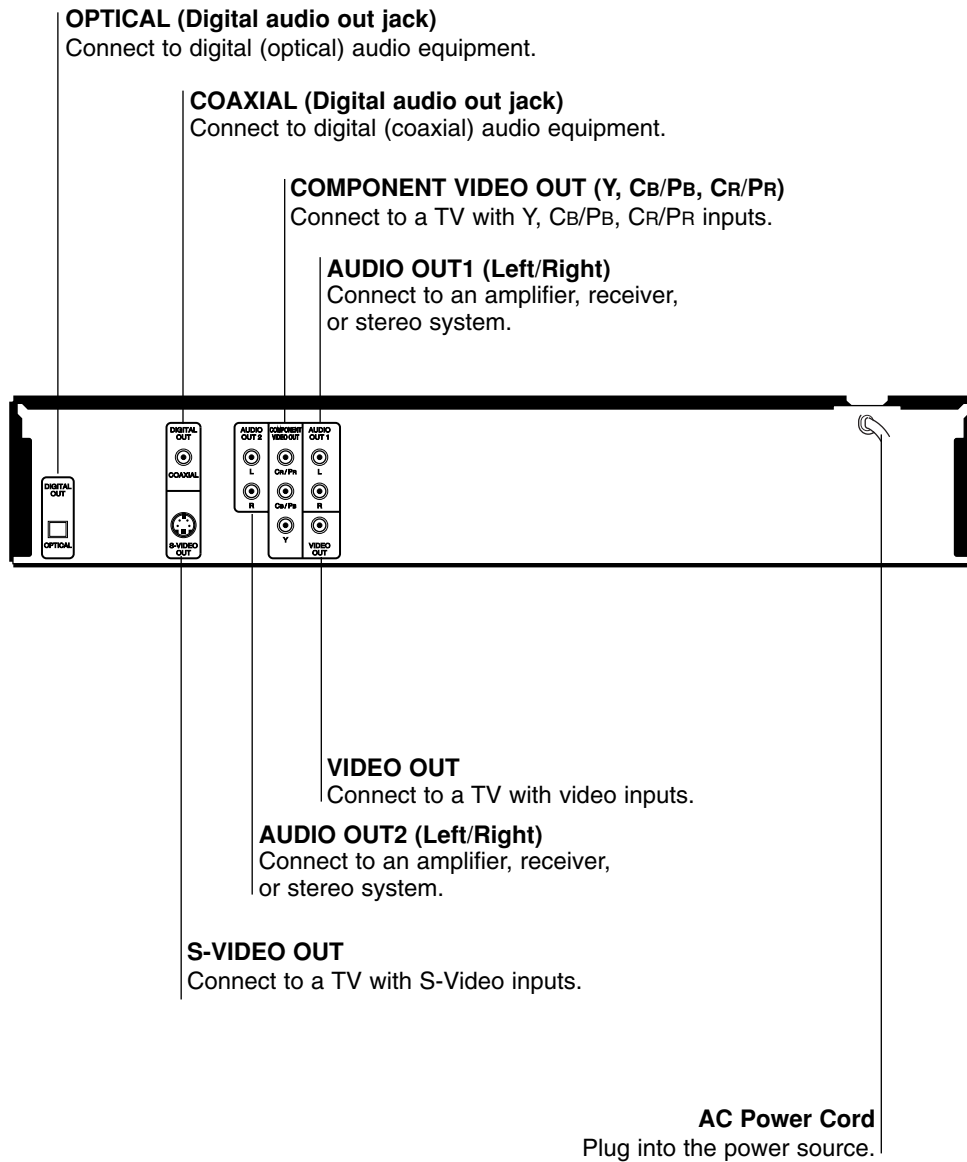

Caution

Do not touch the inner pins of the jacks on the rear panel. Electrostatic discharge may cause permanent damage to the unit.

Connections

Tips

- Depending on your TV and other equipment you wish to connect, there are various ways you could connect the player. Use only one of the connections described below.
- Please refer to the manuals of your TV, VCR, Stereo System or other devices as necessary to make the best connections.
- For better sound reproduction, connect the player's AUDIO OUT jacks to the audio in jacks of your amplifier, receiver, stereo or audio/video equipment. See "Connecting to Optional Equipment" on page 11.

Caution

- Make sure the DVD Player is connected directly to the TV. Tune the TV to the correct video input channel.
- Do not connect the DVD Player's AUDIO OUT jack to the phono in jack (record deck) of your audio system.
- Do not connect your DVD Player via your VCR. The DVD image could be distorted by the copy protection system.

Connecting to a TV

- Make one of the following connections, depending on the capabilities of your existing equipment.

Video connection

- 1 Connect the VIDEO OUT jack on the DVD Player to the video in jack on the TV using the video cable (V).
- 2 Connect the Left and Right AUDIO OUT jacks of the DVD Player to the audio left/right in jacks on the TV (A) using the audio cables.

S-Video connection

- 1 Connect the S-VIDEO OUT jack on the DVD Player to the S-Video in jack on the TV using the S-Video cable (S).
- 2 Connect the Left and Right AUDIO OUT jacks of the DVD Player to the audio left/right in jacks on the TV (A) using the audio cables.

Component Video (Color Stream®) connection

- 1 Connect the COMPONENT VIDEO OUT jacks on the DVD Player to the corresponding in jacks on the TV using an Y, Cb/Pb, CR/PR cable (C).
- 2 Connect the Left and Right AUDIO OUT jacks of the DVD Player to the audio left/right in jacks on the TV (A) using the audio cables.

Notes

- Refer to the owner's manual of your TV as well.
- Before you connect the DVD player to your TV, be sure to turn off the power and unplug both units from the wall outlet before making any connections.

Progressive Scan (Color Stream® pro) connection

- If your television is a high-definition or "digital ready" television, you may take advantage of the DVD Player's progressive scan output for the highest video resolution possible.
- If your TV does not accept the Progressive Scan format, the picture will appear scrambled if you try Progressive Scan on the DVD Player.

- 1 Connect the COMPONENT VIDEO OUT jacks on the DVD Player to the corresponding in jacks on the TV using an optional Y, Cb/Pb, CR/PR cable (C).
- 2 Connect the Left and Right AUDIO OUT jacks of the DVD Player to the audio left/right in jacks on the TV (A) using the supplied audio cables.

Notes

- Set the Progressive to "On" on the setup menu for progressive signal, see page 13.
- Progressive scan does not work with the analog video connections (yellow VIDEO OUT and S-VIDEO OUT jack). (See "Video mode setting", page 25)

Rear of TV

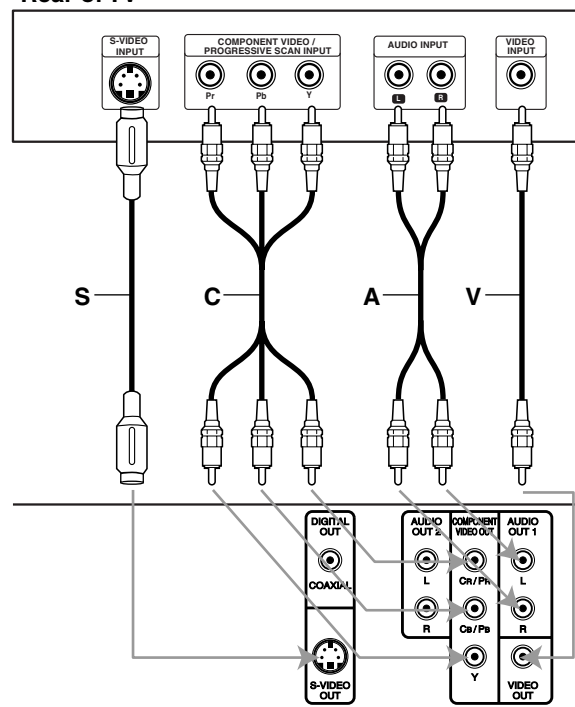

Rear of DVD player

Caution

- Do not set the Digital Audio Output of this DVD player to "Dolby Digital" unless you are connecting the DIGITAL OUT jack of this DVD player to an AV decoder that has the Dolby Digital decoding function. High volume sound may damage your hearing as well as the speakers.

Connections (Continued)

Connecting to Optional Equipment

Connecting to an amplifier equipped with two channel analog stereo or Dolby Pro Logic II/ Pro Logic

Connect the Left and Right AUDIO OUT jacks on the DVD Player to the audio left and right in jacks on your amplifier, receiver, or stereo system, using the audio cables (A).

Connecting to an amplifier equipped with two channel digital stereo (PCM) or to an Audio/ Video receiver equipped with a multi-channel decoder (Dolby Digital™, MPEG 2, or DTS)

- 1 Connect one of the DVD Player's DIGITAL AUDIO OUT jacks (OPTICAL **O** or COAXIAL **X**) to the corresponding in jack on your amplifier. Use an optional digital (optical **O** or coaxial **X**) audio cable.
- 2 You will need to activate the player's digital output. (See "Digital Audio Output" on page 14).

Digital Multi-channel sound

A digital multi-channel connection provides the best sound quality. For this you need a multi-channel Audio/Video receiver that supports one or more of the audio formats supported by your DVD Player (MPEG 2, Dolby Digital and DTS). Check the receiver manual and the logos on the front of the receiver.



Caution:

Due to the DTS Licensing agreement, the digital output will be in DTS digital out when DTS audio stream is selected.



Notes

- If the audio format of the digital output does not match the capabilities of your receiver, the receiver will produce a strong, distorted sound or no sound at all.
- Six Channel Digital Surround Sound via digital connection can only be obtained if your receiver is equipped with a Digital Multi-channel decoder.
- To see the audio format of the current DVD in the on-screen display, press AUDIO.

Rear of DVD player

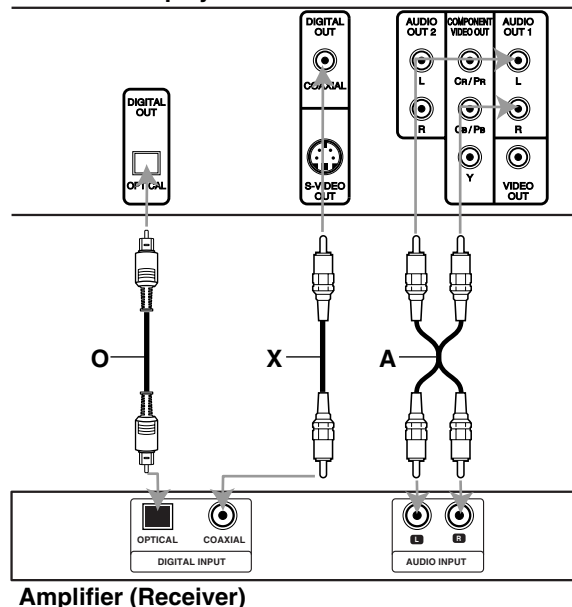

Amplifier (Receiver)

Notes

- Refer to the owner's manual of your audio system as well.
- Before you connect the DVD player to other equipment, be sure to turn off the power and unplug all of the equipment from the wall outlet before making any connections.
- If you place the DVD player near a tuner or radio, the radio broadcast sound might be distorted. In this case, move the DVD player away from the tuner and radio.
- The output sound of the DVD player has a wide dynamic range. Be sure to adjust the receiver's volume to a moderate listening level. Otherwise, the speakers may be damaged by a sudden high volume sound.
- Turn off the receiver before you connect or disconnect the DVD player's power cord. If you leave the receiver power on, the speakers may be damaged.

Before Operation

General Explanation

This manual gives basic instructions for operating the DVD Player. Some DVDs require specific operation or allow only limited operation during playback. When this occurs, the symbol  appears on the TV screen, indicating that the operation is not permitted by the DVD Player or is not available on the disc.







On-Screen Display

General playback status can be displayed on the TV screen. Some items can be changed on the menu.





On-screen display operation

- 1** Press OSD during playback.
- 2** Press **▲/▼** to select an item.
The selected item will be highlighted.
- 3** Press **◀▶** to change the setting of an item.
The number buttons can be also be used for setting numbers (e.g., title number). For some functions, press SELECT/ENTER to execute the setting.









DVD

| Items | | Function (Press ▲/▼ to select desired item) | Selection Method |
|--|--|--|---------------------------------|
| Title Number |  1 / 3 | Shows the current title number and total number of titles, and skips to the desired title number. | ◀ / ▶, or Numbers, SELECT/ENTER |
| Chapter Number |  1 / 12 | Shows the current chapter number and total number of chapters, and skips to the desired chapter number. | ◀ / ▶, or Numbers, SELECT/ENTER |
| Time search |  0:20:09 | Shows the elapsed playing time, and searches the point by the elapsed time directly. | Numbers, SELECT/ENTER |
| Audio language and Digital Audio Output mode |  1 ENG DOLBY 5.1 CH | Shows the current audio soundtrack language, encoding method, and channel number, and changes the setting. | ◀ / ▶, or AUDIO |
| Subtitle language |  OFF | Shows the current subtitles language, and changes the setting. | ◀ / ▶, or SUBTITLE |
| Angle |  1 / 1 | Shows the current angle number and total number of angles, and changes the angle number. | ◀ / ▶, or ANGLE |
| Sound |  NORM. | Shows the current sound mode (NORMAL or 3D SURROUND), and changes the setting. | ◀ / ▶ |

VCD2.0 VCD1.1

| Items | | Function (Press ▲/▼ to select desired item) | Selection Method |
|---------------|---|---|---------------------------------|
| Track Number |  1 / 4 | Shows the current track number, total number of tracks and PBC On mode, and skip to the desired track number. | ◀ / ▶, or Numbers, SELECT/ENTER |
| Time |  0:20:09 | Shows the elapsed playing time (Display only) | - |
| Audio Channel |  STER. | Shows the audio channel, and changes the audio channel. | ◀ / ▶, or AUDIO |
| Sound |  NORM. | Shows the current sound mode (NORMAL or 3D SURROUND), and changes the setting. | ◀ / ▶ |

Temporary Feedback Field Icons

-  TITLE Repeat Title
-  CHAPT Repeat Chapter
-  TRACK Repeat Track (non-PBC Video CDs only)
-  ALL Repeat All Tracks (non-PBC Video CDs only)
-  A B Repeat A-B
-  OFF Repeat Off
-  II Resume play from this point
-  Action prohibited or not available

Notes

- Some discs may not provide all of the features on the on-screen display example shown below.
- If no button is pressed for 10 seconds, the on-screen display disappears.

Before Operation (Continued)

Initial Settings

You can set your own Personal Preferences on the player.

Initial Settings General Operation

- 1 Press **SETUP**.
The setup menu appears.



- 2 Press **▲/▼** to select the desired item.
The screen will show the current setting for the selected item, as well as alternate setting(s).
- 3 While the desired item is selected, press **▶**, then **▲/▼** to select the desired setting.
- 4 Press **SELECT/ENTER** to confirm your selection.
Some items require additional steps.
- 5 Press **SETUP**, **RETURN**, or **PLAY** to exit the setup menu.

Language

Disc Language **DVD**

Select a language for the disc's Menu, Audio, and Subtitle.

Original : The original language set for the disc is selected.
Other : To select another language, press number buttons to enter the corresponding 4-digit number according to the language code list on page 27. If you enter the wrong language code, press **CLEAR**.

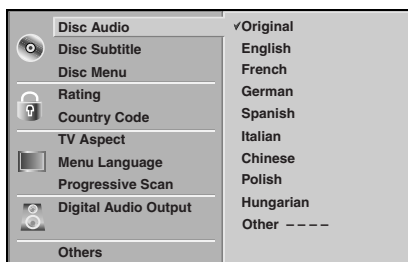

Menu Language

Select a language for the setup menu. This is the menu you see when you press **SETUP**.

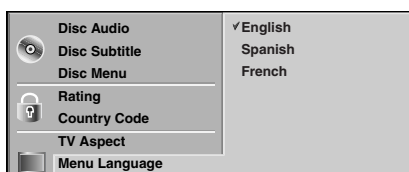

Picture

TV Aspect **DVD**

4:3 Letterbox: Select when a standard 4:3 TV is connected. Displays theatrical images with masking bars above and below the picture.

4:3 Panscan: Select when a conventional TV set is connected. The video material formatted in the Pan & Scan style is played back in that style (Both sides of the picture are cut off).

16:9 Wide: Select when a 16:9 wide TV is connected.

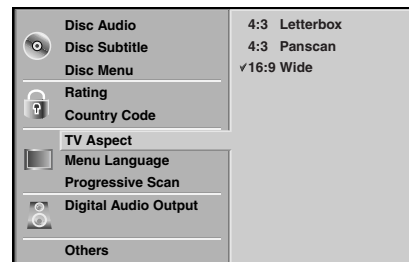

Progressive Scan **DVD**

Progressive Scan Video provides the highest quality pictures with less flickering.

If you are using the **COMPONENT VIDEO OUT** jacks, but are connecting the DVD Player to a standard (analog) television, set Progressive Scan to Off.

If you are using the Component Video jacks for connection to a TV or monitor that is compatible with a progressive scan signal, set Progressive Scan to On.

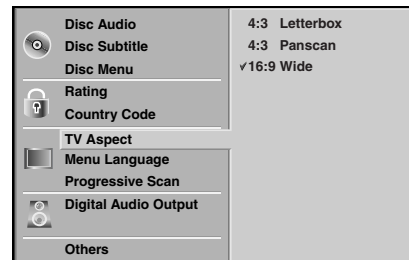

Caution

Once the setting for progressive scan output is entered, an image will only be visible on a progressive scan compatible TV or monitor. If you set Progressive Scan to On in error, you must reset the unit. Press **STOP** to stop any disc that is playing. Next, press **STOP** again and hold it for five seconds before releasing it. The video output will be restored to the standard setting, and a picture will once again be visible on a conventional analog TV or monitor.

Before Operation (Continued)

Sound

Digital Audio Output

Each DVD disc has a variety of audio output options. Set the player's Digital Audio Output according to the type of audio system you use.

DOLBY DIGITAL/PCM: Select "DOLBY DIGITAL/PCM" if you connected the DVD Player's DIGITAL OUT jack to a Dolby Digital decoder (or an amplifier or other equipment with a Dolby Digital decoder).

Stream/PCM: Select "Stream/PCM" if you connected the DVD Player's DIGITAL OUT jack to an amplifier or other equipment with a DTS decoder, Dolby Digital decoder or MPEG decoder.

PCM: Select when connected to a 2-channel digital stereo amplifier. The DVD player outputs sounds in the PCM 2ch format when you play a DVD video disc recorded on the Dolby Digital, MPEG1, or MPEG2 recording system.

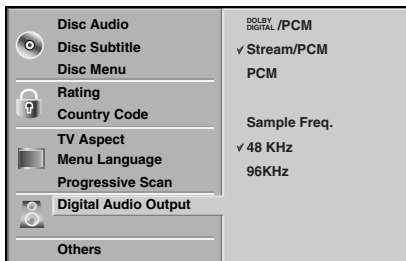

Sample Frequency

To change the Sample Frequency setting, first select the desired Digital Audio Output as indicated as above. If your receiver or amplifier is NOT capable of handling 96KHz signals, select 48KHz. When this choice is made, this unit will automatically convert any 96KHz signals to 48KHz so your system can decode them. If your receiver or amplifier is capable of handling 96KHz signals, select 96KHz. When this choice is made, this unit will pass each type of signal through without any further processing.

Others

The DRC, Vocal, PBC and Auto Play settings can be changed.

- Press ▲/▼ to select the desired item and press SELECT/ENTER. The setting of the selected item is changed between On and Off.



Dynamic Range Control (DRC) **DVD**

With the DVD format, you can hear a program's soundtrack in the most accurate and realistic presentation possible, thanks to digital audio technology. However, you may wish to compress the dynamic range of the audio output (the difference between the loudest sounds and the quietest ones). Then, you may listen to a movie at a lower volume without losing clarity of sound. Set DRC to On for this effect.

Vocal **DVD**

Set Vocal to On only when a multi-channel karaoke DVD is playing. The karaoke channels on the disc will mix into normal stereo sound.

PBC **VCD2.0**

Set Playback Control (PBC) to On or Off.

On: Video CDs with PBC are played according to the PBC.

Off: Video CDs with PBC are played the same way as Audio CDs.

Auto Play **DVD**

You can set up the DVD Player so a DVD disc automatically starts playing whenever the DVD is inserted.

If Auto Play mode is set to On, this DVD player will search a title that playback time is long most and then play back the title automatically.

On: Auto Play function is activated.

Off: Auto Play function is not activated.

Note

The Auto Play function may not work for some DVDs.

Before Operation (Continued)

Parental Control

Rating **DVD**

Movies on DVDs may contain scenes not suitable for children. Therefore, discs may contain Parental Control information that applies to the complete disc or to certain scenes on the disc. These scenes are rated from 1 to 8, and alternatively, more suitable scenes are available for selection on some discs. Ratings are country-dependent. The Parental Control feature allows you to prevent discs from being played by your children or to have certain discs played with alternative scenes.

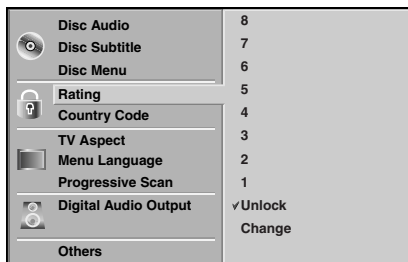

1 Select "Rating" on the Setup menu using the ▲▼ buttons.

2 While "Rating" is selected, press ►.

3 When you have not entered a password yet. Enter a 4-digit password using the numbered buttons to create a personal 4-digit security password. then press SELECT/ENTER. Enter the 4-digit password again and press SELECT/ENTER to verify. **When you have already entered a password;** Enter a 4-digit password using the numbered buttons to confirm the personal 4-digit security password, then press SELECT/ENTER.

If you make a mistake before pressing SELECT/ENTER, press CLEAR and enter 4-digit security password again.

4 Select a rating from 1 to 8 using the ▲▼ buttons. One (1) has the least playback restrictions. Eight (8) has the most playback restrictions.

Unlock: If you select Unlock, Parental Control is not active. The disc will play in full.

Ratings 1 to 8: Some discs contain scenes not suitable for children. If you set a rating for the player, all disc scenes with the same rating or lower will be played. Higher rated scenes will not be played unless an alternative scene is available on the disc. The alternative must have the same rating or a lower one. If no suitable alternative is found, playback will stop. You must enter the 4-digit password or change the rating level in order to play the disc.

5 Press SELECT/ENTER to confirm your rating selection, then press SETUP to exit the menu.

Country Code **DVD**

Enter the code of a country/area whose standards were used to rate the DVD video disc, referring to the list (See "Country Code List", page 28.).

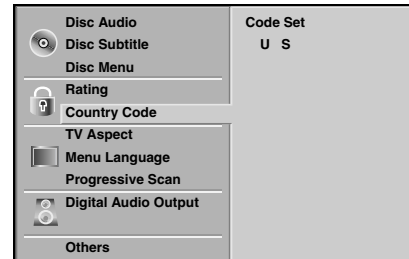

1 Select Country Code using the ▲▼ buttons on the setup menu.

2 While Country Code is selected, press ►.

3 Follow step 3 of "Rating" on left.

4 Select the first character using the ▲▼ buttons.

5 Shift the cursor using ► button and select the second character using ▲▼ buttons.

6 Press SELECT/ENTER to confirm your country code selection, then press SETUP to exit the menu.

N Note

Confirmation of the 4-digit password is necessary when the code is changed (see "Changing the 4-digit code" below.).

Changing the 4-digit code

- 1 Follow Steps 1-2 as shown above to the left (Rating).
- 2 Enter the old code, then press SELECT/ENTER.
- 3 Select Change using ▲▼ buttons then press SELECT/ENTER.
- 4 Enter the new 4-digit code, then press SELECT/ENTER.
- 5 Enter exactly the same code a second time and verify by pressing SELECT/ENTER.
- 6 Press SETUP to exit the menu.

If you forget your 4-digit code

If you forget your password, to clear the current password, follow the procedure below.

- 1 Press SETUP to display the setup menu.
- 2 Use the Number buttons to enter the 6-digit number "210499".
The 4-digit password is cleared. "P CLR" appears on the display for a moment.
- 3 Enter a new code as shown above to the left (Rating).

Operation with DVD and Video CD

Playing a DVD and Video CD

T Playback Setup **DVD** **VCD2.0** **VCD1.1**

- Turn on the TV and select the video input source connected to the DVD player.
- Audio system: Turn on the audio system and select the input source connected to the DVD player.

1 Press OPEN/CLOSE to open the disc tray.

2 Load your chosen disc in the tray, with the playback side down.

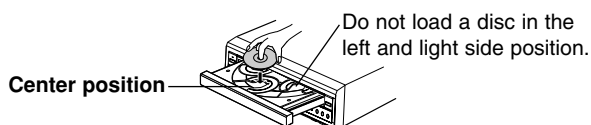

- Discs can be loaded one at a time by pressing DISC SKIP to rotate the carousel.

3 Press OPEN/CLOSE to close the tray.

READING appears on the TV screen, and playback starts automatically. If playback does not start, press PLAY.

In some cases, the disc menu might appear instead.

T If a menu screen is displayed

The menu screen may be displayed first after loading a DVD or Video CD which offer a menu.

DVD

Use the ◀▶/▲▼ buttons to select the title/chapter you want to view, then press SELECT/ENTER to start playback.

Press TOP MENU or MENU to return to the menu screen.

VCD2.0

- Use the number buttons to select the track you want to view.
Press RETURN to return to the menu screen.
- Menu setting and the exact operating procedures for using the menu may differ depending on the disc. Follow the instructions on the each menu screen. You also may set PBC to Off under setup. See page 14.

⚠ Caution

- Do not touch the loading drawer and carousel while they are in motion, and do not attempt to rotate the carousel by hand; doing so could result in incorrect operation of the player and/or damage to the discs.

N Notes

- If Parental Control is set and the disc is not within the Rating settings (not authorized), the 4-digit code must be entered and/or the disc must be authorized (see “Parental Control”, on page 15).
- DVDs may have a region code. Your player will not play discs that have a region code different from your player. The region code for this player is 1 (one).

Exchanging discs during playback

- Press DISC EX-CHANGE on the front panel during playback to open the disc tray.
- Press DISC SKIP to rotate the disc trays to the desired position. The carousel will rotate clockwise by one disc increments.
- Exchange the discs and press DISC EX-CHANGE or OPEN/CLOSE to close the disc tray.

N Note

- The disc tray presently loaded in the play position can not be exchanged.

Skipping discs

Press DISC SKIP during play or when playback is stopped.

N Notes

- When DISC SKIP is pressed, the disc tray rotates and playback begins from the beginning of the next disc.
- If there is no disc on the next disc tray, the following disc tray will be selected.
- When DISC SKIP is pressed during playback of disc 5, playback of disc 1 will start.

Exchanging the disc and starting playback

1. Press OPEN/CLOSE during playback or when playback is stopped.
Play stops (if pressed during playback), the disc tray opens and the disc that was in the play position comes to the front.
2. Exchange the disc.
3. Press OPEN/CLOSE or PLAY again.
The tray closes and playback begins (with the disc that was in front).

After operation

When the unit is not in use, remove the disc and press POWER to turn off the DVD player.

N Notes

- Do not move the DVD player during playback. Doing so may damage the disc and the DVD player.
- Use the OPEN/CLOSE button on the remote control or DVD player to open and close the disc tray. Do not push the disc tray while it is moving. Doing so may cause the DVD player to malfunction.
- Do not push up the disc tray or put any objects other than discs on the disc tray. Doing so may cause the DVD video player to malfunction.
- Keep your fingers well clear of the disc tray as it is closing. Be especially careful with children's fingers around the closing disc tray as there is a risk of personal injury.

Operation with DVD and Video CD

General Features

Note

Unless stated otherwise, all operations described use the remote control. Some features may also be available on the Setup menu.





Moving to another TITLE

When a disc has more than one title, you can move to another title as follows:

- Press OSD, then press the appropriate numbered button (0-9) to select a title number.

Moving to another CHAPTER/TRACK 1/12 1/3



















When a title on a disc has more than one chapter or a disc has more than one track, you can move to another chapter/track as follows:

- Press SKIP/SCAN  or  briefly during playback to select the next chapter/track or to return to the beginning of the current chapter/track.
- Press  twice briefly to step back to the previous chapter/track.
- To go directly to any chapter/track during DVD playback, press OSD. Then, press / to select the chapter/track icon. Then, enter the chapter/track number using the numbered buttons (0-9).

Note

For two-digit numbers, press the numbered buttons (0-9) in rapid succession.













Search

- 1 Press and hold SKIP/SCAN  or  for about two seconds during playback.
The player will now go into SEARCH mode.
- 2 Press and hold SKIP/SCAN  or  repeatedly to select the required speed: X2, X4, X16, X100 (backward) or X2, X4, X16, X100 (forward).
With a Video CD, the Search speed changes: X2, X4, X8, (backward) or X2, X4, X8, (forward).
- 3 To exit SEARCH mode, press PLAY.

Still Picture and Frame-by-Frame playback

- 1 Press PAUSE/STEP during playback.
The player will now go into PAUSE mode.
- 2 You can advance the picture frame-by-frame by pressing PAUSE/STEP repeatedly on the remote control.

Slow Motion

- 1 Press SLOW  or  during playback.
The player will enter SLOW mode.
- 2 Use the SLOW  or  to select the required speed:  1/16,  1/8,  1/4 or  1/2 (backward), or  1/16,  1/8,  1/4 or  1/2 (forward).
- 3 To exit slow motion mode, press PLAY.

Notes

Slow motion playback in reverse is not applicable for Video CD.

Random

- 1 Press RANDOM during playback or in stop mode.
The unit automatically begins Random Playback and "RANDOM(1-3)" appears on the display window.
 - RANDOM1: Plays all the tracks on a single disc in random order and then stops.
 - RANDOM2: Plays all the tracks on current disc in random order and then plays all the tracks on each succeeding disc in random order and then stops.
 - RANDOM3: Plays 2 tracks randomly from a disc and then plays 2 tracks randomly from a different disc until all tracks on all discs have been played.
- 2 To return to normal playback, press RANDOM until "RANDOM" disappears on the display window.

Tips

By pressing SKIP/SCAN  during Random playback, the unit selects another title (track) and resumes Random playback.

Notes

- This function only works with DVD Karaoke discs and video CD without PBC.
- DVD karaoke works only RANDOM 1 function.
- On a Video CD with PBC, you must set PBC to Off on the setup menu to use the Random function. See page 14.

Operation with DVD and Video CD

General Features (continued)

Repeat A-B



To repeat a sequence in a title :

- 1 Press A-B at your chosen starting point.
“A *” appears briefly on the TV screen.
- 2 Press A-B again at your chosen end point.
“A B” appears briefly on the TV screen, and the repeat sequence begins (“A↔B” appears the display window).
- 3 To cancel the sequence, press A-B.

Repeat



DVD Video Discs - Repeat Chapter/Title/All/Off

- 1 To repeat the currently playing chapter, press REPEAT.
The Repeat Chapter icon appears on the TV screen.
- 2 To repeat the title currently playing, press REPEAT a second time.
The Repeat Title icon appears on the TV screen.
- 3 To repeat entire all disc contents, press REPEAT a third time.
The Repeat All icon appears on the TV screen.
- 4 To exit Repeat mode, press REPEAT a fourth time.
The Repeat Off icon appears on the TV screen.

Video CDs - Repeat Track/Disc/All/Off

- 1 To repeat the track currently playing, press REPEAT.
The Repeat Track icon appears on the TV screen.
- 2 To repeat the disc currently playing, press REPEAT a second time.
The Repeat Disc icon appears on the TV screen.
- 3 To repeat entire all disc contents, press REPEAT a third time.
The Repeat All icon appears on the TV screen.
- 4 To exit Repeat mode, press REPEAT a fourth time.
The Repeat Off icon appears on the TV screen.

Note

On a Video CD with PBC, you must set PBC to Off on the setup menu to use the Repeat function. See page 14.

Time Search

The Time Search function allows you to start playing at any chosen time on the disc.

- 1 Press OSD during playback. The on-screen display appears on the screen.
The Time Search box shows the elapsed playing time of the current disc.
- 2 Within 10 seconds, press ▲/▼ to select the Time Search icon in the on-screen display.
The “-:-:-:-” appears in the Time Search box.
- 3 Within 10 seconds, use the number buttons to enter the required start time. Enter hours, minutes, and seconds from left to right in the box.
If you enter the wrong numbers, press CLEAR to remove the numbers you entered. Then enter the correct numbers.
- 4 Within 10 seconds, press SELECT/ENTER to confirm the start time.
Playback starts from the selected time on the disc. If you enter an invalid time, playback will continue from the current point.

3D Surround

This unit can produce a 3D Surround effect, which simulates multi-channel audio playback from two conventional stereo speakers, instead of the five or more speakers normally required to listen to multi-channel audio from a home theater system.

- 1 Press OSD during playback.
- 2 Press ▲ or ▼ to select the sound option.
The sound option will be highlighted.
- 3 Press ◀ or ▶ to select “3D SUR”.
To turn off the 3D Surround effect, select “NORM”.

Zoom

The Zoom function allows you to enlarge the video image and to move through the enlarged image.

- 1 Press ZOOM during playback or still playback to activate the Zoom function.
If you press ZOOM repeatedly, the magnification level increases up to six steps.
- 2 Use the ◀▶/▲▼ buttons to move through the zoomed picture.
- 3 Press CLEAR to resume normal playback or return to the paused image.

Note

The zoom function may not work for some DVDs.

Operation with DVD and Video CD

General Features (continued)

Marker Search **DVD** **VCD2.0** **VCD1.1**



You can start playback from a memorized point. Up to nine points can be memorized.

To enter a mark, follow these steps.

- 1 During disc playback, press **MARKER** when playback reaches the spot that you want to memorize.
The Marker icon will appear on the TV screen briefly.
- 2 Repeat step 1 to enter up to nine Marker points on a disc.

To Recall a Marked Scene

- 1 During disc playback, press **SEARCH**.
The **MARKER SEARCH** menu will appear on the screen.
- 2 Within 10 seconds, press **◀▶** to select a Marker number that you want to recall.
- 3 Press **SELECT/ENTER**.
Playback will start from the Marked scene.
- 4 To remove the **MARKER SEARCH** menu, press **SEARCH**.

To clear a Marked Scene

- 1 During disc playback, press **SEARCH**.
The **MARKER SEARCH** menu will appear on the screen.
- 2 Press **◀▶** to select the Marker number that you want to erase.
- 3 Press **CLEAR**.
The Marker number will be erased from the list.
- 4 Repeat steps 2 and 3 to erase additional Marker numbers.
- 5 To remove the **MARKER SEARCH** menu, press **SEARCH**.

Special DVD Features **DVD**

Checking the contents of DVD discs: Menus

DVDs may offer menus that allow you to access special features. To use the disc menu, press **MENU**. Then, press the appropriate number button to select an option. Or, use the **◀▶/▲▼** buttons to highlight your selection, then press **SELECT/ENTER**.

Title Menu **DVD**

- 1 Press **TOP MENU**.
If the current title has a menu, the menu will appear on the screen. Otherwise, the disc menu may appear.
- 2 The menu can list camera angles, spoken language and subtitle options, and chapters for the title.
- 3 To remove the title menu, press **TOP MENU** again.

Disc Menu **DVD**

- 1 Press **MENU**.
The disc menu is displayed.
- 2 To remove the disc menu, press **MENU** again.

Camera Angle **DVD**

If the disc contains scenes recorded at different camera angles, you can change to a different camera angle during playback.

- Press **ANGLE** repeatedly during playback to select a desired angle.
The number of the current angle appears on the display.

Changing the Audio Language



Press **AUDIO** repeatedly during playback to hear a different audio language or audio track.

Changing the Audio Channel **VCD2.0** **VCD1.1**

Press **AUDIO** repeatedly during playback to hear a different audio channel (**STER.**, **LEFT** or **RIGHT**).

Subtitles **DVD**

Press **SUBTITLE** repeatedly during playback to see the different subtitle languages.

Note

If appears, the feature is not available on the disc.

Operation with Audio CD and MP3/WMA Disc

Playing an Audio CD and MP3/WMA Disc

CD **MP3** **WMA**

The DVD Player can play MP3/WMA formatted recordings on CD-ROM, CD-R or CD-RW discs. Before playing MP3/WMA recordings, read the notes on MP3/WMA Recordings on right.

- 1 Insert a disc and close the tray.**
Audio CD; Audio CD menu appears on the TV screen go to step 4.
MP3/WMA disc; The MP3/WMA-JPEG choice menu appears on the TV screen. Go to step 2



- 2 Press ▲/▼ to select the MP3/WMA then press SELECT/ENTER.**
The MP3/WMA menu appears on the TV screen. Press RETURN to move to the MP3/WMA-JPEG choice menu.

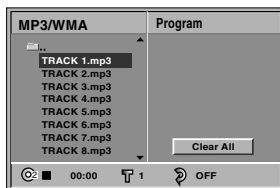

- 3 Press ▲/▼ to select a folder, and SELECT/ENTER.**
A list of files in the folder appears.

- 4 Press ▲/▼ to select a track then press PLAY or SELECT/ENTER.**
Playback starts.
During playback, the current track's elapsed playing time will appear on the display window and menu. Playback will stop at the end of the disc.
Press TOP MENU to move to the next page.
Press MENU to move to the previous page.

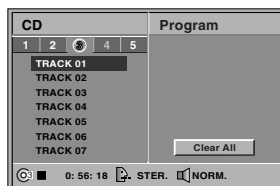

Audio CD menu

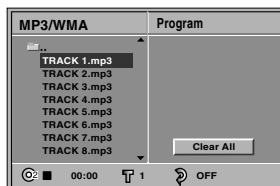

MP3/WMA menu



Tip
If you are in a file list and want to return to the Folder list, use the ▲/▼ to highlight and press SELECT/ENTER to return to the previous menu screen.

- 5 To stop playback at any other time, press STOP.**

Notes on MP3/WMA Recordings

About MP3

- An MP3 file is audio data compressed by using the MPEG1 audio layer-3 file-coding scheme. We call files that have the “.mp3” file extension “MP3 files”.
- The player can not read an MP3 file that has a file extension other than “.mp3”.

About WMA(Window Media Audio)

- An WMA file is a Microsoft audio compression technology.
- WMA(Windows Media Audio) offers double the audio compression of the MP3 format.

Microsoft, Windows Media, and the Windows Logo are trademarks or registered trademarks of Microsoft Corporation in both the United States and other countries



MP3/WMA Disc compatibility with this player is limited as follows:

1. Sampling Frequency / only at 44.1kHz (MP3), 22.05 - 44.1kHz (WMA)
2. Bit rate / within 32 - 320kbps (MP3), 32 - 128kbps (WMA)
3. CD-R physical format should be “ISO 9660”
4. If you record MP3/WMA files using the software which cannot create a FILE SYSTEM, for example “Direct-CD” etc., it is impossible to playback MP3/WMA files. We recommend that you use “Easy-CD Creator”, which creates an ISO9660 file system.
5. A single session disc requires MP3/WMA files in the first track. If there is no MP3/WMA file in the 1st track, it cannot playback MP3/WMA files. If you wish to playback MP3/WMA files, format all the data in the disc or use a new one.
6. File names should be named using 8 letters or less and must incorporate “.mp3” or “.wma” extension e.g. “*****.MP3” or “*****.WMA”.
7. Do not use special letters such as “/ : * ? “ < > ” etc.
8. Total number of files on the disc should be less than 650.

This DVD player requires discs/recordings to meet certain technical standards in order to achieve optimal playback quality. Pre-recorded DVDs are automatically set to these standards. There are many different types of recordable disc formats (including CD-R containing MP3 or WMA files). That require certain pre-existing conditions (see above) to insure compatible playback.

Customers should also note that permission is required in order to download MP3/WMA files and music from the Internet. Our company has no right to grant such permission. Permission should always be sought from the copyright owner.



- **Caution**
If you record a disc using a personal computer, even if it is recorded in a compatible format, there are cases in which it may not play because of the settings of the application software used to create the disc. (Check with the software publisher for more detailed information.)

Operation with Audio CD and MP3/WMA Disc (Continued)

Pause **CD** **MP3** **WMA**

- 1 Press PAUSE/STEP during playback.
- 2 To return to playback, press PLAY or press PAUSE/STEP again.

Moving to another Track **CD** **MP3** **WMA**

- Press SKIP/SCAN **◀◀** or **▶▶** briefly during playback to go to the next track or to return to the beginning of the current track.
- Press SKIP/SCAN **◀◀** twice briefly to step back to the previous track.
- In case of audio CD, to go directly to any track, enter the track number using the numbered buttons (0-9) during playback.

Search **CD** **MP3** **WMA**

- 1 Press and hold SKIP/SCAN **◀◀** or **▶▶** for about two seconds during playback.
The player will now go into SEARCH mode.
- 2 Press and hold SKIP/SCAN **◀◀** or **▶▶** repeatedly to select the required speed: **◀◀X2**, **◀◀X4**, **◀◀X8** (backward) or **▶▶X2**, **▶▶X4**, **▶▶X8** (forward).
Search speed and direction are indicated on the menu screen.
- 3 To exit SEARCH mode, press PLAY.

Random with MP3/WMA Disc **MP3** **WMA**

- 1 Press RANDOM during playback or when playback is stopped.
The unit automatically begins Random Playback and RANDOM or "RAND." appears on the display window and menu screen.
- 2 To return to normal playback, press RANDOM repeatedly until RANDOM or "RAND." disappears on the display window and menu screen.

Repeat Track/All/Off **MP3** **WMA**

- 1 To repeat the track currently playing, press REPEAT.
The Repeat icon and "TRACK" appears on the menu screen.
- 2 To repeat all tracks on a disc, press REPEAT a second time.
The Repeat icon and "ALL" appears on the menu screen.
- 3 To cancel Repeat mode, press REPEAT a third time.
The Repeat icon and "OFF" appears on the menu screen.

Random with Audio CD **CD**

- 1 Press RANDOM during playback or in stop mode.
The unit automatically begins Random Playback and "RANDOM(1-3)" appears on the display window.
 - RANDOM1: Plays all the tracks on a single disc in random order and then stops.
 - RANDOM2: Plays all the tracks on current disc in random order and then plays all the tracks on each succeeding disc in random order and then stops.
 - RANDOM3: Plays 2 tracks randomly from a disc and then plays 2 tracks randomly from a different disc until all tracks on all discs have been played.
- 2 To return to normal playback, press RANDOM until "RANDOM" disappears on the display window.

Repeat A-B **CD**

To repeat a sequence.

- 1 During disc playback, press A-B at your chosen starting point.
The Repeat icon and "A *" appears on the menu screen.
- 2 Press A-B again at your chosen end point.
The Repeat icon and "A B" appears on the menu screen, and the sequence begins to play repeatedly.
- 3 To exit the sequence and return to normal play, press A-B again.
The Repeat icon and "OFF" appears on the menu screen.

3D Surround **CD**

This unit can produce a 3D Surround effect, which simulates multi-channel audio playback from two conventional stereo speakers, instead of the five or more speakers normally required to listen to multi-channel audio from a home theater system.

- 1 Press OSD during playback.
- 2 Use **◀** or **▶** to select the sound option.
The sound option will be highlighted.
- 3 Use **▲** or **▼** to select "3D SUR".
To turn off the 3D Surround effect, select "NORM".

Changing the Audio Channel **CD**

Press AUDIO repeatedly during playback to hear a different audio channel (STER., LEFT, or RIGHT).

Repeat Track/Disc/All/Off **CD**

1. To repeat the track currently playing, press REPEAT.
The Repeat icon and "TRACK" appear on the menu screen.
2. To repeat all tracks on a disc, press REPEAT a second time.
The Repeat icon and "DISC" appear on the menu screen.
3. To repeat entire all disc contents, press REPEAT third time.
The Repeat icon and "All" appears on the menu screen.
4. To cancel Repeat mode, press REPEAT a fourth time.
The Repeat icon and "OFF" appear on the menu screen.

Operation with JPEG Disc

Viewing a JPEG disc **JPEG**

This DVD Player can play discs with JPEG files and Kodak picture CD. Before playing JPEG recordings, read the notes on JPEG Recordings on right.

- 1 Insert a disc and close the tray.**
The MP3/WMA-JPEG choice menu appears on the TV screen.



- 2 Press ▲/▼ to select the JPEG then press SELECT/ENTER.**
The JPEG menu appears on the TV screen.



- 3 Press ▲/▼ to select a folder, and SELECT/ENTER.**
A list of files in the folder appears.
Press RETURN to move to the MP3/WMA-JPEG choice menu.

T Tip

If you are in a file list and want to return to the Folder list, use the ▲/▼ buttons on the remote to highlight “..” and press SELECT/ENTER to return to the previous menu screen.

- 4 If you want to view a particular file, press ▲/▼ to highlight a file and press SELECT/ENTER or PLAY.**

Viewing the file proceeding starts.
During viewing a file, press RETURN to move to the previous menu (JPEG menu).
Press TOP MENU to move to the next page.
Press MENU to move to the previous page.

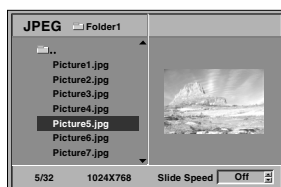

T Tip

There are three viewing Slide Speed options: Fast, Normal, Slow, and Off. Press ◀▶ to highlight the Slide Speed then press ▲/▼ to select the option you want to use, and press SELECT/ENTER.

- 5 To stop viewing at any other time, press STOP.**
The JPEG menu appears.

Moving to another File

Press SKIP/SCAN ◀◀ or ▶▶ once during viewing a picture to advance to the next file or to the previous file.

Still Picture

- Press PAUSE/STEP during slide show.
The player will now go into PAUSE mode.
- To return to the slide show, press PLAY or press PAUSE/STEP again.

To flip the picture

Press ▲/▼ during showing a picture to flip the picture horizontally or a vertically.

To rotate picture

Press ◀▶ during showing a picture to rotate the picture clockwise or counter clockwise.

Notes on JPEG Recordings

- Depending upon the size and number of the JPEG files, it could take a long time for the DVD player to read the disc's contents. If you don't see an on-screen display after several minutes, some of the files are too big — reduce the resolution of the JPEG files to less than 2 mega pixels and burn another disc.
- Total number of files and folders on the disc should be less than 650.
- Some disc may be incompatible due to different recording format or condition of disc.
- When you are using software such as “Easy CD Creator” to burn the jpeg files into the CD-R, ensure that all the selected files have the “.jpg” extensions when copying into the CD layout.
- If the files have “.jpe” or “.jpeg” extensions, please rename them as “.jpg” files.
- File names without “.jpg” extension will not be able to be read by this DVD player. Even though the files are shown as JPEG image files in windows explorer.

⚠ Caution

- If you record a disc using a personal computer, even if it is recorded in a compatible format, there are cases in which it may not play because of the settings of the application software used to create the disc. (Check with the software publisher for more detailed information.)

Programmed Playback **CD** **VCD2.0** **VCD1.1** **MP3** **WMA**

The Program function enables you to store your favorite tracks from any disc in the player memory.

Program can contain 30 tracks.

Programmed Playback with Audio CD

- 1 Press **PROGRAM** during playback or in the stop mode to enter the Program Edit mode.

The  mark will appear to the right of the word Program on the right side of the menu screen.

Note

Press **PROGRAM** to exit the Program Edit mode. The  mark will disappear.

- 2 Move to the Disc number selection column by pressing **▲** repeatedly.
- 3 Select an audio disc number using **◀▶**.
- 4 Select a track, then press **SELECT/ENTER** to place the selected track on the Program list.

Note

You must select a disc number of audio CD. If selected track is other kind of disc (DVD or MP3 etc.), the track skips during programmed playback.

- 5 Repeat steps 2-4 to place additional tracks on the Program list.

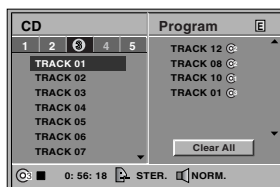

Audio CD menu

- 6 Press **▶**. The programmed track you selected last is highlighted on the program list.
- 7 Press **▲▼** to select the track you want to start playing. Press **TOP MENU** to move to the next page. Press **MENU** to move to the previous page.
- 8 Press **PLAY** to start. Playback begins in the order in which you programmed the tracks and "PROG." appears on the menu screen. Playback stops after all of the tracks on the Program list have played once.
- 9 To resume normal playback from programmed playback, select a track of CD list and then press **SELECT/ENTER**. "PROG." indicator disappears on the menu screen.

Programmed Playback with MP3/WMA disc

- 1 Follow step 1 of "Programmed Playback with Audio CD" on left.
- 2 Select a track, then press **SELECT/ENTER** to place the selected track on the Program list.
- 3 Repeat step 2 to place additional tracks on the Program list.

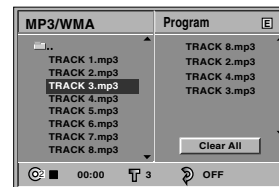

MP3/WMA menu

- 4 Follow steps 6-9 of "Programmed Playback with Audio CD" on left.

Programmed Playback with Video CD

Note

On a Video CD with PBC, you must set PBC to Off on the setup menu to use the Program function. See page 14.

- 1 Insert Video CD and close the tray.
- 2 Press **PROGRAM** while playback is stopped. The VCD Program menu will appear.

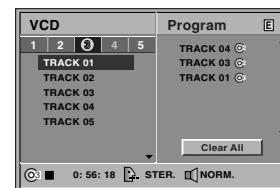

Video CD menu

Note

Press **RETURN** or **PROGRAM** to exit the Program menu.

- 3 Follow steps 2-8 of "Programmed Playback with Audio CD" on left.
- 4 To resume normal playback from programmed playback, press **PROGRAM**. "PROG." indicator disappears in the display window.

Repeat Programmed Tracks

- To repeat the track currently playing, press REPEAT.
The Repeat icon and "TRACK" appears on the menu screen.
- To repeat all tracks on the program list, press REPEAT a second time.
The Repeat icon and "ALL" appears on the menu screen.
- To cancel Repeat mode, press REPEAT a third time.
The Repeat icon and "OFF" appears on the menu screen.

Erasing a Track from Program List

- 1 Press PROGRAM during playback (Audio CD and MP3/WMA disc only) or in the stop mode to enter the Program Edit mode.
The  mark will appear.
- 2 Press ► to move to the Program list.
- 3 Use ▲/▼ to select the track that you wish to erase from the Program list.
- 4 Press CLEAR.
The track will be erased from the Program list.

Erasing the Complete Program List

- 1 Follow steps 1-2 of "Erasing a Track from Program List" as above.
- 2 Use ▲/▼ to select "Clear All", then press SELECT/ENTER.
The complete Program for the disc will be erased.
The programs are also cleared when the disc is removed.

Additional Information

Screen Saver

The screen saver picture appears when you leave the DVD Player in stop mode for about five minutes. After the Screen Saver has been engaged for about five minutes, the DVD Player will automatically turn itself off.

Video Mode Setting

DVD **VCD2.0** **VCD1.1**

- With certain discs, the playback picture may be flickering or Dot Crawl is shown on straight lines. That means Vertical interpolation or De-interlace is not perfectly matched with the disc. In this case, the picture quality may be improved by changing the video mode.
- To change the video mode, press and hold OSD about 3 seconds during disc playback. The new video mode number selected is displayed on the TV screen. Check whether the video quality has improved. If not, repeat the above procedure until picture quality is improved.
- Video mode change sequence:
MODE1 → MODE2 → MODE3 → MODE1
- If you turn off the power, the video mode will be back to initial state (MODE1).

Detailed Descriptions for Video Modes

MODE1: The source material of the DVD video (film material or video material) is determined from disc information.

MODE2: Suitable for playing film based content or video based material recorded by the progressive scan method.

MODE3: Suitable for playing video based content with comparatively little motion.

Note

The video mode setting only works when the Progressive Scan mode is set to "On" in the Setup menu.

Setting Remote control codes of DVD player

- This DVD player support two remote control codes : C004 and C044.
- When the unit is shipped from the factory, the remote code is set to C004.
- To set the code of the player to C044, press PAUSE then input "9872" using number buttons.
- To set the code of the player to C004, press PAUSE then input "9871" using number buttons.
- You can change the code of the player only when NO DISC appears in the display window.
- Changed Remote control codes is displayed in the Display window.
- Set the remote control codes of the Remote control to the same setting (page 8).

Notes

- This setting can not be used if a disc is playing.
- If a DVD has been loaded, be sure to press STOP twice before proceeding.

Troubleshooting

Check the following guide for the possible cause of a problem before contacting service.

| Symptom | Cause | Correction |
|--|---|--|
| No power. | <ul style="list-style-type: none"> The power cord is disconnected. | <ul style="list-style-type: none"> Plug the power cord into the wall outlet securely. |
| The power is on, but the DVD player does not work. | <ul style="list-style-type: none"> No disc is inserted. | <ul style="list-style-type: none"> Insert a disc. (Check that the DVD or, audio CD indicator in the display window is lit.) |
| No picture. | <ul style="list-style-type: none"> The TV is not set to receive DVD signal output. | <ul style="list-style-type: none"> Select the appropriate video input mode on the TV so the picture from the DVD player appears on the TV screen. |
| | <ul style="list-style-type: none"> The video cable is not connected securely. | <ul style="list-style-type: none"> Connect the video cable securely. |
| | <ul style="list-style-type: none"> The connected TV power is turned off. | <ul style="list-style-type: none"> Turn on the TV. |
| No sound. | <ul style="list-style-type: none"> The equipment connected with the audio cable is not set to receive DVD signal output. | <ul style="list-style-type: none"> Select the correct input mode of the audio receiver so you can listen to the sound from the DVD player. |
| | <ul style="list-style-type: none"> The audio cables are not connected securely. | <ul style="list-style-type: none"> Connect the audio cable securely. |
| | <ul style="list-style-type: none"> The power of the equipment connected with the audio cable is turned off. | <ul style="list-style-type: none"> Turn on the equipment connected with the audio cable. |
| | <ul style="list-style-type: none"> The Digital Audio Output is set to the wrong position. | <ul style="list-style-type: none"> Set the Digital Audio Output to the correct position, then turn on the DVD player again by pressing POWER. |
| The playback picture is poor. | <ul style="list-style-type: none"> The disc is dirty. | <ul style="list-style-type: none"> Clean the disc. |
| The DVD player does not start playback. | <ul style="list-style-type: none"> No disc is inserted. | <ul style="list-style-type: none"> Insert a disc. (Check that the DVD, or audio CD indicator in the DVD display is lit.) |
| | <ul style="list-style-type: none"> An unplayable disc is inserted. | <ul style="list-style-type: none"> Insert a playable disc. (Check the disc type, color system, and Regional code.) |
| | <ul style="list-style-type: none"> The disc is placed upside down. | <ul style="list-style-type: none"> Place the disc with the playback side down. |
| | <ul style="list-style-type: none"> The disc is not placed within the guide. | <ul style="list-style-type: none"> Place the disc on the disc tray correctly inside the guide. |
| | <ul style="list-style-type: none"> The disc is dirty. | <ul style="list-style-type: none"> Clean the disc. |
| | <ul style="list-style-type: none"> The Rating level is set. | <ul style="list-style-type: none"> Cancel the Rating function or change the rating level. |
| The remote control does not work properly. | <ul style="list-style-type: none"> The remote control is not pointed at the remote sensor of the DVD player. | <ul style="list-style-type: none"> Point the remote control at the remote sensor of the DVD player. |
| | <ul style="list-style-type: none"> The remote control is too far from the DVD player. | <ul style="list-style-type: none"> Operate the remote control within 16 ft (5 m). |
| | <ul style="list-style-type: none"> There is an obstacle in the path of the remote control and the DVD player. | <ul style="list-style-type: none"> Remove the obstacle. |
| | <ul style="list-style-type: none"> The batteries in the remote control are exhausted. | <ul style="list-style-type: none"> Replace the batteries with new ones. |
| | <ul style="list-style-type: none"> Remote control code is different between the DVD player and Remote control. | <ul style="list-style-type: none"> Set the remote control codes of both DVD player and Remote control to the same setting. |

Language Code List

Enter the appropriate code number for the initial settings "Disc Audio", "Disc Subtitle" and/or "Disc Menu" (See page 13).

| Code | Language | Code | Language | Code | Language | Code | Language |
|------|-----------------|------|------------------|------|----------------|------|------------|
| 6566 | Abkhazian | 7074 | Fiji | 7678 | Lingala | 8373 | Singhalese |
| 6565 | Afar | 7073 | Finnish | 7684 | Lithuanian | 8375 | Slovak |
| 6570 | Afrikaans | 7082 | French | 7775 | Macedonian | 8376 | Slovenian |
| 8381 | Albanian | 7089 | Frisian | 7771 | Malagasy | 8379 | Somali |
| 6577 | Ameharic | 7176 | Galician | 7783 | Malay | 6983 | Spanish |
| 6582 | Arabic | 7565 | Georgian | 7776 | Malayalam | 8385 | Sudanese |
| 7289 | Armenian | 6869 | German | 7784 | Maltese | 8387 | Swahili |
| 6583 | Assamese | 6976 | Greek | 7773 | Maori | 8386 | Swedish |
| 6588 | Aymara | 7576 | Greenlandic | 7782 | Marathi | 8476 | Tagalog |
| 6590 | Azerbaijani | 7178 | Guarani | 7779 | Moldavian | 8471 | Tajik |
| 6665 | Bashkir | 7185 | Gujarati | 7778 | Mongolian | 8465 | Tamil |
| 6985 | Basque | 7265 | Hausa | 7865 | Nauru | 8484 | Tatar |
| 6678 | Bengali; Bangla | 7387 | Hebrew | 7869 | Nepali | 8469 | Telugu |
| 6890 | Bhutani | 7273 | Hindi | 7879 | Norwegian | 8472 | Thai |
| 6672 | Bihari | 7285 | Hungarian | 7982 | Oriya | 6679 | Tibetan |
| 6682 | Breton | 7383 | Icelandic | 8065 | Panjabi | 8473 | Tigrinya |
| 6671 | Bulgarian | 7378 | Indonesian | 8083 | Pashto, Pushto | 8479 | Tonga |
| 7789 | Burmese | 7365 | Interlingua | 7065 | Persian | 8482 | Turkish |
| 6669 | Byelorussian | 7165 | Irish | 8076 | Polish | 8475 | Turkmen |
| 7577 | Cambodian | 7384 | Italian | 8084 | Portuguese | 8487 | Twi |
| 6765 | Catalan | 7465 | Japanese | 8185 | Quechua | 8575 | Ukrainian |
| 9072 | Chinese | 7487 | Javanese | 8277 | Rhaeto-Romance | 8582 | Urdu |
| 6779 | Corsican | 7578 | Kannada | 8279 | Rumanian | 8590 | Uzbek |
| 7282 | Croatian | 7583 | Kashmiri | 8285 | Russian | 8673 | Vietnamese |
| 6783 | Czech | 7575 | Kazakh | 8377 | Samoan | 8679 | Volapük |
| 6865 | Danish | 7589 | Kirghiz | 8365 | Sanskrit | 6789 | Welsh |
| 7876 | Dutch | 7579 | Korean | 7168 | Scots Gaelic | 8779 | Wolof |
| 6978 | English | 7585 | Kurdish | 8382 | Serbian | 8872 | Xhosa |
| 6979 | Esperanto | 7679 | Laothian | 8372 | Serbo-Croatian | 7473 | Yiddish |
| 6984 | Estonian | 7665 | Latin | 8378 | Shona | 8979 | Yoruba |
| 7079 | Faroese | 7686 | Latvian, Lettish | 8368 | Sindhi | 9085 | Zulu |

Country Code List

Enter the appropriate code number for the initial setting "Country Code" (See page 15).

| Code | Country | Code | Country | Code | Country | Code | Country |
|------|--------------------------|------|--------------------------------|------|---------------------------|------|--------------------------------|
| AD | Andorra | ER | Eritrea | LC | Saint Lucia | SC | Seychelles |
| AE | United Arab Emirates | ES | Spain | LI | Liechtenstein | SD | Sudan |
| AF | Afghanistan | ET | Ethiopia | LK | Sri Lanka | SE | Sweden |
| AG | Antigua and Barbuda | FI | Finland | LR | Liberia | SG | Singapore |
| AI | Anguilla | FJ | Fiji | LS | Lesotho | SH | Saint Helena |
| AL | Albania | FK | Falkland Islands | LT | Lithuania | SI | Slovenia |
| AM | Armenia | FM | Micronesia | LU | Luxembourg | SJ | Svalbard and Jan Mayen Islands |
| AN | Netherlands Antilles | FO | Faroe Islands | LV | Latvia | SK | Slovak Republic |
| AO | Angola | FR | France | LY | Libya | SL | Sierra Leone |
| AQ | Antarctica | FX | France (European Territory) | MA | Morocco | SM | San Marino |
| AR | Argentina | GA | Gabon | MC | Monaco | SN | Senegal |
| AS | American Samoa | GB | Great Britain | MD | Moldavia | SO | Somalia |
| AT | Austria | GD | Grenada | MG | Madagascar | SR | Suriname |
| AU | Australia | GE | Georgia | MH | Marshall Islands | ST | Saint Tome and Principe |
| AW | Aruba | GF | French Guyana | MK | Macedonia | SU | Former USSR |
| AZ | Azerbaijan | GH | Ghana | ML | Mali | SV | El Salvador |
| BA | Bosnia-Herzegovina | GI | Gibraltar | MM | Myanmar | SY | Syria |
| BB | Barbados | GL | Greenland | MN | Mongolia | SZ | Swaziland |
| BD | Bangladesh | GM | Gambia | MO | Macau | TC | Turks and Caicos Islands |
| BE | Belgium | GN | Guinea | MP | Northern Mariana Islands | TD | Chad |
| BF | Burkina Faso | GP | Guadeloupe (French) | MQ | Martinique (French) | TF | French Southern Territories |
| BG | Bulgaria | GQ | Equatorial Guinea | MR | Mauritania | TG | Togo |
| BH | Bahrain | GR | Greece | MS | Montserrat | TH | Thailand |
| BI | Burundi | GS | S. Georgia & S. Sandwich Isls. | MT | Malta | TJ | Tadjikistan |
| BJ | Benin | GT | Guatemala | MU | Mauritius | TK | Tokelau |
| BM | Bermuda | GU | Guam (USA) | MV | Maldives | TM | Turkmenistan |
| BN | Brunei Darussalam | GW | Guinea Bissau | MX | Mexico | TN | Tunisia |
| BO | Bolivia | GY | Guyana | MY | Malaysia | TO | Tonga |
| BR | Brazil | HK | Hong Kong | MZ | Mozambique | TP | East Timor |
| BS | Bahamas | HM | Heard and McDonald Islands | NA | Namibia | TR | Turkey |
| BT | Bhutan | HN | Honduras | NC | New Caledonia (French) | TT | Trinidad and Tobago |
| BV | Bouvet Island | HR | Croatia | NE | Niger | TV | Tuvalu |
| BW | Botswana | HT | Haiti | NF | Norfolk Island | TW | Taiwan |
| BY | Belarus | HU | Hungary | NG | Nigeria | TZ | Tanzania |
| BZ | Belize | ID | Indonesia | NI | Nicaragua | UA | Ukraine |
| CA | Canada | IE | Ireland | NL | Netherlands | UG | Uganda |
| CC | Cocos (Keeling) Islands | IL | Israel | NO | Norway | UK | United Kingdom |
| CF | Central African Republic | IN | India | NP | Nepal | UM | USA Minor Outlying Islands |
| CG | Congo | IO | British Indian Ocean Territory | NR | Nauru | US | United States |
| CH | Switzerland | IQ | Iraq | NU | Niue | UY | Uruguay |
| CI | Ivory Coast | IR | Iran | NZ | New Zealand | UZ | Uzbekistan |
| CK | Cook Islands | IS | Iceland | OM | Oman | VA | Vatican City State |
| CL | Chile | IT | Italy | PA | Panama | VC | Saint Vincent & Grenadines |
| CM | Cameroon | JM | Jamaica | PE | Peru | VE | Venezuela |
| CN | China | JO | Jordan | PF | Polynesia (French) | VG | Virgin Islands (British) |
| CO | Colombia | JP | Japan | PG | Papua New Guinea | VI | Virgin Islands (USA) |
| CR | Costa Rica | KE | Kenya | PH | Philippines | VN | Vietnam |
| CS | Former Czechoslovakia | KG | Kyrgyzstan | PK | Pakistan | VU | Vanuatu |
| CU | Cuba | KH | Cambodia | PL | Poland | WF | Wallis and Futuna Islands |
| CV | Cape Verde | KI | Kiribati | PM | Saint Pierre and Miquelon | WS | Samoa |
| CX | Christmas Island | KM | Comoros | PN | Pitcairn Island | YE | Yemen |
| CY | Cyprus | KN | Saint Kitts & Nevis Anguilla | PR | Puerto Rico | YT | Mayotte |
| CZ | Czech Republic | KP | North Korea | PT | Portugal | YU | Yugoslavia |
| DE | Germany | KR | South Korea | PW | Palau | ZA | South Africa |
| DJ | Djibouti | KW | Kuwait | PY | Paraguay | ZM | Zambia |
| DK | Denmark | KY | Cayman Islands | QA | Qatar | ZR | Zaire |
| DM | Dominica | KZ | Kazakhstan | RE | Reunion (French) | ZW | Zimbabwe |
| DO | Dominican Republic | LA | Laos | RO | Romania | | |
| DZ | Algeria | LB | Lebanon | RU | Russian Federation | | |
| EC | Ecuador | | | RW | Rwanda | | |
| EE | Estonia | | | SA | Saudi Arabia | | |
| EG | Egypt | | | SB | Solomon Islands | | |
| EH | Western Sahara | | | | | | |

Specifications

General

| | |
|-----------------------|--|
| Power requirements | AC 120V , 60 Hz |
| Power consumption | 14W |
| Dimensions (approx.) | 17.3 X 3.2 X 16.2 inches (440 X 80 X 410 mm) (w x h x d) |
| Mass (approx.) | 11.2 lbs (5.1 kg) |
| Operating temperature | 5°C to 35°C (41°F to 95°F) |
| Operating humidity | 5 % to 90 % |

System

| | |
|-----------------------|--|
| Laser | Semiconductor laser, wavelength 650 nm |
| Signal system | NTSC |
| Frequency response | DVD (PCM 96 kHz): 8 Hz to 44 kHz DVD (PCM 48 kHz): 8 Hz to 22 kHz CD: 8 Hz to 20 kHz |
| Signal-to-noise ratio | More than 100dB (ANALOG OUT connectors only) |
| Harmonic distortion | Less than 0.008% |
| Dynamic range | More than 100 dB (DVD) More than 95 dB (CD) |

Outputs

| | |
|---------------------------|---|
| Video output | 1 Vp-p 75 Ω, negative sync, RCA jack x 1 |
| S-Video output | (Y) 1.0 V (p-p), 75 Ω, negative sync, Mini DIN 4-pin x 1 (C) 0.3 V (p-p) 75 Ω |
| Component Video output | (Y) 1.0 V (p-p), 75 Ω, negative sync, RCA jack x 1 (CB/PB)/(CR/PR) 0.7 V (p-p), 75 Ω, RCA jack x 2 |
| Audio output (coaxial) | 0.5 V (p-p), 75 Ω, RCA jack x 1 |
| Audio output (optical) | Optical connector x 1 |
| Audio output (analog 2ch) | 2.0 Vrms , 600 Ω, RCA jack (L, R) x 2 |

Accessories

| | |
|--------------------------------|---|
| Video cable | 1 |
| Audio cable | 1 |
| Remote control unit (RC5400VC) | 1 |
| Batteries (AAA size) | 2 |
| Warranty card (for USA) | 1 |
| Warranty card (for CANADA) | 1 |
| User Guide | 1 |

- Design and specifications are subject to change without notice.

Manufactured under license from Dolby Laboratories. "Dolby", "Pro Logic", and the double-D symbol are trademarks of Dolby Laboratories.

"DTS" and "DTS Digital Out" are trademarks of Digital Theater Systems, Inc.

www.marantz.com

You can find your nearest authorized distributor or dealer on our website.

| | | |
|---------------|-----------------------|--|
| JAPAN | Marantz Japan, Inc. | 35-1 Sagami Ohno 7-Chome, Sagamihara-shi, Kanagawa 228-8505, Japan |
| U.S.A. | Marantz America, Inc. | 1100 Maplewood Drive, Itasca, IL 60143, U.S.A. |
| EUROPE | Marantz Europe B.V. | P.O. Box 8744, 5605 LS Eindhoven, The Netherlands |

marantz[®] is a registered trademark.



P/NO: 3834RS0062W

Printed in China

03/2003 MIT-Ig 31AW851250

Free Manuals Download Website

<http://myh66.com>

<http://usermanuals.us>

<http://www.somanuals.com>

<http://www.4manuals.cc>

<http://www.manual-lib.com>

<http://www.404manual.com>

<http://www.luxmanual.com>

<http://aubethermostatmanual.com>

Golf course search by state

<http://golfingnear.com>

Email search by domain

<http://emailbydomain.com>

Auto manuals search

<http://auto.somanuals.com>

TV manuals search

<http://tv.somanuals.com>