

TUNN[®]

By *interfire*

**MONO CHANNEL / 2 CHANNEL / 4 CHANNEL
AUTOMOTIVE AMPLIFIER**

**T-1000M
T-270 / T-2100 / T-2130
T-460 / T-480**

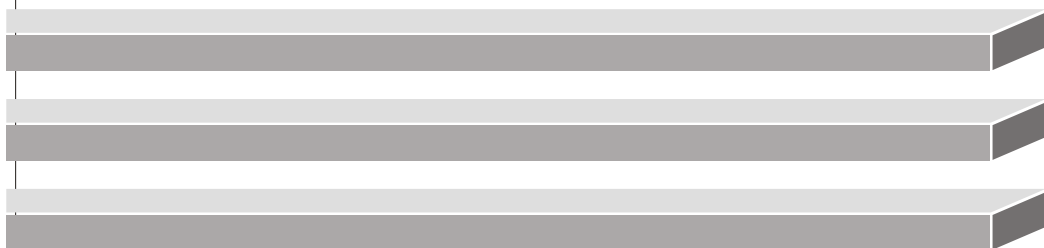

INSTRUCTION MANUAL



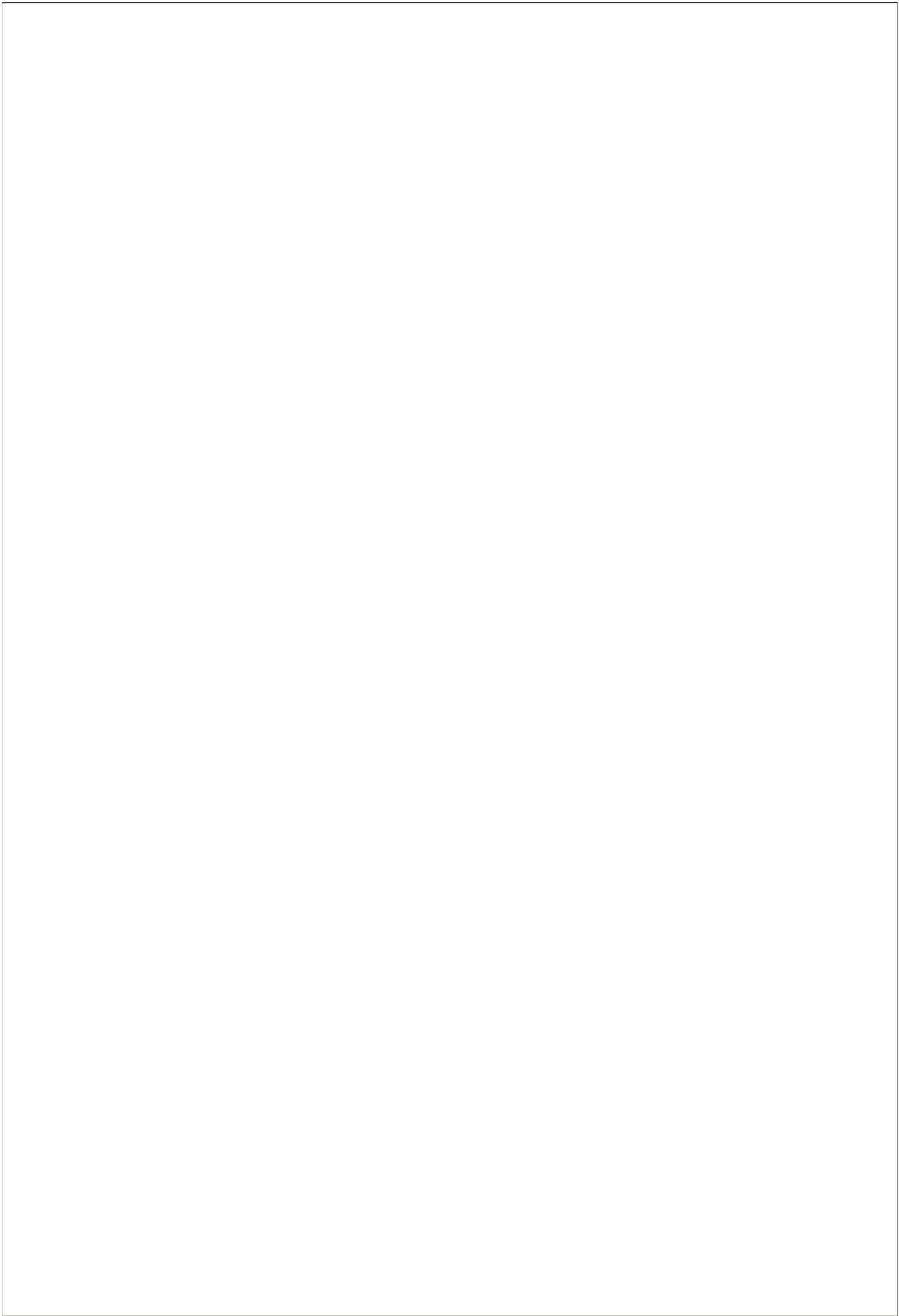

Congratulations on your Purchase

Your new high fidelity bridgeable/stereo amplifier is designed to deliver maximum enjoyment and one year of trouble free service. Please take a few moments to read this manual thoroughly. It will explain the features and operation of your unit and help insure trouble free installation.

Features

- Four Class "AB" High-Current Dual Discrete Drive Stages.
- Class "AB" Technology MOSFET PWM Power Supply.
- Bridgeable & TRI-Mode Operation.
- Continuously Variable 12dB/Octave High Pass & 12dB /Octave Low Pass Crossover.
- Subwoofer Variable Crossover for Deep Bass Control.
- Enhanced Bass Boost +12dB @ 45Hz.
- Silver Plated RCA, Power & Speaker Terminal.
- Soft Start & Muting.
- Overload, Thermal and Short Circuit Protection.
- Power & Protection indicator.
- Bass Level Remote Control(16.4Fit) - T-1000M / T-2130

Precautions: Read First!

- If after reading the directions you feel uncomfortable about installing the amplifier in your car, or not equipped or competent to do so, you should have the amplifier installed by an authorized installer. It's your car!
- Negative battery terminal must be disconnected before any electrical connections are made.
- Be sure choose a location that provides substantial ventilation for the amplifier. The most preferred locations would be in your car's trunk, under the front seats or on the back wall of a truck.
- The location chosen should provide at least 2" of clearance above the amplifier for adequate ventilation.
- If the amplifier is to be mounted vertically be sure that it is in a place where adequate air will flow along the length of its heatsink fins for cooling.
- NEVER mount the amplifier upside down, this will cause the heat to rise back into the amplifier causing thermal shutdown or possible permanent damage.
- NEVER mount the amplifier in a location that is subject to direct sunlight or exposed to moisture.
- Be sure to mount the amplifier to a strong, solid surface which will not give way under the stress of a sudden stop or accident.
- Make sure that the mounting screws will not penetrate the gas tank, brake and fuel lines, wiring or other critical parts of your car when installed.

- NEVER operate the amplifier without the proper power and ground wire, 10 gauge minimum.
- NEVER operate the amplifier without proper fusing. Fuse holder must be located with in 0.5 meters from the battery. This fuse is to protect the car not the electronics. In case of a short, the fuse will blow instead of the wire burning up. Using other than the recommended fuse ratings at the battery and at the amplifier may cause damage to the amplifier and will void your warranty.
- Do not run wiring underneath or outside the car since exposure to the elements may cause the insulation to deteriorate rapidly, resulting in short-circuits and/or intermittent operation. all cables should be run beneath carpets and inside trim pieces.
- To help minimize interference, it is best to run the power cables along the opposite side from the audio cables
- Whenever wires pass through metal, rubber or plastic grommets must be used to prevent the metal from wearing through the installation and causing a short.
- Whenever possible, use cable ties, mounting clamps and similar wiring aids. (available from an electrical supply or auto parts store) Adding stress relief loops to wiring is also advisable to prevent straining or breakage.
- It is best to test the system before the amplifier is mounted and interior of car is reassembled.
- If the temperature inside your car reaches extreme levels (such as sitting locked up for several hours in the hot sun or exposed to a very cold winter's day) the amplifier may go into protection mode and shut off. Leave the unit off until the ambient temperature returns to normal.
- The amplifier operates with any vehicle using a 12 volt negative ground system. If you are not sure of the type of electrical system in your vehicle, consult your authorized dealer or qualified mechanic.
- NEVER ground the speaker leads and NEVER allow the speaker leads to come in contact with each other. Speaker wire should be 18 gauge or larger.
- Remote turn on wire must be switched by the radio does not have a remote turn on or antenna output, connect to wire that has a positive 12 volts when the key is turned to the accessory. If the amplifier does not turn off the battery will die.
- Do not listen to high volumes for extended periods of time or hearing damage may occur.

CONTINUOUS EXPOSURE TO SOUND PRESSURE LEVELS OVER 100dB MAY CAUSE PERMANENT HEARING LOSS. HIGH POWERED AUTOSOUND SYSTEM MAY PRODUCE SOUND PRESSURE LEVELS WELL OVER 130dB. USE COMMON SENSE AND PRACTICE SAFE SOUND.

INSTALLATION

MOUNTING:

1. After reading precaution, decide where you are going to install the unit. Also, see Fig.1.
2. Once the location has been determined, place the amplifier into position. Using a felt tip pen or pencil mark the four holes to be drilled for mounting. NEVER use the amplifier as a template for drilling. It is very easy to damage the amplifier surface in this manner.
3. Remove amplifier. Drill four 3.5 m/m holes into mounting surface. If you want to mount the amplifier to MDF or wood panel, drill four 3.0m/m diameter holes into mounting surface.
4. If possible, test the system to ensure it is operating correctly before final mounting of the amplifier.
5. Mount the amplifier using the supplied 4 self tapping screws.

INSTALLATION DIAGRAM

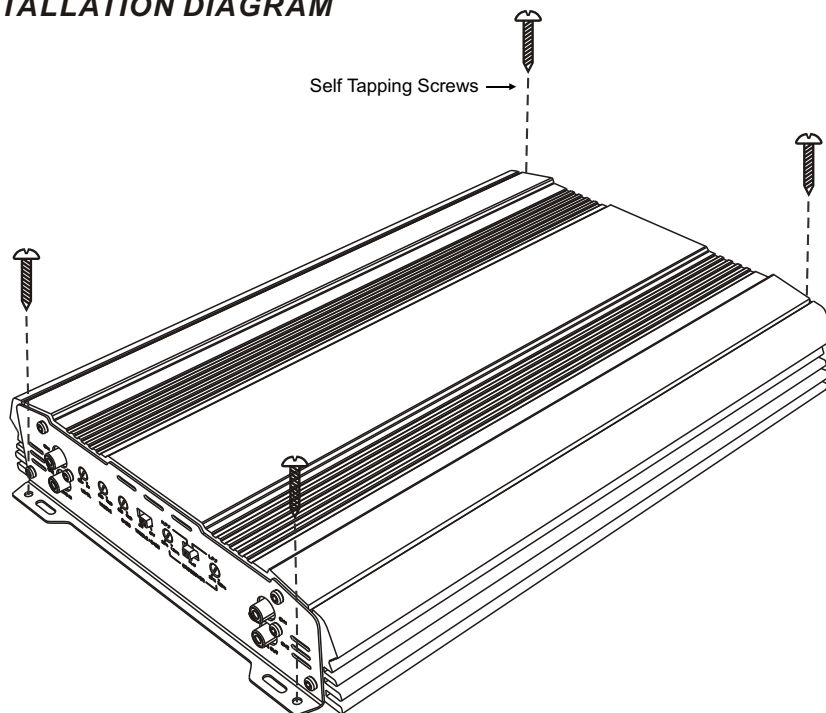

FIG.1

CONNECTIONS

INPUT CONNECTIONS

This amplifier will accept low level inputs only. Low level is the same as line level. The low level signal is carried through RCA cables. It is preferred to use low level inputs to the amplifier if the head unit is equipped with the low level outputs. If not, you can use a "high to low converter" available through your local car audio shop.

Connect the low level/line level RCA cables from the head unit, or signal processor, to the line level input on the amplifier. See Fig.2 system wiring diagrams.

POWER CONNECTIONS

It is important to have good quality power and ground connections. Remember, to complete an electrical circuit, the ground connection is just as important as the positive power connection. Before any power connections are made, disconnect the ground cable at the battery.

When the power supply lead, memory backup lead or ground lead are extended use a 5mm² (AWG5) or larger automotive grade cable which will withstand friction and heat to safe grade against fires occurring as a result of short-circuiting.

GND = Connect the proper gauge ground wire to the amplifier "GND" terminal. Locate the position on the chassis of the car to which the amplifier is to be grounded. The surface must be free from any paint or dirt. This can be accomplished with a small grinding bit, sand paper or wire wheel. **NOTE:** Do not ground the amplifier to the "frame of the car. The frame on most cars and trucks is not grounded to the chassis(body). Use Solder or a clamp ring to connect the ground wire. Pre-drill the prepped chassis to bolt the ground ring terminal with nut, bolt and lock washers. Insulate metal and connector with paint or silicon to prevent rust and oxidation. Silicon also works great to prevent nuts and bolts from working loose in a harsh environment of an automobile. Upon completion of the ground connection, grab wire or connector and confirm that it is a solid connection. To prevent engine noise, it is recommended to ground the head unit and other audio electronics in the same location.

REM = Connect the remote wire (power antenna output) from the head unit to the remote turn-on wire of the amplifier. If the head unit is not equipped with a remote/antenna output, locate a wire that is controlled by the accessory position of the key. It is important to have the amplifier turn off with the radio or key. If the amplifier remains on, the result will most likely be a dead battery.

12V = Connect the proper gauge power wire to the amplifier "B+" terminal. Run wire towards the fuse holder that is no greater than 0.5 meters from the battery. Remember, the fuse is to protect the safety of the car in the case of a short. Connect fuse holder to battery, but do not install fuse at this time.

MONO CHANNEL SYSTEM WIRING DIAGRAM

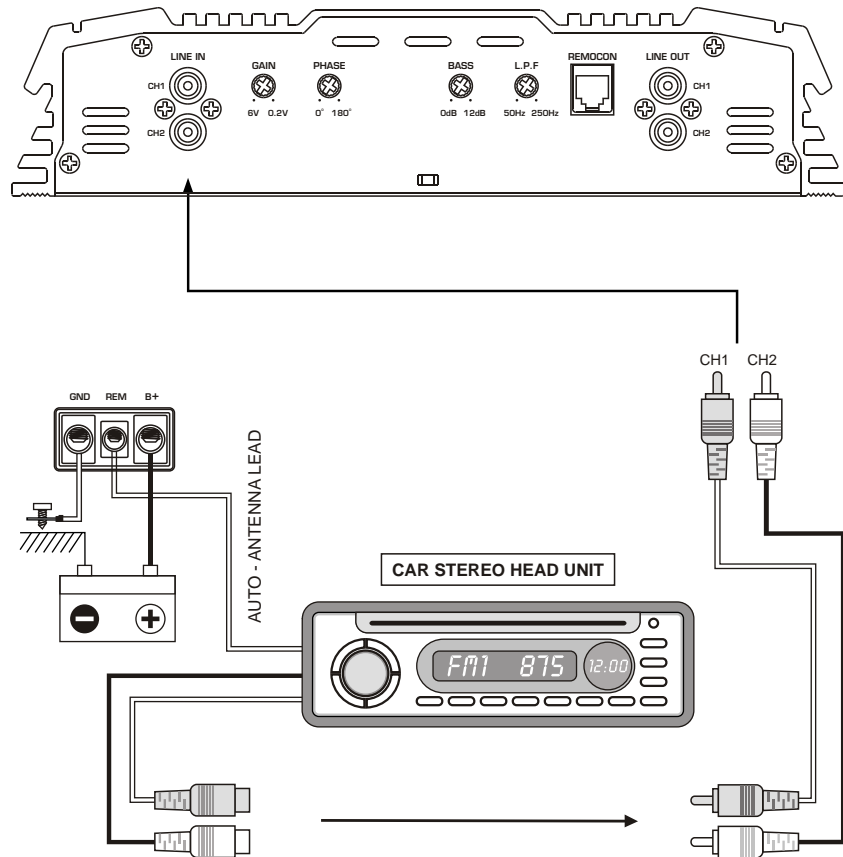

FIG.2

2 CHANNEL SYSTEM WIRING DIAGRAM

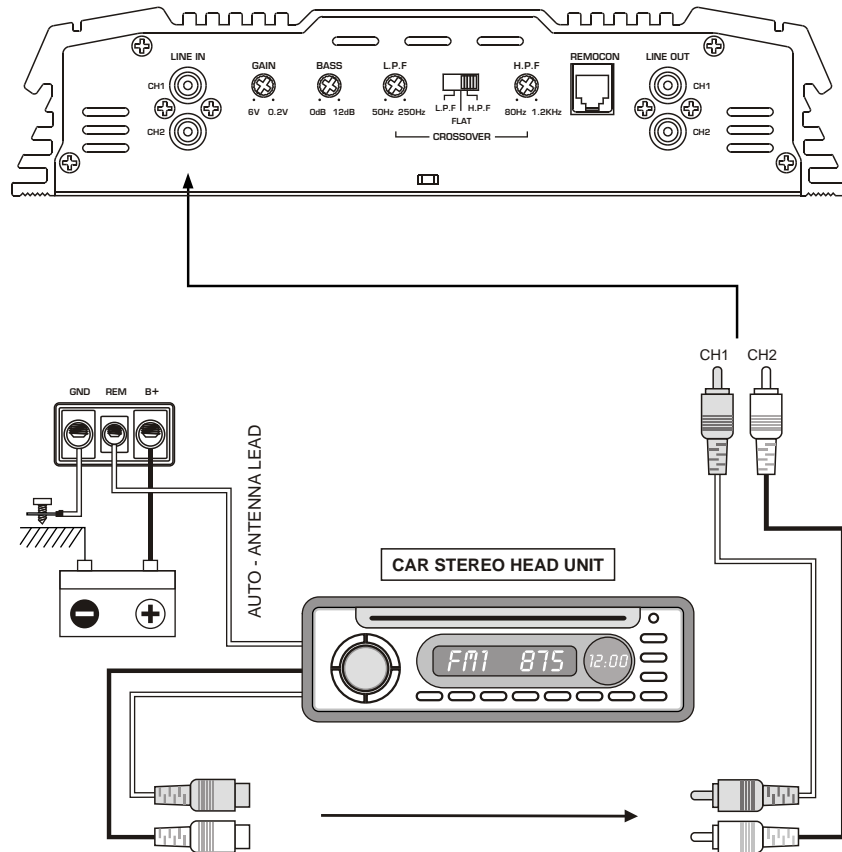

FIG.2

4 CHANNEL SYSTEM WIRING DIAGRAM

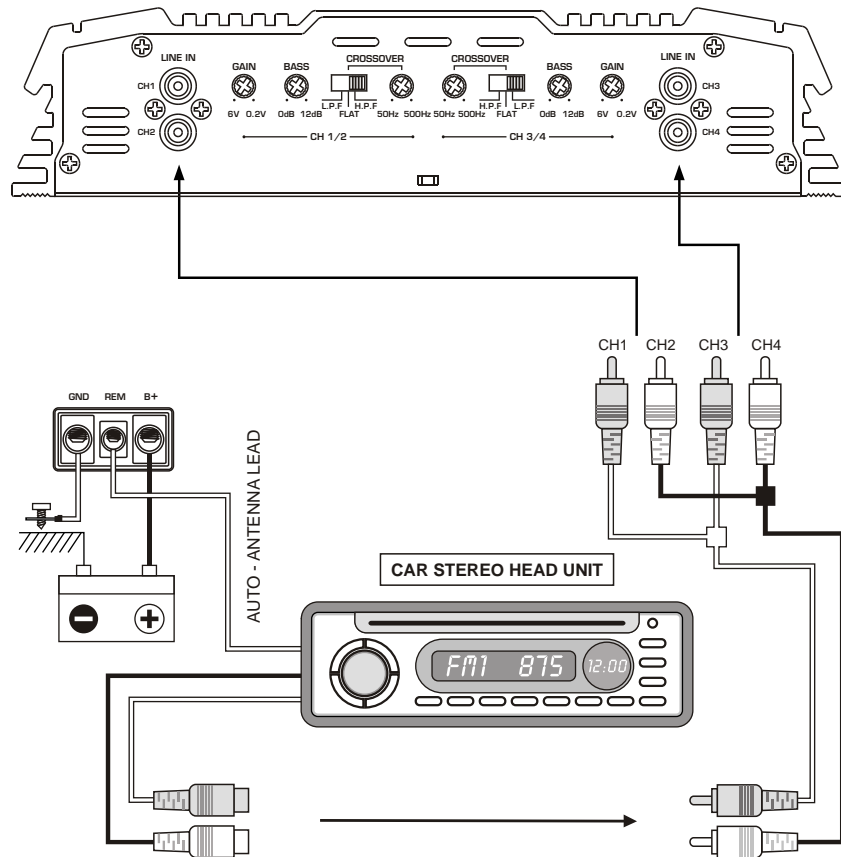

FIG. 2

SPEAKER CONNECTIONS

This amplifier can operate in one, two or three channel mode. The minimum impedance for single channel (bridged/mono) operation is 4 or 8 ohms. Tri channel power is referred to stereo and mono at the same time. Minimum impedance remains the same for three channel (front /subwoofer) systems as long as proper passive crossovers are used. Connect right and left speaker wire to corresponding speaker output terminals of the amplifier. Be sure to have the positive wire from the speaker connected to the positive speaker terminal of the amplifier and the negative wire from the speaker must connect with the negative speaker terminal of the amplifier. Reversing any of these connections will result in the speaker cones moving out of phase which causes bass cancellation. See Fig.3 Speaker Output Connections.

MONO CHANNEL SPEAKER WIRING DIAGRAM

1 SPEAKER BRIDGED

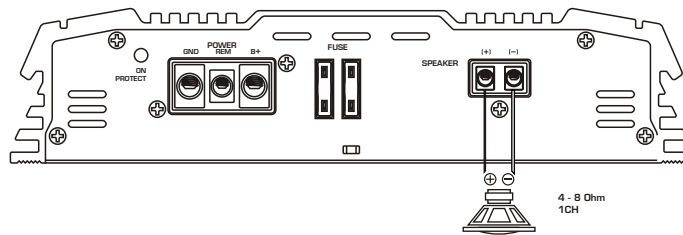

2 SPEAKER STEREO

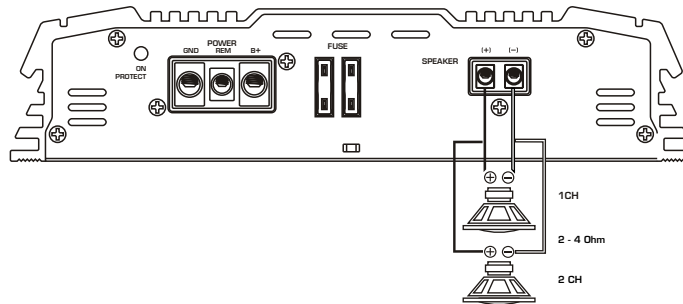
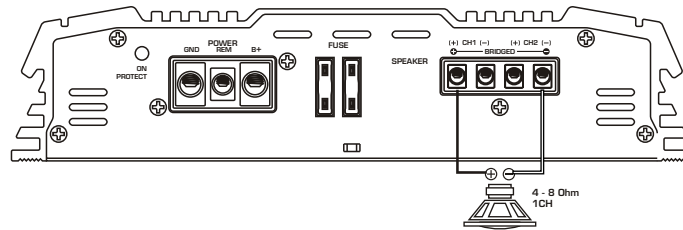

FIG. 3

SPEAKER CONNECTIONS

2 CH SPEAKER WIRING DIAGRAM

1 SPEAKER BRIDGED



2 SPEAKER STEREO

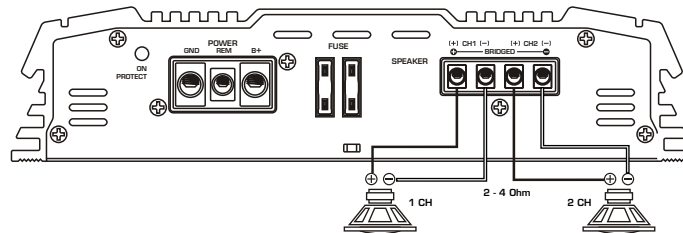

3 SPEAKER TRI MODE

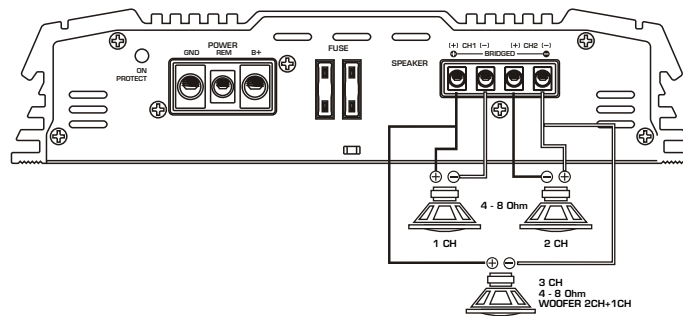
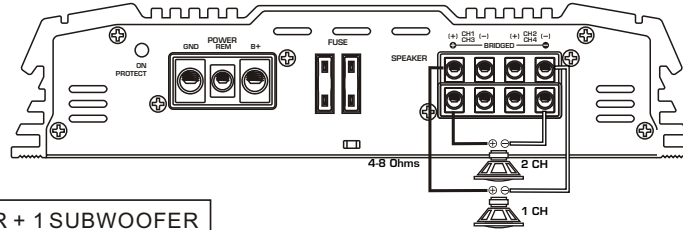

FIG. 3

SPEAKER CONNECTIONS

4 CH SPEAKER WIRING DIAGRAM

2 SPEAKER BRIDGED



2 SPEAKER + 1 SUBWOOFER

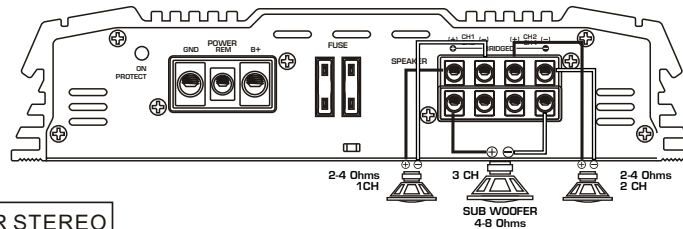

4 SPEAKER STEREO

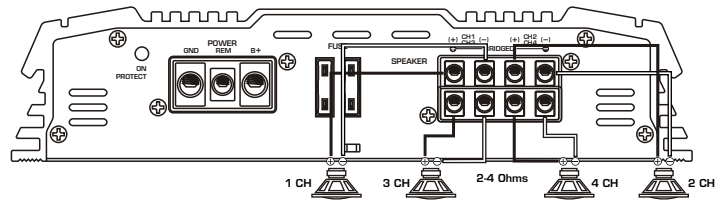

6 SPEAKER HEX MODE

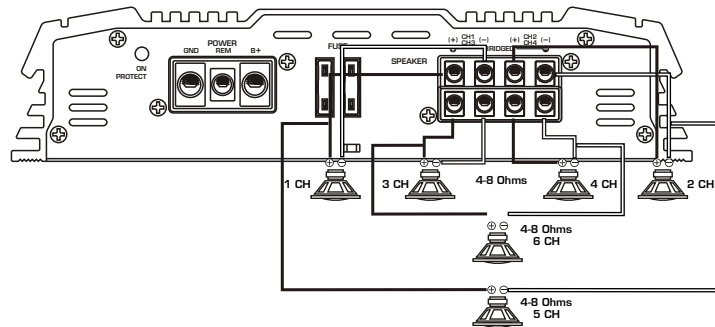

ADJUSTMENTS

1. Set to the "H.P.F" position when the amplifier is used to drive a tweeter/midrange system. The frequencies below the crossover point will be attenuated at 12dB/octave. Permits adjustment of the crossover frequency, by rotating the knob to select any frequency between 80Hz to 1.2kHz & 50Hz to 500Hz as the crossover point.
 2. Set to the "L.P.F" position when the amplifier is used to drive a subwoofer. The frequencies above the crossover point will be attenuated at 12dB /octave. Permits adjustment of the crossover frequency, by rotating the knob to select any frequency between 50Hz to 250Hz & 50Hz to 500Hz as the crossover point.
 3. Set to the "OFF" position when the amplifier will be used for driving full-range speakers. The full frequency band width (20Hz - 20kHz) will be output to the speakers without high or low frequency attenuation.
 4. Level adjustment-The sensitivity adjustment is to allow the amplifier to work with many different brands of head units. It allows input signal to vary between 350 millivolts to 5 volt from the head unit or other signal processor. Start by setting the sensitivity adjustment to the "MIN" (3 volts). Using a cassette or compact disc that you are familiar with, turn on head unit to the 3/4 volume setting. Slowly turn up sensitivity adjustment towards the "MAX" (200 millivolts) using a flat head screw driver. Stop turning on the onset of distortion and turn back just a slight. The 3/4 volume setting is now the "maximum" volume for the head unit. The goal is to keep the level control to the lowest setting yet still have enough signal to drive the amplifier. This is done to prevent over driving the amplifier and to keep system noise to a minimum. It is important not over drive speakers (at point of distortion) this will cause permanent damage to the speakers. Also, if the amplifier itself is over driven, it could be damaged.
 5. The "BASS" function can be selected to increase low frequency response output, or decrease frequency response output. The "BASS" function will be working at only "OFF" or "L.P.F" position.
- The BASS is adjustable from 0 ~ 12dB boost at 50Hz.

FRONT/REAR PANEL

2CHANNEL

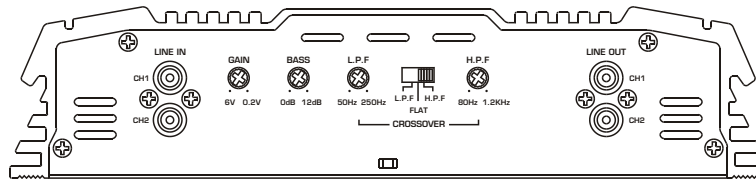

T-270, T-2100

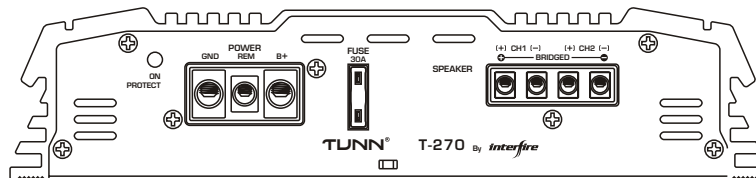

T-270

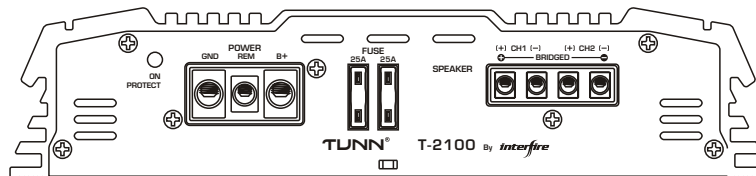

T-2100

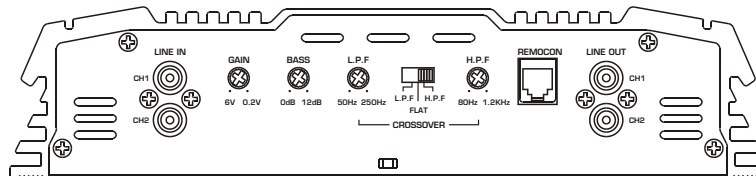

T-2130

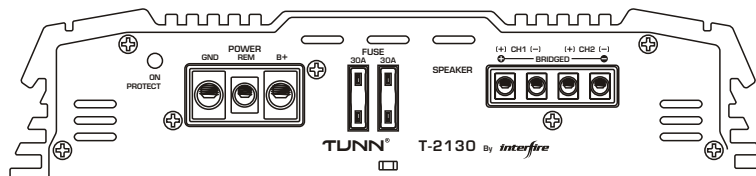

T-2130

FRONT/REAR PANEL

4CHANNEL

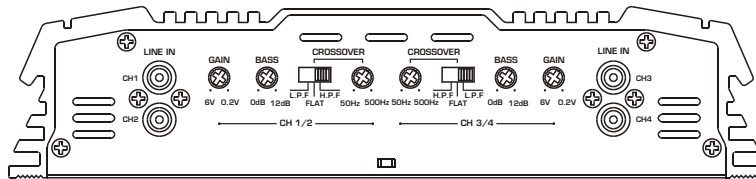

T-460, T-480

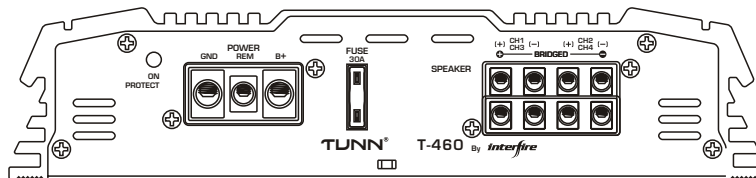

T-460

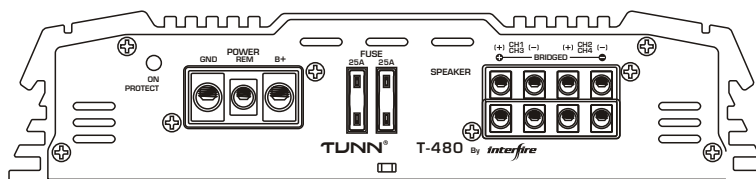

T-480

MONO CHANNEL

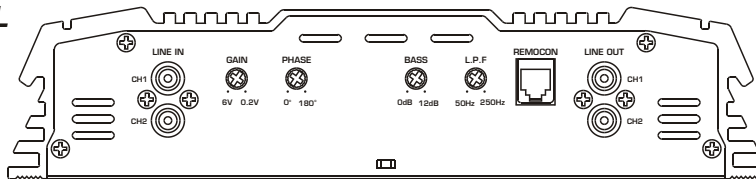

T-1000M

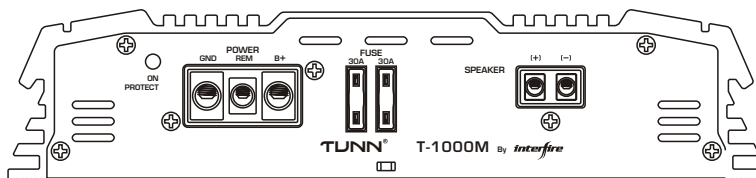

T-1000M

TROUBLE SHOOTING GUIDE.

This section provides you with a catalog of amplifier symptoms and their probable causes and solutions. Before you consult this listing, make sure the vehicle's electrical system is working properly by verifying that other electrical items (e.g. headlights, windows, etc.) still function correctly.

SYMPTOM	PROBABLE CAUSE	SOLUTION
No Audio	Low or N.C Remote Turn-on connections Blown Fuse Power wires not connected Blown or non speakers connected	Check remote turn-on voltage at amp and head unit Replace with new fast-blow fuse Check butt splices or solder joints Check ground and battery connections Use VOM or DVM to measure speaker coil impedance; check speaker wiring connections
Distorted Audio	Input Sensitivity not set properly or damaged speaker cones Low turn-on voltage	See adjustment procedure and check each step; Inspect each speaker for damage and repair or replace suspected component Refer to head unit owner's manual
Audio Level Low	Mute circuit on head unit is on.	Check electrical system for low voltage; Check ground connection
Audio Lacks	Speakers wired with wrong polarity, causing cancellation of bass frequencies	Check polarity of wires from amplifiers to each speaker as defined by the system design Check battery voltage at amplifier during operation
External Fuse Blowing	Incorrect wiring or short circuit	Refer to electrical installation and check each installation step
Whining noise on audio with engine running	Amplifier is picking up alternator noise	Install an in-line noise filter on the head unit's power wire; Check alternator routing diodes or voltage regulator for proper operation. Check all grounds , battery voltage, and RCA cables
Ticking noise on audio with engine running	Amplifier is picking up radiated spark noise	Check RCA audio cable; Install an in-line noise filter on the head unit's power wire. Check spark plug wires.

SPECIFICATION

Output Power Rating RMS	T-270	T-2100	T-2130
Channel	2CH	2CH	2CH
Total Max Power	900 Watts	1200 Watts	1500 Watts
4 Ohm at 14.4V 0.3%THD (RMS)	100W x 2	150W x 2	200W x 2
4 Ohm at 14.4V (MAX)	180W x 2	290W x 2	340W x 2
2 Ohm at 14.4V 0.3%THD (RMS)	160W x 2	250W x 2	310W x 2
2 Ohm at 14.4V (MAX)	250W x 2	400W x 2	500W x 2
1 Ohm at 14.4V 0.3%THD	N / A	N / A	N / A
Mono Bridge (RMS)	310W x 1	490W x 1	630W x 1
Power Supply	Full PWM	Full PWM	Full PWM
Output Power Circuit Configuration	Class A/B	Class A/B	Class A/B
Miscellaneous Spec			
Damping Factor @ 4 Ohms / 100Hz	>100	>100	>100
S/N Ratio(A-Weight)	>90dB	>90dB	>90dB
THD	<0.1%	<0.1%	<0.1%
Crossover, Phase Shift, Line-Input			
Crossover S/W for 1+2 channel 12dB/Oct.	HP/FULL/LP	HP/FULL/LP	HP/FULL/LP
Variable Hi-Pass	80Hz-1.2kHz	80Hz-1.2kHz	80Hz-1.2kHz
Variable Low-Pass	50Hz-250Hz	50Hz-250Hz	50Hz-250Hz
Bass Boost, 12dB @ 45 Hz	YES	YES	YES
Others			
Heatsink Length (mm)	270	330	380

NOTE : Specifications & design subject to change without notice for improvements.

SPECIFICATION

Output Power Rating RMS	T-1000M	T-460	T-480
Channel	1CH Mono	4CH	4CH
Total Max Power	1200 Watts	800 Watts	1000 Watts
4 Ohm at 14.4V 0.3%THD (RMS)	330W x 1	50W x 4	80W x 4
4 Ohm at 14.4V (MAX)	630W x 1	120W x 4	130W x 4
2 Ohm at 14.4V 0.3%THD (RMS)	510W x 1	85W x 4	110W x 4
2 Ohm at 14.4V (MAX)	1000W x 1	130W x 4	190W x 4
1 Ohm at 14.4V 0.3%THD	N / A	N / A	N / A
Mono Bridge (RMS)	N / A	170W x 2	220W x 2
Power Supply	Full PWM	Full PWM	Full PWM
Output Power Circuit Configuration	Class A/B	Class A/B	Class A/B
Miscellaneous Spec			
Damping Factor @ 4 Ohms / 100Hz	>150	>100	>100
S/N Ratio(A-Weight)	>90dB	>90dB	>90dB
THD	<0.1%	<0.1%	<0.1%
Crossover, Phase Shift, Line-Input			
Crossover S/W for 1+2 channel 12dB/Oct.	N / A	HP/FULL/LP	HP/FULL/LP
Variable Hi-Pass	N / A	50Hz-500Hz	50Hz-500Hz
Variable Low-Pass	50Hz-250Hz	50Hz-500Hz	50Hz-500Hz
Bass Boost, 12dB @ 45 Hz	YES	YES	YES
Others			
Heatsink Length (mm)	330	270	330

NOTE : Specifications & design subject to change without notice for improvements.

WARRANTY

WARRANTY LIMITATIONS

The following is **NOT** covered under TUNN warranty program:

1. Product owned by anyone other than the original purchaser from an authorized TUNN dealer.
(The warranty is **NOT** transferable and will not apply to products purchased from unauthorized dealers.)
2. Speaker products that have been over-powered, causing thermal (burnt voice coil) and/or mechanical failure (ripped surrounds or spiders).
3. Product that has **NOT** been installed according to the instructions in the owner's manual
4. Product in which repair and/or modification has been attempted by unauthorized parties
5. Product damaged in an accident, due to criminal activity (attempted theft, gunshot damage, etc.) or by "acts of God" (flooding, lightning, etc.)
6. Product that has been physically damaged abused and/or altered. Including bent frames or missing magnets.
7. Custom finishes or other cosmetic treatments applied to products. (TUNN will not be responsible for restoring or maintaining any Custom finishes)
8. Product with defaced, altered or removed serial numbers (no valid, legible serial No. = no warranty).
9. Product damaged cosmetically due to improper handling or normal wear and tear Including Freight damage. Be sure to package all returns in its packing material and box.
10. Installation and shipping costs associated with removing, re-installing or shipping the product to TUNN for warranty service

WARRANTY TERMS

(Effective April 1st, 2008)

These terms supersede all prior published warranty terms

TUNN products are warranted against defects in materials and workmanship for a period of One (1) Year from the original date of purchase.

Products found to be defective during the warranty period will be repaired or replaced (with a product deemed to be equivalent) at TUNN's discretion.

Note: Products purchased from unauthorized dealers are not covered under warranty. Ask your dealer for details on warranty limitations.

INTERNATIONAL WARRANTIES:

Products purchased outside the United States of America are covered only by that country's distributor and not by TUNN, Inc.

IF YOU NEED SERVICE ON YOUR TUNN PRODUCT:

Please call TUNN Customer Service at 1-877-90-AUDIO to obtain an RA # (Return Authorization number). All warranty returns should be sent to TUNN freight prepaid through an authorized TUNN Dealer and must be accompanied by proof of purchase (a copy of the original sales receipt). Direct returns from consumers or non-authorized dealers will be Refused unless specifically authorized by TUNN with a valid return authorization number. Warranty expiration on products returned without proof of purchase will be determined from the manufacturing date code. Coverage may be invalidated as this date is previous to purchase date. Return only defective components. Non-defective items received will be returned freight-collect. Customer is responsible for shipping charges and insurance in sending the product to TUNN. Freight damage on returns is not covered under warranty. Always include proof of purchase (sales receipt).

NOTICE: Products shipped without a valid RA# will be refused and shipped back.

TUNN[®]
By *interfire*

10110 Santa Fe Springs Road
Santa Fe Springs, CA 90670
1-562-926-2600

Free Manuals Download Website

<http://myh66.com>

<http://usermanuals.us>

<http://www.somanuals.com>

<http://www.4manuals.cc>

<http://www.manual-lib.com>

<http://www.404manual.com>

<http://www.luxmanual.com>

<http://aubethermostatmanual.com>

Golf course search by state

<http://golfingnear.com>

Email search by domain

<http://emailbydomain.com>

Auto manuals search

<http://auto.somanuals.com>

TV manuals search

<http://tv.somanuals.com>