Kodak EasyShare Z1275/Z1285 digital camera



Extended user guide

www.kodak.com

For interactive tutorials, visit www.kodak.com/go/howto

For help with your camera, visit www.kodak.com/go/z1275support,
www.kodak.com/go/z1285support

Kodak

Eastman Kodak Company
Rochester, NY 14650

© Eastman Kodak Company, 2007

All screen images are simulated.

Kodak, EasyShare, and Perfect Touch are trademarks of Eastman Kodak Company.

P/N 4J6185_en

Front view

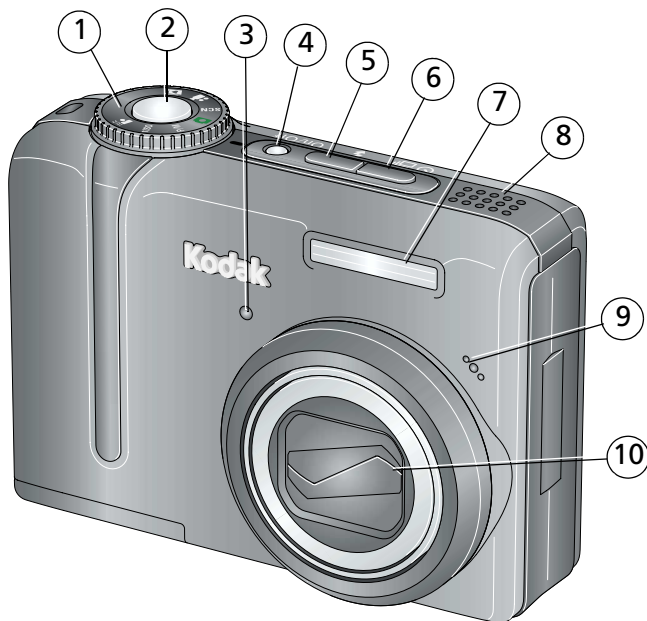

- | | | | |
|---|--|----|---|
| 1 | Mode dial | 6 | Self-timer/Burst button  |
| 2 | Shutter button | 7 | Flash |
| 3 | Self-timer/Video light | 8 | Speaker |
| 4 | On/Off button | 9 | Microphone |
| 5 | Flash button  | 10 | Lens |

Back view

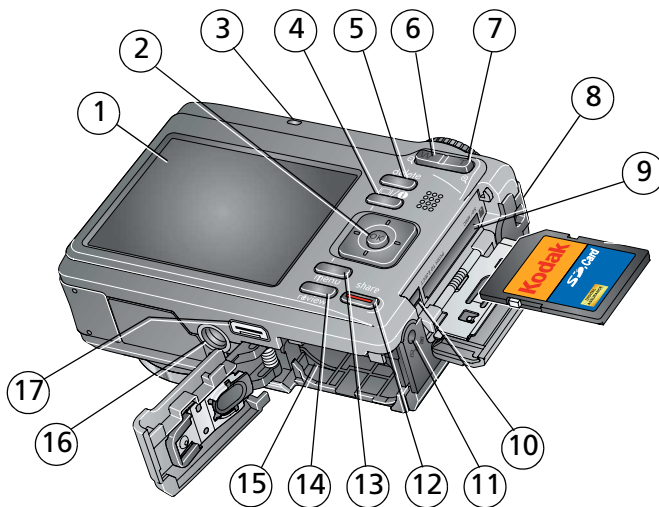





- | | | | |
|---|---|----|---|
| 1 | LCD | 10 | USB, A/V Out  |
| 2 |  , OK | 11 | DC-In  , for optional 3V AC adapter |
| 3 | Ready light | 12 | Share button |
| 4 | LCD/Info button  | 13 | Menu button |
| 5 | Delete button | 14 | Review button |
| 6 | Wide angle (W) button | 15 | Battery compartment |
| 7 | Telephoto (T) button | 16 | Tripod socket |
| 8 | Strap post | 17 | Dock connector |
| 9 | Slot for optional SD/SDHC or MMC card | | |

Table of contents

1	Setting up your camera	1
	Attaching the strap	1
	Loading the battery	1
	Turning on the camera	2
	Setting the language, date/time	2
	Using an optional SD/SDHC or MMC card	3
2	Taking pictures/videos	4
	Taking a picture	4
	Capture modes	6
	Using optical zoom	8
	Using the flash	9
	Using the self-timer	10
	Taking panoramic pictures	11
	Understanding the picture-taking icons	12
3	Working with pictures/videos	13
	Reviewing pictures/videos	13
	Deleting pictures/videos	15
	Using the menu button in Review	16
	Adding sound tags	17
	Cropping pictures	18
	Using Kodak Perfect Touch technology	18
	Editing videos	19
	Running a slide show	21
	Viewing pictures/videos in different ways	24
	Selecting multiple pictures/videos	25
	Copying pictures/videos	25
	Understanding the review icons	26

4	Doing more with your camera	27
	Using the Menu button to change settings	27
	Using the framing grid to compose a picture.....	32
	P and M modes.....	33
	Using burst	36
	Using exposure compensation to adjust picture brightness.....	37
	Using the histogram to view picture brightness.....	38
	Sharing your pictures.....	38
5	Transferring and printing pictures	44
	Installing the software.....	44
	Transferring pictures with the USB cable.....	45
	Printing pictures.....	46
	Dock compatibility for your camera.....	48
6	Troubleshooting	49
7	Getting help	55
	Helpful links.....	55
8	Appendix	57
	Camera specifications	57
	Storage capacities	60
	Upgrading your software and firmware.....	60
	Important safety instructions	60
	Battery life	61
	Care and maintenance	62
	Limited Warranty	62
	Regulatory compliance	65

1

Setting up your camera

Attaching the strap

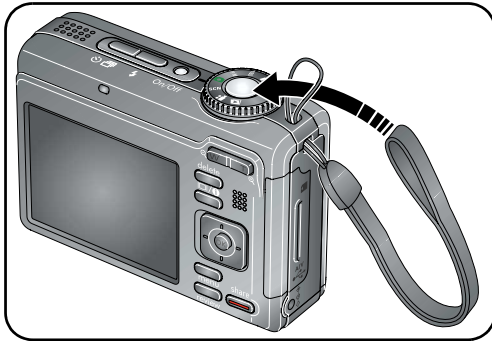

Loading the battery

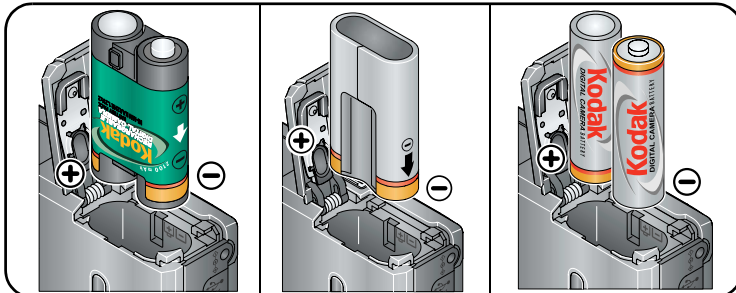

Ni-MH
(rechargeable)

CRV3 lithium
(non-rechargeable)

2 AA (rechargeable or
non-rechargeable)

To extend battery life, see [page 61](#).

www.kodak.com/go/support

Turning on the camera

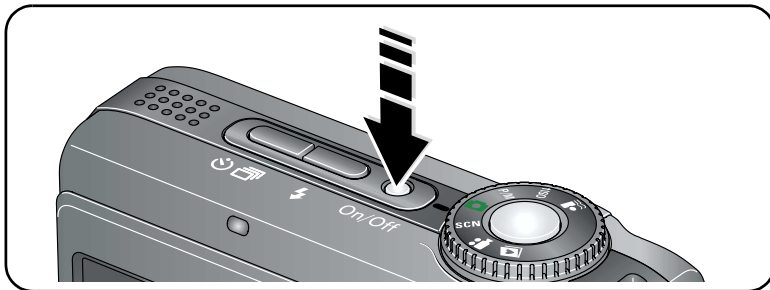

Setting the language, date/time

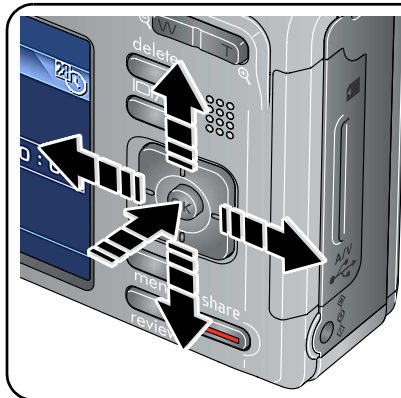
An illustration of the camera's back panel focusing on the navigation controls. A central circular multi-selector is surrounded by four directional arrows: up, down, left, and right. Below the multi-selector are buttons labeled 'menu', 'share', and 'review'. Above it is a 'delete' button. The camera's LCD screen is visible on the left side.

Language:

▲/▼ to change.

OK to accept.

Date/Time:

▲/▼ to change.

◀/▶ for previous/next field.

OK to accept.

NOTE: To change the date/time and language in the future, use the Menu button ([see page 31](#)).

Using an optional SD/SDHC or MMC card

Your camera has internal memory. You can purchase an SD/SDHC or MMC card to store more pictures and videos (www.kodak.com/go/z1275accessories, www.kodak.com/go/z1285accessories). We recommend Kodak SD/SDHC or MMC cards.

NOTE: To choose a storage location for pictures and videos, [see page 31](#).

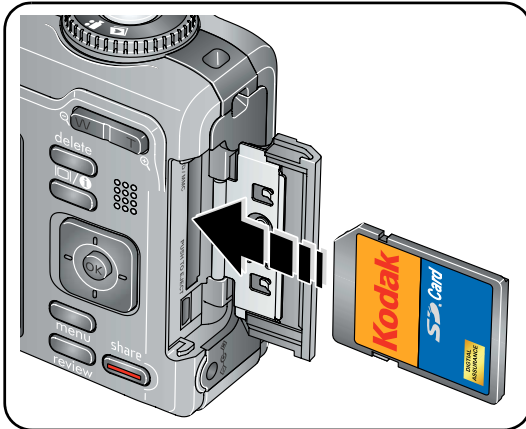

CAUTION:

A card can only be inserted one way; forcing it may cause damage. Inserting or removing a card when the Ready light is blinking may damage the pictures, the card, or the camera.

2

Taking pictures/videos

Taking a picture

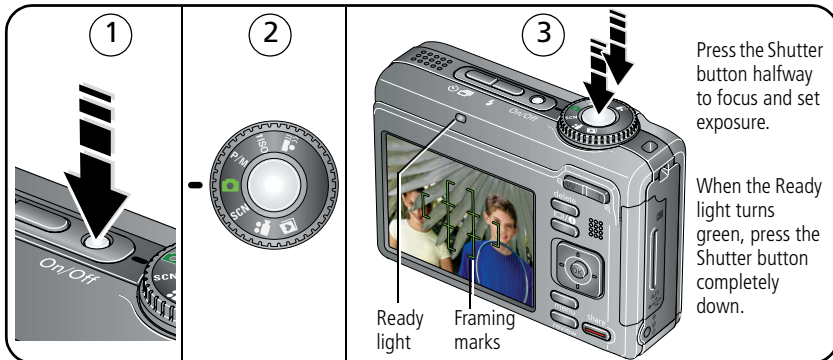

NOTE: Press  to turn on/off status icons (see page 12) and histogram (see page 38). For more information on framing marks, see page 5.

Taking a video

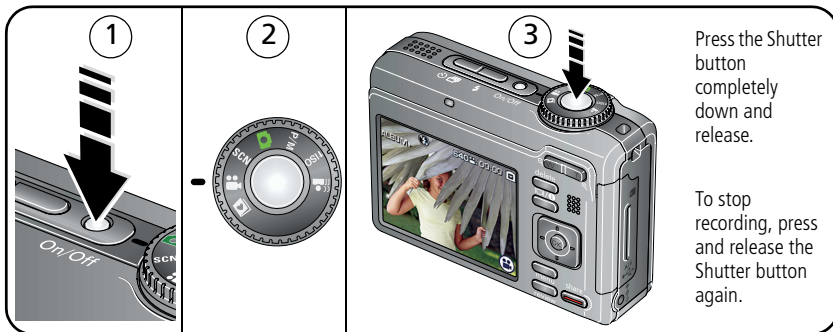

Reviewing the picture/video just taken

After you take a picture/video, the LCD displays a quickview for several seconds. (To dismiss the quickview sooner, press the Shutter button halfway.)

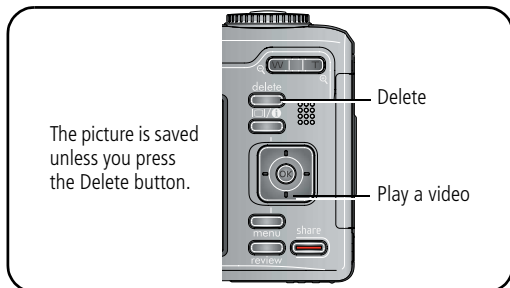

To review pictures/videos anytime, see [page 13](#).

Using the framing marks to take pictures

Framing marks indicate the camera focus area. The camera attempts to focus on foreground subjects, even if they're not centered in the scene.

1 Press the Shutter button **halfway**.





When the subject is in focus, the framing marks turn green. If the camera is not focusing on the desired subject (or if the framing marks disappear), release the Shutter button and recompose the scene.

2 Press the Shutter button **completely down** to take the picture.

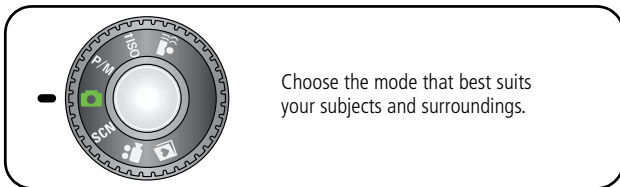



NOTE: Framing marks do not appear in some SCN (scene) and Video modes. When you use AF Zone and set Center Zone ([see page 29](#)), the framing marks are fixed at Center Wide.

Capture modes



Capture mode	For
 Smart Scene	General picture taking. When the Shutter button is pressed halfway, faces are detected, the scene is analyzed, and the best settings are applied.
P/M P, M	Program, Manual modes for more creative control. (See page 33).
 ISO High ISO	People in low-light scenes indoors using a higher ISO.
 Digital Image Stabilization	Minimizing the effects of camera shake and subject movement.
SCN Scene	Point-and-shoot simplicity when taking pictures under special conditions. (See page 6 .)
 Video	Capturing video with sound. (See page 4 .)
 Favorites	Viewing favorite pictures. (See page 40 .)

Scene modes

- 1 Turn the Mode dial to Scene **SCN**.
- 2 Press     to display Scene modes.

NOTE: If the mode description turns off before you finish reading it, press OK.

3 Press OK to choose a Scene mode.

Use this SCN mode	For
Portrait	Full-frame portraits of people.
Panorama L-R, R-L	Stitching up to 3 pictures into one panoramic scene (see page 11).
Sport	Subjects that are in motion. Shutter speed is fast. The camera pre-settings are Multi-Pattern Exposure Metering and Multi-Zone Focus.
Landscape	Far-away scenes. The camera uses infinity auto-focus. Auto-focus framing marks are not available in Landscape.
Close-up	Close range. Use available light instead of flash if possible. The camera automatically sets the focus distance depending on the zoom position.
Night Portrait	Reducing red eye of people in night scenes or low-light conditions. Place the camera on a flat, steady surface or use a tripod.
Night Landscape	Distant scenery at night. Flash does not fire. Place the camera on a flat, steady surface or use a tripod.
Snow	Bright snow scenes.
Beach	Bright beach scenes.
Text	Documents. Focus is set to Macro Focus (see page 29).
Fireworks	Bright, colorful light displays. Flash does not fire. Place the camera on a flat, steady surface or use a tripod.
Flower	Close-ups of flowers or other small subjects in bright light. Focus is set to Macro Focus (see page 29).
Manner/Museum	Quiet occasions, like a wedding or lecture. Flash and sound are disabled.
Self-Portrait	Close-ups of yourself. Assures proper focus and minimizes red eye.
Children	Action pictures of children in bright light.
Backlight	Subjects that are in shadow or "backlit" (when light is behind the subject).

Use this SCN mode	For
Panning Shot	Fast-moving subjects. The background gives the sense of movement, while the subject appears still. Shutter speed is > 1/180 sec.
Candle light	Capturing the ambiance of candle light.
Sunset	Capturing the deep hues seen at sunset.

Using optical zoom

Use optical zoom to get up to 5X closer to your subject while taking pictures/videos. Optical zoom is effective when the lens is no closer than 24 in. (60 cm) to the subject or 7.9 in. (20 cm) in Close-up mode.

- 1 Use the LCD to frame your subject. For focus distances, see [Camera specifications, page 57](#).
- 2 Press Telephoto (T) to zoom in. Press Wide Angle (W) to zoom out.
The zoom indicator shows zoom status.

- 3 Take the picture or video.

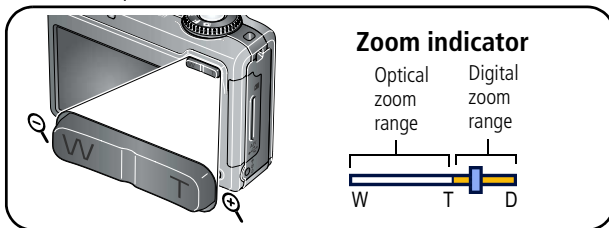

Using the digital zoom

Use digital zoom to get up to 5X beyond optical zoom while taking pictures. Press Telephoto (T) to the maximum optical zoom. Release the button, then press it again.

NOTE: You may notice decreased image quality when using digital zoom. The slider on the zoom indicator turns red when the picture quality reaches the limit for an acceptable 4 x 6-in. (10 x 15 cm) print.

Using the flash

Use the flash when you take pictures at night, indoors, or outdoors in heavy shadows.

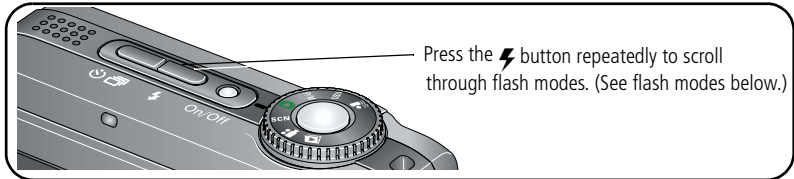

Flash modes	Flash fires	
⚡ Auto	When the lighting conditions require it.	
⚡ Fill	Every time you take a picture, regardless of the lighting conditions. Use when the subject is in shadow or is “backlit” (when the light is behind the subject). In low light, hold the camera steady or use a tripod.	
👁 Red-eye	If Red-eye Pre-flash is turned off: <ul style="list-style-type: none"> ■ The flash fires once and the camera automatically corrects red-eye in the picture. 	If Red-eye Pre-flash is turned on: <ul style="list-style-type: none"> ■ The flash fires once so the eyes become accustomed to the flash, then fires again when the picture is taken.
	To turn the Red-eye Pre-flash feature on/off, see page 30 .	
⚡ Off	Never.	

Flash-to-subject distance	
Wide angle	2–19.3 ft (0.6–5.9 m) @ ISO 400
Telephoto	2–10.5 ft (0.6–3.2 m) @ ISO 400

Using the self-timer

Use the self-timer when you want to be included in a picture, or to ensure a steady Shutter button press.

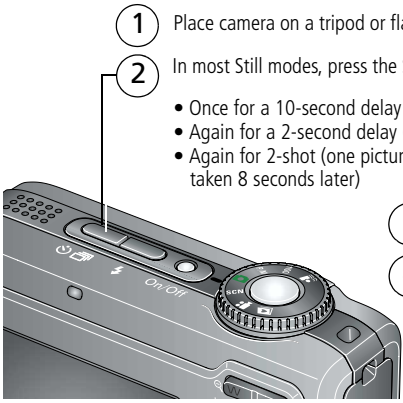

1 Place camera on a tripod or flat surface.

2 In most Still modes, press the Self-Timer/Burst button :

- Once for a 10-second delay (so you have time to get into the scene)
- Again for a 2-second delay (for a steady, auto-shutter release on a tripod)
- Again for 2-shot (one picture taken after 10 seconds and another picture taken 8 seconds later)

3 Compose the scene.

4 Press the Shutter button halfway, then completely down.
The picture is taken after the delay.

To cancel the Self-timer before the picture is taken, press the Self-timer/Burst button , or press the Shutter button completely down.

Use the same procedure to use the self-timer in Video mode, but:

- Turn the Mode dial to Video .
- Press the Shutter button completely down.

NOTE: The video stops when no storage space remains. Only the 2- and 10-second options are available in video mode.

Taking panoramic pictures

Use panorama to “stitch” up to 3 pictures into a panoramic scene.

NOTE: For best results, use a tripod. Individual pictures are not saved, even if panorama capture is cancelled before stitching occurs. (Picture size is set to 4.8 MP for each picture. Exposure Compensation, White Balance, Exposure Metering, AF Zone, AF Control, Color Mode, and Sharpness are set with the first picture. The flash is set to Off.) You can use the self-timer (2- and 10-second delays) while taking panoramic pictures. [See page 10.](#)

- 1 Turn the Mode dial to SCN.
- 2 Press **◀/▶** to highlight Panorama Left-Right or Panorama Right-Left (depending on the direction you want to pan), then press the OK button.
- 3 Take the first picture.
After a quickview, the LCD displays the liveview and an “overlay” from the first picture.
- 4 Compose the second picture. Make the overlay from the first picture cover the same portion in the new picture. (You can press the Delete button to re-take a picture.)
- 5 If you are taking only 2 pictures, press the OK button to stitch them together.
After you take 3 pictures, the pictures are automatically stitched together.



Understanding the picture-taking icons

Status icons indicate mode, feature, and camera status.

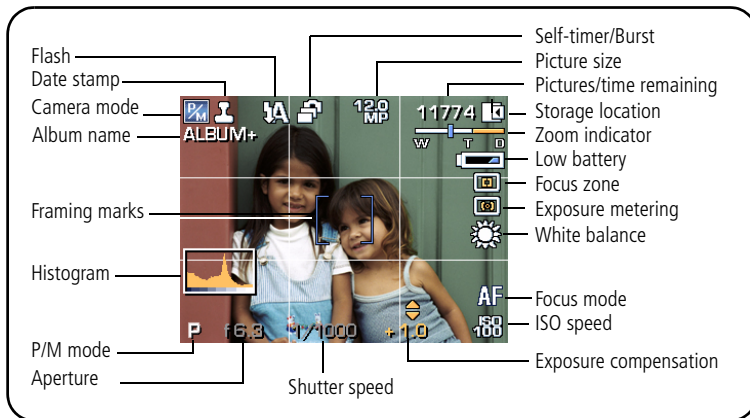

3

Working with pictures/videos

Reviewing pictures/videos

Press the Review button to view and work with your pictures/videos. Press Review again to exit.



- 1 Press the Review button.
- 2 Press  to view previous/next picture/video.

NOTE: Pictures taken at the 3:2 and 16:9 aspect ratios (see page 27) do not fill the LCD.

Magnifying a picture during review

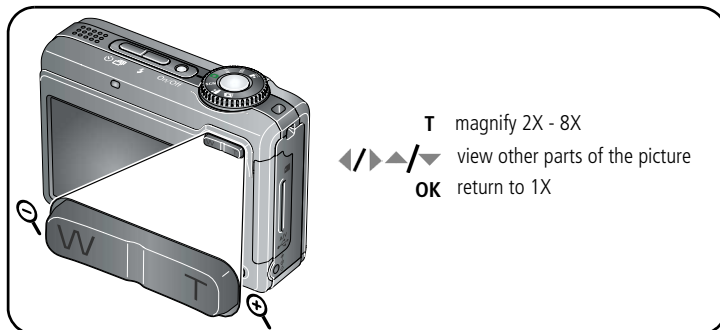

NOTE: If you press the W button while at 1X, the view changes from single-picture to multi-up thumbnails. (See page 24.)

Playing a video

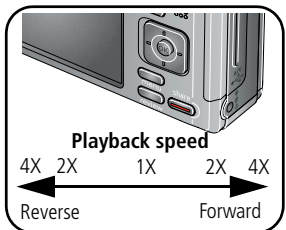

- 1 Press the Review button.
- 2 Press ◀/▶ to locate previous/next video.
- 3 Press ▼ to play a video.
 - Press ▲/▼ to adjust the volume.
 - Press OK to pause/unpause.
 - Press ▶ during playback to play at 2X speed; press again for 4X.
 - Press ◀ during playback to reverse at 2X speed; press again for 4X.

Viewing picture/video information

- 1 Press the Review button.
- 2 Repeatedly press the LCD/Info   button to turn on/off status icons and picture/video info.

Deleting pictures/videos



- 1 Press the Review button.
- 2 Press  to find a picture/video.
- 3 Press the Delete button.
- 4 Follow the screen prompts.

Using the undo delete feature

If you accidentally delete a picture/video, use Undo Delete to retrieve it. This feature is available only immediately after you delete a picture/video in Review mode (when the Undo Delete option appears).

- 1 Press  to highlight Undo Delete.
- 2 Press OK.
The deleted picture/video appears.
- 3 Select Exit to exit the Delete menu.

Protecting pictures/videos from deletion







- 1 Press the Review button.
- 2 Press  to find a picture/video.
- 3 Press the Menu button.
- 4 Press  to highlight Protect, then press OK.
The Protect icon  appears with the protected picture/video.
 - Press the Menu button to exit the menu.





CAUTION:

Formatting internal memory or an SD/SDHC or MMC card deletes all (including protected) pictures/videos. (Formatting internal memory also deletes email addresses, album names, and favorites.)

Using the menu button in Review

- 1 Press the Review button, then the Menu button.
- 2 Press   to choose a tab:
 -  **Review** to view pictures/videos
 -  **Edit** to edit pictures/videos
 -  **Setup** for other camera settings
- 3 Press   to highlight a setting, then press the OK button.
- 4 Choose an option, then press the OK button.

 Options	
View By	See page 24
Album	See page 24
Slide Show	See page 21
Multi-up	See page 24
Copy To	See page 25
Protect/Unprotect	See page 15
Select/Deselect All	See page 25

 Options		
Pictures	Perfect Touch tech.	See page 18
	Crop	See page 18
	Sound Tags	See page 17
Videos	Make Picture	See page 19
	Trim	See page 19
	Action Print	See page 21
	Bookmark	See page 20

Adding sound tags

You can record a voice or sound (up to 1 minute long) to a picture.

NOTE: Only one sound tag can be added to each picture (not to videos).

Recording a sound tag

- 1 Press the Review button, then ◀/▶ to find a picture.
- 2 Press the Menu button, then ◀/▶ to highlight the Edit tab.
- 3 Press ▲/▼ to highlight Sound Tag. Press the OK button.
- 4 Choose Record, then press OK.
- 5 Follow the screen prompts.

The sound tag is applied to your picture.

- Press the Menu button to exit the menu.

Playing a sound tag

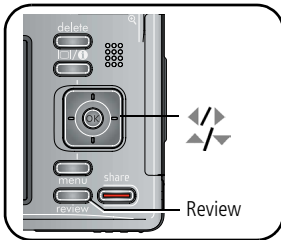

- 1 Press the Review button, then ◀/▶ to find a  tagged picture.
- 2 Press ▼ to play the sound tag.
- 3 Press ▲/▼ to adjust the volume.
- 4 Press OK to stop playback.

Cropping pictures

You can crop a picture so that only the desired portion of the picture remains.

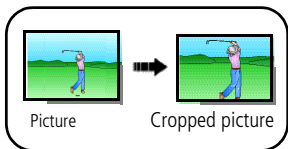

- 1 Press the Review button, then ◀/▶ to find a picture.
- 2 Press the Menu button, then ◀/▶ to highlight the Edit tab.
- 3 Press ▲/▼ to highlight Crop. Press the OK button.
- 4 Press Telephoto (T) to zoom in, or ◀/▶ ▲/▼ to move the crop box. Press OK.
- 5 Follow the screen prompts.

The picture is cropped. The original is saved. (Cropped pictures cannot be cropped again.)

- Press the Menu button to exit the menu.

Using Kodak Perfect Touch technology

Kodak Perfect Touch technology helps ensure better, brighter pictures.

- 1 Press the Review button, then ◀/▶ to find a picture.
- 2 Press the Menu button, then ◀/▶ to highlight the Edit tab.
- 3 Press ▲/▼ to highlight Perfect Touch tech. Press the OK button.

The enhancement is previewed in a split screen. Press ◀/▶ to view other parts of the picture.

- 4 Press OK. Follow the screen prompts to replace the original picture or to save the enhanced picture as a new one.

NOTE: You cannot enhance previously enhanced or panorama pictures, or videos.

- Press the Menu button to exit the menu.

Editing videos

Making a picture from a video

You can choose a single frame from a video, then make a picture suitable for printing.

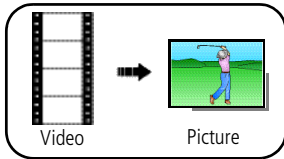

- 1 Press the Review button, then ◀/▶ to find a video.
- 2 Press the Menu button, then ◀/▶ to highlight the Edit tab.
- 3 Press ▲/▼ to highlight Make Picture, then press the OK button.
- 4 Press ▼ to play the video. (Press the OK button to pause). Press ◀/▶ to navigate through video frames.
- 5 Press OK to select a video frame, then press ▼.
- 6 Follow the screen prompts.

A picture is created. (The original video is saved.)

- Press the Menu button to exit the menu.

Trimming a video

You can delete an unwanted portion from the beginning or end of a video.

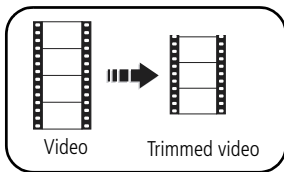

- 1 Press the Review button, then ◀/▶ to find a video.
- 2 Press the Menu button, then ◀/▶ to highlight the Edit tab.
- 3 Press ▲/▼ to highlight Trim. Press the OK button.
- 4 Follow the screen prompts.

The video is trimmed. (You can save it as a new video or replace the original.)

- Press the Menu button to exit the menu.

Using video bookmarks

You can set bookmarks at interesting places in your video, then jump from one bookmark to another.

Setting bookmarks

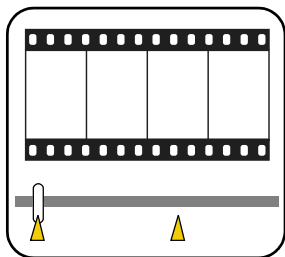

- 1 Press the Review button, then ◀/▶ to find a video.
- 2 Press the Menu button, then ◀/▶ to choose the Edit tab. Choose Bookmark, then press OK.
- 3 Press ▼ to add bookmarks. When finished adding up to 9 bookmarks, press ▲.
 - Press the Menu button to exit the menu.

Using bookmarks

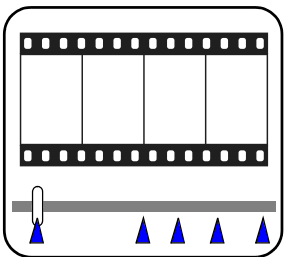

- 1 Press the Review button, then ◀/▶ to find a video.
- 2 Press ▼ to play the video. To jump to the first bookmark, press and hold ◀/▶ for 4 seconds while the video is playing.
 - After you jump to a bookmark, press ◀/▶ to jump to other bookmarks.
 - To view all bookmarked video frames, press the Zoom wide angle (W) button. To return to normal view, press the telephoto (T) button.

Making a video action print

From a video, you can make a 4-, 9-, or 16-up picture, suitable for a 4 x 6-inch (10 x 15 cm) print.

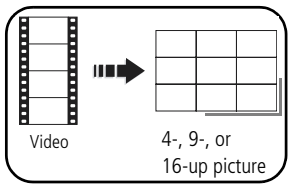

- 1 Press the Review button, then ◀/▶ to find a video.
- 2 Press the Menu button, then ◀/▶ to highlight the Edit tab.
- 3 Press ▲/▼ to highlight Action Print. Press the OK button. Choose an option, then press the OK button:

- Auto options: The camera includes the first and last frames, then 2, 7, or 14 equally spaced frames.
- Manual: You choose the first and last frames; the camera chooses 2, 7, or 14 equally spaced frames.
- Use Bookmarks: Bookmarked frames are used.
A 4-, 9-, or 16-up picture is created. If you have less than 4 or 9 bookmarks, equally-spaced video frames are used.
- Press the Menu button to exit the menu.

Running a slide show

Use Slide Show to display your pictures/videos on the LCD. If you have a Kodak EasyShare HDTV dock, see its user documentation.

Starting the slide show

- 1 Press the Review button, then the Menu button.
- 2 Press ▲/▼ to highlight Slide Show, then press the OK button.
- 3 Press ▲/▼ to highlight Begin Show, then press the OK button.

To interrupt the Slide Show, press the OK button.

Changing the slide show display interval

The default interval setting displays each picture for 5 seconds. You can set the display interval from 3–60 seconds.

- 1 On the Slide Show menu, press ▲/▼ to highlight Interval, then press the OK button.
- 2 Select a display interval.
To scroll through the seconds quickly, press and hold ▲/▼.
- 3 Press the OK button.

The interval setting remains until you change it.

Running a continuous slide show loop

When you turn on Loop, the slide show is continuously repeated.

- 1 On the Slide Show menu, press ▲/▼ to highlight Loop, then press the OK button.
- 2 Press ▲/▼ to highlight On, then press the OK button.
- 3 Press ▲/▼ to highlight Begin Show, then press the OK button.

The slide show repeats until you press the OK button or until battery power is exhausted. The Loop feature remains until you change it.

Displaying pictures/videos on a television

You can display pictures/videos on a television, computer monitor, or any device equipped with a video input. To connect the camera to a television, use an A/V cable (may be sold separately).

For a true HDTV experience on your television, dock your camera on the Kodak EasyShare HDTV dock. Visit www.kodak.com/go/hdtdock.

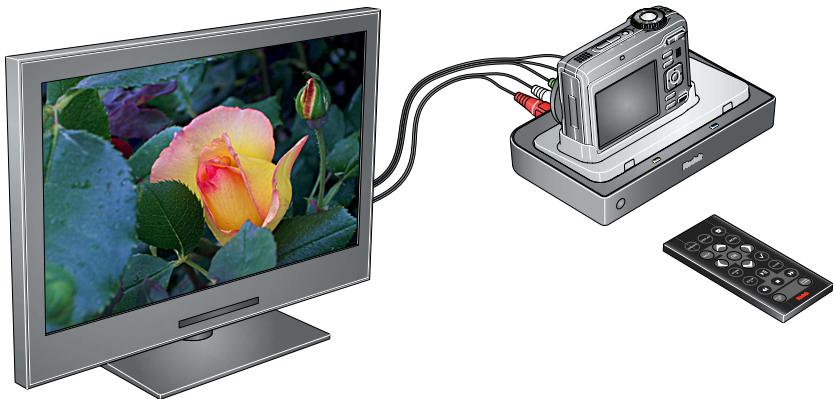

Viewing pictures/videos in different ways

Viewing as thumbnails (multi-up)

- 1 Press the Review button.
- 2 Press the Zoom Wide Angle (W) button to change from single-picture view to multi-up thumbnails.
- 3 Press Telephoto (T) to return to single-picture view.
 - To select multiple pictures/videos, see [page 25](#).
 - Press the Review button to exit Review.

Viewing by date, album, or image storage location

- 1 Press the Review button, then the Menu button.
- 2 Press $\blacktriangle/\blacktriangledown$ to highlight View By, then press the OK button.
- 3 Press $\blacktriangle/\blacktriangledown$ to highlight All (default), Date, Album, or Image Storage Location, then press the OK button.
 - Press $\blacktriangle/\blacktriangledown$ $\blacktriangleleft/\blacktriangleright$ to highlight a date or album, then press the T button. To return to the list of dates or albums, press the W button.
 - Press the Review button to exit Review.
 - For more about albums, see [page 42](#).

Selecting multiple pictures/videos

Use the multi-select feature when you have two or more pictures/videos to print, transfer, or delete pictures/videos. (Multi-select is used most effectively in Multi-Up mode, [page 24](#).)

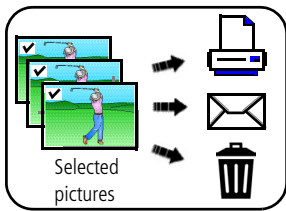

- 1 Press the Review button, then ◀/▶ to find a picture/video.
- 2 Press the OK button to select pictures/videos.

A check mark appears on the picture. You can now print, transfer, or delete the selected pictures. You can press OK a second time to remove a check mark.

Copying pictures/videos

You can copy pictures/videos from a card to internal memory or from internal memory to a card.

NOTE: Before you copy, make sure that a card is inserted in the camera.

Copy pictures/videos:

- 1 Press the Review button, then the Menu button.
- 2 Press ▲/▼ to highlight Copy To, then press the OK button.
- 3 Press ▲/▼ to highlight an option.
- 4 Press the OK button.

NOTE: Pictures/videos are copied, not moved. To remove pictures/videos from the original location after copying, delete them (see [page 15](#)).

Tags that you applied for print, email, and favorites are not copied. (Sound tags are copied.)

Protection settings are not copied. To apply protection to a picture/video, see [page 15](#).

Understanding the review icons

Pictures

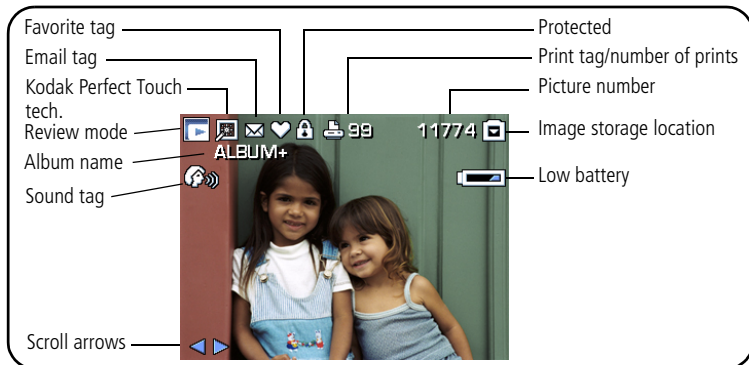

Videos











4





Doing more with your camera





Using the Menu button to change settings





NOTE: Some settings remain until you change them; others remain until you turn off the camera.





- 1 Press the Menu button.
- 2 Press   to highlight a menu tab:
 -  **Capture** for the most common picture-taking settings.
 -  **Capture Plus** for other picture-taking settings.
 -  **Setup** for other camera settings.
- 3 Press   to highlight a setting, then press the OK button.
- 4 Choose an option, then press the OK button.

NOTE: Press the LCD/Info button   for information about camera settings and options. Some capture modes offer limited settings.





Press Menu,  ,  ,  ,  , and OK to access settings	 Options
Picture Size Choose a picture resolution. For recommended print sizes, visit www.kodak.com/go/printsizes	12.0 MP (4:3) (default) —Highest resolution, largest file size 10.7 MP (3:2) —For EasyShare printer docks, photo printers 9.0 MP (16:9) —HDTV format 6.0 MP (4:3) —Medium resolution and file size 3.1 MP (4:3) —Smaller resolution and file size 2.2 MP (3:2) —For EasyShare printer docks, photo printers 2.1 MP (16:9) —HDTV format 1.2 MP (4:3) —For emailing, Internet, or conserving space







Press Menu,   ,  /  , and OK to access settings	 Options
Video Size Available only in Video mode.	1280 x 720 (HD) —HDTV format; uses the least compression, and gives the highest video quality. 640 x 480 (default) —medium quality and file size. 320 x 240 —lowest quality; smallest file size.
Color Mode Choose color tones.	High Color Natural Color (default) Low Color Black & White Sepia —pictures have a reddish-brown, antique look. NOTE: EasyShare software also lets you change a color picture to black-and-white or sepia. Unavailable in Video mode.
AF Control Choose an auto-focus setting. Available only in SCN, P/M, and Video modes.	Continuous AF —because the camera is always focusing, there is no need to press the Shutter button halfway down to focus. Single AF (default) —uses TTL-AF (through-the-lens auto focus) when the Shutter button is pressed halfway down.
Date Stamp Imprint the date on pictures.	Choose a date option, or turn off the feature. (Default is off.)

<p>Press Menu,   ,   , and OK to access settings</p>	<p> Options</p>
<p>White Balance Choose your lighting condition. Available only in P/M and Panorama modes.</p>	<p>Auto (default)—automatically corrects white balance. Ideal for general picture taking. Daylight—for pictures in natural lighting. Tungsten—corrects the orange cast of household light bulbs. Ideal for indoor pictures under tungsten or halogen lighting without flash. Fluorescent—corrects the green cast of fluorescent lighting. Ideal for indoor pictures under fluorescent lighting without flash. Open Shade—for pictures in shade in natural lighting.</p>
<p>Exposure Metering Evaluate light levels at specific areas of a scene. Available only in P/M and Panorama modes.</p>	<p>Multi-pattern (default)—evaluates lighting conditions throughout the image to give an optimum picture exposure. Ideal for general picture taking. Center-weighted—evaluates the lighting conditions of the subject centered in the LCD. Ideal for backlit subjects. Spot—similar to Center-weighted, except the metering is concentrated on a smaller area of the subject centered in the LCD.</p>
<p>AF Zone Select a large or concentrated area of focus. Available only in P/M and Panorama modes.</p>	<p>Multi-zone (default)—evaluates 5 zones to give an even picture focus. Ideal for general picture taking. Center-zone—evaluates the small area centered in the LCD. Ideal when precise focus of a specific area in the picture is needed.</p>
<p>Exposure Bracketing Interval Choose the difference in exposure compensation while using exposure bracketing. Available only in P/M mode.</p>	<p>Off (default) +/- 0.3 EV +/- 0.7 EV +/- 1.0 EV See page 37.</p>

Press Menu,  /  ,  /  , and OK to access settings	 Options
Sharpness Control picture sharpness. Available only in P/M and Panorama modes.	High Normal (default) Low
Red-eye Pre-flash Choose if the Red-eye flash fires automatically before a picture is taken. NOTE: The camera automatically corrects red-eye, when the Red-eye Pre-flash is set to Off.	On (default) Off

Using the Setup menu

Press Menu,  ,  ,  ,  , and OK to access settings	 Options
LCD Brightness	Power Save (default) High Power
Image Storage Choose a storage location for pictures/videos.	Auto (default) —the camera uses the card if one is in the camera. If not, the camera uses internal memory. Internal Memory —the camera uses internal memory, even if a card is installed.
Set Album Choose Album names.	On or Off Pre-select album names before you take pictures or videos. Then, all the pictures or videos you take are tagged with those album names. See page 43 .
Capture Frame Grid Use the frame grid to divide the LCD screen into thirds, vertically and horizontally.	On Off (default)
Orientation Sensor Orient pictures so that they are displayed with the correct side up.	On (default) Off
Camera Sounds Choose sound effects.	Theme —applies the same sound effect set to all functions. Individual —choose a sound effect for each function.
Sound Volume	Off Low Medium (default) High
Date & Time	See page 2 .

Press Menu,  ,  ,  ,  , and OK to access settings	 Options
Auto Power Off Choose inactivity time until camera turns off.	10 minutes 5 minutes 3 minutes (default) 1 minute
Video Out Choose the regional setting for connecting to a television or other external device.	NTSC (default) —used in North America and Japan. PAL —used in Europe and China.
Language	See page 2 .
Reset Camera	Reset picture-taking settings to their defaults.
Format  CAUTION: Formatting deletes all pictures/videos, including those that are protected.	Memory Card —deletes everything on the card; formats the card. Cancel —exits without making a change. Internal Memory —deletes everything in internal memory including email addresses, album names, and favorites; formats the internal memory.
About View camera information.	

Using the framing grid to compose a picture

The framing grid divides the LCD into thirds—vertically and horizontally. This is helpful if, for example, you want to balance a picture between water, earth, and sky.



To turn on/off the framing grid, [see page 31](#).

P and M modes

Use Program and Manual modes when you want more control over your camera and pictures.



Mode	For	Press ◀/▶▲/▼ to control
P Program	Ease of auto shooting with full access to most menu options. The camera automatically sets the shutter speed and aperture (f-stop) based on the scene lighting.	Exposure compensation (how much light enters the camera), Focus mode, and ISO speed
M Manual	The highest level of creative control. (To prevent blur, use a tripod for slow shutter speeds.)	Aperture, shutter speed, focus mode, and ISO speed

NOTE: Settings you change in P or M mode apply only to pictures taken in that mode. For example, if you change the Color Mode to Sepia while in P or M mode, you retain the default setting of Color for Smart scene and Scene modes.
The settings, including Flash, are maintained for P and M modes—even when you change modes or turn off the camera.

Changing P or M mode settings

P/M modes control ISO, Focus, exposure compensation, shutter speed, and aperture (f-number, also known as f-stop). Use the Menu button to control all other settings.

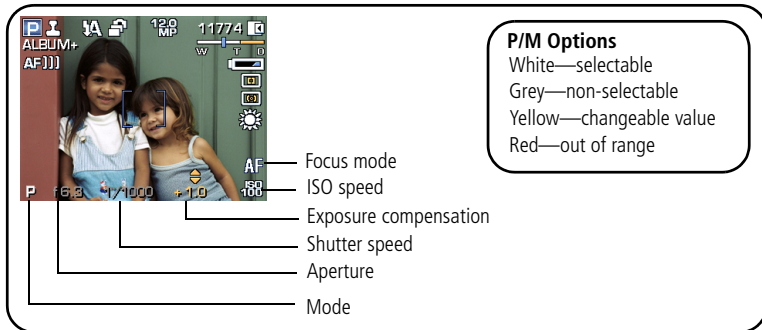

- 1 Turn the Mode dial to P/M.

The mode options are displayed.

- 2 Use ◀/▶ to move between settings and ▲/▼ to change the value.

NOTE: Some settings may be unavailable (see P/M color options above). The arrows disappear when you cannot make further value changes.

- 3 Take a picture.

P/M mode—see [page 33](#).

ISO speed—adjust the camera's sensitivity to light. Higher ISO indicates greater sensitivity. ISO 3200 is available only in 1.2, 2.1, 2.2, and 3.1 MP picture size (see [page 27](#)).

NOTE: A higher ISO may produce unwanted "noise" in a picture.





Exposure Compensation—adjust the exposure; good for controlling backlit or non-standard scenes. If the picture is too light, decrease the setting; if it's too dark, increase the setting.

Shutter speed—control how long the shutter stays open.



Aperture—(also known as f-stop) control the size of the lens opening, which determines the depth of field.

- Smaller f-stop numbers indicate a larger lens opening; good for portraits and low-light conditions.
- Larger f-stop numbers indicate a smaller lens opening; keeps the main subject sharp; good for landscapes and well-lit conditions.

Focus mode—select a large or concentrated area of focus.

Focus mode	Description
 Normal AF (default)	Focus setting for general picture-taking.
 Macro	Sharpness and detail in pictures at close range. Use available light instead of flash, if possible. The camera automatically sets the focus distance depending on the zoom position. The close-up distances are: Wide angle: 7.9–27.6 in. (0.2–0.7 m) Telephoto: 19.7–39.4 in. (0.5–1.0 m)
 Infinity	Distant subjects. Auto-focus framing marks are unavailable.
 Manual	Focus is at center position. When MF icon appears, press OK to display focus indicator. Press ▲/▼ to adjust the setting. A magnified image appears on the screen when adjusting focus position.

Using burst

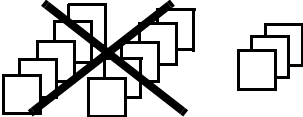
Mode	Icon	Description	Purpose
First Burst		Camera takes up to 3 pictures while the Shutter button is pressed. 	Capture an expected event. Example: A person swinging a golf club.
Last Burst		Camera takes up to 30 pictures while the Shutter button is pressed. When the Shutter button is released, only the last 3 pictures are saved. 	Capture an event when the precise timing is uncertain. Example: A child blowing out birthday candles.

1 In most Still modes, press the Self-timer/Burst button .

NOTE: Burst is unavailable in Portrait, Night Portrait, Night Landscape, Backlight, Fireworks, and Panorama modes.

2 Press the Shutter button **halfway** to focus and set exposure.

3 Press the Shutter button **completely down and hold it** to take pictures.

The camera stops taking pictures when you release the Shutter button, when the pictures are taken, or when there is no more storage space.

NOTE: During quickview, you can delete all pictures in the burst series. To delete selectively, do so in Review (see [page 15](#)).

Using exposure compensation to adjust picture brightness

In P/M and Panorama modes, you can adjust exposure compensation before you take a picture to make your pictures darker or lighter. Only the first picture in Panorama mode can be adjusted—that adjustment is applied to the remaining pictures.

- 1 Press ▼ to decrease exposure compensation.
- 2 Press ▲ to increase exposure compensation.

An exposure compensation level between -2.0 and +2.0 is shown on the LCD as the LCD image gets darker or lighter.

- 3 Take the picture when you are satisfied with the exposure compensation level.

Using exposure compensation with exposure bracketing

In P/M modes, you can use exposure compensation (see [page 37](#)) in conjunction with exposure bracketing to get the best exposure.

If the exposure compensation is set to:	And if the exposure bracketing interval is set to 0.3 steps:	Then the exposures taken are:
0.0	Set the Exposure bracketing in the Setup menu (see page 29).	-0.3, 0.0, +0.3
+1.0		+0.7, +1.0, +1.3
-1.0		-1.3, -1.0, -0.7

Using the histogram to view picture brightness

Use the histogram to evaluate the distribution of light before or after you take a picture. If the peak is to the right of the graph, the subject is bright; if it's to the left, the subject is dark. Optimal exposure is achieved when the peak is in the middle of the histogram.

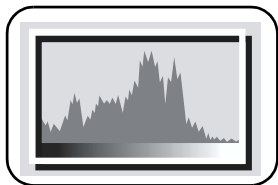

To turn on the histogram in P/M mode or in Review, press the Info  button until the histogram appears.











NOTE: If a scene is dark or light, you can adjust the exposure compensation (see [page 37](#)) before taking the picture. The flash may affect a picture's light and shadow.

Sharing your pictures

Press the Share button to tag your pictures and videos. When they are transferred to your computer, you can share them. Use the Share button:

- Any time. (The most recent picture/video taken is then displayed.)
- After pressing the Review button.

Tagging pictures for printing

- 1 Press the Share button. Press   to locate a picture.
- 2 Press   to highlight Print , then press the OK button.*
- 3 Press   to select the number of copies (0-99). Zero removes the tag for that picture.
Optional: You can apply a print quantity to other pictures with the print quantity screen displayed. Press   to locate a picture. Press   to change the print quantity. Repeat until the desired print quantity is applied to pictures.
- 4 Press the OK button.

The Print icon  appears in the status area.

5 Press the Share button to exit the menu.

* To tag all pictures in the storage location, highlight Print All, press the OK button, then indicate the number of copies. To remove print tagging for all pictures in the storage location, highlight Cancel Prints, then press the OK button.

Printing tagged pictures

When you transfer the tagged pictures to your computer, the Kodak EasyShare software print screen opens. For details, click the Help button in EasyShare software.

For more information on printing from your computer, printer dock, PictBridge enabled printer, or card, see [page 46](#).

NOTE: For the best 4 x 6 in. (10 x 15 cm) prints, set the camera to a 3:2 picture size. (See [page 27](#).)

Tagging pictures/videos for emailing

First—on your computer

Use Kodak EasyShare software to create an email address book on your computer. Then copy up to 32 email addresses to the camera's internal memory. For details, click the Help button in EasyShare software.

Second—tag pictures/videos on your camera

- 1 Press the Share button. Press ◀/▶ to locate a picture/video.
- 2 Press ▲/▼ to highlight Email , then press the OK button.
- 3 Press ▲/▼ to highlight an email address, then press the OK button.
- 4 To tag other pictures/videos with the same address, press ◀/▶ to scroll through them. When the picture you want is displayed, press OK.
- 5 To send the pictures/videos to more than one address, repeat step 3 for each address.
Selected addresses are checked.
- 6 To remove a selection, highlight a checked address and press the OK button. To remove all email selections, highlight Clear All.

7 Press / to highlight Exit, then press the OK button.

8 Press the Share button to exit the menu.

Third—transfer and email

When you transfer the tagged pictures/videos to your computer, the Email screen opens and lets you send them to the addresses you specified. For details, click the Help button in Kodak EasyShare software.

Tagging pictures as favorites

Want to keep copies of your favorite pictures on your camera?

Start with the Share button!

1. Tag pictures as favorites	1 Press the Share button. Press / to find a picture. 2 Press / to highlight Favorite, then press the OK button. <i>The Favorite icon appears in the status area. To remove the tag, press the OK button again.</i> NOTE: Sound tags (see page 17) are retained with tagged pictures and can be deleted only in Review mode.
2. View favorites on your camera	1 Turn the Mode dial to Favorites . 2 Press / to view favorites.

The next time you transfer pictures to your computer, EasyShare software helps you make choices about your favorite pictures. Favorite pictures (smaller versions of the originals) are loaded to the Favorites section of your camera's internal memory.

NOTE: Videos tagged as favorites remain in the Favorites folder in EasyShare software. For details, see Help in EasyShare software.

Preventing favorites from transferring to the camera

- 1 Open Kodak EasyShare software. Click the My Collection tab.
- 2 Go to the Albums view.
- 3 Click the Camera Favorites Album for your camera.
- 4 Click Remove Album.

The next time you transfer pictures from your camera to the computer, use the Camera Favorites Wizard/Assistant to either recreate your Camera Favorites Album or to turn off the Camera Favorites feature.

Optional settings

In Favorites mode, press the Menu button to access optional settings:

- Slide Show ([see page 21](#))
- Multi-up ([see page 24](#))
- Setup Menu ([see page 31](#))

Printing and emailing favorites

- 1 Turn the Mode dial to Favorites . Press ◀/▶ to find a picture.
- 2 Press the Share button.
- 3 Highlight Print or Email, then press the OK button.

NOTE: Favorites that were taken on this camera (not imported from another source) are good for prints up to 4 x 6 in. (10 x 15 cm). Use the Add Email option to create email addresses.





Tagging pictures/videos for albums



Use the Album feature to tag the pictures/videos in your camera with album names.

First—on your computer

Use EasyShare software to create album names on your computer, then copy up to 32 album names to the camera's internal memory.

Second—on your camera

- 1 Press the Review button, then find the picture/video.
- 2 Press the Menu button.
- 3 Press / to highlight Album, then press the OK button.
- 4 Press / to highlight an album name, then press the OK button.

To add other pictures to the same album, press / to scroll through the pictures. When the picture you want is displayed, press the OK button.

To add the pictures to more than one album, repeat step 4 for each album.

- 5 Press / to highlight Exit, then press the OK button.

The album name appears with the picture. A plus (+) after the album name means the picture was added to more than one album.

To remove a selection, highlight an album name and press the OK button. To remove all album selections, select Clear All.

Third—transfer to your computer

When you transfer the tagged pictures/videos to your computer, EasyShare software opens and categorizes your pictures/videos in the appropriate album. For details, click the Help button in EasyShare software.

Pre-tagging for album names

Use the Set Album (Still or Video) feature to pre-select album names before you take pictures/videos. Then, all the pictures/videos you take are tagged with those album names. Use the Add Album option to create album names.

First—on your computer

Use the EasyShare software to create album names on your computer. The next time you connect the camera to the computer, up to 32 album names are copied to the camera's internal memory.

Second—on your camera

- 1 In any mode, press the Menu button.
- 2 Press ▲/▼ to highlight Set Album, then press the OK button.
- 3 Press ▲/▼ to highlight an album name, then press the OK button.
- 4 Highlight Exit, then press the OK button.
- 5 Press the Menu button to exit the menu.

Your selections are saved. Your album selection is displayed on the LCD. A plus (+) after the album name means more than one album is selected.

Third—transfer to your computer

When you transfer the tagged pictures/videos to your computer, EasyShare software opens and categorizes your pictures/videos in the appropriate album. For details, see Help in EasyShare software.

5

Transferring and printing pictures

Installing the software



CAUTION:

Install EasyShare software *before* connecting the camera to the computer. Failure to do so may cause the software to load incorrectly.

- 1 Close all software applications that are open on your computer (including anti-virus software).
- 2 Place the EasyShare software CD into the CD-ROM drive.
- 3 Load the software:

Windows OS—if the install window does not appear, choose Run from the Start menu and type **d:\setup.exe** where **d** is the drive letter that contains the CD.

Mac OS X—double-click the CD icon on the desktop, then click the Install icon.

- 4 Follow the on-screen instructions to install the software.

NOTE: When prompted, take few minutes to electronically register your camera and software. To register later, see www.kodak.com/go/register.

- 5 If prompted, restart the computer. If you turned off anti-virus software, turn it back on. See the anti-virus software manual for details.

For information on the software applications included on the EasyShare software CD, click the Help button in EasyShare software.

Transferring pictures with the USB cable

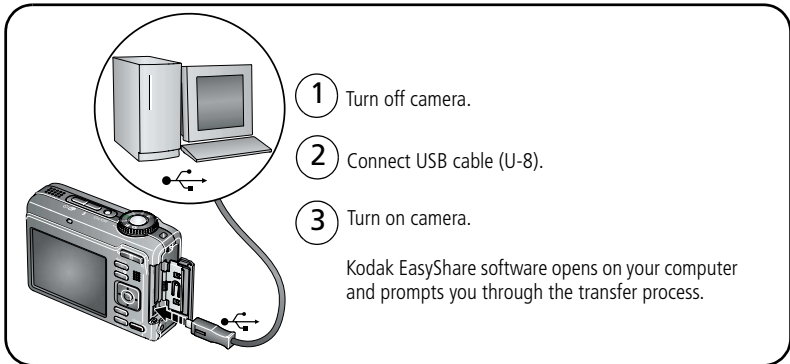

NOTE: Visit www.kodak.com/go/howto for an online tutorial on connecting.

Also available for transferring

You can also use these Kodak products to transfer your pictures and videos.

- Kodak EasyShare camera dock, Kodak EasyShare printer dock (see [page 46](#))
- Kodak card reader

Purchase these and other accessories at a dealer of Kodak products or www.kodak.com/go/z1275accessories, www.kodak.com/go/z1285accessories.

Printing pictures

Printing with a Kodak EasyShare printer dock

Dock your camera to the Kodak EasyShare printer dock and print directly—with or without a computer. Purchase this and other accessories at a dealer of Kodak products or visit www.kodak.com/go/z1275accessories, www.kodak.com/go/z1285accessories.

Direct printing with a PictBridge enabled printer

Your camera is compatible with PictBridge technology, so you can print directly to PictBridge enabled printers. You need:

- Camera with fully charged batteries
- PictBridge enabled printer
- USB cable (may be sold separately)

Connecting the camera to a PictBridge enabled printer

- 1 Turn off the camera and printer.
- 2 Connect the appropriate USB cable from the camera to the printer. (See your printer user guide or visit www.kodak.com/go/z1275accessories, www.kodak.com/go/z1285accessories.)

Printing from a PictBridge enabled printer

- 1 Turn on the printer. Turn on the camera.

The PictBridge logo is displayed, followed by the current picture and menu. (If no pictures are found, a message is displayed.) If the menu interface turns off, press any button to redisplay it.

- 2 Press ▲/▼ to choose a printing option, then press the OK button.

Current Picture—Press ◀/▶ to choose a picture. Choose the number of copies.

Tagged Pictures—If your printer is capable, print pictures that you tagged for printing and choose a print size.

Index Print—Print thumbnails of all pictures. This option requires one or more sheets of paper. If the printer is capable, choose a print size.

All Pictures—Print all pictures in internal memory, on a card, or in Favorites. Choose the number of copies.

Image Storage—Access internal memory, a card, or Favorites.

NOTE: During direct printing, pictures are not permanently transferred or saved to the computer or printer.

Disconnecting the camera from a PictBridge enabled printer

- 1 Turn off the camera and printer.
- 2 Disconnect the USB cable from the camera and the printer.

Using a printer that is not PictBridge enabled

For details on printing pictures from your computer, click the Help button in EasyShare software.

Ordering prints online

Kodak Gallery (www.kodakgallery.com) is one of the many online print services offered in the Kodak EasyShare software. You can easily:

- Upload your pictures.
- Edit, enhance, and add borders to your pictures.
- Store pictures, and share them with family and friends.
- Order high-quality prints, photo greeting cards, frames, and albums—and have them delivered to your door.

Printing from an optional SD/SDHC or MMC card

- Automatically print tagged pictures when you insert your card into a printer with an SD/SDHC or MMC card slot. See your printer user's guide for details.
- Make prints at an SD/SDHC or MMC card-capable Kodak picture maker/picture kiosk. (Contact a location prior to visiting. See www.kodak.com/go/picturemaker.)
- Take the card to your local photo retailer for professional printing.

Dock compatibility for your camera

To see which EasyShare printer docks are compatible with your camera, visit www.kodak.com/go/dockcompatibility.

Purchase camera docks, printer docks, and other accessories at a dealer of Kodak products or www.kodak.com/go/z1275accessories, www.kodak.com/go/z1285accessories.

6

Troubleshooting

For step-by-step product support, visit www.kodak.com/go/z1275support, www.kodak.com/go/z1285support and select Interactive Troubleshooting & Repairs.

Camera problems

If	Try one or more of the following
Camera does not turn on.	<ul style="list-style-type: none"> ■ Install new batteries (see page 1). ■ Charge rechargeable batteries.
Camera does not turn off.	<ul style="list-style-type: none"> ■ Remove the battery, then reinsert or replace it. If the camera still does not function, visit www.kodak.com/go/z1275support, www.kodak.com/go/z1285support and select Interactive Troubleshooting & Repairs.
Pictures remaining number does not decrease after taking a picture.	<ul style="list-style-type: none"> ■ The camera is operating normally. Continue taking pictures.
Short battery life with Kodak Ni-MH rechargeable digital camera batteries.	<ul style="list-style-type: none"> ■ Wipe the contacts with a clean, dry cloth (see page 62) before loading batteries in the camera. ■ Limit activities that deplete battery power: reviewing pictures/videos and excessive use of the flash. ■ Use the Battery Refresh feature on your camera dock, printer dock, or battery charger (if equipped).
Stored pictures are corrupted.	<ul style="list-style-type: none"> ■ Retake pictures. Do not remove card while the Ready light is blinking. Keep rechargeable batteries charged. ■ Transfer the pictures to the computer (see page 45), then format the card or internal memory (see page 32). <p>Caution: Formatting a card deletes all pictures and videos, including protected files.</p>

If	Try one or more of the following
In Review mode, you do not see a picture (or the expected picture) on the LCD screen.	<ul style="list-style-type: none"> ■ Check the image storage location setting (see page 31).
In Review mode, a blue or black screen is displayed instead of a picture.	<ul style="list-style-type: none"> ■ Transfer the picture to the computer (see page 45), then format the card or internal memory (see page 32). <p>Caution: Formatting a card deletes all pictures and videos, including protected files.</p>
Shutter button does not work.	<ul style="list-style-type: none"> ■ Turn on the camera (see page 2). ■ Wait until the Ready light stops blinking red before attempting to take another picture. ■ Transfer pictures to the computer (see page 45), delete pictures from the camera (page 15), switch image storage locations (see page 31), or insert a card with available memory (page 3).
Slide show does not run on external video device.	<ul style="list-style-type: none"> ■ Adjust the camera Video Out setting (NTSC or PAL, see page 32). ■ See the external device's user's guide.
Picture is too light.	<ul style="list-style-type: none"> ■ Move so there is at least 2 ft (0.6 m) between the camera and the subject. ■ Decrease Exposure Compensation (see page 37).
Picture is not clear.	<ul style="list-style-type: none"> ■ Clean the lens (see page 62). ■ Make sure your camera is not in Close-up mode. ■ Move so there is at least 2 ft (0.6 m) between the camera and the subject. ■ Place the camera on a flat, steady surface or use a tripod.

If	Try one or more of the following
Picture is too dark.	<ul style="list-style-type: none"> ■ Turn on the flash (see page 9). ■ Move so there is no more than 11.8 ft (3.6 m) in wide angle and 6.9 ft (2.1 m) in telephoto between the camera and the subject. ■ Use Fill flash (see page 9) or change your position so light is not behind the subject. ■ Increase Exposure Compensation (see page 37).
Camera does not recognize SD/SDHC or MMC card.	<ul style="list-style-type: none"> ■ Purchase a certified SD/SDHC or MMC card. ■ Reformat the card (see page 32). <p>Caution: Formatting a card deletes all pictures and videos, including protected files.</p> <ul style="list-style-type: none"> ■ Insert a card into the slot, then push to seat (see page 3).
Camera freezes up when a card is inserted or removed.	<ul style="list-style-type: none"> ■ Turn the camera off, then back on. Make sure the camera is turned off before inserting or removing a card.
Memory card full.	<ul style="list-style-type: none"> ■ Insert a new card (see page 3), transfer pictures to the computer (see page 45), or delete pictures (see page 15).
Memory card and internal memory full.	<ul style="list-style-type: none"> ■ Transfer pictures to the computer (see page 45), then format the card or internal memory (see page 32). <p>Caution: Formatting a card deletes all pictures and videos, including protected files.</p>

Camera ready light status

If	Try one or more of the following
Ready light does not turn on and the camera does not work.	<ul style="list-style-type: none"> ■ Turn on the camera (see page 2). ■ Install new batteries (see page 1) or charge rechargeable batteries. ■ Turn camera off, then back on.
Ready light blinks green.	<ul style="list-style-type: none"> ■ Camera is operating normally.

If	Try one or more of the following
Ready light blinks amber.	<ul style="list-style-type: none"> ■ Wait. Resume picture taking when the light stops blinking and turns green.
Ready light blinks red and camera turns off.	<ul style="list-style-type: none"> ■ Install new batteries (see page 1) or charge rechargeable batteries.
Ready light glows steady red.	<ul style="list-style-type: none"> ■ Transfer pictures to the computer (see page 45), delete pictures from the camera (see page 15), switch image storage locations (see page 31), or insert a card with available memory (see page 3). ■ Wait. Resume picture taking when the light turns green. ■ Change the image storage location to internal memory (see page 31), or use a different card.
Ready light is off or glows steady green.	<ul style="list-style-type: none"> ■ Camera is operating normally.

Camera/computer communications

If	Try one or more of the following
The computer does not communicate with the camera.	<ul style="list-style-type: none"> ■ Turn on the camera (see page 2). ■ Install new batteries (see page 1) or charge rechargeable batteries. ■ Connect cable to camera and computer port (see page 45). ■ Install the software (see page 44). ■ Disconnect the USB cable. Close all open applications. Re-install the software (see page 44). ■ Disconnect camera from the computer. Close all software applications, reconnect camera.
Cannot transfer pictures. (The Add New Hardware Wizard cannot locate drivers.)	<ul style="list-style-type: none"> ■ Disconnect USB cable. (If using camera dock or printer dock, disconnect cable and remove camera from dock). Close all open applications. Re-install the software (see page 44). ■ Disconnect the USB cable. Close all open applications. Re-install the software (see page 44).

LCD messages

If	Try one or more of the following
No images to display	<ul style="list-style-type: none"> ■ Change image storage location setting (see page 31).
Memory card requires formatting	<ul style="list-style-type: none"> ■ Insert a new card (see page 3) or format the card (see page 32).
Memory card cannot be read (Please format memory card or insert another card)	<p>Caution: Formatting a card deletes all pictures and videos, including protected files.</p>
Only one USB connection allowed. Disconnect cable or rem. (remove) camera from dock.	<ul style="list-style-type: none"> ■ Unplug the USB cable from the camera.
Internal memory requires formatting	<ul style="list-style-type: none"> ■ Format the internal memory (see page 32).
Internal memory cannot be read (Please format internal memory)	<p>Caution: Formatting deletes all pictures and videos, including protected files. (Formatting internal memory also deletes email addresses, album names, and Favorites. To restore them, see the Kodak EasyShare software Help.)</p>
No memory card (Files not copied)	<ul style="list-style-type: none"> ■ Insert a card (see page 3).
Not enough space to copy files (Files not copied)	<ul style="list-style-type: none"> ■ Delete pictures from the image storage location you are copying to (see page 15), or insert a new card (see page 3).
Memory card is locked (Insert new memory card)	<ul style="list-style-type: none"> ■ Insert a new card (see page 3), move the switch on the card to unlock the card, or change the image storage location to internal memory (see page 31).
Read-only memory card. Remove write protection to capture or write to card.	

If	Try one or more of the following
Memory card is unusable (Insert new memory card)	<ul style="list-style-type: none"> ■ Insert a new card (see page 3) or format the card (see page 32). <p>Caution: Formatting a card deletes all pictures and videos, including protected files.</p>
No address book on camera (Connect with computer to import address book)	<ul style="list-style-type: none"> ■ Create and copy address book from computer. See the Kodak EasyShare software Help.
No album names on camera (Connect with computer to import album names)	<ul style="list-style-type: none"> ■ Create and copy album names from computer. See the Kodak EasyShare software Help.
High camera temperature. (Camera will be turned off.)	<ul style="list-style-type: none"> ■ Leave the camera off for ten minutes, then turn it back on. If the message reappears, visit www.kodak.com/go/z1275support, www.kodak.com/go/z1285support and select Interactive Troubleshooting & Repairs.
Can only mark image with 32 album names. Only the first 32 album names will be saved.	<ul style="list-style-type: none"> ■ Delete one or more album names associated with the image (see page 42).
Unrecognized file format	<ul style="list-style-type: none"> ■ Transfer the picture to the computer (see page 45), or delete it (page 15).
Camera error #XXXX. See user's guide.	<ul style="list-style-type: none"> ■ Turn camera off, then back on. If the message reappears, visit www.kodak.com/go/z1275support, www.kodak.com/go/z1285support and select Interactive Troubleshooting & Repairs.

7

Getting help

Helpful links

Camera

Email, write, or phone customer support	www.kodak.com/go/contact
Get support for your product (FAQs, troubleshooting information, arrange for repairs, etc.)	www.kodak.com/go/z1275support www.kodak.com/go/z1285support
Purchase camera accessories (camera docks, printer docks, lenses, cards, etc.)	www.kodak.com/go/z1275accessories www.kodak.com/go/z1285accessories
Download the latest camera firmware and software	www.kodak.com/go/z1275downloads www.kodak.com/go/z1285downloads
See online demonstrations of your camera	www.kodak.com/go/howto

Software

Get information on EasyShare software	www.kodak.com/go/easysharesw (or click the Help button in EasyShare software)
Get help with the Windows operating system and working with digital pictures	www.kodak.com/go/pcbasics

Other

Get support for other cameras, software, accessories	www.kodak.com/go/support
Get information on Kodak EasyShare printer docks	www.kodak.com/go/printerdocks
Get information on Kodak inkjet products	www.kodak.com/go/inkjet
Optimize your printer for truer, more vibrant colors	www.kodak.com/go/onetouch
Register your camera	www.kodak.com/go/register

NOTE: If you have questions concerning this product, you may speak with Kodak customer support.

Australia	1800 267 588
Austria	0179 567 357
Belgium	02 713 14 45
Brazil	0800 891 42 13
Canada	1 800 465 6325
China	800 820 6027
Czech Republic	00 800 56325000
Denmark	3 848 71 30
Ireland	01 407 3054
Finland	0800 1 17056
France	01 55 1740 77
Germany	069 5007 0035
Greece	00800 44140775
Hong Kong	800 901 514
Hungary	06 80 456 325
India	91 80 41374555 (toll free 000800 440 1227)
Italy	02 696 33452
Japan	03 5540 9002
Korea	080 708 5600

Netherlands	020 346 9372
New Zealand	0800 880 120
Norway	23 16 21 33
Philippines	1 800 1 888 9600
Poland	00800 4411625
Portugal	021 415 4125
Russia	8 495 929 9166
Singapore	800 6363 036
Slovakia	00 800 56325000
Spain	91 749 76 53
Sweden	08 587 704 21
Switzerland	01 838 53 51
Taiwan	0800 096 868
Thailand	001 800 631 0017
Turkey	00800 448827073
United Kingdom	0870 243 0270
United States	1 800 235 6325
International Toll Line	+44 131 458 6714
International Toll Fax	+44 131 458 6962

Camera specifications

For more specifications, visit www.kodak.com/go/z1275support,
www.kodak.com/go/z1285support

CCD—1/1.72 in. (4:3 aspect ratio)

Pixels—Total: 4088 x 3040 (12.43 MP)

Effective: 4011 x 3011 (12.08 MP), including ring pixels

ISO speed—Auto: 64–400

Selectable: 64, 100, 200, 400, 800, 1600 (ISO 3200 is available only in 1.2, 2.1, 2.2, and 3.1 MP picture size.)

Optics—5X optical zoom lens, 35 mm–175 mm (35 mm equivalent); f/2.8–f/5.1

Lens barrier—Automatic built-in

Digital zoom—5.0X continuous

Combined zoom—25X

Shutter speed—Mechanical shutter with CCD electronic; 1/2000–8 secs.

Color display—6.4 cm (2.5 in) color hybrid LCD; 115 K (480 x 240) pixels; 30 fps

External storage—Optional SD/SDHC or MMC Card . (The SD logo is a trademark of the SD Card Association.)

Internal storage—64 MB (58 MB available for image storage. 1 MB equals one million bytes.)

Image file format—Still: EXIF 2.21 (JPEG compression); file organization: DCF

Video: QuickTime, MPEG4; G.711 (audio)

Output image size—12.0 MP (4:3): 4000 x 3000 pixels

10.7 MP (3:2): 4000 x 2664 pixels

9.0 MP (16:9): 4000 x 2256 pixels

6.0 MP (4:3): 2832 x 2128 pixels

3.1 MP (4:3): 2048 x 1536 pixels

2.2 MP (3:2): 1800 x 1200 pixels

2.1 MP (16:9): 1920 x 1080 pixels

1.2 MP: 1280 x 960 pixels

Color modes—High Color, Natural Color, Low Color, Black & White, Sepia

Sharpness—High, Normal, Low

White balance—Auto, Daylight, Tungsten, Fluorescent, Open Shade

Focus system—TTL-AF (through-the-lens auto focus); Multi-zone AF, and Center-zone AF; Working range:

0.6 m (24 in.)—infinity @ wide normal

0.9 m (35.4 in.)—infinity @ telephoto normal

0.2–0.7 m (7.9–27.6 in.) @ wide macro

0.5–1.0 m (19.7–39.4 in.) @ telephoto macro

10 m (32.8 ft)—infinity @ wide Landscape

10 m (32.8 ft)—infinity @ telephoto Landscape

Exposure metering—TTL-AE; Multi-pattern; Center-weighted; Center spot

Exposure compensation—+/-2.0 EV with 1/3 EV steps

Exposure bracketing—3 images with selectable +/- 0.3, 0.7, and 1.0 EV steps

Capture modes—Smart Scene, P/M, High ISO, Digital Image Stabilization, SCN modes, Video

Self-timer—2 seconds, 10 seconds, or 2-shot

Video capture—HD720p (1280 x 720 @ 30 fps), VGA (640 x 480 @30 fps), QVGA (320 x 240 @30 fps)

Burst mode—Maximum 3 pictures @ 1.7 fps; Auto Exposure, Auto Focus, Auto White Balance executed for first shot only

Electronic flash—Auto flash; Guide no. 8.3 @ ISO 100; working range at ISO 400: 0.6–5.9 m (2–19.3 ft) @ Wide
0.6–3.2 m (2–10.5 ft) @ Tele

Flash modes—Auto, Fill, Red-eye, Off

Communication with computer—USB 2.0 high speed (PIMA 15740 protocol) via USB cable model U-8; USB 2.0 full speed (PIMA 15740 protocol) via EasyShare camera dock, printer dock, or HDTV dock

Video output—NTSC or PAL selectable

PictBridge compatibility—Yes

Power—2 Kodak oxy-alkaline digital camera batteries AA ZR6 (non-rechargeable); 2-AA lithium digital camera batteries; 2 Kodak Ni-MH rechargeable digital camera batteries AA; 1 Kodak lithium digital camera battery CRV3 (non-rechargeable); 1 Kodak Ni-MH rechargeable digital camera battery KAA2HR, 3V AC adapter; EasyShare camera dock, printer dock, or HDTV dock

Auto power off—Selectable 1, 3, 5, 10 minutes

Microphone—Yes

Speaker—Yes

Sound tag—Yes

Date stamp—None, YYYY/MM/DD, MM/DD/YYYY, DD/MM/YYYY

Tripod mount—1/4 inch

Size—9 x 6.5 x 3.2 cm (3.5 x 2.5 x 1.2 in.) @ power off

Weight—161 g (5.7 oz) without battery or card

Operating temperature—32-104°F (0-40°C)

Storage capacities

The LCD displays the number of pictures (or minutes/seconds of video) remaining. For average SD card capacities, visit www.kodak.com/go/SDcapacities. Actual storage capacity varies depending on subject composition, card size, and other factors. You may be able to store more or fewer pictures and videos. Favorites take up additional space in internal memory.

Upgrading your software and firmware

Download the latest versions of the software included on the Kodak EasyShare software CD and the camera firmware (the software that runs on the camera). See www.kodak.com/go/z1275downloads, www.kodak.com/go/z1285downloads.

Important safety instructions

CAUTION:

Do not disassemble this product; there are no user-serviceable parts inside. Refer servicing to qualified service personnel. Kodak AC adapters and battery chargers are intended for indoor use only. The use of controls, adjustments, or procedures other than those specified herein may result in exposure to shock and/or electrical or mechanical hazards. If the LCD breaks, do not touch the glass or liquid. Contact Kodak customer support.

- The use of an accessory that is not recommended by Kodak may cause fire, electric shock, or injury. For approved accessories, visit www.kodak.com/go/accessories.
- Use only a USB-certified computer equipped with a current-limiting motherboard. Contact your computer manufacturer if you have questions.
- If using this product in an airplane, observe all instructions of the airline.
- When removing the battery, allow it to cool; it may be hot.
- Read and follow all warnings and instructions supplied by the battery manufacturer.

- Use only batteries approved for this product to avoid risk of explosion.
- Keep batteries out of the reach of children.
- Do not allow batteries to touch metal objects, including coins. Otherwise, a battery may short circuit, discharge energy, become hot, or leak.
- Do not disassemble, install backward, or expose batteries to liquid, moisture, fire, or extreme temperature.
- Remove the battery when the product is stored for an extended period of time. In the unlikely event that battery fluid leaks inside the product, contact Kodak customer support.
- In the unlikely event that battery fluid leaks onto your skin, wash immediately with water and contact your local health provider. For additional health-related information, contact your local Kodak customer support.
- Dispose of batteries according to local and national regulations. Visit www.kodak.com/go/kes.
- Do not charge non-rechargeable batteries.

For more information on batteries, see www.kodak.com/go/batterytupes.

Battery life

CRV3 lithium battery: 480–580 pictures

AA (2) lithium batteries: 380–480 pictures

Ni-MH rechargeable digital camera battery (per charge): 270–370 pictures

AA (2) Ni-MH rechargeable batteries (per charge): 270–370 pictures

AA (2) Ni-Mn batteries: 120–170 pictures

Approximate number of pictures in Smart Scene mode. (CIPA testing method using 128 MB SD card.) Actual battery life may vary based on usage.

Extending battery life

- See Auto Power Off ([see page 32](#)).

- Limit activities that quickly deplete battery power (reviewing pictures on the camera, excessive use of the flash).
- Dirt on the battery contacts can affect battery life. Wipe the contacts with a clean, dry cloth before loading batteries in the camera.
- Battery performance is reduced at temperatures below 41° F (5° C). When using your camera in cold weather, carry spare batteries and keep them warm. Do not discard cold batteries that do not work; when they return to room temperature, they may be usable.

Care and maintenance

- If you suspect water has gotten inside the camera, remove the battery and card. Allow all components to air-dry for at least 24 hours before using the camera.
- Blow gently on the lens or LCD to remove dust and dirt. Wipe gently with a soft, lint-free cloth or an untreated lens-cleaning tissue. Do not use cleaning solutions unless designed specifically for camera lenses. Do not allow chemicals, such as suntan lotion, to contact painted surfaces.
- Service agreements may be available in your country. Contact a dealer of Kodak products for more information.
- For digital camera disposal or recycling information, contact your local authorities. In the US, visit the Electronics Industry Alliance Web site at www.eiae.org or the Kodak Web site at www.kodak.com/go/z1275support, www.kodak.com/go/z1285support.

Limited Warranty

Kodak warrants Kodak consumer electronic products and accessories ("Products"), excluding batteries, to be free from malfunctions and defects in both materials and workmanship for one year from the date of purchase. Retain the original dated sales receipt. Proof of the date of purchase will be required with any request for warranty repair.

Limited warranty coverage

Warranty service is only available from within the country where the Products were originally purchased. You may be required to ship Products, at your expense, to the authorized service facility for the country where the Products were purchased.

Kodak will repair or replace Products if they fail to function properly during the warranty period, subject to any conditions and/or limitations stated herein. Warranty service will include all labor as well as any necessary adjustments and/or replacement parts. If Kodak is unable to repair or replace a Product, Kodak will, at its option, refund the purchase price paid for the Product provided the Product has been returned to Kodak along with proof of the purchase price paid. Repair, replacement, or refund of the purchase price are the sole remedies under the warranty.

If replacement parts are used in making repairs, those parts may be remanufactured, or may contain remanufactured materials. If it is necessary to replace the entire Product, it may be replaced with a remanufactured Product. Remanufactured Products, parts and materials are warranted for the remaining warranty term of the original Product, or 90 days after the date of repair or replacement, whichever is longer.

Limitations

This warranty does not cover circumstances beyond Kodak's control. This warranty does not apply when failure is due to shipping damage, accident, alteration, modification, unauthorized service, misuse, abuse, use with incompatible accessories or attachments (such as third party ink or ink tanks), failure to follow Kodak's operation, maintenance or repacking instructions, failure to use items supplied by Kodak (such as adapters and cables), or claims made after the duration of this warranty.

Kodak makes no other express or implied warranty for this product, and disclaims the implied warranties of merchantability and fitness for a particular purpose. In the event that the exclusion of any implied warranty is ineffective under the law, the duration of the implied warranty will be one year from the purchase date or such longer period as required by law.

The option of repair, replacement, or refund is Kodak's only obligation. Kodak will not be responsible for any special, consequential or incidental damages resulting from the sale, purchase, or use of this product regardless of the cause. Liability for any special, consequential or incidental damages (including but not limited to loss of revenue or profit, downtime costs, loss of the use of the equipment, cost of substitute equipment, facilities or services, or claims of your customers for such damages resulting from the purchase, use, or failure of the Product), regardless of cause or for breach of any written or implied warranty is expressly disclaimed.

Your rights

Some states or jurisdictions do not allow exclusion or limitation of incidental or consequential damages, so the above limitation or exclusion may not apply to you. Some states or jurisdictions do not allow limitations on how long an implied warranty lasts, so the above limitation may not apply to you.

This warranty gives you specific rights, and you may have other rights which vary from state to state or by jurisdiction.

Outside the United States and Canada

In countries other than the United States and Canada, the terms and conditions of this warranty may be different. Unless a specific Kodak warranty is communicated to the purchaser in writing by a Kodak company, no warranty or liability exists beyond any minimum requirements imposed by law, even though defect, damage, or loss may be by negligence or other act.

Regulatory compliance

FCC compliance and advisory



Kodak EasyShare Z1275/Z1285 digital camera

This equipment has been tested and found to comply with the limits for a Class B digital device, pursuant to Part 15 of the FCC Rules. These limits are designed to provide reasonable protection against harmful interference in a residential installation.

This equipment generates, uses, and can radiate radio frequency energy and, if not installed or used in accordance with the instructions, may cause harmful interference to radio communications. However, there is no guarantee that interference will not occur in a particular installation.

If this equipment does cause harmful interference to radio or television reception, which can be determined by turning the equipment off and on, the user is encouraged to try to correct the interference by one or more of the following measures: 1) reorient or relocate the receiving antenna; 2) increase the separation between the equipment and the receiver; 3) connect the equipment to an outlet on a circuit different from that to which the receiver is connected; 4) consult the dealer or an experienced radio/TV technician for additional suggestions.

Any changes or modifications not expressly approved by the party responsible for compliance could void the user's authority to operate the equipment. Where shielded interface cables have been provided with the product or specified additional components or accessories elsewhere defined to be used with the installation of the product, they must be used in order to ensure compliance with FCC regulation.

Australian C-Tick



Canadian DOC statement

DOC Class B Compliance—This Class B digital apparatus complies with Canadian ICES-003.

Observation des normes-Classe B—Cet appareil numérique de la classe B est conforme à la norme NMB-003 du Canada.

FCC and Industry Canada

This device complies with Industry Canada RSS-210 and FCC Rules. Operation is subject to the following two conditions: (1) this device may not cause harmful interference, and (2) this device must accept any interference received, including interference that may cause undesired operation.

FCC et Industrie Canada

Cet appareil est conforme à la norme RSS-210 d'Industrie Canada et aux réglementations de la FCC. Son utilisation est soumise aux deux conditions suivantes : (1) cet appareil ne doit pas provoquer d'interférences nuisibles, et (2) cet appareil doit supporter les interférences reçues, y compris celles susceptibles de nuire à son bon fonctionnement.

Waste Electrical and Electronic Equipment labeling



In the European Union, do not discard this product as unsorted municipal waste. Contact your local authorities or go to www.kodak.com/go/recycle for recycling program information.

Korean Class B ITE

이 기기는 가정용으로 전자파적합등록을 한 기기로서 주거지역에서는 물론 모든 지역에서 사용할 수 있습니다.
--

VCCI Class B ITE

この装置は、情報処理装置等電波障害自主規制協議会（VCCI）の基準に基づいたクラスB情報技術装置です。この装置は、家庭環境で使用することを目的としていますが、この装置がラジオやテレビジョン受信機に近接して使用されると、受信障害を引き起こすことがあります。
取扱説明書に従って正しい取り扱いをして下さい。

China RoHS

环保使用期限 (EPUP)

在中国大陆, 该值表示产品中存在的任何危险物质不得释放, 以免危及人身健康、财产或环境的时间期限(以年计)。该值根据操作说明中所规定的产品正常使用而定。

有毒有害物质或元素名称及含量标识表

部件名称	有毒有害物质或元素					
	铅	汞	镉	六价铬	多溴联苯	多溴二苯醚
数码相机电路板元件	×	○	○	○	○	○

○：表示该有毒有害物质在该部件所有均质材料中的含量均在SJ/T 11363-2006规定的限量要求以下。
×：表示该有毒有害物质至少在该部件的某一均质材料中的含量超出SJ/T 11363-2006规定的限量要求。



USB 数据线

Russian GOST-R



Eastman Kodak Company
Rochester, NY 14650

Фотокамера изготовлена в Китае; остальные элементы - в соответствии с маркировкой.

MPEG-4

Use of this product in any manner that complies with the MPEG-4 visual standard is prohibited, except for use by a consumer engaging in personal and non-commercial activities.

Index

A

- A/V out, 23
- about picture, video, 14
- about this camera, 32
- accessories, 45
 - battery, 61
 - buying, 55
 - printer dock, 46
 - SD/SDHC/MMC card, 3
- AF control, 28
- album
 - set, 31
 - tagging pictures for, 43
- appendix, 57
- auto
 - enhancement, 18
 - flash, 9
 - focus control, 16
 - focus framing marks, 5

B

- backlight, 7
- battery
 - extending life, 62
 - loading, 1
- battery compartment, ii
- battery life, 61
- beach, 7
- bookmarks, 20
- burst, using, 36
- button
 - burst, 36

- delete, ii, 5
- flash, 9
- LCD/Info, ii
- OK, ii
- review, 13
- shutter, i
- telephoto, ii
- wide angle, ii
- zoom, 8

C

- cable
 - audio/video, 23
 - USB, 45
- camera screen
 - error messages, 53
- camera sounds, 31
- candle light, 8
- capture frame grid, 31
- caring for your camera, 62
- children, 7
- clock, setting, 2
- close-up, 7
- color mode, 28
- compatibility, dock, 48
- copy pictures
 - card to memory, 25
 - memory to card, 25
 - to computer, 44
- cropping pictures, 18, 19
- customer support, 55, 56

D

date setting, 2
date stamp, 28
DC-in, ii
delete button, ii
deleting
 during quickview, 5
 pictures/video, 15
 protecting pictures, videos, 15
digital image stabilization, 6
digital zoom, using, 8
displaying slide show, 21
disposal, recycling, 62, 66
dock compatibility, 48
doing more with your camera, 27
download pictures, 44

E

EasyShare software, installing, 44
emailing pictures, videos, 39
error messages, 53
exposure
 bracketing interval, 29
 compensation, 33, 37
 metering, 29
external video device
 viewing pictures, videos, 23

F

favorites, 6
 settings, 41
 tagging, 40
fireworks, 7
firmware, upgrading, 60

flash
 settings, 9
flower, 7
focus
 framing marks, 5
 zone, 29
focus mode
 infinity, 35
 macro, 35
 manual, 35
 normal AF, 35
format, 32
framing grid, 32

G

grid, framing, 32
guidelines, battery, 61

H

HDTV dock, 21, 23
help, 49
 camera, 49
 web links, 55
high ISO, 6
histogram, 38

I

icons, mode dial, 6
image stabilization, 6
Image stabilizer, 16
image storage, 31
information
 about pictures, videos, 14
installing
 batteries, 1

SD/SDHC/MMC card, 3
software, 44
internal memory
storage capacity, 60

K

Kodak EasyShare software
upgrading, 60
Kodak Perfect Touch technology, 18
Kodak web sites, 55

L

landscape, 7
LCD, ii
brightness, 31
reviewing pictures, 13
reviewing videos, 13
LCD/Info button, ii
lens
cleaning lens, 62
light
ready, 51
loading
batteries, 1
SD/SDHC/MMC card, 3
software, 44

M

Macintosh computers, installing
software on, 44
magnify picture, 13
maintenance, camera, 62
manner/museum, 7
manual mode, 33
memory

inserting card, 3
storage capacities, 60
mode dial, 6
modes, capture
digital image stabilization, 6
high ISO, 6
P/M, 6
SCN, 6
smart scene, 6
video, 6
multiple selections, 25
multi-up, 24

N

night landscape, 7
night portrait, 7

O

OK button, ii
online prints, ordering, 48
optical zoom, 8
orientation sensor, 31

P

P/M mode, 33
panning shot, 8
panoramic pictures, 11
Perfect Touch technology, 18
PictBridge enabled printer, 46
picture size, 27
pictures
checking settings, 26
copying, 25
cropping, 18, 19
deleting, 15

- emailing tagged, 39
- Kodak Perfect Touch, 18
- magnifying, 13
- printing, 47
- protecting, 15
- reviewing, 13
- storage capacity, 60
- tagging, 43
- taking, modes, 6
- transfer, 44
- picture-taking settings, 27
- portrait, 7
- power
 - camera, 2
- printer dock, 46
- printing
 - from a card, 48
 - from computer, 47
 - optimizing printer, 55
 - order online, 48
 - PictBridge technology, 46
 - tagged pictures, 48
 - with EasyShare printer dock, 46
- problem-solving, 49
- program and manual, 6
- program mode, 33
- protecting pictures, videos, 15

Q

- quickview, using, 5

R

- ready light, 4, 51
- recycling, disposal, 62, 66

- red-eye, flash, 9
- regulatory information, 65
- repair, 55
- review button, 13
- reviewing pictures/videos
 - as you take them, 5
 - deleting, 15
 - LCD, 13
 - protecting, 15
 - slide show, 21
- running slide show, 21

S

- scene modes, 6
 - backlight, 7
 - beach, 7
 - candle light, 8
 - children, 7
 - close-up, 7
 - fireworks, 7
 - flower, 7
 - landscape, 7
 - manner/museum, 7
 - night landscape, 7
 - night portrait, 7
 - panning shot, 8
 - panorama, 11
 - portrait, 7
 - self-portrait, 7
 - snow, 7
 - sport, 7
 - sunset, 8
 - text, 7
- SCN, 6

- SD/SDHC/MMC card
 - inserting, 3
 - printing from, 48
 - storage capacities, 60
 - select multiple pictures/videos, 25
 - self-portrait, 7
 - self-timer
 - with pictures, 10
 - service and support telephone numbers, 56
 - setting
 - about, 32
 - AF control, 28
 - album, 31
 - auto-focus, 16
 - camera sounds, 31
 - capture frame grid, 31
 - color mode, 28
 - date and time, 2
 - date stamp, 28
 - exposure bracketing, 29
 - exposure metering, 29
 - flash, 9
 - focus zone, 29
 - image storage, 31
 - LCD brightness, 31
 - orientation sensor, 31
 - picture size, 27
 - picture taking mode, 6
 - self-timer, 10
 - sharpness, 30
 - sound volume, 31
 - video out, 32
 - video size, 16, 28
 - white balance, 29
 - settings
 - picture taking, 27
 - sharing pictures, videos, 38
 - sharpness, 30
 - shutter
 - button, i
 - problems, 50
 - self-timer delay, 10
 - speed, 33
 - slide show
 - continuous loop, 22
 - problems, 50
 - running, 21
 - smart scene, 6
 - snow, 7
 - software
 - installing, 44
 - upgrading, 60
 - sound volume, 31
 - sounds, 31
 - specifications, camera, 57
 - sport, 7
 - status
 - camera ready light, 51
 - storage capacity, 60
 - strap, 1
 - strap post, ii
 - sunset, 8
 - support, technical, 55, 56
- T**
- tagging
 - favorites, 40

- for albums, 43
- for email, 39
- for print, 39
- telephone support, 56
- telephoto button, ii
- television, slide show, 23
- text, 7
- time, setting, 2
- timer, shutter delay, 10
- transferring pictures, videos, 44
- trash can, deleting, 5
- troubleshooting, 49
 - camera, 49
 - camera/computer communications, 52
 - error messages, 53
 - ready light status, 51
- turning camera on and off, 2

U

- undelete, 15
- undo, 15
- upgrading software, firmware, 60
- URLs, Kodak web sites, 55
- USB cable, 45
- USB, A/V out, ii

V

- VCCI compliance, 67
- video, 6
 - action print, 21
 - bookmarks, 20
 - checking settings, 26
 - copying, 25

- emailing tagged, 39
- out, 32
- protecting, 15
- reviewing, 13
- size, 16, 28
- storage capacities, 60
- transfer, 44
- viewing, 13
- viewing
 - by date, album, 24
 - by multi-up, 24
- viewing picture
 - after taking, 5, 13
- viewing picture, video information, 14
- volume, 31

W

- warranty, 62
- WEEE, 66
- white balance, 29
- wide angle button, ii
- Windows OS-based computers
 - installing software, 44

Z

- zoom
 - digital, 8
 - optical, 8

Free Manuals Download Website

<http://myh66.com>

<http://usermanuals.us>

<http://www.somanuals.com>

<http://www.4manuals.cc>

<http://www.manual-lib.com>

<http://www.404manual.com>

<http://www.luxmanual.com>

<http://aubethermostatmanual.com>

Golf course search by state

<http://golfingnear.com>

Email search by domain

<http://emailbydomain.com>

Auto manuals search

<http://auto.somanuals.com>

TV manuals search

<http://tv.somanuals.com>