

Dell Professional Projector S518WL

User's Guide



Notes, Cautions, and Warnings



NOTE: A NOTE indicates important information that helps you make better use of your projector



CAUTION: A CAUTION indicates potential damage to hardware or loss of data if instructions are not followed.



WARNING: A WARNING indicates a potential for property damage, personal injury, or death.

**Information in this document is subject to change without notice.
© 2017 Dell Inc. All rights reserved.**

Reproduction of these materials in any manner whatsoever without the written permission of Dell Inc. is strictly forbidden.

Trademarks used in this text: Dell and the DELL logo are trademarks of Dell Inc.; DLP and DLP logo are trademarks of TEXAS INSTRUMENTS INCORPORATED; Microsoft and Windows are either trademarks or registered trademarks of Microsoft Corporation in the United States and/or other countries.

Other trademarks and trade names may be used in this document to refer to either the entities claiming the marks and names or their products. Dell Inc. disclaims any proprietary interest in trademarks and trade names other than its own.

Model: Dell Professional Projector S518WL

October 2017 Rev. A01

Contents

1	About Your Dell Projector	4
	Projector Box Contents	4
	Projector Top and Bottom View	5
	Projector Connections	6
	Remote Control	9
2	Adjusting Projector Image	12
	Adjusting Projected Zoom	12
	Adjusting Projector Position	13
	Adjusting Image Corners	15
	Adjusting Image Size	16
3	Using Your Projector	18
	Using Network Display	18
	Connecting a Computer Using Optional Wireless Dongle	22
	Using PC-Free Presentation	40
4	Troubleshooting	55
	Troubleshooting Tips	55
	Guiding Signals	58
5	Maintenance	59
	Replacing the Remote Control Battery	59
6	Specifications	60
	Compatibility Mode (Digital / Analog)	63
7	Additional Information	65
8	Contacting Dell	66

1

About Your Dell Projector

Your projector comes with all the items shown below. Ensure that you have all the items, and contact Dell if anything is missing.

Projector Box Contents

Package Contents

Power cable

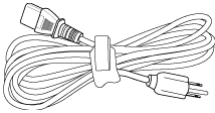

VGA cable (VGA to VGA)

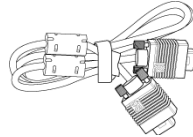

Remote control (CR2032 x 2pcs)

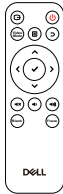

1.2 m USB cable (USB-A to USB-A)

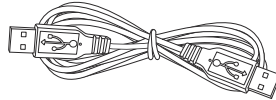

User's Guide and Documentation

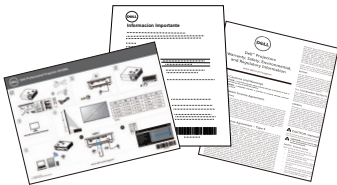

Projector Top and Bottom View

Top View

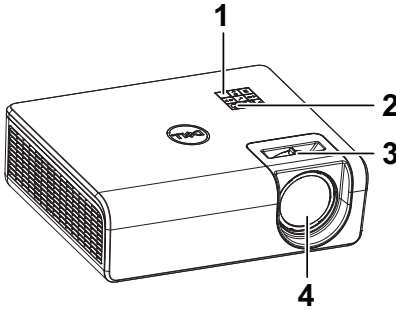

Bottom View

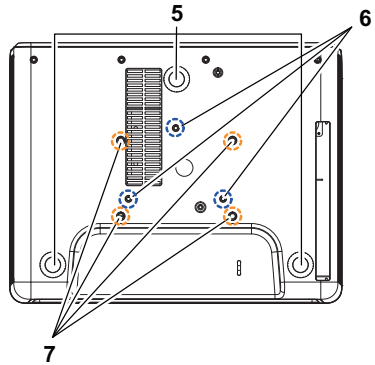

- | | |
|---|----------------------------------|
| 1 | IR receiver |
| 2 | Power button |
| 3 | Focus tab |
| 4 | Lens |
| 5 | Tilt adjustment wheel |
| 6 | Mounting holes for wall mount |
| 7 | Mounting holes for ceiling mount |



NOTE: Wall mount screw hole M4 x 8 mm depth.
Wall mount dimensions : 130mm X 88mm M4
Ceiling mount screw hole M3 x 8 mm depth.
Ceiling mount dimensions : 110mm X 82.3mm M3

Projector Connections

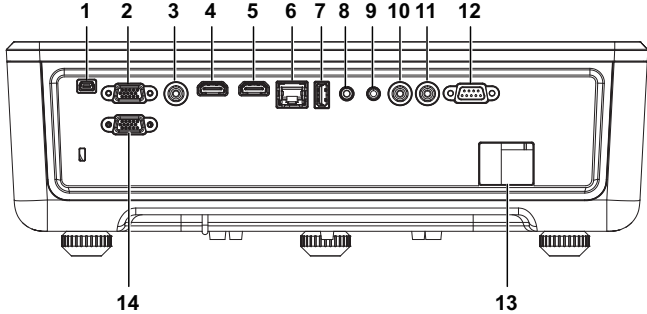

1	Mini USB (mini type B) connector for firmware upgrade	8	Audio input connector
2	VGA input	9	Audio output connector
3	Composite Video connector	10	Audio RCA (R) connector
4	HDMI-1 (1.4) connector	11	Audio RCA (L) connector
5	HDMI-2 (1.4) connector	12	RS232 connector
6	RJ45 connector	13	Power cord connector
7	USB Type A Power (+5V/ 1.8A) connector and also for media / wifi	14	VGA output

CAUTION: Before you begin any of the procedures in this section, follow the Safety Instructions as described on page 7.

CAUTION: Safety Instructions

- 1 Do not use the projector near appliances that generate a lot of heat.
- 2 Do not use the projector in areas where there is an excessive amount of dust. The dust may cause the system to fail and the projector will automatically shutdown.
- 3 Ensure that the projector is mounted in a well-ventilated area.
- 4 Do not block the ventilation slots and openings on the projector.
- 5 Ensure the projector operates between ambient temperatures 5°C to 40°C (41°F to 104°F).
- 6 Do not try to touch the ventilation outlet as it can become very hot after the projector has been turned on or immediately after it is turned off.
- 7 Do not look into the lens while the projector is on as it may cause injury to your eyes.
- 8 Do not place any objects near or in front of the projector or cover its lens while the projector is on as the heat may cause the object to melt or burn.
- 9 Do not use alcohol to wipe the lens.



NOTE:

- Do not attempt to ceiling mount the projector by yourself. It should be installed by a qualified technician.
- Recommended Projector Wall Mount Kit. For more information, see the Dell Support website at **dell.com/support**.
- For more information, see the Safety Information that shipped with your projector.
- The S518WL projector can only be used indoors.



WARNING: Laser Safety Notice

This product is classified as CLASS 1 LASER PRODUCT - RISK GROUP 1 according to IEC 60825-1 : 2014. Complies with FDA regulations 21 CFR 1040.10 and 1040.11 as a Risk Group 1 , LIP (Laser Illuminated Projector) as defined in IEC 62471:2006 except for deviations pursuant to Laser Notice No. 50, dated June 24, 2007.







Complies with 21 CFR 1040.10 and 1040.11 as a Risk Group 1, LIP (Laser Illuminated Projector) as defined in IEC 62471:2006 except for deviations pursuant to Laser Notice No. 50, dated June 24, 2007

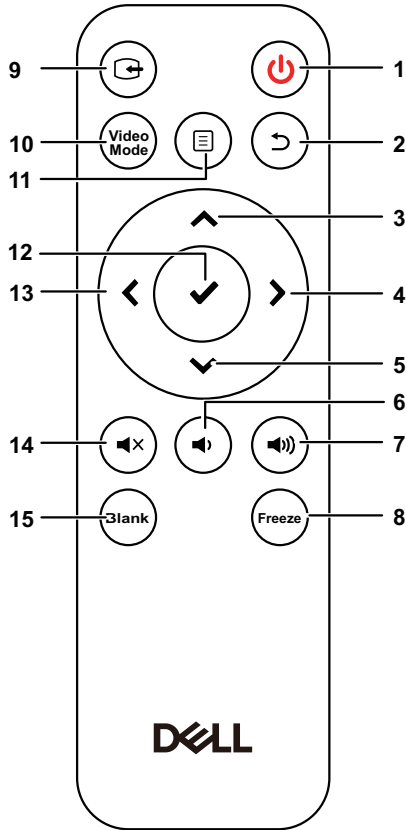





IEC 60825-1:2014 CLASS 1 LASER PRODUCT RISK GROUP 1	IEC 60825-1:2014 PRODUIT LASER DE CLASSE 1 GROUPE DE RISQUE 1	IEC 60825-1:2014 1类激光产品 危险组 1	IEC 60825-1:2014 1類激光產品 危險組1
---	---	-------------------------------------	------------------------------------

- Failure to comply with the following could result in death or serious injury.
- This projector has a built-in Class 4 laser module. Never attempt to disassemble or modify the projector.
- Any operation or adjustment not specifically instructed in the User manual creates the risk of hazardous laser radiation exposure.
- Do not open or disassemble the projector as this may cause damage or exposure to laser radiation.
- Do not stare into beam when the projector is on. The bright light may result in permanent eye damage.
- When turning on the projector, make sure no one within projection range is looking into the lens.
- Follow the control, adjustment, or operation procedures to avoid damage or injury from exposure of laser radiation.
- The instructions for the assembly, operation, and maintenance include clear warnings concerning precautions to avoid possible exposure to hazardous laser radiation.

Remote Control



1	Power 	Turns the projector on or off.
2	Back 	Returns to the previous screen.
3	Up 	Press to navigate through the On-Screen Display (OSD) Menu items.
4	Right 	Press to navigate through the On-Screen Display (OSD) Menu items.
5	Down 	Press to navigate through the On-Screen Display (OSD) Menu items.
6	Volume down 	Press to decrease the volume.

7	Volume up 	Press to increase the volume.
8	Freeze	Press to pause the screen image, then press "Freeze" again to resume normal projection.
9	Video in	Press to switch between sources: HDMI 1, HDMI 2, Wireless/LAN Display, and USB Viewer.
10	Video mode	<p>The projector has preset configurations that are optimized for displaying data (presentation slides) or video (movies, games, etc.).</p> <p>Press the Video Mode button to toggle between Presentation mode, Bright mode, Movie mode, sRGB, or Custom mode.</p> <p>Pressing the Video Mode button once will show the current display mode. Pressing the Video Mode button again will switch between modes.</p>
11	Menu 	Press to activate the OSD.
12	Enter 	Press to confirm the selection.
13	Left 	Press to navigate through the On-Screen Display (OSD) Menu items.
14	Mute 	Press to mute or un-mute the projector speaker.
15	Blank 	Press to toggle between white/blank/resume the image.

Remote Control Operating Range

Operating range	
Angle	$\pm 30^\circ$
Distance	7 m/22.97 feet

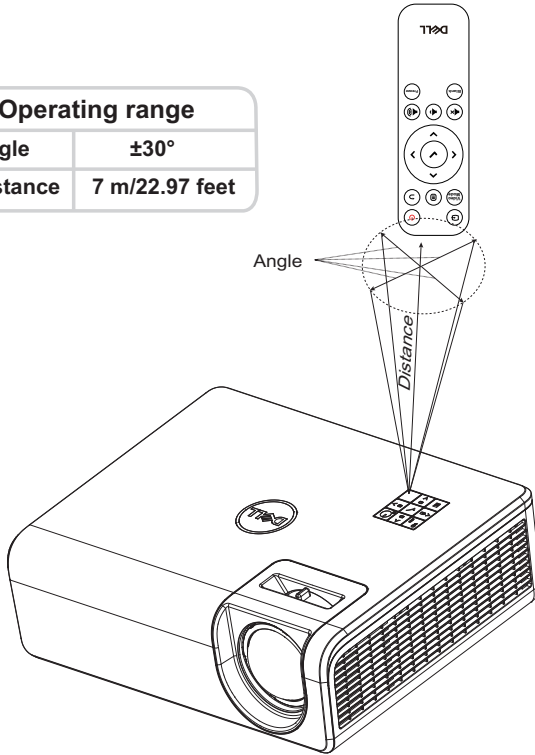

NOTE: Actual operating range may slightly differ from the diagram. Weak batteries will also prevent the remote control from properly operating the projector.

2

Adjusting Projector Image

Adjusting Projected Zoom

Raising the Projector Height

- 1 Raise the projector to the desired display angle, and use the rear tilt adjustment wheel to fine-tune the display angle.

Lowering the Projector Height

- 1 To lower the projected image, use the front tilt adjustment wheel to fine-tune the display angle.

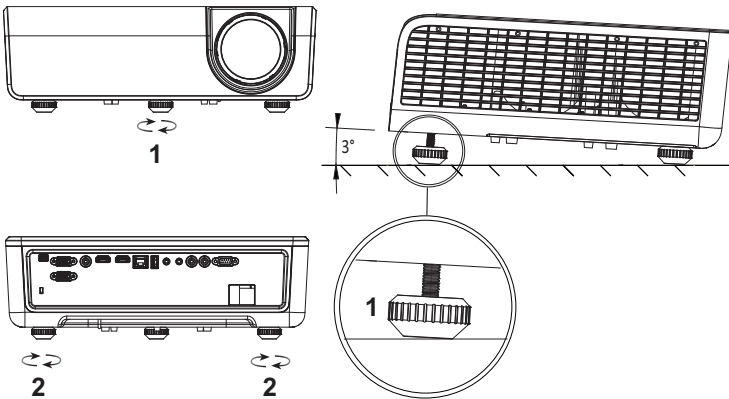

-
- | | |
|---|--|
| 1 | Front tilt adjustment wheel
(Angle of tilt: 0 to 3 degrees) |
| 2 | Rear tilt adjustment wheel |
-

Adjusting Projector Position

When you select a position for the projector, consider the size and shape of your screen, the location of your power outlets, and the distance between the projector and the rest of your equipment. Follow these general guidelines:

- When positioning the projector to the screen, it must be at least 31 inches (78.4 cm) from the projection screen.
- Position the projector to the required distance from the screen. The distance from the lens of the projector to the screen, the zoom setting, and the video format determine the size of the projected image.
- Lens throw ratio: 0.52

You can set up or install the S518WL in the following ways:

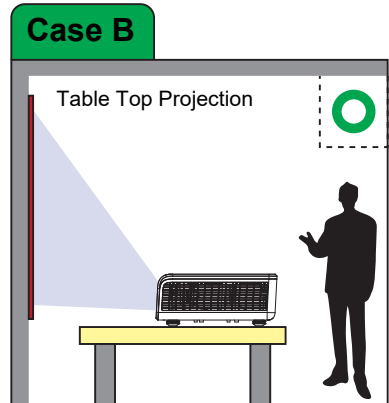
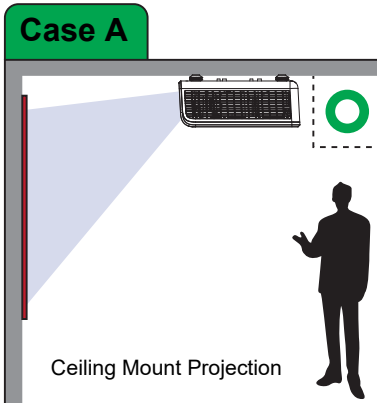

Case C

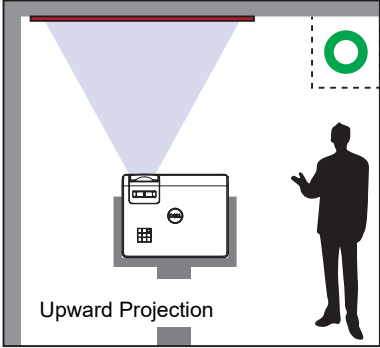

Case D

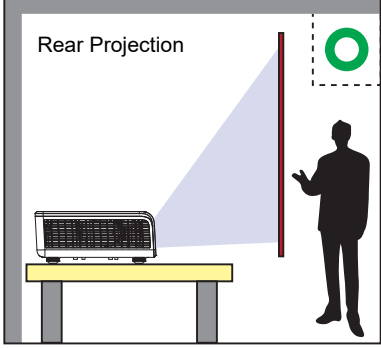

Do not install the S518WL projector in the following ways:

Case E

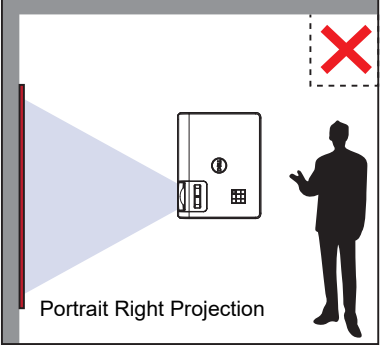

Case F

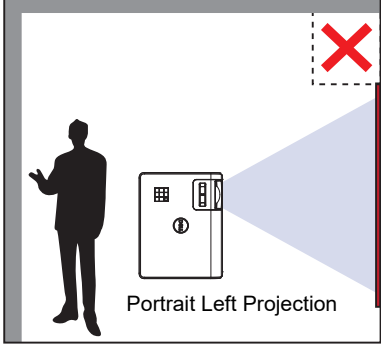

Adjusting Image Corners

Use Keystone adjustment feature to get perfect, rectangular projected images.

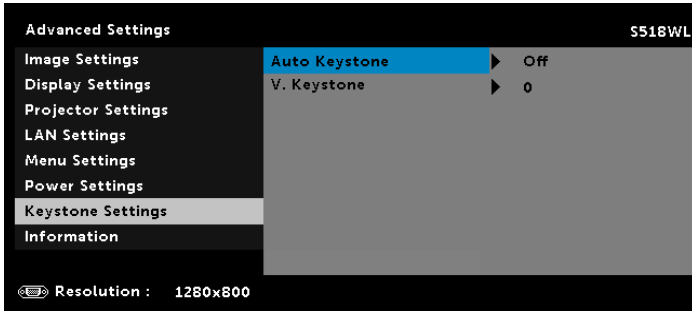

Adjusting Image Size

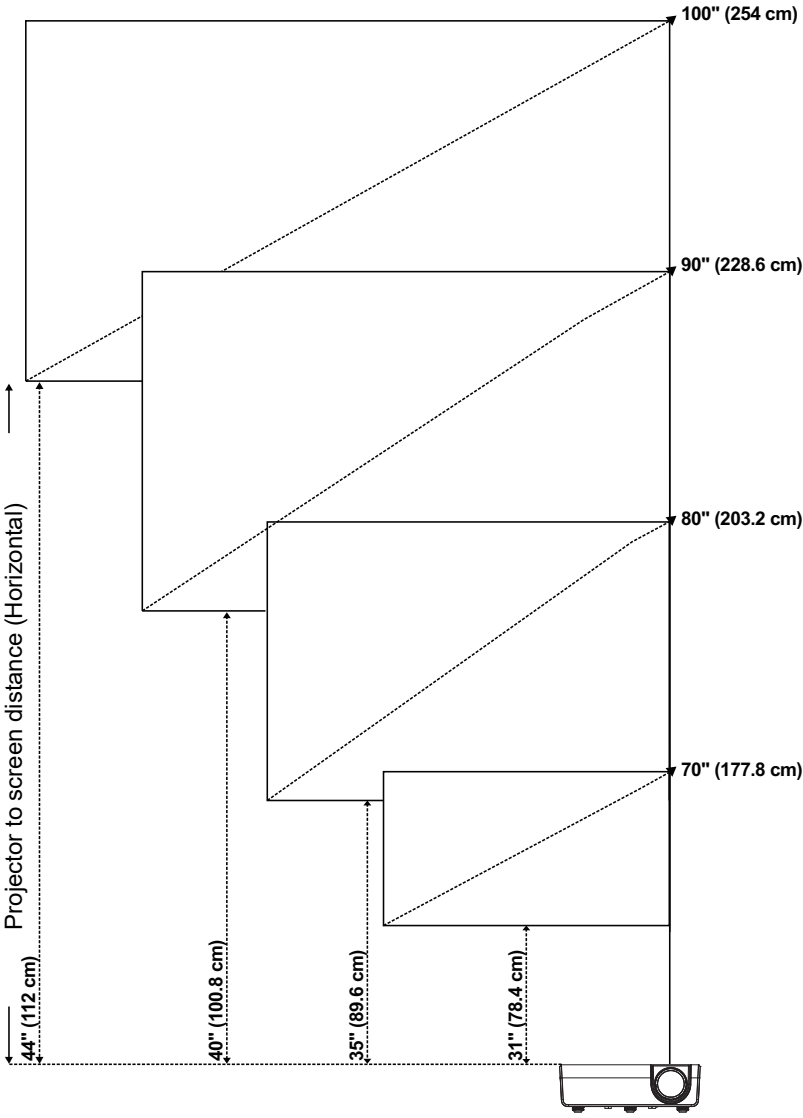

Adjusting Image Shape

Screen Size W*H						A (Projection Distance)	D (Offset)		
B Diagonal Length of image		W (Width)		H (Height)					
inch	cm	inch	cm	inch	cm	inch	cm	inch	cm
70	177.8	59	150.8	37	94.2	31	78.4	5.6	14.1
80	203.2	68	172.3	42	107.7	35	89.6	6.4	16.2
90	228.6	76	193.9	48	121.2	40	100.8	7.2	18.2
100	254.0	85	215.4	53	134.6	44	112.0	8.0	20.2

* This graph is for user reference only.

* Offset Ratio: 115 +/- 5%

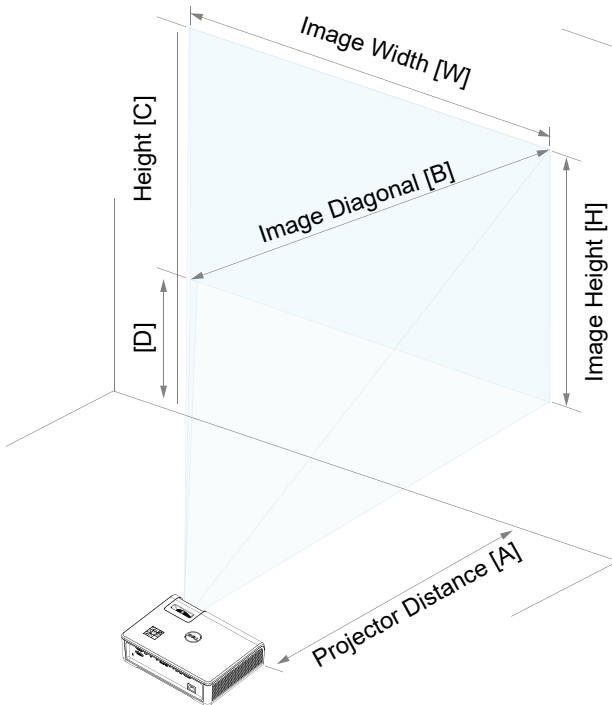

3

Using Your Projector

Using Network Display

Configure Your Projector for Network Display

Connect Projector to the Network

1 Connect the power cable and turn on the projector by pressing the power button.

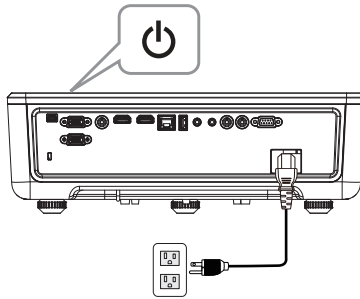

2 Press the **Menu** button on your projector control panel or remote control.

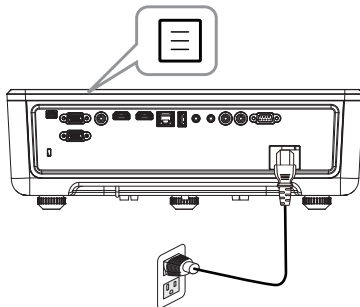

NOTE: Use **▲**, **▼**, **◀** and **▶** buttons to navigate and **✓** to select.

3 Ensure DHCP option is **Off** from LAN settings of Advanced Settings menu.

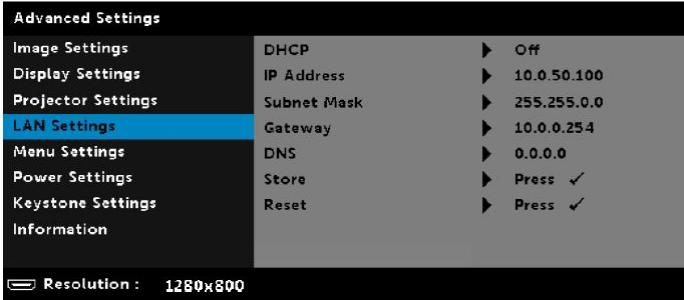

4 Access the **Input Source** menu, select **Network** source.

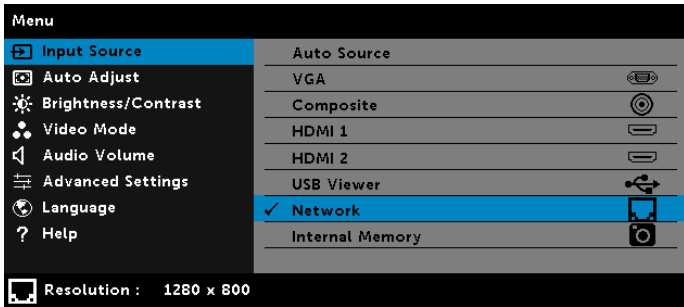

The **Network Guide Screen** shown below appears:

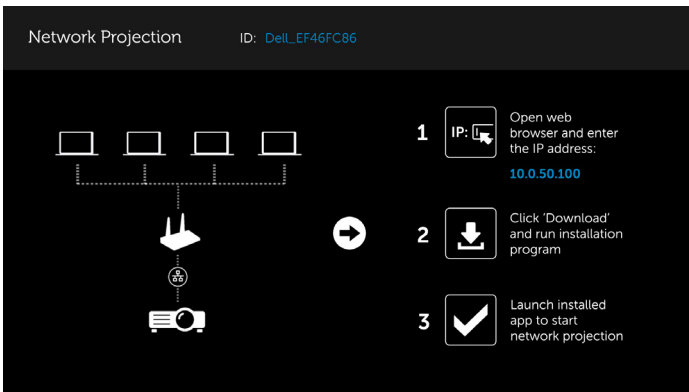

5 Do one of the following:

- a If this is the first time you are connecting to the projector via wireless method, first open the web browser on your computer and enter the IP address 10.0.50.100. Continue to Step 6.

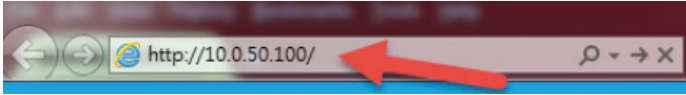

- b If you have previously connected your computer to the projector via wireless method, please continue to Step 6.
- 6 Follow the on-screen instruction to launch the web management page and download the app to start network projection.

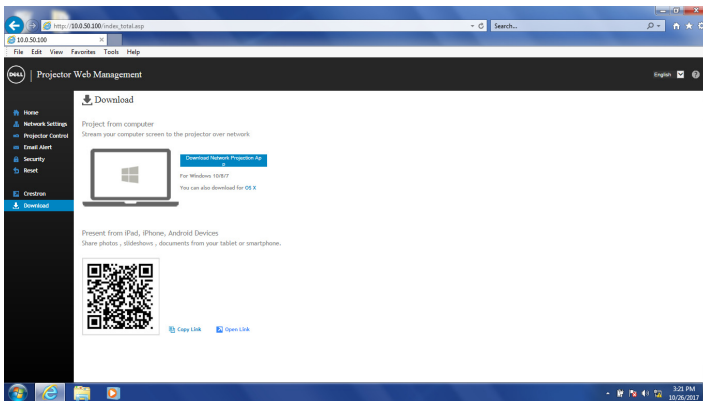

- 7 Open Dell Network Projection application on your computer.

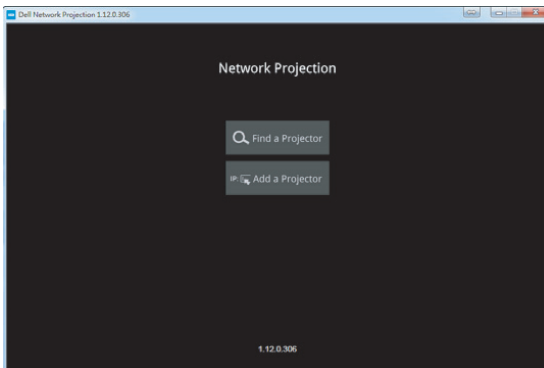

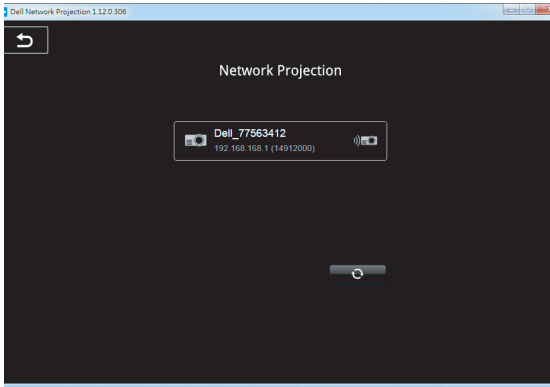

8 Find a Projector you connected with.

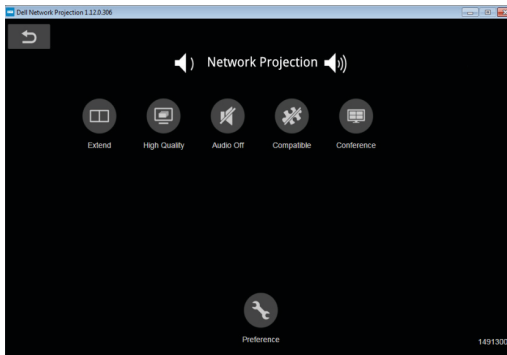

9 Select **Extend** to share your content.



 **NOTE:** Your computer should be equipped with wireless functionality and properly configured to detect another wireless connection. Refer to your computer's documentation on how to configure a wireless connection.

 **NOTE:** Your projector must be installed with a wireless dongle if you want to use the wireless display. The wireless dongle is not shipped with your projector. You can purchase it on the Dell website at www.dell.com.

Connecting a Computer Using Optional Wireless Dongle

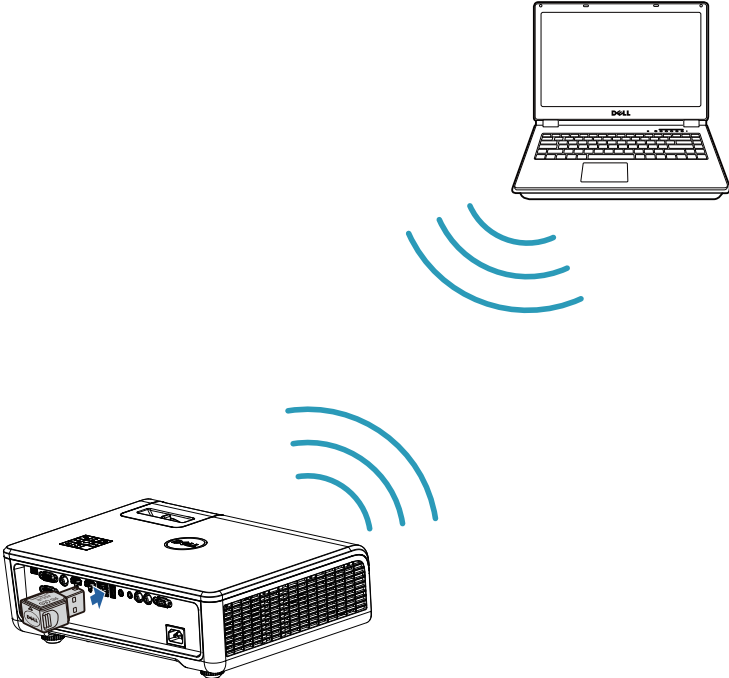

- 1 Connect the wireless dongle to the USB-A port on the projector.

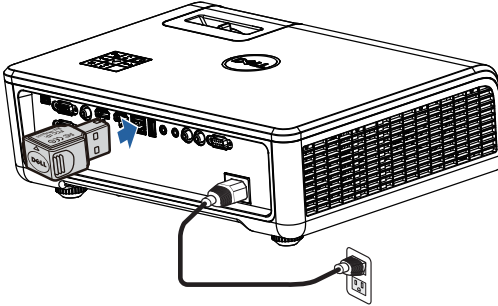

- 2 Access the Input Source menu, select **Network** source.

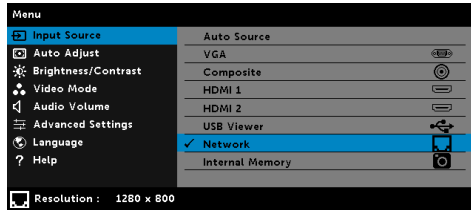
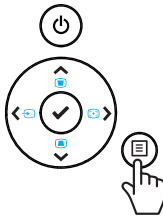

- 3 In your device's wireless menu, search for the projector by its ID. Then enter the PSK at the prompt to start sharing the same network with the projector.

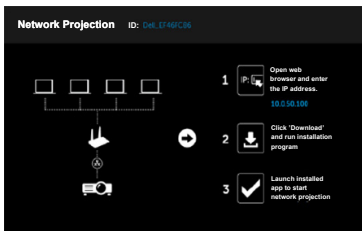

- 4 Do one of the following:
- a If this is the first time you are connecting to the projector via wireless method, first open the web browser on your computer and enter the IP address 10.0.50.100. Continue to Step 5.

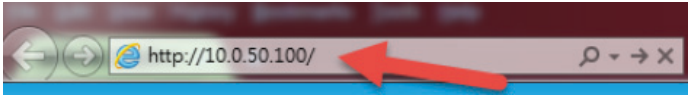

- b If you have previously connected your computer to the projector via wireless method, please continue to Step 6.
- 5 Follow the on-screen instruction to launch the web management page and download the app to start network projection.

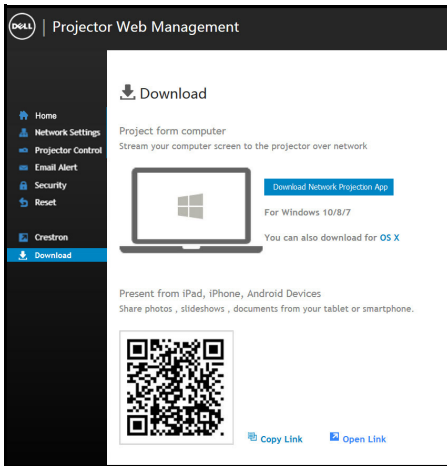

6 Open **Dell Network Projection** application on your computer.

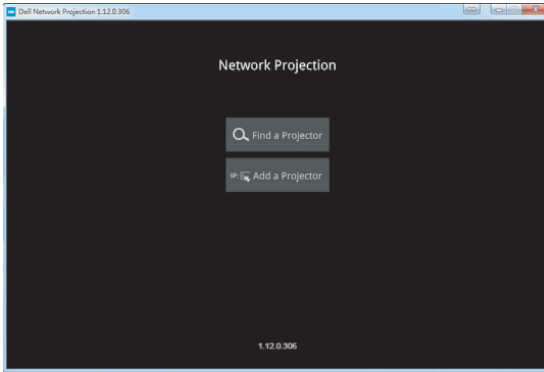

7 Find a Projector you connected with.

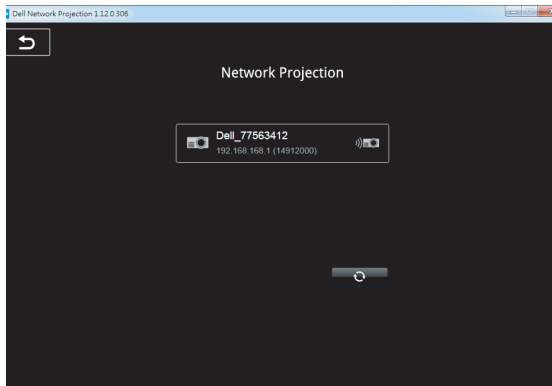

8 Select **Extend** to share your content.

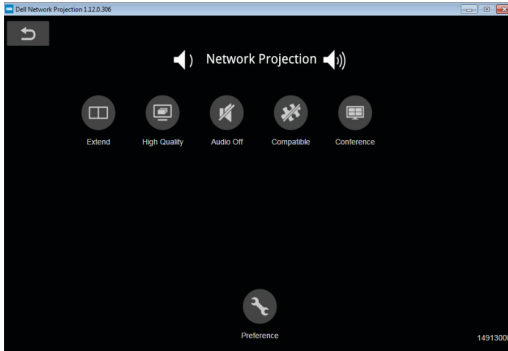

NOTE: Your computer should be equipped with wireless functionality and properly configured to detect another wireless connection. Refer to your computer's documentation on how to configure a wireless connection.



NOTE: Your projector must be installed with a wireless dongle if you want to use the wireless display. The wireless dongle is not shipped with your projector. You can purchase it on the Dell website at www.dell.com.

Connecting to Smartphone or Tablet Using Optional Wireless Dongle

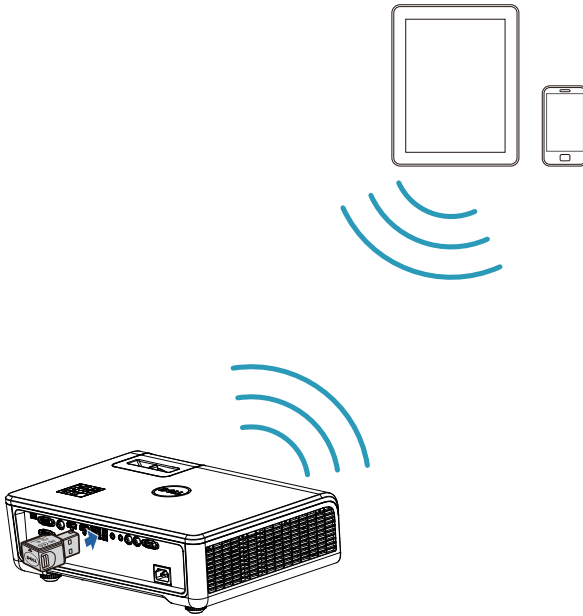

- 1 Install application **EZCast Pro** on your android or iOS device. In your device's wireless menu, search for the projector by its ID. Then enter the PSK at the prompt to start sharing the same network with the projector.
- 2 Launch the **EZCast Pro** application then click the top-right button to choose the device you connected with.

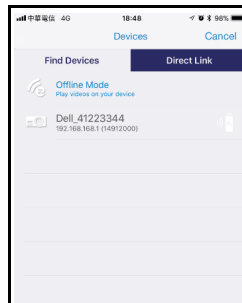
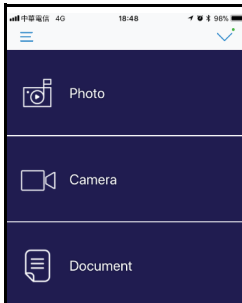



NOTE: Dell S518WL supports **EZView** function. It is an application that transmits supported content from your Android or iOS devices wirelessly. For more Information, please visit the Dell Support site at **dell.com/support**.

Supported file formats are listed on page 40 in Multimedia File Type Support section.

Connect Projector Directly to the Computer

A. Direct cable connection

3 Connect the LAN cable to the projector and the computer.

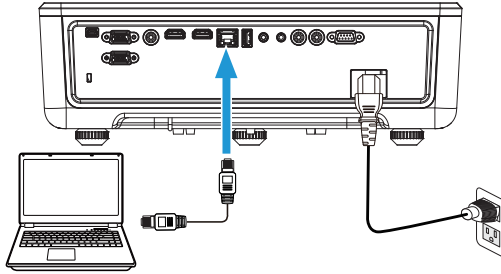

B. Network switch

4 Connect the LAN cable to the projector and the computer via the network switch/hub.

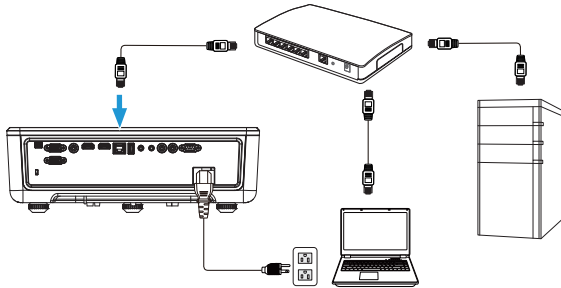

5 DHCP of LAN Settings switches to On.

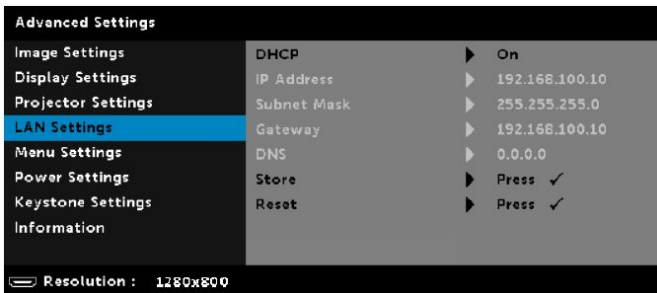

NOTE: If the DHCP setting is set to On, the IP sharing device will automatically assign a set of IP Address, Subnet Mask, and Gateway.

Install software on your PC/ Windows device

1 Open Local Area Connection Properties, and then enter the IP Address and Subnet Mask, click OK.

Steps: Start > Control Panel > Network and Internet > Network and Sharing Center > Change Adapter Setting > Local Area Connection

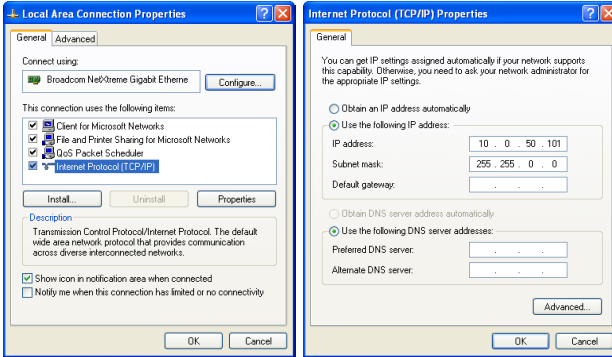

2 Open the Internet browser on your computer, and enter **10.0.50.100** (default) in the browser's address bar. You will be directed to the **Dell S518WL Web Management** page.

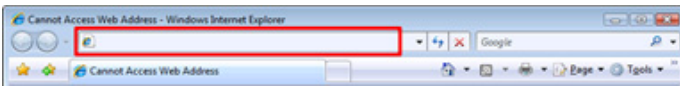

3 The S518WL Web Management page opens. For first-time use, click **Download**.

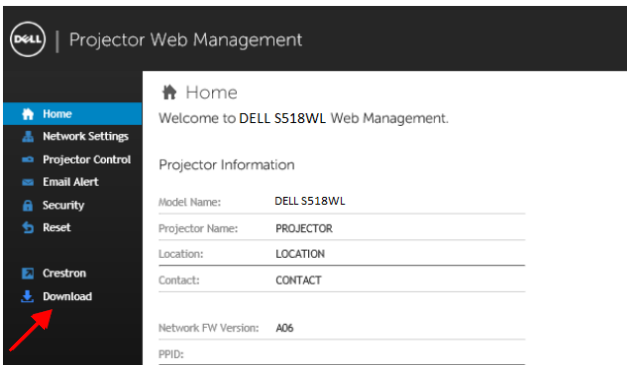

4 At the **Download** page, click **Download Network Projection App For Windows 10/8/7/Vista/XP** and install to your computer.

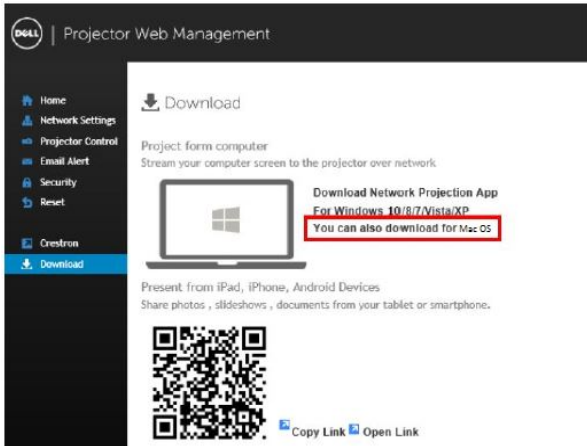

 **NOTE:** If you are unable to install the application because of inadequate rights on the computer, please contact your network administrator.

5 Click **Run** to proceed with the one-time installation of the software.

6 The installation software will launch. Follow the on-screen instructions to complete setup.

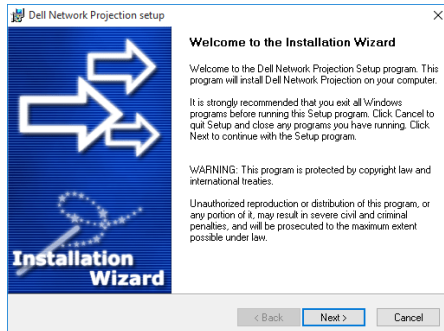

 **NOTE:** Alternatively you can download the latest version of the Dell Network Projection application from dell.com/support

Installation instructions for Mac

1 Open Local Area Connection Properties, and then enter the IP Address and Subnet Mask, click OK.

Steps: Go > Applications > System Preferences > Network

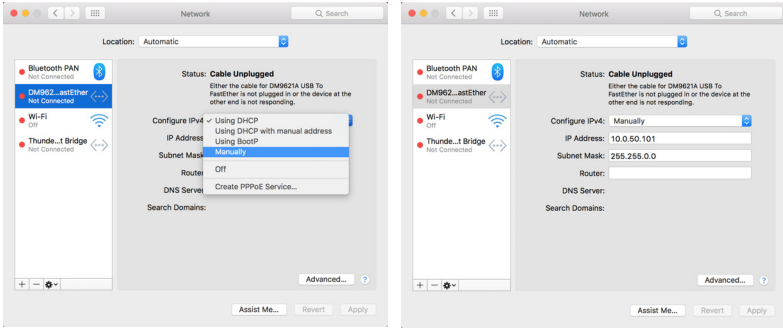

2 Open the Safari browser on your Mac computer, and enter **10.0.50.100** (default) in the browser's address bar. You will be directed to the **Dell S518WL Web Management** page.

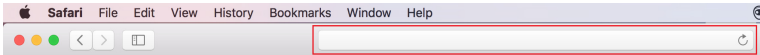

3 The S518WL web management page opens. For first-time use, click **Download**.

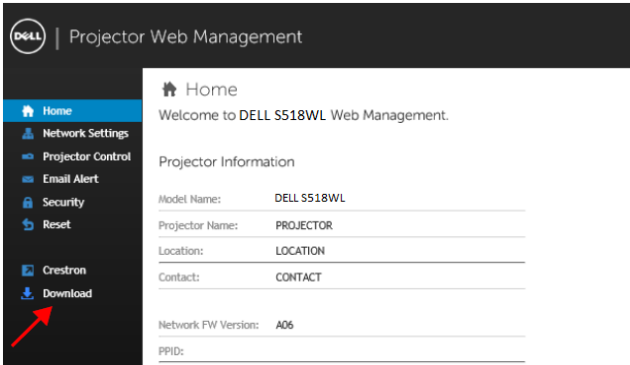

4 At the **Download** page, click **You can also download for Mac OS** and install to your computer.

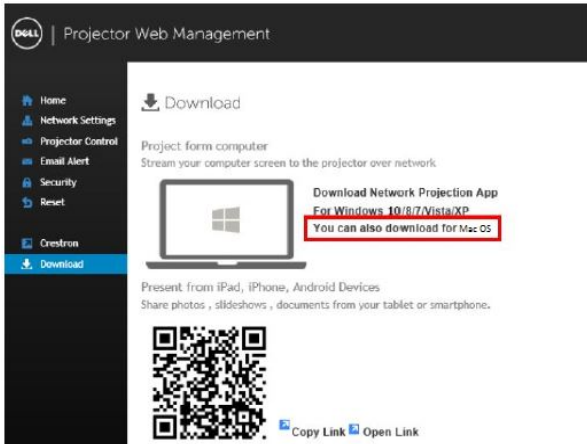

NOTE: If you are unable to install the application because of inadequate rights on the computer, please contact your network administrator.

5 Running **Dell_Network_Projection_Mac.pkg** from **Downloads** folder.

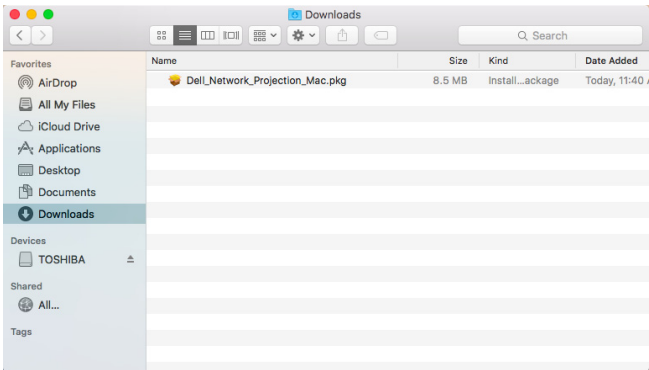

6 The installation software will launch. Follow the on-screen instructions to complete setup.

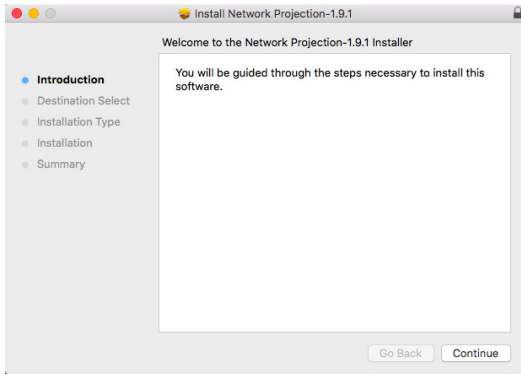

Using the Dell Network Projection App (Windows)

Once the installation is completed, you can double-click  icon on the desktop to start the application.

The **Dell Network Projection Screen** shown below appears:

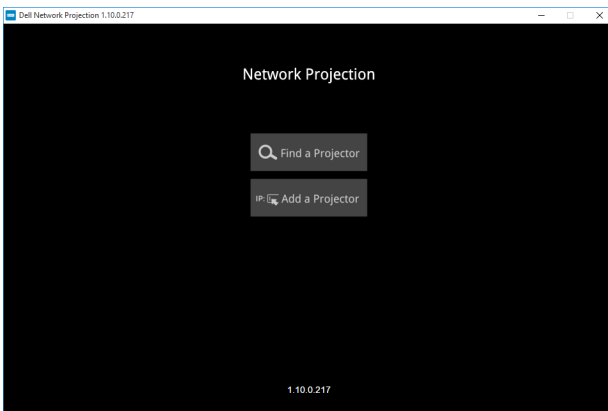

1 At **Dell Network Projection** screen, click **Find a Projector**, and then select **Dell_42FE21E1** (This is an example. The actual network name of your projector will differ from this example.). This is the name & code that will be projected, when your projector is set to the 'Network' source.

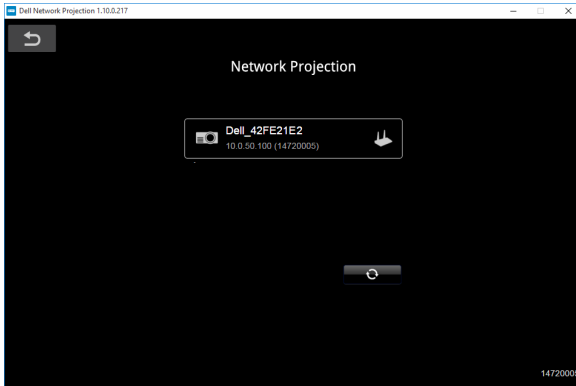

2 In order to start presenting, click on the first icon until **"Mirror On"** is shown.

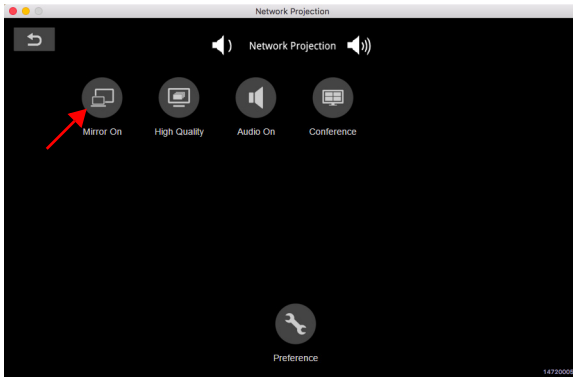

Using the Dell Network Projection App (Mac)

1 1. Go to **Applications** folder, and then open the **Network Projection** folder.

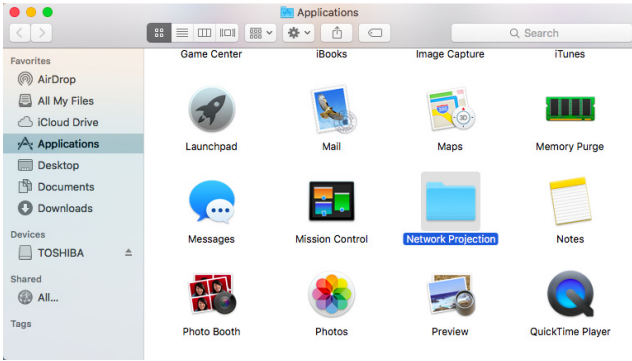

2 Run the **Network Projection** application from Network Projection folder.

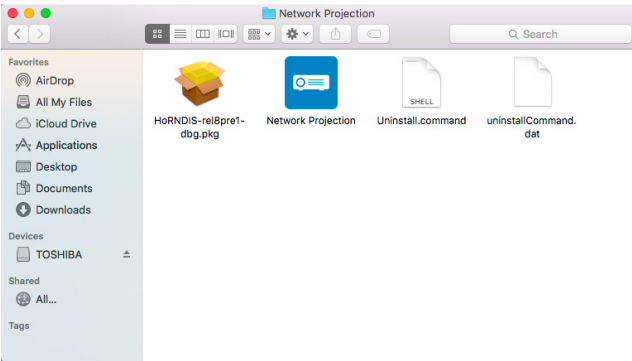

The **Dell Network Projection Screen** shown below appears:

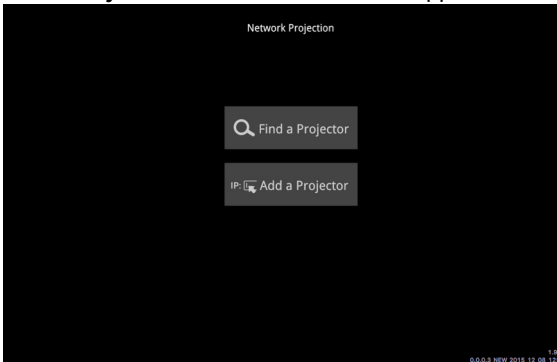

3 On the **Dell Network Projection** screen, click **Find a Projector**, and then select **Dell_CCDDEE01** (This is an example. The actual network name of your projector will differ from this example.). This is the name & code that will be projected, when your projector is set to the 'Network' source.

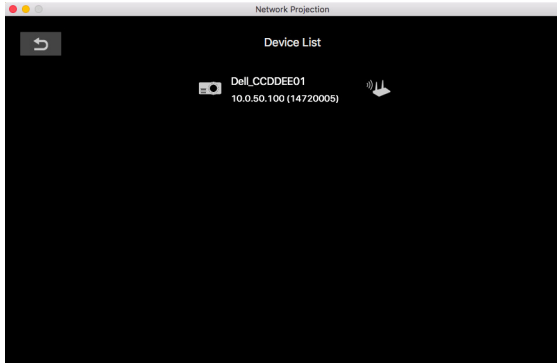

4 In order to start presenting, click on the first icon until **"Mirror On"** is shown.

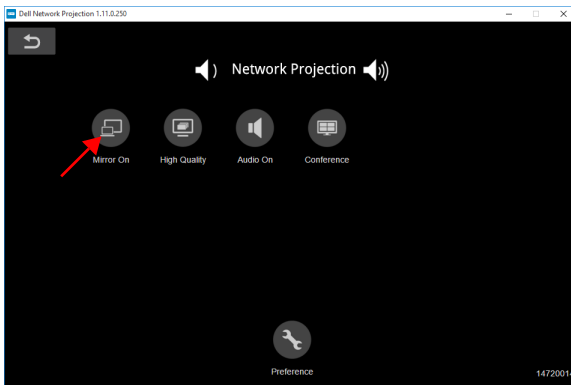





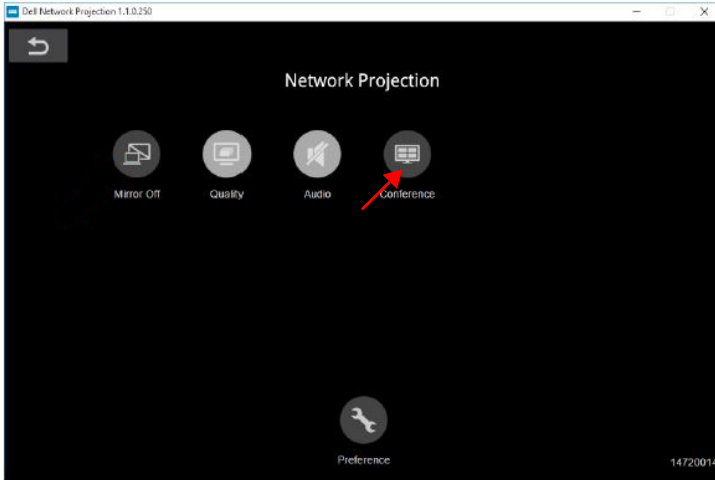

Split Screen

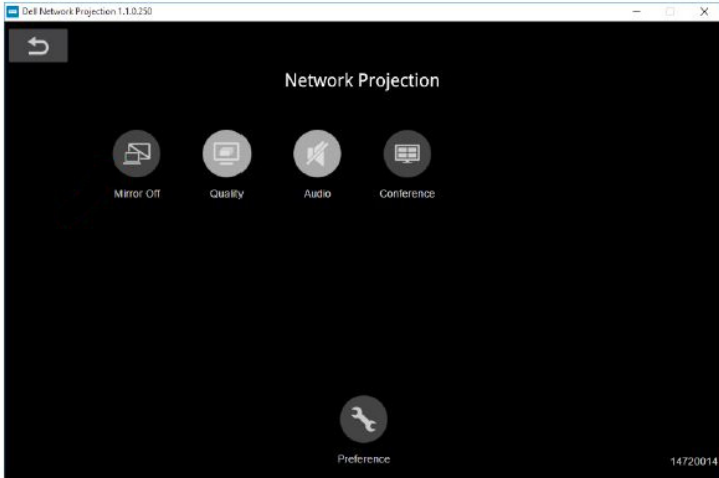
After the network projection connects, click **Conference** button to activate the split screen feature.



Understanding the Buttons



Item	Description
<hr/> Control Toolbar <hr/>	
	Mirror Off/On Click to toggle network projection On/Off and screen extension.
	Quality Click to toggle High/Low quality.
	Audio Click to toggle audio On/Off.
	Conference Click to activate the conference control.
	Preference Click to activate the fast connection settings.

Using PC-Free Presentation

Multimedia File Type Support

Photos

Image Type	Profile	Color Space	Size limitation
JPEG	Baseline	YUV400	8000 x 6000
		YUV420	8000 x 6000
		YUV422	8000 x 6000
		YUV440	8000 x 6000
		YUV444	8000 x 6000
	Progressive	YUV400	
		YUV420	
		YUV422	Width <= 10240 & Height <=6400
		YUV440	
		YUV444	
BMP	No Limit	No Limit	No Limit

Audio

Audio Format	Sample Rate (KHz)	Bit Rate (Kbps)
MP1	8-48	8-320
MP2	8-48	8-320
MP3	8-48	8-320
WMA	22-48	5-320

Video

File Extensions	Audio / Video	Codec	Profile/Level Support
.avi .mkv	Video	H.264	Up to High Profile , Levels 1- 4.1 (1080P 30fps 25Mbps)
	Audio	MPEG-1 Layer I, II	
		MPEG-1 Layer III (mp3)	
		PCM	
ADPCM			
.mov .mp4	Video	H.264	Up to High Profile , Levels 1- 4.1 (1080P 30fps 25Mbps)
		MPEG4	Advanced Simple Profile (frame picture) , Levels 0-5 (1080P 30fps 30Mbps)
	Audio	PCM	
		ADPCM	
.wmv	Video	WMV3	Up to Main Profile; Low, Medium Level (1080P 30fps 25Mbps)
	Audio	WMV2	

Office Viewer File Type Support

The office viewer feature allows you to play the MS Excel, MS Word, MS PowerPoint, and PDF files.

File Format	Support Version	Pages/Lines Limitation	Size Limitation
Adobe PDF		Up to 1000 pages (One file)	Up to 75 MB
MS Word	Word 97, 2000, 2002, 2003		Up to 100 MB
	Word 2007, 2010 (.docx)		
MS Excel	Excel 97, 2000,2002, 2003	Row Limit: up to 595 / Column Limit: up to 256	Up to 15 MB
	Excel 2007, 2010 (.xlsx)	Sheet: up to 100	
	Office XP Excel	Note: Any one of three limitations above does not appear on one Excel file simultaneously	
MS PowerPoint	PowerPoint 97	Up to 1000 pages (One file)	Up to 19 MB
	PowerPoint 2000, 2002, 2003		
	PowerPoint 2007, 2010 (.pptx)		
	Office XP PowerPoint		

Setting up to present using External USB Storage

 **NOTE:** A USB flash disk must be plugged into the projector if you want to use the USB media playback feature.

Follow these steps to display the Video, Audio, Photo, or PDF files on your projector:

- 1 Connect the power cable and turn on the projector by pressing the power button.

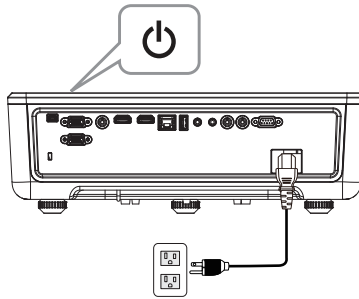

- 2 Plug in a USB flash disk to your projector.

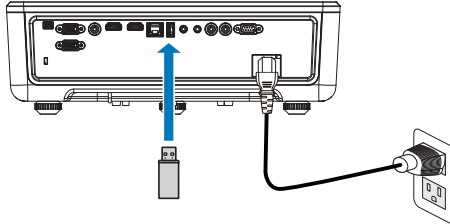

- 3 Press the **Menu** button on the control panel or remote control.
- 4 Access the **Input Source** menu, select **USB Viewer** source.

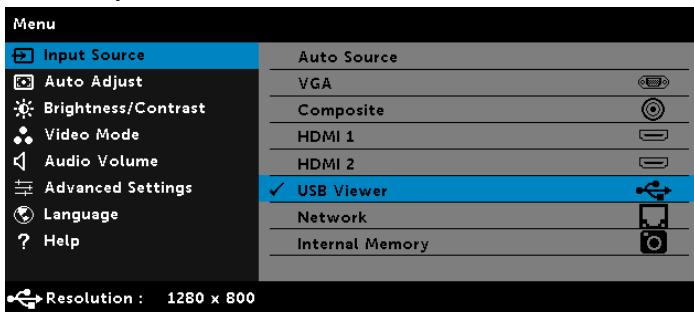

5 Go to USB Viewer menu:

- a You can play **Video**, **Music**, or **Photo** files, or select **Setting** option to change multimedia settings.

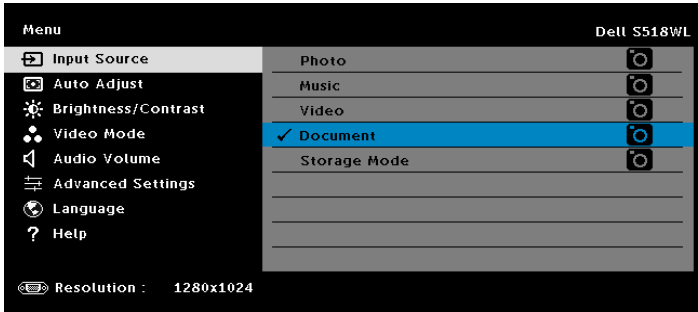

The Video Source Screen shown below appears:

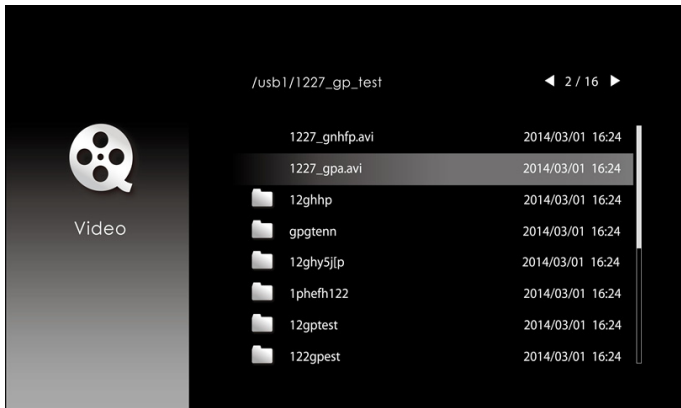

At the Video playback screen, press the **✓** button on the control panel or remote control to access the video playback control. Then you can use the following buttons on the screen to control video playback.



The **Music Source Screen** shown below appears:









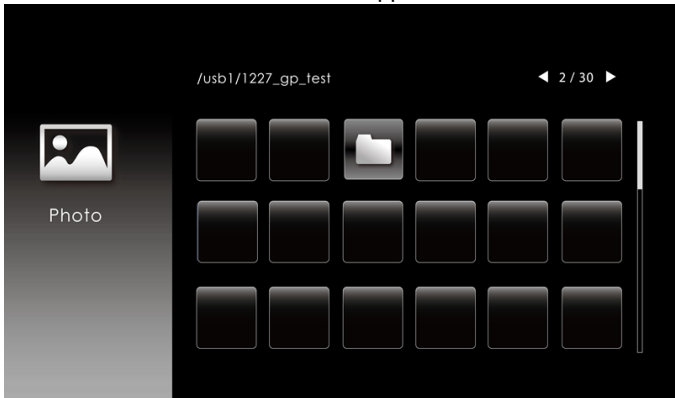

At the Music playback screen, press the  button on the control panel or remote control to access the music playback control. Then you can use the following buttons on the screen to control music playback.





The **Photo Source Screen** shown below appears:



At the Photo playback screen, press the button on the control panel or remote control to access the photo playback control. Then you can use the following buttons on the screen to control photo playback.

								
Rotate - / +		Zoom in / out		Up / Down / Left / Right (in Zoom mode)			Reset	

		
Slideshow	Information	Slideshow settings

The **Setting Source Screen** shown below appears:



- b You can also play **MS Excel, MS Word, MS PowerPoint,** or **PDF** files via **Document** option.

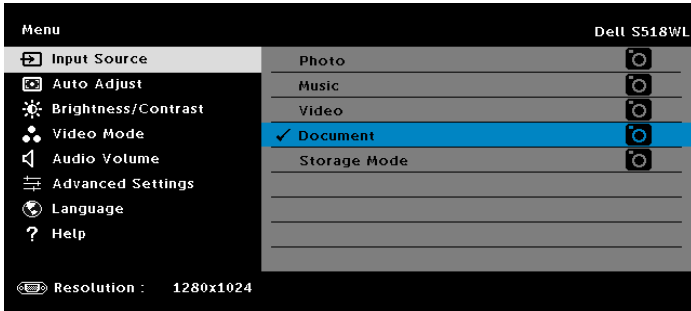

The **Document Screen** shown below appears:



Buttons Introduction (In USB Viewer)

Button	Up	Down	Left	Right	Enter	Menu	Return
Control Panel	Up	Down	Left and Source Menu (Hold 2 seconds)		Enter	Return	N/A
Remote Control	Up	Down	Left	Right	Enter	Return	Return

Office Viewer File Type Support

The office viewer feature allows you to play the MS Excel, MS Word, MS PowerPoint, and PDF files.

File Type	Support Version	Pages/Lines Limitation	Size Limitation
Adobe PDF		Up to 1000 pages (One file)	Up to 75 MB
MS Word	Word 97, 2000, 2002, 2003 Word 2007, 2010 (.docx)	Because office viewer does not load all pages of MS Word file at the same time, there are no obvious limitations of page and line.	Up to 100 MB

MS Excel	Excel 97, 2000,2002, 2003	Row Limit: up to 595 / Column Limit: up to 256	Up to 15 MB
	Excel 2007, 2010 (.xlsx)	Sheet: up to 100	
	Office XP Excel	Note: Any one of three limitations above cannot appear on one Excel file simultaneously	
MS PowerPoint	PowerPoint 97	Up to 1000 pages (One file)	Up to 19 MB
	PowerPoint 2000, 2002, 2003		
	PowerPoint 2007, 2010 (.pptx)		
	Office XP PowerPoint		
	PowerPoint presentation-2003 and earlier*.pps)		
PowerPoint presentation-2007 and 2010(.ppsx)			

Setting up to Present via Internal Memory

Follow these steps to playback the **Photo**, **Video**, or **Music** files on your projector:

- 1 Connect power cable with AC adapter then using USB-A to USB-A cable to connect computer and projector. Power up the projector by pressing the power button.

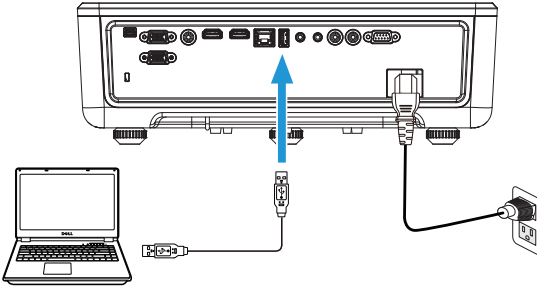

- 2 Access the **Input Source** menu, select the **Internal Memory** option, and press the **✓** button.

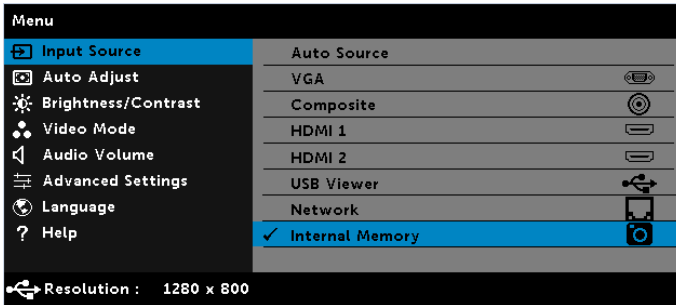

The **Internal Memory Screen** shown below appears:

- 3 Select **Storage Mode** to access the internal memory as **Removable Disk**.

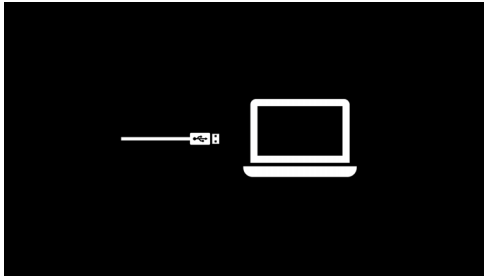
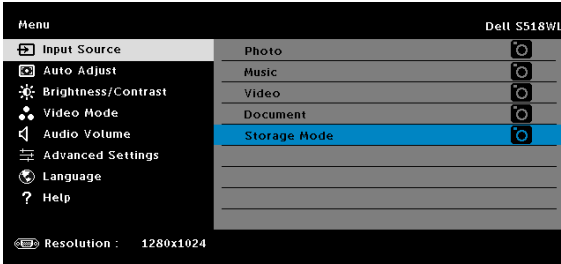

- 4 To copy files to the projector's Internal Memory, first open a file explorer window. Go to Computer and locate a Removable Disk. This refers to the Internal Memory of the projector. You may copy files to the Internal Memory. This will allow you to project the files directly from the projector in the future, without needing a computer. For supported file types, please refer to page 22.

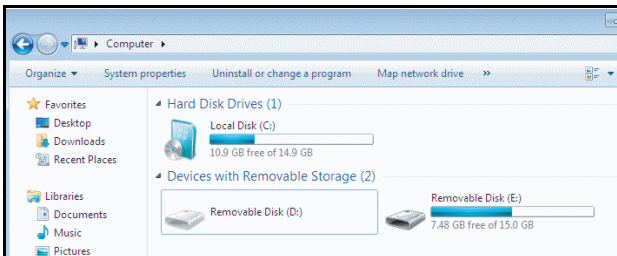

- 5 Select the multimedia files: **Photo**, **Music**, **Video**, or **Document**, and then press the **✓** button to start playing. Or select the **Setup** option to change multimedia settings.

The **Photo Source Screen** shown below appears:

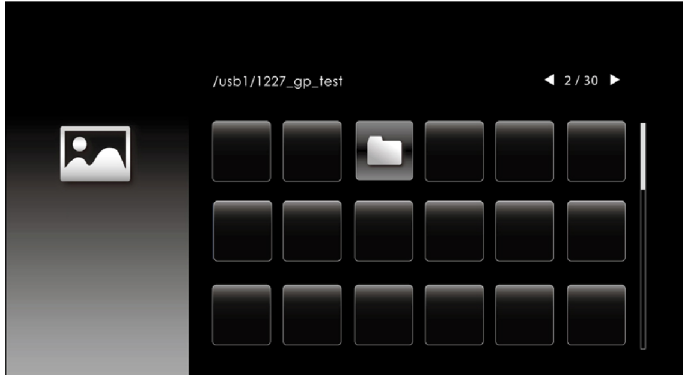

Slideshow screen:



Press the ✓ button on the remote control or keypad to access the photo viewer control. Then you can use the following buttons on the screen to control photo viewer.

Rotate - / +	Zoom in / out	Up / Down / Left / Right (in Zoom mode)				Reset	

Slideshow	Information	Slideshow settings

The **Music Source Screen** shown below appears:

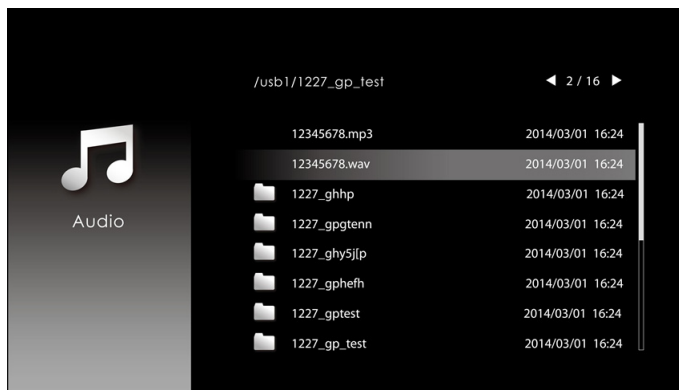

Music playback screen:

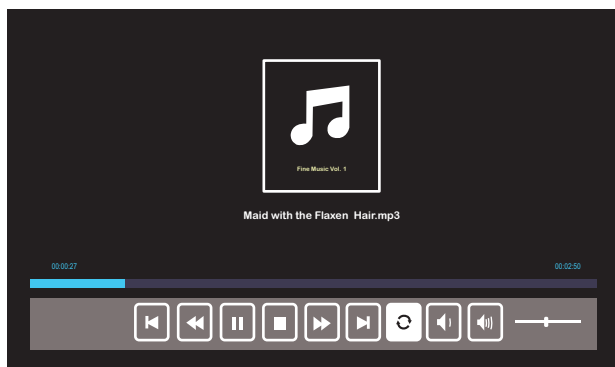

Press the **✓** button on the remote control or keypad to access the music playback control. Then you can use the following buttons on the screen to control music playback.



The **Video Source Screen** shown below appears:



Video playback screen:

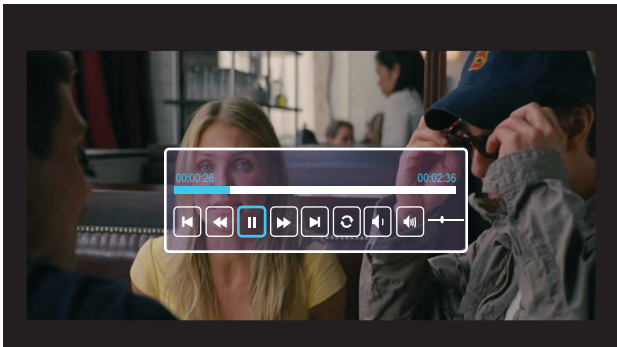

Press the **✓** button on the remote control or keypad to access the video playback control. Then you can use the following buttons on the screen to control video playback.



4

Troubleshooting

Troubleshooting Tips



If you experience problems with your projector, see the following troubleshooting tips. If your problem persists, please contact Dell.



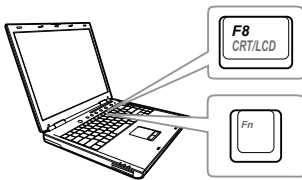

Problem

No image appears on the screen



Possible Solution

- Ensure that you have chosen the correct input source on the INPUT SOURCE menu.
 - Ensure the external graphics port is enabled. If you are using a Dell laptop computer, press   (Fn+F8). For other computers, see your respective documentation. If images are not displayed properly, please upgrade the video driver of your computer. For Dell computers, see www.dell.com/support.
 - Ensure that all the cables are securely connected. See "Adjusting Projector Image" on page 12.
 - Ensure that the pins of the connectors are not bent or broken.
 - Use the Test Pattern in the Projector Settings of the Advanced Settings menu. Ensure that the colors of the test pattern are correct.
-

Problem (continued)	Possible Solution (continued)
Partial, scrolling, or incorrectly displayed image	<p>If you are using a Dell laptop computer, set the resolution of the computer to WXGA (1280 x 800):</p> <ul style="list-style-type: none"> aRight-click the unused portion of your Microsoft® Windows® desktop, click Properties, and then select Settings tab. bVerify that the setting is 1280 x 800 pixels for the external monitor port. cPress   (Fn+F8). <p>If you experience difficulty in changing resolutions, or if your monitor freezes, restart all the equipment and the projector.</p> <p>If you are not using a Dell laptop computer, see your documentation. If images are not displayed properly, please upgrade the video driver of your computer. For a Dell computer, see www.dell.com/support.</p>
The screen does not display your presentation	<p>If you are using a portable computer, press   (Fn+F8).</p>
Image color is incorrect	<ul style="list-style-type: none"> • If the display receives the wrong signal output from the graphics card, please set the signal type to RGB in the OSD Image Settings of the Advanced Settings tab. • Use Test Pattern in the Projector Settings of the Advanced Settings menu. Ensure that the colors of the test pattern are correct.
Image is out of focus	<ol style="list-style-type: none"> 1 Adjust the focus until the image is clear. Use Focus Adjust in the Projector Settings of the Advanced Settings menu. 2 Ensure that the projection screen is within the required distance from the projector (2.55 ft (0.78 m) ~ 3.67 ft (1.12 m)).

Problem (continued)	Possible Solution (continued)
The image is stretched when displaying a 16:9 DVD	<p>The projector automatically detects the input signal format. It will maintain the aspect ratio of the projected image according to the input signal format with an Original setting.</p> <p>If the image is still stretched, adjust the aspect ratio in the Display Settings of the Advanced Settings menu in the OSD.</p>
Image is reversed	Select Projector Settings of the Advanced Settings from the OSD and adjust the projector mode.
TEMP light is solid amber	The projector has overheated. The display automatically shuts down. Turn the display on again after the projector cools down. If the problem persists, please contact Dell.
TEMP light is blinking amber	If the projector fan fails, the projector will automatically shut down. Try to clear the projector mode by pressing and holding the Power button for 10 seconds. Please wait for about 5 minutes and try to power up again. If the problem persists, please contact Dell.
The remote control is not operating smoothly or works only within a limited range	The battery level might be low. If so, replace with new CR2032 battery.
LAN control support	<ul style="list-style-type: none"> • Web Control functions were verified on IE9, IE10, and IE11. The other version may have compatibility problem. • The Compatibility View setting should be disabled. Otherwise the web control page may have icon or content display abnormal issue.

Guiding Signals

Projector Status	Description	Control Buttons		Indicator	
		Power	TEMP (Amber)	LAMP (Amber)	
Standby mode	Projector in Standby mode. Ready to power on.	White Flashing	OFF	OFF	OFF
Warming up mode	Projector takes some time to warm up and power on.	White	OFF	OFF	OFF
Laser Diode on	Projector in Normal mode, ready to display an image.  Note: The OSD menu is not accessed.	White	OFF	OFF	OFF
Cooling mode	Projector is cooling to shutdown.	White	OFF	OFF	OFF
Projector overheated	Air vents might be blocked or ambient temperature may be above 40°C. The projector automatically shuts down. Ensure that the air vents are not blocked and that the ambient temperature is within operational range. If the problem persists, please contact Dell.	OFF	AMBER	OFF	OFF
Fan breakdown	One of the fans has failed. The projector automatically shuts down. If the problem persists, please contact Dell.	OFF	AMBER Flashing	OFF	OFF
Laser Diode driver overheated	Air vents might be blocked or the Laser Diode driver has overheated. The projector will automatically shut down. Turn the display on again after the projector cools down. If the problem persists, please contact Dell.	AMBER	AMBER	OFF	OFF
Color Wheel breakdown	Color wheel cannot start. The projector has failed and the projector automatically shuts down. Unplug/plug the power cord and then turn on the projector. If this problem persists, please contact Dell.	White	AMBER Flashing	AMBER Flashing	AMBER Flashing
Laser Diode failure	Laser Diode is defective.	OFF	OFF	AMBER	AMBER
Fault - DC supply (+12V)	Power supply has been interrupted. The projector automatically shuts down. Unplug/plug the power cord and then turn on the projector. If this problem persists, please contact Dell.	AMBER Flashing	AMBER	AMBER	AMBER

5

Maintenance

Replacing the Remote Control Battery

- 1 Rotate the battery lid counterclockwise to remove the battery cover.

- 2 Insert a CR2032 coin cell battery and align the polarity correctly according to the marking in the battery holder.



NOTE: When you use the remote control for the first time, there is a plastic sheet between the battery and its contact. Remove the sheet before use.

- 3 Rotate the battery lid clockwise to lock the battery cover.

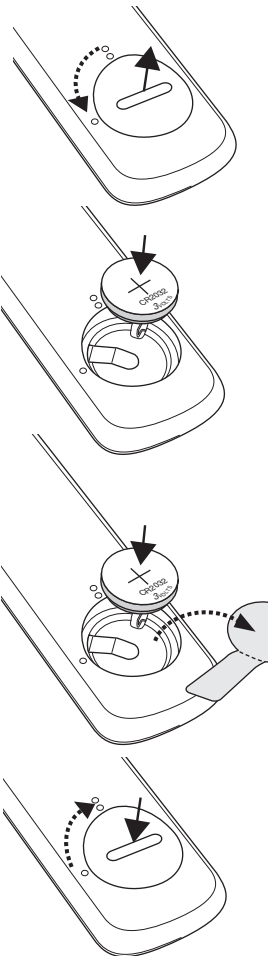

6

Specifications

Light Valve	0.65 WXGA S450 DMD, DarkChip3™
Brightness	3200 ANSI Lumens (Max.)
Contrast Ratio	1800:1 Typical (Full On/Full Off) 20000:1 High Contrast Ratio
Uniformity	80% Typical (Japan Standard - JBMA)
Number of Pixels	1280 x 800 (WXGA)
Aspect Ratio	16:9
Displayable Color	1.07 billion colors
Color Wheel Speed	2 X for Normal
Projection Lens	F-Stop: F/2.7 Focal length, f=7.51 mm No Manual Zoom Lens, Fixed Throw ratio =0.52 Offset ratio: 115+/-5%
Projection Screen Size	70 ~ 100 inches (diagonal)
Projection Distance	2.55 ~ 3.67 ft (0.78 ~ 1.12 m)
Keystone	+/- 15 degree
Video Compatibility	Component Video input via HDMI: 2160p (24/25/60 Hz), 1080i (24/25/60 Hz), 720p (50/60 Hz), 576i/p, 480i/p
Power Supply	Universal AC 100-240 V 50-60 Hz with PFC input
Power Consumption	Normal mode: 255 W ± 10% @ 110 Vac Eco mode: 135 W ± 10% @ 110 Vac Standby mode: < 0.5 W Network standby: < 2 W
	 NOTE: By default, the projector is set to enter power saving mode after 20 minutes of no activity.
Audio	2 speakers x 10 watt RMS

Noise Level	Normal mode: 36 dB(A) Eco mode: 32 dB(A)
Projector Weight	< 12 lb (5.5 Kg)
Dimensions (W x D x H)	1.26 x 0.99 x 0.37 inches (386.5 x 303.2 x 115 mm)

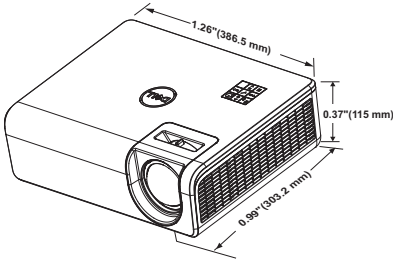

Environmental	<p>Operating temperature: 5 °C - 40 °C (41 °F- 104 °F) Humidity: 80% maximum</p> <p>Storage temperature: 0 °C to 60 °C (32 °F to 140 °F) Humidity: 90% maximum</p> <p>Shipping temperature: -20 °C to 60 °C (-4 °F to 140 °F) Humidity: 90% maximum</p>
I/O Connectors	<p>Power: One AC power socket (3-pin - C14 inlet)</p> <p>VGA input: One 15-pin D-sub connector (Blue), VGA In, for analog RGB/Component input signals.</p> <p>VGA output: One 15-pin D-sub connector (Black) for VGA-A loop through.</p> <p>Composite Video input: One Yellow RCA jack for CVBS signal.</p> <p>HDMI 1.4 input: Two HDMI 1.4 connectors for HDMI 1.4 specification HDCP 2.2 compliant.</p> <p>Analog Audio input: One 3.5 mm stereo mini phone jack (Blue) and One pair of RCA (Red/ White)</p> <p>Variable audio output: One 3.5 mm stereo mini phone jack (Green).</p>

USB (mini type B) port: One mini type B connector for firmware upgrade.

USB Power (5V/1.8A): One USB Power (5V/1.8A) for power only

RS232 port: One 9-pin D-sub for RS232 communication.

RJ-45 port: One RJ-45 connector for build-in for network control and LAN display.

Up to 20,000 hours in Normal mode

Light Source

Compatibility Mode (Digital / Analog)

Resolution	Refresh Rate (Hz)	H Sync Frequency (KHz)	Pixel Clock (MHz)
640 x 350	70.087	31.469	25.175
720 x 400	70.087	31.469	28.322
720 x 480 p60	59.940	31.469	27.000
720 x 576 p50	50.000	31.250	27.000
720 x 400	70.087	31.469	28.322
640 x 480	75.000	37.500	31.500
640 x 480	85.008	43.269	36.000
800 x 600	60.317	37.879	40.000
800 x 600	75.000	46.875	49.500
800 x 600	85.061	53.674	56.250
1280 x 720 p50	50.000	37.500	74.250
1280 x 270 p60	60.000	45.000	74.250
1920 x 1080 i50	50.000	28.125	74.250
1920 x 1080 i60	60.000	33.750	74.250
1280 x 720	59.855	44.772	74.500
1024 x 768	75.029	60.023	78.750
1280 x 800	59.810	49.702	83.500
1366 x 768	59.790	47.712	85.500
1152 x 864	75.000	67.500	108.000
1280 x 1024	60.020	63.981	108.000
1280 x 1024	75.025	79.976	135.000
1280 x 1024	85.024	91.146	157.000
1600 x 1200	60.000	75.000	162.000
1400 x 1050	59.978	65.317	121.750
1280 x 768	59.870	47.776	79.500
1360 x 768	60.015	47.712	85.500
1680 x 1050-R	59.883	64.674	119.000

1680 x 1050	59.954	65.290	146.250
1920 x 1200-R	60.000	74.038	154.000
1440 x 900	59.887	55.935	106.500
848 x 480	60.000	31.020	33.750
1920 x 1080	60.000	67.500	148.500
1366 x 768	59.790	47.712	85.500
1280 x 800	59.810	49.702x	83.500

7

Additional Information

For additional information on how to use your projector, please see the **Dell Projectors User Guide** at www.dell.com/support/manuals.

8

Contacting Dell

For customers in the United States, call 800-WWW-DELL (800-456-3355).



NOTE: If you do not have an active Internet connection, you can find contact information on your purchase invoice, packing slip, bill, or Dell product catalog.

Dell provides several online and telephone-based support and service options. Availability varies by country and product, and some services may not be available in your area. To contact Dell for sales, technical support, or customer service issues:

- 1 Visit go to www.dell.com/contactDell.
- 2 Select your country from the displayed list.
- 3 Select a Segment for Contact.
- 4 Select the appropriate service or support link based on your need.

Index

A

- Adjusting the Projected Image
 - Adjusting the Projector Height 12
 - lower the projector
 - Front tilt adjustment wheel 12
 - Rear tilt adjustment wheel 12

C

- Connection Ports
 - Audio input connector 6
 - Audio output connector 6
 - Audio RCA (L) connector 6
 - Audio RCA (R) connector 6
 - Composite Video connector 6
 - HDMI-1 (1.4) connector 6
 - HDMI-2 (1.4) connector 6
 - Mini USB (mini type B) connector for firmware upgrade 6
 - Power cord connector 6
 - RJ45 connector 6
 - RS232 connector 6
 - USB Type A Power (+5V/1.8A) connector and also for media / wifi 6
 - VGA input 6
 - VGA output 6
- Contact Dell 4

D

- Dell
 - contacting 65, 66

M

- Main Unit 5
 - Focus tab 5
 - IR receiver 5
 - Lens 5
 - Mounting holes for ceiling mount 5
 - Mounting holes for wall mount 5
 - Power button 5
 - Tilt adjustment wheel 5

P

- phone numbers 66

R

- Remote Control 9
- Replacing 59

S

- Specifications
 - Aspect Ratio 60
 - Audio 60

- Brightness 60
- Color Wheel Speed 60
- Contrast Ratio 60
- Dimensions 61
- Displayable Color 60
- Environmental 61
- I/O Connectors 61
- Light Valve 60
- Noise Level 61
- Number of Pixels 60
- Power Consumption 60
- Power Supply 60
- Projection Distance 60
- Projection Lens 60
- Projection Screen Size 60
- Projector Weight 61
- Uniformity 60
- Video Compatibility 60

support

- contacting Dell 65, 66

T

- telephone numbers 66

Free Manuals Download Website

<http://myh66.com>

<http://usermanuals.us>

<http://www.somanuals.com>

<http://www.4manuals.cc>

<http://www.manual-lib.com>

<http://www.404manual.com>

<http://www.luxmanual.com>

<http://aubethermostatmanual.com>

Golf course search by state

<http://golfingnear.com>

Email search by domain

<http://emailbydomain.com>

Auto manuals search

<http://auto.somanuals.com>

TV manuals search

<http://tv.somanuals.com>