

DATA PROJECTOR

XJ-UT331X/XJ-UT311WN*/ XJ-UT351W/XJ-UT351WN*

*Network Models

User's Guide

- Be sure to read the "Safety Precautions" and "Operating Precautions" in the "Read this first" document, and make sure you use this product correctly.
- Keep this manual in a safe place for future reference.
- Visit the site below for the latest version of this manual.
<http://world.casio.com/manual/projector/>

- DLP is a registered trademark of Texas Instruments of the United States.
- Microsoft and Windows are registered trademarks or trademarks of Microsoft Corporation in the United States and other countries.
- HDMI, the HDMI Logo and High-Definition Multimedia Interface are trademarks or registered trademarks of HDMI Licensing, LLC.
- PjLink is a pending trademark or a registered trademark in Japan, the United States, and other countries and areas.
- Crestron and Crestron Connected are registered trademarks of Crestron Electronics, Inc. of the United States.
- AMX is a registered trademark of AMX LLC of the United States.
- XGA is a registered trademark of IBM Corporation of the United States.
- Other company and product names may be registered trademarks or trademarks of their respective owners.
- Portions of this product are based in part on the work of the Independent JPEG Group.

- The contents of this User's Guide are subject to change without notice.
- Copying of this manual, either in part or its entirety is forbidden. You are allowed to use this manual for your own personal use. Any other use is forbidden without the permission of CASIO COMPUTER CO., LTD.
- CASIO COMPUTER CO., LTD. shall not be held liable for any lost profits or claims from third parties arising out of the use of this product or this manual.
- CASIO COMPUTER CO., LTD. shall not be held liable for any loss or lost profits due to loss of data due to malfunction or maintenance of this product, or any other reason.
- The sample screens shown in this manual are for illustrative purposes only, and may not be exactly the same as the screens actually produced by the product.

Contents

Safety Precautions	6
Operating Precautions	12
About the Light Source Unit.....	12
Projector Light Emission	12
Laser and High Temperature Precautions (See the label on the projector)	13
Other Precautions	14
Precaution when Handling the Projector after Use	15
Getting Ready	16
Unpacking	16
Operation Flow to Projection.....	16
General Guide	17
Terminals	18
Setting Up the Projector.....	19
Setup Precautions	19
Connecting with an External Device	20
Cover Included with the YW-40 Wireless Adapter	22
Attaching and Removing the Cable Cover	22
Remote Controller	23
Operating the Projector	24
Basic Image and Audio Operations During Projection.....	24
Basic Operation List	24
Input Source Details	26
Light Control	27
Digital Screen Shift.....	28
Test Pattern Projection.....	28
Changing the Audio Input.....	29
Control Panel Lock.....	29

Configuring Remote Control ID and Projector ID Settings.....	30
Using the Presentation Timer (TIMER)	30
To display the timer	30
To display the timer function menu	30
To configure timer settings.....	31
Timer Operations	31
Using the Setup Menu (MENU)	32
Setup Menu Settings	32
Password Protection	38
If you forget your password... ..	39
Projecting from USB Input (Network Models Only).....	39
Supported Playback Files.....	39
Supported USB Memory Devices.....	39
Connecting USB Memory Devices to the Projector	40
Projecting Files from a USB Memory Device.....	40
Operation During Image File Projection	41
Operation During Movie File Projection.....	41
File Viewer Setting Items	42
File Menu Operations.....	42
Autorun	43
File Viewer Troubleshooting.....	43
File Viewer Error Messages	44
Projecting the Screen Image of a Graphing Calculator.....	45
To project the screen image of a graphing calculator	45
Cleaning the Projector.....	46
Cleaning the Projector Exterior	46
Cleaning the Lens.....	46
Cleaning Vents	46
Troubleshooting	47
Indicators.....	47
Error Indicators and Warning Messages	47
Projector Troubleshooting	49



Appendix	51
Supplying Power to External Equipment.....	51
Updating Firmware and Transferring a User Logo	52
Mounting the Projector on a Wall.....	52
Using the MONITOR OUT Terminal	53
Projection Distance and Screen Size	54
Aspect Ratio Setting and Projection Image	55
Projector RS-232C Control	57
Specifications	60
TCO Certified Document URL.....	62

Safety Precautions

Thank you for selecting this CASIO product. Be sure to read these “Safety Precautions” before trying to use it. After reading this User’s Guide, keep it in a safe place for future reference.

About safety symbols

Various symbols are used in this User’s Guide and on the product itself to ensure safe use, and to protect you and others against the risk of injury and against material damage. The meaning of each of the symbols is explained below.

 Danger	This symbol indicates information that, if ignored or applied incorrectly, creates the risk of death or serious personal injury.
 Warning	This symbol indicates information that, if ignored or applied incorrectly, could possibly create the risk of death or serious personal injury.
 Caution	This symbol indicates information that, if ignored or applied incorrectly, could possibly create the risk of personal injury or material damage.

Icon Examples



A triangle indicates a situation against which you need to exercise caution. The example shown here indicates you should take precaution against electric shock.



A circle with a line through it indicates information about an action that you should not perform. The specific action is indicated by the figure inside the circle. The example shown here means disassembly is prohibited.



A black circle indicates information about an action that you must perform. The specific action is indicated by the figure inside the circle. The example shown here indicates you must unplug the power cord from the power outlet.

Precautions During Use

Warning

- **Adult supervision is required whenever there are young children present and especially when there is the possibility of young children coming into contact with the projector.**

- **Smoke, odor, heat, and other abnormalities**



Should you ever notice smoke, strange odor, or any other abnormality, immediately stop using the projector. Continued use creates the risk of fire and electric shock. Immediately perform the following steps.

1. Unplug the projector.
2. Contact your original dealer or authorized CASIO service center.

● **Malfunction**



Immediately stop using the projector if the screen appears abnormal, or if any other abnormal operation occurs even though you are operating the projector correctly. Continued use creates the risk of fire and electric shock. Immediately perform the following steps.

1. Turn off the projector.
2. Unplug the projector.
3. Contact your original dealer or authorized CASIO service center.

● Power cord



Misuse of the power cord creates the risk of fire and electric shock.

Make sure that you always observe the following precautions.

- Be sure to use only the accessories that come with the projector.
- Make sure that you use a power source with the same voltage as that specified for the projector.
- Do not overload a power outlet with too many devices.
- Do not locate the power cord near a stove.
- Do not use the power cord that comes with the projector with any other device.
- Do not share the outlet supplying power to the projector with other devices. If you are using an extension cord, make sure that the ampere rating of the extension cord is compatible with the power consumption value of this projector.
- Never use the power cord while it is still bundled together.
- Use a conveniently located power outlet that you can reach easily when you need to unplug the projector.



A damaged power cord creates the risk of fire and electric shock.

Make sure that you always observe the following precautions.

- Never place heavy objects on the power cord and never expose it to heat.
- Make sure the power cord is not pinched between the wall and the rack or table where the projector is located, and never cover the power cord with a cushion or other object.
- Never try to modify the power cord, allow it to become damaged, or subject it to excessive bending.
- Do not twist the power cord or pull on it.



Never touch the power cord or plug while your hands are wet.

Doing so creates the risk of electric shock.

- When using this projector in the country where you purchased it, be sure to use the power cord that came with it. Whenever using the projector in another country, be sure to purchase and use a power cord that is rated for the voltage of that country. Also make sure that you are aware of the Safety Standards that apply in that country.



When going out, make sure the projector is in a location away from pets and other animals, and unplug the power plug from the power outlet. A power cord damaged by chewing can cause shorts, and creates the risk of fire.

● Water and foreign matter



Never allow water to get on the projector. Water creates the risk of fire and electric shock.



Never place a vase or any other container of water on top of the projector. Water creates the risk of fire and electric shock.



Water or other liquid, or foreign matter (metal, etc.) getting into the projector creates the risk of fire and electric shock. Should anything get inside the projector, immediately perform the following steps.

1. Turn off the projector.
2. Unplug the projector.
3. Contact your original dealer or authorized CASIO service center.

● Disassembly and modification



Never try to take the projector apart or modify it in any way. The projector contains a large number of high-voltage components that create the risk of electric shock and burn injury. Also, note that problems caused by unauthorized projector disassembly or modification are not covered by the warranty and are not eligible for repair by CASIO.

Be sure to leave all internal inspection, adjustment, and repair up to your original dealer or authorized CASIO service center.

● Dropping and impact



Continued use of the projector after it has been damaged by dropping or other mistreatment creates the risk of fire and electric shock. Immediately perform the following steps.

1. Turn off the projector.
2. Unplug the projector.
3. Contact your original dealer or authorized CASIO service center.

● Disposal by burning



Never try to dispose of the projector by burning it. Doing so can cause an explosion, which creates the risk of fire and personal injury.

● Projector light emission



- Never look directly into the lens, intake vents, or exhaust vents while the light is on. When turning on the projector, check to make sure that no one is looking directly into its lens, intake vents, or exhaust vents. The strong light emitted by the projector creates the risk of eye damage.
- Do not attempt to use a magnifying glass, mirror, or other similar object to bend or reflect the projector's light, and never hold or place such object in the path of the projector's light. Refracted or reflected light can shine into a person's eyes and create the risk of eye damage.

● Blocking the vents



Never allow the vents to become blocked. Doing so causes internal heat build up, which creates the risk of fire and breakdown of the projector. Touching the projector while it is hot creates the risk of burn injury. Make sure that you always observe the following precautions.

- Maintain a distance of at least 6 cm (2.4 inches) between the front of the projector (from which light is being emitted) and the projection surface (screen). Maintain a distance of at least 30 cm (11.8 inches) between surfaces and the other sides of the projector.

- Do not insert the projector into any space where air circulation is poor.
- Never cover the projector with a blanket or any similar item.
- Locate the projector on a firm, flat surface during use. Never use the projector while it is on a carpet, blanket, towel, seat cushion, or other pliable surface.
- Never stand the projector up on either end during use.

● Projector cabinet



Never open the projector's cabinet. Doing so creates the risk of electric shock.

● Cleaning



Before cleaning the projector, be sure to turn it off and unplug it from the power outlet. Failure to do so creates the risk of electric shock.

● Exhaust vents

The exhaust vents become very hot while the projector is running. Never touch them. Doing so creates the risk of burn injury. The areas near the exhaust vents also become quite hot. Never locate objects made of plastic or other heat-sensitive materials near or under the projector. Doing so creates the risk of deformation and discoloration of the object.

● Location

Never locate the projector in any of the following types of locations. Doing so creates the risk of fire and electric shock.

- Near an area subject to strong vibration
- An area subject to large amounts of moisture or dust
- In a kitchen or other area exposed to oil smoke
- Near a heater, on a heated carpet, or in an area exposed to direct sunlight
- An area subject to temperature extremes (Operating temperature range is 5°C to 35°C (41°F to 95°F)).

● Heavy objects

Never place heavy objects on the projector or climb on top of the projector. Doing so creates the risk of fire and electric shock.

● Water

Never locate the projector in a bathroom or anywhere else there is the chance that it will be splashed with water.

● Unstable location



Never place the projector on an unstable surface or on a high shelf. Doing so can cause it to fall, creating the risk of personal injury.

● Using the projector on a base with casters

Whenever using the projector on a base that has casters, make sure that you lock the casters when not moving the base.

● Lightening

During a lightening storm, do not touch the plug of the projector's power cord.

● Remote controller



Never try to take the remote controller apart or modify it in any way. Doing so creates the risk of electric shock, burn injury, and other personal injury. Be sure to leave all internal inspection, adjustment, and repair up to your original dealer or authorized CASIO service center.



Never allow the remote controller to become wet. Water creates the risk of fire and electric shock.

● Radio waves emitted by the YW-40 wireless adapter (included or purchased separately)



Never use this product inside of an aircraft or medical facility, or in any other location where use of such devices is prohibited. Radio waves can have an effect on the operation of electronic equipment and medical equipment, and cause accidents.



Do not use this product in the vicinity of high-precision electronic instruments or electronic devices that handle weak radio signals. Radio waves can have an effect on the operation of such equipment, and cause accidents.

- If you are using a pace maker or any other electronic medical device, be sure to consult your physician or device manufacturer before using this product.

● Do not use flammable gas sprays nearby



Do not spray flammable gas into or in the vicinity of the projector. The gas may ignite and create the risk of fire.

Caution

● Power cord



Misuse of the power cord creates the risk of fire and electric shock. Make sure that you always observe the following precautions.

- When unplugging the power cord, always grasp the plug, and do not pull on the power cord.
- Insert the plug into the power outlet as far as it will go.
- After using the projector, unplug it from the power outlet.
- Unplug the projector from the power outlet if you do not plan to use it for a long time.
- At least once a year, unplug the power plug and use a dry cloth or vacuum cleaner to clear dust from the area around the prongs of the power plug.
- Never use detergent to clean the power cord, especially the power plug and jack.
- Before moving the projector, be sure to turn it off and unplug it from the power outlet first.

● Backup of important data



Be sure to keep separate written records of all data stored in projector memory. Memory data can be lost due to breakdown, maintenance, etc.

● During projection, make sure there is nothing in front of the lens blocking the light.

An object in front of the lens creates the risk of fire.

● Lens effect

Never have an aquarium or any other object that produces a lens effect in front of the projector while the light source unit is on. Such an object creates the risk of fire.

● Lens

Never touch the lens with your hand.

● **YW-40 wireless adapter (included or purchased separately)**



Keep the wireless adapter out of the reach of small children. Accidental swallowing of a wireless adapter can interfere with proper breathing and create a life-threatening situation.

Battery Precautions

Danger



Should liquid leaking from an alkaline battery get into the eyes, immediately take the following steps.

1. Do not rub the eyes! Wash the eyes with clean water.
2. Contact a physician immediately. Failure to take immediate action can lead to loss of eyesight.

Warning

Misuse of batteries can cause them to leak and stain the area around them, or to explode, creating the risk of fire and personal injury. Make sure that you always observe the following precautions.



- Never try to take batteries apart and do not allow them to become shorted.
- Never expose batteries to heat or throw them into fire.
- Never mix old batteries and new ones.
- Never mix batteries of different types.
- Never try to charge batteries.
- Take care that batteries are oriented correctly when you load them.



Caution

Misuse of batteries can cause them to leak and stain the area around them, or to explode, creating the risk of fire and personal injury. Make sure that you always observe the following precaution.



- Use only the type of batteries that is specified for the remote controller.

● **Dead batteries**

Be sure to remove batteries from the remote controller as soon as they go dead.



- Remove batteries from the remote controller if you do not plan to use it for a long time.

● **Disposing of batteries**

Make sure that you dispose of used batteries in accordance with the rules and regulations in your local area.

Magnetism



Caution



This projector has a magnet inside. Because of this, it should not be used in the vicinity of anyone wearing a pacemaker or any other electric medical device. Should any problem arise, move the projector away from the person experiencing the problem and consult a physician.



Keep the projector away from floppy disks, magnetic cards, magnetic tapes, prepaid cards, checks, and any other media that uses magnetic recording. The projector can corrupt data recorded on magnetic media.

Other

Caution

Allowing dust to build up inside the projector by not cleaning it for long periods creates the risk of fire and accident, and can cause loss of projection luminosity. Contact your original dealer or authorized CASIO service center once a year about having the interior of the projector cleaned. Note that you will be charged for cleaning.

- **Be sure to follow all applicable local laws and regulations, and do not dismantle the projector when disposing of it.**

Operating Precautions

About the Light Source Unit

- The projector's light source unit uses a laser and LED.
- The life of the light source unit is rated at approximately 20,000 hours. The actual life will depend on use conditions, the settings configured on the setup menu, and differences between each individual light source unit.
- The light source unit is warranted for the period noted on the warranty certificate or for 6,000 hours, whichever comes first.
- The failure of the light source unit to light or a noticeable drop in light source unit brightness indicates the end of the light source unit's life. Contact your original dealer or authorized CASIO service center for replacement. Note that problems caused by unauthorized projector disassembly or modification are not covered by the warranty and are not eligible for repair by CASIO.

Projector Light Emission



- Never look directly into the lens while the light is on. Particular care is required when children are present.



Laser and High Temperature Precautions (See the label on the projector)

Laser Precautions

Non- U.S. Label ①: This projector is a Class 1 laser device that conforms to IEC 60825-1: 2014.

U.S. Label ②: This projector is a Class 2 laser device that conforms to IEC 60825-1: 2007.

- This projector has a built-in laser module. Disassembly or modification is very dangerous and should never be attempted.
- Any operation or adjustment not specifically instructed by the user's guide creates the risk of hazardous laser radiation exposure.

Vent Outlet Precautions (Label ③)

	<ul style="list-style-type: none"> ● Vent outlets become very hot during projection. Never touch vents or allow them to become blocked. ● Do not insert foreign objects.
--	--

Except for USA
クラス 1 レーザー製品
CLASS 1 LASER PRODUCT
IEC 60825-1: 2014

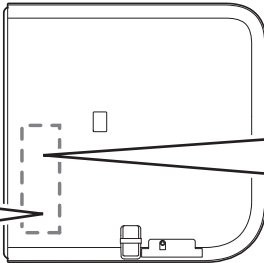

Bottom

⚠️ 高温注意 CAUTION HOT
注意高温 ATTENTION CHAUD
고온주의 VORSICHT HEISS

⚠️ 注意
・内部に異物をいれしないでください。・投映中は、排気口が高温になります。排気口に触れたりおさがないでください。

⚠️ Caution
・Do not insert foreign objects. ・Vent outlets become very hot during projection. Never touch vents or allow them to become blocked.

⚠️ 주의
・내부에 이물질을 넣지 마십시오. ・투영중에는 배기구가 고온이 됩니다. ・절대로 배기구를 만지거나 막지 마십시오.

⚠️ Attention
・Ne pas laisser pénétrer des matières étrangères l'intérieur. ・Les sorties d'air deviennent très chaudes pendant la projection. Ne jamais les toucher ni les obstruer.

⚠️ 注意
・不要让异物混入。・使用过程中投影机的通风口会非常热。切勿触摸通风口或使其被挡住。

⚠️ VORSICHT
・Stecken Sie keine Fremdkörper in das Gerät. ・Die Entlüftungsoffnungen werden bei der Projektion sehr heiß. Berühren oder blockieren Sie die Öffnungen nicht.

For USA
LASER RADIATION
DO NOT LOOK INTO THE
LIGHT SOURCE
CLASS 2 LASER PRODUCT
MAXIMUM OUTPUT POWER: <36mW
WAVELENGTH: 650nm
Complies with 21 CFR Parts 1040.10 and 1040.21 except for deviations pursuant to Laser Notice No.49 dated June 24, 2007

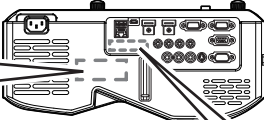

Rear

Label ③

Production Date:
YYYY / MM

Other Precautions

This projector is made of precision components. Failure to observe the following precautions can result in inability to correctly save data and malfunction.

- **Never use or store the projector in the following locations. Doing so creates the risk of malfunction of and damage to the projector.**

- Locations subjected to electrostatic charge
- Locations subjected to temperature extremes
- Locations where there is extreme moisture
- Locations subjected to sudden temperature changes
- Locations where there is a lot of dust
- On a shaky, slanted, or otherwise unstable surface
- Locations where there is the danger of getting wet
- Locations where there are large amounts of oil smoke or other smoke
- Locations where there is the risk of salt damage
- Locations where corrosive gas (such as the sulfur gas at hot springs) is generated

- **Ensure that the remote control signal receiver is not exposed fluorescent light, sunlight, or other strong light. Strong light can cause malfunction.**

- **Avoid using the projector under the following conditions. Such conditions create the risk of malfunction of and damage to the projector.**

- Avoid areas subject to temperature extremes (operating temperature range is 5°C to 35°C (41°F to 95°F)).
- Never place heavy objects on the projector or climb on top of the projector.
- Never insert or allow foreign objects to drop into the projector.
- Never place a vase or any other container of water on top of the projector.

- **Whenever setting the projector down or performing any operation that involves moving or reorienting it, take care that you do not pinch your fingers under the projector.**

- **Never leave dead batteries inside the remote controller for a long time.**

Dead batteries can leak, which leads to malfunction of and damage to the remote controller. Be sure to replace the batteries at least once every one year, no matter how much you use the remote controller during that time.

- **Clean with a soft, dry cloth.**

When very dirty, use a soft cloth that has been dampened in a weak solution of water and a mild neutral detergent. Wring all excess water from the cloth before wiping. Never use thinner, benzine, or any other volatile agent to clean the projector. Doing so can remove its markings and cause staining of the case.

- **Missing Screen Dots**

Though this projector is manufactured using the most advanced digital technology available today, some of the dots on the screen may be missing. This is normal, and does not indicate malfunction.

- **Never subject the projector to strong impact while it is projecting.**

If the projector is accidentally subjected to strong impact, the projection image will momentarily go blank. The image will reappear after some time, but it may be the wrong color or it may be accompanied by an error message.

If the projected image is the wrong color, re-select the current input source. If this does not return the projected image to its proper color, turn projector power off and then back on again.

If the image reappears with an error message, correct the problem in accordance with the indicator explanations under “Error Indicators and Warning Messages” (page 47).

- **Use a power outlet near the projector. Always use the projector so that the power cord can be easily unplugged.**

- **The YW-40 Wireless Adapter (included or purchased separately) supports the 2.4GHz band only.**

- **Keystone Correction and Image Quality**

Performing keystone correction causes the image to be compressed before it is projected. This can result in distortion of the image or a loss of image quality. If this happens, change the orientation of the projector and/or screen so it conforms as much as possible to the illustration under “Setting Up the Projector” (page 19).

If image quality is the highest priority, turn off auto keystone correction and position the projector so it is pointed straight at the screen.

- Even if your projector is still within the warranty period, you will be charged for repair if a problem is due to running the projector non-stop for very long periods (like 24 hours) or if the projector was set up and used without following the “Setup Precautions” (page 19).

- Use under high ambient temperature or in environments subjected to large amounts of dust, oil, smoke, tobacco smoke, or other types of smoke can shorten the replacement cycles and require more frequent replacement of the optical engine and other components. Note that you are charged for such replacement. For details about replacement cycles and fees, contact an authorized CASIO service center.

- **Condensation**

Moving the projector from a cold room to a heated room, turning on a heater in a cold room, and other similar conditions can cause condensation (fogging) to form on the projector lens and/or inside the projector, which will make the projected image appear out of focus and can lead to malfunction and other trouble. If this happens, turn off the projector and wait for a while until the condensation clears naturally. When it does, you will be able to project images normally.

- **Power Supply to External Equipment**

Turning off projector power also cuts power being supplied to external equipment. Note that power being supplied is also cut when the projector is turned off due to restarting by its self-check function or Auto Power Off, due to some error, or for any other reason. Depending on the external equipment being used, cut off of the power supply may cause data that is being edited to be lost or corrupted. Make it a habit to frequently save data on external equipment being powered by the projector. Note that CASIO COMPUTER CO., LTD. shall be held in no way liable for any loss or corruption of data.

Precaution when Handling the Projector after Use

The projector’s exhaust vents and the area around the vents become very hot during operation, and will still be hot immediately after turning off the projector. Because of this, you should hold the projector as shown in the illustration whenever moving it.

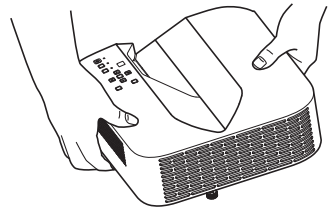

Getting Ready

Unpacking

As you unpack the projector, check to make sure that all of the items listed below are present.

- Projector
- Wireless remote controller YT-131 (XJ-UT311WN, XJ-UT351WN)
- Wireless remote controller YT-160 (XJ-UT331X, XJ-UT351W)
- Test Batteries (AAA-size × 2)
- AC Power Cord
- Cable cover
- “Safety Precautions” Sheet
- “Read this first” Sheet
- Warranty
- Wireless adapter YW-40 (XJ-UT311WN only)

Operation Flow to Projection

This section explains the operational flow up to the point that projection is started.

1. Load the test batteries that come with the projector into the remote controller.

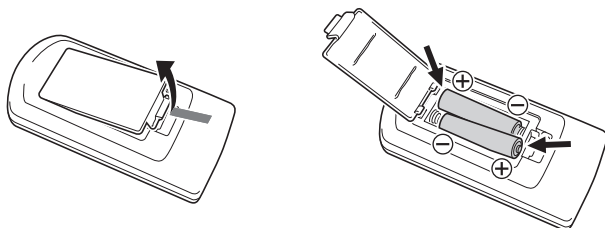

- Use only alkaline batteries to power the remote controller.

2. Place the projector onto a table, desk, or stand that is level and firm, making sure that you allow enough room around it.

- “Safety Precautions” (page 6), “Operating Precautions” (page 12)
- “Setting Up the Projector” (page 19), “Setup Precautions” (page 19)

You will need to purchase special hardware to mount this projector on a wall. For details, contact the retailer where you purchased the projector.

3. Adjust the vertical angle of the projector.

- “To adjust the vertical angle of the projector” (page 19)

4. Use the supplied power cord to plug the projector into a power outlet.

5. Connect the projector to an image output device and/or audio output device, and then turn on each device.

- “Connecting with an External Device” (page 20)

6. Press the [⏻] key to turn on the projector.

- The first time you turn on the projector, a “Language” window will appear in the center of the projection screen. Select the language you want.

7. Use the [INPUT] key to select the input source.

- “Select the input source (INPUT)” (page 24)

8. Use the focus lever to adjust the focus.

- “General Guide” (page 17)

9. Perform keystone correction and adjust brightness as required.

- “Use manual keystone correction (▲/▼) (KEystone)” (page 24), “Light Control” (page 27).

10. After you finish projecting, press the [⏻] key to turn off the projector.



Note

- This product is also designed for IT power distribution system with phase-to-phase voltage 230V.

General Guide

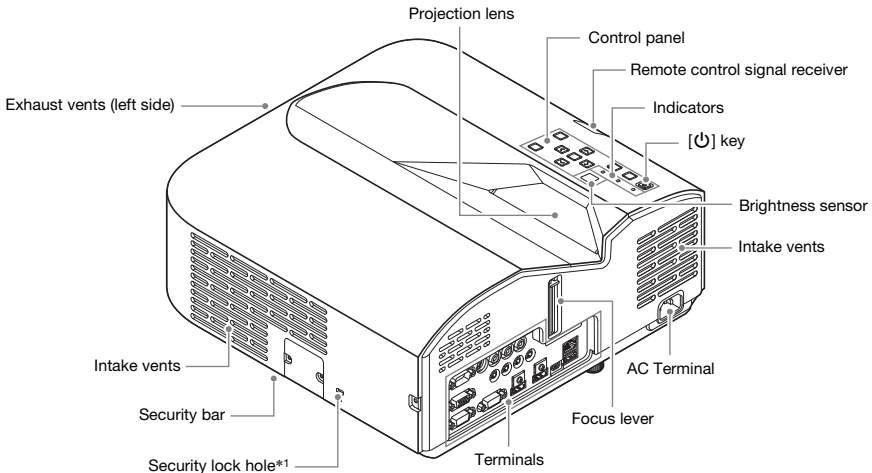

*1 The anti-theft lock hole is provided for connection of an anti-theft chain. Visit the Kensington Lock Website at <http://www.kensington.com/> for more information.

Control Panel and Indicators

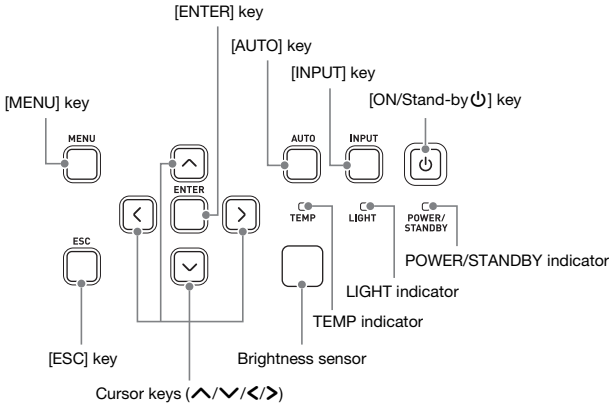

Terminals

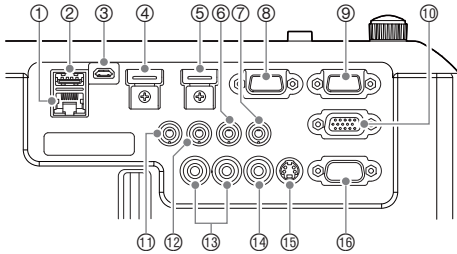

- | | |
|---|--------------------------|
| ① LAN terminal (Network models only) | ⑨ COMPUTER IN 1 terminal |
| ② USB-A (5V/2A) port (XJ-UT311WN, XJ-UT351WN) or DC (5V/2A) port (XJ-UT331X, XJ-UT351W) | ⑩ COMPUTER IN 2 terminal |
| ③ LOGO port | ⑪ MIC terminal |
| ④ HDMI 2 terminal (XJ-UT351W and XJ-UT351WN only) | ⑫ AUDIO OUT terminal |
| ⑤ HDMI 1 terminal | ⑬ AUDIO IN R L terminals |
| ⑥ AUDIO IN 1 terminal | ⑭ VIDEO terminal |
| ⑦ AUDIO IN 2 terminal | ⑮ S-VIDEO terminal |
| ⑧ MONITOR OUT terminal | ⑯ SERIAL port |

Setting Up the Projector

Locate the projector on a desk, table, or stand that is firm and level. Make sure that you allow sufficient space around the sides and back of the projector for proper ventilation. The illustrations below show how the projector should be oriented relative to the screen for optimum projection.

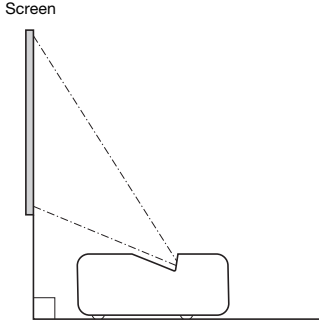

To adjust the vertical angle of the projector

- ① Rotate the single foot on the bottom front of the projector to fine adjust the projector's vertical angle.
- ② Rotate the two feet on the bottom back of the projector to fine adjust the projector's horizontal angle.

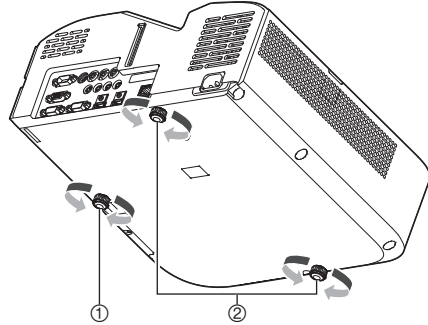

Test Pattern

You can project a test pattern when setting up the projector to help determine the proper image size, projector orientation, etc. For details, see "Test Pattern Projection" on page 28.

Setup Precautions

- Use a conveniently located power outlet that you can reach easily when you need to unplug the projector.
- Maintain a distance of at least 6 cm (2.4 inches) between the front of the projector (from which light is being emitted) and the projection surface (screen). Maintain a distance of at least 30 cm (11.8 inches) between surfaces and the other sides of the projector. There should be no other objects within the above distances from the projector. Particular care is required to keep objects away from projector air intake and exhaust openings.
- Airflow from air conditioning equipment can blow the heat being exhausted from the area around the projector's lens in a way that causes heat ripples to appear in the projected image. If this happens, adjust the airflow of the air conditioning equipment or move the projector.

Connecting with an External Device

Before starting projection, you first need to connect a computer, video device, and/or other external devices to the projector.

- For information about locations of the terminals that correspond to the numbers in the “Projector Terminal” column of the table, see “Terminals” (page 18).
- When a cable is not provided with the projector for a connection, use a commercially available cable. When selecting a cable, make sure that the shapes of its connectors match the shapes of the projector and other equipment terminals.

Connecting to an Image Output Device

You can have multiple image output devices connected to the projector at the same time. Use the projector’s [INPUT] key to select the device whose image you want to project.

Other Device / Terminal Type	Projector Terminal	Projector Terminal Shape	Cable
Computer / RGB Out Terminal	⑨, ⑩	15-pin Mini D-Sub female	RGB
Video Device / Component Video Out Terminal	⑨, ⑩	15-pin Mini D-Sub female	Component video
Video Device / S-Video Out Terminal	⑮	4-pin Mini Din female	S-terminal
Video Device / Composite Video Out Terminal	⑭	RCA pin jack	Pin plug
Computer or Video Device / HDMI Out Terminal	④, ⑤	HDMI Type A female	High Speed HDMI
USB flash drive or other external USB storage device*1	②	USB Type A female	*2
Graphing Calculator / USB Port*3	②	USB Type A female	USB
YW-40 Wireless Adapter (available separately or included)*4	②	USB Type A female	—

*1 Network models only. For information about operation following connection, see “Projecting from USB Input (Network Models Only)” (page 39).

*2 See “Connecting USB Memory Devices to the Projector” (page 40).

*3 Network models only. For information about operation following connection, see “Projecting the Screen Image of a Graphing Calculator” (page 45).

*4 Network models only. For information about operation following connection, see the separate “Network Function Guide”.

Connecting to an Audio Input Device

Other Device / Terminal Type	Projector Terminal	Projector Terminal Shape	Cable
Computer, Video Device, Audio Device, etc. / Audio Out Terminal	⑥, ⑦	Stereo mini jack	Audio
Computer, Video Device, Audio Device, etc. / Audio Out Terminal	⑬	RCA pin jack × 2	Pin plug
Microphone*5	⑪	Stereo mini jack	(microphone)

*5 Plug-in power type microphones are not supported.

Connecting with an External Display and/or External Speaker

Other Device / Terminal Type	Projector Terminal	Projector Terminal Shape	Cable
External Display / Analog RGB In Terminal*6	⑧	15-pin Mini D-Sub female	RGB
External Speaker / Audio In Terminal	⑫	Stereo mini jack	Audio

*6 For details, see “Using the MONITOR OUT Terminal” (page 53).

Other Connections

Other Device / Terminal Type	Projector Terminal	Projector Terminal Shape	Cable
Computer or Router / LAN Terminal*7	①	RJ-45 female	LAN (STP shielded cable recommended.)
Device that can be powered by a USB port connection*8	②	USB Type A female	Power cable for other device, or USB cable
Computer or RS-232C Controller Device / RS-232C Terminal*9	⑯	9-pin D-Sub male	Serial (cross)

*7 Network models only. For details, see the separate “Network Function Guide”.

*8 For details, see “Supplying Power to External Equipment” (page 51).

*9 For details, see “Projector RS-232C Control” (page 57).

Cover Included with the YW-40 Wireless Adapter

Though a separately available YW-40 Wireless Adapter comes with an anti-theft cover, the cover cannot be attached to this type of projector. To protect the wireless adapter against theft while it is connected to the projector, use the cable cover that comes with the projector.

Attaching and Removing the Cable Cover

Before attaching or removing the cable cover, turn off the projector and unplug its power plug from the power outlet. After turning off the projector, wait for a while to allow it to cool.

To attach the cable cover

1. Turn the projector over and insert the cable cover hook into the hole provided on the projector (Figure 1).
2. Rotate the cable cover in the direction indicated by the arrow in Figure 2 to attach it to the projector.
3. Aligning the cable cover screw with the screw hole on the projector (Figure 3), use a Phillips head screw driver to tighten the screw (Figure 4).

To remove the cable cover

1. Use a Phillips head screw driver to loosen the cable cover screw until it disengages from the projector (without detaching it from the cover).
2. Remove the screw side of the cable cover from the projector and then unhook the cover hook from the projector.

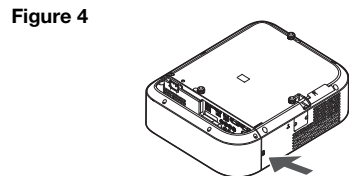
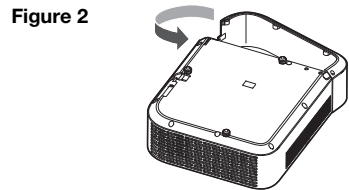
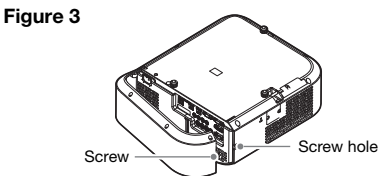
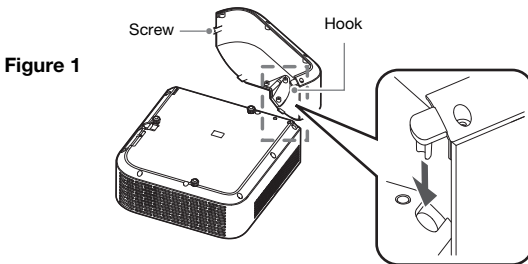

Remote Controller

Projector operations are performed using the remote controller that comes with it. Point the remote controller signal emitter at one of the signal receivers on the projector as you perform remote controller key operations. The maximum range of the remote controller signal is approximately 5 meters (16.4 feet) (between signal emitter and receiver).

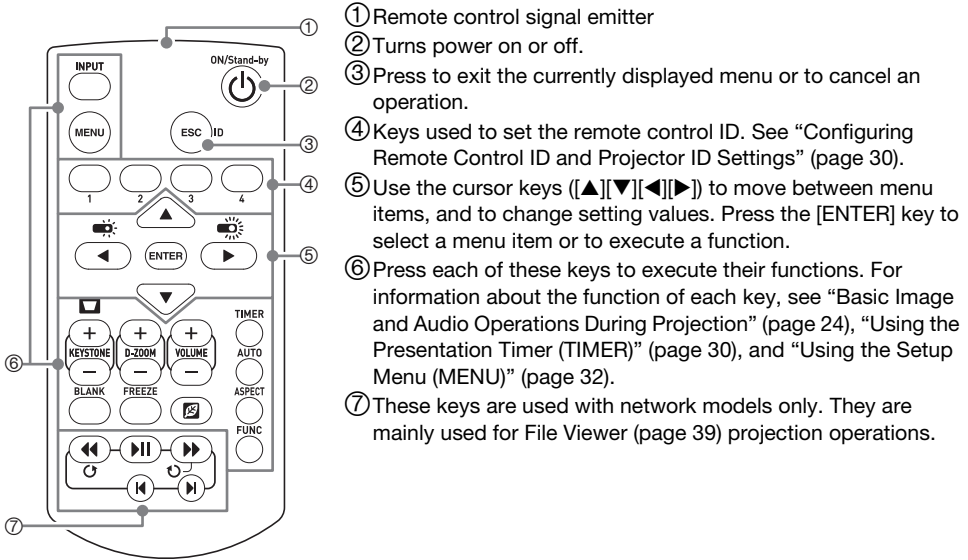

Important!

- To avoid running down the batteries, store the remote control unit so its keys are not pressed inadvertently.

Operating the Projector

Unless specifically noted otherwise, the operations in this section are performed using the remote controller. If both the projector and the remote controller have the same key, either one can be used to perform the corresponding operation.

Basic Image and Audio Operations During Projection

Basic Operation List

To end the operations below, press the [ESC] key.

To do this:	Perform this operation:
Select the input source (INPUT)	<ol style="list-style-type: none">1. Press the [INPUT] key.2. Use the [INPUT], [▲] and [▼] keys to select the input source you want and then press the [ENTER] key.<ul style="list-style-type: none">● If you do not press the [ENTER] key, the projector will automatically apply the currently selected input source after about three seconds.● The name of the input source you selected will appear in the upper right corner of the projection screen for a few seconds. The message “No signal input” will appear if no input signal can be detected. <p>For details about available input sources, see “Input Source Details” (page 26).</p>
Change light brightness	See “Light Control” (page 27).
Use manual keystone correction (▲/▼) (KEYSTONE)	<ol style="list-style-type: none">1. While there is no menu or dialog box displayed on the projection screen, press the projector [▲] or [▼] key, or the remote controller [KEYSTONE +] or [KEYSTONE -] key.2. Use the [▲] and [▼] keys to correct vertical keystone, and the [◀] and [▶] keys to correct horizontal keystone.<ul style="list-style-type: none">● Both vertical and horizontal keystone can be corrected within a range of $\pm 5^\circ$.
Zoom an image (D-ZOOM)	<ol style="list-style-type: none">1. Press the [D-ZOOM +] key to enlarge at the center of the projected image.2. To zoom in on the center of the projected image more, press the [D-ZOOM +] key again. To zoom out, press the [D-ZOOM -] key.3. While an image is zoomed, use the [▲], [▼], [◀], and [▶] keys to scroll the view to other parts of the image.
Momentarily blank the image and mute the audio (BLANK)	<ol style="list-style-type: none">1. Press the [BLANK] key.<ul style="list-style-type: none">● This cuts off the image and audio from the input source, and projects the screen specified by the Setup Menu “Blank Screen” setting (page 34). If “Black” is specified for the “Blank Screen” setting, the projection light will turn off at this time.● Auto Power Off is disabled until the operation in step 2 is performed.2. To restore the image and audio, press the [BLANK], [ESC], or [⏻] key.<ul style="list-style-type: none">● Note that the [⏻] key can be used only when “Black” is selected for the “Blank Screen” setting.
Freeze an image (FREEZE)	<ol style="list-style-type: none">1. Press the [FREEZE] key.<ul style="list-style-type: none">● This freezes the current input source image.2. To return to the real-time input source image, press the [FREEZE] key again or press the [ESC] key.
Auto adjust an image (AUTO)	<ol style="list-style-type: none">1. Press the [AUTO] key.<ul style="list-style-type: none">● This automatically adjusts the frequency and phase in accordance with the input signal, which can reduce flickering and other projected image problems. This operation is supported while the input source is Computer (RGB).

To do this:	Perform this operation:
Change the aspect ratio of the projected image (ASPECT)	<p>1. Press the [ASPECT] key.</p> <ul style="list-style-type: none"> ● Each press of the [ASPECT] key cycles between the aspect ratio settings as shown below. For the meaning of each setting, see “Aspect Ratio Setting Details” (page 26). ● Input source: RGB or HDMI(PC) WXGA models: “Normal” → “Full” → “16:9” → “4:3” → “True” XGA models: “Normal” → “Full” → “16:9” → “16:10” ● Input source: Video, S-Video, Component or HDMI(DTV) WXGA models: “Normal” → “16:9” → “16:10” → “4:3” → “Letter Box” XGA models: “Normal” → “16:9” → “16:10” → “4:3” <p> Important! _____</p> <ul style="list-style-type: none"> ● Note that enlarging or reducing the size of an image using the [ASPECT] key for commercial purposes or public presentation may infringe on the legally protected copyright of the copyright holder of the original material.
Change the color mode (FUNC)	<p>1. Press the [FUNC] key. On the menu that appears, select “Color Mode” and then press the [ENTER] key.</p> <p>2. Use the [▲] and [▼] keys to move the highlighting to the color mode you want to select, and then press the [ENTER] key.</p> <ul style="list-style-type: none"> ● For details on what each color mode does, see “Image Adjustment 1 → Color Mode” (page 32). ● The color mode cannot be selected when “Off” is selected for the “Light Control” setting (page 27).
Adjust the volume level (VOLUME)	<p>1. Press the [VOLUME +] or [VOLUME -] key to display the “Volume” dialog box.</p> <p>2. Press the [VOLUME +] key to increase the volume, or the [VOLUME -] key to lower the volume.</p>
Mute the audio (VOLUME)	<p>1. Press the [VOLUME +] or [VOLUME -] key to display the “Volume” dialog box.</p> <p>2. Press the [ENTER] key to mute the audio.</p> <p>3. To restore the audio, press the [VOLUME +] or [VOLUME -] key.</p>

Aspect Ratio Setting Details

Normal	Projects at the projector's maximum possible size while maintaining the input signal aspect ratio.
Full	Projects at the projector's maximum possible size by enlarging or reducing the input signal.
16:9	This setting specifies a 16:9 aspect ratio, which is the same as a movie screen, high-definition TV, etc. Using this setting when the input signal is a 16:9 image that has been squeezed to a 4:3 image causes the image to be displayed with its normal 16:9 aspect ratio.
16:10	This setting specifies a 16:10 aspect ratio. Use this setting to adjust the image for projection onto a 16:10 aspect ratio screen.
4:3	Regardless of the input signal aspect ratio, the image is always resized to an aspect ratio of 4:3 for projection.
True	Projects each input source dot as a projector output pixel dot. If the input signal resolution exceeds the projector's output resolution, the excess is cut off. When projecting while "True" is selected as the aspect ratio setting for an RGB signal with a resolution that is less than SVGA, the image is enlarged to SVGA and projected.
Letter Box	This will resize the image horizontally to 1280 dots and project 800 vertical dots of the center of the image, maintaining the aspect ratio of the input signal.

For details about how the aspect ratio setting affects the projected image, see "Aspect Ratio Setting and Projection Image" (page 55).

Input Source Details

Selecting an input source with the [INPUT] key to select an input also determines the projector terminal whose image input is projected. This also automatically determines which terminal's audio input will be output by the projector.

Input source selection options are shown in the table below. For information about the terminals that correspond to the numbers in the table, see "Terminals" (page 18).

When this input source is selected:	Images input from this terminal will be output:	Audio input from this terminal will be output (initial default setting):
Computer1 (RGB1)	⑨ COMPUTER IN 1 (RGB signal input)	⑥ AUDIO IN 1
Computer1 (Component 1)	⑨ COMPUTER IN 1 (component signal input)	⑥ AUDIO IN 1
Computer2 (RGB2)	⑩ COMPUTER IN 2 (RGB signal input)	⑦ AUDIO IN 2
Computer2 (Component 2)	⑩ COMPUTER IN 2 (component signal input)	⑦ AUDIO IN 2
S-Video	⑬ S-VIDEO	⑬ AUDIO IN R L
Video	⑭ VIDEO	⑬ AUDIO IN R L
HDMI1	⑤ HDMI 1	⑤ HDMI 1
HDMI2*1	④ HDMI 2	④ HDMI 2
File Viewer*2	② USB-A (connection with USB flash drive or other device)	② USB-A
CASIO USB Tool*2	② USB-A (graphing calculator connection)	⑥ AUDIO IN 1
Network*2	② USB-A (YW-40 Wireless Adapter connection) or ① LAN (wired LAN connection)	② USB-A or ① LAN

*1 XJ-UT351W and XJ-UT351WN only

*2 Network models only

Supported Signals

For information about the signals that are supported by this projector, visit the CASIO website.

Changing the Audio Input

In place of the default audio input terminals shown the rightmost column of the above table, you can assign one of the following terminals for each input source: AUDIO IN 1, AUDIO IN 2, AUDIO IN R L. For details, see “Changing the Audio Input” on page 29.

Resolution

Depending on the projector model, its projection resolution will be fixed at XGA (1024 × 768 pixels) or WXGA (1280 × 800 pixels). Images may appear coarse, text and other figures may be difficult to read or a moire pattern may appear when the input signal from a computer does not match the projector’s projection resolution. If this happens, try doing the following.

- Change the computer’s output resolution setting so it matches the projector’s projection resolution. For information about the projection resolution of your projector, see “Specifications” (page 60). See the user documentation that comes with your computer for details about changing its settings.
- Change the “Aspect Ratio” setting to “True” (Applies only to models that support WXGA projection resolution). With the “True” setting, the projector projects the input signal at its actual size (1 input source dot equal to one projector output pixel dot). For information about configuring the Aspect Ratio setting, see “Change the aspect ratio of the projected image (ASPECT)” (page 25).

Light Control

Light Control lets you adjust the light being output (light source brightness) by the projector. When “On” is selected for “Light Control” (page 35) on the Setup Menu (initial default setting), light output can be adjusted to one of seven levels. Selecting “On” for the Setup Menu “Light Sensor” (page 35) setting will cause light output to be adjusted automatically in accordance with currently available light.



Note

- To project at maximum light source brightness, select “Off” for the “Light Control” setting on the Setup Menu. Selecting “Off” makes it impossible for you to adjust light and also disables the light sensor.

To end the operations below, press the [ESC] key.

To do this:	Perform this operation:
Adjust light output	<ol style="list-style-type: none">1. While there is no menu or dialog box displayed on the projection screen, press the [◀] or [▶] key.<ul style="list-style-type: none">● This displays the current light output level as a value from 1 to 7.2. Use the [◀] and [▶] key to adjust light output.

Digital Screen Shift

You can use the procedures in this section to reduce the size of the projected image while maintaining its aspect ratio and to shift the projection image vertically or horizontally, without physically moving the projector.

To do this:	Perform this operation:
Adjust the projection image size and position	<ol style="list-style-type: none"> 1. Press the [MENU] key to display the setup menu. 2. Select the following in sequence, and then press the [ENTER] key: "Screen Settings", "Digital Screen Shift", "Reposition Digital Screen Shift". <ul style="list-style-type: none"> ● This displays the "Digital Screen Shift" dialog box. 3. Use the [D-ZOOM -] and [D-ZOOM +] keys to adjust the size of the projected image within the range of 84% to 100%. <ul style="list-style-type: none"> ● If a zoom factor that is less than 100% is specified, you can also perform the step 4 and 5 below to reposition the projection image. If 100% is specified, jump to step 5 of this procedure. 4. Use the [▲] and [▼] keys to move the projection image vertically, and the [◀] and [▶] keys to move it horizontally. 5. When everything is the way you want, press the [ESC] key to close the dialog box. Next press [MENU] to close the setup menu.
Return the projection image size and position to their initial defaults	<ol style="list-style-type: none"> 1. Press the [MENU] key to display the setup menu. 2. Select the following in sequence, and then press the [ENTER] key: "Screen Settings", "Digital Screen Shift", "Restore Default Digital Screen Shift". 3. Press the [▲] key, select "Yes", and then press the [ENTER] key.

Test Pattern Projection

You can use the operations below to have the projector project a "No Signal Screen" (page 34) or a "Blank Screen" (page 34) as a test pattern. Use the test pattern when adjusting the parameters of the projection screen (position, size, keystone correction, focus, aspect ratio, Digital Screen Shift, etc.) The test pattern also comes in handy when making fine adjustments after mounting the projector on a wall.

To do this:	Perform this operation:
Specify use of the No Signal Screen for test pattern projection	<ol style="list-style-type: none"> 1. Press the [MENU] key to display the setup menu. 2. Select "Screen Settings", "No Signal Screen", and then use the [◀] and [▶] keys to select "Test Pattern". 3. Press the [MENU] key to close the setup menu.
Specify use of the Blank Screen for test pattern projection	<ol style="list-style-type: none"> 1. Press the [MENU] key to display the setup menu. 2. Select "Screen Settings", "Blank Screen", and then use the [◀] and [▶] keys to select "Test Pattern". 3. Press the [MENU] key to close the setup menu.
Project the Test Pattern	<ul style="list-style-type: none"> ● If settings are configured to project the test pattern when there is no signal, use the [INPUT] key to select an input source that is not sending an input signal to the projector. ● If settings are configured for output of the test pattern when the image is blanked, press the [BLANK] key.



Important!

- Auto Power Off (page 35) is disabled while a test pattern is being projected.

Changing the Audio Input

Selecting an input source causes the projector to output the image from the image input terminal that corresponds to the input source, and the audio from the audio input terminal. Though the input source of each image input terminal is fixed, you can change the initial default audio input terminal to one of the following terminals: AUDIO IN 1, AUDIO IN 2, AUDIO IN R L.

To do this:	Perform this operation:
Change the audio input for a particular input source	<ol style="list-style-type: none">1. Press the [MENU] key to display the setup menu.2. Select "Option Settings 2", "Audio Input", and then press the [ENTER] key.3. Use the [▲] and [▼] keys to select the input source whose audio input setting you want to change.4. Use the [◀] and [▶] keys to select the audio input you want to assign to the selected input source.5. Repeat steps 3 and 4 as required.6. After the settings are the way you want, press the [MENU] key to close the setup menu.
Return audio inputs for all the input sources to their initial default settings	<p>On the setup menu, execute "Option Settings 2" → "Restore Menu Defaults".</p> <ul style="list-style-type: none">● Note that this returns all items included on the "Option Settings 2" menu (not just audio input settings) to their initial default settings.

For details about the audio input terminal initial default settings for each input source, see "Input Source Details" (page 26).

Control Panel Lock

Control panel lock disables (locks) all of the projector's keys, except for the [⏻] key. This limits projector operation to the remote controller, which protects against inadvertent mis-operation.

To do this:	Perform this operation:
Lock the control panel	<ol style="list-style-type: none">1. Press the [MENU] key to display the setup menu.2. Select "Option Settings 2", "Control Panel Lock".3. Use the [◀] key to select "On". When the confirmation dialog box appears, press the [ENTER] key.<ul style="list-style-type: none">● This disables (locks) all projector keys except for the [⏻] key.4. After you are finished, press the [MENU] key to exit the setup menu.
Unlock the control panel	<p>Perform either of the following operations.</p> <ul style="list-style-type: none">● While there is no menu or dialog box displayed on the projection screen, hold down the projector's [▼] key until the message "Control panel was unlocked." appears.● To use the remote controller to unlock the control panel, perform the procedure under "Lock the control panel" above. In step 3, press the [▶] key of the remote controller to select "Off" and then press the [MENU] key.

Configuring Remote Control ID and Projector ID Settings

The remote control ID and projector ID are numbers from 1 to 4. If the two IDs match, you will be able to perform all projector operations from the remote controller. This function helps to avoid remote control conflicts when there are multiple projectors (up to four) in the same area.

The initial factory default setting of both the remote control ID and projector ID is “All”, which means that the remote controller signal can be sent and received regardless of the ID of the sending/receiving device.

The “Specify a remote control ID” operation in the table below can be performed on the remote control unit only. This operation can be performed even if the projector is turned off. For the other operations, first start image projection operation and then perform the operation.

To do this:	Perform this operation:
Specify a remote control ID	While holding down the remote controller [ESC] key, press one of the keys below. <ul style="list-style-type: none">● [1], [2], [3], or [4]: Sets the number of the key you press as the remote control ID.● [MENU]: Changes the remote control ID to “All”.
Specify a projector ID	<ol style="list-style-type: none">1. Press the [MENU] key to display the setup menu.2. Select “Option Settings 1”, “Projector ID”, and then press the [ENTER] key.3. Use the [▲] and [▼] keys to select a number from 1 to 4 or select “All”, and then press the [ENTER] key.
Check the current remote control ID and projector ID settings	While holding down the remote controller [ESC] key, press the [INPUT] key. This will project the remote control ID and projector ID for about 10 seconds. The remote control ID and projector ID shown by this operation may not match each other.

Using the Presentation Timer (TIMER)

The presentation timer shows a countdown from a preset time value. You can use it to keep track of how much time has elapsed during your presentation, and to limit a presentation to a preset amount of time. You can configure the presentation timer so it is displayed in the projected image.

To display the timer

When the timer is not displayed on the projected image, press the [TIMER] key once.

The timer will appear for about five seconds and then disappear automatically if the “Off” is selected for the “Continuous Display” setting on the timer function menu.

To display the timer function menu

When the timer is not displayed on the projected image, press the [TIMER] key twice. If the timer is displayed, press the [TIMER] key once.

To configure timer settings

1. Use the [TIMER] key to display the timer function menu.
2. Use the [▼] and [▲] keys to select the “Position”, “Continuous Display”, or “Start Time” setting and then change the settings as described in the table below.

To do this:	Perform this operation:
Reposition the timer on the projected image	Select “Position”, and then use the [◀] and [▶] keys to select one of the following settings: “Lower Right”, “Upper Right”, “Upper Left”, “Lower Left” (Initial default: Lower Right).
Enable or disable continuous display of the timer	Select “Continuous Display”, and then use the [◀] and [▶] keys to select either “On” or “Off” (Initial default: Off). On: Once the timer is displayed, it remains displayed until you display a different dialog box or you press the [ESC] key. Off: The timer automatically disappears about five seconds after it is displayed.
Specify the timer countdown start time	Select “Start Time”, and then use the [◀] and [▶] keys to specify the countdown start time you want. You can set a start time from five to 60 minutes, in five-minute steps (Initial default: 20 minutes).

3. To save your settings and close the timer function menu, press [ESC].
 - To start the timer immediately after changing its settings, use [▼] and [▲] to select “Start Timer” on the timer function menu and then press the [ENTER] key before pressing [ESC] in the step above.

Timer Operations

Perform all of the operations below while the timer function menu (page 30) is displayed.

To do this:	Perform this operation:
Start a countdown timer operation	Select “Start Timer” and then press the [ENTER] key. <ul style="list-style-type: none">● This will close the timer function menu and start the timer countdown.● After the countdown reaches 00:00, it will start a 60-minute count up operation (from –00:01 to –60:00). The numerals of the timer display are red (indicating that the presentation is over time) during a count up operation.
Pause the timer countdown	Select “Pause Timer” and then press the [ENTER] key.
Resume a paused timer countdown	Select “Restart Timer” and then press the [ENTER] key.
Reset the timer to its start time	Select “Reset Timer” and then press the [ENTER] key. <ul style="list-style-type: none">● This will reset the time to the “Start Time” setting.

Using the Setup Menu (MENU)

Pressing the [MENU] key displays the Setup Menu on the projection screen. You can use this menu to adjust projected image brightness, contrast, and other settings, and to change projector settings.



Setup Menu Settings

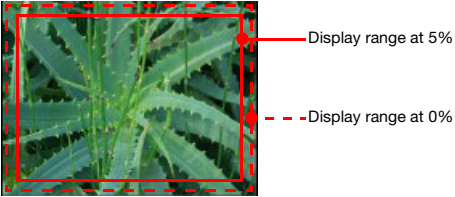

- One or more letters (such as RCV) after the menu item name indicates an item that is available only when one or more particular input source is selected. The letters indicate the input source(s) where the menu item is available.
R: RGB input, **C:** Component input, **V:** S-video input or Video input, **H:** HDMI (PC) input, **D:** HDMI (DTV) input, **F:** File Viewer*¹, **T:** CASIO USB Tool*¹, **N:** Network*¹
¹ Network model projectors only
- A menu item that does not have any letter after it will be available regardless of the input source.
- **N** after a menu item indicates the item is available only on network model projectors.
- The initial default setting is indicated by an asterisk (*).

Use this menu item:	To do this:
Image Adjustment 1 → Brightness	Adjust projected image brightness.
Image Adjustment 1 → Contrast	Adjust projected image contrast.
Image Adjustment 1 → Sharpness (V)	Use this item to adjust the sharpness of the outlines in the projected image. A larger value makes the image sharper, while a smaller value makes it softer.
Image Adjustment 1 → Saturation (V)	Use this item to adjust the color saturation of the projected image. A larger value increases color saturation.
Image Adjustment 1 → Tint (V)	Use this item to adjust the tint of the projected image. A larger value makes the overall image more bluish, while a smaller value makes the overall image more reddish. This setting is supported only when the signal is NTSC or NTSC4.43.
Image Adjustment 1 → Color Mode	Select one of the following projected image color modes: "Standard*", "Graphics", "Theater*", "Blackboard", "Natural".  Note <ul style="list-style-type: none"> ● Initial default setting: "Theater" when the input source is S-Video, Video, Component, or HDMI (DTV). "Standard" any other time.
Image Adjustment 1 → Color Balance	Select one of the following color balance presets: "Warm", "Normal*", "Cold". Also can be used to separately adjust red, green, and blue.
Image Adjustment 1 → Light Control Off Mode	When "Off" is selected for the "Option Settings 1 → Light Control → Light Control" setting, specify either "Bright" (brightness priority) or "Normal*" (hue priority) as the image quality setting.
Image Adjustment 1 → Restore Menu Defaults	Return all of the items in the "Image Adjustment 1" main menu to their initial defaults for the currently projecting image source.

Use this menu item:	To do this:
Image Adjustment 2 → Vertical Position (RCV) Image Adjustment 2 → Horizontal Position (RCV)	Adjust the vertical and horizontal positions of the input source image in relation to the target screen.
Image Adjustment 2 → Frequency (R)	When vertical bands appear in the projected image while RGB is selected as the input source, it means that the frequency setting is not correct. When this happens, use this setting to adjust the frequency manually. If, for some reason, your manual frequency settings cause the image input from the computer to disappear from the projection, you can press the [AUTO] key to perform an auto adjust operation, which should cause the image to appear.
Image Adjustment 2 → Phase (R)	Adjust the phase of the RGB input signal when the image flickers because the projector phase and RGB input signal phase do not match.
Image Adjustment 2 → Overscan (CVD)	<p>Adjust the overscan amount for an input video signal within the range of 0% to 5%*. The size of the border area displayed on the projection screen depends on the setting value. A smaller value results in a wider border area as shown below.</p> 
Image Adjustment 2 → Restore Menu Defaults (RCVD)	Return all of the items in the “Image Adjustment 2” main menu to their initial defaults for the currently projecting image source.
Volume Adjustment → Volume	See “Adjust the volume level (VOLUME)” (page 25) for more information.
Volume Adjustment → Restore Menu Defaults	Return the Volume setting to its initial default for the currently projecting image source.
Screen Settings → Vertical Keystone Correction	Correct vertical keystone of the projected image.
Screen Settings → Horizontal Keystone Correction	Correct horizontal keystone of the projected image.
Screen Settings → Correction Priority	<p>Enable or disable keystone corrected projection image distortion reduction.</p> <p>Shape: Reduces projected image distortion when keystone correction is performed. The resulting projection area will be slightly smaller than normal.</p> <p>Size*: With this setting, the normal projection area size is maintained for a keystone corrected image, but there may be some projected image distortion.</p>
Screen Settings → Aspect Ratio (RCVHD)	<p>Select an aspect ratio setting for the projected image.</p> <p>See “Change the aspect ratio of the projected image (ASPECT)” (page 25) for more information.</p>

Use this menu item:	To do this:
Screen Settings → Projection Mode	Specify whether projection will be from the front of the screen or the back of the screen. Front*: Select this option to project from the front of the screen. Rear: Select this option to project from the back of the screen. This setting flips the front projected image horizontally.
Screen Settings → Ceiling Mount	Set up the projector to be positioned upside down for mounting on a wall. On: Select when the projector is positioned upside down for mounting on a wall. Since the bottom of the projector is upwards, the projected image is flipped both horizontally and vertically. Off*: Select when the projector is used on a desktop. This projects the image assuming that the top of the projector is upwards.
Screen Settings → No Signal Screen	Select one of the following as the projection image whenever there is no input signal being input to the projector: "Blue"* (blue screen), "Black" (black screen), "Logo" (projector built-in logo, or user logo, page 52), "Test Pattern". Also note that selecting "Test Pattern" for this item will cause Auto Power Off to be disabled while a test pattern is being projected when there is no signal.
Screen Settings → Blank Screen	Select one of the following as the projection image whenever the [BLANK] key is pressed: "Blue"* (blue screen), "Black" (black screen), "Logo" (projector built-in logo, or user logo, page 52), "Test Pattern".
Screen Settings → Digital Screen Shift	See "Digital Screen Shift" (page 28).
Screen Settings → Restore Menu Defaults	Return all of the items in the "Screen Settings" main menu to their initial defaults for the currently projecting image source.
Input Settings → COMPUTER1 Terminal/ COMPUTER2 Terminal (RC)	Specify the method to be used to identify the COMPUTER IN 1/COMPUTER IN 2 terminal input signal. Auto*: Projector automatically identifies the COMPUTER IN 1/COMPUTER IN 2 terminal input signal. RGB: Always assumes the COMPUTER IN 1/COMPUTER IN 2 terminal input signal is an RGB signal. Component: Always assumes the COMPUTER IN 1/COMPUTER IN 2 terminal input signal is a component video signal.
Input Settings → RGB1 Level Adjust/RGB2 Level Adjust (R)	"RGB1 Level Adjust" corresponds to the RGB signal output from the COMPUTER IN 1 terminal, while "RGB2 Level Adjust" corresponds to the RGB signal output from the COMPUTER IN 2 terminal. Specifies whether level adjustment of the input RGB signal is enabled (On*) or disabled (Off). Leaving this setting "On" will normally optimize the projected image. However, depending on the input signal, there may be cases when this setting does not optimize the image and may even distort it. If this happens, change this setting to "Off".
Input Settings → Video Signal (V) Input Settings → S-Video Signal (V)	Specify the method to be used to identify the VIDEO terminal input signal. Auto*: Projector automatically identifies the video input signal. NTSC, NTSC4.43, PAL, PAL-M, PAL-N, PAL60, SECAM: Always assumes the video input signal is the specified video signal type.
Input Settings → Signal Name Indicator	Specify whether the newly selected input signal type should be displayed (On*) or not displayed (Off) when the [INPUT] key is pressed to change the input signal.
Input Settings → Restore Menu Defaults	Return all of the items in the "Input Settings" main menu to their initial defaults for the currently projecting image source.

Use this menu item:	To do this:
Option Settings 1 → Auto Adjust (R)	Specify whether the projector should detect the RGB input signal type (resolution, frequency) and adjust the projection image accordingly. On*: Auto Adjust enabled. Off: Auto Adjust disabled.  Note <ul style="list-style-type: none"> ● If you want to retain the following “Image Adjustment 2” menu settings when power is turned off, select “Off” for this setting: “Vertical Position”, “Horizontal Position”, “Frequency”, “Phase”.
Option Settings 1 → Light Control → Light Output	See “Light Control” (page 27).
Option Settings 1 → Light Control → Light Sensor	Enable or disable the light sensor. On: Enables automatic adjustment of light output in accordance with surrounding light. Off*: Disables automatic adjustment of light output.
Option Settings 1 → Light Control → Light Control	Enable or disable projector light output (light source brightness). On*: Enables light output adjustment. Off: Disables light output adjustment and “Light Sensor” (below). This setting must be selected when you want the light source to output at maximum brightness.
Option Settings 1 → Auto Power Off	Specify the amount of time of projector operation and input signal inactivity to be allowed before Auto Power Off is triggered to turn off projector power automatically. Auto Power Off can be disabled, if you want. 5 min, 10 min*, 15 min, 20 min, 30 min: Time until Auto Power off is triggered. Off: Disables Auto Power Off.
Option Settings 1 → Password	See “Password Protection” (page 38).
Option Settings 1 → Direct Power On	Enable (On) and disable (Off*) projector auto power on as soon as the projector’s AC power cord is plugged into a power outlet.
Option Settings 1 → Projector ID	See “Configuring Remote Control ID and Projector ID Settings” (page 30).
Option Settings 1 → Language	Specify the display language. English, French, German, Italian, Spanish, Swedish, Portuguese, Dutch, Norwegian, Polish, Finnish, Czech, Turkish, Russian, Lithuanian, Vietnamese, Thai, Malay, Indonesian, Arabic, Chinese (Simplified), Chinese (Traditional), Korean, Japanese  Important! <ul style="list-style-type: none"> ● Network Model Users When using certain Network model functions, some menus and messages may be displayed in English, regardless of the language selected here.
Option Settings 1 → Restore Menu Defaults	Return all of the items in the “Option Settings 1” main menu to their initial defaults for the currently projecting image source.
Option Settings 2 → Plug and Play 	Specify what the projector should do when a supported external USB device is connected to the projector’s USB-A port or when the projector is turned on while an external USB device is connected to the USB-A port. On: Enables automatic input source switching. Off*: Disables automatic input source switching.

Use this menu item:	To do this:
Option Settings 2 → Audio Out	Use this item to specify whether audio input from the input sources should be output to the speaker (Speaker*) or output to an external destination from the projector's AUDIO OUT terminal.
Option Settings 2 → Audio Input	See "Changing the Audio Input" (page 29).
Option Settings 2 → High Altitude	<p>Turn the high-altitude fan speed setting on or off in accordance with the altitude of the area where you are using the projector.</p> <p>On: Select this setting when using the projector in a high altitude (1,500 to 3,000 meters / 5,000 to 10,000 feet above sea level) area where air is thin. This setting increases cooling efficiency.</p> <p>Off*: Select this setting at normal altitudes (up to 1,500 meters / 5,000 feet).</p> <p> Important!</p> <ul style="list-style-type: none"> ● Do not use this projector at altitudes greater than 3,000 meters (10,000 feet) above sea level.
Option Settings 2 → Control Panel Lock	<p>Disable projector unit key operations.</p> <p>See "Control Panel Lock" (page 29) for more information.</p>
Option Settings 2 → Standby RGB/Audio	<p>Specify output of projector image input to the MONITOR OUT terminal and input audio to the AUDIO OUT terminal while the projector is in standby (projector off with power being supplied). The output image is fixed as the video signal from the projector COMPUTER IN 1 terminal. The output audio is the audio signal from the audio input terminal assigned to "Computer1" of the input source, and the audio signal from the MIC terminal.</p> <p>Output: Select this setting to output video and audio signals while the projector is in standby.</p> <p>No Output*: Select this setting not to output video and audio signals while the projector is in standby.</p> <p> Note</p> <ul style="list-style-type: none"> ● When "Output" is selected for this setting, audio is output from the AUDIO OUT terminal during standby, regardless of the projector's current "Option Settings 2 → Audio Out" setting. ● The video signal input to the projector's COMPUTER IN 2 terminal cannot be output from the MONITOR OUT terminal.
Option Settings 2 → Closed Caption (V)	<p>Use this item to specify whether to display closed captions when projecting a video signal that includes them.</p> <p>Off*: Closed captions not displayed.</p> <p>CC1, CC2, CC3, CC4: Indicates the current closed caption output setting (CC1, CC2, CC3, and CC4).</p>
Option Settings 2 → Timer Function	Display the timer function menu. For details, see "Using the Presentation Timer (TIMER)" (page 30).
Option Settings 2 → Microphone Input Level	Adjusts the volume level of audio input from the MIC terminal within the range of 0* (mute) to 3 (maximum).
Option Settings 2 → Restore Menu Defaults	Return all of the items in the "Option Settings 2" main menu to their initial defaults for the currently projecting image source.

Use this menu item:	To do this:
Multimedia Settings → Autorun N	Specify whether to use (Enable*) or not use (Disable) the autorun function. For details, see “Autorun” (page 43).
Multimedia Settings → Functions N (F)	Display the same menu (Function Menu) that appears when the remote controller’s [FUNC] key is pressed.
Network Settings → Wired LAN info N	Shows information about the current wired LAN connection status (IP address, DHCP setting, etc.)
Network Settings → Wireless LAN Info N	Shows information about the current wireless LAN connection (IP address, DHCP setting, security settings, status of connection with external access point, etc.)
Network Settings → Projector Wired LAN Settings N	Configure the IP address setting.
Network Settings → Projector Wireless LAN Settings N	Displays a dialog box for selecting the SSID and setting the IP address for use when the projector is used as a wireless LAN access point.
Network Settings → Remote On N	Specify whether the projector can be turned on via wired LAN while the projector is in standby (projector off with power being supplied). Enable: Remote on enabled. Disable*: Remote on disabled. Projector standby power consumption depends on whether or not “Remote On” is enabled. For information about power consumption in each standby state, see “Specifications” (page 60).
Network Settings → PJLink Authentication N	Enables and disables PJLink connection authentication. Initial default setting: Enable.
Network Settings → Update Network Settings N	Reflects on the projector changes made to “Projector Wireless LAN Settings”.
Network Settings → Initialize Network Settings N	Returns network settings to their initial factory defaults.
Operational Info	Display the projector information below. Input Signal, Signal Name, Resolution, Horizontal Frequency, Vertical Frequency, Scan System, Audio Input, Projector ID, Light Time, Version (projector ROM version)
Restore All Defaults → Unit Operating Time	Display the cumulative operating time of this unit. This time cannot be initialized.
Restore All Defaults → Restore All Defaults	Initialize all Setup Menu item settings, except for those below. Option Settings 1 → Language, Option Settings 1 → Power On Password, Operational Info → Light Time, Operational Info → Version, Restore All Defaults → Unit Operating Time  Note ● A user logo image that has been transferred to the projector (page 52) is not deleted by a “Restore All Defaults” operation.

Password Protection

The projector can be configured to prompt for input of a password immediately after power is turned on. This prevents unauthorized use of the projector. Note the following precautions whenever you use the password feature.

- The password feature protects against unauthorized use of the projector. Note that it is not an anti-theft measure.
- You will need to enter the initial factory default password the first time you use the projector after turning on the password feature. Change the initial factory default password to a different one of your choice as soon as possible after turning on the password feature.
- The remote controller is required to input the password. Take care to avoid misplacing the remote controller. Replace the remote controller batteries as soon as possible after they start to go low.
- When inputting the password, the remote controller ID and the projector ID must be the same, or either the remote controller ID or projector ID must be set to “All”. For more information, see “Configuring Remote Control ID and Projector ID Settings” (page 30).
- You will not be able to use the projector if you forget its password. We strongly suggest that you keep a written or other type of record of the password so you can look it up when necessary.

To do this:	Perform this operation:
Change the password	<ol style="list-style-type: none"> 1. Press the [MENU] key to display the setup menu. 2. Select “Option Settings 1”, “Password”, and then press the [ENTER] key. 3. Enter the current password, and then press the [ENTER] key. <ul style="list-style-type: none"> ● The password of your projector is a sequence of remote controller key inputs. If the projector is still protected by the factory default password, perform the key operation shown below to enter it. <div style="border: 1px solid black; padding: 5px; text-align: center; margin: 10px 0;"> [▲] [▼] [◀] [▶] [▲] [▼] [◀] [▶] </div> 4. Use the [▼] key to select “Change Password”, and then press the [ENTER] key. 5. Enter a key sequence up to eight key operations long, and then press the [ENTER] key. <ul style="list-style-type: none"> ● You can use any of the following keys as part of your password key sequence. [INPUT], [MENU], [BLANK], [FREEZE], [⏏], [VOLUME +], [VOLUME -], [D-ZOOM +], [D-ZOOM -], [KEystone +], [KEystone -], [▲], [▼], [◀], [▶], [TIMER], [AUTO], [ASPECT], [FUNC] 6. Re-enter the same password key sequence you entered in step 5 and then press the [ENTER] key. <ul style="list-style-type: none"> ● The message “Your new password has been registered.” indicates that the password has been changed. Press the [ESC] key. ● If the password you entered in this step is different from the one you entered in step 5, the message “The password you input is wrong.” appears. Press the [ESC] key to return to step 5.
Change the power on password setting	<ol style="list-style-type: none"> 1. Perform steps 1 through 3 under “Change the password” above and display the Password screen. 2. After confirming that “Power On Password” is selected, use the [◀] and [▶] keys to select either the “On” or “Off” setting. <ul style="list-style-type: none"> ● Changing the setting from “Off” to “On” will cause the “Prompt for password when power is turned on?” dialog box to appear. Press the [ENTER] key to confirm that you want to turn on power on password protection, or the [ESC] key to exit the dialog box without changing the setting. 3. After you are finished, press the [MENU] key to exit the setup menu.

If you forget your password...

You will need to bring the projector and valid identification (original or copy of your employee I.D., driver's license, etc.) to a specified repair service provider. Note that you will be charged to have the password cleared. Having your password cleared using the procedure described above will return all of the settings of your projector, except for the Light Time, to their initial factory defaults.

Projecting from USB Input (Network Models Only)

Use the projector's File Viewer to project the contents of a file on a USB memory device.

Supported Playback Files

File Type	Supported File Conditions
Image File:*1	JPEG: Up to approximately 15 M pixels (baseline JPEG) Up to approximately 8 M pixels (progressive JPEG) PNG: Less than 6 MB and up to approximately 8 M pixels*2 GIF: Less than 6 MB and up to approximately 8 M pixels*2 BMP: Less than 6 MB and up to approximately 8 M pixels (for 24-bit color)
Movie File:*3	AVI: 20 Mbps maximum 720/30P (MJPEG video, ADPCM audio) MOV: 20 Mbps maximum 1080/30P (H.264 video, ADPCM audio or AAC audio) MP4: 20 Mbps maximum 1080/30P (H.264 video, AAC audio)

*1 Even if you are using a WXGA model projector, the maximum projection resolution for image data is 1024 × 768, except for baseline JPEG. In the case of baseline JPEG image data, maximum projection resolution is 1280 × 800.

*2 Transparent colors in PNG and GIF format image files that have transparent colors enabled will all be displayed as black. Animation GIFs are displayed as still images, without animation.

*3 Performing fast forward or fast reverse with a movie file with a large bit rate may cause the operation to be performed at a slower speed than normal or to stop part way through. Though a movie with one of the maximum bit rates shown above will play back normally, fast forward and fast reverse not supported.

Supported USB Memory Devices

Connection of the FAT/FAT32 format memory devices listed below is supported.

- USB flash drive
- Memory cards (A commercially available USB card reader is required to connect a memory card to the projector.)
- USB storage class (USB Mass Storage Class) compatible digital cameras

Use of exFAT and NTFS format memory devices is not supported.

Connecting USB Memory Devices to the Projector

A memory device connects to the USB-A port

This type of memory device:	Connects this way:
USB flash drive	Connect USB flash drive to the projector's USB-A port.
Memory cards	<ol style="list-style-type: none">1. Load the memory card into a USB card reader's card slot.2. Connect the USB card reader to the projector's USB-A port.
Digital cameras	Connect one end of the USB cable to digital camera, and the other end of (Type A connector) to the projector's USB-A port. <ul style="list-style-type: none">● Be sure to refer to the digital camera user documentation for information about how to connect and required settings.

Projecting Files from a USB Memory Device

To do this:	Perform this operation:
Project files from a USB memory device	<ol style="list-style-type: none">1. Connect the memory device to the projector. See "Supported USB Memory Devices" (page 39).2. Press the [INPUT] key as many times as necessary to select "File Viewer" and then press the [ENTER] key.<ul style="list-style-type: none">● This will start up File Viewer and display the File Viewer main screen.3. Use the [▲] and [▼] keys to select "Slide" (image file) or "Movie" (movie file), and then press the [ENTER] key.<ul style="list-style-type: none">● This displays a list of files (image or movie) that corresponds the item you select.4. Use the [▲] and [▼] keys to select the file you want to open and then press the [ENTER] or [▶▶▶] key.<ul style="list-style-type: none">● In the case of an image file, pressing the [ENTER] key will project only one file. Pressing the [▶▶▶] key will start an image file slideshow starting from the currently selected file.● For information about operations that can be performed while projection is in progress, see "Operation During Image File Projection" and "Operation During Movie File Projection" below.
Configuring File Viewer settings	<ol style="list-style-type: none">1. On the File Viewer main screen, select "Viewer Settings" and then press the [ENTER] key.2. Use [▲] and [▼] to select the item whose setting you want to change.3. Use [◀] and [▶] to change the currently selected setting.<ul style="list-style-type: none">● For information about the settings available for each item, see "File Viewer Setting Items" (page 42).4. Repeat steps 2 through 3 as many times as necessary to configure all of the settings you want.

Operation During Image File Projection

To do this:	Perform this operation:
Project the previous image file	Press the [◀] or [◀◀] key.
Project the next image	Press the [▶] or [▶▶] key.
Rotate the image leftwards 90 degrees*1	Press the [◀◀] key.
Rotate the image rightwards 90 degrees*1	Press the [▶▶] key.
Start a slideshow	Press the [▶▶▶] key.
Stop an ongoing slideshow	Press the [▶▶▶] key.

*1 Supported for JPEG files only.

Operation During Movie File Projection

To do this:	Perform this operation:
Pause and resume movie playback	Press the [ENTER] or [▶▶▶] key.
Re-play the file from the beginning	Press the [FUNC] key. On the menu that appears, select "Play from Beginning" and then press the [ENTER] key.
Toggle display of the movie playback time between show and hide	Press the [FUNC] key. On the menu that appears, select "Time Indicator On/Off" and then press the [ENTER] key.
Fast forward at 2X, 8X, or 32X normal speed	Press the [▶] or [▶▶] key. <ul style="list-style-type: none"> The first press starts 2X speed fast forward, the second press increases to 8X, and the third press increases to 32X.
Fast reverse at 2X, 8X, or 32X normal speed	Press the [◀] or [◀◀] key. <ul style="list-style-type: none"> The first press starts 2X speed fast reverse, the second press increases to 8X, and the third press increases to 32X.
Return from fast forward or fast reverse to normal playback	Press the [ENTER] key or [▶▶▶] key.
Jump to the final movie frame	Press the [FUNC] key. On the menu that appears, select "Go to End" and then press the [ENTER] key.
Stop movie file playback and return to the file menu	Press the [ESC] key.

File Viewer Setting Items

The initial default setting for each item is indicated by an asterisk (*).

Setting Name	Description
Display Sequence Setup	Specifies the sequence of images in the file menu. < File Names (Ascending) >*, < File Names (Descending) >*, < File Name Extension (Ascending) >*, < Time (New-to-Old) >*, < Time (Old-to-New) >
Startup Mode	Specifies whether the default view when a mode is entered from the main File Viewer main screen is the "< List View >"* or "< Icon View >".
Thumbnail View	< Show >*: Displays file thumbnails in the file menu. < Hide >: File thumbnails not displayed.
Image Switching	< Manual >*: Specifies manual image scrolling. < Auto >: Specifies auto image scrolling.

Setting Name	Description
Slideshow Display Interval	Specifies how long each image will remain displayed during a slideshow. < 5 seconds >*, < 10 seconds >*, < 30 seconds >*, < 1 minute >*, < 5 minutes >
Slideshow Repeat	< Repeat >: Loops playback of a slideshow or movie. < Repeat Off >*: Automatically stops playback when the end of a slideshow or movie is reached.
Movie Audio Output	< Output >*: Outputs audio when a movie with an audio track is played back. < Do not output >: Audio not output during movie playback.
Initialize Viewer Setup	Returns all File Viewer settings to their initial defaults.

File Menu Operations

To do this:	Perform this operation:
Toggle the file menu between the list view and icon view	Press the [FUNC] key. On the menu that appears, select "Screen Format" and then press the [ENTER] key.
Scroll the file menu	Press the [▶] key to scroll forward, and the [◀] key to scroll back.
Open a folder	Use the cursor keys to move the highlighting to the folder you want to open and then press the [ENTER] key.
Exit the current folder and move up to the next level	Press the [ESC] key.
Return to the main screen from the file menu	Press the [FUNC] key. On the menu that appears, select "Back to top menu" and then press the [ENTER] key.

Autorun

Autorun automatically starts playback of image files or movie files on a USB flash drive when the USB flash drive is connected to projector's USB-A port, or if the projector is turned on while a USB flash drive is connected to the USB-A port. The setup menu settings shown below need to be configured before using Autorun.

- "Multimedia Settings → Autorun" (page 37): Enable
- "Option Settings 2 → Plug and Play" (page 35): On

To do this:	Perform this operation:
Prepare an Autorun USB flash drive	<ol style="list-style-type: none"> 1. Create a folder named "AUTORUNC" (all single-byte upper-case characters) in the root directory of the USB flash drive. 2. Insert all of the image files or movie file you want to auto project into the folder you created in step 1. <ul style="list-style-type: none"> ● If you want to auto project a movie file, place only one movie file into the "AUTORUNC" folder. Do not place any other files into the folder. If there is both a movie file and image file in the "AUTORUNC" folder, the image file will be given priority and the movie file will not be played. ● Multiple image files can be placed in the "AUTORUNC" folder without any problem. If there are, the operation under "Auto project files on a USB Flash drive" below will start a slideshow of the images.
Auto project files on a USB Flash drive	If the projector is turned on, plug the USB flash drive you prepared above into the projector's USB-A port. If the projector is turned off, plug the USB flash drive you prepared above into the projector's USB-A port, and then turn on the projector.

File Viewer Troubleshooting

Problem	Cause and Required Action
File Viewer does not appear when I connect USB flash drive to the projector's USB-A port.	<ul style="list-style-type: none"> ● The USB flash drive you are connecting may have a format that cannot be recognized by the projector. ● If "Off" is selected for the "Option Settings 2 → Plug and Play" setting (page 35), File Viewer will not startup automatically even if a USB flash drive is connected to the projector's USB-A port. If this happens, change the "Plug and Play" setting to "On".
Some folders and/or files are not displayed in the file menu.	All the folders and/or files contained in a folder will not be displayed if there are more than 999 folder and/or files inside the folder. If this happens, reduce the number of folders and/or files in the folder.
When I connect my digital camera to the projector via USB, digital camera memory contents do not appear.	<ul style="list-style-type: none"> ● The digital camera's USB mass storage class setting may not be configured correctly, or you may need to perform some operation on the camera. Consult the user documentation for your digital camera for information about the required settings and operations. ● The digital camera may not support USB mass storage class. If it does not, you will not be able to use Viewer to view digital camera memory contents.
On the Slide Mode file menu, question marks (?) appear in place of thumbnails.	Question marks are displayed in place of thumbnails of images that cannot be projected by File Viewer.

File Viewer Error Messages

Message	Cause and Required Action
Folder does not contain any image files.	There is no displayable folder, or file in the folder you are trying to access with the File Viewer. Use your computer to check the contents of the folder. For details about file formats supported for projector playback, see “Supported Playback Files” (page 39).
Cannot display an image file.	<ul style="list-style-type: none">● You may be trying to play back an image or a movie whose format and/or size is not supported by File Viewer. Check the “Supported Playback Files” (page 39).● There may be an error in the image or movie file itself. Open the image or movie file on your computer and check it.
This movie file cannot be played back.	
This file cannot be played back.	For information about the types of files that can be displayed by File Viewer, see “Supported Playback Files” (page 39).
Could not find an image file.	There is nothing on the connected USB flash drive, or there is some problem with the file system. Use your computer to check the contents of the USB flash drive.

Projecting the Screen Image of a Graphing Calculator

You can connect a CASIO graphing calculator to the projector using a USB cable and project the calculator's screen image with the projector. USB connection of the following CASIO graphing calculators is supported.

- fx-9860G Series, GRAPH 25/35/75 Series
- fx-CG10/20/50 Series, GRAPH 90+E
- ClassPad 330 PLUS
- ClassPad II Series, fx-CG 500

To project the screen image of a graphing calculator

- 1. With the projector turned on, connect its USB-A port to the USB port of the calculator.**
 - To connect, use a USB cable with a Type A connector on one end (projector) and a Type B mini connector on the other end (calculator).
- 2. On the projector, press the [INPUT] key. This will display the "Input" dialog box.**
- 3. Use the [▼] and [▲] keys to select "CASIO USB Tool" and then press the [ENTER] key.**
- 4. On the graphing calculator, perform the operation required for projection.**
 - For details about this operation, refer to the use documentation that comes with your calculator.



Important!

- If the calculator does not operate properly after you connect it to the projector, try disconnecting the USB cable from the calculator and then reconnecting it. If this does not correct the problem, disconnect the USB cable from both the projector and the calculator. Turn the projector off and then back on again, and then re-connect the calculator.

Cleaning the Projector

Make it a habit to clean the projector at regular intervals as described in this section. Before cleaning the projector, be sure to unplug it from the power outlet and make sure it is cooled down completely.

Cleaning the Projector Exterior

Wipe the exterior of the projector with a soft cloth that has been moistened in a weak solution of water and a mild neutral detergent. Be sure to wring all excess moisture from the cloth before wiping. Never use benzene, alcohol, thinner, or any other volatile agent for cleaning.

Cleaning the Lens

Carefully wipe the lens with a commercially available lens cloth or optical lens paper, like those for eyeglasses or camera lenses. When cleaning the lens, do not apply undue force and take care to avoid damaging the lens.

Cleaning Vents

Dust and dirt tend to collect around the intake vents. Because of this, you should use a vacuum cleaner to clean away accumulated dust and dirt periodically (about once a month) as shown below.

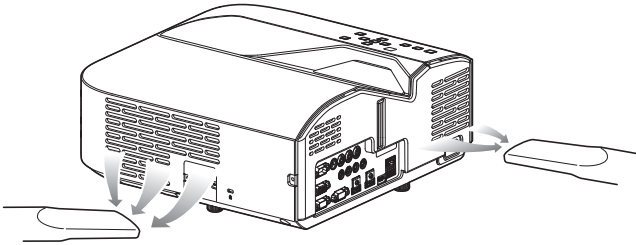

Important!

- Continued use of the projector after dust has accumulated around the intake vents can cause overheating of internal components and lead to malfunction.
- Certain operating conditions also can cause dirt and dust to accumulate around the projector's exhaust vents. If this happens, use the same procedure as that described above to clean the exhaust vents.

Troubleshooting

Indicators

Indicators keep you informed about the current operational status of the projector. The following shows what the indicators look like when operation is normal.

When the indicators appear like this:	It means this:									
<table border="0"> <tr> <td>POWER/ STANDBY</td> <td>LIGHT</td> <td>TEMP</td> </tr> <tr> <td>●</td> <td>●</td> <td>●</td> </tr> <tr> <td>Red</td> <td>Amber</td> <td>Amber</td> </tr> </table>	POWER/ STANDBY	LIGHT	TEMP	●	●	●	Red	Amber	Amber	You have just plugged the AC power cord into a power outlet. Wait until the projector enters the standby state (see below) before trying to turn on power.
POWER/ STANDBY	LIGHT	TEMP								
●	●	●								
Red	Amber	Amber								
<table border="0"> <tr> <td>●</td> <td>○</td> <td>○</td> </tr> <tr> <td>Red</td> <td></td> <td></td> </tr> </table>	●	○	○	Red			Standby state: The AC power cord is plugged in and the projector is in standby.			
●	○	○								
Red										
<table border="0"> <tr> <td>◎</td> <td>●</td> <td>●</td> </tr> <tr> <td>Green</td> <td>Amber</td> <td>Amber</td> </tr> </table>	◎	●	●	Green	Amber	Amber	Projector is warming up after being turned on.			
◎	●	●								
Green	Amber	Amber								
<table border="0"> <tr> <td>●</td> <td>○</td> <td>○</td> </tr> <tr> <td>Green</td> <td></td> <td></td> </tr> </table>	●	○	○	Green			Projector is on and standing by for use. "Off" is selected for the projector's "Light Control" (page 27) setting.			
●	○	○								
Green										
<table border="0"> <tr> <td>●</td> <td>●</td> <td>○</td> </tr> <tr> <td>Green</td> <td>Green</td> <td></td> </tr> </table>	●	●	○	Green	Green		Projector is on and standing by for use. "On" is selected for the projector's "Light Control" setting.			
●	●	○								
Green	Green									
<table border="0"> <tr> <td>◎</td> <td>○</td> <td>○</td> </tr> <tr> <td>Red</td> <td></td> <td></td> </tr> </table>	◎	○	○	Red			Projector is performing internal power down processes.			
◎	○	○								
Red										

● : Lit ◎ : Flashing ○ : Unlit

Error Indicators and Warning Messages

Warning messages and indicators let you know what the problem is when a projector error occurs.

- When an error occurs, wait until the fan stops before unplugging the AC power cord. If you unplug the AC power cord while the fan is still operating, an error may occur when you plug the AC power cord back in.
- Press the [ESC] key to clear the warning message.

Indicator/Error Message	Description and Required Action
POWER : Green steady LIGHT : – TEMP : – Message : Internal temperature is too high. Check projector air vents for blockage.	The projector's internal temperature is very high. Perform the following steps. <ol style="list-style-type: none"> 1. Check for any blocking of the projector's intake vents and exhaust vents, and make sure that there is sufficient space around the projector. See "Setup Precautions" (page 19). 2. If there is dust accumulated around the intake vents and/or exhaust vents, turn off the projector and remove it. See "Cleaning the Projector" (page 46).

Indicator/Error Message	Description and Required Action
POWER : Green steady → Red steady LIGHT : – TEMP : – Message : Internal temperature is too high. The projector will turn off.	Power has turned off automatically due to internal overheating. Perform the following steps. 1. Check for any blocking of the projector's intake vents and exhaust vents, and make sure that there is sufficient space around the projector. See "Setup Precautions" (page 19). 2. If there is dust accumulated around the intake vents and/or exhaust vents, remove it. See "Cleaning the Projector" (page 46). If there is no problem with the projector's vents, confirm that the POWER/STANDBY indicator is lit red (without flashing), and then turn power back on again. If the error occurs again when you turn power back on, contact your retailer or nearest authorized CASIO Service Center.
POWER : Red steady LIGHT : Red steady TEMP : Red steady Message : –	Power has turned off automatically due to a fan problem. Confirm that the POWER/STANDBY indicator is lit red (without flashing) and that the fan has stopped. After checking the POWER/STANDBY indicator, disconnect the power cord from the projector and wait for all of the projector's indicators to go out. Next, reconnect the power cord and turn projector power back on. If the error occurs again when you turn power back on, contact your retailer or nearest authorized CASIO Service Center.
POWER : Red steady LIGHT : – TEMP : Red steady Message : –	Power has turned off automatically due to a system problem. After confirming that the POWER/STANDBY indicator is lit red (without flashing), disconnect the power cord from the projector and wait for all of the projector's indicators to go out. Next, reconnect the power cord and turn the projector back on. If the error occurs again when you turn power back on, contact your retailer or nearest authorized CASIO Service Center.
POWER : Red steady LIGHT : – TEMP : Red steady Message : –	The projector was turned off automatically due to some problem that was probably caused by external digital noise or some other reason. Confirm that the POWER/STANDBY indicator is lit red (without flashing). After checking the POWER/STANDBY indicator, disconnect the power cord from the projector and wait for all of the projector's indicators to go out. Next, reconnect the power cord and turn projector power back on. If the error occurs again when you turn power back on, contact your retailer or nearest authorized CASIO Service Center.
POWER : Red steady LIGHT : Red flashing (0.5-second interval) TEMP : Red flashing (0.5-second interval) Message : –	The projector was turned off automatically because the light source unit turned off or did not turn on. After confirming that the POWER/STANDBY indicator is lit red (without flashing), unplug the power cord. Wait for a short while and then plug it back in and turn on the projector again. If the error occurs again when you turn power back on, contact your retailer or nearest authorized CASIO Service Center.
POWER : Red steady LIGHT : Not lit or red flashing TEMP : Red flashing (2-second interval) Message : –	Power has turned off automatically due to a projector memory error. Confirm that the POWER/STANDBY indicator is lit red (without flashing). After checking the POWER/STANDBY indicator, disconnect the power cord from the projector and wait for all of the projector's indicators to go out. Next, reconnect the power cord and turn projector power back on. If the error occurs again when you turn power back on, contact your retailer or nearest authorized CASIO Service Center.

Projector Troubleshooting

Check the following items whenever you experience any problem with the projector.

Problem	Cause and Recommended Action
Power does not turn on.	<ul style="list-style-type: none"> ● If the POWER/STANDBY indicator is not lit, the AC power cord is not connected correctly. Connect the AC power cord correctly. ● If the TEMP or LIGHT indicator remains flashing or lit, it means some type of error has occurred. See “Error Indicators and Warning Messages” (page 47).
No image is projected or the projected image is abnormal.	<ul style="list-style-type: none"> ● The computer or video device connected to the projector is not turned on or it is not outputting a video signal. Make sure the connected computer or video device is turned on, and perform the required operation on it to output a video signal. ● The correct output source is not selected on the projector. On the projector, select the correct input source that corresponds to the connected device. ● Images may not project correctly when you have the component output terminal of a video device connected to the COMPUTER IN (1 or 2) terminal of the projector. Connect to the VIDEO or S-VIDEO terminal.
Image color or display is very abnormal.	<p>The wrong option (“Component” or “RGB”) may be selected for the “Input Settings → COMPUTER1 Terminal (or COMPUTER2 Terminal)” setting on the setup menu. The image will not be projected correctly if “Component” is selected while the projector’s COMPUTER IN (1 or 2) terminal is connected to the RGB output terminal of a computer, or if “RGB” is selected while the projector’s COMPUTER IN (1 or 2) terminal is connected to the component video output terminal of a video device. On the setup menu, select “Auto” for the “Input Settings → COMPUTER1 Terminal (or COMPUTER2 Terminal)” setting.</p>
I can’t understand messages or menus because they are the wrong language.	<p>Perform the following operation to select the language you want.</p> <ol style="list-style-type: none"> 1. Press the [MENU] key to display the setup menu. 2. If the input signal is HDMI (PC), press [▼] four times and then press the [ENTER] key. If the input signal is not HDMI (PC), press [▼] five times and then press the [ENTER] key. 3. Press [▲] twice and then press the [ENTER] key to display the language selection menu. 4. Use the [▼] and [▲] keys to move the highlighting to the language you want to select and then press the [ENTER] key. 5. Press the [MENU] key to exit the setup menu.
No sound	<ul style="list-style-type: none"> ● The projector’s volume level setting may be too low or muted. Use the remote controller [VOLUME +] and [VOLUME -] keys to adjust the volume level. ● The volume level setting of the device connected to the projector is too low or the other device is not outputting audio. Adjust the volume level of the connected device. ● Audio output of the audio device connected to the audio input terminal assigned to the currently projecting input source may not be connected correctly. For more information, see “Input Source Details” (page 26) and “Changing the Audio Input” (page 29). ● “Line” may be selected for the “Option Settings 2 → Audio Out” setting on the setup menu. Change the “Audio Out” setting to “Speaker”.
Strange color	<p>The input signal may not match projector settings. Try doing the following.</p> <ul style="list-style-type: none"> – Press the [FUNC] key and then select “Brightness” to adjust image brightness. – Press the [FUNC] key and then select “Color Mode” to change the color mode. – On the setup menu, use “Image Adjustment 1 → Color Balance” to adjust the projection image color balance.

Problem	Cause and Recommended Action
Text is blurry.	<ul style="list-style-type: none"> ● The image may be out of focus. Adjust image focus. ● The current frequency and/or phase setting do not match the input signal. (Applies only when the input source is an RGB signal.) Press the [AUTO] key to execute an automatic adjustment operation. ● On the setup menu, perform the “Image Adjustment 2 → Frequency” and “Image Adjustment 2 → Phase” adjustments. (Applies only when the input source is an RGB signal.)
The message “Please input the password.” appears and further operation is not possible.	The “Option Settings 1 → Power On Password” setting on the setup menu is turned on, so the projector is password protected. Input the correct password, and then press the [ENTER] key. See page 38. If you are unable to input the password with the remote controller keys, see “The remote controller does not work.” below.
The remote controller does not work.	<ul style="list-style-type: none"> ● The remote controller batteries may be dead. Replace the batteries. ● The remote controller may be too far from the projector. Make sure the remote controller is within about five meters from the projector when performing operations. ● The remote control ID and projector ID may not match. Change the two IDs so they are the same, or change one of the IDs to “All”. For more information, see “Configuring Remote Control ID and Projector ID Settings” (page 30).
The TEMP or LIGHT indicator is flashing or lit.	An error occurred. See “Error Indicators and Warning Messages” (page 47).
The light source unit does not light.	<ul style="list-style-type: none"> ● The light source has been temporarily shut off by pressing the [BLANK] key. Press the [BLANK] or [ESC] key. ● The light source unit has reached the end of its service life or it is malfunctioning. Contact your original dealer or authorized CASIO service center for replacement.
Power suddenly turns off and the projector restarts.	The projector periodically performs a self-check operation. In rare cases, the result of a self-check may cause the projector to restart automatically. This normally does not indicate malfunction, so you can continue using the projector. However, malfunction may be indicated if successive restarts keep occurring. If this happens contact your original dealer or authorized CASIO service center.



Important!

- Try performing the following steps, which may or may not return the projector to normal operation.
 1. Unplug the AC power cord and wait for at least 10 minutes.
 2. Plug the power cord back in and turn the projector back on again.
- If normal operation does not resume after you perform the above steps, take the projector to your retailer or authorized CASIO service center.

Supplying Power to External Equipment

Power can be supplied to external equipment via the USB-A/DC 5V port of an XJ-UT311WN, XJ-UT351WN model projector, or via the DC 5V port of an XJ-UT331X, XJ-UT351W model projector.



Important!

- Turning off projector power also cuts power being supplied to external equipment. Note that power being supplied is also cut when the projector is turned off due to restarting by its self-check function or Auto Power Off, due to some error, or for any other reason. Depending on the external equipment being used, cut off of the power supply may cause data that is being edited to be lost or corrupted. Make it a habit to frequently save data on external equipment being powered by the projector.
- Projector power being turned off by Auto Power Off (page 35) also causes power to external equipment to be cut off. Before starting power supply to external equipment, be sure to select “Off” for the setting “Option Settings 1 → Auto Power Off” to disable Auto Power Off.
- For a list of external equipment whose operation has been confirmed while being powered by the projector, visit the CASIO projector website (<http://world.casio.com/faq/projector/>). Proper operation is not guaranteed for any external device that is not included in the list at the CASIO projector website.
- Though power up to 5V DC 2A can be supplied to other devices not included on the CASIO website, note that doing so may make some functions unavailable on some devices. Before using output from this port to power another device, be sure to check the user documentation of the device and make sure you connect it correctly. Particular care is required when connecting a chargeable battery to this projector’s USB port power supply. Incorrect connection creates the risk of explosion, fire, and smoke.
- Note that CASIO COMPUTER CO., LTD. shall be held in no way liable for any loss or corruption of data stored on an external device connected to this projector’s USB port power supply, or for any damage, smoke generation, or fire occurring on the connected device.



Note

- To temporarily blank projection while maintaining power supply from the projector to external equipment, press the [BLANK] key. For more information, see “Momentarily blank the image and mute the audio (BLANK)” (page 24).

Updating Firmware and Transferring a User Logo

You can perform a procedure on a computer to update the projector's firmware (software in the projector flash ROM). You can also transfer images to the projector to be used as a user logo.

To do this:	Perform this operation:
Update projector firmware	<ol style="list-style-type: none">1. Use a commercially available USB cable to connect the projector's LOGO port to your computer's USB port.2. Visit the CASIO website, refer to the "Projector Firmware Update Guide", and perform the required operation to update.
Transfer a user logo to the projector	<ol style="list-style-type: none">1. Use a commercially available USB cable to connect the projector's LOGO port to your computer's USB port.2. Visit the CASIO website, refer to the "User Logo Transfer Guide", and perform the required operation to update.

Mounting the Projector on a Wall

You can use special wall mounting hardware to mount the projector on a wall. In this configuration, the projector should be mounted with the top of the projector downwards.

For full details, contact the retailer where you purchased the projector.



Important!

- When mounting the projector on a wall, make sure that it is at least one meter away from fire detectors, fire alarms, and other fire protection devices. Locating the projector too close to a fire protection device creates the risk of mis-operation of the device due to warm air exhausted from the projector. Also, avoid locating the projector close to fluorescent lights or other strong light sources. Bright light can shorten the operating range of the remote controller or even make remote control impossible. When selecting a location for the projector, be sure to test for proper operation of the remote controller.
- The vertical and horizontal orientation of the projected image is reversed from normal when the projector is positioned upside down for mounting on a wall. You need to change the setup of the projector in order to correct for this. For details, see "Screen Settings → Ceiling Mount" (page 34) under "Setup Menu Settings".

Using the MONITOR OUT Terminal

The MONITOR OUT terminal of the projector outputs the video signal being input via the COMPUTER IN 1 terminal or COMPUTER IN 2 terminal as-is. This makes it possible to simultaneously output the projection image to another display.



Note

- The signals output from the MONITOR OUT terminal when the projector is turned on depends on the selected input source as shown in the table below.

When this input source is selected:	The video input signal from this terminal is output to the MONITOR OUT terminal:
Computer 1	COMPUTER IN 1
Computer 2	COMPUTER IN 2
Video, S-Video, HDMI1, HDMI2, File Viewer, CASIO USB Tool, Network	The video input signal is output from either Computer 1 or Computer 2, in accordance with the last selected input source (COMPUTER IN 1 terminal or COMPUTER IN 2 terminal).*1

*1 For example, even if the input source is switched from Computer 1 to S-Video, the MONITOR OUT terminal continues output the video input signal from COMPUTER IN 1.

- The projector can be configured to output, from the MONITOR OUT terminal, the video signal input from the COMPUTER IN 1 terminal while the projector is in the standby state. For details, see “Option Settings 2 → Standby RGB/Audio” (page 36).

Projection Distance and Screen Size

The projection distance values below are for reference when setting up the projector.

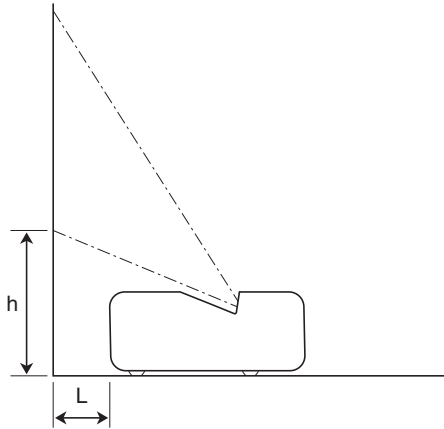

WXGA models

Projection Size		Projection Distance (Distance to projector front): L (cm / inch)	Height from Projector Bottom to Screen Bottom: h (cm / inch)
Screen Size	Diagonal (cm)		
50	127	6 / 2.4	24 / 9.4
60	152	13 / 5.1	27 / 10.6
80	203	27 / 10.6	32 / 12.6
100	254	40 / 15.7	38 / 15
110	279	47 / 18.5	40 / 15.7

XGA models







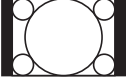
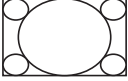
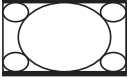

Projection Size		Projection Distance (Distance to projector front): L (cm / inch)	Height from Projector Bottom to Screen Bottom: h (cm / inch)
Screen Size	Diagonal (cm)		
40	102	4 / 1.6	25 / 9.8
50	127	12 / 4.7	28 / 11.0
60	152	20 / 7.9	32 / 12.6
80	203	37 / 14.6	39 / 15.4
100	254	52 / 20.5	45 / 17.7

Aspect Ratio Setting and Projection Image

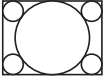
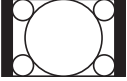
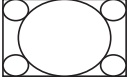
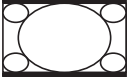
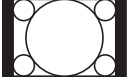
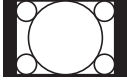
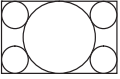
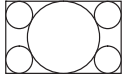
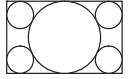

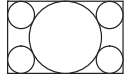

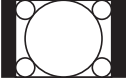
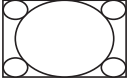
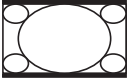
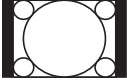

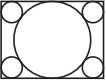
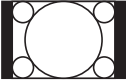
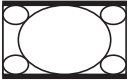
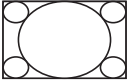
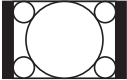
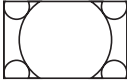
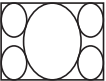

The following shows how images are projected in accordance with the type of the input signal and the aspect ratio setting of the projector.

WXGA models (1280 × 800)

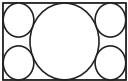
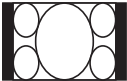
Input source: RGB or HDMI(PC)

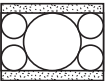
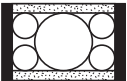
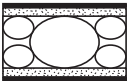
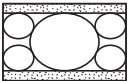
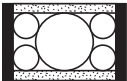
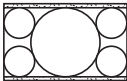
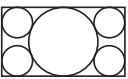

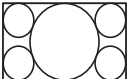



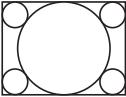
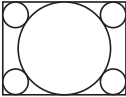
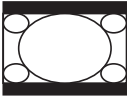

Input Signal	Normal	Full	16:9	4:3	True
 SVGA (800 × 600)					
 XGA (1024 × 768)					
 WXGA (1280 × 800)					
 SXGA (1280 × 1024)					

Input source: Video, S-Video, Component or HDMI(DTV)

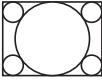
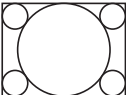
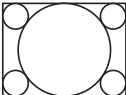

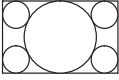
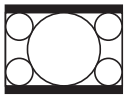
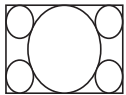

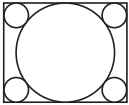
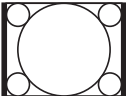
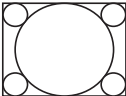



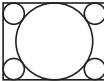
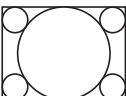

Input Signal	Normal	16:9	16:10	4:3	Letter Box
 4:3 Aspect Image					
 Squeezed Image					
 Letter Box Image					
 16:9 Aspect Image					

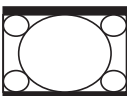
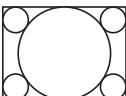
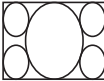
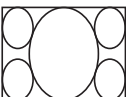
XGA models (1024 × 768)

Input source: RGB or HDMI(PC)

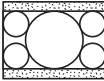
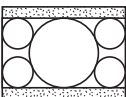
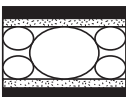
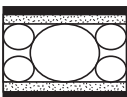
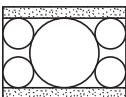
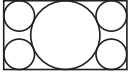
Input Signal	Normal	Full	16:9	16:10
 SVGA (800 × 600)				
 XGA (1024 × 768)				
 WXGA (1280 × 800)				
 SXGA (1280 × 1024)				

Input source: Video, S-Video, Component or HDMI(DTV)

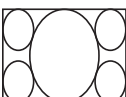
Input Signal	Normal	16:9	16:10	4:3
 4:3 Aspect Image				
 Squeezed Image				
 Letter Box Image				
 16:9 Aspect Image				

Projector RS-232C Control

To control the projector using RS-232C commands from a computer, you need to connect the projector and computer using a commercially available serial cable (cross).

Command Send Format

Communication Protocol	Data Rate: 19200 bps, Data Bit: 8 bit, Parity: None, Stop Bit: 1 bit, Flow Control: None	
Read Command	Send Format	(<command name>?)
	Receive Format	(<applicable command setting range>,<current setting>)
	Command Send Example	<code>[[V O L ?]]</code> sent from the computer to the projector. ↓ <code>[[0-30,15]]</code> returned from the projector to the computer.
Write Command	Send Format	(<command name><setting value>)
	Command Send Example	<code>[[V O L 0]]</code> sent from the computer to the projector. ↓ Projector volume setting becomes 0.

- All commands use ASCII characters and decimal format integers.
- The projector will return a question mark (?) when it is sent a command it cannot recognize. Any setting value that cannot be recognized by the projector will be ignored.
- If the projector is performing a process initiated by a previously sent command, a projector key operation, or a remote controller key operation, send of the next command must wait until the projector completes the previous process.

Command List

- While the projector is turned off, it can receive only following commands: check power on/off state (PWR?), read light time (LMP?), and write power on (PWR1). Do not try to send any other commands to the projector while it is turned off.
- Input of a valid signal must be in progress in order to use a command to turn on blank screen or change the aspect ratio.
- You can use only the commands and settings that are equipped on your projector model.
- Entries in the “Function” column of the table below indicate that a command is read-only (**R**) or write only (**W**).

Command Name	Function	Settings
PWR	Power On/Off	0: Off, 1: On
SRC	Selecting the Input Source:	0: RGB1, 1: Component 1, 2: Video, 3: RGB2, 4: Component 2 6: Auto1 (RGB/Component), 7: HDMI1, 8: Network, 9: S-Video 10: Auto2 (RGB/Component), 11: File Viewer, 13: CASIO USB Tool 14: HDMI2
AIS	Selecting the Audio Input	1: AUDIO IN 1, 2: AUDIO IN 2, 3: AUDIO IN R L, 4: HDMI1 AUDIO IN 5: HDMI2 AUDIO IN, 6: Viewer AUDIO, 7: Network AUDIO
BLK	Blank Screen	0: Off, 1: On
VOL	Volume*1	0 (mute) to 30 (maximum volume)
VLP	W VLP specifies, as a numeric value, how much volume should be increased. VLM specifies how much it should be decreased. For example, to change volume by a factor of 5, send “VLP5” to increase it or “VLM5” to decrease it.	
VLM		
MUT	Mute	0: Off, 1: On
PST	Color Mode	1: Graphics, 2: Theater, 3: Standard, 4: Blackboard, 5: Natural
ARZ	Aspect Ratio	0: Normal*2, 1: 16:9, 2: Normal*2, 3: Letter Box, 4: Full, 5: True 6: 4:3, 7: 16:10
LMP	R Reads the cumulative light time (Returns the number of hours as an integer value.)	
PMD	Light Control	0: Bright*3, 1: Normal*3, 2: Light Sensor On, 3: Light Output 7 4: Light Output 6, 5: Light Output 5, 6: Light Output 4 7: Light Output 3, 8: Light Output 2, 9: Light Output 1
FRZ	Freeze	0: Off, 1: On
KST	Vertical Keystone Correction	0 to 120*4
KSP	W KSP specifies, as a numeric value, how much vertical keystone correction should be increased. KSM specifies how much it should be decreased. For example, to change vertical keystone correction by a factor of 5, send “KSP5” to increase it or “KSM5” to decrease it.	
KSM		
HKS	Horizontal Keystone Correction	0 to 120*4
HKP	W HKP specifies, as a numeric value, how much horizontal keystone correction should be increased. HKM specifies how much it should be decreased. For example, to change horizontal keystone correction by a factor of 5, send “HKP5” to increase it or “HKM5” to decrease it.	
HKM		
KEY	W Executes key press operation.*5	1: ▲, 2: ▼, 3: ◀, 4: ▶, 5: ENTER, 6: ESC, 10: FUNC, 11: MENU 12: POWER, 13: AUTO, 14: INPUT, 15: TIMER, 16: ASPECT 17: BLANK, 18: FREEZE, 19:  , 20: KEYSTONE + 21: KEYSTONE -, 22: D-ZOOM +, 23: D-ZOOM -, 24: VOLUME + 25: VOLUME -, 26: PLAY (▶), 27: REWIND (◀◀) 28: FORWARD (▶▶), 29: PREVIOUS (◀◀), 30: NEXT (▶▶)

Command Name	Function	Settings
POS	Setup Type*6	0: Projection with top of projector upwards, screen in front 1: Projection with top of projector downwards, screen in back 2: Projection with top of projector upwards, screen in back 3: Projection with top of projector downwards, screen in front
APO	Auto Power Off	0: Off, 1: 5 minutes, 2: 10 minutes, 3: 15 minutes, 4: 20 minutes 5: 30 minutes
STS	R Reads the projector error status.	0: Normal, 1: Fan error, 2: Temperature error, 7: Light error 16: Other error
MIC	Microphone Input Level	0 to 3
IDS	Projector ID	0: All, 1: ID1, 2: ID2, 3: ID3, 4: ID4

- *1 This setting is applied to the input source signal that is currently being projected by the projector.
- *2 Setting 0 is the "Normal" setting when the input source is RGB or HDMI(PC), while setting 2 is the "Normal" setting when the input source is component, HDMI(DTV), Video, or S-Video.
- *3 Light Control Off Mode settings.
- *4 The setting range on the projector setup menu is -60 to 60.
- *5 Each KEY command setting corresponds to a remote controller key. The projector operation that is performed in response to a KEY command is identical to the corresponding remote controller key operation. When sending KEY commands to the projector from an external device, make sure they are sent in the same sequence that the corresponding key operations are performed on the remote controller.
- *6 Specifies how the projector is set up relative to screen for projection. Corresponds to the projector setup menu "Projection Mode" and "Ceiling Mount" commands.

Specifications

Model Name		XJ-UT331X	XJ-UT311WN	XJ-UT351W	XJ-UT351WN
Display system		DLP® chip × 1, DLP® system			
Display Chip	Chip Size	XGA 0.55 inches (Aspect ratio: 4:3)	WXGA 0.65 inches (Aspect ratio: 16:10)		
	Number of Pixels	786,432 (1024 × 768)	1,024,000 (1280 × 800)		
Projection Lens		Fixed zoom, manual focus			
		F 2.3 / f 4.2			
Light Source		Laser and LED			
Projected Image Size		40 to 100 inches	50 to 110 inches		
Projection Distance	60 inches	0.20 meters (0.7 feet)	0.13 meters (0.4 feet)		
	100 inches	0.52 meters (1.7 feet)	0.40 meters (1.3 feet)		
	Minimum Projection Distance	0.04 meters (0.1 feet)	0.06 meters (0.2 feet)		
Gamut		Full color (up to 1.07 billion colors)			
Brightness *1 *2		3300 lumens	3100 lumens	3500 lumens	
Contrast Ratio (Full White / Black) *1 *2		20000:1			
Scanning Frequencies	Horizontal	15 to 91 kHz			
	Vertical	50 to 85 Hz			
Display Resolution	RGB Signal	Native: 1024 × 768	Native: 1280 × 800		
		Maximum: 1920 × 1200 resizing			
	Component Signal	Maximum: 1920 × 1080 (HDTV 1080P)			
	HDMI Signal	Maximum: 1920 × 1200 resizing			
	Video Signal	NTSC, PAL, PAL-N, PAL-M, PAL60, SECAM			

Model Name		XJ-UT331X	XJ-UT311WN	XJ-UT351W	XJ-UT351WN
Terminals	RGB Input	COMPUTER terminal: RGB 15-pin mini D-Sub × 2 Used for both RGB input and component (YCbCr/YPbPr) input.			
	Component Input				
	RGB Output	MONITOR OUT terminal: RGB 15-pin mini D-Sub × 1			
	Digital Video Input	HDMI input terminal: HDMI type A terminal × 1 (XJ-UT331X, XJ-UT311WN) / HDMI type A × 2 (XJ-UT351W, XJ-UT351WN), HDCP support, audio signal support			
	Analog Video Input	Composite (RCA) terminal × 1, S-video terminal × 1			
	Audio Input	RCA R/L terminals, 3.5 mm stereo mini jack × 2			
	Audio Output	3.5 mm stereo mini jack × 1			
	Mic Input *3	3.5 mm monaural mini jack × 1			
	USB Host	USB type A × 1 (Network models only)			
	USB Device	Micro-USB type B × 1: For firmware update and logo data registration			
	Control Terminal	RS-232C (D-sub 9 pin) × 1			
	Power Supply Port	DC 5V/2A × 1 (On XJ-UT311WN, XJ-UT351WN, doubles as USB host port.)			
	LAN Terminal	RJ-45 × 1 (Network models only)			
Wireless Support *4		IEEE 802.11b/g/n compatible (Network models only)			
Speaker		16W × 1, Monaural			
Operating Temperature		5 to 35°C (41 to 95°F)			
Operating Humidity		20 to 80% (non-condensation)			
Operating Altitude		0 to 3,000 meters (0 to 10,000 feet) above sea level			
Power Requirements		100 to 240V~(AC), 50/60Hz			
Power Consumption (100 to 240V)					
Light Output 7 when "Light Control" is "On"		170W	160W	185W	
Light Output 1 when "Light Control" is "On"		90W	90W	105W	
When "Bright" is selected for "Light Control Off Mode"		210W	195W	225W	
When "Normal" is selected for "Light Control Off Mode"		180W	170W	200W	
Standby Power Consumption (100 to 120V)					
When "Disable" is specified for "Remote On" *5		0.12W			
When "Enable" is specified for "Remote On" *5		-	1.9W	-	1.9W

Model Name	XJ-UT331X	XJ-UT311WN	XJ-UT351W	XJ-UT351WN
Standby Power Consumption (220 to 240 V)				
When "Disable" is specified for "Remote On" *5	0.23W			
When "Enable" is specified for "Remote On" *5	-	2.3W	-	2.3W
Approximate Dimensions *6	338 (W) × 333 (D) × 153 (H) mm (13.3" × 13.1" × 6") (Including projections)			
Approximate Weight *6	5.7kg (12.6lbs)			

*1 When the "Light Control Off Mode" setting is "Bright". ISO 21118:2012 standard.

*2 Shows overall average value when the projector is shipped from the factory. This type of entry is governed by ISO 21118:2012 data projector specifications. Measurement methods and conditions are based on Appendix 2.

*3 Plug-in power type microphones are not supported.

*4 With connection of wireless adapter YW-40 to USB-A port on the back of the projector.

*5 For information about configuring the Remote On setting, see "Network Settings → Remote On" (page 37).

*6 Excluding cable cover.

Specifications are subject to change without notice.

TCO Certified Document URL

<http://world.casio.com/projector/tco/>

GUIDELINES LAID DOWN BY FCC RULES FOR USE OF THIS UNIT IN THE U.S.A. (not applicable to other areas).

NOTICE

This equipment has been tested and found to comply with the limits for a Class B digital device, pursuant to Part 15 of the FCC Rules. These limits are designed to provide reasonable protection against harmful interference in a residential installation. This equipment generates uses and can radiate radio frequency energy and, if not installed and used in accordance with the instructions, may cause harmful interference to radio communication. However, there is no guarantee that interference will not occur in a particular installation. If this equipment does cause harmful interference to radio or television reception, which can be determined by turning the equipment off and on, the user is encouraged to try to correct the interference by one or more of the following measures:

- Reorient or relocate the receiving antenna.
- Increase the separation between the equipment and receiver.
- Connect the equipment into an outlet on a circuit different from that to which the receiver is connected.
- Consult the dealer or an experienced radio/TV technician for help.

FCC CAUTION

Changes or modifications not expressly approved by the party responsible for compliance could void the user's authority to operate the equipment.

Proper connectors must be used for connection to host computer and/or peripherals in order to meet FCC emission limits.

Connector cable.....XJ-UT331X/XJ-UT311WN/XJ-UT351W/XJ-UT351WN unit to PC

Declaration of Conformity

Model Number: XJ-UT331X/XJ-UT311WN/XJ-UT351W/XJ-UT351WN

Trade Name: CASIO COMPUTER CO., LTD.

Responsible party: CASIO AMERICA, INC.

Address: 570 MT. PLEASANT AVENUE, DOVER, NEW JERSEY 07801

Telephone number: 973-361-5400

This device complies with Part 15 of the FCC Rules, Operation is subject to the following two conditions: (1) This device may not cause harmful interference, and (2) this device must accept any interference received, including interference that may cause undesired operation.



CASIO COMPUTER CO., LTD.

XJ-UT331X/XJ-UT311WN/
XJ-UT351W/XJ-UT351WN

XJ-UT351W/XJ-UT351WN

FOR CALIFORNIA USA ONLY

Perchlorate Material – special handling may apply.

See www.dtsc.ca.gov/hazardouswaste/perchlorate.

This Class B digital apparatus complies with Canadian ICES-003.

Cet appareil numérique de la classe B est conforme à la norme NMB-003 du Canada.

GPL and LGPL

- (1) This product uses software (This Software) that comes under the GNU General Public License (GPL) and GNU Lesser General Public License (LGPL). In accordance with the GPL and LGPL, the source code of This Software is open source code. Anyone who wishes to view the open source code can do so by downloading it from the CASIO Projector download site. Whenever copying, modifying, or distributing This Software, be sure to do so in accordance with the terms and conditions of the GPL and LGPL.
- (2) This Software is provided “as is” without expressed or implied warranty of any kind. However, this disclaimer does not affect the terms and conditions of the warranty of the product itself (including malfunctions due to This Software).
- (3) For details about the GPL and LGPL that This Software comes under, visit the CASIO website.



Manufacturer:
CASIO COMPUTER CO., LTD.
6-2, Hon-machi 1-chome, Shibuya-ku, Tokyo 151-8543, Japan

Responsible within the European Union:
Casio Europe GmbH
Casio-Platz 1, 22848 Norderstedt, Germany
www.casio-europe.com

CASIO®

CASIO COMPUTER CO., LTD.
6-2, Hon-machi 1-chome
Shibuya-ku, Tokyo 151-8543, Japan

MA1705-B

© 2017 CASIO COMPUTER CO., LTD.

Free Manuals Download Website

<http://myh66.com>

<http://usermanuals.us>

<http://www.somanuals.com>

<http://www.4manuals.cc>

<http://www.manual-lib.com>

<http://www.404manual.com>

<http://www.luxmanual.com>

<http://aubethermostatmanual.com>

Golf course search by state

<http://golfingnear.com>

Email search by domain

<http://emailbydomain.com>

Auto manuals search

<http://auto.somanuals.com>

TV manuals search

<http://tv.somanuals.com>