

User's Guide (Basic Operations)

- Be sure to read the "Safety Precautions" on page E-2 and "Operating Precautions" on page E-6 before trying to use this projector.
- This manual covers only basic operations, including how to set up the projector, basic projector operations, and how to replace the lamp. For more detailed information, see the User's Guide (UsersGuide_English.pdf) on the CD-ROM that comes with the projector.

Contents

Safety Precautions	E-2	Connecting a Computer to the Projector ...	E-17
Operating Precautions	E-6	Connecting to a Standard Video Device ...	E-17
Lamp Handling Precautions.....	E-6	Connecting a USB Device to the Projector	
Lamp Replacement Precautions.....	E-6	(XJ-S35 Only)	E-18
Other Precautions.....	E-7	Turning On the Projector	E-19
Unpacking	E-9	Turning Off the Projector	E-21
Using the User Documentation on the		Projector Basics	E-22
CD-ROM	E-9	Selecting the Input Source.....	E-22
Projector Features and Main Functions	E-10	Adjusting the Projected Image.....	E-22
General Guide	E-10	Keystone Correction (KEYSTONE)	E-23
Remote Controller General Guide	E-12	Using the Setup Menu	E-24
Preparing the Remote Controller.....	E-12	User Maintenance	E-25
Replacing the Remote Controller Battery....	E-13	Cleaning the Projector	E-25
Getting Ready	E-14	Reattaching the Lens Cover	E-26
Setting Up the Projector.....	E-14	Replacing the Lamp	E-26
Setup Precautions	E-15	Troubleshooting	E-30
Adjusting the Projector Elevation Angle	E-16	Indicators	E-30
Rear Projection		Projector Troubleshooting.....	E-35
(From the Back of the Screen).....	E-16	Specifications	E-37

- DLP is a registered trademark of Texas Instruments Incorporated of the United States.
- Microsoft, Windows, Windows NT, Windows XP, the Windows logo, and PowerPoint are registered trademarks or trademarks of Microsoft Corporation in the United States and other countries.
- Apple and Macintosh are registered trademarks of Apple Computer, Inc. of the United States.
- Adobe and Acrobat are registered trademarks of Adobe Systems Incorporated.
- XGA is a registered trademark of IBM Corporation of the United States.
- Other company and product names may be registered trademarks or trademarks of their respective owners.



- The contents of this User's Guide are subject to change without notice.
- Copying of this manual, either in part or its entirety, is forbidden. You are allowed to use this manual for your own personal use. Any other use is forbidden without the permission of CASIO COMPUTER CO., LTD.
- CASIO COMPUTER CO., LTD. shall not be held liable for any lost profits or claims from third parties arising out of the use of this product or this manual.
- CASIO COMPUTER CO., LTD. shall not be held liable for any loss or lost profits due to loss of data caused by malfunction or maintenance of this product, or any other reason.
- The sample screens shown in this manual are for illustrative purposes only, and appear differently from the screens actually produced by the product.

Safety Precautions

Thank you for selecting this CASIO product. Be sure to read these "Safety Precautions" before trying to use it. After reading this User's Guide, keep it in a safe place for future reference.

About safety symbols

Various symbols are used in this User's Guide and on the product itself to ensure safe use, and to protect you and others against the risk of injury and against material damage. The meaning of each of the symbols is explained below.

 Danger	This symbol indicates information that, if ignored or applied incorrectly, creates the risk of death or serious personal injury.
 Warning	This symbol indicates information that, if ignored or applied incorrectly, could possibly create the risk of death or serious personal injury.
 Caution	This symbol indicates information that, if ignored or applied incorrectly, could possibly create the risk of personal injury or material damage.

Icon Examples



A triangle indicates a situation against which you need to exercise caution. The example shown here indicates you should take precaution against electric shock.



A circle with a line through it indicates information about an action that you should not perform. The specific action is indicated by the figure inside the circle. The example shown here means disassembly is prohibited.



A black circle indicates information about an action that you must perform. The specific action is indicated by the figure inside the circle. The example shown here indicates you must unplug the power cord from the power outlet.

Precautions During Use



Warning

● Smoke, odor, heat, loud noise, and other abnormalities



Should you ever notice smoke, strange odor, or loud noise being emitted by the projector, or any other abnormality, immediately stop using the projector.

Continued use creates the risk of fire and electric shock. Immediately perform the following steps.

1. Unplug the projector.
2. Contact your original dealer or authorized CASIO service center.

● Malfunction



Immediately stop using the projector if the screen appears abnormal, or if any other abnormal operation occurs even though you are operating the projector correctly. Continued use creates the risk of fire and electric shock. Immediately perform the following steps.

1. Turn off the projector.
2. Unplug the projector.
3. Contact your original dealer or authorized CASIO service center.

● Power cord



Misuse of the power cord creates the risk of fire and electric shock. Make sure that you always observe the following precautions.

- Make sure that you use a power source with the same voltage as that specified for the projector.
- Do not overload a power outlet with too many devices.



A damaged power cord creates the risk of fire and electric shock. Make sure that you always observe the following precautions.

- Never place heavy objects on the power cord and never expose it to heat.
- Make sure the power cord is not pinched between the wall and the rack or table where the projector is located, and never cover the power cord with a cushion or other object.
- Never try to modify the power cord, allow it to become damaged, or subject it to excessive bending.
- Do not twist the power cord or pull on it.



Never touch the power cord or plug while your hands are wet. Doing so creates the risk of electric shock.

- When using this projector in the country where you purchased it, be sure to use the power cord that came with it. Whenever using the projector in another country, be sure to purchase and use a power cord that is rated for the voltage of that country.

● Water and foreign matter



Never allow water to get on the projector. Water creates the risk of fire and electric shock.



Never place a vase or any other container of water on top of the projector. Water creates the risk of fire and electric shock.



Water or other liquid, or foreign matter (metal, etc.) getting into the projector creates the risk of fire and electric shock. Should anything get inside the projector, immediately perform the following steps.

1. Turn off the projector.
2. Unplug the projector.
3. Contact your original dealer or authorized CASIO service center.

● Disassembly and modification



Never try to take the projector apart or modify it in any way. The projector contains a large number of high-voltage components that create the risk of electric shock and burn injury.

Be sure to leave all internal inspection, adjustment, and repair up to your original dealer or authorized CASIO service center.

● Dropping and impact



Continued use of the projector after it has been damaged by dropping or other mistreatment creates the risk of fire and electric shock. Immediately perform the following steps.

1. Turn off the projector.
2. Unplug the projector.
3. Contact your original dealer or authorized CASIO service center.

● Disposal by burning



Never try to dispose of the projector by burning it. Doing so can cause an explosion, which creates the risk of fire and personal injury.

● Looking into the lens or vents while lamp is on



Never look directly into the lens or vents while lamp is on. The strong light emitted by the projector creates the risk of eye damage.

● Blocking the vents



Never allow the intake vents (on the side or back of the projector) or the exhaust vents (on the front of the projector) to become blocked. Doing so causes internal heat build up, which creates the risk of fire and breakdown of the projector. Touching the projector while it is hot creates the risk of burn injury. Make sure that you always observe the following precautions.

- Allow at least 30cm (11.8 inches) between the projector and walls.
- Do not insert the projector into any space where air circulation is poor.
- Never cover the projector with a blanket or any similar item.
- Locate the projector on a firm, flat surface during use. Never use the projector while it is on a carpet, blanket, towel, seat cushion, or other pliable surface.
- Never stand the projector up on either end during use.

● Projector cabinet



Never open the projector's cabinet. Doing so creates the risk of electric shock.

● Cleaning



Before cleaning the projector, be sure to turn it off and unplug it from the power outlet. Failure to do so creates the risk of electric shock.

● Exhaust vents

The exhaust vents become very hot while the projector is running. Never touch them. Doing so creates the risk of burn injury. The areas near the exhaust vents also become quite hot. Never locate objects made of plastic or other heat-sensitive materials near or under the projector. Doing so creates the risk of deformation and discoloration of the object.

● Lens cover

Be sure to open the lens cover before turning on the projector. Never close the lens cover while the projector is in use.

Safety Precautions

● Location

Never locate the projector in any of the following types of locations. Doing so creates the risk of fire and electric shock.

- Near an area subject to strong vibration
- An area subject to large amounts of moisture or dust
- In a kitchen or other area exposed to oil smoke
- Near a heater, on a heated carpet, or in an area exposed to direct sunlight
- An area subject to temperature extremes (Operating temperature range is 5°C to 35°C (41°F to 95°F)).

● Heavy objects

Never place heavy objects on the projector or climb on top of the projector. Doing so creates the risk of fire and electric shock.

● Water

Never locate the projector in a bathroom or anywhere else there is the chance that it will be splashed with water.

● Unstable location



Never place the projector on an unstable surface or on a high shelf. Doing so can cause it to fall, creating the risk of personal injury.

● Using the projector on a base with casters

Whenever using the projector on a base that has casters, make sure that you lock the casters when not moving the base.

● Lightening

During a lightening storm, do not touch the plug of the projector's power cord.

● Remote controller



Never try to take the remote controller apart or modify it in any way. Doing so creates the risk of electric shock, burn injury, and other personal injury. Be sure to leave all internal inspection, adjustment, and repair up to your original dealer or authorized CASIO Service Center.



Never allow the remote controller to become wet. Water creates the risk of fire and electric shock.



Caution

● Power cord



Misuse of the power cord creates the risk of fire and electric shock. Make sure that you always observe the following precautions.

- Do not locate the power cord near a stove.
- When unplugging the power cord, always grasp the plug, and do not pull on the power cord.
- Insert the plug into the power outlet as far as it will go.
- After using the projector, turn it off. After the projector finishes its cool down routine, unplug it from the power outlet.
- Unplug the projector from the power outlet if you do not plan to use it for a long time.
- To avoid the built up of dust between the prongs of the plug, unplug it from the power outlet and clean between the prongs at least once a year.
- Before moving the projector, be sure to turn it off and unplug it from the power outlet first.

● Backup of important data



Be sure to keep separate written records of all data stored in projector memory. Memory data can be lost due to breakdown, maintenance, etc.

● Lens effect

Never have an aquarium or any other object that produces a lens effect in front of the projector while the lamp is on. Such an object creates the risk of fire.

● Lens

Never touch the lens with your hand.

Battery Precautions



Warning

Misuse of a battery can cause it to leak and stain the area around it, or to explode, creating the risk of fire and personal injury. Make sure that you always observe the following precautions.



- Never try to take a battery apart and do not allow it to become shorted.
- Never expose a battery to heat or throw it into fire.
- Never try to charge the battery.
- Take care that the battery is oriented correctly when you load it.



● Button battery



- Keep the button battery out of the reach of small children to make sure it is not swallowed accidentally. Should a button battery ever be swallowed, contact a physician immediately.



Caution

Misuse of a battery can cause it to leak and stain the area around it, or to explode, creating the risk of fire and personal injury. Make sure that you always observe the following precaution.



- Use only the type of battery that is specified for the remote controller.

● Dead battery

Be sure to remove the battery from the remote controller as soon as it goes dead.



- Remove the battery from the remote controller if you do not plan to use it for a long time.

● Disposing of batteries

Make sure that you dispose of used batteries in accordance with the rules and regulations in your local area.

Lamp Precautions



Warning

● Lamp removal



Never remove the lamp from the projector immediately after using it. The lamp becomes very hot during use, creating the risk of burn injury. Turn off the projector. After the POWER/STANDBY indicator changes to steady (not flashing) amber, unplug the projector from the power outlet. Next, wait for at least 60 minutes before removing the lamp.

● Specified lamp type



Use only the lamp type that is specified for this projector. Use of any other type of lamp creates the risk of fire and breakdown.



Caution

● Lamp replacement



Before replacing the lamp, be sure to turn off the projector and unplug it from the power outlet. Failure to do so creates the risk of electric shock.

- Take care when replacing a broken lamp. A broken lamp can cause glass fragments to be scattered inside the lamp housing. Glass inside of the lamp housing may also be discharged from the projector's vent exhaust ports. Gas inside of the lamp includes mercury, so be sure to ventilate the area whenever the lamp breaks. Should you accidentally inhale gas fumes or should gas fumes get into your eyes, immediately contact a physician.

● Broken lamp



Never attempt to replace a broken lamp on your own. The projector uses a mercury lamp with high internal pressure as its light source. Should the lamp break, be sure to contact your original dealer or authorized CASIO service center to request replacement. Attempting to replace a broken lamp on your own creates the risk of personal injury due to broken glass or dispersed mercury.

Other



Caution

Allowing dust to build up inside the projector for long periods without cleaning creates the risk of fire and breakdown. Contact your original dealer or authorized CASIO service center once a year about having the interior of the projector cleaned. Note that you will be charged for cleaning.

Operating Precautions

Lamp Handling Precautions



Caution

Continued use of a lamp that has passed its lamp life increases the risk of the lamp rupturing. Replace the lamp with a new one as soon as possible after the replacement message appears.

- Never touch the glass of the lamp with your fingers. Doing so can damage the lamp and shorten its life.
- The light source lamp is a consumable item. The average life of a lamp is approximately 2000 hours. After 2000 hours, a message appears to alert you to the need of lamp replacement. However, note that the characteristics of a particular lamp or lamp operating conditions can cause the lamp to start to go dim or even fail before the message appears.
- Lamps are guaranteed for 180 days from the date of purchase or for 500 hours operation, whichever comes first.
- A mercury lamp with high internal pressure is used as the light source. A lamp that is weakened by impact, damage, or expiration of its lamp life may explode or fail to light if exposed to loud noise. Note that lamp life differs greatly from lamp to lamp, and is affected by conditions under which the lamp is used.
- The replacement message appears and the LAMP indicator flashes red after the lamp life is reached. When this happens, replace the lamp using the instructions provided in this User's Guide.
- If the lamp continues to be used after its lamp life is reached, after 100 hours the projector will enter a cool down state and then go into standby. The projector will not turn on again until you replace the lamp.

Lamp Replacement Precautions

- When the lamp life is reached, the message "It is time to replace the lamp. Use the procedure in the User's Guide to replace the lamp as soon as possible." appears on the display for about 10 seconds, and the LAMP indicator starts to flash red in one-second intervals. Replace the lamp as soon as possible after the message appears or the LAMP indicator flashes.
- Replace the lamp with a special YL-33 replacement lamp, which should be available from your original dealer. Use only the lamp type that is specified for this projector.
- Turn off the projector. After the POWER/STANDBY indicator changes to steady (not flashing) amber, unplug the projector from the power outlet. Next, wait for at least 60 minutes before removing the lamp. Note that the lamp cartridge becomes very hot during normal use and during standby. Handling it when hot creates the risk of burn injury.
- The lamp contains mercury. Dispose of old lamps in accordance with the rules and regulations of your local jurisdiction.
- When replacing the lamp, use the special screwdriver that comes with the YL-33 replacement lamp.

Other Precautions

This projector is made of precision components. Failure to observe the following precautions can result in inability to correctly save data and malfunction.

● **Never use or store the projector in the following locations. Doing so creates the risk of malfunction of and damage to the projector.**

- Locations subjected to electrostatic charge
- Locations subjected to temperature extremes
- Locations where there is extreme moisture
- Locations subjected to sudden temperature changes
- Locations where there is a lot of dust
- On a shaky, slanted, or otherwise unstable surface
- Locations where there is the danger of getting wet

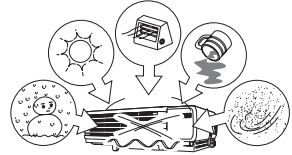

● **Avoid using the projector under the following conditions. Such conditions create the risk of malfunction of and damage to the projector.**

- Avoid areas subject to temperature extremes (operating temperature range is 5°C to 35°C (41°F to 95°F)).
- Never place heavy objects on the projector or climb on top of the projector.
- Never insert or allow foreign objects to drop into the projector.
- Never place a vase or any other container of water on top of the projector.



● **Never leave a dead battery inside the remote controller for a long time.**

A dead battery can leak, which leads to malfunction of and damage to the remote controller.

● **Clean with a soft, dry cloth.**

When very dirty, use a soft cloth that has been dampened in a weak solution of water and a mild neutral detergent. Wring all excess water from the cloth before wiping. Never use thinner, benzene, or any other volatile agent to clean the projector. Doing so can remove its markings and cause staining of the case.

● **Missing Screen Dots**

Though this projector is manufactured using the most advanced digital technology available today, some of the dots on the screen may be missing. This is normal, and does not indicate malfunction.

● **Never subject the projector to strong impact while it is projecting.**

If the projector is accidentally subjected to strong impact, the projection image will momentarily go blank. The image will reappear after some time, but it may be the wrong color or it may be accompanied by an error message.

If the projected image is the wrong color, re-select the current input source. If this does not return the projected image to its proper color, use the procedure under "To turn off the projector" on page E-21 to turn projector power off and then back on again.

If the image reappears with an error message, correct the problem in accordance with the indicator explanations in the "Troubleshooting" guide on page E-30.

● **Keystone Correction and Image Quality**

Performing keystone correction causes the image to be compressed before it is projected. This can result distortion of the image or a loss of image quality. If this happens, change orientation of the projector and/or screen so it conforms as much as possible to the illustration under "Setting Up the Projector" on page E-14.

If image quality is the highest priority, turn off auto keystone correction and position the projector so it is pointed straight at the screen.

Operating Precautions

● Even if your projector is still within the warranty period, you will be charged for repair if a problem is due to running the projector non-stop for very long periods (like 24 hours) or if the projector was set up and used without following the "Setup Precautions" on page E-15 of this manual.

● **Precaution when Handling the Projector after Use**

The exhaust vents on the front of the projector and the top of projector become very hot during operation, and will still be hot immediately after turning off the projector. Because of this, you should hold the sides of the projector as shown in the illustration whenever moving it.

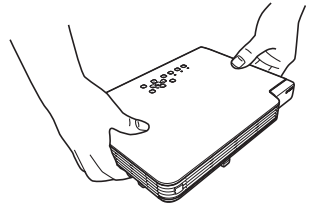

● **Stowing the Projector in the Soft case**

Make sure the projector is no longer warm before stowing it in the soft case.

Unpacking

As you unpack the projector, check to make sure that all of the items listed below are present.

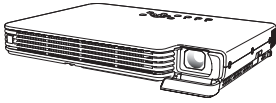

DATA PROJECTOR XJ-S30/XJ-S35



Remote Controller



**Test Battery (CR2025)
(Loaded in remote controller.)**



AC Power Cord



Video Cable



Mini D-Sub Cable

- Soft Cases (projector and cords)
- CD-ROM
- User's Guide (Basic Operations)
- "Read this first" Sheet
- Warranty
- Serial Number Stickers (2) with Barcode

Using the User Documentation on the CD-ROM

The CD-ROM that comes with the projector has a PDF file "User's Guide" that contains detailed explanations about projector operations. The CD-ROM also contains a "USB Function Guide" file, which applies to the XJ-S35.

In order to read the User's Guide, you need to have Adobe® Reader® installed on your computer. If you don't, first double-click the "AdbRdr60_enu_full.exe" file on the CD-ROM to install Adobe Reader (computers running Windows only).

To view the User's Guide contents

1. Place the bundled CD-ROM into your computer's CD-ROM drive.
2. Navigate to the CD-ROM, and open the "User's Guide" folder.
3. Double-click "UsersGuide_English.pdf".
 - This starts up Adobe Reader and displays the contents of the manual whose icon you clicked.
 - On some systems, the ".pdf" extension may not appear at the end of the file name.

NOTE

- If you have the XJ-S35, double-click the file named "USB_Guide_English.pdf" to access the "USB Function Guide".

Projector Features and Main Functions

- **Slim and compact:** An easily portable compact configuration that's a mere 32 millimeters (1.3 inches) thin (at its thinnest point) delivers 2000 ANSI lumens of output. Compact enough to install or use just about anywhere.
- **Wide projection range, from a minimum of 0.84 meters:** Wide angle 2X zoom allows projection even when projector-to-screen distance is severely limited. Minimum projection distance is 1.7 meters, even when projecting onto a 60-inch large screen.
- **A selection of possible input sources:** Computer RGB, composite video, and component video (Y-Cb/P-Cr/Pr) are all supported as input sources.
- **Direct Power On:** The projector can be configured to turn on automatically and start projecting as soon as it is plugged into a power outlet. This eliminates keeping your audience waiting as you perform time-consuming setups.
- **Pointer:** The remote controller can be used to select one of a variety of different pointers for use during projection.
- **Expandability using external USB devices (XJ-S35 only):** A USB port on the XJ-S35 can be used for connection of a USB memory device, a wireless adapter (YW-2S), or a document camera (YC-400 Multi PJ Camera System). Now you can project images from USB memory device, use a wireless controller to project images from your computer screen, or even use a document camera to project images of documents.

General Guide

[Front/Top/Left Side]

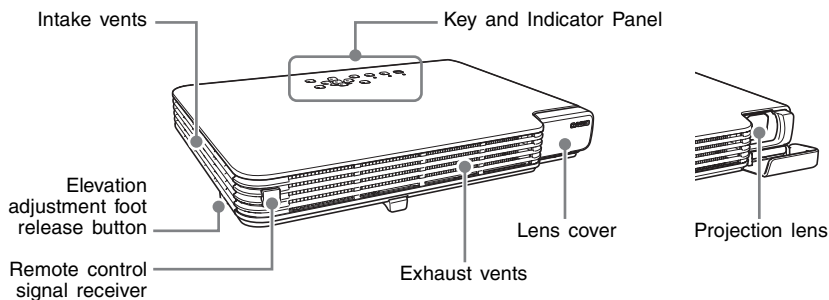

[Key and Indicator Panel]

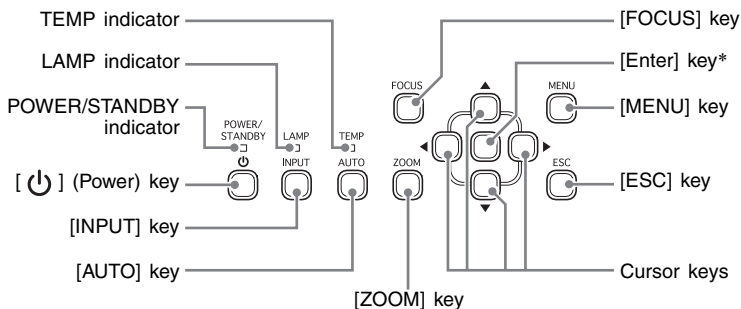

* The projector's enter key does not have anything printed on it. When you see [ENTER] in this manual, it means you should press the projector's enter key or the [ENTER] key of the remote controller.

 <p>Warning</p>	<ul style="list-style-type: none"> ● Never look into the lens while the projector is turned on. ● Never allow the intake and exhaust vents to become blocked, and make sure there is at least 30 cm (11.8 inches) clearance around the projector. Blocked vents can cause heat to build up, creating the risk of fire and malfunction. ● Never touch the areas around the exhaust vents. These areas can become very hot, and create the risk of burn injury.
---	--

[Bottom]

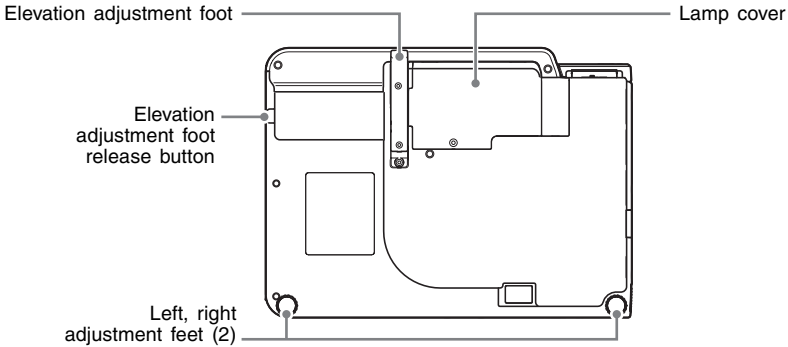

[Back, Terminals]

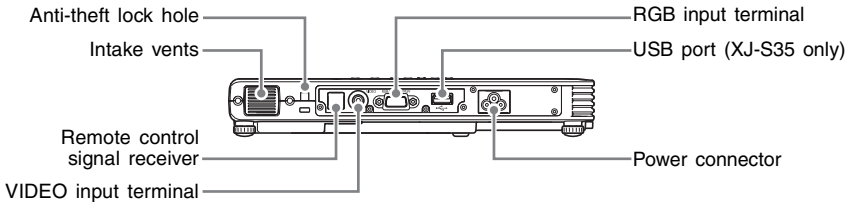

 <p>Warning</p>	<ul style="list-style-type: none"> ● Never allow the intake vents on the side or back of the projector to become blocked. Blocked vents can cause heat to build up, creating the risk of fire and malfunction.
---	---

 **NOTE**

- The anti-theft lock hole is provided for connection of an anti-theft chain. Visit the Kensington Lock Website at <http://www.kensington.com/> for more information.

Remote Controller General Guide

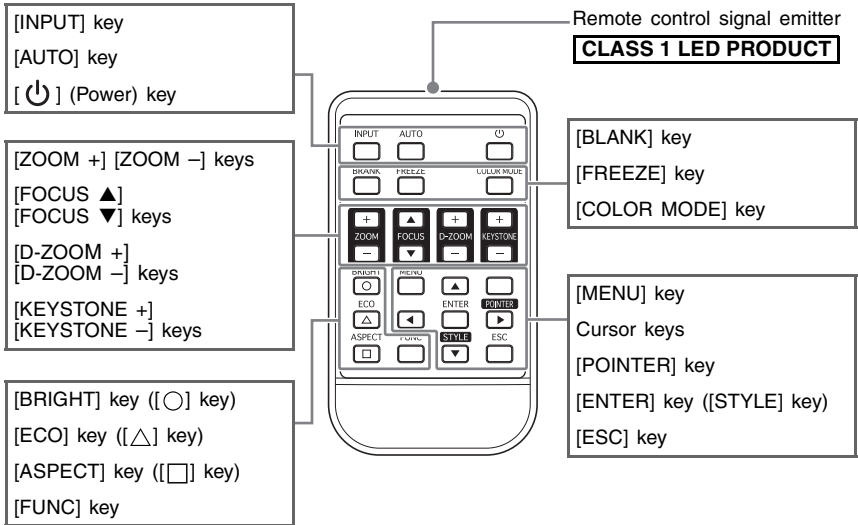

Preparing the Remote Controller

The remote control unit comes loaded with a test battery. Before using it for the first time, remove the battery insulation sheet from the back of the remote controller.

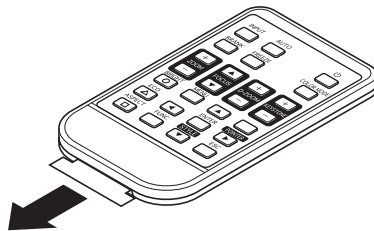



Important!

- To avoid running down the battery, store the remote control unit so its buttons are not pressed inadvertently.

Replacing the Remote Controller Battery

Before you can use the remote controller for the first time, you need to load the battery that comes with it.

 Caution	RISK OF EXPLOSION IF BATTERY IS REPLACED BY AN INCORRECT TYPE. DISPOSE OF USED BATTERIES ACCORDING TO THE INSTRUCTIONS.
--	--

 Caution	Misuse of a battery can cause it to leak and stain the area around it, or to explode, creating the risk of fire and personal injury. Make sure that you always observe the following precautions. <ul style="list-style-type: none"> ● Take care that the battery is oriented correctly when you load it. ● Use only battery type that is specified for use with the remote controller.
--	---

1. Hook your fingernail on the groove of the battery holder on the back of the remote controller. While holding down the release on the side (Ⓢ), pull out the holder (Ⓣ).
2. Place the battery (CR2025) onto the battery holder.
 - Make sure that the plus (+) side of the battery is facing upwards (so you can see it). Take care that you do not install the battery upside down.

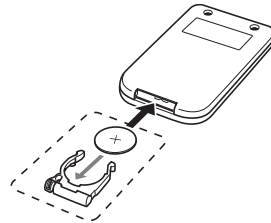
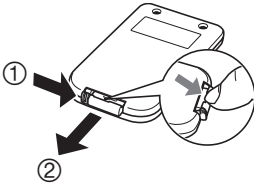

3. Replace the battery holder back into the remote controller.

Getting Ready

Setting Up the Projector

Locate the projector on a desk, table, or stand that is firm and level. Make sure to allow sufficient space around the sides and back of the projector for proper ventilation.

- The following illustrations show how the projector should be oriented for optimum projection relative to the screen.

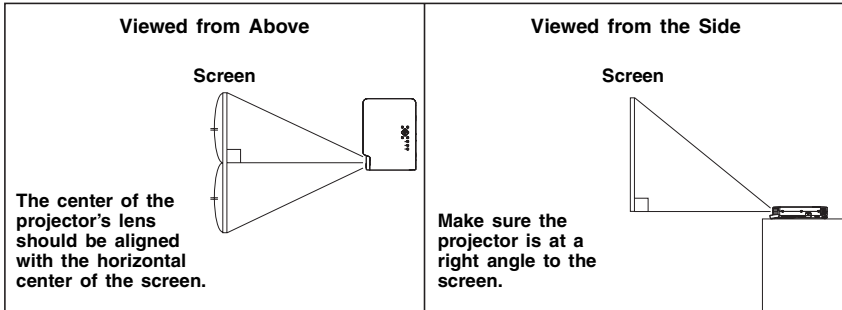

Important!

- You can place the projector on a surface that is angled up to 30 degrees upwards or downwards during use. Never locate the projector on a surface that is angled more than 30 degrees, or angled at all to the left or right. Such conditions can cause the lamp to explode or can shorten lamp life, and also creates the risk of malfunction.

Setup Precautions

Note that the condition of the environment where you use the projector greatly affects its performance. Make sure that the following are the conditions of projector setup whenever you use it.

- Use a conveniently located power outlet that you can reach easily when you need to unplug the projector.
- Do not place any objects within the area indicated by the dashed line in the illustration below. Be especially careful that you never block intake and exhaust vents.

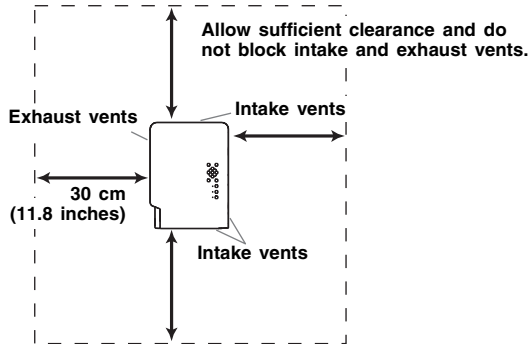

- Do not locate any objects near the projector while it is in use. Keep all items at least 30cm (11.8 inches) away from the intake and exhaust vents.
- The vents become quite hot while the projector is in use. Never touch the vents with your hands. Also, the areas near the exhaust vents become quite hot. Never locate objects made of plastic or other heat-sensitive materials near or under the projector. Doing so creates the risk of deformation and discoloration of the object.
- Avoid placing the projector on a surface that is unstable or prone to vibration. Never place the projector on top of a carpet, blanket, towel, or other soft material.
- Do not locate the projector where it will be exposed to direct sunlight.
- Avoid locations where there are large amounts of dust and moisture.
- Keep the projector away from speakers, TVs, radios, and other devices that generate magnetism, as well as from heaters.
- Over time, use of the projector can cause dust and dirt to build up in and around the fan's intake vents, which can lead to malfunction of the projector. Be sure to check the intake vents for dust build up each time before you use the projector. If you see dirt or dust in or around the intake vents, remove it by wiping with a cloth, etc.
- When positioning the projector, make sure you do so in such a way that the intake vents do not become blocked. Blocked intake vents can shorten the life of the lamp.

Adjusting the Projector Elevation Angle

You can change the elevation angle of the projector in a range of 0 to 12 degrees. You can also make fine adjustments to the left and right side elevation angle when necessary.

To change the projector elevation angle

1. Lift up the front of the projector and press the release button.
 - This causes the elevation adjustment foot to drop from the bottom of the projector.
2. While holding down the release button, raise and lower the front of the projector until the elevation adjustment foot is approximately the length you need.
3. Release the release button to lock the elevation adjustment foot in its current position.
4. Use the left and right adjustment feet to further fine adjust the elevation angle.

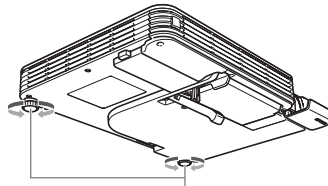
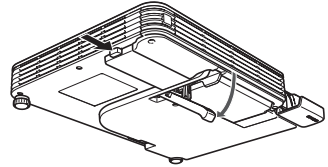

Rotate to adjust horizontal alignment.

Important!

- To retract the elevation adjustment foot, hold down the release button and slide the elevation adjustment foot back into the projector. Never try to forcibly change the elevation adjustment foot position without pressing the release button.

Rear Projection (From the Back of the Screen)

In the case of rear projection, left/right orientation is opposite that of front projection, so you need to configure the setup menu accordingly. For more detailed operation information, see the User's Guide (UsersGuide_English.pdf) on the CD-ROM that comes with the projector.

Connecting a Computer to the Projector

You can use the projector to project an image of video output from a computer.

Important!

- Always turn off the projector and the computer before connecting them.

Projector

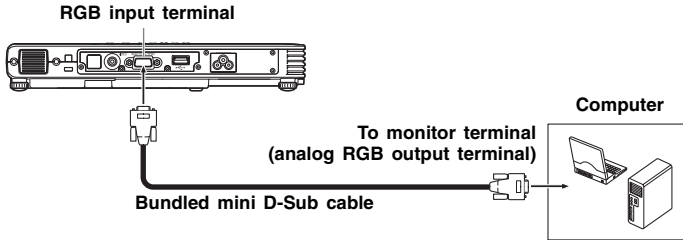

Connecting to a Standard Video Device

You can use the projector to project an image from a video deck, TV, video camera, or other video device.

Important!

- Always turn off the projector and the video device before connecting them.

Projector

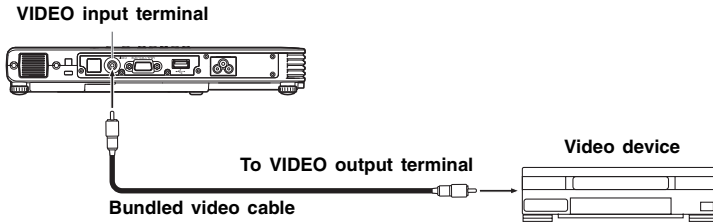

- You can use the bundled video cable to connect to a pin jack (RCA) type VIDEO output terminal. When connecting a video camera or other video device with a special video output terminal, use the special cable that comes with the video device. For details, see the documentation that comes with the video device.

NOTE

- The RGB input terminal can be connected to the component video terminal of video equipment using an optionally available component video cable (YK-3). For more information, see "Connecting to a Component Video Output Device" in the User's Guide (UsersGuide_English.pdf) on the CD-ROM that comes with the projector.

Connecting a USB Device to the Projector (XJ-S35 Only)

If you have an XJ-S35 model projector, you can connect any of the following USB devices to the projector's USB port.

- **USB Memory Device**

You can transfer image and movie data from your computer to a USB memory device* and take it along with you for projection with the XJ-S35. The projector comes with software (EZ-Converter) that converts Microsoft PowerPoint sheets to images, which you can then store to a USB memory device. This means you can include PowerPoint data in your presentations without having to lug a computer along everywhere you go.

* CASIO COMPUTER CO., LTD. makes no guarantees concerning the operation of any particular USB memory device.

- **Wireless Adapter (YW-2S)**

Connecting a YW-2S Wireless Adapter to your computer and projector makes it possible to wirelessly transmit computer images to the projector. You can network up to four computers with a projector.

- **Document Camera (YC-400 Multi PJ Camera System)**

You can connect the YC-400 Multi PJ Camera System directly to the USB port of the XJ-S35 projector and project images of documents without going through a computer.

For details about connecting these USB devices to the XJ-S35 projector and procedures you need to perform to project images from a USB device, see "USB Function Guide" on the bundled CD-ROM.

Turning On the Projector

Before performing any of the operations in this section, make sure you first set up the projector and connect to an output device.

AC Power Cord Precautions

- Use the AC power cord that comes with the projector.
- Make sure that you use a power source with the same voltage as that specified for the projector.
- Do not share the outlet supplying power to the projector with other devices. If you are using an extension cord, make sure that the ampere rating of the extension cord is compatible with the power consumption value of this projector.
- Never use the power cord while it is still bundled together.
- Never place objects on top of the power cord and do not step on it.
- Never pull on the power cord. When unplugging it, grasp the plug.
- Use a conveniently located power outlet that you can reach easily when you need to unplug the projector.
- If you need more information about the power supply, contact your original dealer or authorized CASIO service center.

To turn on the projector

1. Use the bundled AC power cord to plug the projector into a power outlet.
 - Plugging into a power outlet causes the three indicators on the top of the projector to light amber. After a short while, two of the indicators will go out and only the POWER/STANDBY indicator will remain lit amber, which indicates the standby state.
 - Note that the projector will not turn on if you press the [⏻] (power) key while all three indicators are lit amber. Wait until the projector is in the standby state before trying to turn it on.

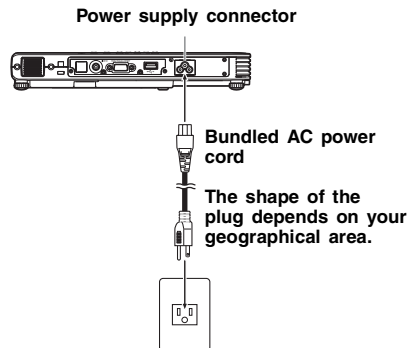

NOTE

- This product is also designed for IT power distribution system with phase-to-phase voltage 230V.

2. Turn on the computer or video device that is connected to the projector.
3. If the projector's lens cover is closed, open it.
4. Press the [⏻] (power) key.
 - This causes the POWER/STANDBY indicator to flash green, which indicates that the projector is warming up.
 - After warm up is complete, POWER/STANDBY indicator stops flashing and remains lit green, and the projector starts projecting an image from the device connected to it.
 - A "Language" window will be projected the first time you turn on the projector. Use the procedure under "Specifying the Display Message Language" on the page E-20 to configure the language settings.

Getting Ready

NOTE

- If the Eco Mode is turned on, the LAMP indicator will light green when warm up starts.
- If the projector is hot when you plug the AC power cord into a power outlet, it will go into a cool down state. The cool down state is indicated by the POWER/STANDBY indicator flashing orange.
Note that the projector will not turn on until cool down is complete, even if you press the [⏻] (power) key.
The projector will turn on and enter the standby state after cool down is complete.
- The password feature lets you limit use of the projector to specific individuals. For more information, see “Option Settings 1 → Power On Password” in the User’s Guide (UsersGuide_English.pdf) on the CD-ROM that comes with the projector.

Specifying the Display Message Language

A “Language” window will be projected the first time you turn on the projector. Use the menu on this screen to specify the display language you want to use.

1. Use the cursor [▲] and [▼] keys to highlight the language you want to use.

Language		
Selecção da linguagem: Inglês	▲/▼: Deslizar	[ENTER]: Aplicar
Sélectionner une langue: Français	▲/▼: Faire défiler	[ENTER]: Appliquer
Wählen Sie eine Sprache: Deutsch	▲/▼: Scrollen	[ENTER]: Anwenden
Seleziona una lingua: Italiano	▲/▼: Scorrimento	[ENTER]: Applicazione
Seleccionar un idioma: Español	▲/▼: Desplazar	[ENTER]: Aplicar
Vali kieli: Svenska	▲/▼: Skrolla	[ENTER]: Tillämpa
選擇語言: 中文(繁體字)	▲/▼: 選擇	[ENTER]: 套用
選擇語言: 中文(簡體字)	▲/▼: 選擇	[ENTER]: 套用
언어: 한국어	▲/▼: 이동	[ENTER]: 적용
言語を選択してください: 日本語	▲/▼: 選択	[ENTER]: 適用
▲/▼: Scroll [ENTER]: Apply		

2. Press the [ENTER] key.

Direct Power On

You can configure the projector so it powers up automatically as soon as you plug it into a power source. With this “Direct Power On” feature, you do not even need to press the [⏻] (power) key. To enable Direct Power On, display the Setup Menu, and then change the “Direct Power On” setting to “On”.

Important!

- When you have Direct Power On enabled, do not leave the projector plugged into an electrical outlet while it is turned off. If you do, there is the chance that it (and the lamp) might turn on automatically when power is restored after being cut off by a power outage, tripping of a breaker, etc.

NOTE

- Direct Power On causes the projector to turn on automatically as soon as it is plugged into a power outlet. This greatly reduces the amount of time it takes until you are ready to start projecting. Note, however, that the actual startup sequence (Standby State → Power On → Warm Up → Projection Starts) that the projector performs is the same, regardless of whether Direct Power On is enabled or disabled. The only difference is what triggers the sequence (plugging in or pressing the [⏻] (power) key). For details about the startup sequence that the projector performs when you plug it into a power source, see “To turn on the projector” on page E-19.
- For details about configuring the Direct Power On setting, see “Direct Power On” under “Option Settings 1 Main Menu” in the “User’s Guide”.

Turning Off the Projector

Caution

- When you turn off the projector, the lamp goes out and the projector goes into a cool down state. Note that you will not be able to turn the projector back on again while it is cooling down.
 - The projector may remain quite hot for a while after you turn it off. Take care when moving the projector or otherwise handling it after use. See “Precaution when Handling the Projector after Use” (page E-8) for more information.
 - Make sure that the projector is cooled down sufficiently before storing it.
-

To turn off the projector

1. Press the [⏻] (power) key.
 - This causes the confirmation message “Do you want to turn off the projector?” to appear in the center of the projection screen.
 - If you do not turn off the projector the confirmation message will disappear automatically after about 10 seconds. The confirmation message will also disappear if you press [ESC] key.
2. To turn off the projector, press the [⏻] (power) key again in response to the confirmation message.
 - This causes the projector lamp to go out and stops projection.
 - Also the POWER/STANDBY indicator starts to flash amber, which indicates that the projector is cooling down.
 - The projector will not turn back on again while it is cooling down.
 - After cool down is finished, the POWER/STANDBY indicator on the top of the projector will light amber, which indicates the standby state. You can now turn the projector back on, if you want.
3. Unplug the AC power cord from the power outlet.
 - This causes the POWER/STANDBY indicator to go out.
4. After ensuring that the projector and the connected computer or video device are turned off, disconnect the connecting cables from the projector and the connected device.
5. Close the lens cover.

Auto Power Off

Auto Power Off automatically turns off the projector whenever there is no input signal, and no operation is performed on the projector for about 30 minutes. When Auto Power Off is triggered, the projector first enters a cool down state, the same as it does when you press the [⏻] (power) key to turn it off.

NOTE

- While Direct Power On (page E-20) is enabled, the projector will turn off automatically if no key operation is performed and no signal input is received within about 10 minutes after it is turned on.
-

Projector Basics

NOTE

- For detailed information about projection operations, see the User's Guide on the CD-ROM that comes with the projector.
- For details about connecting USB devices to the XJ-S35 projector and procedures you need to perform to project images from a USB device, see "USB Function Guide" on the bundled CD-ROM.

Selecting the Input Source

When you turn on the projector, it first checks the RGB terminal for an input signal and then the VIDEO terminal. When it detects an input signal, it automatically selects it and starts projecting the signal.

Whenever you want to manually trigger an input source search operation, press the [INPUT] key.

NOTE

- When the projector detects an input source (RGB, component, or VIDEO) after an auto or manual select operation, the name of the newly selected source will appear in the projected image for a few seconds.
- The message "No signal input." will appear if no input signal can be selected.

Adjusting the Projected Image

To adjust the size of the projected image

Hold down the [ZOOM +] key to increase the size of the image or the [ZOOM -] key to decrease it. When the image is the size you want, release the key.

Projector key operation

Press the [ZOOM] key and then hold down the [◀] key to increase the size of the image, press the [ZOOM] key and then hold down the [▶] key to decrease it. When the image is the size you want, release the key.

To adjust image focus

Hold down the [FOCUS ▲] or [FOCUS ▼] key. When the focus is the way you want, release the key.

Projector key operation

Press the [FOCUS] key and then hold down the [◀] or [▶] key to focus. When focus is the way you want, release the key.

Auto Adjustment of an RGB Image

When the input source is RGB (computer), the projector automatically adjusts vertical and horizontal positioning, frequency, and phase whenever it detects an RGB signal (following input source selection, power up, etc.). You can also execute an automatic adjustment operation by pressing the [AUTO] key.

NOTE

- You can turn off auto adjustment when you want to disable auto adjustment and maintain manual settings.
- The projected image may become distorted while an auto adjustment operation is in progress.
- If an image is unclear following the auto adjustment operation, you can use the menu to adjust items manually.

Keystone Correction (KEYSTONE)

When the projector is at an angle to the screen it is projecting on, the projected image may have different length top and bottom edges. This phenomenon is called, "keystoning". This projector comes with functions for automatic as well as manual keystone correction, which provides a regularly shaped projected image.

Important!

- Keystone correction can cause the corrected image to be smaller than the original (uncorrected) image, or it can cause distortion of the image. If the projected image becomes difficult to view, try moving the screen and/or projector so they are oriented close to the configuration shown under "Setting Up the Projector" on page E-14.
- The projector does not support horizontal keystone correction. The center of the projector's lens should be aligned with the horizontal center of the screen (page E-14).

Automatic Keystone Correction

When "On" is selected for the "Option Settings 1 → Auto Keystone Correction" setting of the Setup Menu, the projector will detect the vertical orientation of the object in the image and adjust its shape automatically so it appears as a rectangle. The message "Auto Keystone Corrected." appears in the lower left corner of the projected image when the projector performs auto keystone correction.

- The correction range is 0° to +30°.

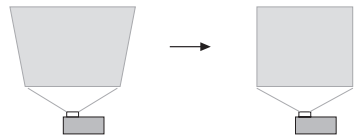

NOTE

- Auto keystone correction is performed by detecting the elevation angle of the projector. This means that the surface you are projecting onto needs to be standing straight up. If the surface you are projecting onto is not straight, use manual keystone correction to correct the image.

To use manual keystone correction

1. Press the [KEYSTONE +] or [KEYSTONE -] key.
 - This causes the keystone correction screen to appear on the projected image.
2. Use the [KEYSTONE +] and [KEYSTONE -] keys to correct for keystoning.
 - Correction can be performed for keystoning within $\pm 30^\circ$.
3. To close the setup screen, press the [ESC] key.

Using the Setup Menu

Pressing the [MENU] key while an image is being projected displays the setup menu on the projected image. The setup menu can be used to configure a variety of different projector settings. Use the cursor keys to select and configure settings, and the [ENTER] key to register them.

The menu items that can be set (or displayed) depend on the current input source. In the following table, the "Input Source" columns indicate whether each item appears (○) or not (×) for each input source (R = RGB, C = Component, V = Video, – = No input signal). A triangle (△) indicates that the item can be set (or displayed), subject to certain conditions.

Main menu Sub-menu	Input Source			
	R	C	V	–
Image Adjustment				
Brightness	○	○	○	×
Contrast	○	○	○	×
Sharpness	×	×	○	×
Saturation	×	×	○	×
Tint	×	×	△	×
Color Mode	○	○	○	×
Color Balance	○	○	○	×
Vertical Position	○	○	○	×
Horizontal Position	○	○	○	×
Frequency	○	×	×	×
Phase	○	×	×	×
Video Mode	×	×	○	×
Restore Menu Defaults	○	○	○	×
Screen Settings				
Keystone Correction	○	○	○	○
Aspect Ratio	×	△	○	×
Projection Mode	○	○	○	○
Startup Screen	○	○	○	○
No Signal Screen	○	○	○	○
Blank Screen	○	○	○	○
Restore Menu Defaults	○	○	○	○
Input Settings				
RGB Input	○	○	×	△
Video Signal	×	×	○	△
Signal Name Indicator	○	○	○	○
Restore Menu Defaults	○	○	○	○

Main menu Sub-menu	Input Source			
	R	C	V	–
Option Settings 1				
Menu Position	○	○	○	○
Auto Keystone Correction	○	○	○	○
Auto Adjust	○	×	×	△
Eco Mode	○	○	○	○
Auto Power Off	○	○	○	○
Power On Password	○	○	○	○
Direct Power On	○	○	○	○
Language	○	○	○	○
Restore Menu Defaults	○	○	○	○
Option Settings 2				
Zoom Memory	○	○	○	○
Pointer	○	○	○	○
Plug and Play (XJ-S35 only)	○	○	○	○
Restore Menu Defaults	○	○	○	○
USB (XJ-S35 only)				
Operational Info				
Lamp Time	○	○	○	○
Reset Lamp Time	○	○	○	○
Input Signal	○	○	○	○
Signal Name	○	○	○	×
Index	○	○	×	×
Resolution	○	×	×	×
Scan System	○	○	×	×
Restore All Defaults	○	○	○	○

- For detailed information about settings and how they are configured, see the User's Guide (UsersGuide_English.pdf) on the CD-ROM that comes with the projector.
- USB Settings (XJ-S35 only) are on a setup menu that appears when a USB device is connected to projector. For details, see "USB Function Guide" on the bundled CD-ROM.

Cleaning the Projector

Periodically clean the projector exterior, lens, intake vents, and exhaust vents on a regular basis.

Important!

- Always make sure that the projector has cooled sufficiently before cleaning it. If the projector is turned on, perform the following steps before cleaning it.

1. Turn off the projector.
2. Check to make sure that the POWER/STANDBY indicator has changed to amber.
3. Unplug the power cord from the power outlet, and allow the projector to cool down for about 60 minutes.

Cleaning the Projector Exterior

Wipe the exterior of the projector with a soft cloth that has been moistened in a weak solution of water and a mild neutral detergent. Be sure to wring all excess moisture from the cloth before wiping.

Never use benzene, alcohol, thinner, or any other volatile agent for cleaning.

Cleaning the Lens

Carefully wipe the lens with a commercially available lens cloth or optical lens paper, like those for eyeglasses or camera lenses. When cleaning the lens, be very careful to avoid scratching it.

Cleaning Intake and Exhaust Vents

Dust and dirt tend to collect around the intake vents located on the back and both sides of the projector. Because of this, you should use a vacuum cleaner to clean away accumulated dust and dirt periodically as shown below.

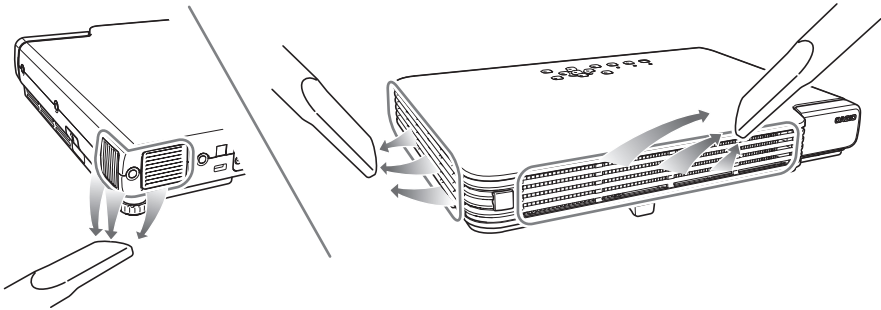

Important!

- Continued use of the projector after dust has accumulated around the intake vents can cause overheating of internal components and lead to malfunction.
- Certain operating conditions also can cause dirt and dust to accumulate around the projector's exhaust vents on the front. If this happens, use the same procedure as that described above to clean the exhaust vents.

Reattaching the Lens Cover

If the lens cover becomes detached, see “Reattaching the Lens Cover” in the User’s Guide (UsersGuide_English.pdf) on the CD-ROM that comes with the projector.

Replacing the Lamp



Caution

- Continued use of a lamp that has passed its lamp life increases the risk of the lamp rupturing. Replace the lamp with a new one as soon as possible after the replacement message appears.

- The light source lamp is a consumable item. The average life of a lamp is approximately 2000 hours. After 2000 hours, a message appears to alert you to the need of lamp replacement. However, note that the characteristics of a particular lamp or lamp operating conditions can cause the lamp to start to go dim or even fail before the message appears.

To check the current lamp use time

- Press the [MENU] key to display the setup menu.
- Press the [▼] key to select the “Operational Info” main menu.
 - The “Lamp Time” sub-menu item shows the number of hours that the current lamp has been used.
- Press the [MENU] key to exit the setup menu.

Image Adjustment	Lamp Time	10 hours
Screen Settings	Reset Lamp Time	OK(ENTER)
Input Settings	Input Signal	RGB
Output Settings 1	Output Name	1024x768@60
Output Settings 2	Input	RGB
USB	Resolution	1024 x 768
Operational Info	Horizontal Frequency	60.000Hz
Restore All Defaults	Vertical Frequency	60.000Hz
	Scale Source	Noninterlaced

[▲]/[▼]/[ENTER] Select [MENU] Quit

When to replace the lamp

The LAMP indicator starts to flash red and the message shown below appears whenever the lamp time exceeds 2000 hours.

It is time to replace the lamp. Use the procedure in the User’s Guide to replace the lamp as soon as possible.

When this message appears, replace the lamp as soon as possible using the procedure under “Replacing the Lamp” on page E-27.

Note that the above message will disappear about 10 seconds after you turn on the projector, even if you do not replace the lamp.

You will be able to continue using the projector without replacing the lamp until the lamp time reaches 100 hours. At that time, the LAMP indicator will stop flashing and remain lit red, the following message will appear for about 10 seconds, and then the projector will turn off automatically.

The lamp has exceeded its service life! The projector will not turn on until you replace the lamp.

When this message appears, replace the lamp immediately using the procedure under “Replacing the Lamp” on page E-27.

Replacing the Lamp

 Caution	<ul style="list-style-type: none"> ● During normal use, the lamp and the area around it become extremely hot. Before replacing the lamp, turn off the projector and wait for the cool down operation (indicated when the POWER/STANDBY indicator is flashing amber) to finish. Next, disconnect the AC power cord from the projector, and wait for at least 60 minutes to allow it to cool down even further. Touching the lamp or the area around it during operation or immediately after turning off the projector creates the risk of serious burn injury. ● Replace the lamp using the YL-33 optional lamp cartridge only. ● A mercury lamp with high internal pressure is used as the light source. A lamp that is weakened by impact, damage, or expiration of its lamp life may explode or fail to light if exposed to loud noise. Note that lamp life differs greatly from lamp to lamp, and is affected by conditions under which the lamp is used. ● Never touch the glass of the lamp with your fingers. Doing so can cause the lamp to rupture and shorten its life. ● A broken lamp can cause glass fragments to be scattered inside the lamp housing. Gas inside of the lamp housing may also be discharged from the projector's vent exhaust ports. Gas inside of the lamp includes mercury, so be sure to ventilate the area whenever the lamp breaks. Should you accidentally inhale gas fumes or should gas fumes get into your eyes, immediately contact a physician. ● Should the lamp break, take care to avoid personal injury on the glass fragments. Never try to replace a broken lamp on your own. Be sure to contact your original dealer or authorized CASIO service center to request replacement. ● The lamp contains mercury. Dispose of old lamps in accordance with the rules and regulations of your local jurisdiction.
--	--

Important!

- Disposing of the Lamp (U.S.A. Only)
This product utilizes a lamp containing mercury. Disposal of the lamp may be regulated due to environmental considerations. For disposal or recycling information, please contact your local authorities or the Electronic Industries Alliance: <http://www.eiae.org>.

To replace the lamp

Important!

- When replacing the lamp, use the special screwdriver that comes with the YL-33 replacement lamp. The projector does not come with a screwdriver.

1. Turn off the projector and unplug its AC power cord.
2. Wait for about 60 minutes to allow the projector's current lamp to cool down completely.
3. Turn over the projector and place it on top of a desk or on some other stable surface.

User Maintenance

4. Loosen the lamp cover screw, and then remove the lamp cover.

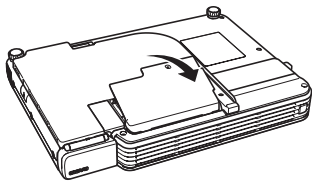
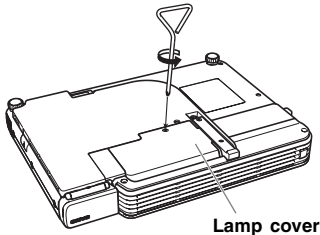

5. Loosen the three screws indicated by an ▲ mark.

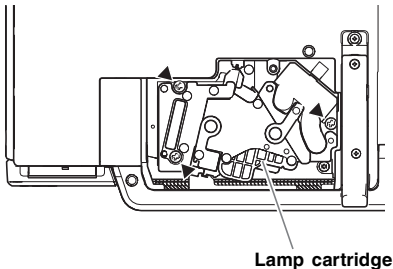

6. Use the lamp cartridge handle to pull the lamp cartridge from the projector.

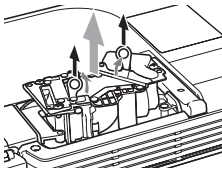

7. Insert the new lamp cartridge as far as it will go, as shown in the illustration.
- After inserting the lamp cartridge, lay its handle down in the position shown in the illustration under step 5 on this page.

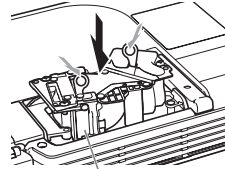

Make sure the grooves of the lamp cartridge align with the grooves of the lamp housing.

Caution

- Take care to avoid touching the lamp (glass) and the mirrors inside the projector. Doing so can cause the lamp to rupture, shorten lamp life, and otherwise affect lamp performance.
-

8. Secure the lamp cartridge with the three screws.

9. Return the lamp cover to its original position, and secure it with the screw.
- After replacing the lamp, be sure to perform the procedure under "Resetting the Lamp Time" on page E-29.

Resetting the Lamp Time

The lamp time reset operation you need to perform depends on when you replace the lamp.

It is time to replace the lamp. Use the procedure in the User's Guide to replace the lamp as soon as possible.

If you replace the lamp when the above message appears, use the procedure under "To reset the lamp time".

The lamp has exceeded its service life! The projector will not turn on until you replace the lamp.

If you replace the lamp after the above message appears, use the procedure under "To reset the lamp time after exceeding the lamp life".

To reset the lamp time

1. Turn on the projector.
2. Press the [MENU] key to display the setup menu.
3. Press the [▼] key to select "Operational Info", and then press the [ENTER] key.
4. Press the [ENTER] key.
 - This causes the message "Reset Lamp Time?" to appear.
5. Press the [▲] key to select "Yes", and then press the [ENTER] key.
 - This resets the lamp time to 0 hours.
6. Press the [MENU] key to exit the setup menu.
 - This causes the setup menu to disappear from the projected image.

To reset the lamp time after exceeding the lamp life

If you use the existing lamp until its life is exceeded, you will not be able to turn on the projector even after you replace the lamp with a new one. Perform the following procedure to initialize the lamp time in this case, which will make it possible to turn on the projector.

1. Use the bundled AC power cord to plug the projector into a power outlet.
 - Connecting to a power outlet causes the POWER/STANDBY and LAMP indicators on the top of the projector to light red, which indicates that the lamp has exceeded its service life.
2. While holding down the projector's [◀] key, hold down the [AUTO] key for about five seconds.
 - This will reset the lamp time, cause the POWER/STANDBY indicator to change from red to amber, and also cause the LAMP indicator to go out.
3. Press the [⏻] (power) key to ensure that the projector turns on normally.

Troubleshooting

Indicators

The status of the indicators lets you know the current operational status of the projector. This section provides details about indicators.

- “POWER” in the following table stands for the “POWER/STANDBY” indicator.

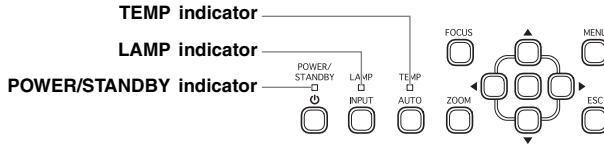

Normal Operation Indicators

When this indicator:	Is this:	It means this:
POWER :	Amber steady	You have just plugged the AC power cord into a power outlet. Wait until the projector enters the standby state (see below) before trying to turn on power.
TEMP :	Amber steady	
LAMP :	Amber steady	
POWER :	Amber steady	Standby state: The AC power cord is plugged in and the projector is in standby.
POWER :	Green flashing	Projector is warming up after being turned on.
POWER :	Green steady	Projector is on and standing by for use.
POWER :	Amber flashing	Projector is cooling down after being turned off. If the projector is hot when you plug the AC power cord into a power outlet, it also goes into a cool down state.
LAMP :	Green steady	The projector's Eco Mode is turned on.

Error Indicators and Warning Messages

When an error occurs, wait until cool down is complete and the fan stops before unplugging the AC power cord. If you unplug the AC power cord while the fan is still operating, an error may occur when you plug the AC power cord back in.

Indicator/Error Message	Description and Required Action
POWER : Green steady TEMP : – LAMP : – Message : Internal temperature is too high. Check projector air vents for blockage.	The projector's internal temperature is very high. Press the [ESC] key to clear the warning message and perform the following steps. ① Check for any blocking of the projector's intake vents and exhaust vents, and make sure that there is sufficient space around the projector. See “Setup Precautions” (page E-15). ② If there is dust accumulated around the intake vents and/or exhaust vents, turn off the projector and remove it. See “Cleaning the Projector” (page E-25).

Indicator/Error Message	Description and Required Action
<p>POWER : Amber flashing → Amber steady TEMP : Red flashing (1-second interval) → Turns off LAMP : – Message : Internal temperature is too high. The projector will turn off.</p>	<p>Power has turned off automatically due to internal overheating. Perform the following steps.</p> <ol style="list-style-type: none"> ① Check for any blocking of the projector's intake vents and exhaust vents, and make sure that there is sufficient space around the projector. See "Setup Precautions" (page E-15). ② If there is dust accumulated around the intake vents and/or exhaust vents, remove it. See "Cleaning the Projector" (page E-25). <p>If there is no problem with the projector's vents, confirm that the POWER/STANDBY indicator is lit amber (without flashing), and then turn power back on again. If the error occurs again when you turn power back on, contact your retailer or nearest authorized CASIO Service Center.</p>
<p>POWER : Amber flashing → Red steady TEMP : Red flashing (0.5- second interval) LAMP : – Message : –</p>	<p>Power has turned off automatically due to internal overheating. This causes a dialog box containing the text in the next item below to appear the next time you turn on the projector. Follow the steps that are provided.</p>
<p>POWER : Green steady TEMP : – LAMP : – Message : The projector has a history of turning off due to high temperature. Check air vents for blockage.</p>	<p>The last time you were using the projector, power turned off automatically due to internal overheating. Press the [ESC] key to clear the warning message and perform the following steps.</p> <ol style="list-style-type: none"> ① Check for any blocking of the projector's intake vents and exhaust vents, and make sure that there is sufficient space around the projector. See "Setup Precautions" (page E-15). ② If there is dust accumulated around the intake vents and/or exhaust vents, turn off the projector and remove it. See "Cleaning the Projector" (page E-25). ③ Disconnect the power cord from the projector and wait for all of the projector's indicators to go out. Next, reconnect the power cord and turn the projector back on. If the error occurs again when you turn power back on, contact your retailer or nearest authorized CASIO Service Center.
<p>POWER : Amber flashing → Red steady TEMP : Red steady LAMP : Red steady Message : There is a problem with the fan. The projector will turn off.</p>	<p>Power has turned off automatically due to a fan problem. Confirm that the POWER/STANDBY indicator is lit red (without flashing) and that the fan has stopped. After checking the POWER/STANDBY indicator, disconnect the power cord from the projector and wait for all of the projector's indicators to go out. Next, reconnect the power cord and turn projector power back on.</p> <p>If the error occurs again when you turn power back on, contact your retailer or nearest authorized CASIO Service Center.</p>

Troubleshooting

Indicator/Error Message	Description and Required Action
<p>POWER : Amber flashing → Red steady TEMP : Red steady LAMP : – Message : A system problem has occurred. The projector will turn off.</p>	<p>Power has turned off automatically due to a system problem. After confirming that the POWER/STANDBY indicator is lit red (without flashing), disconnect the power cord from the projector and wait for all of the projector's indicators to go out. Next, reconnect the power cord and turn the projector back on. If the error occurs again when you turn power back on, contact your retailer or nearest authorized CASIO Service Center.</p>
<p>POWER : Green steady TEMP : – LAMP : – Message : A system problem has occurred. Some functions may not operate correctly.</p>	<p>A system problem has occurred, which may cause problems with some functions. Turn off the projector, disconnect the power cord from the projector and wait for all of the projector's indicators to go out. Next, reconnect the power cord and turn the projector back on. If the error occurs again when you turn power back on, contact your retailer or nearest authorized CASIO Service Center. Press the [ESC] key to clear the warning message.</p>
<p>POWER : Green steady TEMP : – LAMP : – Message : This device is defective. Remove the device immediately, and then press the [ENTER] key.</p>	<p>The USB connection was terminated because the device connected to the USB terminal caused excessive current to flow to the projector. Immediately disconnect the USB device and press the [ENTER] key.</p>
<p>POWER : Green steady TEMP : – LAMP : – Message : There is a problem with the USB port.</p>	<p>The USB connection was terminated because of a problem with the USB port. To use the USB function, turn off the projector and then turn it back on again. If the error occurs again when you turn power back on, contact your retailer or nearest authorized CASIO Service Center. Press the [ESC] key to clear the warning message.</p>
<p>POWER : Green steady TEMP : – LAMP : – Message : Zoom and focus cannot be performed for some reason. Try turning the projector off and then back on again. If this message reappears, request servicing.</p>	<p>Zoom and focus cannot be performed due to some trouble in the optical drive circuit. Turn off the projector and then turn it back on again. If the error occurs again when you turn power back on, contact your retailer or nearest authorized CASIO Service Center. Press the [ESC] key to clear the warning message.</p>

Indicator/Error Message	Description and Required Action
POWER : Amber flashing → Red steady TEMP : Red steady LAMP : – Message : –	The projector was turned off automatically due to some problem that was probably caused by external digital noise or some other reason. Confirm that the POWER/STANDBY indicator is lit red (without flashing) and that the fan has stopped. After checking the POWER/STANDBY indicator, disconnect the power cord from the projector and wait for all of the projector's indicators to go out. Next, reconnect the power cord and turn projector power back on. If the error occurs again when you turn power back on, contact your retailer or nearest authorized CASIO Service Center.
POWER : Amber flashing → Red steady TEMP : Red flashing (0.5-second interval) LAMP : Red flashing (0.5-second interval) Message : –	The projector was turned off automatically because the lamp turned off or did not turn on. After confirming that the POWER/STANDBY indicator is lit red (without flashing), unplug the power cord. Wait for a short while and then plug it back in and turn on the projector again. If the error occurs again when you turn power back on, wait until the projector cools down and then replace the lamp (page E-26). If the lamp does not light after you replace it, contact your retailer or nearest authorized CASIO Service Center.
POWER : Amber flashing → Red steady TEMP : Red flashing (2-second interval) LAMP : – Message : –	Power has turned off automatically due to a projector memory error. Confirm that the POWER/STANDBY indicator is lit red (without flashing) and that the fan has stopped. After checking the POWER/STANDBY indicator, disconnect the power cord from the projector and wait for all of the projector's indicators to go out. Next, reconnect the power cord and turn projector power back on. If the error occurs again when you turn power back on, contact your retailer or nearest authorized CASIO Service Center.
POWER : Amber flashing → Red steady TEMP : Amber flashing (1-second interval) LAMP : – Message : –	Power has turned off automatically because the lamp cover is open. Perform the following steps. ① After confirming that the POWER/STANDBY indicator is lit red (without flashing), disconnect the power cord from the projector. ② Check to make sure that the lamp cover is closed. ③ Plug the power cord back in and turn the projector back on again. If the error occurs again when you turn power back on, contact your retailer or nearest authorized CASIO Service Center.
POWER : Green steady TEMP : – LAMP : Red flashing (1-second interval) Message : It is time to replace the lamp. Use the procedure in the User's Guide to replace the lamp as soon as possible.	It is time to replace the lamp. Replace the lamp following the steps under "Replacing the Lamp" (page E-26). Press the [ESC] key to clear the warning message.

Troubleshooting

Indicator/Error Message	Description and Required Action
POWER : Amber flashing → Red steady TEMP : – LAMP : Red steady Message : The lamp has exceeded its service life! The projector will not turn on until you replace the lamp.	The allowable life for the lamp has been exceeded, and the projector will not turn on. Replace the lamp following the steps under “Replacing the Lamp” (page E-26).

Projector Troubleshooting

Check the following items whenever you experience any problem with the projector.

Problem	Cause and Recommended Action	See
The projector does not turn on when I press the [⏻] (power) key.	If the POWER/STANDBY indicator is not lit, the AC power cord may not be connected correctly. → Make sure the AC power cord is connected correctly to the projector and the power outlet (see “Turning On the Projector”).	page E-19
	If the TEMP or LAMP indicator remains flashing or lit, it means some type of error has occurred. → See “Error Indicators and Warning Messages” under “Indicators”.	page E-30
The projector does not project any image from the connected device.	The connected computer or video device may not be turned on, or it may not be outputting a video signal. → Make sure the connected computer or video device is turned on, and perform the required operation on it to output a video signal.	—
	The correct input source is not selected on the projector. → On the projector, select the input source that corresponds to the device whose image you are trying to project (see “Selecting the Input Source”).	page E-22
The projector does not correctly project the image from the connected device.	Images may not project correctly when you have the component output terminal of a video device connected to the RGB terminal of the projector. → Try using the projector’s VIDEO input terminal (see “Connecting to a Standard Video Device”).	page E-17
When RGB/Component is selected as the input source, the color of the projected image or the image itself is abnormal.	The wrong option (“Component” or “RGB”) may be selected for the “Input Settings → RGB Input” setting on the setup menu. The image will not be projected correctly if “Component” is selected while the projector’s RGB input terminal is connected to the RGB output terminal of a computer, or if “RGB” is selected while the projector’s RGB input terminal is connected to the component video output terminal of a video device. → Use the setup menu to change the “Input Settings → RGB Input” setting to “Auto” to correct the problem.	User’s Guide (UsersGuide_English.pdf)
The message “Input the password.” appears and further operation is not possible.	The “Option Settings 1 → Power On Password” setting on the setup menu is turned on, so the projector is password protected. → Input the correct password, and then press the [ENTER] key.	User’s Guide (UsersGuide_English.pdf)
The remote controller does not work.	The remote controller battery may be dead. → Replace the battery (see “Replacing the Remote Controller Battery”).	page E-13
	The remote controller may be too far from the projector. → Make sure the remote controller is within the allowable range when you operate it.	User’s Guide (UsersGuide_English.pdf)

Troubleshooting

Problem	Cause and Recommended Action	See
The TEMP or LAMP indicator is flashing or lit.	→ See “Error Indicators and Warning Messages” under “Indicators”.	page E-30
The message “It is time to replace the lamp.” is being projected.	It is time to replace the lamp. → Replace the lamp (see “Replacing the Lamp”).	page E-26
The message “The lamp has exceeded its service life!” is being projected.	The allowable life for the lamp has been exceeded, and the projector will not turn on. → Replace the lamp (see “Replacing the Lamp”).	page E-26

Important!

Try performing the following steps, which can return the projector to normal operation.

1. Press the [⏻] (power) key to turn off the projector.
2. After the projector's cool down is finished and the fan is completely stopped, unplug the AC power cord.
3. Plug the power cord back in and turn the projector back on again.
 - * If the power off confirmation message does not appear when you press the [⏻] (power) key, unplug the AC power cord and wait for at least 10 minutes. Then plug the power cord back in and turn the projector back on again.

If normal operation does not resume after you perform the above steps, take the projector to your retailer or authorized CASIO Service Center.

Specifications

Model Name		XJ-S30/XJ-S35
Projection System		DLP
DLP chip	Size	0.55inch
	Number of Pixels	XGA (1024 × 768)
Projection Lens		Optical X2 zoom, electric focus F = 2.0 to 2.8 f = 20 to 40mm
Light Source		200W high-pressure mercury lamp
RGB input terminal		RGB mini D-Sub 15-pin × 1 (Also used as component signal input terminal.)
VIDEO input terminal		RCA pin jack × 1
USB port (XJ-S35 only)		USB TYPE A
Environment		Operating Temperature: 5 to 35°C (41 to 95°F) Operating Humidity: 20 to 80% (non-condensation)
Power Requirements		XJ-S30: 100-240V AC, 50/60Hz, 3.1A-1.3A XJ-S35: 100-240V AC, 50/60Hz, 3.1A-1.3A
Approximate Dimensions		270 (W) × 199 (D) × 42 (H) mm (Excluding projections. 32 mm at thinnest part) (10.6" × 7.8" × 1.7" (Excluding projections. 1.3" at thinnest part))
Weight		Approximately 1.8kg (4.0 lbs)
Display Languages		English, French, German, Italian, Spanish, Swedish, Chinese (Simplified), Chinese (Traditional), Korean, Japanese

CASIO COMPUTER CO., LTD. makes no guarantees concerning the operation or suitability of any USB device that you connect to the projector's USB port.

* Specifications are subject to change without notice.

Free Manuals Download Website

<http://myh66.com>

<http://usermanuals.us>

<http://www.somanuals.com>

<http://www.4manuals.cc>

<http://www.manual-lib.com>

<http://www.404manual.com>

<http://www.luxmanual.com>

<http://aubethermostatmanual.com>

Golf course search by state

<http://golfingnear.com>

Email search by domain

<http://emailbydomain.com>

Auto manuals search

<http://auto.somanuals.com>

TV manuals search

<http://tv.somanuals.com>